

Operation Manual



**CUBASE ARTIST 10.5**  
Music Production System

Cristina Bachmann, Heiko Bischoff, Lillie Harris, Christina Kaboth, Insa Mingers, Matthias Obrecht, Sabine Pfeifer, Benjamin Schütte, Marita Sladek

This PDF provides improved access for vision-impaired users. Please note that due to the complexity and number of images in this document, it is not possible to include text descriptions of images.

The information in this document is subject to change without notice and does not represent a commitment on the part of Steinberg Media Technologies GmbH. The software described by this document is subject to a License Agreement and may not be copied to other media except as specifically allowed in the License Agreement. No part of this publication may be copied, reproduced, or otherwise transmitted or recorded, for any purpose, without prior written permission by Steinberg Media Technologies GmbH. Registered licensees of the product described herein may print one copy of this document for their personal use.

All product and company names are ™ or ® trademarks of their respective owners. For more information, please visit [www.steinberg.net/trademarks](http://www.steinberg.net/trademarks).

© Steinberg Media Technologies GmbH, 2020.

All rights reserved.

Cubase Artist\_10.5.20\_en-US\_2020-05-26

# Table of Contents

<b>7</b>	<b>New Features</b>	<b>110</b>	Sampler Tracks
<b>9</b>	<b>Introduction</b>	<b>113</b>	MIDI Tracks
9	Platform-Independent Documentation	<b>117</b>	Group Channel Tracks
9	PDF Documents and Online Documentation	<b>120</b>	FX Channel Tracks
10	Conventions	<b>123</b>	Ruler Track
11	Key Commands	<b>125</b>	Folder Tracks
<b>12</b>	<b>Setting up Your System</b>	<b>128</b>	More Tracks
12	Studio Setup Dialog	<b>140</b>	<b>Track Handling</b>
13	Setting up Audio	<b>140</b>	Adding Tracks via the Add Track Dialog
20	Setting up MIDI	<b>140</b>	Adding Tracks Using Track Presets
22	Synchronizers	<b>141</b>	Adding Tracks by Dragging Files from the MediaBay
<b>24</b>	<b>Audio Connections</b>	<b>141</b>	Exporting MIDI Tracks as Standard MIDI Files
24	Audio Connections Window	<b>143</b>	Removing Selected Tracks
25	Renaming the Hardware Inputs and Outputs	<b>143</b>	Removing Empty Tracks
26	Adding Input and Output Busses	<b>143</b>	Moving Tracks in the Track List
27	Presets for Input and Output Busses	<b>144</b>	Renaming Tracks
28	Monitoring Bus	<b>144</b>	Automatically Assigning Colors to New Tracks/Channels
28	Bus Configurations	<b>144</b>	Showing Track Pictures
<b>30</b>	<b>Project Window</b>	<b>146</b>	Setting the Track Height
31	Showing/Hiding Zones	<b>147</b>	Selecting Tracks
31	Project Zone	<b>148</b>	Deselecting Tracks
45	Left Zone	<b>148</b>	Duplicating Tracks
52	Lower Zone	<b>148</b>	Disabling Tracks
58	Right Zone	<b>148</b>	Organizing Tracks in Folder Tracks
63	Keyboard Focus in the Project Window	<b>148</b>	Handling Overlapping Audio
64	Zooming in the Project Window	<b>149</b>	Track Folding Menu
67	Snap Function	<b>149</b>	Events Display on Folder Tracks
70	Cross-Hair Cursor	<b>150</b>	Modifying Event Display on Folder Tracks
71	Edit History Dialog	<b>150</b>	Lanes, Takes and Overlapping Events
72	Color Handling	<b>151</b>	Defining the Track Time Base
<b>80</b>	<b>Project Handling</b>	<b>154</b>	Track Versions
80	Creating New Projects	<b>155</b>	Track Presets
80	Hub	<b>162</b>	
82	Project Assistant Dialog	<b>168</b>	<b>Parts and Events</b>
83	Project Files	<b>168</b>	Events
83	Template Files	<b>172</b>	Parts
86	Project Setup Dialog	<b>173</b>	Editing Techniques for Parts and Events
89	Opening Project Files	<b>189</b>	<b>Range Editing</b>
90	Saving Project Files	<b>189</b>	Creating a Selection Range
91	Reverting to the Last Saved Version	<b>191</b>	Editing Selection Ranges
91	Choosing a Project Location	<b>194</b>	<b>Playback and Transport</b>
92	Self-Contained Projects	<b>194</b>	Transport Panel
<b>94</b>	<b>Tracks</b>	<b>199</b>	Transport Menu
94	Track Inspector Settings Dialog	<b>204</b>	Transport Bar
97	Track Controls Settings Dialog	<b>209</b>	Transport Pop-Up Window
102	Add Track Dialog	<b>210</b>	Time Display Window
103	Audio Tracks	<b>211</b>	Left and Right Locators
106	Instrument Tracks	<b>214</b>	Setting the Project Cursor

214	Auto-Scroll Settings Menu	363	Insert Effects
215	Time Formats	368	VST Effect Selector
216	Pre-Roll and Post-Roll	369	Send Effects
217	Punch In and Punch Out	373	Side-Chain Input
217	Metronome Click	376	Dither Effects
226	Chase	376	Effect Control Panel
<b>228</b>	<b>On-Screen Keyboard</b>	379	Effect Presets
228	Recording MIDI With the On-Screen Keyboard	383	System Component Information Window
229	On-Screen Keyboard Options	<b>386</b>	<b>Direct Offline Processing</b>
<b>230</b>	<b>Recording</b>	387	Direct Offline Processing Workflow
230	Basic Recording Methods	387	Direct Offline Processing Window
235	Monitoring	393	Built-In Audio Processes
237	Audio Recording Specifics	401	Key Commands for Direct Offline Processing
242	MIDI Recording Specifics	<b>403</b>	<b>Time Stretch and Pitch Shift Algorithms</b>
250	Remaining Record Time	403	élastique
250	Lock Record	403	MPEX
<b>251</b>	<b>Importing Audio and MIDI Files</b>	404	Standard
251	Audio File Import	405	Limitations
258	MIDI File Import	<b>406</b>	<b>Audio Functions</b>
<b>261</b>	<b>Quantizing MIDI and Audio</b>	406	Detect Silence Dialog
261	Quantize Functions	409	Spectrum Analyzer Window
262	Quantizing MIDI Event Starts	411	Statistics Window
263	Quantizing MIDI Event Lengths	<b>413</b>	<b>Sample Editor</b>
263	Quantizing MIDI Event Ends	415	Sample Editor Toolbar
263	Quantizing Audio Event Starts	419	Info Line
264	Quantizing Audio Event Lengths (AudioWarp Quantizing)	419	Overview Line
264	Quantize Panel	420	Sample Editor Inspector
<b>271</b>	<b>Fades, Crossfades, and Envelopes</b>	422	Ruler
271	Event-Based Fades	423	Waveform Display
275	Creating Clip-Based Fades	425	Range Editing
276	Crossfades	429	Regions List
279	Auto Fades and Crossfades	431	Snap Point
281	Event Envelopes	<b>434</b>	<b>Hitpoints</b>
<b>283</b>	<b>Arranger Track</b>	434	Calculating Hitpoints
283	Adding Arranger Events on the Arranger Track	437	Locating to Hitpoints in the Project Window
284	Arranger Editor	438	Slices
287	Setting up an Arranger Chain and Adding Events	440	Creating a Groove Quantize Map
289	Jump Mode	440	Creating Markers
291	Arranging Music to Video	440	Creating Regions
<b>292</b>	<b>Transpose Functions</b>	441	Creating Events
292	Project Root Key	441	Creating Warp Markers
295	Transpose Track	441	Creating MIDI Notes
297	Keep Transpose in Octave Range	<b>443</b>	<b>Tempo Matching Audio</b>
298	Transpose on the Info Line	443	Algorithm Presets
299	Excluding Individual Parts or Events from Global Transpose	444	Stretching Audio Events to the Project Tempo
<b>300</b>	<b>Markers</b>	444	Musical Mode
300	Position Markers	446	Auto Adjust
300	Cycle Markers	446	Manual Adjust
301	Markers Window	448	Free Warp
304	Marker Track	450	Flattening Realtime Processing
306	Importing and Exporting Markers	450	Flatten Realtime Processing Dialog
<b>307</b>	<b>MixConsole</b>	451	Unstretching Audio Files
307	MixConsole in Lower Zone	<b>452</b>	<b>Audio Part Editor</b>
310	MixConsole Window	453	Audio Part Editor Toolbar
<b>361</b>	<b>Audio Effects</b>	458	Info Line
361	Insert Effects and Send Effects	458	Ruler
		458	Lanes
		459	Operations
		<b>462</b>	<b>Sampler Tracks</b>
		462	Loading Audio Samples into Sampler Control

463	Loading MIDI Parts into Sampler Control	591	<b>MIDI Realtime Parameters and MIDI Effects</b>
463	Creating Sampler Tracks	591	MIDI Track Parameters
464	Sampler Control	593	MIDI Modifiers
473	Sample Editing and Playback Functions	598	MIDI Effects
475	Transferring Samples from Sampler Control to VST Instruments	601	Transpose and Velocity on the Info Line
<b>476</b>	<b>Pool</b>	<b>602</b>	<b>Using MIDI Devices</b>
476	Pool Window	602	Program Change Messages and Bank Select Messages
481	Working with the Pool	603	Patch Banks
<b>494</b>	<b>MediaBay and Media Rack</b>	603	MIDI Device Manager
494	Media Rack in Right Zone	<b>608</b>	<b>MIDI Functions</b>
504	MediaBay Window	608	Transpose Setup Dialog
531	Working with Volume Databases	609	Merging MIDI Events into a New Part
534	MediaBay Settings	611	Dissolve Part Dialog
<b>535</b>	<b>Automation</b>	612	Repeating MIDI Events of Independent Track Loops
535	Recording your Actions	612	Extending MIDI Notes
535	Automation Curves	613	Fixing MIDI Note Lengths
536	Static Value Line	613	Fixing MIDI Note Velocities
536	Write/Read Automation	614	Rendering Sustain Pedal Data to Note Lengths
536	MIDI Part Data vs. Track Automation	614	Deleting Overlaps
537	Writing Automation Data	614	Editing Velocity
539	Editing Automation Events	615	Deleting Double Notes
543	Automation Tracks	615	Deleting Controller Data
544	MIDI Controller Automation	616	Deleting Continuous Controller Data
<b>547</b>	<b>VST Instruments</b>	616	Restricting Polyphonic Voices
547	Adding VST Instruments	616	Thinning Out Controller Data
548	VST Instrument Control Panel	616	Extracting MIDI Automation
550	VST Instrument Selector	617	Reversing the Playback Order of MIDI Events
550	Creating Instrument Tracks	617	Inverting the Order of Selected MIDI Events
550	VST Instruments in the Right Zone	<b>618</b>	<b>MIDI Editors</b>
551	VST Instruments Window	618	Common MIDI Editor Functions
551	VST Instruments Window Toolbar	625	Controller Display
552	VST Instrument Controls	638	Key Editor
553	Presets for Instruments	648	Key Editor Operations
556	Playing Back VST Instruments	656	Score Editor
557	Latency	663	Score Editor Operations
558	Import and Export Options	670	Drum Editor
560	VST Quick Controls	682	Drum Editor Operations
561	Side-Chain Input for VST Instruments	684	Drum Maps
<b>563</b>	<b>Installing and Managing VST Plug-ins</b>	689	List Editor
563	Plug-ins and Collections	698	List Editor Operations
566	Adding New Plug-in Collections	703	In-Place Editor
567	Hiding Plug-ins	<b>706</b>	<b>Note Expression</b>
567	Reactivating Plug-ins from the Blocklist	707	VST Note Expressions
<b>569</b>	<b>Track Quick Controls</b>	707	MIDI Controllers
570	Parameter Assignment	712	Note Expression Inspector Section
573	Controlling Automatable Parameters	715	Note Expression Tools
574	Connecting Track Quick Controls with Remote Controllers	716	Controller Mapping
<b>576</b>	<b>Remote Controlling Cubase</b>	717	Recording
576	Connecting Remote Devices	720	Note Expression Event Editor
576	Removing the Remote Input from All MIDI Inputs	726	Trimming Note Expression Data
577	Setting up Remote Devices	726	Removing All Note Expression Data
579	Remote Devices and Automation	726	Note Expression MIDI Setup Dialog
579	Assigning Commands to Remote Devices	<b>731</b>	<b>Chord Functions</b>
580	Generic Remote Page	731	Chord Track
585	Remote Control Editor	732	Chord Events
590	Joysticks	736	Scale Events
590	Track Quick Controls	737	Voicings
590	VST Quick Controls	740	Converting Chord Events to MIDI

740	Controlling MIDI Playback Using the Chord Track	844	<b>Exchanging Files with Other Applications</b>
744	Assigning Voices to Notes	844	AAF Files
745	Extracting Chord Events from MIDI	849	<b>ReWire</b>
746	Recording Chord Events with a MIDI Keyboard	849	Introduction
<b>747</b>	<b>Chord Pads</b>	849	Enabling ReWire Applications
747	Chord Pads Zone	850	Launching and quitting
750	Functions Menu	851	Activating ReWire channels
751	Chord Assistant	851	Using the transport and tempo controls
752	Chord Assignment	852	How the ReWire channels are handled
755	Swapping Chord Assignments	852	Routing MIDI via ReWire
755	Copying Chord Assignments	853	Considerations and limitations
755	Playing Back and Recording Chords	<b>854</b>	<b>Key Commands</b>
758	Player Setup	854	Key Commands Dialog
765	Chord Pads Setup Dialog	857	Assigning Key Commands
771	Chord Pads Presets	857	Searching for Key Commands
772	Creating Chord Events from Chord Pads	858	Removing Key Commands
772	Creating MIDI Parts from Chord Pads	858	Setting up Macros
<b>773</b>	<b>Transformer</b>	859	Saving Key Commands Presets
773	Window Overview	859	Loading Key Command Presets
774	Filter Conditions	859	Importing Key Command Settings
779	Selecting a Function	859	Resetting Key Commands
779	Specifying Actions	860	Default Key Commands
781	Presets	872	Setting up Tool Modifier Keys
<b>782</b>	<b>Editing Tempo and Time Signature</b>	<b>873</b>	<b>Customizing</b>
782	Project Tempo Modes	873	Workspaces
782	Track Time Base	876	Setup Options
783	Tempo Track Editor	878	Windows Dialog
785	Tempo Track	879	Where are the Settings Stored?
787	Tempo Changes for Projects	879	Safe Mode Dialog
788	Setting up a Fixed Project Tempo	<b>882</b>	<b>Optimizing</b>
790	Beat Calculator	882	Optimizing Audio Performance
791	Set Definition from Tempo Dialog	<b>886</b>	<b>Preferences</b>
792	Time Signature Events	886	Preferences Dialog
<b>794</b>	<b>Rendering Audio and MIDI</b>	888	Editing
794	Render Tracks Dialog	893	Editors
797	Render Selection Dialog	893	Event Display
<b>800</b>	<b>Export Audio Mixdown</b>	896	General
800	Export Audio Mixdown Dialog	897	MIDI
805	Mixing Down to Audio Files	901	MediaBay
806	File Formats	901	Metering
<b>814</b>	<b>Synchronization</b>	902	Record
814	Master and Slave	904	Transport
815	Timecode Formats	905	User Interface
816	Clock Sources	907	VST
817	Project Synchronization Setup Dialog	908	Video
822	External Synchronization	<b>909</b>	<b>Index</b>
<b>823</b>	<b>VST System Link</b>		
823	Setting up VST System Link		
827	Activating VST System Link		
830	Application Examples		
<b>833</b>	<b>Video</b>		
833	Video File Compatibility		
834	Frame Rates		
834	Video Output Devices		
835	Preparations for Creating Video Projects		
837	Preparations for Video Playback		
839	Editing Video		
840	Export Video		
843	Extracting Audio from Video		

# New Features

Cubase comes with many new features. The following list informs you about the most important improvements and provides links to the corresponding descriptions.

## New Features in Version 10.5.20

### Improved Range and Event Editing

- Cubase now includes the following range and event editing functions: **Range to Next Event/Range to Previous Event**, **Enlarge Range to Next Event/Enlarge Range to Previous Event**, **Cut Head/Cut Tail**, and **Set Spacer between Selected Events**. See [Select Menu for Selection Ranges](#), [Using Cut Head and Cut Tail](#), and [Setting Spacers between Events](#).

### Remove Multiple Busses

- You can now remove multiple input or output busses at the same time in the **Audio Connections** window. See [Removing Busses](#).

### Enhanced Direct Offline Processing

- The **Direct Offline Processing** window now allows you to reset audio processes to their default settings. See [Direct Offline Processing Workflow](#).

### Plug-in Report

- The **VST Plug-in Manager** now allows you to create an extensive plug-in report with detailed information about the installed plug-ins on your system. See [VST Plug-in Manager Window](#).

### Adjustable Event Opacity

- The new preference **Event Opacity** allows you to customize the visibility of the event background. See [Event Display](#).

### Colorize Selected Channels

- The new preference **Show Color for Selected Channel** allows you to highlight the selected channel by colorizing it. See [User Interface - Track & MixConsole Channel Colors](#).

## New Features in Version 10.5.0

### Highlights

#### Combine Selection Tools

- The new **Combine Selection Tools** mode speeds up your editing workflow by combining the two most frequently used tools in one powerful feature. Activate the new tool mode to use the selection tools for both objects and ranges at the same time without the need to change tools. If time is critical, the **Combine Selection Tools** mode will be your new best friend. See [Combine Selection Tools Mode](#).

### **MIDI Retrospective Recording**

- Do you always deliver your best performances when not recording? The completely revised MIDI Retrospective Recording feature can help you to bring your A game to every project. Cubase tracks your MIDI input even when you are not recording and brings back your chords and melodies as a stacked cycle or a continuous performance with just one click. Even better, your performance is captured on multiple tracks. So no more worries — Cubase has your back. See [Recovery of MIDI Recordings](#).

### **Colorized MixConsole Channels**

- Maintaining a clear overview while your project is growing is essential for a fast and efficient workflow. With the new option to colorize complete channels in the **MixConsole** using track colors, you can focus on your mix by intuitively finding the tracks you are looking for. Even if you are sitting several meters away from the screen, you will not get lost in your mix. See [Applying Channel Colors to Channel Controls](#).

### **Video Export**

- Export videos including audio for your clients and collaborators directly from Cubase. The new video export feature lets you render videos as MP4 with H.264 video compression and 16-bit stereo audio in 44.1 or 48 kHz. Export the whole video or just footage within the locator range, adding the timecode to the video export for the next production process. See [Export Video](#).

## **More New Features**

### **Safe Mode**

- The new **Safe Mode** allows you to initiate Cubase without any third-party plug-ins loaded. See [Safe Mode Dialog](#).

### **Enter Track Name When Adding Folder Tracks**

- You can enter a name for a folder track when you add it via the **Add Track** dialog. See [Add Track Dialog – Folder](#).

### **New Preference for Cycle Activation**

- The new preference **Clicking Locator Range in Upper Part of the Ruler Activates Cycle** allows you to disable the function to activate/deactivate cycle mode when you click the locator range in the upper part of the ruler. See [Transport](#).



# Introduction

This is the **Operation Manual** for Steinberg's Cubase. Here you will find detailed information about all the features and functions in the program.

The screenshots are taken from Cubase Pro.

## Platform-Independent Documentation

The documentation applies to the operating systems Windows and macOS.

Features and settings that are specific to one of these platforms are clearly indicated. In all other cases, the descriptions and procedures in the documentation are valid for Windows and macOS.

Some points to consider:

- The screenshots are taken from Windows.
- Some functions that are available on the **File** menu on Windows can be found in the program name menu on macOS.

## PDF Documents and Online Documentation

The documentation consists of several documents. You can read them online or download them from [steinberg.help](http://steinberg.help). To visit [steinberg.help](http://steinberg.help), do one of the following:

- Enter [www.steinberg.help](http://www.steinberg.help) in the address bar of your web browser.
- In the program, select **Help > Cubase Help**.

### Operation Manual

The main Cubase reference documentation, with detailed descriptions of operations, parameters, functions, and techniques.

### Remote Control Devices

Lists the supported MIDI remote control devices.

### Plug-in Reference

Describes the features and parameters of the included VST plug-ins, VST instruments, and MIDI effects.

### Steinberg Library Manager

Describes how you can register and manage your VST Sound libraries.

### HALion Sonic SE

Describes the features and parameters of the included VST instrument HALion Sonic SE.

### Groove Agent SE

Describes the features and parameters of the included VST instrument Groove Agent SE.

**Retrologue**

Describes the features and parameters of the included VST instrument Retrologue.

**MIDI Devices**

Describes how to manage MIDI devices and device panels.

## Conventions

In our documentation, we use typographical and markup elements to structure information.

## Typographical Elements

The following typographical elements mark the following purposes.

**Prerequisite**

Requires you to complete an action or to fulfill a condition before starting a procedure.

**Procedure**

Lists the steps that you must take to achieve a specific result.

**Important**

Informs you about issues that might affect the system, the connected hardware, or that might bring a risk of data loss.

**Note**

Informs you about issues that you should consider.

**Tip**

Adds further information or useful suggestions.

**Example**

Provides you with an example.

**Result**

Shows the result of the procedure.

**After Completing This Task**

Informs you about actions or tasks that you can perform after completing the procedure.

**Related Links**

Lists related topics that you can find in this documentation.

## Markup

Bold text indicates the name of a menu, option, function, dialog, window, etc.

---

EXAMPLE

To open the **Functions** menu, click **Functions Menu** in the top right corner of the **MixConsole**.

---

If bold text is separated by a greater-than symbol, this indicates a sequence of different menus to open.

---

EXAMPLE

Select **Project > Add Track**.

---

## Key Commands

Many of the default key commands, also known as keyboard shortcuts, use modifier keys, some of which are different depending on the operating system.

When key commands with modifier keys are described in this manual, they are indicated with the Windows modifier key first, followed by the macOS modifier key and the key.

---

EXAMPLE

**Ctrl/Cmd-Z** means: press **Ctrl** on Windows or **Cmd** on macOS, then press **Z**.

---

# Setting up Your System

To use Cubase, you must set up your audio, and if required, your MIDI system.

## Studio Setup Dialog

The **Studio Setup** dialog allows you to set up your connected audio, MIDI, and remote control devices.

- To open the **Studio Setup** dialog, select **Studio > Studio Setup**.

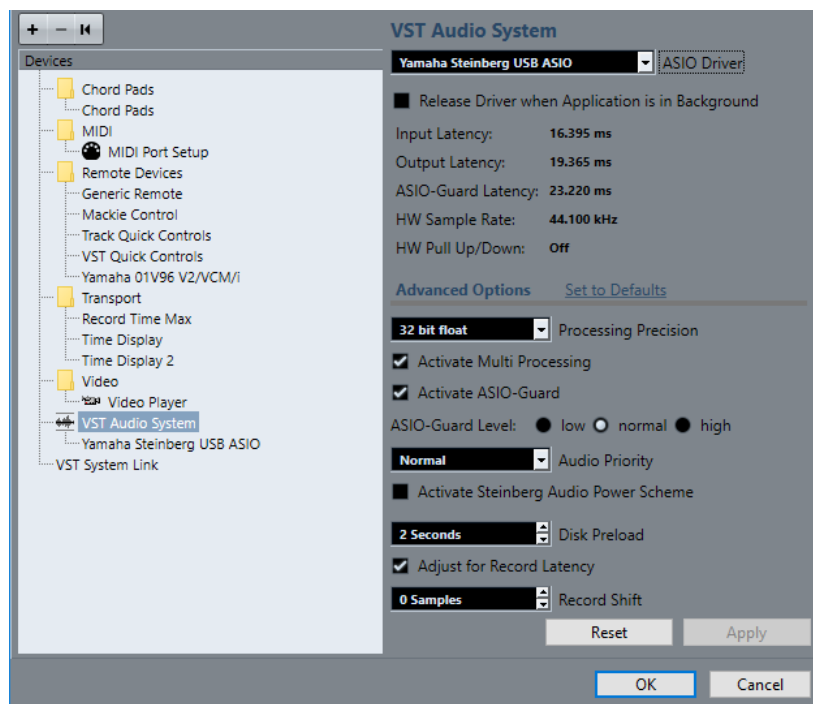

The following options are available:

### Add Device

Allows you to manually add devices such as a **Note Expression Input Device**, an additional **Time Display** device, or specific remote control devices.

### Remove Selected Device

Allows you to remove manually added devices.

### Send Reset Message to All Devices

Resets all remote control devices in the **Devices** list.

### Devices list

Select a device in the **Devices** list to show its settings in the right section.

**Reset**

Resets the selected remote device.

**Apply**

Applies the settings.

## Setting up Audio

You must set up your audio equipment before you can use it in Cubase.

**IMPORTANT**

Make sure that all equipment is turned off before making any connections.

---

### Simple Stereo Input and Output Setup

If you only use a stereo input and output from Cubase, you can connect your audio hardware, for example, the inputs of your audio card or your audio interface, directly to the input source and the outputs to a power amplifier and speaker.

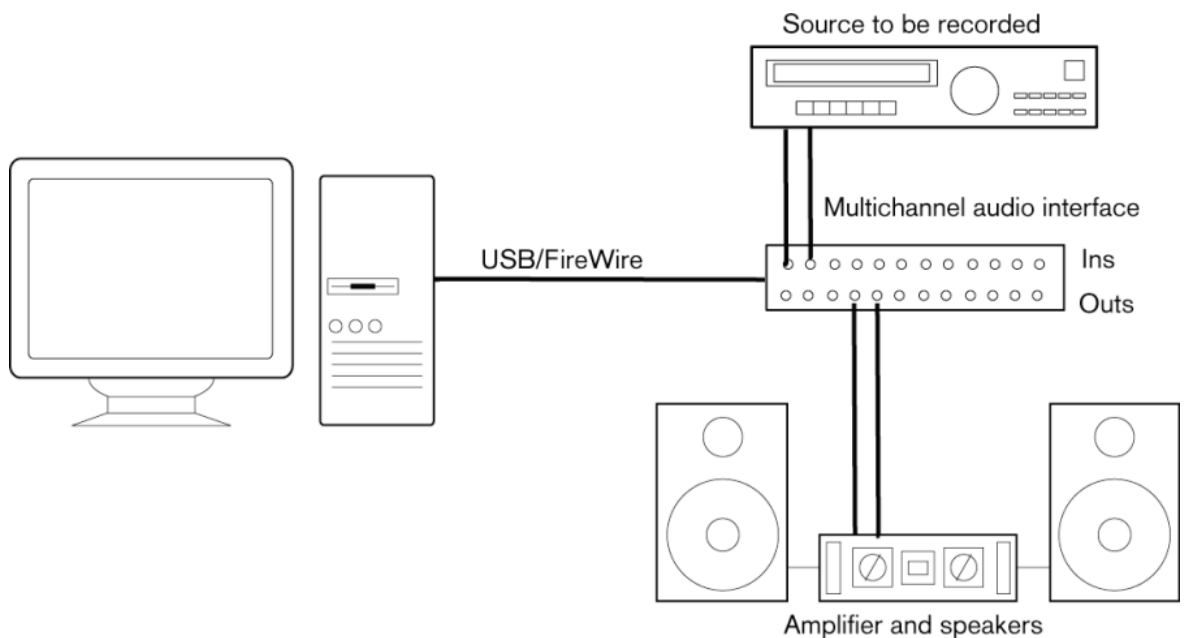

### Audio Connections

Your system setup depends on many different factors, for example, on the kind of project that you want to create, on the external equipment that you want to use, or on the computer hardware that is available to you. Therefore, the following sections can only serve as examples.

How to connect your equipment, that is, whether to use digital or analog connections also depends on your setup.

### Recording Levels and Inputs

When you connect your equipment, make sure that the impedance and levels of the audio sources and inputs are matched. Using the correct type of input is important to avoid distortion

or noisy recordings. For example, different inputs can be used, such as consumer line level (-10 dBV) or professional line level (+4 dBu).

Sometimes, you can adjust input characteristics on the audio interface or on its control panel. For details, refer to the documentation that came with the audio hardware.

#### IMPORTANT

Cubase does not provide any input level adjustments for the signals that are coming into your audio hardware, since these are handled differently for each card. Adjusting input levels is either done in a special application that is included with the hardware or its control panel.

---

## Word Clock Connections

If you are using a digital audio connection, you may also need a word clock connection between the audio hardware and external devices. For details, refer to the documentation that came with the audio hardware.

#### IMPORTANT

Set up word clock synchronization correctly, or you may experience clicks and crackles in your recordings.

---

## Selecting an Audio Driver

By selecting an audio driver, you allow Cubase to communicate with the audio hardware. Normally, when you start Cubase, a dialog opens that prompts you to select a driver, but you can also select your audio hardware driver as described below.

#### NOTE

On Windows operating systems, we recommend that you access your hardware via an ASIO driver developed specifically for the hardware. If no ASIO driver is installed, contact the manufacturer of your audio hardware for information on available ASIO drivers. If no specific ASIO driver is available, you can use the Generic Low Latency ASIO driver.

---

#### PROCEDURE

1. Select **Studio > Studio Setup**.
  2. In the **Devices** list, select **VST Audio System**.
  3. Open the **ASIO Driver** pop-up menu and select your audio hardware driver.
  4. Click **OK**.
- 

## Setting up Audio Hardware

You must select and set up your audio hardware in the **Studio Setup** dialog before you can use it.

#### PREREQUISITE

You have selected a driver for your audio hardware.

---

#### PROCEDURE

1. Select **Studio > Studio Setup**.
2. In the **Devices** list, select your audio hardware driver.
3. Do one of the following to open the control panel for your audio hardware:

- On Windows, click **Control Panel**.
- On macOS, click **Open Config App**.  
This button is available only for some hardware products. If it is not available in your setup, refer to the documentation of your audio hardware.

**NOTE**

The control panel is provided by the manufacturer of your audio hardware and is different for each audio interface brand and model. However, control panels for the Generic Low Latency ASIO Driver (Windows only) are provided by Steinberg.

---

4. Set up your audio hardware as recommended by the manufacturer.
- 

## VST Audio System Page

On the **VST Audio System** page you can select an ASIO driver for your audio hardware.

- To open the **VST Audio System** page, select **Studio > Studio Setup** and select **VST Audio System** in the **Devices** list.

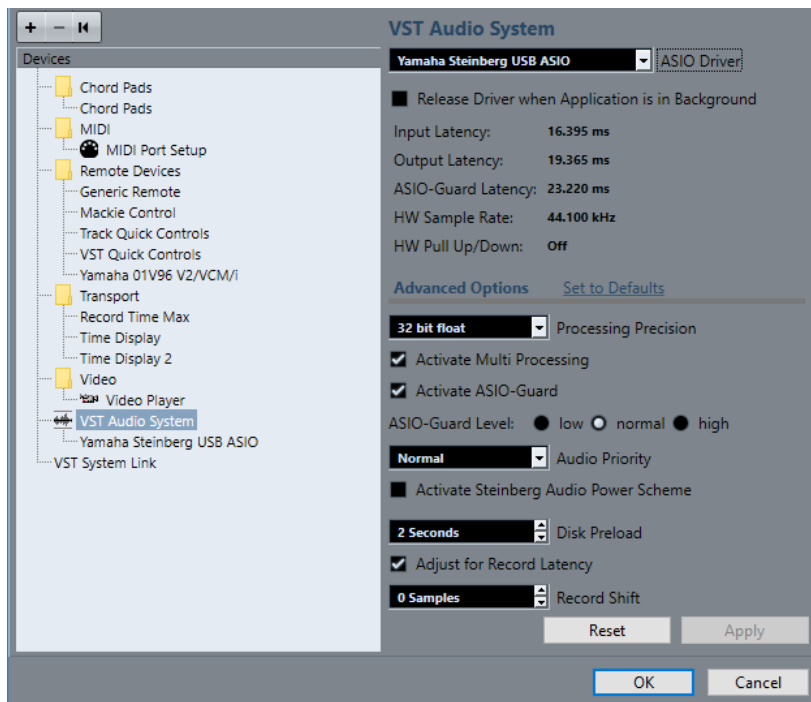

The following options are available:

### ASIO Driver

Allows you to select a driver.

### Release Driver when Application is in Background

Releases the driver and allows other applications to play back via your audio hardware even though Cubase is running.

### Input Latency

Shows the input latency of the audio hardware.

### Output Latency

Shows the output latency of the audio hardware.

### **ASIO-Guard Latency**

Shows the ASIO-Guard latency.

### **HW Sample Rate**

Shows the sample rate of your audio hardware.

### **HW Pull Up/Down**

Shows the pull up/down status of the audio hardware.

### **Set to Defaults**

Allows you to restore the default settings.

### **Processing Precision**

Allows you to set the audio processing precision to 32 bit float or 64 bit float. Depending on this setting, all channels are processed and mixed in 32-bit floating-point or 64-bit floating-point format.

#### **NOTE**

A processing precision of 64 bit float can increase CPU load and memory consumption.

To show all plug-ins that support 64-bit float processing, open the **VST Plug-in Manager** and activate **Show Plug-ins That Support 64-Bit Float Processing** in the **Display Options** pop-up menu.

#### **NOTE**

VST 2 plug-ins and instruments are always processed with 32-bit precision.

### **Activate Multi Processing**

Allows you to distribute the processing load evenly to all available CPUs. This way, Cubase can make full use of the combined power of multiple processors.

### **Activate ASIO-Guard**

Activates the ASIO-Guard. This is only available if **Activate Multi Processing** is activated.

### **ASIO-Guard Level**

Allows you to set the ASIO-Guard level. The higher the level, the higher the processing stability and audio processing performance. However, higher levels also lead to an increased ASIO-Guard latency and memory usage.

### **Audio Priority (Windows only)**

This setting should be set to **Normal** if you work with audio and MIDI. If you do not use MIDI at all, you can set this to **Boost**.

### **Activate Steinberg Audio Power Scheme**

If this option is activated, all power safe modes that have an impact on real time processing are deactivated. Note that this is only effective for very low latencies, and that it increases the power consumption.

### **Disk Preload**

Allows you to specify how many seconds of audio are preloaded into RAM prior to starting playback. This allows for smooth playback.

### **Adjust for Record Latency**

If this is activated, the plug-in latencies are taken into account during recording.



## Record Shift

Allows you to shift the recordings by the specified value.

### RELATED LINKS

[VST Plug-in Manager Window](#) on page 564

## ASIO Driver Setup Page

This page allows you to set up your ASIO driver.

- To open the page where you can set up the ASIO driver, select **Studio > Studio Setup** and select the audio driver in the **Devices** list.

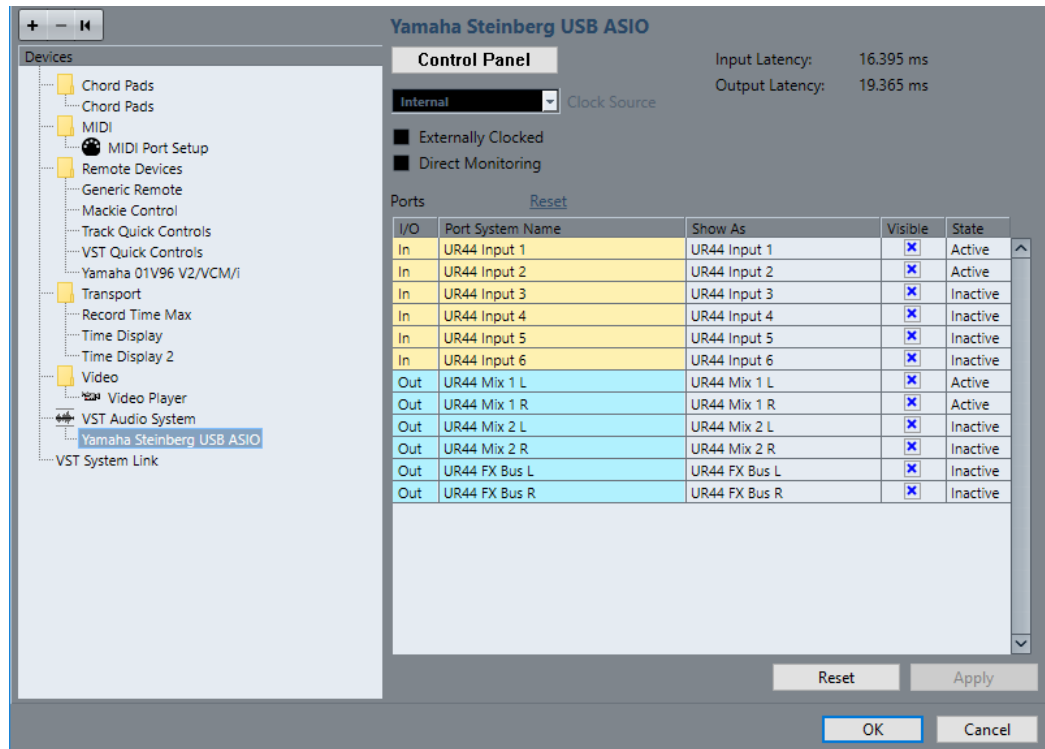

The following options are available:

### Control Panel

Opens the control panel for the audio hardware.

### Input Latency

Shows the input latency of the audio driver.

### Output Latency

Shows the output latency of the audio driver.

### Clock Source

Allows you to select a clock source.

### Externally Clocked

Activate this option if you use an external clock source.

### Direct Monitoring

Activate this option to monitor via your audio hardware and to control it from Cubase.

**Ports Reset**

Allows you to reset all port names and visibilities.

**I/O**

The port input/output status.

**Port System Name**

The system name of the port.

**Show As**

Allows you to rename the port. This name is used in the **Input Routing** and **Output Routing** pop-up menus.

**Visible**

Allows you to activate/deactivate audio ports.

**State**

The state of the audio port.

## Using External Clock Sources

If you are using an external clock source, Cubase must be notified that it receives external clock signals and derives its speed from that source.

---

PROCEDURE

1. Select **Studio > Studio Setup**.
  2. In the **Devices** list, select your audio hardware driver.
  3. Activate **Externally Clock**.
- 

RESULT

Cubase now derives its speed from the external source.

NOTE

For proper audio playback and recording, you must set the sample rate of the project to the sample rate of the incoming clock signals.

---

When a sample rate mismatch occurs, the **Record Format** field on the **Project** window status line is highlighted in a different color. Cubase accepts a sample rate mismatch, and playback is therefore faster or slower.

## Using Several Audio Applications Simultaneously

You can allow other applications to play back via your audio hardware even though Cubase is running.

PREREQUISITE

Other audio applications accessing the audio hardware are set to release the audio driver.

---

PROCEDURE

1. Select **Studio > Studio Setup**.
  2. In the **Devices** list, select **VST Audio System**.
  3. Activate **Release Driver when Application is in Background**.
-

#### RESULT

The application that has the focus gets access to the audio hardware.

## Audio Hardware Configuration

Most audio cards provide one or more small applications that allow you to customize your hardware.

The settings are normally gathered on a control panel that can be opened from within Cubase or separately, when Cubase is not running. For details, refer to the audio hardware documentation.

Settings include:

- Selecting which inputs/outputs are active.
- Setting up word clock synchronization.
- Turning on/off monitoring via the hardware.
- Setting levels for each input.
- Setting levels for the outputs so that they match the equipment that you use for monitoring.
- Selecting digital input and output formats.
- Making settings for the audio buffers.

## Setting up Input and Output Ports

Once you have selected the driver for your audio hardware and have set it up, you must specify which inputs and outputs to use.

#### PREREQUISITE

You have selected a driver for your audio hardware.

---

#### PROCEDURE

1. Select **Studio > Studio Setup**.
  2. In the **Devices** list, select your audio hardware driver.
  3. Make your changes.
  4. Click **OK**.
- 

#### RELATED LINKS

[ASIO Driver Setup Page](#) on page 17

## Audio Bus Setup

Cubase uses a system of input and output busses to transfer audio between the program and the audio hardware.

- Input busses let you route audio from the inputs of your audio hardware into Cubase. This means that audio is always recorded through one or several input busses.
- Output busses let you route audio from Cubase to the outputs of your audio hardware. This means that audio is always played back through one or several output busses.

Once you have set up the internal input and output busses, you can connect your audio source, for example, a microphone, to your audio interface and start recording, playing back, and mixing.

RELATED LINKS

[Audio Connections](#) on page 24

## Monitoring

In Cubase, monitoring means listening to the input signal while recording.

The following ways of monitoring are available:

- Externally by listening to the signal before it reaches Cubase.
- Via Cubase.
- By using ASIO Direct Monitoring.

This is a combination of the other methods.

RELATED LINKS

[External Monitoring](#) on page 235

[Monitoring via Cubase](#) on page 235

[ASIO Direct Monitoring](#) on page 236

## Setting up MIDI

You must set up your MIDI equipment before you can use it in Cubase.

### IMPORTANT

Turn off all equipment before making any connections.

---

### PROCEDURE

1. Connect your MIDI equipment (keyboard, MIDI interface, etc.) to your computer.
  2. Install the drivers for your MIDI equipment.
- 

### RESULT

You can use your MIDI equipment in Cubase.

## MIDI Connections

To play back and record MIDI data from your MIDI device, for example, a MIDI keyboard, you need to connect the MIDI ports.

Connect the MIDI output port of your MIDI device to the MIDI input port of your audio hardware. This way, the MIDI device sends MIDI data to be played back or recorded inside your computer.

Connect the MIDI input port of your MIDI device to the MIDI output port of your audio hardware. This way, you can send MIDI data from Cubase to the MIDI device. For example, you can record your own playing, edit the MIDI data in Cubase, and then play it back on the keyboard and record the audio that is coming out of the keyboard for a better edited performance.

## Showing or Hiding MIDI Ports

You can show the MIDI ports that you want to use and hide those that you do not use on the MIDI pop-up menus in the program.

---

### PROCEDURE

1. Select **Studio > Studio Setup**.
2. In the **Devices** list, select **MIDI Port Setup**.

3. To hide a MIDI port, deactivate its **Visible** column.
4. Click **OK**.

## Setting up All MIDI Inputs

When you record MIDI, you can specify which MIDI input each recording MIDI track should use. However, you can also record any MIDI data from any MIDI input. You can specify which inputs are included when you select **All MIDI Inputs** for a MIDI track.

### PROCEDURE

1. Select **Studio > Studio Setup**.
2. In the **Devices** list, select **MIDI Port Setup**.
3. Activate **In 'All MIDI Inputs'** for a port.

### NOTE

If you have a MIDI remote control unit connected, make sure to deactivate the **In 'All MIDI Inputs'** option for that MIDI input. This avoids accidental recording of data from the remote control when **All MIDI Inputs** is selected as input for a MIDI track.

4. Click **OK**.

### RESULT

When you select **All MIDI Inputs** on the **Input Routing** menu of a MIDI track in the **Inspector**, the MIDI track uses all MIDI inputs that you specified in the **MIDI Port Setup**.

## MIDI Port Setup Page

The **MIDI Port Setup** page in the **Studio Setup** dialog displays the connected MIDI devices and allows you to set up their ports.

- To open the **MIDI Port Setup** page, select **Studio > Studio Setup** and activate **MIDI Port Setup** in the **Devices** list.

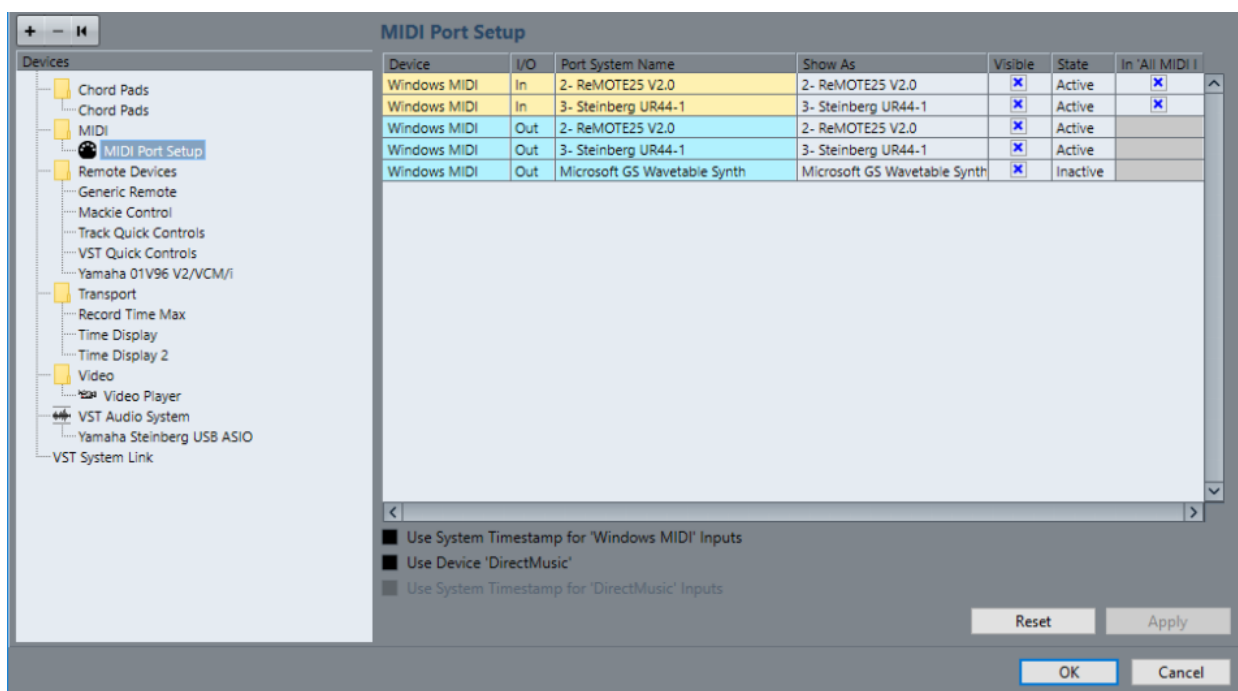

The following columns are displayed:

**Device**

The connected MIDI devices.

**I/O**

The port input/output status.

**Port System Name**

The system name of the port.

**Show As**

Allows you to rename the port. This name is used in the **Input Routing** and **Output Routing** pop-up menus.

**Visible**

Allows you to activate/deactivate MIDI ports.

**State**

The state of the MIDI port.

**In 'All MIDI Inputs'**

Allows you to record MIDI data from all MIDI inputs.

**NOTE**

Deactivate this option if you use remote control devices.

---

The following options are available:

**Use System Timestamp for 'Windows MIDI' Inputs**

Activate this option if you have persistent timing problems such as shifted notes. If this is activated, the system timestamp is used as a time reference.

**Use Device 'DirectMusic'**

If you do not use a device with a DirectMusic device driver, you can leave this option deactivated. This enhances the system performance.

**Use System Timestamp for 'DirectMusic' Inputs**

Activate this option if you have persistent timing problems such as shifted notes. If this is activated, the system timestamp is used as a time reference.

## Plug and Play Support for USB MIDI Devices

Cubase supports plug and play of USB MIDI devices. These devices can be plugged in and switched on while the application is running.

## Synchronizers

When using Cubase with external tape transports, you most likely must add a synchronizer to your system.

**IMPORTANT**

Make sure that all equipment is turned off before making any connections.

---

For information on how to connect and set up your synchronizer, refer to the documentation of your synchronizer.

RELATED LINKS

[Synchronization](#) on page 814

# Audio Connections

To play back and record in Cubase, you must set up input and output busses in the **Audio Connections** window.

The bus types that you need depend on your audio hardware, on your general audio setup, and on the projects that you use.

## Audio Connections Window

The **Audio Connections** window allows you to set up input and output busses.

- To open the **Audio Connections** window, select **Studio > Audio Connections**.

### Inputs/Outputs Tab

The **Inputs** and **Outputs** tabs allow you to set up and configure input and output busses.

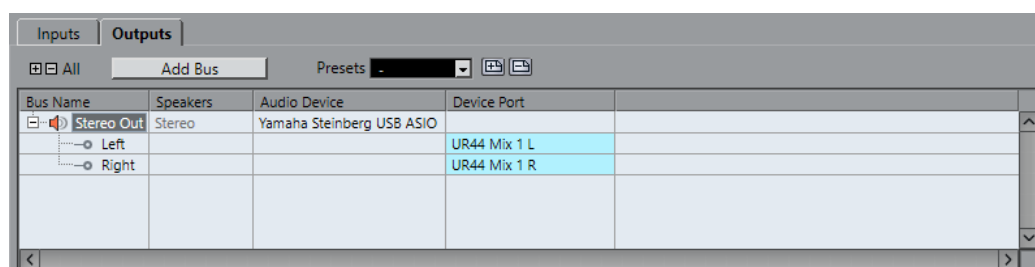

The following options are available above the bus list:

#### Add Bus

Opens the **Add Input Bus** dialog, where you can create a new bus configuration.

#### Presets

Opens the **Presets** menu, where you can select bus configuration presets. **Store** allows you to save a bus configuration as preset. **Delete** deletes the selected preset.

#### Expand All/Collapse

Expands/Collapses all busses in the bus list.

The following columns are available for the bus list:

#### Bus Name

Lists the busses. Click the name of a bus to select or rename it.

#### Speakers

Indicates the speaker configuration (mono, stereo) of each bus.

#### Audio Device

Shows the selected ASIO driver.



### Device Port

Shows which physical inputs/outputs on your audio hardware are used by the bus. Expand the bus entry to show all speaker channels. If the bus entry is collapsed, only the first port that is used by this bus is visible.

The **Device Port** pop-up menu displays how many busses are connected to a given port. The busses are shown in square brackets next to the port name.

Up to 3 bus assignments can be displayed in this way. If more connections have been made, this is indicated by a number at the end of the port name.

For example, "Adat 1 [Stereo1] [Stereo2] [Stereo3] (+2)" means that the Adat1 port is already assigned to 3 stereo busses plus 2 additional busses.

## Renaming the Hardware Inputs and Outputs

Before you set up busses, you should rename the default inputs and outputs of your audio hardware. This allows transferring projects between different computers and setups.

For example, if you move your project to another studio, the audio hardware may be of a different model. But if you and the other studio owner have agreed on identical names for your inputs and outputs, Cubase corrects inputs and outputs for your busses.

### NOTE

If you open a project that was created on another computer and the port names do not match or the port configuration is not the same, the **Missing Ports** dialog appears. This allows you to manually re-route ports that are used in the project to ports that are available on your computer.

---

### PROCEDURE

1. Select **Studio > Studio Setup**.
  2. In the **Devices** list, select **VST Audio System**.
  3. Open the **ASIO Driver** pop-up menu and select your audio hardware driver.
  4. In the **Devices** list, select your audio hardware driver.
  5. In the **Show As** column, click on a port name and enter a new name.
  6. Repeat the previous step until you have renamed all required ports.
  7. Click **OK**.
- 

### RELATED LINKS

[Re-Routing Missing Ports](#) on page 90

## Hiding Ports

You can hide ports that you are not using. Hidden ports are not displayed in the **Audio Connections** window.

---

### PROCEDURE

1. Select **Studio > Studio Setup**.
  2. In the **Devices** list, select your audio hardware driver.
  3. In the **Visible** column, deactivate the ports that you want to hide.
  4. Click **OK**.
-

## Activating and Deactivating Ports (macOS only)

On macOS you can specify which input and output ports are active. This allows you to use the microphone input instead of the line input or to deactivate the audio card input or output.

### NOTE

This function is only available for built-in audio, standard USB audio devices, and a certain number of other audio cards.

---

### PROCEDURE

1. Select **Studio > Studio Setup**.
  2. In the **Devices** list, select your audio hardware driver.
  3. Click **Control Panel**.
  4. Activate/Deactivate ports.
  5. Click **OK**.
- 

## Adding Input and Output Busses

You must add input and output busses to establish the connection between your audio hardware and Cubase.

---

### PROCEDURE

1. In the **Audio Connections** dialog, click the **Inputs** or **Outputs** tab.
  2. Click **Add Bus**.
  3. In the **Add Input Bus** dialog, configure the bus.
  4. Optional: Enter a name for the bus.  
If you do not specify a name, the bus is named according to the channel configuration.
  5. Click **Add Bus**.  
The new bus is added to the bus list.
  6. For each of the speaker channels in the bus, click in the **Device Port** column and select a port of your audio hardware.
- 

## Setting the Default Output Bus (Main Mix)

The **Main Mix** is the default output bus to which each new audio, group, or FX channel is automatically routed. If only one bus is available, this bus is automatically used as the default output bus.

### PREREQUISITE

Add an output bus.

---

### PROCEDURE

1. In the **Audio Connections** dialog, right-click the output bus that you want to use as default output bus.
  2. Select **Set <bus name> as Main Mix**.
-

#### RESULT

The selected bus is used as default bus. The **Main Mix** is indicated by a speaker icon next to its name.

#### RELATED LINKS

[Inputs/Outputs Tab](#) on page 24

## Presets for Input and Output Busses

For input and output bus configurations, you can use different kinds of presets.

- A number of standard bus configurations.
- Automatically created presets tailored to your specific hardware configuration.  
On startup, Cubase analyzes the physical inputs and outputs that are provided by your audio hardware and creates a number of hardware-dependent presets.
- Your own presets.

#### NOTE

You can create default presets for input and output bus configurations. If you create a new empty project, these default presets are applied. To create default presets, save your preferred input and output bus configurations under the name **Default**. If you have not defined default presets, the last used input and output bus configuration is applied when creating a new empty project.

---

## Saving a Bus Configuration Preset

You can save your own input and output bus configuration as presets.

---

#### PROCEDURE

1. Select **Studio > Audio Connections**.
  2. Click the **Inputs** or **Outputs** tab, and set up your bus configuration.
  3. Click **Store**.
  4. In the **Type in Preset Name** dialog, enter a name.
  5. Click **OK**.
- 

#### RESULT

The preset is available in the **Presets** menu.

## Deleting a Bus Configuration Preset

You can delete bus configuration presets that you no longer need.

---

#### PROCEDURE

1. Select **Studio > Audio Connections**.
  2. Click the **Inputs** or **Outputs** tab, and from the **Presets** menu, select the preset that you want to delete.
  3. Click **Delete**.
- 

#### RESULT

The preset is deleted.

## Monitoring Bus

The default output bus (**Main Mix**) is used for monitoring. You can adjust the monitoring level in the **MixConsole**.

### RELATED LINKS

[Setting the Default Output Bus \(Main Mix\)](#) on page 26

[MixConsole](#) on page 307

## Bus Configurations

After you have set up all the required busses for a project you can edit the names and change port assignments. The bus configuration is saved with the project.

## Removing Busses

You can remove busses that you no longer need.

---

### PROCEDURE

- In the **Audio Connections** window, do one of the following:
    - To remove a single bus, right-click the bus in the list and select **Remove Bus**. Alternatively, you can select the bus and press **Backspace**.
    - To remove multiple input or output busses at the same time, use **Shift** or **Ctrl/Cmd** to select them in the list, right-click them, and select **Remove Selected Busses**.
- 

## Changing Port Assignments

You can change the port assignment of busses.

---

### PROCEDURE

1. Select **Studio > Audio Connections**.
  2. Do one of the following:
    - To change the assignment of a single bus, open the **Device Port** pop-up menu, and select a new port.
    - To assign subsequent busses to several selected busses, open the **Device Port** pop-up menu for the first selected entry, press **Shift**, and select a device port.
    - To assign the same port to several selected busses, open the **Device Port** pop-up menu for the first selected entry, press **Shift-Alt**, and select a device port.
- 

## Renaming Multiple Busses

You can rename all the selected busses at once using incrementing numbers or letters.

---

### PROCEDURE

1. Select **Studio > Audio Connections**.
2. Select the busses that you want to rename.
3. Do one of the following:
  - Enter a new name for one of the busses, followed by a number.
  - Enter a new name for one of the busses, followed by a space and a capital letter.

4. Press **Return**.

---

RESULT

The busses are renamed automatically using either incrementing numbers or letters.

NOTE

The renaming starts from the bus where you edit the name until the bottom, and then continues from the top until all selected busses have been renamed.

---

## Exclusive Port Assignments

For certain channel types, the port assignment is exclusive.

Once a port has been assigned to such a bus or channel, it must not be assigned to another bus, otherwise the connection to the first bus will be broken.

The corresponding ports are marked in the **Audio Connections** window on the **Device Port** pop-up menu.

# Project Window

The **Project** window provides an overview of the project, and allows you to navigate and perform large scale editing.

Each project has one **Project** window. The **Project** window is displayed whenever you open or create a new project.

- To open a project, select **File > Open**.
- To create a new project, select **File > New Project**.



The **Project** window is divided into several zones:

## 1 Left Zone

The left zone shows the **Inspector** that features two tabs:

- The **Track** tab shows the settings for the track that is selected in the track list.

### NOTE

In this documentation we use **Inspector** to refer to the **Track** tab of the **Inspector**.

- The **Editor** tab shows the settings for the editor that is open in the lower zone.

You can also open the **Visibility** tab that features the following tabs:

- The **Track** tab allows you to show/hide individual tracks from the track list.

- The **Zones** tab allows you to determine and lock the position of certain **MixConsole** channels in the lower zone.

## 2 Project Zone

The project zone shows the toolbar, the track list with the tracks, the event display with the parts and events of the project, and the **Project** window ruler.

On the toolbar, you can activate/deactivate the status line, the info line, the overview line, and the **Transport Bar**.

## 3 Lower Zone

The lower zone shows the **Chord Pads**, the **Editor**, the **Sampler Control**, and the **MixConsole**.

## 4 Right Zone

The right zone shows the **VSTi** rack, and the **Media** rack.

### RELATED LINKS

[Project Zone](#) on page 31

[Left Zone](#) on page 45

[Lower Zone](#) on page 52

[Right Zone](#) on page 58

[Project Window Toolbar](#) on page 32

## Showing/Hiding Zones

You can show/hide the zones in the **Project** window according to your needs.

---

### PROCEDURE

- Do one of the following:
  - To show/hide the left zone, click **Show/Hide Left Zone** on the **Project** window toolbar.
  - To show/hide the lower zone, click **Show/Hide Lower Zone** on the **Project** window toolbar.
  - To show/hide the right zone, click **Show/Hide Right Zone** on the **Project** window toolbar.

### NOTE

The project zone is always shown.

---

### RELATED LINKS

[Project Window Toolbar](#) on page 32

## Project Zone

The project zone is the heart of the **Project** window and cannot be hidden.

The project zone features the track list and the event display with the ruler. Furthermore, you can activate/deactivate the status line, the info line, the overview line, and the **Transport Bar** for the project zone.

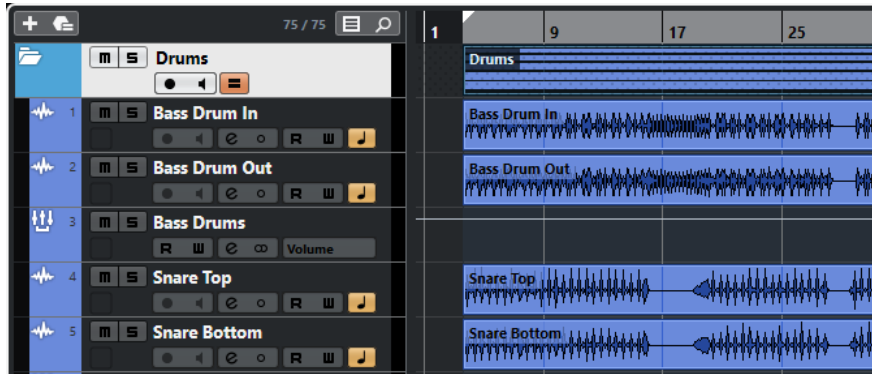

#### RELATED LINKS

- [Track List](#) on page 39
- [Event Display](#) on page 40
- [Global Track Controls](#) on page 40
- [Ruler](#) on page 42
- [Status Line](#) on page 43
- [Info Line](#) on page 43
- [Overview Line](#) on page 44
- [Transport Bar](#) on page 44

## Project Window Toolbar

The toolbar contains tools and shortcuts for opening other windows and various project settings and functions.

- To show/hide tools, open the toolbar context menu by right-clicking in an empty area of the toolbar and activate the tools that you want to display. To show all tools, select **Show All**.

#### NOTE

The number of elements that are shown also depends on the size of the **Project** window and the screen resolution.

The following options are available:

#### Activate Project



#### NOTE

Only available if more than one project is open.

Activates a project.

#### Project History

##### Undo/Redo



Undoes/Redoes actions in the **Project** window.



## Constrain Delay Compensation

### Constrain Delay Compensation



Minimizes the latency effects of the delay compensation.

## Left Divider

### Left Divider



Tools that are placed to the left of the divider are always shown.

## Media & MixConsole Windows

### Open MediaBay



Opens/Closes the **MediaBay**.

### Open Pool Window



Opens/Closes the **Pool** window.

### Open MixConsole



Opens/Closes the **MixConsole**.

## Track Visibility Configurations

### Track Visibility Configurations

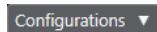

Allows you to create configurations that are useful for switching between different visibility setups.

### Set Track Type Filter



Allows you to filter the tracks by track type. **Alt**-click to reset the track type filter.

### Set Track Visibility Agents



Allows you to set a visibility agent to filter the tracks.

## State Buttons

### Deactivate All Mute States



Deactivates all mute states.

### Deactivate All Solo States



Deactivates all solo states.

### Activate/Deactivate Read for All Tracks



Activates/Deactivates read automation for all tracks.

### Activate/Deactivate Write for All Tracks



Activates/Deactivates write automation for all tracks.

### Suspend All Read/Write Automation



Suspends all read/write automation.

## Auto-Scroll

### Auto-Scroll



Keeps the project cursor visible during playback.

### Select Auto-Scroll Settings



Allows you to activate **Page Scroll** or **Stationary Cursor** and to activate **Suspend Auto-Scroll When Editing**.

## Locators

### Go to Left Locator Position



Allows you to go to the left locator position.

### Left Locator Position

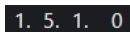

Shows the left locator position.

### Go to Right Locator Position



Allows you to go to the right locator position.

### Right Locator Position

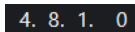

Shows the right locator position.

## Transport Controls

### Go to Previous Marker/Zero



Moves the project cursor to the previous marker/zero position on the timeline.

### Go to Next Marker/Project End



Moves the project cursor to the next marker/project end.

### Rewind



Moves backward.

### Forward



Moves forward.

### Activate Cycle



Activates/Deactivates cycle mode.

### Stop



Stops playback.

### Start



Starts playback.

### Transport Record



Activates/Deactivates record mode.

## Tool Buttons

### Combine Selection Tools



Combines the **Object Selection** tool and the **Range Selection** tool.

### Object Selection



Selects events and parts.

### Range Selection



Selects ranges.

### Draw



Draws events.

### Erase



Erases events.

### Split



Splits events.

### Glue



Glues events together.

### Mute



Mutes events.

### Zoom



Zooms in. Hold **Alt** and click to zoom out.

### Comp



Assembles takes.

### Line



Creates a series of contiguous events.

### Play



Allows you to play back events.

### Color



Allows you to colorize events.

## Color Menu

### Select Color for Selected Tracks or Events



Opens the **Colorize** pane that allows you to colorize the selected tracks or events.

## Nudge Palette

### Trim Start Left



Increases the length of the selected event by moving its start to the left.

### Trim Start Right



Decreases the length of the selected event by moving its start to the right.

### Move Left



Moves the selected event to the left.

### Move Right



Moves the selected event to the right.

### Trim End Left



Decreases the length of the selected event by moving its end to the left.

### Trim End Right



Increases the length of the selected event by moving its end to the right.

## Project Root Key

### Project Root Key



Changes the root key of the project.

## Snap

### Snap to Zero Crossing



Restricts editing to zero crossings, that is, positions where the amplitude is zero.

### Snap On/Off



Restricts horizontal movement and positioning to the positions specified by the **Snap Type**.

### Snap Type



Allows you to specify to what positions you want events to snap.

## Grid Type

### Grid Type



Allows you to specify a grid type for the **Snap** function. This setting only has effect if **Snap Type** is set to one of the grid options.

## Quantize

### Apply Quantize



Applies the quantize settings.

### Quantize Presets



Allows you to select a quantize preset.

### Iterative Quantize On/Off



Activates/Deactivates iterative quantize.

### AudioWarp Quantize On/Off



Activates/Deactivates **AudioWarp** quantize.

### Open Quantize Panel



Opens the **Quantize Panel**.

## System Performance Meter

### System Performance Meter



Shows the meters for average audio processing load and the disk cache load.

## Right Divider

### Right Divider



Tools that are placed to the right of the divider are always shown.

## Window Zone Controls

### Show/Hide Left Zone



Shows/Hides the left zone of the window.

### Show/Hide Lower Zone



Shows/Hides the lower zone of the window.

### Show/Hide Right Zone



Shows/Hides the right zone of the window.

### Set up Window Layout



Allows you to set up the window layout.

## Set up Toolbar

### Set up Toolbar



Opens a pop-up menu where you can set up which toolbar elements are visible.

#### RELATED LINKS

[Left/Right Toolbar Divider](#) on page 38

[Snap Types Menu](#) on page 68

[Markers](#) on page 300

[Automation](#) on page 535

[Synchronization](#) on page 814

## Left/Right Toolbar Divider

The left and right toolbar dividers allow you to lock the position of specific tools at the left or at the right side of the toolbar, so that they are always shown.

All other items are shown in the center of the toolbar. When you reduce the width of the **Project** window, these toolbar items are hidden successively. When you increase the width, they are shown again.

## Toolbox

The toolbox makes the editing tools from the toolbar available at the mouse pointer position. It can be opened instead of the standard context menus in the event display and editors.



- To activate the toolbox function, activate **Show Toolbox on Right-Click** in the **Preferences** dialog (**Editing—Tools** page).
- To open the toolbox, right-click in the event display or editor.  
If **Show Toolbox on Right-Click** is deactivated, the context menu opens.
- To open the context menu instead of the toolbox, press any modifier key and right-click in the event display or editor.

If **Show Toolbox on Right-Click** is deactivated, press any modifier key to open the toolbox instead of the context menu.

## Track List

The track list shows the tracks that are used in the project. When a track is added and selected, it contains name fields and settings for this track.

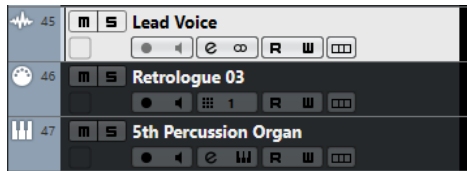

- To decide which controls are visible for each track type, right-click the track list and open the **Track Controls Settings** dialog.

### RELATED LINKS

[Track Controls Settings Dialog](#) on page 97

## Dividing the Track List

You can divide the track list into an upper track list and a lower track list. These track lists can have independent zoom and scroll controls. Dividing the track list is useful if you are working with a video track and multi-track audio, for example. It allows you to place the video track in the upper track list and to scroll the audio tracks separately in the lower track list, so that they can be arranged with the video.

### PROCEDURE

- Do one of the following:
  - Select **Project > Divide Track List**.
  - Click **Divide Track List** in the top right corner of the **Project** window below the ruler.

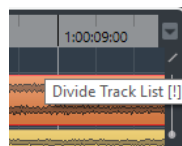

### RESULT

The track list is divided and video, marker, or arranger tracks are automatically moved to the upper track list. All other track types are moved to the lower track list.

### AFTER COMPLETING THIS TASK

- To move any type of track from the lower track list to the upper and vice versa, right-click it in the track list and select **Toggle Track List** from the context menu.
- To resize the upper part of the track list, click and drag the divider between the track list sections.
- To revert to a single track list, click **Divide Track List** again.

## Event Display

The event display shows the parts and events that are used in the project. They are positioned along the timeline.

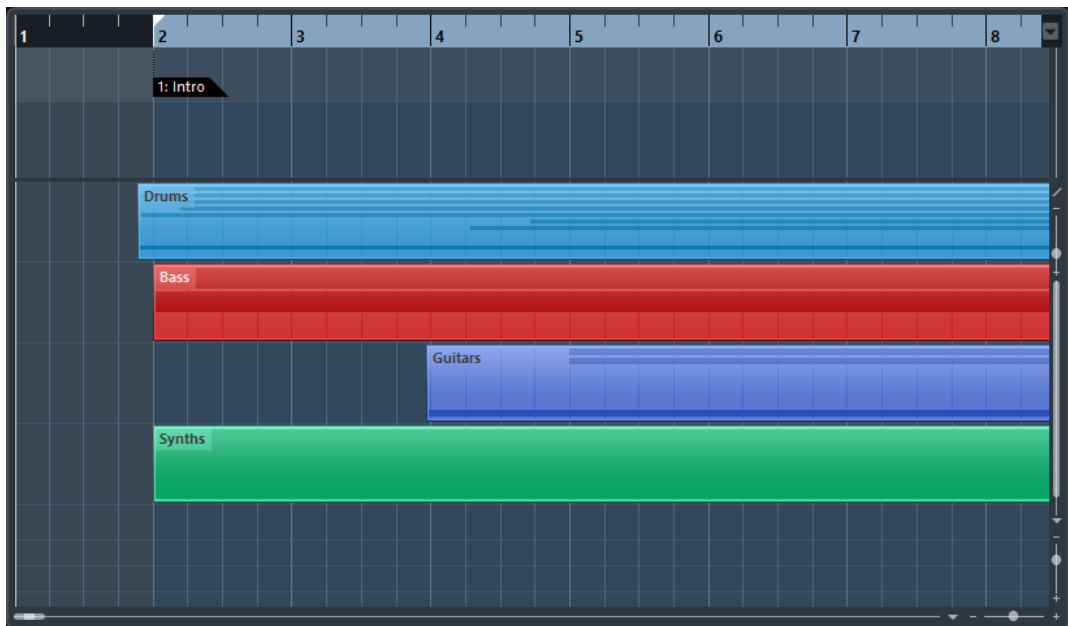

## Global Track Controls

The global track controls allow you to manage the tracks in the track list.

- The global track controls are shown above the track list.



- 1 Add Track**  
Opens the **Add Track** dialog.
- 2 Use Track Preset**  
Allows you to add a track using a track preset.
- 3 Number of Visible Tracks**  
Displays how many tracks are hidden. Click this to show all tracks that are filtered out by the **Visibility** tab.

### NOTE

If the track was outside the view or hidden, it is now shown. Tracks that are hidden using **Set Track Type Filter** are not shown.

- 4 Set Track Type Filter**  
Determines which track types are shown in the track list.



## 5 Find Tracks

Finds and selects specific tracks in the track list.

### RELATED LINKS

[Opening the Visibility](#) on page 50

## Filtering Track Types

You can filter tracks by their track type.

---

### PROCEDURE

1. Click **Set Track Type Filter** above the track list.  
This opens the track types filter.

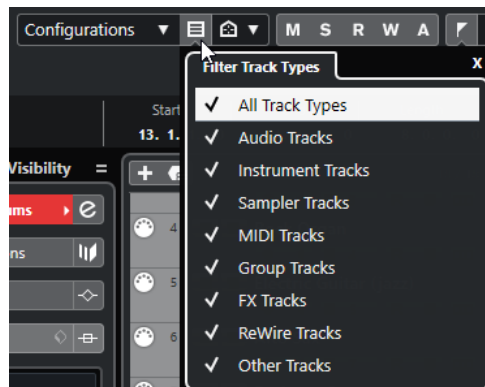

2. Uncheck a track type to hide it.

---

### RESULT

Tracks of the filtered type are removed from the track list and the color of the **Set Track Type Filter** button changes to indicate that a track type is hidden.

## Finding Tracks

The **Find Tracks** function allows you to find specific tracks. This is useful if you have a large project with many tracks or if you have hidden tracks using the **Visibility** tab.

---

### PROCEDURE

1. Click **Find Tracks** above the track list to open a selector that lists all tracks.
2. In the search field, enter the name of the track.  
As you type, the selector updates automatically.
3. In the selector, select the track and press **Return**.

---

### RESULT

The selector closes and the track is selected in the track list.

### NOTE

If the track was outside the view or hidden, it is now shown. Tracks that are hidden using **Set Track Type Filter** are not shown.

---

## Ruler

The ruler shows the timeline and the display format of the project.



Initially, the **Project** window ruler uses the display format that is specified in the **Project Setup** dialog.

- To select an independent display format for the ruler, click the arrow button to the right of the ruler and select an option from the pop-up menu.
- To set the display format globally for all windows, use **Select Primary Time Format** pop-up menu on the **Transport** panel, or hold down **Ctrl/Cmd** and select a format in any ruler.

### RELATED LINKS

[Project Setup Dialog](#) on page 86

## Ruler Display Format Menu

You can select a display format for the ruler.

- To show the ruler display formats, click the arrow button to the right of the ruler.

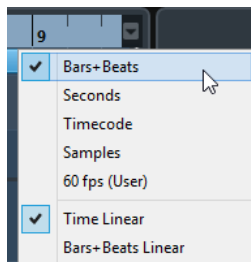

The selection that you make affects the time display formats in the following areas:

- Ruler
- Info line
- Tooltip position values

The following options are available:

### **Bars+Beats**

Sets the ruler to display bars, beats, sixteenth notes, and ticks. By default, there are 120 ticks per sixteenth note. To change this, adjust the **MIDI Display Resolution** setting in the **Preferences** dialog (**MIDI** page).

### **Seconds**

Sets the ruler to display hours, minutes, seconds, and milliseconds.

### **Timecode**

Sets the ruler to display hours, minutes, seconds, and frames. The number of frames per second (fps) is set in the **Project Setup** dialog with the **Project Frame Rate** pop-up menu. To display subframes, activate **Show Timecode Subframes** in the **Preferences** dialog (**Transport** page).

### **Samples**

Sets the ruler to display samples.

### **fps (User)**

Sets the ruler to display hours, minutes, seconds, and frames, with a user-definable number of frames per second. To display subframes, activate **Show Timecode**

**Subframes** in the **Preferences** dialog (**Transport** page). You can also set the number of frames per second.

#### Time Linear

Sets the ruler linear to time.

#### Bars+Beats Linear

Sets the ruler linear to bars and beats.

## Status Line

The status line shows the most important project settings.

- To activate the status line, click **Set up Window Layout** on the toolbar and activate **Status Line**.

The following information is shown on the status line:

Audio Inputs	Connected	Audio Outputs	Connected	Max. Record Time	282 hours 49 mins
Record Format	44.1 kHz - 24 bit	Project Frame Rate	30 fps	Project Pan Law	Equal Power

#### Audio Inputs/Audio Outputs

These fields are shown if the audio device ports are not connected. Click to open the **Audio Connections** dialog and connect the ports.

#### Max. Record Time

Displays the remaining time for recording, depending on your project settings and the available hard disk space. Click in this field to display the remaining record time in a separate window.

#### Record Format

Displays the sample rate and the bit depth used for recording. Click in this field to open the **Project Setup** dialog.

#### Project Frame Rate

Displays the frame rate used in the project. Click in this field to open the **Project Setup** dialog.

#### Project Pan Law

Displays the current pan law setting. Click in this field to open the **Project Setup** dialog.

#### RELATED LINKS

[Project Window Toolbar](#) on page 32

## Info Line

The info line shows information about the event or part that you selected in the project zone.

Name	Start	End	Length	Offset		
MIDI 01	1. 1. 1. 0	2. 2. 1. 0	1. 1. 0. 0	0. 0. 0. 0		
Mute	Lock	Transpose	Global Transpose	Velocity	Root Key	
-	-	0	Follow	0	-	

To activate the info line, click **Set up Window Layout** on the toolbar and activate **Info Line**.

#### RELATED LINKS

[Project Window Toolbar](#) on page 32

## Value Editing Rules on the Info Line

You can edit almost all event or part data on the info line using regular value editing.

If you select several events or parts, the info line is shown in another color and only the information about the first item in the selection is displayed. The following rules apply:

- Value changes are applied to all selected elements, relative to the current values.  
For example, you have selected two audio events. The first event has a length of 1 bar, the second of 2 bars. If you change the info line value to 3, the first event is resized to 3 bars and the second event to 4 bars.
- Value changes are applied absolutely to the current values if you press **Ctrl/Cmd** while modifying the value on the info line.  
In the example above, both events are resized to 3 bars.

### NOTE

To change the modifier, select a new modifier in the **Info Line** category of the **Preferences** dialog (**Editing—Tool Modifiers** page).

---

## Overview Line

The overview line allows you to zoom and navigate to other sections in the project.



To activate the overview line, click **Set up Window Layout** on the toolbar and activate **Overview**.

In the overview line, events and parts are displayed as boxes. A rectangle indicates the section of the project that is displayed in the event display.

- To zoom the event display in or out horizontally, resize the rectangle by dragging the edges.
- To navigate to another section of the event display, drag the rectangle to the left or right, or click in the upper part of the overview.

### RELATED LINKS

[Project Window Toolbar](#) on page 32

## Transport Bar

The **Transport Bar** allows displaying the transport functions in an integrated and fixed zone of the **Project** window.

- To activate the **Transport Bar**, click **Set up Window Layout** on the **Project** window toolbar and activate **Transport Bar**.
- To show/hide tools, open the **Transport Bar** context menu by right-clicking in an empty area of the **Transport Bar** and activate the tools that you want to display. To show all tools, select **Show All**.

### RELATED LINKS

[Common Record Modes Menu](#) on page 234

[Audio Record Modes](#) on page 239

[MIDI Record Modes](#) on page 246

[Left/Right Toolbar Divider](#) on page 38

[Project Window Toolbar](#) on page 32

## Left Zone

The left zone of the **Project** window allows you to display the **Inspector** and the **Visibility** tab.

To show/hide the left zone, click **Show/Hide Left Zone** on the **Project** window toolbar.

The top of the left zone features the following tabs:

- **Inspector**
- **Visibility**

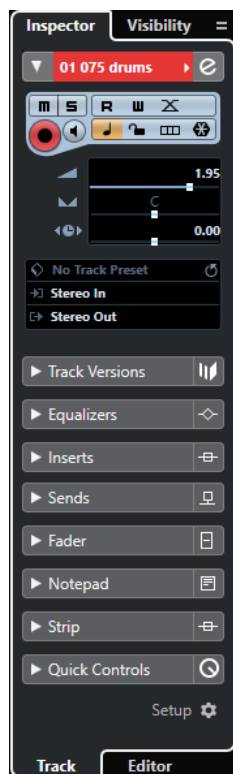

### RELATED LINKS

[Inspector](#) on page 45

[Visibility](#) on page 49

[Project Window Toolbar](#) on page 32

## Inspector

The **Inspector** allows you to show controls and parameters for either the selected track in the track list or the event or part that is shown in the editor in the lower zone.

- To show/hide the **Inspector**, click **Show/Hide Left Zone** in the **Project** window toolbar.

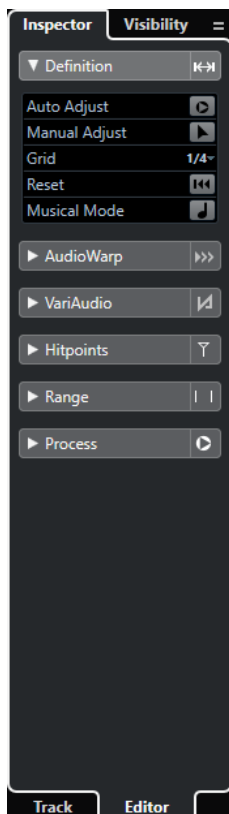

The following tabs are available:

### Track

Opens the **Track Inspector** for the selected track.

### Editor

Opens the **Editor Inspector** for the event or part that is shown in the editor in the lower zone.

#### RELATED LINKS

[Opening the Track Inspector](#) on page 46

[Opening the Editor Inspector](#) on page 47

[Opening the Editor in the Lower Zone](#) on page 55

## Opening the Track Inspector

The **Track Inspector** shows controls and parameters for the selected track in the track list.

---

#### PROCEDURE

1. Click **Show/Hide Left Zone** on the **Project** window toolbar to activate the **Left Zone**.
2. At the bottom of the left zone, click the **Track** tab.

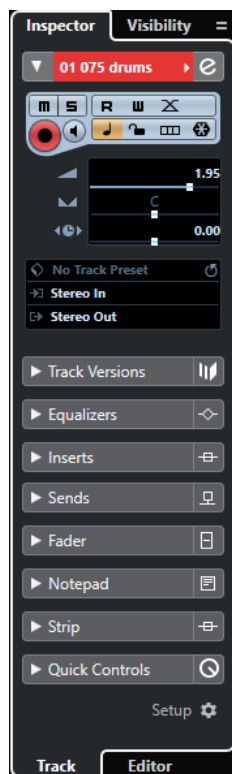

---

#### RESULT

The **Track Inspector** for the selected track opens. If more than one track is selected in the track list, the controls and parameters for the topmost selected track are shown.

#### NOTE

In this documentation we use **Inspector** to refer to the **Track** tab of the **Inspector**.

---

## Opening the Editor Inspector

The **Editor Inspector** shows controls and parameters for the event or part that is shown in the editor in the lower zone.

#### PREREQUISITE

The **Sample Editor**, the **Audio Part Editor**, the **Key Editor**, the **Drum Editor**, or the **Score Editor** is shown in the lower zone.

---

#### PROCEDURE

1. Click **Show/Hide Left Zone** on the **Project** window toolbar to activate the **Left Zone**.
2. At the bottom of the left zone, click the **Editor** tab.

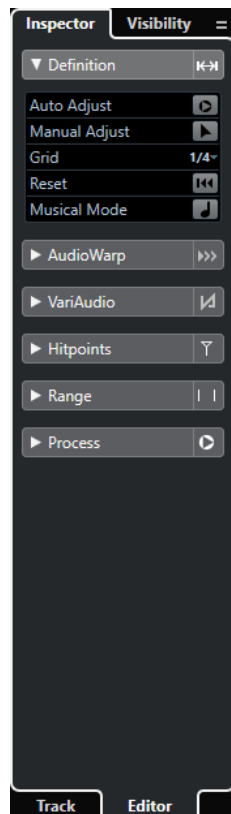

---

#### RESULT

The **Editor Inspector** for the event or part opens.

#### NOTE

The **Editor Inspector** only contains information if the lower zone shows an editor. Otherwise, it is empty.

---

#### RELATED LINKS

[Opening the Editor in the Lower Zone](#) on page 55

## Inspector Sections

The **Track** tab and the **Editor** tab of the **Inspector** are divided into a number of sections that each contain different controls for the track, event or part.

Not all **Inspector** sections are shown by default. The available sections depend on the type of the selected track, event, or part, and on the settings in the setup dialog for the **Track** tab and the **Editor** tab of the **Inspector**.

- To open/close sections, click their names.  
Opening one section closes the other sections.
- To open a section without closing the other sections, **Ctrl/Cmd**-click the section name.

#### RELATED LINKS

[Track Inspector Settings Dialog](#) on page 94

[Inspector Sections](#) on page 95

[Audio Track Inspector](#) on page 105

[Instrument Track Inspector](#) on page 108

[MIDI Track Inspector](#) on page 115



- [Sampler Track Inspector](#) on page 112
- [Arranger Track Inspector](#) on page 129
- [Marker Track Inspector](#) on page 133
- [Signature Track Inspector](#) on page 134
- [Tempo Track Inspector](#) on page 136
- [Transpose Track Inspector](#) on page 137
- [Video Track Inspector](#) on page 138
- [Key Editor Inspector](#) on page 647
- [Drum Editor Inspector](#) on page 679
- [Sample Editor Inspector](#) on page 420

## Visibility

The **Visibility** tab allows you to show or hide individual tracks from the track list and to determine the position of certain **MixConsole** channels in the lower zone.

- To open the **Visibility** tab, click **Visibility**.

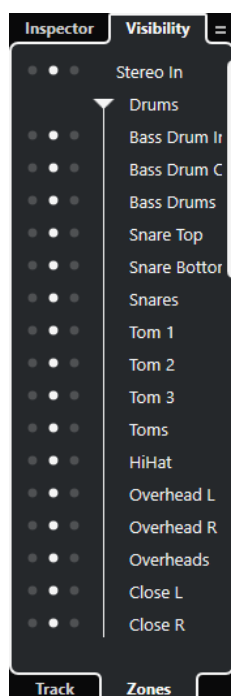

The following tabs are available:

### Track

Allows you to show or hide individual tracks from the track list.

### Zones

Allows you to determine and lock the position of certain **MixConsole** channels in the lower zone.

### RELATED LINKS

[Opening the MixConsole in the Lower Zone](#) on page 54

## Opening the Visibility

The **Visibility** tab allows you to show or hide individual tracks from the track list.

---

### PROCEDURE

1. Click **Show/Hide Left Zone** on the **Project** window toolbar to activate the **Left Zone**.
2. At the top of the left zone, click the **Visibility** tab.
3. At the bottom of the left zone, click the **Track** tab.



### RELATED LINKS

[Showing/Hiding Individual Tracks](#) on page 50

## Showing/Hiding Individual Tracks

The **Visibility** tab shows a list of all tracks of your project. This list allows you to show and hide individual tracks.

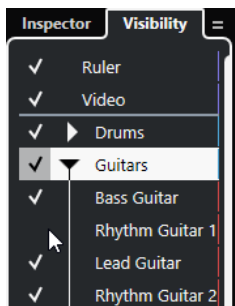

- To show/hide a track in the track list, check/uncheck it by clicking to the left of the track name.
- To activate/deactivate several tracks at the same time, select them and press **Return**.
- To show a hidden track exclusively, check it by **Shift**-clicking to the left of the track name.
- To expand or collapse a folder, click the triangle to the left of a folder track.

#### NOTE

- The channels of the **MixConsole** in the lower zone are updated accordingly. This means that if you hide a track using the **Visibility** tab, the channel corresponding to that track is also hidden in the **MixConsole** in the lower zone.
  - If you want to synchronize the track and the channel visibility in a separate **MixConsole** window, you must use the **Sync Visibility of Project and MixConsole** function.
- 

#### RELATED LINKS

[Synchronizing Track and Channel Visibility](#) on page 51

## Synchronizing Track and Channel Visibility

You can synchronize the track visibility in the **Project** window with the channel visibility in a separate **MixConsole** window.

#### PROCEDURE

1. At the top of the left zone, select the **Visibility** tab.
2. At the bottom of the left zone, select the **Track** tab.
3. Click the equals sign to open the **Sync Visibility of Project and MixConsole: On/Off** menu.

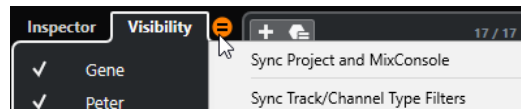

4. Select **Sync Project and MixConsole** to synchronize the track visibility with the channel visibility.
- 

#### RESULT

The track and channel visibility are synchronized.

#### NOTE

- You can only synchronize the track visibility in the **Project** window with the channel visibility of one **MixConsole**. If you enable **Sync Visibility of Project and MixConsole: On/Off** for a second **MixConsole**, the first link is lost.
  - If you divide the track list, the top part of the list is not affected. Likewise, channels in the left or right zones of the **MixConsole** are not synchronized.
- 

#### RELATED LINKS

[Synchronizing Channel and Track Visibility](#) on page 313

## Opening the Zones

The **Zones** tab allows you to determine and lock the position of certain **MixConsole** channels in the lower zone.

#### PROCEDURE

1. At the top of the left zone, click the **Visibility** tab.
2. At the bottom of the left zone, click the **Zones** tab.

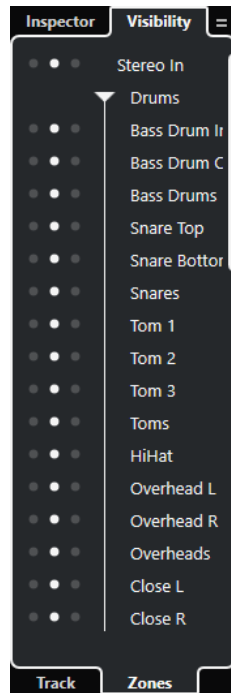

#### RESULT

The **MixConsole** opens in the lower zone.

#### RELATED LINKS

[Opening the MixConsole in the Lower Zone](#) on page 54

## Lower Zone

The lower zone of the **Project** window allows you to display specific windows and editors in an integrated and fixed zone of the **Project** window. This is useful if you work on single screen systems and notebooks, for example.

To show/hide the lower zone, click **Show/Hide Lower Zone** on the **Project** window toolbar.

The lower zone features the following tabs: **Chord Pads**, **MixConsole**, **Sampler Control**, and **Editor**.

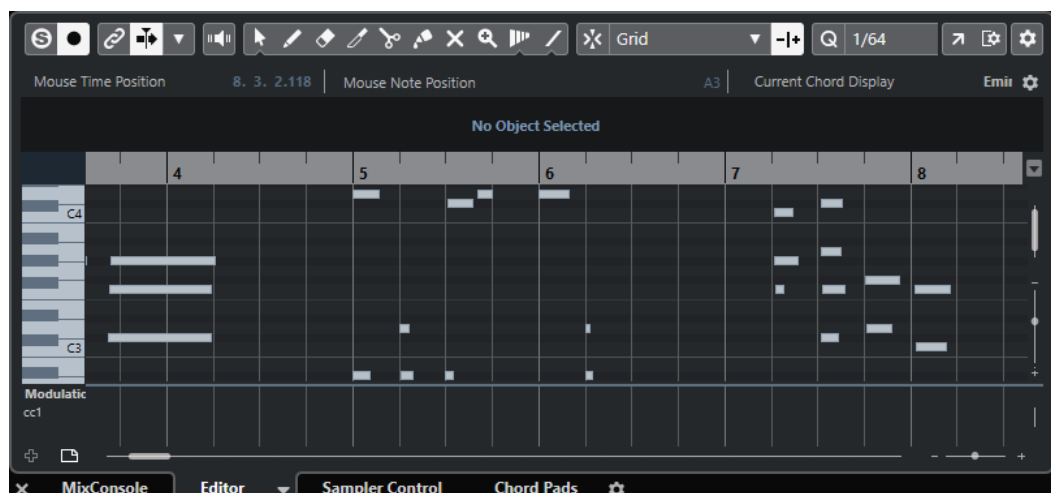

To close the lower zone, click **Close Lower Zone**  to the left of the tabs.

RELATED LINKS

- [Opening Chord Pads](#) on page 53
- [Opening the MixConsole in the Lower Zone](#) on page 54
- [Opening Sampler Control](#) on page 55
- [Opening the Editor in the Lower Zone](#) on page 55
- [Project Window Toolbar](#) on page 32

## Setting up the Lower Zone

In the lower zone, the **MixConsole**, **Editor**, **Sampler Control**, and **Chord Pads** tabs are shown. You can change their order, and you can hide tabs that you do not need.

---

PROCEDURE

1. Click **Set up Lower Zone** in the bottom right of the lower zone.

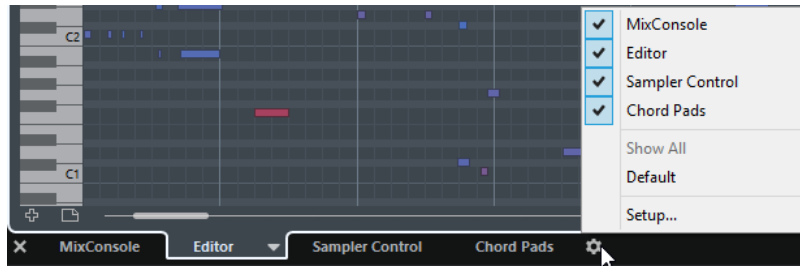

2. Do one of the following:
  - Activate/Deactivate the options in the pop-up menu to show/hide tabs in the lower zone.
  - Select **Setup** to open a dialog where you can activate/deactivate the tabs and change their position.

**NOTE**

In the **Presets** section of this dialog you can also save a preset of your configuration.

---

RESULT

The tabs in the lower zone are shown according to your configuration.

RELATED LINKS

- [Setup Dialog](#) on page 877

## Opening Chord Pads

**Chord Pads** allow you to play with chords, and to change their voicings and tensions.

---

PROCEDURE

1. Click **Show/Hide Lower Zone** on the **Project** window toolbar to activate the lower zone.
2. At the bottom of the lower zone, click the **Chord Pads** tab.

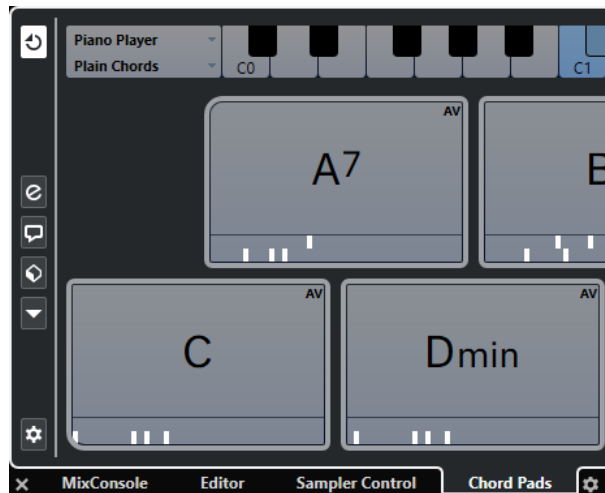

---

RESULT

The **Chord Pads** are opened.

RELATED LINKS

[Chord Pads](#) on page 747

[Setting up the Lower Zone](#) on page 53

[Project Window Toolbar](#) on page 32

## Opening the MixConsole in the Lower Zone

The **MixConsole** in the lower zone allows you to perform all basic mixing procedures from within the lower zone of the **Project** window, and at the same time to see the context of your tracks and events.

---

PROCEDURE

1. Click **Show/Hide Lower Zone** on the **Project** window toolbar to activate the lower zone.
2. At the bottom of the lower zone, click the **MixConsole** tab.



---

RESULT

The **MixConsole** is opened in the lower zone.

RELATED LINKS

[MixConsole in Lower Zone](#) on page 307

[Project Window Toolbar](#) on page 32

## Opening Sampler Control

**Sampler Control** allows you to display and edit the waveform of an audio sample on a sampler track.

---

PROCEDURE

1. Click **Show/Hide Lower Zone** on the **Project** window toolbar to activate the lower zone.
2. At the bottom of the lower zone, click the **Sampler Control** tab.



---

RESULT

**Sampler Control** is opened.

RELATED LINKS

[Sampler Tracks](#) on page 462

[Project Window Toolbar](#) on page 32

## Opening the Editor in the Lower Zone

The **Editor** in the lower zone allows you to perform event editing procedures from within the lower zone of the **Project** window, and at the same time to see the context of your tracks and events.

NOTE

By default, double-clicking an audio event/part or a MIDI part in the event display or selecting it and pressing **Return** opens the corresponding editor in the lower zone of the **Project** window. Using a menu command opens a separate editor window. You can change this in the **Preferences** dialog (**Editors** page).

---

PROCEDURE

1. Click **Show/Hide Lower Zone** on the **Project** window toolbar to activate the lower zone.
2. At the bottom of the lower zone, click the **Editor** tab.
3. In the event display, do one of the following:
  - Select a MIDI part.

- Select an audio event.
- Select an audio part.

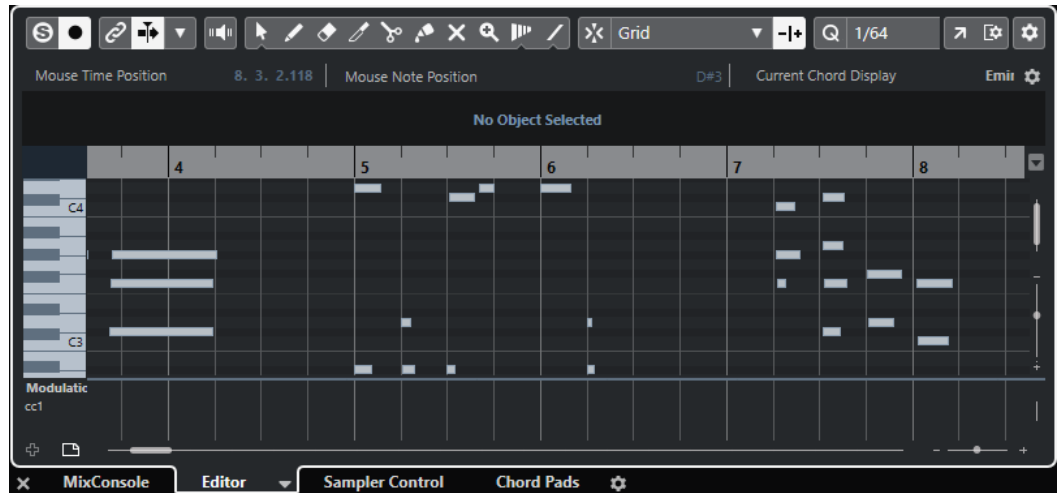

---

#### RESULT

Depending on your event or part selection, the lower zone shows either the **Audio Part Editor**, the **Sample Editor**, or one of the MIDI editors.

#### NOTE

To change the default MIDI editor, select **MIDI > Set up Editor Preferences**, and select an option from the **Default MIDI Editor** pop-up menu.

---

#### NOTE

If you open the editor and no event or part is selected, the editor in the lower zone is empty.

---

#### RELATED LINKS

[Selecting a different MIDI Editor](#) on page 56

[Project Window Toolbar](#) on page 32

## Selecting a different MIDI Editor

You can display the MIDI part that is opened in the editor in the lower zone in a different MIDI editor. You can do this without changing the default MIDI editor.

---

#### PROCEDURE

1. On the **Editor** tab in the editor in the lower zone, click **Select MIDI Editor**.
2. Select an editor from the pop-up menu.



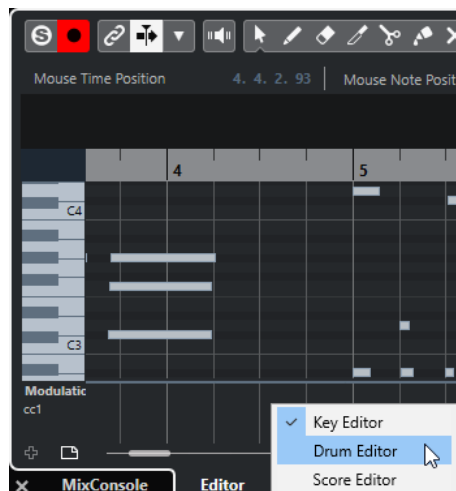

---

#### RESULT

The MIDI part is displayed in the selected editor.

#### NOTE

This selection is temporary. Next time you open the MIDI part, the default MIDI editor is used.

---

## Link Project and Lower Zone Editor Cursors

You can link cursors and zoom factors of the project zone and the **Key Editor**, **Drum Editor**, and the **Audio Part Editor** in the lower zone.

#### NOTE

**Link Project and Lower Zone Editor Cursors** is not available in the **Sample Editor**.

---

#### NOTE

The ruler display format setting is not affected by this function. You can still select different ruler display formats for the project zone and the editor in the lower zone.

---



If you activate **Link Project and Lower Zone Editor Cursors** , the cursors and zoom factors are linked in the event displays of the project zone and the lower zone. This is useful if you edit in both zones and you want to keep the same position in view.

#### NOTE

In the **Key Commands** dialog in the **Edit** category, you can assign a key command for this.

---

#### RELATED LINKS

[Ruler](#) on page 42

[Ruler Display Format Menu](#) on page 42

[Zooming in the Project Window](#) on page 64

## Right Zone

The right zone of the **Project** window allows you to display the **VSTi** rack and the **Media** rack.

To show/hide the right zone, click **Show/Hide Right Zone** on the **Project** window toolbar.

The top of the right zone features the following tabs: **VSTi** and **Media**.

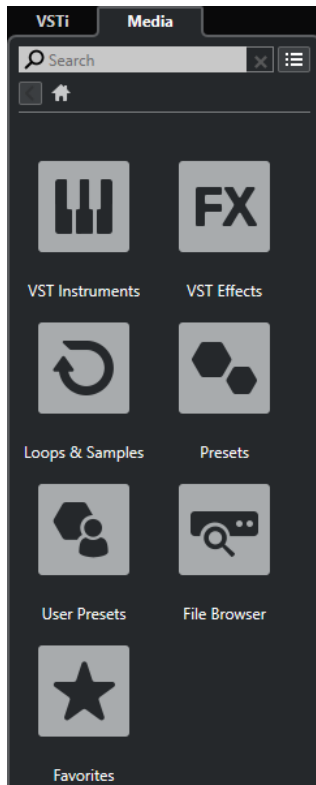

#### NOTE

You can show/hide specific tabs in the right zone by right-clicking a tab and activating/deactivating the options in the context menu.

---

#### RELATED LINKS

[VSTi Rack in the Right Zone](#) on page 60

[Media Rack in the Right Zone](#) on page 62

[Project Window Toolbar](#) on page 32

## Opening the VSTi Rack in the Right Zone

You can show the **VSTi** rack in the right zone of the **Project** window. This allows you to add and edit VST instruments, and at the same time to see the context of your tracks and events.

---

#### PROCEDURE

1. Click **Show/Hide Right Zone** on the **Project** window toolbar to activate the **Right Zone**.
2. At the top of the right zone, click the **VSTi** tab.



- 3.
-

## RESULT

The **VSTi** rack is opened in the right zone of the **Project** window.

## RELATED LINKS

[VSTi Rack in the Right Zone](#) on page 60

[VST Instruments](#) on page 547

[Project Window Toolbar](#) on page 32

## VSTi Rack in the Right Zone

The **VSTi** rack in the right zone of the **Project** window allows you to add and edit VST instruments in the context of the **Project** window.

The following sections are available:

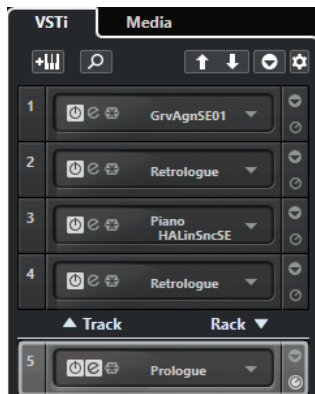

- **Track**  
Shows the associated VST instrument for an instrument track.
- **Rack**  
Shows a VST instrument.

The following controls are available:

### Add Track Instrument



Opens the **Add Track** dialog that allows you to select an instrument and add an instrument track that is associated to this instrument.

### Find Instruments



Opens a selector that allows you to find a loaded instrument.

### Set Remote-Control Focus for VST Quick Controls to Previous Instrument



Allows you to set the remote-control focus to the previous instrument.

### Set Remote-Control Focus for VST Quick Controls to Next Instrument



Allows you to set the remote-control focus to the next instrument.

### Show/Hide all VST Quick Controls



Shows/Hides the default quick controls for all loaded instruments.

### Settings



Opens the **Settings** menu where you can activate/deactivate the following modes:

- **Show VST Quick Controls for One Slot Only** shows the **VST Quick Controls** exclusively for the selected instrument.
- **MIDI Channel follows track selection** ensures that the **Channel** selector follows the MIDI track selection in the **Project** window. Use this mode if you work with multitimbral instruments.
- **Remote-Control Focus for VST Quick Controls follows track selection** ensures that the **VST Quick Controls** remote-control focus follows the track selection.

RELATED LINKS

[VST Instruments Window](#) on page 551

## Opening the Media Rack in the Right Zone

You can show the **Media** rack in the right zone of the **Project** window. This allows you to see the context of your tracks and events when you drag audio events, MIDI parts, presets, or instruments into the **Project** window.

---

PROCEDURE

1. Click **Show/Hide Right Zone** on the **Project** window toolbar to activate the **Right Zone**.
2. At the top of the right zone, click the **Media** tab.

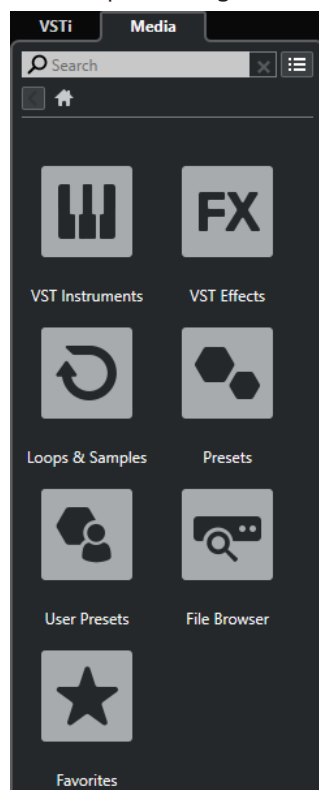

---

RESULT

The **Media** rack is opened in the right zone of the **Project** window.

RELATED LINKS

[Media Rack in the Right Zone](#) on page 62

[MediaBay and Media Rack](#) on page 494

[Project Window Toolbar](#) on page 32

## Media Rack in the Right Zone

The **Media** rack in the right zone of the **Project** window allows you to drag audio events, MIDI parts, or instrument presets into the event display. It lists Steinberg factory content and any installed Steinberg content sets.

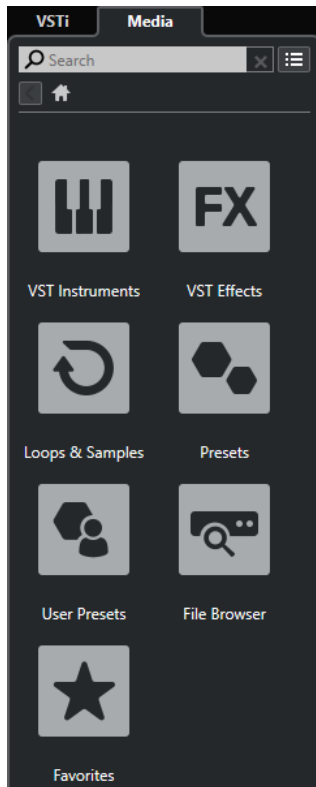

The **Media** rack **Home** tab shows the following tiles:

### VST Instruments

Shows all included VST instruments.

### VST Effects

Shows all included VST effects.

### Loops & Samples

Shows audio loops, MIDI loops, or instrument sounds ordered by content set.

### Presets

Shows track presets, strip presets, pattern banks, FX chain presets, and VST FX presets.

### User Presets

Shows track presets, strip presets, pattern banks, FX chain presets, VST FX presets, and instrument presets that are listed in the **User** folder.

### Favorites

Shows your favorite folders and allows you to add new favorites. The folder content is automatically added to the **MediaBay** database.

### File Browser

Shows your file system and the pre-defined folders **Favorites**, **This Computer**, **VST Sound**, **Factory Content**, and **User Content** where you can search for media files and access them immediately.

#### RELATED LINKS

[Media Rack in Right Zone](#) on page 494

[MediaBay and Media Rack](#) on page 494

## Keyboard Focus in the Project Window

The different zones in the **Project** window can be controlled by using key commands. To make sure that a key command has effect on a specific zone, you must make sure that this zone has the keyboard focus.

The following **Project** window zones can have the keyboard focus:

- Project zone
- Left zone
- Lower zone
- Right zone

If a zone has the keyboard focus, the border that surrounds it is highlighted in a specific color.

#### NOTE

You can change the focus color in the **Preferences** dialog (**User Interface—Custom Colors** page).

---

#### RELATED LINKS

[Project Zone](#) on page 31

[Left Zone](#) on page 45

[Lower Zone](#) on page 52

[Right Zone](#) on page 58

[Project Window](#) on page 30

## Activating Keyboard Focus for a Zone

You can activate the keyboard focus for a zone by clicking with the mouse and by using key commands.

#### PROCEDURE

- Do one of the following:
  - To activate any zone, click in it.
  - To activate the next zone, press **Tab**. This allows you to cycle forward through the zones.
  - To activate the previous zone, press **Shift-Tab**.

#### NOTE

The editor in the lower zone automatically gets the keyboard focus if you double-click an event or part in the event display, if you select an event or part and press **Return**, or if you use key commands to open the zone.

---

#### RESULT

The keyboard focus is activated for this zone and the border of the zone is highlighted.

#### NOTE

The project zone and the lower zone have separate toolbars and info lines. If you use the toolbar or the info line for one of these zones, the corresponding zone automatically gets the focus.

---

## Zooming in the Project Window

You can zoom in the **Project** window according to the standard zoom techniques.

#### NOTE

If screen redraws are slow on your system, consider activating **Quick Zoom** in the **Preferences** dialog (**Editing** page).

---

### Zooming Horizontally

- Select the **Zoom** tool and click in the event display to zoom in. To zoom out, hold down **Alt** and click.
- Use the horizontal zoom sliders to zoom in and out.
- Click the lower half of the ruler and drag down to zoom in horizontally. Click the lower half of the ruler and drag up to zoom out horizontally.
- Click **H** to zoom in horizontally. Click **G** to zoom out horizontally.

#### NOTE

If the **Grid Type** in the **Project** window toolbar is set to **Adapt to Zoom**, the horizontal zoom level affects the grid and snap resolution in the event display.

---

### Zooming Vertically

- Select the **Zoom** tool, click in the event display, and drag a selection rectangle to zoom in vertically and horizontally.

#### NOTE

For this to work, you must deactivate the **Zoom Tool Standard Mode: Horizontal Zooming Only** option in the **Preferences** dialog (**Editing—Tools** page).

---

- Use the vertical zoom sliders to zoom in and out. If you have made any individual track height adjustments, the relative height differences are maintained.
- Click **Shift-H** to zoom in vertically. Click **Shift-G** to zoom out vertically.

#### RELATED LINKS

[Zoom Submenu](#) on page 65

[Zoom Presets](#) on page 66

[Zooming in on Cycle Markers](#) on page 66

[Zoom History](#) on page 67

[Link Project and Lower Zone Editor Cursors](#) on page 57

[Grid Type Menu](#) on page 69



## Zooming in on Audio Contents

You can zoom in vertically on the contents of audio parts and events. This is useful when viewing quiet audio passages.

---

### PROCEDURE

- Click the waveform zoom slider in the top right corner of the event display and drag up.

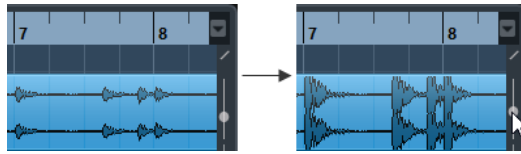

---

### RESULT

The contents of audio parts and events in your project are zoomed in vertically.

### AFTER COMPLETING THIS TASK

To get an approximate reading on the level of the audio events by viewing the waveforms, zoom out by dragging the slider all the way down again. Otherwise, zoomed waveforms may be mistaken for clipped audio.

## Zoom Submenu

The **Zoom** submenu contains options for zooming in the **Project** window.

- To open the **Zoom** submenu, select **Edit > Zoom**.

The following options are available:

### **Zoom In/Zoom Out**

Zooms in/out one step, centering on the project cursor.

### **Zoom Full**

Zooms out so that the whole project is visible. The whole project means the timeline from the project start to the length set in the **Project Setup** dialog.

### **Zoom to Selection**

Zooms in horizontally and vertically so that the current selection fills the screen.

### **Zoom to Selection (Horiz.)**

Zooms in horizontally so that the current selection fills the screen.

### **Zoom to Event**

Zooms in to show the currently selected event. This option is available in the **Sample Editor** and in some MIDI editors.

### **Zoom In Vertically/Zoom Out Vertically**

Zooms in/out one step vertically.

### **Zoom In Tracks/Zoom Out Tracks**

Zooms the selected tracks in/out one step vertically.

### **Zoom Selected Tracks**

Zooms in vertically on the selected tracks and minimizes the height of all other tracks.

### **Undo Zoom/Redo Zoom**

These options allow you to undo/redo the last zoom operation.

RELATED LINKS

[Zoom Submenu](#) on page 424

## Zoom Presets

You can create zoom presets that allow you to set up different zoom settings. For example, one where the whole project is displayed in the **Project** window and another with a high zoom factor for detailed editing. The **Zoom Presets** pop-up menu allows you to select, create, and organize zoom presets.

- To open the **Zoom Presets** pop-up menu, click the button to the left of the horizontal zoom control.

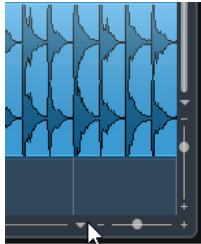

The upper part of the menu lists the zoom presets.

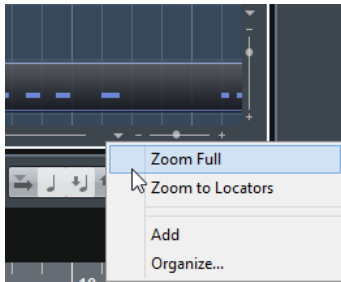

- To save the current zoom setting as a preset, open the **Zoom Presets** pop-up menu and select **Add**. In the **Type In Preset Name** dialog that opens, type in a name for the preset and click **OK**.
- To select and apply a preset, select it from the **Zoom Presets** pop-up menu.
- To zoom out so that the whole project is visible, open the **Zoom Presets** pop-up menu and select **Zoom Full**.

This displays the project from the **Project Start Time** to the **Project Length** that is set in the **Project Setup** dialog.

- To delete a preset, open the **Zoom Presets** pop-up menu and select **Organize**. In the dialog that opens, select the preset in the list and click **Delete**.
- To rename a preset, open the **Zoom Presets** pop-up menu and select **Organize**. In the dialog that opens, select a preset in the list and click **Rename**. In the dialog that opens, type in a new name for the preset. Click **OK** to close the dialogs.

### IMPORTANT

Zoom presets are global for all projects. They are available in all projects that you open or create.

---

## Zooming in on Cycle Markers

You can zoom in on the area between cycle markers in the project.

### PREREQUISITE

You have created at least one cycle marker for the project.

#### PROCEDURE

- Click the button to the left of the horizontal zoom control to open the **Zoom Presets** pop-up menu, and select a cycle marker.

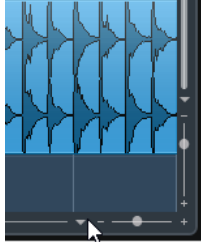

The middle part of the pop-up menu lists any cycle markers that you have added to the project.

---

#### RESULT

The event display is zoomed in to encompass the marker area.

#### RELATED LINKS

[Markers Window](#) on page 301

## Zoom History

You can undo and redo zoom operations. This way, you can zoom in several steps and then easily go back to the zoom stage at which you started.

You can undo and redo zoom operations in the following ways:

- To undo zoom, select **Edit > Zoom > Undo Zoom** or double-click with the zoom tool.
- To redo zoom, select **Edit > Zoom > Redo Zoom** or press **Alt** and double-click with the zoom tool.

## Snap Function

The **Snap** function helps you to find exact positions when editing in the **Project** window. It does this by restricting horizontal movement and positioning to certain positions. Operations affected by **Snap** include moving, copying, drawing, sizing, splitting, range selection, etc.

- To activate/deactivate **Snap**, activate/deactivate **Snap**  on the toolbar.

## Setting the Snap Point

You can set the snap point at any position of the audio event.

---

#### PROCEDURE

1. Select an event.
  2. Place the project cursor at a position within the selected audio event.
  3. Select **Audio > Snap Point to Cursor**.
- 

#### RESULT

The snap point is set at the cursor position. The snap point for an event is displayed as a vertical line in the **Project** window.

#### NOTE

You can also set the snap point in the **Sample Editor**.

---

#### RELATED LINKS

[Adjusting the Snap Point](#) on page 432

## Snap to Zero Crossing

When splitting and sizing audio events, sudden amplitude changes can cause pops and clicks. To avoid this, you can activate **Snap to Zero Crossing** to snap to points where the amplitude is zero.

- To activate **Snap to Zero Crossing**, activate **Snap to Zero Crossing**  on the toolbar.

## Snap Types Menu

You can select between different snap types to determine the snap point.

- To open the **Snap Type** pop-up menu, click **Snap Type**  on the toolbar.

The following snap types are available:

### Grid

If this option is activated, the snap points are set with the **Grid Type** pop-up menu. The options depend on the display format that is selected for the ruler.

If you select **Seconds** as ruler format, time-based grid options are available.

If you select **Bars+Beats** as ruler format, musical grid options are available.

### Grid Relative

If this option is activated, events and parts are not magnetic to the grid. Rather, the grid determines the step size for moving the events. This means that a moved event keeps its original position relative to the grid.

For example, if an event starts at the position 3.04.01, **Snap** is set to **Grid Relative**, and **Grid Type** is set to **Bar**, you can move the event in steps of one bar to the positions 4.04.01, 5.04.01, and so on.

#### NOTE

This only applies when dragging existing events or parts. When you create new events or parts, this **Snap Type** works like **Grid**.

---

### Events

If this option is activated, the start and end positions of other events and parts become magnetic. This means that if you drag an event to a position near the start or end of another event, it is automatically aligned with the start or end of the other event.

For audio events, the position of the snap point is also magnetic. This includes marker events on the marker track.

### Shuffle

Shuffle is useful when you want to change the order of adjacent events. If you have two adjacent events and drag the first one to the right, past the second event, the two events change places.



The same principle works when changing the order of more than two events.

### Cursor

This grid type lets the project cursor become magnetic. Dragging an event near the cursor causes the event to be aligned with the cursor position.

### Grid + Cursor

This is a combination of **Grid** and **Cursor**.

### Events + Cursor

This is a combination of **Events** and **Cursor**.

### Events + Grid + Cursor

This is a combination of **Events**, **Grid**, and **Cursor**.

## Grid Type Menu

Allows you to specify a grid type that determines the grid and snap resolution in the event display.

### NOTE

This setting only has an effect if **Snap Type** is set to one of the grid options.

---

- To open the **Grid Type** pop-up menu, click **Grid Type**  **Bar** on the toolbar.

If you select **Bars+Beats** as ruler format, the following grid types are available:

### Bar

Sets the grid and snap resolution to bars.

### Beat

Sets the grid and snap resolution to beats.

### Use Quantize

Sets the grid and snap resolution to the value that is activated in the **Quantize Presets** pop-up menu.

### Adapt to Zoom

Sets the grid and snap resolution to the horizontal zoom level. The more you zoom in on the event display, the finer the resolution. High zoom levels allow you to snap to 64th notes, low zoom levels allow you to snap to bars.

### NOTE

**Adapt to Zoom** is only available if **Bars+Beats** is set as ruler display format.

---

### NOTE

You can assign key commands to the grid types in the **Key Commands** dialog in the **Edit** category.

---

If you activate **Time Linear** in the ruler context menu, the distances between the grid lines are still constant but based on musical values such as bars and beats.

If you select **Seconds** as ruler format, the following grid types are available:

**1 ms**

Sets the grid and snap resolution to 1 ms.

**10 ms**

Sets the grid and snap resolution to 10 ms.

**100 ms**

Sets the grid and snap resolution to 100 ms.

**1000 ms**

Sets the grid and snap resolution to 1000 ms.

RELATED LINKS

[Snap Types Menu](#) on page 68

[Zooming in the Project Window](#) on page 64

[Ruler Display Format Menu](#) on page 42

## Cross-Hair Cursor

The cross-hair cursor is displayed when working in the **Project** window and in the editors, facilitating navigation and editing, especially when arranging large projects.

- You can set up the cross-hair cursor in the **Preferences** dialog (**Editing—Tools** page). You can set up the colors for the line and the mask of the cross-hair cursor, and define its width.

The cross-hair cursor works as follows:

- When the **Object Selection** tool or one of its subtools is selected, the cross-hair cursor appears when you start moving/copying a part/event, or when using the event trim handles.

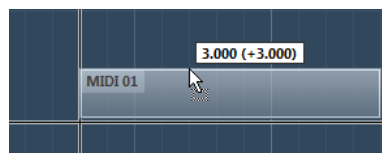

Cross-hair cursor when moving an event.

- When the **Object Selection** tool, the **Split** tool, or any other tool that makes use of this function is selected, the cross-hair cursor appears as soon as you move the mouse over the event display.
- The cross-hair cursor is only available for tools where such a function is of any use. The **Mute** tool, for example, does not use a cross-hair cursor, as you have to click directly on an event to mute it.

### NOTE

If the **Key Editor**, **Drum Editor** or the **Audio Part Editor** is open in the lower zone of the **Project** window and **Link Project and Lower Zone Cursors** is activated, the cross-hair cursor is shown in the editor in the lower zone and in the **Project** window.

---

## Edit History Dialog

The **Edit History** dialog contains a list of all your edits. This allows you to undo all actions in the **Project** window as well as in the editors.

- To open the **Edit History** dialog, select **Edit > History**.

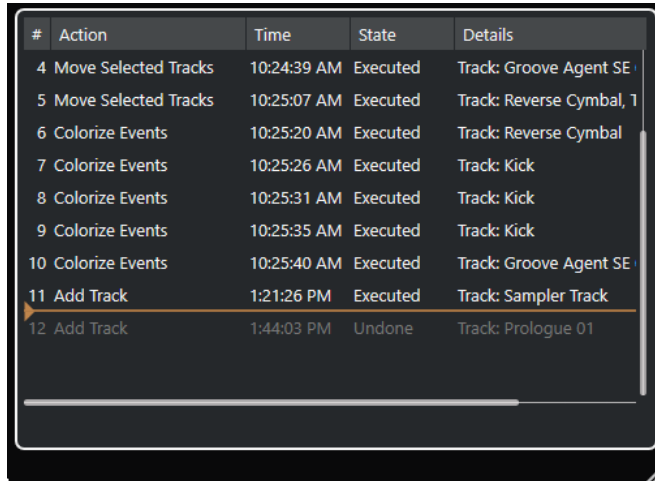

#	Action	Time	State	Details
4	Move Selected Tracks	10:24:39 AM	Executed	Track: Groove Agent SE
5	Move Selected Tracks	10:25:07 AM	Executed	Track: Reverse Cymbal, 1
6	Colorize Events	10:25:20 AM	Executed	Track: Reverse Cymbal
7	Colorize Events	10:25:26 AM	Executed	Track: Kick
8	Colorize Events	10:25:31 AM	Executed	Track: Kick
9	Colorize Events	10:25:35 AM	Executed	Track: Kick
10	Colorize Events	10:25:40 AM	Executed	Track: Groove Agent SE
11	Add Track	1:21:26 PM	Executed	Track: Sampler Track
12	Add Track	1:44:03 PM	Undone	Track: Prologue 01

### Action

Shows the name of the action.

### Time

Shows the time when this action was performed.

### State

Shows the state of the action.

### Details

Shows further details, and allows you to enter new text.

### Separator

Move the separator upwards to undo your actions. To redo an action again, move the separator down.

### NOTE

- You can also undo applied audio processes. However, we recommend to modify or delete these using the **Direct Offline Processing** window.
- All offline processing that you have applied permanently to the audio using the **Make Direct Offline Processing Permanent** function cannot be undone. Therefore, it is not shown in the **Edit History** dialog.

---

### RELATED LINKS

[Direct Offline Processing](#) on page 386

[Applying Offline Processing Permanently](#) on page 392

## Setting the Number of Maximum Undo Steps

You can limit the number of maximum undo steps. This is useful if you run out of memory, for example.

---

### PROCEDURE

1. In the **Preferences** dialog, select **General**.

2. Set the number in the **Maximum Undo Steps** field.
- 

## Color Handling

You can colorize events and tracks in Cubase. This allows for an easier overview in the **Project** window.

### RELATED LINKS

[Color Picker](#) on page 78

[Project Colors Setup Dialog](#) on page 75

[Setting Event Colors to Track Colors](#) on page 75

[Colorizing Events on the Fly](#) on page 74

[Colorizing Selected Events or Parts](#) on page 73

[Resetting the Track Color](#) on page 73

[Colorizing Single Tracks](#) on page 73

[Colorizing Selected Tracks](#) on page 72

[Color Handling](#) on page 72

[User Interface - Track & MixConsole Channel Colors](#) on page 906

[Automatically Assigning Colors to New Tracks/Channels](#) on page 144

## Colorizing Selected Tracks

You can colorize selected tracks.

---

### PROCEDURE

1. In the **Project** window, deselect all events or parts.
2. Select the tracks that you want to colorize.
3. On the **Project** window toolbar, select **Select Color for Selected Tracks or Events**.  
The **Colorize** pane opens.

### NOTE

If you want to select colors by names instead, activate the **Select Colors by Name** option in the **Project Colors Setup** dialog (**Options** page).

- 
4. Select a color.
- 

### RESULT

The selected tracks are colorized, and the events and parts get the track color.

### NOTE

If you assign a different color to individual events or parts with the **Color** tool, events or parts no longer follow color changes of the track.

---

### RELATED LINKS

[Colorizing Events on the Fly](#) on page 74

[Options Tab](#) on page 77



## Colorizing Single Tracks

You can colorize single tracks via the **Inspector** or the track list. This is useful if you want to ensure that no other tracks, events, or parts are colorized accidentally.

---

### PROCEDURE

1. Do one of the following:
  - Select the track that you want to colorize, and in the **Inspector**, click **Colorize Selected Track**.



- **Ctrl/Cmd**-click the left area of the track list.

The **Colorize** pane opens.

### NOTE

If you want to select colors by names instead, activate the **Select Colors by Name** option in the **Project Colors Setup** dialog (**Options** page).

---

2. Select a color.
- 

### RESULT

The track is colorized, and any events or parts on that track get the same color.

### NOTE

If you assign a different color to individual events or parts with the **Color** tool, they no longer follow color changes of the track.

---

### RELATED LINKS

[Colorizing Events on the Fly](#) on page 74

[Options Tab](#) on page 77

## Resetting the Track Color

You can reset the color of a track to the default color.

---

### PROCEDURE

1. In the **Project** window, select the track that you want to reset to the default color, and deselect all events or parts.
  2. On the **Project** window toolbar, select **Select Color for Selected Tracks or Events**.
  3. In the **Colorize** pane, click **Set Track Color to Default**.
- 

### RESULT

The default color is assigned to the selected track.

## Colorizing Selected Events or Parts

You can colorize selected events or parts with **Select Color for Selected Tracks or Events**. By default, events or parts follow the color of the corresponding track. However, you can overwrite

this setting and, for example, select the same color for events or parts that reside on different tracks.

---

PROCEDURE

1. In the **Project** window, select all events or parts that you want to colorize.
2. On the **Project** window toolbar, select **Select Color for Selected Tracks or Events**. The **Colorize** pane opens.

NOTE

If you want to select colors by names, activate the **Select Colors by Name** option in the **Project Colors Setup** dialog (**Options** page).

3. Select a color.
- 

RESULT

The selected events are colorized and no longer follow the color changes of the track.

RELATED LINKS

[Colorizing Events on the Fly](#) on page 74

[Options Tab](#) on page 77

## Colorizing Events on the Fly

You can colorize events or parts with the **Color** tool. By default, events or parts follow the color of the corresponding track. However, you can overwrite this setting and, for example, select the same color for events or parts that reside on different tracks.

---

PROCEDURE

1. In the **Project** window toolbar, select the **Color** tool.
  2. Do one of the following to select a tool color:
    - **Alt**-click an event or part to copy its color.
    - Move the mouse pointer over the **Color** tool, and use the mouse wheel to step through the colors of the current color set.
  3. Optional: Select the events or parts that you want to colorize with the **Object Selection** tool.  
This is only necessary if you want to colorize multiple events or parts.
  4. On the **Project** window toolbar, select the **Color** tool.
  5. Click the events or parts that you want to colorize.
- 

RESULT

The events or parts are colorized and no longer follow color changes of the track.

NOTE

You can also **Ctrl/Cmd**-click an event or part with the **Color** tool to open the **Colorize** pane or to select colors by names.

---

RELATED LINKS

[Colorizing Selected Events or Parts](#) on page 73

[Options Tab](#) on page 77

## Setting Event Colors to Track Colors

You can set the color of events or parts to the track color. This is useful if you colorized events or parts with the **Color** tool and you want them to follow the track color again.

---

### PROCEDURE

1. In the **Project** window, select the event or part that you want to set to the track color.
  2. On the **Project** window toolbar, click **Select Color for Selected Tracks or Events**.
  3. In the **Colorize** pane, click **Set Event Color to Track**.
- 

### RESULT

The track color is assigned to the selected event or part.

### RELATED LINKS

[Colorizing Events on the Fly](#) on page 74

## Project Colors Setup Dialog

The **Project Colors Setup** dialog allows you to set up colors for your project.

- To open the **Project Colors Setup** dialog, select **Project > Project Colors Setup**.



### RELATED LINKS

[Color Picker](#) on page 78

[Color Set Tab](#) on page 76

[Presets Tab](#) on page 77

[Options Tab](#) on page 77

## Color Set Tab

The **Color Set** tab allows you to change the color set that is used in the project.

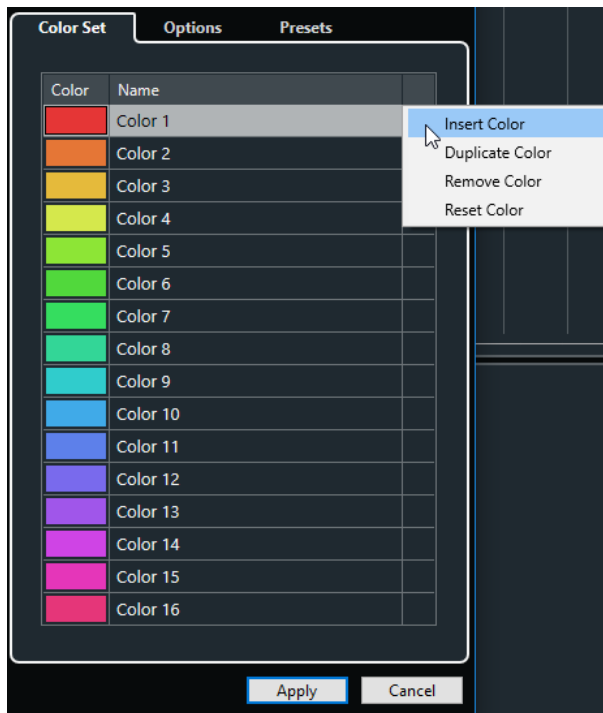

The following options are available:

### Color fields

Click a field to open the **Color Picker** that allows you to specify a new color.

### Name

Shows the name of the color. Double-click to change it.

### Set up

Allows you to add or remove color fields.

- **Insert Color**  
Adds a new color field.
- **Duplicate Color**  
Duplicates the selected color field.
- **Remove Color**  
Removes the selected color field.
- **Reset Color**  
Resets the selected color field to the factory settings.

### Apply

Applies your changes and closes the dialog.

### RELATED LINKS

[Color Picker](#) on page 78

## Presets Tab

The **Presets** tab allows you to expand the color set to 24 or even 32 colors or reduce it to 8 colors. You can add tints, and you can sort colors according to their color tint or their basic color.

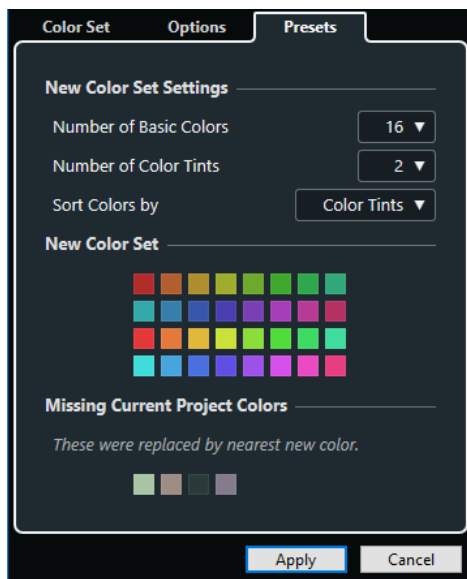

In the **New Color Set Settings** section, the following options are available:

### Number of Basic Colors

You can set up 8, 16, 24, or 32 basic colors.

### Number of Color Tints

You can set up 1, 2, or 4 color tints.

### Sort Colors by

Allows you to sort the colors of the color set by their basic color or by their color tint.

The **New Color Set** section displays the current colors of the new color set.

The **Missing Current Project Colors** section shows which missing colors will be replaced. Move the mouse pointer over the color field of a color that is missing to highlight the color that is used to replace it in the **New Color Set** section.

### Apply

Applies your changes and closes the dialog.

## Options Tab

The **Options** tab allows you to access the color set options.

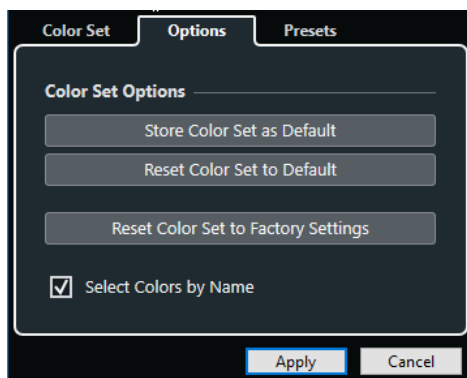

In the **Color Set Options** section, the following options are available:

**Store Color Set as Default**

Saves the current set of colors as default.

**Reset Color Set to Default**

Applies the default set of colors.

**Reset Color Set to Factory Settings**

Returns to the standard color palette.

**Select Colors by Name**

Allows you to select the colors by name.

**Apply**

Applies your changes and closes the dialog.

## Color Picker

The **Color Picker** allows you to define new custom colors.

To open the **Color Picker**, do one of the following:

- Select **Project > Project Colors Setup**, and in the **Project Colors Setup** dialog on the **Color Set** tab, click a color field.  
This allows you to define custom project colors.
- Select **Edit > Preferences**, select one of the **User Interface** entries, and click a color field.  
This allows you to define custom user interface colors.

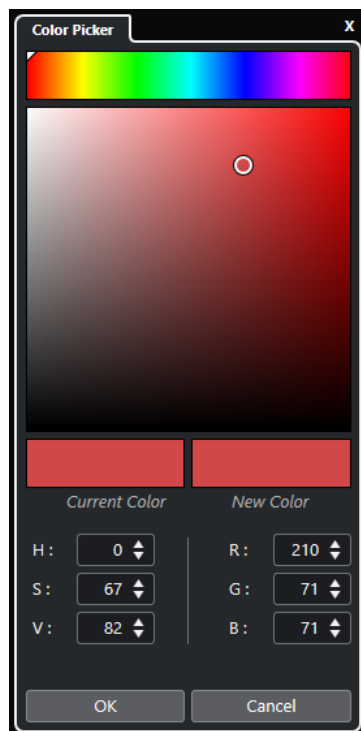

**Color selectors**

Allow you to select a color shade and the nuance of the shade.

**Context menu**

Allows you to copy, paste, or reset colors.

**Current Color/New Color**

Shows the current color and the new color.

**Hue/Saturation/Value**

Allow you to edit the colors numerically.

**Red/Green/Blue**

Allow you to edit the colors numerically.

**OK**

Confirms the color changes.

**NOTE**

You must restart the application for some changes to take effect.

---

# Project Handling

In Cubase, projects are the central documents. You must create and set up a project to work with the program.

## Creating New Projects

You can create empty projects or projects that are based on a template.

---

### PROCEDURE

1. Select **File > New Project**.  
Depending on your settings, either the **Hub** or the **Project Assistant** dialog opens.
2. In the location options section, select where to store the new project.
  - To use the default location, select **Use default location**.
  - To choose another location, select **Prompt for project location**.
3. Do one of the following:
  - To create an empty new project, click **Create Empty**.
  - To create a new project from a template, select a template and click **Create**.

---

### RESULT

A new, untitled project is created. If you selected a template, the new project is based on this template and includes the corresponding tracks, events, and settings.

### NOTE

If you create an empty project, your default presets for the input and output bus configurations are applied. If you have not defined default presets, the last used configurations are applied.

---

### RELATED LINKS

[Presets for Input and Output Busses](#) on page 27

## Hub

**Hub** keeps you up to date with the latest information and assists you with organizing your projects.

To open the **Hub**, do one of the following:

- Select **Hub > Open Hub**.
- Select **File > New Project**.



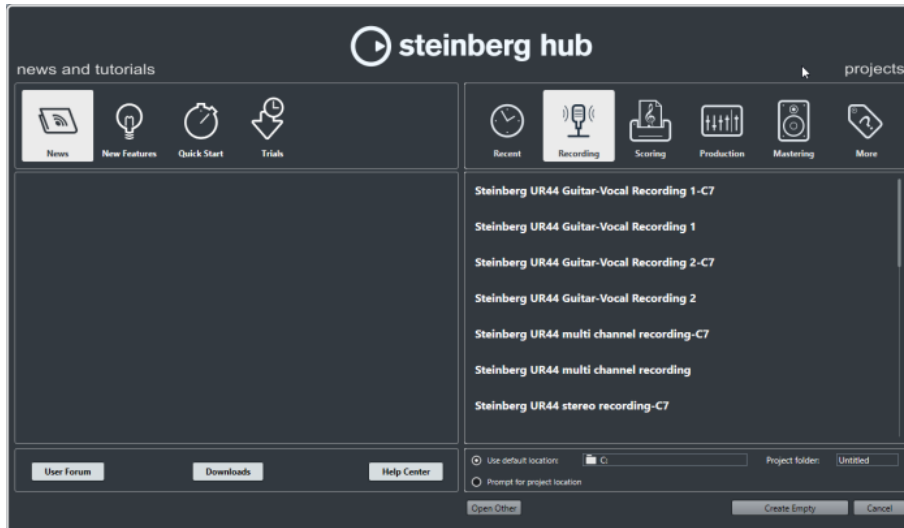

## News and Tutorials Section

The **News and Tutorials** section displays Steinberg news, tutorial videos as well as links to the user forum, downloads, and the Help Center.

### NOTE

Ensure that you have an active Internet connection to access this material.

## Projects Section

The **Projects** section lets you create new projects, which can either be empty or based on a template. It lets you specify where to save the projects. It also allows you to access recently opened projects or projects that are stored in other locations. This section offers the same functionality as the **Project Assistant** dialog.

### Category bar

In this section, the available factory templates are sorted into the predefined categories **Recording**, **Scoring**, **Production**, and **Mastering**.

The **Recent** category contains a list of the recently opened projects.

The **More** category contains the default project template and all templates that are not assigned to any of the other categories.

### Template list

When you click on one of the category items, the list below the category bar shows the available templates for this category. Any new templates that you create are added at the top of the corresponding list.

### Location options

This section allows you to specify where the project is stored.

### Open Other

This button allows you to open any project file on your system. This is identical to using the **Open** command on the **File** menu.

### RELATED LINKS

[Project Assistant Dialog](#) on page 82

## Deactivating the Hub

To start Cubase or to create new projects without the **Hub**, you can deactivate it.

### PROCEDURE

1. In the **Preferences** dialog, select **General**.
2. Deactivate **Use Hub**.

### RESULT

Cubase starts without opening a project and opens the **Project Assistant** dialog when you create a new project using the **File** menu. However, you can still open the **Hub** through the **Hub** menu.

## Project Assistant Dialog

The **Project Assistant** dialog assists you with organizing your projects.

- To open the **Project Assistant** dialog, deactivate **Use Hub** in the **Preferences** dialog (**General** page), and select **File > New Project**.



### Category bar

In this section, the available factory templates are sorted into the predefined categories **Recording**, **Production**, **Scoring**, and **Mastering**.

The **Recent** category contains a list of the recently opened projects.

The **More** category contains the default project template and all templates that are not assigned to any of the other categories.

### Template list

When you click on one of the category items, the list below the category bar shows the available factory templates for this category. Any new templates that you create are added at the top of the corresponding list.

### Location options

This section allows you to specify where the project is stored.

### Open Other

This button allows you to open any project file on your system. This is identical to using the **Open** command from the **File** menu.

## Project Files

A project file (extension \*.cpr) is the central document in Cubase. A project file contains references to media data that can be saved in the project folder.

### NOTE

We recommend to save files only in the project folder, even though you can save them in any other location to which you have access.

---

The project folder contains the project file and the following folders that Cubase automatically creates when necessary:

- Audio
- Edits
- Images
- Track Pictures

## Template Files

Templates can be a good starting point for new projects. Templates are projects where you can save all settings that you regularly use, such as bus configurations, sample rates, record formats, basic track layouts, VSTi setups, drum map setups, etc.

The following template types are available from within the **Hub**:

- Factory templates for specific scenarios. These are listed in the **Recording, Scoring, Production, or Mastering** categories.
- The default template. This is listed in the **More** category.
- Any new user templates that you create and save. These are listed in the **More** category.

Template projects are not saved in project folders and therefore contain no subfolders and no media files.

- To open the location of a specific template, right-click a template in the template list and select **Show in Explorer** (Windows only) or **Reveal in Finder** (macOS only).

## Save As Template Dialog

The **Save As Template** dialog allows you to save projects as templates.

- To open the **Save As Template** dialog, select **File > Save As Template**.

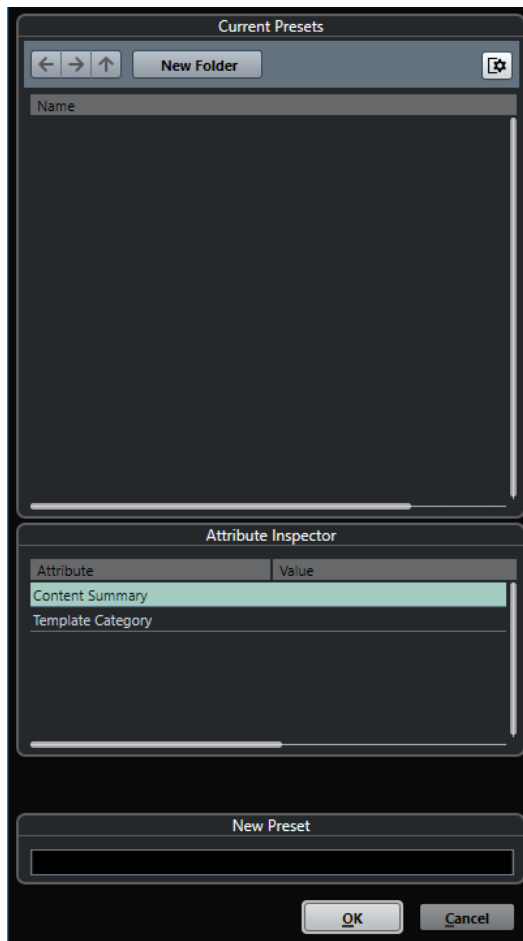

The following options are available in the **Current Presets** section:

**New Folder**

Allows you to add and name a folder to the template list.

**Template list**

Lists the templates and the folders.

The following options are available in the **Attribute Inspector** section:

**Value**

Click this field to enter a description for the **Content Summary** attribute, or to select a template category for **Template Category** attribute.

The following options are available in the **New Preset** section:

**New Preset**

Allows you to enter a name for the new project template.

**Show Attribute Inspector**

Allows you to show/hide the **Attribute Inspector**.

## Saving a Project Template File

You can save the current project as a template. When you create a new project, you can select this template as a starting point for your new project.

### PREREQUISITE

You have removed all clips from the **Pool**. This ensures that references to media data from the original project folder are deleted.

---

### PROCEDURE

1. Set up a project.
2. Select **File > Save as Template**.
3. In the **New Preset** section of the **Save as Template** dialog, enter a name for the new project template.

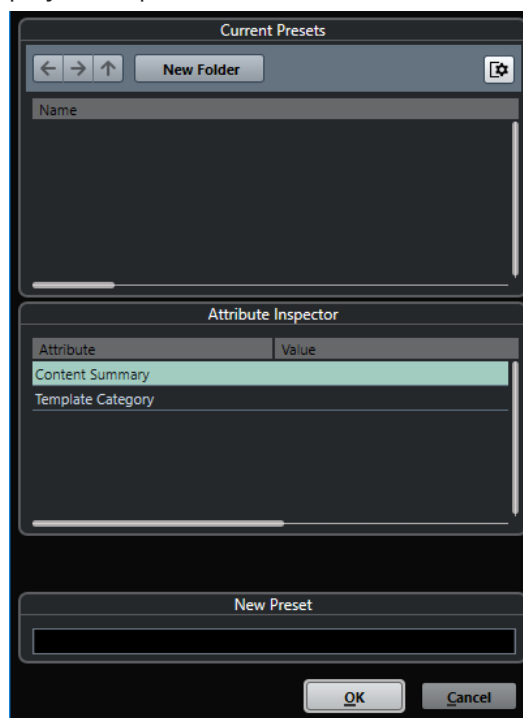

4. In the **Attribute Inspector** section, double-click the **Value** field of the **Content Summary** attribute to enter a description for the template.
  5. Click the **Value** field of the **Template Category** attribute and select a template category from the pop-up menu.  
If you do not select a category, the new template will be listed in the **Hub** in the **More** category.
  6. Click **OK** to save the template.
- 

## Renaming Templates

You can rename template files from within the **Hub** or the **Project Assistant**.

---

### PROCEDURE

1. In the **Hub** or the **Project Assistant**, right-click a template and select **Rename**.
  2. In the **Rename** dialog, enter a new name and click **OK**.
-

## Project Setup Dialog

The **Project Setup** dialog allows you to make general settings for your project.

- To open the **Project Setup** dialog, select **Project > Project Setup**.
- To open the **Project Setup** dialog automatically when you create a new project, activate the **Run Setup on Create New Project** option in the **Preferences** dialog (**General** page).

The screenshot shows the Project Setup dialog with the following settings:

- Project Duration:** Project Start Time: 00:00:00:00, Project Length: 00:10:00:00
- Project Frame Rate:** Project Frame Rate: 30 fps, Get Frame Rate from Video button
- Project Time Displays:** Display Format: Bars+Beats, Display Time Offset: 00:00:00:00, Display Bar Offset: 0
- Record File Format:** Sample Rate: 44.100 kHz, Bit Depth: 24 bit, Record File Type: Wave File
- Project Ownership:** Author: Enter Name, Company: Enter Company
- Other Project Settings:** Stereo Pan Law: Equal Power, Volume Max: +6 dB
- Hermode Tuning:** HMT Type: None, HMT Depth: 100 %

### IMPORTANT

While most **Project Setup** settings can be changed at any time, you must set the sample rate directly after creating a new project. If you change the sample rate at a later stage, you must convert all audio files in the project to the new sample rate to make them play back properly.

In the **Project Duration** section, the following options are available:

#### Project Start Time

Allows you to specify the start time of the project in timecode format. This also determines the sync start position when synchronizing to external devices.

#### Project Length

Allows you to specify the length of the project.

#### Project Frame Rate

In the **Project Frame Rate** section, the following options are available:

##### Project Frame Rate

Allows you to specify the timecode standard and frame rate for the project. When synchronizing to an external device, this setting must correspond to the frame rate of any incoming timecode.

##### Get Frame Rate From Video

Allows you to set the project frame rate to the frame rate of an imported video file.

## Project Time Displays

In the **Project Time Displays** section, the following options are available:

### Display Format

Allows you to specify the global display format that is used for all rulers and position displays in the program, except the ruler tracks. However, you can make independent display format selections for the individual rulers and displays.

### Display Time Offset

Allows you to specify an offset for the time positions that are displayed in the rulers and position displays to compensate for the **Project Start Time** setting.

### Display Bar Offset

This setting is only used if you select the **Bars+Beats** display format. Allows you to specify an offset for the time positions that are displayed in the rulers and position displays to compensate for the **Project Start Time** setting.

## Record File Format

In the **Record File Format** section, the following options are available:

### Sample Rate

Allows you to specify the sample rate at which Cubase records and plays back audio.

- If your audio hardware generates the sample rate internally and you select a non-supported sample rate, this is indicated by a different color. In this case, you must set a different sample rate to make your audio files play back properly.
- If you select a sample rate that your audio hardware supports, but that differs from its current sample rate setting, it is automatically changed to the project sample rate.
- If your audio hardware is externally clocked and receives external clock signals, sample rate mismatches are accepted.

### Bit Depth

Allows you to specify the bit depth of the audio files that you record in Cubase. Select the record format according to the bit depth that is delivered by your audio hardware. The available options are 16 bit, 24 bit, 32 bit, 32 bit float, and 64 bit float.

#### NOTE

- If your audio interface supports a bit depth of 32 bit, and you want to maintain this precision in your recordings, you must select a **Processing Precision** of 64 bit float in the **Studio Setup** dialog.
  - When you record with effects, consider setting the bit depth to 32 bit float or 64 bit float. This prevents clipping (digital distortion) in the recorded files and keeps the audio quality very high. Effect processing and level or EQ changes in the input channel are done in 32-bit float or 64-bit float format, depending on the **Processing Precision** setting in the **Studio Setup** dialog. If you record at 16 bit or 24 bit, the audio will be converted to this lower bit depth when it is written to a file. As a result, the signal may degrade. This is independent of the actual bit depth of your audio hardware. Even if the signal from the audio hardware has a bit depth of 16 bit, the signal will be 32 bit float or 64 bit float after the effects are added to the input channel.
  - The higher the bit depth value, the larger the files and the more strain is put on the disk system. If this is an issue, you can lower the record format setting.
-

### Record File Type

Allows you to specify the file type of the audio files that you record in Cubase.

#### NOTE

- For wave file recordings larger than 4 GB, the EBU RIFF standard is used. If a FAT 32 disk is used (not recommended), audio files are split automatically. In the **Preferences** dialog, you can specify what happens if your recorded Wave file is larger than 4 GB.
- You can set up embedded strings in the **Preferences** dialog.

### Project Ownership

In the **Project Ownership** section, the following options are available:

#### Author

Allows you to specify a project author that is written into the file, when you export audio files and activate the **Insert iXML chunk** option. You can specify a default author in the **Default Author Name** field in the **Preferences** dialog (**General—Personalization** page).

#### Company

Allows you to specify a company name that is written into the file, when you export audio files and activate the **Insert iXML chunk** option. You can specify a default company in the **Default Company Name** field in the **Preferences** dialog (**General—Personalization** page).

### Other Project Settings

In the **Other Project Settings** section, the following options are available:

#### Stereo Pan Law

If you pan a channel left or right, the sum of the left and right side is higher (louder), than if this channel is panned center. These modes allow you to attenuate signals panned center. **0 dB** turns off constant-power panning. **Equal Power** means that the power of the signal remains the same regardless of the pan setting.

#### Volume Max

Allows you to specify the maximum fader level. By default, this is set to +12 dB. If you load projects that were created with Cubase versions older than 5.5, this value is set to the old default value of +6 dB.

### Hermoder Tuning

In the **Hermoder Tuning** section, the following options are available:

#### HMT Type (MIDI only)

Allows you to specify a mode for Hermoder tuning of MIDI notes.

#### HMT Depth (MIDI only)

Allows you to specify the overall degree of retuning.

#### RELATED LINKS

[VST Audio System Page](#) on page 15

[Record - Audio](#) on page 902



## Opening Project Files

You can open one or several saved project files at the same time.

### IMPORTANT

If you open a project saved with a different program version that contains data for functions that are not available in your version, this data may be lost when you save the project with your version.

---

### NOTE

- If you open an external project, the last used view that was saved on your computer is used. You can change this setting in the **Preferences** dialog (**General** page).
  - External projects are automatically connected to the input and output busses. If you open a project that was created on a computer with an ASIO port configuration different from the configuration of your computer, this can result in unwanted audio connections. You can deactivate the automatic connection of input and output busses in the **Preferences** dialog (**VST** page).
- 

### PROCEDURE

1. Select **File > Open**.
  2. In the file dialog that opens, select the project that you want to open and click **Open**.
  3. If there already is an open project, you are asked if you want to activate the new project. Do one of the following:
    - To activate the project, click **Activate**.
    - To open the project without activating it, click **No**.  
This reduces load times for projects.
- 

### RELATED LINKS

[Workspaces for External Projects](#) on page 874

[Do Not Connect Input/Output Busses When Loading External Projects](#) on page 907

[Activating Projects](#) on page 89

## Activating Projects

If you have several projects opened at the same time in Cubase, only one project can be active. The active project is indicated by the lit **Activate Project** button in the upper left corner of the **Project** window. If you want to work on another project, you have to activate the other project.

---

### PROCEDURE

- To activate a project, click **Activate Project** .

### NOTE

If you close the active project, you must activate another open project manually as Cubase can not automatically activate one of the other open projects.

---

## Opening Recent Projects

You can open recent projects directly from the recent projects list.

---

### PROCEDURE

- Do one of the following:
    - In the category bar of the **Hub** or the **Project Assistant** dialog, click **Recent**, select a project from the projects list, and click **Open**.
    - Select **File > Recent Projects** and select a recently opened project.
- 

## Re-Routing Missing Ports

If you open a Cubase project that was created on a different system with other audio hardware, Cubase tries to find matching audio inputs and outputs for the input/output busses. If Cubase cannot resolve all audio/MIDI inputs and outputs that are used in the project, the **Missing Ports** dialog opens.

This allows you to manually re-route any ports specified in the project to ports that are available in your system.

---

### NOTE

To improve the search for matching audio inputs and outputs for the input/output busses, you should use descriptive, generic names for your input and output ports.

---

### RELATED LINKS

[Renaming the Hardware Inputs and Outputs](#) on page 25

## Saving Project Files

You can save the active project as a project file. To keep your projects as manageable as possible, make sure that you save project files and all related files in the respective project folders.

- To save the project and specify a file name and location, open the **File** menu and select **Save As**.
- To save the project with its current name and location, open the **File** menu and select **Save**.

## Auto Save

Cubase can automatically save backup copies of all open project files with unsaved changes.

---

### NOTE

Only the project files are backed up. If you want to include the files from the **Pool** and save your project in a different location, you must use the **Back up Project** function.

---

Cubase can automatically save backup copies of all open projects with unsaved changes. To set this up, activate the **Auto Save** option in the **Preferences** dialog (**General** page). The backup copies are named “<project name>-xx.bak” where xx is an incremental number. Unsaved projects are backed up in a similar way as “UntitledX-xx.bak”, with X being the incremental number for unsaved projects. All backup files are saved in the project folder.

- To specify the time intervals in which a backup copy is created, use the **Auto Save Interval** setting.

- To specify how many backup files are created with the **Auto Save** function, use the **Maximum Backup Files** option. When the maximum number of backup files is reached, the existing files are overwritten, starting with the oldest file.

## Saving Project Files As a New Version

You can create and activate a new version of an active project file. This is useful if you are experimenting with edits and arrangements and want to be able to go back to a previous version at any time.

---

### PROCEDURE

- Do one of the following:
  - Select **File > Save New Version**.
  - Press **Ctrl/Cmd-Alt-S**.

---

### RESULT

The new file is saved with the same name as the original project and an attached incremental number. For example, if your project is called "My Project", new versions are called "My Project-01", "My Project-02", and so on.

## Reverting to the Last Saved Version

You can return to the last saved version and discard all changes that have been introduced.

---

### PROCEDURE

1. Select **File > Revert**.
2. In the warning message, click **Revert**.  
If you have recorded or created new audio files since the last version was saved, you are prompted to delete or keep the files.

## Choosing a Project Location

You can specify a project location for saving projects in the **Hub** and in the **Project Assistant**.

---

### PROCEDURE

1. Do one of the following:
  - Select **Use default location** to create a project in the default project location, and in the **Project folder** field, specify a name for the project folder. If you do not specify a project folder here, the project is saved in a folder named **Untitled**.

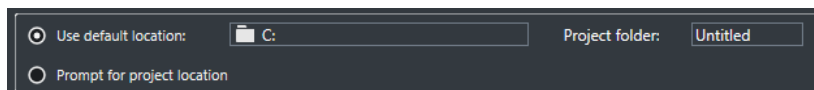

- Click in the path field to change the default project location, and specify the new default location in the file dialog that opens.
  - Activate **Prompt for project location** to open a file dialog where you can specify the project folder location.
2. Do one of the following:
    - Click **Create Empty** to create a new empty project.

- Select one of the template projects and click **Create** to create a project based on a template.
- 

#### RESULT

The project is created and saved in the specified location.

## Self-Contained Projects

If you want to share your work or transfer it to another computer, your project must be self-contained.

The following functions facilitate this task:

- Select **Media > Prepare Archive** to verify that every clip that is referenced in the project is located in the project folder, and to take actions if that is not the case.
- Select **File > Back up Project** to create a new project folder where you can save the project file and the necessary work data. The original project remains unchanged.

#### RELATED LINKS

[Preparing Archives](#) on page 92

[Backing up Projects](#) on page 92

## Preparing Archives

The **Prepare Archive** function allows you to gather all files that are referenced by your project to ensure that these are in the project folder. This is useful if you want to move or archive your project.

---

#### PROCEDURE

1. Select **Media > Prepare Archive**.

If your project references external files, you are prompted if you want to copy them to your working directory. If any processing has been applied, you must decide if you want to flatten edits.

2. Click **Proceed**.
- 

#### RESULT

Your project is ready to be archived. You can move or copy the project folder to another location.

#### AFTER COMPLETING THIS TASK

You must copy audio files that reside within the project folder to the **Audio** folder or save them separately. You must also move your video clips manually, as videos are only referenced and not saved in the project folder.

## Backing up Projects

You can create a backup copy of your project. Backups only contain the necessary work data. All media files except the files from VST Sound archives are included as a copy.

---

#### PROCEDURE

1. Select **File > Back up Project**.
  2. Select an empty folder or create a new one.
  3. Make your changes in the **Back up Project Options** dialog and click **OK**.
-

#### RESULT

A copy of the project is saved in the new folder. The original project remains unaffected.

#### NOTE

VST Sound content provided by Steinberg is copy-protected and is not included in the backup project. If you want to use a backup copy that uses VST Sound content on a different computer, make sure that the corresponding content is also available on that computer.

---

## Back up Project Options Dialog

The **Back up Project Options** dialog allows you to create a backup copy of your project.

- To open the **Back up Project Options** dialog, select **File > Back up Project**.

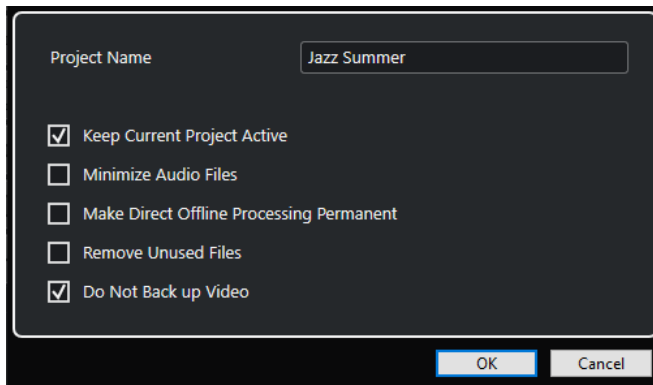

#### Project Name

Allows you to change the name of the backed up project.

#### Keep Current Project Active

Allows you to keep the current project active after clicking **OK**.

#### Minimize Audio Files

Allows you to include only the audio file portions that are actually used in the project. This can significantly reduce the size of the project folder if you are using small sections of large files. It also means that you cannot use other parts of the audio files if you continue working with the project in its new folder.

#### Make Direct Offline Processing Permanent

Allows you to flatten all edits and make all processing and applied effects permanent to each clip in the **Pool**.

#### Remove Unused Files

Allows you to remove unused files and to back up only the files that are actually used.

#### Do Not Back up Video

Allows you to exclude video clips on the video track or in the **Pool** of the current project.

# Tracks

Tracks are the building blocks of your project. They allow you to import, add, record, and edit parts and events. Tracks are listed from top to bottom in the track list and extend horizontally across the **Project** window. Each track is assigned to a particular channel strip in the **MixConsole**.

If you select a track in the **Project** window, the controls, settings, and parameters displayed in the **Inspector** and the track list allow you to control the track.



## Track Inspector Settings Dialog

The **Track Inspector Settings** dialog allows you to configure for each track type which **Inspector** sections are shown. You can also specify the order of the sections.

- To open the **Track Inspector Settings** dialog, click **Set up Inspector**, and select **Setup** from the pop-up menu.



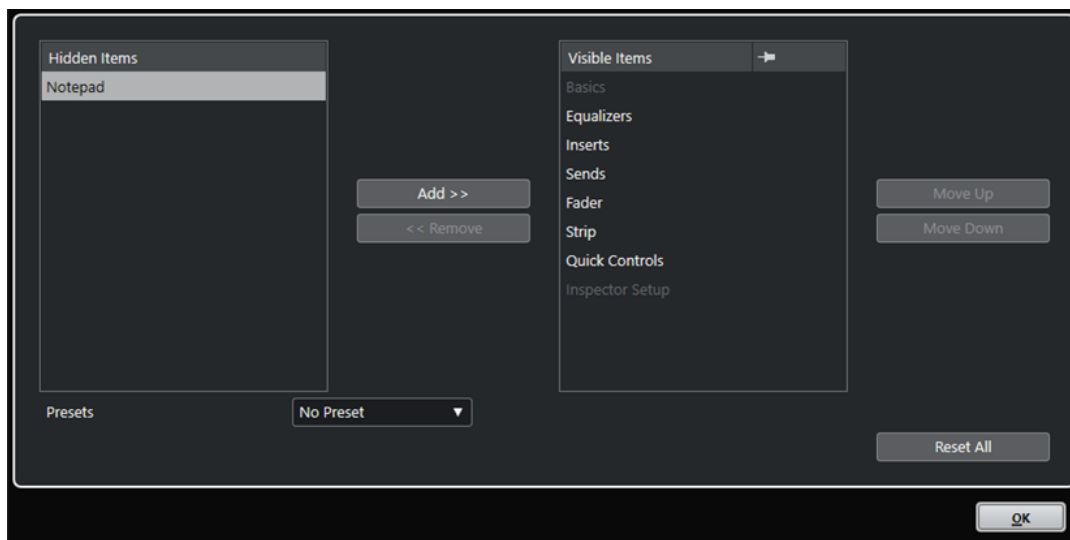

### Hidden Items

Displays sections that are hidden in the **Inspector**.

### Visible Items

Displays sections that are visible in the **Inspector**.

### Pin

Activate **Pin** by clicking the column for a section to exclude this section from being closed automatically.

### Add

Allows you to move an item selected in the hidden sections list to the list of visible sections.

### Remove

Allows you to move an item selected in the visible sections list to the list of hidden sections.

### Move Up/Move Down

Allows you to change the position of an item in the list of visible sections.

### Presets

Allows you to save **Inspector** settings as presets.

### Reset All

Allows you to restore the default **Inspector** settings.

## Inspector Sections

Each track type has its basic track settings that are always shown. Apart from these, you can set up other track-specific **Inspector** sections in the **Track Inspector Settings** dialog.

Depending on the track type, you can set up the following **Inspector** sections:

### Track Versions

Allows you to create and edit **Track Versions**.

### Chords

Allows you to specify how the track follows the chord track.

### **Inserts**

Allows you to add audio insert effects to the track.

### **Equalizers**

Allows you to adjust the EQs for the track. You can have up to four bands of EQs for each track.

### **Sends**

Allows you to route the track to one or several FX channels.

### **Strip**

Allows you to set up the channel strip modules.

### **Fader**

Shows a duplicate of the corresponding **MixConsole** channel.

### **Notepad**

Allows you to enter notes about the track.

### **Quick Controls**

Allows you to configure quick controls to use remote devices, for example.

### **Note Expression**

Allows you to work with the **Note Expression** features.

### **MIDI Modifiers**

Allows you to transpose or adjust the velocity of the MIDI track events in real time during playback.

### **MIDI Inserts**

Allows you to add MIDI insert effects.

### **Instrument**

Shows the audio-related controls for the sampler track.

### **MIDI Sends**

Allows you to add MIDI send effects.

### **MIDI Fader**

Shows a duplicate of the corresponding **MixConsole** channel.

### RELATED LINKS

[Inspector Sections](#) on page 48

[Track Inspector Settings Dialog](#) on page 94

[Track Versions Section](#) on page 156

[Insert Effects](#) on page 363

[Send Effects](#) on page 369

[Equalizers \(EQ\)](#) on page 336

[Chords Section for MIDI Tracks](#) on page 740

[Channel Strips](#) on page 339

[Track Quick Controls](#) on page 569

[Note Expression](#) on page 706

[MIDI Modifiers Section](#) on page 593

[MIDI Inserts](#) on page 598

[MIDI Sends](#) on page 599



## Track Controls Settings Dialog

The **Track Controls Settings** dialog allows you to configure which track controls are shown in the track list. You can also specify the order of controls and group controls so that they are always shown adjacent to each other.

### NOTE

The **Track Controls Settings** dialog is available for the main track types. Track types that can only be added once have their fixed set of track-specific controls. In the global **Add Track** dialog, these tracks are shown in the **More Tracks** section. An exception to this are the chord track and the video track.

- To open the **Track Controls Settings** dialog, right-click a track in the track list and select **Track Controls Settings** from the context menu, or click **Open Track Controls Settings Dialog** in the bottom right corner of the track list.

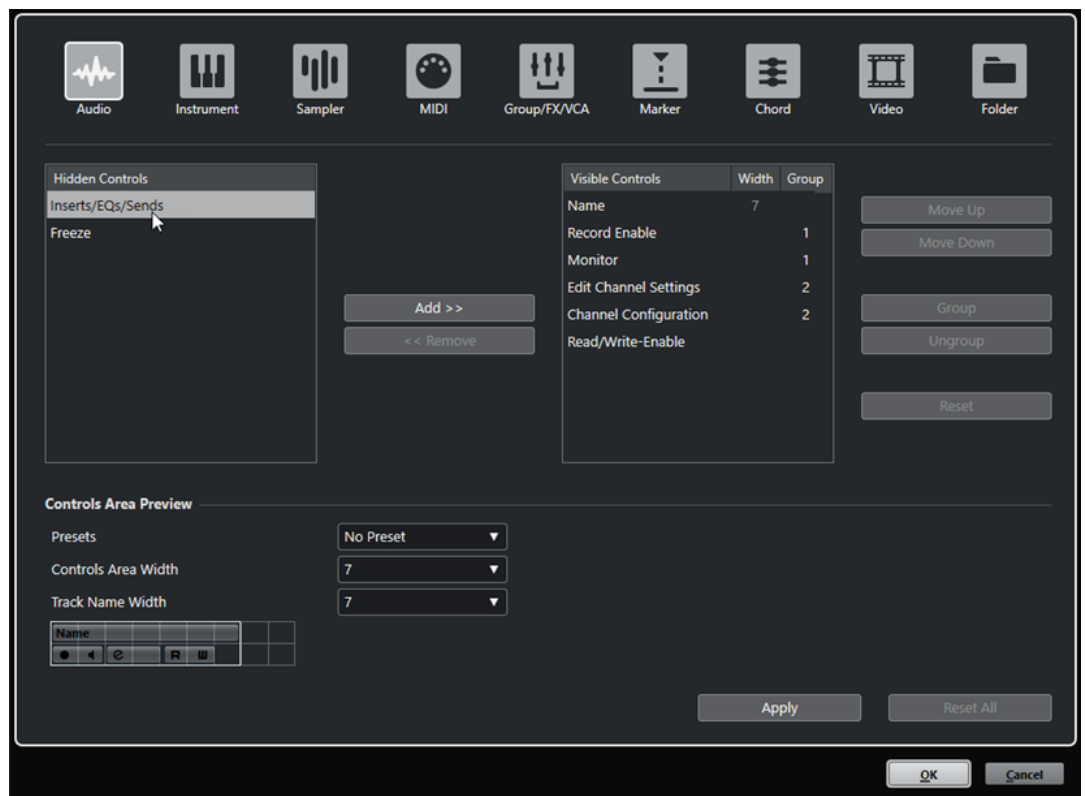
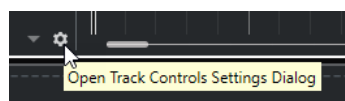

### Track type

Allows you to select the track type to which your settings are applied.

### Hidden Controls

Displays controls that are hidden in the track list.

### Visible Controls

Displays controls that are visible in the track list.

### Width

If you click in this column, you can set the maximum length for the track name.

**Group**

Displays the group number.

**Add**

Allows you to move an item selected in the hidden controls list to the list of visible controls.

**Remove**

Allows you to move an item selected in the visible controls list to the list of hidden controls. All controls can be removed except **Mute** and **Solo**.

**Move Up/Move Down**

Allows you to change the order of an item in the list of visible controls.

**Group**

Allows you to group two or more controls selected in the visible controls list that are adjacent to each other. This ensures that they are always positioned side by side in the track list.

**Ungroup**

Allows you to ungroup grouped controls in the visible controls list. To remove an entire group, select the first (topmost) element belonging to this group and click **Ungroup**.

**Reset**

Allows you to restore all default track controls settings for the selected track type.

**Controls Area Preview**

Shows a preview of the customized track controls.

**Presets**

Allows you to save track controls settings as presets. To recall a preset, click **Switch Presets** in the bottom right corner of the track list. The name of the selected preset is shown in the left corner.

**Controls Area Width**

Allows you to determine the width of the track controls area for the selected track type. In the **Controls Area Preview**, this area is shown with a frame.

**Track Name Width (global)**

Allows you to determine the global name width for all track types.

**Apply**

Applies your settings.

**Reset All**

Allows you to restore all default track controls settings for all track types.

## RELATED LINKS

[More Tracks](#) on page 128

## Track Controls

You can configure which track controls are shown in the track list.

**NOTE**

You can only configure track controls for the main track types. Track types that can only be added once have their fixed set of track-specific controls. In the global **Add Track** dialog, these tracks

are shown in the **More Tracks** section. An exception to this are the chord track and the video track.

---

The following track controls are always shown:

#### Mute



Mutes the track.

#### Solo



Solos the track.

The track name control is available for all track types:

#### Name



Shows the name of the track. Double-click to rename the track.

### Audio-Related Tracks

The following track controls are specific to audio-related tracks, that is, audio tracks, instrument tracks, sampler tracks, group channel tracks, FX channel tracks:

#### Bypass Inserts



Bypasses the inserts for the track.

#### Bypass EQs



Bypasses the equalizers for the track.

#### Bypass Sends



Bypasses the sends for the track.

#### Freeze Channel



Opens a dialog that allows you to set the **Tail Size** time in seconds.

#### Channel Configuration



Shows the channel configuration of the track.

### MIDI-Related Tracks

The following controls are specific to MIDI-related tracks, that is, MIDI tracks, sampler tracks, and instrument tracks:

#### ASIO Latency Compensation



Moves all recorded events on the track by the current latency.

#### Programs

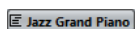

Allows you to select a program.

#### Edit In-Place



Allows you to edit MIDI events and parts on the track in the **Project** window.

### Drum Map



Allows you to select a drum map for the track.

## Audio- and MIDI-Related Tracks

The following track controls are specific to audio- and MIDI-related tracks:

### Record Enable



Activates the track for recording.

### Monitor



For audio-related tracks, this routes incoming signals to the selected output.

For MIDI and instrument-related tracks, this allows you to route incoming MIDI signals to the selected MIDI output. For this to work, activate **MIDI Thru Active** in the **Preferences** dialog (**MIDI** page).

### Edit Channel Settings



Opens the **Channel Settings** window for the track.

### Show Lanes



Divides the tracks in lanes.

### Lock



Disables all editing of all events on the track.

### Read Automation



Allows you to read track automation.

### Write Automation



Allows you to write track automation.

## Instrument Tracks

The following controls are specific to instrument tracks:

### Edit Instrument



Allows you to open the instrument panel.

### Instrument

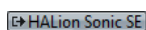

Allows you to select an instrument.

## Sampler Tracks

The following controls are specific to sampler tracks:

### Open/Close Sampler

Opens/Closes the **Sampler Control** in the lower zone.

## MIDI Tracks

The following controls are specific to MIDI tracks:

### Channel



Allows you to specify the MIDI channel.

### Output



Allows you to specify the output for the track.

### Bypass Inserts



Bypasses the inserts for the track.

### Bypass Sends



Bypasses the sends for the track.

## Group/FX/VCA Tracks

The following track controls are specific to group/FX/VCA tracks:

### Mute Automation



Deactivates the automation read function for the selected parameter.

### Lock Automation



Disables all editing of all events on the track.

### Automation parameter

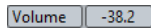

Allows you to select a parameter for automation.

### Parameter

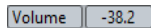

Allows you to select a parameter value for automation.

## Marker Tracks

The following controls are specific to marker tracks:

### Add Marker



Allows you to add a position marker at the project cursor position. This track control is always shown.

### Add Cycle Marker



Allows you to add a cycle marker at the project cursor position. This track control is always shown.

### Locate



Allows you to move the project cursor to the selected marker position.

### Cycle



Allows you to select a cycle marker.

### Zoom



Allows you to zoom in a cycle marker.

## Add Track Dialog

The **Add Track** dialog allows you to set up and add tracks.

To open the **Add Track** dialog, click **Add Track**  in the global track controls area of the track list.

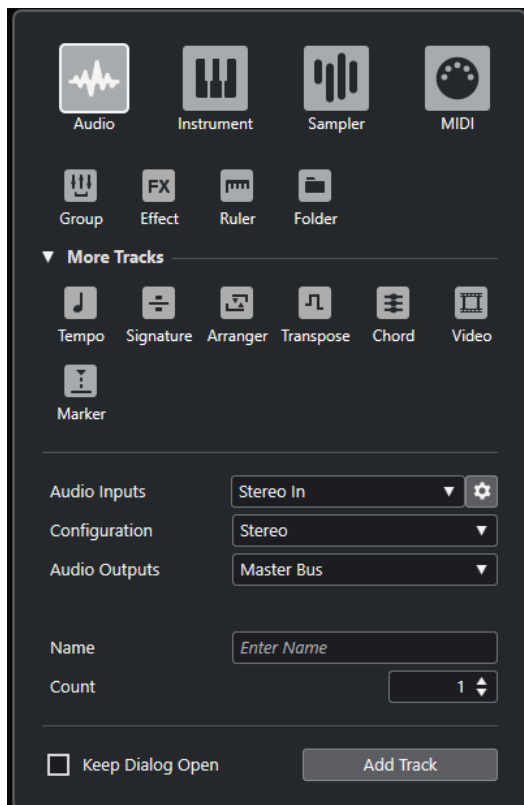

The **More Tracks** section shows track types that can only be added once.

#### RELATED LINKS

- [Add Track Dialog – Audio](#) on page 103
- [Add Track Dialog – Instrument](#) on page 107
- [Add Track Dialog – Sampler](#) on page 111
- [Add Track Dialog – MIDI](#) on page 114
- [Add Track Dialog – Group Channel](#) on page 117
- [Add Track Dialog – Effect](#) on page 120
- [Add Track Dialog – Ruler](#) on page 123
- [Add Track Dialog – Folder](#) on page 125
- [More Tracks](#) on page 128
- [Tempo Track](#) on page 135
- [Signature Track](#) on page 134
- [Arranger Track](#) on page 128
- [Transpose Track](#) on page 137

[Chord Track](#) on page 130  
[Video Track](#) on page 137  
[Marker Track](#) on page 133

## Audio Tracks

You can use audio tracks for recording and playing back audio events and audio parts. Each audio track has a corresponding audio channel in the **MixConsole**. An audio track can have any number of automation tracks for automating channel parameters, effect settings, etc.

You can add audio tracks via the **Add Track** dialog.

### RELATED LINKS

[Add Track Dialog – Audio](#) on page 103

## Add Track Dialog – Audio

The **Audio** page of the **Add Track** dialog allows you to set up and add audio tracks.

To open the **Audio** page of the **Add Track** dialog, do one of the following:

- Click **Add Track**  in the global track controls area of the track list, and click **Audio**. This opens the global **Add Track** dialog on the **Audio** page.

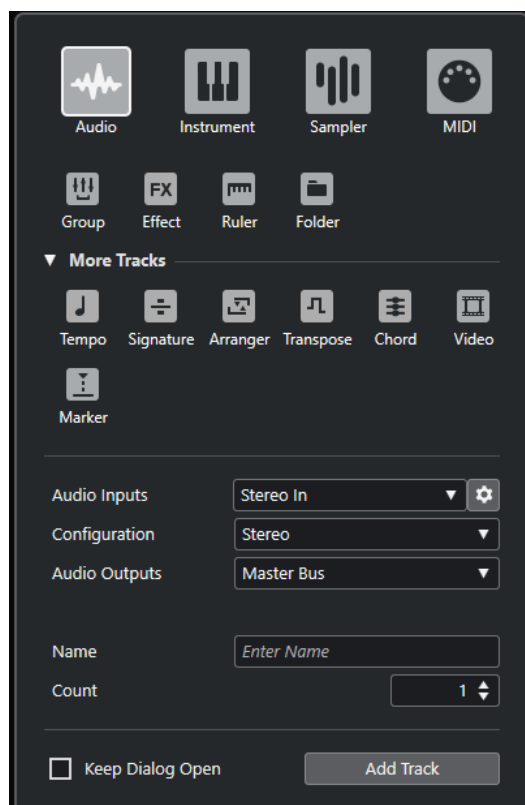

- Select **Project > Add Track > Audio** or right-click in an empty area of the track list, and select **Add Audio Track**. This opens only the **Audio** page of the **Add Track** dialog.

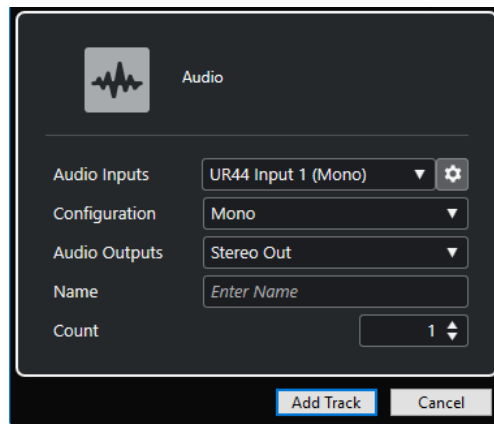

The following settings are available:

### Audio Inputs

Opens a window where you can select an input of your connected audio hardware. If you have added an input bus in the **Audio Connections** window, you can connect to that input bus.

The **Open Audio Connections** button opens the **Audio Connections** window.

### Configuration

Allows you to set the channel configuration. Audio-related tracks can be configured as mono or stereo tracks.

### Audio Outputs

Allows you to set the output routing.

### Name

Allows you to specify a track name.

### Count

Allows you to enter the number of tracks that you want to add.

### Keep Dialog Open

Activate this to keep the dialog open after clicking **Add Track**. This allows you to click the page of another track type to set up and add more tracks.

### NOTE

This is only available if you open the **Add Track** dialog from the global track controls.

---

### Add Track

Adds one or more tracks, according to the track type and settings of the active page, and closes the dialog.

### RELATED LINKS

[Audio Connections Window](#) on page 24



## Audio Track Inspector

The **Inspector** for audio tracks contains controls and parameters that allow you to edit your audio track.



The top section of the audio track **Inspector** contains the following basic track settings:

### Track name

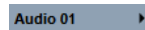

Click once to show/hide the basic track settings section. Double-click to rename the track.

### Colorize Selected Track



Allows you to colorize the selected track.

### Edit Channel Settings



Opens the **Channel Settings** window for the track.

### Mute



Mutes the track.

### Solo



Solos the track.

### Read Automation



Allows you to read track automation.

### Write Automation



Allows you to write track automation.

### Auto Fades Settings



Opens a dialog where you can make separate fade settings for the track.

### Record Enable



Activates the track for recording.

### Monitor



Routes incoming signals to the selected output.

### Toggle Time Base



Switches between musical (tempo-related) and linear (time-related) time base for the track.

### Lock



Disables all editing of all events on the track.

### Show Lanes



Divides the tracks in lanes.

### Freeze Audio Channel



Allows you to freeze the audio channel.

### Volume

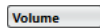

Allows you to adjust the level of the track.

### Pan



Allows you to adjust the panning of the track.

### Delay



Allows you to adjust the playback timing of the track.

### Load/Save/Reload Track Preset



Loads or saves a track preset or reverts the default presets.

### Input Routing



Allows you to specify the input bus for the track.

### Output Routing



Allows you to specify the output bus for the track.

#### RELATED LINKS

[Inspector Sections](#) on page 95

## Instrument Tracks

You can use instrument tracks for dedicated VST instruments. Each instrument track has a corresponding instrument channel in the **MixConsole**. An instrument track can have any number of automation tracks.

You can add instrument tracks via the **Add Track** dialog.

#### RELATED LINKS

[Add Track Dialog – Instrument](#) on page 107

## Add Track Dialog – Instrument

The **Instrument** page of the **Add Track** dialog allows you to set up and add instrument tracks.

To open the **Instrument** page of the **Add Track** dialog, do one of the following:

- Click **Add Track** in the global track controls area of the track list, and click **Instrument**. This opens the global **Add Track** dialog on the **Instrument** page.

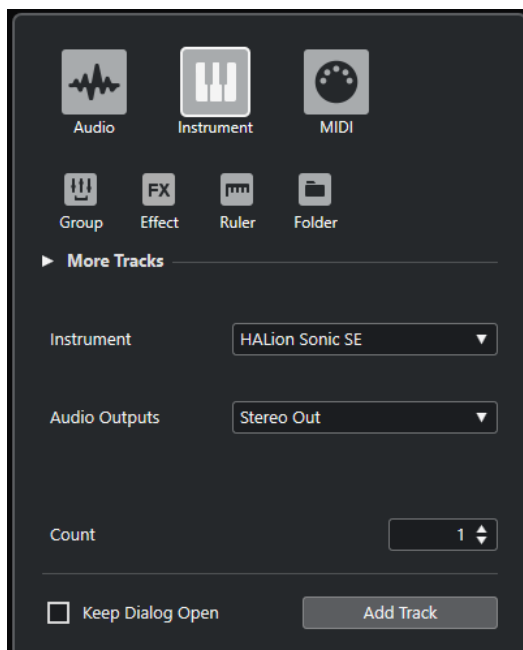
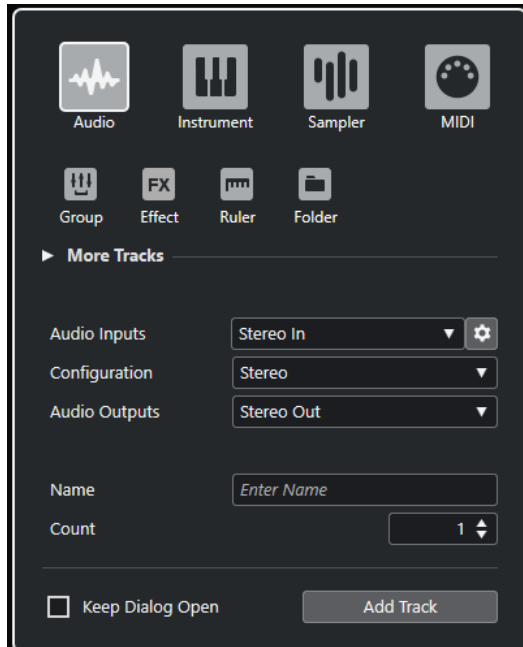

- Select **Project > Add Track > Instrument** or right-click in an empty area of the track list, and select **Add Instrument Track**.

This opens only the **Instrument** page of the **Add Track** dialog.

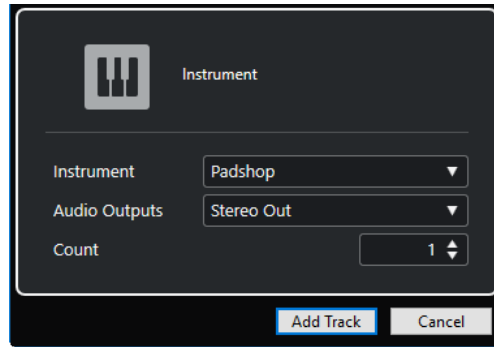

The following settings are available:

#### Instrument

Allows you to select an instrument.

#### Audio Outputs

Allows you to set the output routing.

#### Count

Allows you to enter the number of tracks that you want to add.

#### Keep Dialog Open

Activate this to keep the dialog open after clicking **Add Track**. This allows you to click the page of another track type to set up and add more tracks.

#### NOTE

This is only available if you open the **Add Track** dialog from the global track controls.

#### Add Track

Adds one or more tracks, according to the track type and settings of the active page, and closes the dialog.

## Instrument Track Inspector

The **Inspector** for instrument tracks contains controls and parameters that allow you to control your instrument track. It shows some of the sections from VST instrument channels and MIDI tracks.

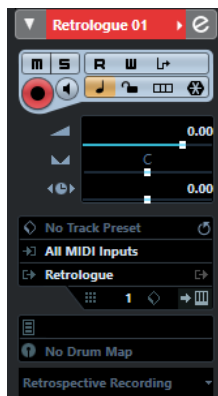

The top section of the instrument track **Inspector** contains the following basic track settings:

#### Track name

HALion Sonic SE

Click once to show/hide the basic track settings section. Double-click to rename the track.

#### Colorize Selected Track



Allows you to colorize the selected track.

#### Edit Channel Settings



Opens the **Channel Settings** window for the track.

#### Mute



Mutes the track.

#### Solo



Solos the track.

#### Read Automation



Allows you to read track automation.

#### Write Automation



Allows you to write track automation.

#### Input Transformer



Opens a pop-up menu that allows you to transform incoming MIDI events in real time.

#### Record Enable



Activates the track for recording.

#### Monitor



Routes incoming MIDI to the selected MIDI output. For this to work, activate **MIDI Thru Active** in the **Preferences** dialog (**MIDI** page).

#### Toggle Time Base



Switches between musical (tempo-related) and linear (time-related) time base for the track.

#### Lock



Disables all editing of all events on the track.

#### Freeze Instrument Channel



Allows you to freeze the instrument.

#### Volume



Allows you to adjust the level of the track.

### Pan



Allows you to adjust the panning of the track.

### Delay



Allows you to adjust the playback timing of the track.

### Show Lanes



Divides the tracks in lanes.

### Load/Save/Reload Track Preset



Loads or saves a track preset or reverts the default presets.

### Input Routing



Allows you to specify the input bus for the track.

### Activate Outputs



This control is only available if the instrument provides more than one output. It allows you to activate one or more outputs for the instrument.

### Edit Instrument



Allows you to open the instrument panel.

### Programs

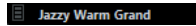

Allows you to select a program.

### Drum Maps

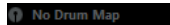

Allows you to select a drum map for the track.

#### RELATED LINKS

[Inspector Sections](#) on page 95

## Sampler Tracks

You can use sampler tracks for controlling the playback of audio samples via MIDI. Each sampler track has a corresponding channel in the **MixConsole**. A sampler track can have any number of automation tracks.

You can add sampler tracks via the **Add Track** dialog.

#### RELATED LINKS

[Add Track Dialog – Sampler](#) on page 111

[Creating Sampler Tracks](#) on page 463

[Sampler Control](#) on page 464

## Add Track Dialog – Sampler

The **Sampler** page of the **Add Track** dialog allows you to set up and add sampler tracks.

To open the **Sampler** page of the **Add Track** dialog, do one of the following:

- Click **Add Track**  in the global track controls area of the track list, and click **Sampler**. This opens the global **Add Track** dialog on the **Sampler** page.

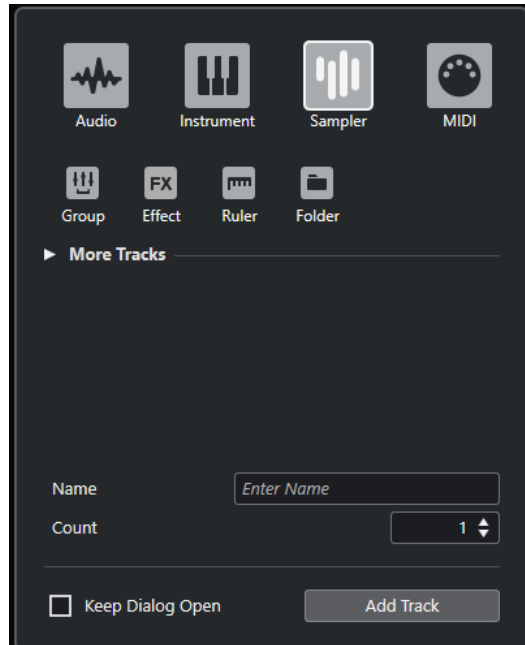

- Select **Project > Add Track > Sampler** or right-click in an empty area of the track list, and select **Add Sampler Track**.

This opens only the **Sampler** page of the **Add Track** dialog.

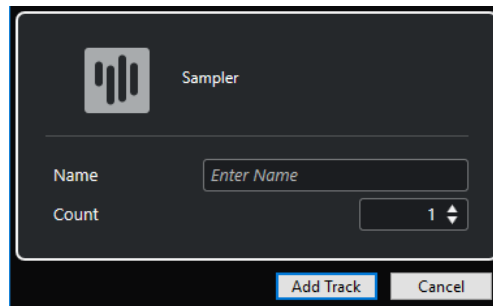

The following settings are available:

### Name

Allows you to specify a track name.

### Count

Allows you to enter the number of tracks that you want to add.

### Keep Dialog Open

Activate this to keep the dialog open after clicking **Add Track**. This allows you to click the page of another track type to set up and add more tracks.

### NOTE

This is only available if you open the **Add Track** dialog from the global track controls.

### Add Track

Adds one or more tracks, according to the track type and settings of the active page, and closes the dialog.

## Sampler Track Inspector

The **Inspector** for sampler tracks contains controls and parameters that allow you to edit your sampler track.

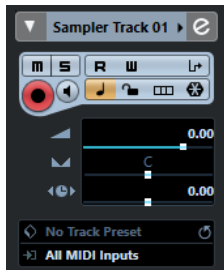

The top section of the sampler track **Inspector** contains the following basic track settings:

### Track name

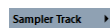

Click once to show/hide the basic track settings section. Double-click to rename the track.

### Colorize Selected Track



Allows you to colorize the selected track.

### Edit Channel Settings



Opens the **Channel Settings** window for the track.

### Mute



Mutes the track.

### Solo



Solos the track.

### Read Automation



Allows you to read track automation.

### Write Automation



Allows you to write track automation.

### Input Transformer



Opens a pop-up menu that allows you to transform incoming MIDI events in real time.

### Record Enable



Activates the track for recording.



### Monitor



Routes incoming MIDI to the selected MIDI output. For this to work, activate **MIDI Thru Active** in the **Preferences** dialog (**MIDI** page).

### Toggle Time Base



Switches between musical (tempo-related) and linear (time-related) time base for the track.

### Lock



Disables all editing of all events on the track.

### Show Lanes



Divides the tracks in lanes.

### Freeze Sampler Channel



Allows you to freeze the sampler track.

### Volume



Allows you to adjust the level of the track.

### Pan



Allows you to adjust the panning of the track.

### Delay



Allows you to adjust the playback timing of the track.

### Load/Save/Reload Track Preset



Loads or saves a track preset or reverts the default presets.

### Input Routing



Allows you to specify the input bus for the track.

### RELATED LINKS

[Inspector Sections](#) on page 95

## MIDI Tracks

You can use MIDI tracks for recording and playing back MIDI parts. Each MIDI track has a corresponding MIDI channel in the **MixConsole**. A MIDI track can have any number of automation tracks.

You can add MIDI tracks via the **Add Track** dialog.

### RELATED LINKS

[Add Track Dialog – MIDI](#) on page 114

## Add Track Dialog – MIDI

The **MIDI** page of the **Add Track** dialog allows you to set up and add MIDI tracks.

To open the **MIDI** page of the **Add Track** dialog, do one of the following:

- Click **Add Track**  in the global track controls area of the track list, and click **MIDI**. This opens the global **Add Track** dialog on the **MIDI** page.

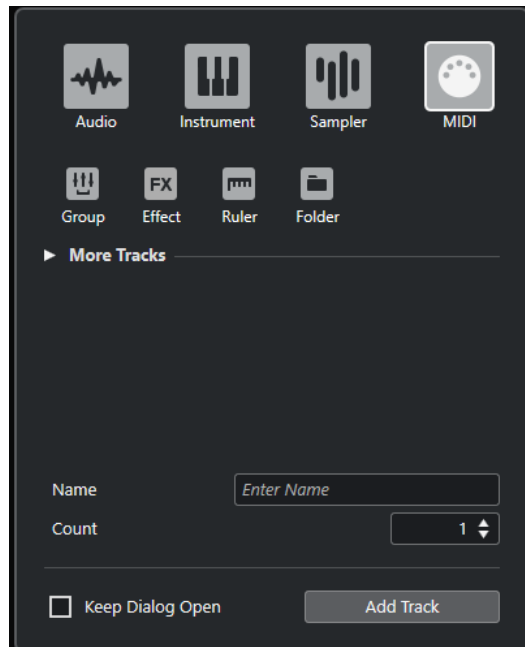

- Select **Project > Add Track > MIDI** or right-click in an empty area of the track list, and select **Add MIDI Track**.

This opens only the **MIDI** page of the **Add Track** dialog.

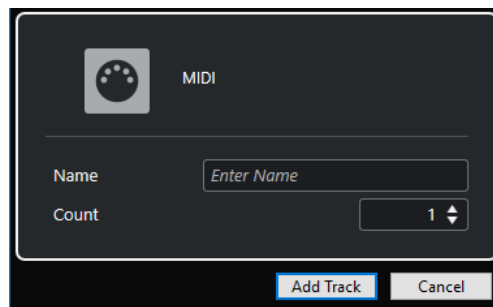

The following settings are available:

### Name

Allows you to specify a track name.

### Count

Allows you to enter the number of tracks that you want to add.

### Keep Dialog Open

Activate this to keep the dialog open after clicking **Add Track**. This allows you to click the page of another track type to set up and add more tracks.

### NOTE

This is only available if you open the **Add Track** dialog from the global track controls.

### Add Track

Adds one or more tracks, according to the track type and settings of the active page, and closes the dialog.

## MIDI Track Inspector

The **Inspector** for MIDI tracks contains controls and parameters that allow you to control your MIDI track. These affect MIDI events in real time, on playback, for example.



The top section of the MIDI track **Inspector** contains the following basic track settings:

### Track name



Click once to show/hide the basic track settings section. Double-click to rename the track.

### Colorize Selected Track



Allows you to colorize the selected track.

### Edit Channel Settings



Opens the **Channel Settings** window for the track.

### Mute



Mutes the track.

### Solo



Solos the track.

### Read Automation



Allows you to read track automation.

### Write Automation



Allows you to write track automation.

### Input Transformer



Opens a pop-up menu that allows you to transform incoming MIDI events in real time.

### Record Enable



Activates the track for recording.

### Monitor



Routes incoming MIDI to the selected MIDI output. For this to work, activate **MIDI Thru Active** in the **Preferences** dialog (**MIDI** page).

### Toggle Time Base



Switches between musical (tempo-related) and linear (time-related) time base for the track.

### Lock



Disables all editing of all events on the track.

### Show Lanes



Divides the tracks in lanes.

### Volume



Allows you to adjust the level of the track.

### MIDI Pan



Allows you to adjust the MIDI panning of the track.

### Delay



Allows you to adjust the playback timing of the track.

### Load/Save/Reload Track Preset



Loads or saves a track preset or reverts the default presets.

### Input Routing



Allows you to specify the input bus for the track.

### Output Routing



Allows you to specify the output bus for the track.

### Channel



Allows you to specify the MIDI channel.

### Edit Instrument



Allows you to open the instrument panel.

### Bank Selector



Allows you to set a bank select message that is sent to your MIDI device.

### Programs

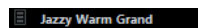

Allows you to select a program.

### Program Selector



Allows you to set a program change message that is sent to your MIDI device.

### Drum Maps

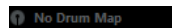

Allows you to select a drum map for the track.

#### RELATED LINKS

[Inspector Sections](#) on page 95

## Group Channel Tracks

You can use group channel tracks to create a submix of several audio channels and apply the same effects to them. A group channel track contains no events as such, but displays settings and automation for the corresponding group channel.

All group channel tracks are automatically placed in a special group track folder in the track list for easy management. Each group channel track has a corresponding channel in the **MixConsole**. A group channel track can have any number of automation tracks.

You can add group channel tracks via the **Add Track** dialog.

#### RELATED LINKS

[Add Track Dialog – Group Channel](#) on page 117

## Add Track Dialog – Group Channel

The **Group** page of the **Add Track** dialog allows you to set up and add group channel tracks.

To open the **Group** page of the **Add Track** dialog, do one of the following:

- Click **Add Track**  in the global track controls area of the track list, and click **Group**. This opens the global **Add Track** dialog on the **Group** page.

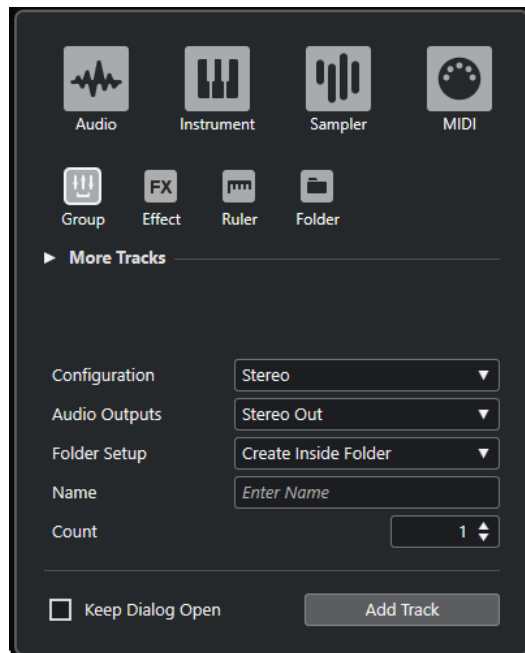

- Select **Project > Add Track > Group**.  
This opens only the **Group** page of the **Add Track** dialog.

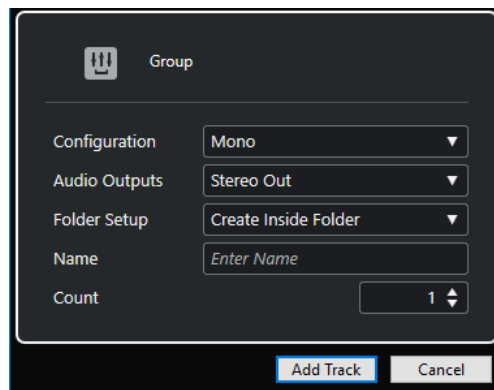

The following settings are available:

### Configuration

Allows you to set the channel configuration. Audio-related tracks can be configured as mono or stereo tracks.

### Audio Outputs

Allows you to set the output routing.

### Folder Setup

Allows you to select whether you want to create the effect inside or outside a dedicated folder.

### Name

Allows you to specify a track name.

### Count

Allows you to enter the number of tracks that you want to add.

### Keep Dialog Open

Activate this to keep the dialog open after clicking **Add Track**. This allows you to click the page of another track type to set up and add more tracks.

**NOTE**

This is only available if you open the **Add Track** dialog from the global track controls.

**Add Track**

Adds one or more tracks, according to the track type and settings of the active page, and closes the dialog.

## Group Channel Track Inspector

The **Inspector** for group channel tracks shows the settings for the group channel.



**Track name**

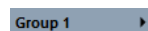

Click once to show/hide the basic track settings section. Double-click to rename the track.

**Colorize Selected Track**



Allows you to colorize the selected track.

**Edit Channel Settings**



Opens the **Channel Settings** window for the track.

**Mute**



Mutes the track.

**Solo**



Solos the track.

**Read Automation**



Allows you to read track automation.

**Write Automation**



Allows you to write track automation.

**Toggle Time Base**



Switches between musical (tempo-related) and linear (time-related) time base for the track.

**Lock**



Disables all editing of all events on the track.

### Volume

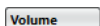

Allows you to adjust the level of the track.

### Pan



Allows you to adjust the panning of the track.

### Output Routing



Allows you to specify the output bus for the track.

### NOTE

When you select the group folder track instead, the **Inspector** shows the folder and the group channels it contains. You can click one of the group channels shown in the folder to have the **Inspector** show the settings for that group channel.

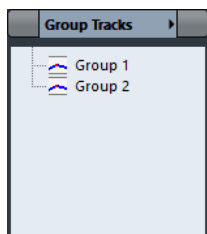

### RELATED LINKS

[Inspector Sections](#) on page 95

## FX Channel Tracks

You can use FX channel tracks for adding send effects. Each FX channel can contain up to eight effect processors. By routing sends from an audio channel to an FX channel, you send audio from the audio channel to the effects on the FX channel. You can place FX channel tracks in a special FX channel folder, or in the track list, outside an FX channel folder. Each FX channel has a corresponding channel in the **MixConsole**. An FX channel track can have any number of automation tracks.

You can add FX channel tracks via the **Add Track** dialog.

### RELATED LINKS

[Add Track Dialog – Effect](#) on page 120

## Add Track Dialog – Effect

The **Effect** page of the **Add Track** dialog allows you to set up and add FX channel tracks.

To open the **Effect** page of the **Add Track** dialog, do one of the following:

- Click **Add Track**  in the global track controls area of the track list, and click **Effect**. This opens the global **Add Track** dialog on the **Effect** page.



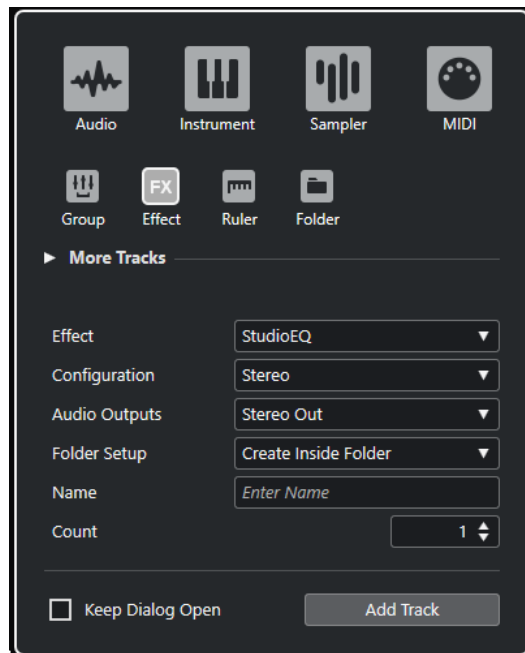

- Select **Project > Add Track > Effect**.  
This opens only the **Effect** page of the **Add Track** dialog.

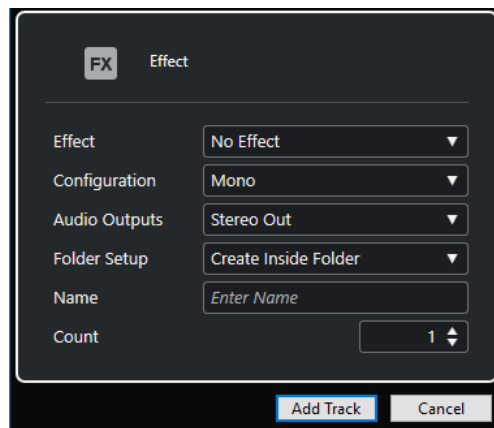

The following settings are available:

#### **Effect**

Allows you to select an effect.

#### **Configuration**

Allows you to set the channel configuration. Audio-related tracks can be configured as mono or stereo tracks.

#### **Audio Outputs**

Allows you to set the output routing.

#### **Folder Setup**

Allows you to select whether you want to create the effect inside or outside a dedicated folder.

#### **Name**

Allows you to specify a track name.

#### **Count**

Allows you to enter the number of tracks that you want to add.

### Keep Dialog Open

Activate this to keep the dialog open after clicking **Add Track**. This allows you to click the page of another track type to set up and add more tracks.

#### NOTE

This is only available if you open the **Add Track** dialog from the global track controls.

### Add Track

Adds one or more tracks, according to the track type and settings of the active page, and closes the dialog.

#### RELATED LINKS

[Adding FX Channel Tracks on page 370](#)

[Adding FX Channels to Selected Channels on page 370](#)

## FX Channel Track Inspector

The **Inspector** for FX channel tracks shows the settings for the FX channel. When you select the folder track instead, the **Inspector** shows the folder and the FX channels it contains. You can click one of the FX channels shown in the folder to have the **Inspector** show the settings for that FX channel.

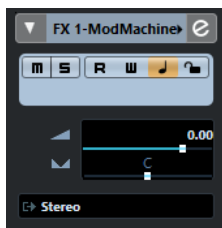

### Track name

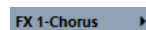

Click once to show/hide the basic track settings section. Double-click to rename the track.

### Colorize Selected Track



Allows you to colorize the selected track.

### Edit Channel Settings



Opens the **Channel Settings** window for the track.

### Mute



Mutes the track.

### Solo



Solos the track.

### Read Automation



Allows you to read track automation.

### Write Automation



Allows you to write track automation.

### Toggle Time Base



Switches between musical (tempo-related) and linear (time-related) time base for the track.

### Lock



Disables all editing of all events on the track.

### Volume

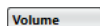

Allows you to adjust the level of the track.

### Pan



Allows you to adjust the panning of the track.

### Output Routing



Allows you to specify the output bus for the track.

#### RELATED LINKS

[Inspector Sections](#) on page 95

## Ruler Track

You can use ruler tracks to show several rulers with different display formats for the timeline. This is completely independent from the main ruler, as well as rulers and position displays in other windows.

You can add ruler tracks via the **Add Track** dialog.

#### RELATED LINKS

[Add Track Dialog – Ruler](#) on page 123

## Add Track Dialog – Ruler

The **Ruler** page of the **Add Track** dialog allows you to set up and add ruler tracks.

To open the **Ruler** page of the **Add Track** dialog, do one of the following:

- Click **Add Track**  in the global track controls area of the track list, and click **Ruler**. This opens the global **Add Track** dialog on the **Ruler** page.

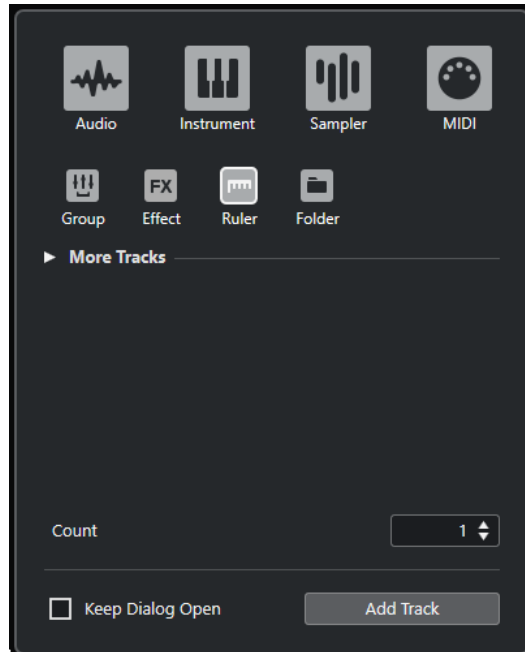

- Select **Project > Add Track > Ruler**.  
This opens only the **Ruler** page of the **Add Track** dialog.

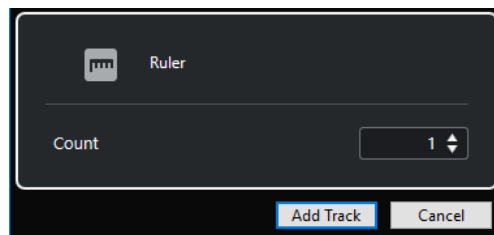

The following settings are available:

#### Count

Allows you to enter the number of tracks that you want to add.

#### Keep Dialog Open

Activate this to keep the dialog open after clicking **Add Track**. This allows you to click the page of another track type to set up and add more tracks.

#### NOTE

This is only available if you open the **Add Track** dialog from the global track controls.

#### Add Track

Adds one or more tracks, according to the track type and settings of the active page, and closes the dialog.

## Ruler Track Controls

In the track list for ruler tracks, you can change the display format for the ruler.

Click the display format to open a pop-up menu.

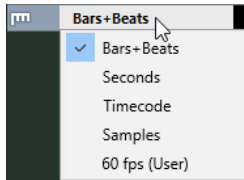

The following display formats are available:

#### **Bars+Beats**

Activates a display format of bars, beats, sixteenth notes, and ticks. By default there are 120 ticks per sixteenth note. To adjust this, change the **MIDI Display Resolution** in the **Preferences** dialog (**MIDI** page).

#### **Seconds**

Activates a display format of hours, minutes, seconds, and milliseconds.

#### **Timecode**

Activates a display format of hours, minutes, seconds, and frames. The number of frames per second (fps) is set in the **Project Setup** dialog with the **Project Frame Rate** pop-up menu. To display subframes, activate **Show Timecode Subframes** in the **Preferences** dialog (**Transport** page).

#### **Samples**

Activates a display format of samples.

#### **fps (User)**

Activates a display format of hours, minutes, seconds, and frames, with a user-definable number of frames per second. To display subframes, activate **Show Timecode Subframes** in the **Preferences** dialog (**Transport** page). On the **Transport** page, you can also set the frame rate.

#### **NOTE**

Ruler tracks are not affected by the display format setting in the **Project Setup** dialog.

---

## Folder Tracks

Folder tracks function as containers for other tracks, making it easier to organize and manage the track structure. They also allow you to edit several tracks at the same time.

You can add folder tracks via the **Add Track** dialog.

#### RELATED LINKS

[Add Track Dialog – Folder](#) on page 125

## Add Track Dialog – Folder

The **Folder** page of the **Add Track** dialog allows you to set up and add folder tracks.

To open the **Folder** page of the **Add Track** dialog, do one of the following:

- Click **Add Track**  in the global track controls area of the track list, and click **Folder**. This opens the global **Add Track** dialog on the **Folder** page.

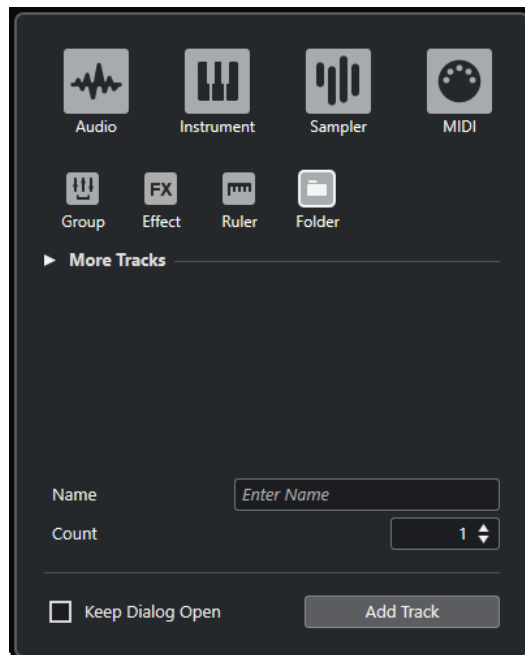

- Select **Project > Add Track > Folder**.  
This opens only the **Folder** page of the **Add Track** dialog.

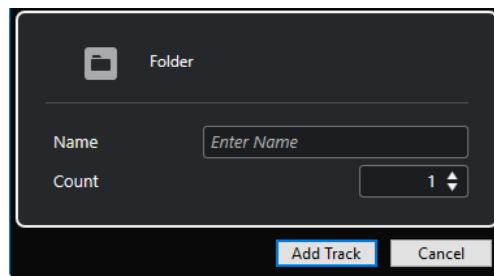

The following settings are available:

**Name**

Allows you to specify a track name.

**Count**

Allows you to enter the number of tracks that you want to add.

**Keep Dialog Open**

Activate this to keep the dialog open after clicking **Add Track**. This allows you to click the page of another track type to set up and add more tracks.

**NOTE**

This is only available if you open the **Add Track** dialog from the global track controls.

**Add Track**

Adds one or more tracks, according to the track type and settings of the active page, and closes the dialog.

## Folder Track Inspector

The **Inspector** for folder tracks shows the folder and its underlying track, much like a folder structure in the File Explorer/macOS Finder. When you select one of the tracks shown under the folder, the **Inspector** shows the settings for that track.



### Track name



Double-click to rename the track.

### Colorize Selected Track



Allows you to colorize the selected track.

### Mute



Mutes the track.

### Solo



Solos the track.

### Record Enable



Activates the track for recording.

### Monitor



For audio-related tracks, this routes incoming signals to the selected output.

For MIDI and instrument-related tracks, this allows you to route incoming MIDI signals to the selected MIDI output. For this to work, activate **MIDI Thru Active** in the **Preferences** dialog (**MIDI** page).

### Lock



Disables all editing of all events on the track.

### RELATED LINKS

[Inspector Sections](#) on page 95

## Folder Track Controls

The track list for folder tracks contains controls and parameters that allow you to edit all tracks in the folder.



### Expand/Collapse Folder

Shows/Hides the tracks in the folder. Hidden tracks are played back as usual.

### Track name



Double-click to rename the track.

### Mute



Mutes the track.

### Solo



Solos the track.

### Record Enable



Activates the track for recording.

### Monitor



For audio-related tracks, this routes incoming signals to the selected output.

For MIDI and instrument-related tracks, this allows you to route incoming MIDI signals to the selected MIDI output. For this to work, activate **MIDI Thru Active** in the **Preferences** dialog (**MIDI** page).

### Lock



Disables all editing of all events on the track.

## More Tracks

Some track types can only be added once.

- Tempo track
- Signature track
- Arranger track
- Transpose track
- Chord track
- Video track

### NOTE

- Marker track

## Arranger Track

You can use the arranger track for arranging your project by marking out sections and determining in which order they are to be played back.

- To add the arranger track to your project, select **Project > Add Track > Arranger**.



## Arranger Track Inspector

The arranger track **Inspector** displays the lists of available arranger chains and arranger events.

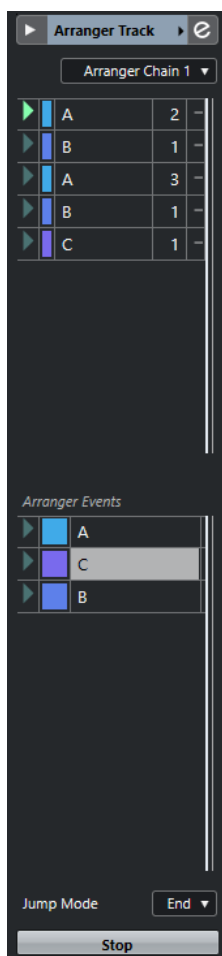

The arranger track **Inspector** contains the following settings:

### Track name

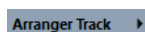

Double-click to rename the track.

### Colorize Selected Track



Allows you to colorize the selected track.

### Open Arranger Editor



Opens the **Arranger Editor**.

### Select Active Arranger Chain + Functions

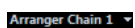

Allows you to select the active arranger chain, to rename it, to create a new one, to duplicate, or to flatten it.

### Current Arranger Chain

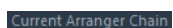

Shows the active arranger chain.

## Arranger Events

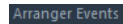

Lists all arranger events in your project. Click the arrow of an arranger event to play it back and start the live mode.

## Stop



Allows you to stop the live mode.

## Jump Mode

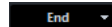

Allows you to define how long the active arranger event is played before jumping to the next one.

## Arranger Track Controls

The track list for the arranger track contains controls and parameters that allow you to edit the arranger track.

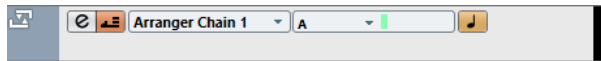

### Select Active Arranger Chain

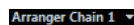

Allows you to select the active arranger chain.

### Current Item/Current Repeat



Displays which arranger event and which repeat is active.

### Activate Arranger Mode



Allows you to activate and deactivate the arranger mode.

### Toggle Time Base



Switches between musical (tempo-related) and linear (time-related) time base for the track.

### Open Arranger Editor



Opens the **Arranger Editor** for the track.

## Chord Track

You can use the chord track for adding chord and scale events to your project. These can transform the pitches of other events.

- To add the chord track to your project, select **Project > Add Track > Chord**.

## Chord Track Inspector

The chord track **Inspector** contains settings for the chord events.

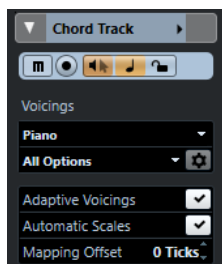

The top section of the chord track **Inspector** contains the following settings:

### Track name

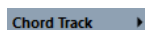

Click to show/hide the basic track settings section.

### Colorize Selected Track



Allows you to colorize the selected track.

### Mute Chord Track



Mutes the track.

### Record Enable



Activates the track for recording.

### Acoustic Feedback



Allows you to audition the events on the chord track. For this to work, you need to select a track for auditioning in the track list.

### Toggle Time Base



Switches between musical (tempo-related) and linear (time-related) time base for the track.

### Lock



Disables all editing of all events on the track.

### Voicing library



Allows you to set up a voicing library for the track.

### Voicing library subset

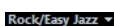

Allows you to select a library subset.

### Configure voicing parameters



Allows you to configure your own voicing parameters for a specific voicing scheme.

### Adaptive Voicings

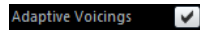

If this option is activated, the voicings are set automatically.

### Automatic Scales



If this option is activated, the program creates scale events automatically.

### Mapping Offset

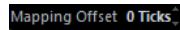

Allows you to specify an offset value to make sure that chord events also affect the MIDI notes that have been triggered too early (enter a negative value) or too late (enter a positive value).

#### RELATED LINKS

[Inspector Sections](#) on page 95

## Chord Track Controls

The track list for the chord track contains controls and parameters that allow you to edit the chord track.

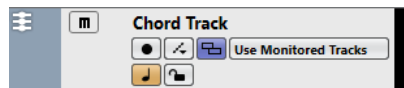

The track list for the chord track contains the following controls:

#### Name



Shows the name of the track. Double-click to rename the track.

#### Record Enable



Activates the track for recording.

#### Mute Chord Track



Mutes the track.

#### Select Track for Auditioning

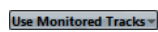

Allows you to select a track for auditioning the chord events.

#### Resolve Display Conflicts



Allows you to show all chord events on the track properly, even at low horizontal zoom levels.

#### Show Scales



Allows you to show the scale lane in the lower part of the chord track.

#### Lock



Disables all editing of all events on the track.

### Toggle Time Base



Switches between musical (tempo-related) and linear (time-related) time base for the track.

## Marker Track

You can use the marker track to add and edit markers that help you to locate certain positions quickly.

- To add the marker track to your project, select **Project > Add Track > Marker**.

## Marker Track Inspector

The marker track **Inspector** displays the marker list.

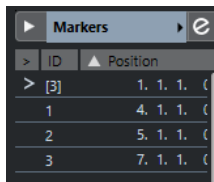

### Track name

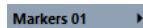

Double-click to rename the track.

### Colorize Selected Track



Allows you to colorize the selected track.

### Open Marker Window



Opens the **Markers** window.

### Marker attributes

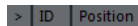

Shows the markers, their IDs, and their time positions. Click in the leftmost column for a marker to move the project cursor to the marker position.

### RELATED LINKS

[Inspector Sections](#) on page 95

## Marker Track Controls

The track list for the marker track contains controls and parameters that allow you to edit the marker track.



### Track name



Double-click to rename the track.

### Locate



Allows you to move the project cursor to the selected marker position.

### Cycle



Allows you to select a cycle marker.

### Zoom



Allows you to zoom in a cycle marker.

### Add Marker



Allows you to add a position marker at the project cursor position.

### Add Cycle Marker



Allows you to add a cycle marker at the project cursor position.

## Signature Track

You can use the signature track to add and edit signature events, and to set up click patterns for them. The signature track's background always shows bars. This is independent of the ruler display format setting.

- To add the signature track to your project, select **Project > Add Track > Signature**.

#### RELATED LINKS

[Time Signature Events](#) on page 792

[Click Patterns Tab](#) on page 225

## Signature Track Inspector

The signature track **Inspector** displays a list of all time signature events.

Bar	Sign.	Pattern
1	4/4	— — — —
3	3/4	— — —
6	4/4	— — — —

### Colorize Selected Track



Allows you to colorize the selected track.

### Bar

Shows the number of the bar where the signature event is positioned. Double-click the field and enter a new value to change the position of the signature event.

#### NOTE

The first signature event is always positioned at bar 1. You cannot change this.

### Sign.

Shows the value of the signature event. Double-click the field and enter a new value to change the time signature.

### Pattern

Shows the click pattern that is used. Double-click the field to open the **Click Pattern Editor** where you can change the pattern.

RELATED LINKS

[Click Pattern Editor](#) on page 219

## Signature Track Controls

The track list for the signature track contains controls and parameters that allow you to edit the signature track.



### Lock



Disables all editing of all events on the track.

### Signature Track Options

- **Copy Click Pattern to Clipboard**  
Copies the click pattern of the selected signature event to the clipboard.
- **Paste Click Pattern to Selected Signatures**  
Pastes the click pattern from the clipboard to selected signature events.

**NOTE**

This only works if the selected signature events are equal.

---

- **Apply Click Pattern to Equal Signatures**  
Pastes the click pattern from the clipboard to signature events that are equal.

**NOTE**

For this you do not have to select the signature events first.

---

- **Reset Click Pattern to Default**  
Sets the click pattern of the selected signature event to default. If no signature event is selected, the click patterns of all signature events are set to default.
- **Show Click Patterns**  
Allows you to show/hide the click patterns for the signature events.
- **Render MIDI Click between Locators**  
Adds a MIDI track to your project and creates a MIDI part containing the click pattern between the left and right locator.
- **Render Audio Click between Locators**  
Adds an audio track to your project and creates an audio event containing the click pattern between the left and right locator.

RELATED LINKS

[Click Patterns Tab](#) on page 225

## Tempo Track

You can use the tempo track to create tempo changes within a project.

- To add a tempo track to your project, select **Project > Add Track > Tempo**.

## Tempo Track Inspector

The tempo track **Inspector** displays a list of all tempo events.



Position	Tempo	Type
1. 1. 1. 0	105.000	Ju
3. 1. 1.102	100.000	Ju
3. 3. 3. 66	65.000	Ju
7. 2. 1. 85	150.000	Ra

### Colorize Selected Track



Allows you to colorize the selected track.

### Open Tempo Track Editor



Opens the **Tempo Track Editor**.

### Tempo event list



Shows a list of all tempo events that allows you to edit tempo events and their positions.

## Tempo Track Controls

The track list for the tempo track contains controls and parameters that allow you to edit the tempo track.

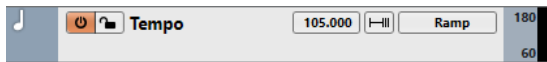

### Activate Tempo Track



Allows you to activate the tempo track. In this mode, the tempo cannot be changed on the **Transport** panel.

### Lock



Disables all editing of all events on the track.

### Current Tempo



Allows you to change the tempo at the project cursor position.

### Open Process Tempo Dialog



Allows you to open the **Process Tempo** dialog.

### New Tempo Points Type

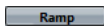

Allows you to specify whether the tempo should change gradually (**Ramp**) or instantly (**Jump**) from the previous curve point to the new one.

### Visible Tempo Upper Limit/Visible Tempo Lower Limit



Allows you to specify the display range. This changes the display scale of the tempo track, but not the tempo setting.



## Transpose Track

You can use the transpose track to set global key changes.

- To add the transpose track to your project, select **Project > Add Track > Transpose**.

### Transpose Track Inspector

The transpose track **Inspector** contains parameters to control the transpose track.

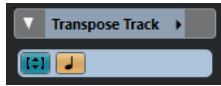

#### Colorize Selected Track



Allows you to colorize the selected track.

#### Keep Transpose in Octave Range



Allows you to keep the transposition in the octave range and ensures that nothing is transposed by more than seven semitones.

#### Toggle Time Base



Switches between musical (tempo-related) and linear (time-related) time base for the track.

### Transpose Track Controls

The track list for the transpose track contains parameters that allow you to control the transpose track.



#### Mute Transpose Events



Mutes the track.

#### Keep Transpose in Octave Range



Allows you to keep the transposition in the octave range and ensures that nothing is transposed by more than seven semitones.

#### Toggle Time Base



Switches between musical (tempo-related) and linear (time-related) time base for the track.

#### Lock



Disables all editing of all events on the track.

## Video Track

You can use the video track to play back video events. Video files are displayed as events/clips on the video track, with thumbnails representing the frames in the film.

- To add a video track, select **Project > Add Track > Video**.

## Video Track Inspector

The video track **Inspector** contains parameters to control the video track.

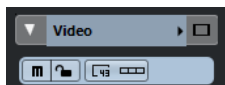

### Colorize Selected Track



Allows you to colorize the selected track.

### Reveal Video Window



Opens the **Video Player** window.

### Mute Video Track



Mutes the track.

### Lock



Disables all editing of all events on the track.

### Show Frame Numbers



Allows you to show each thumbnail with the corresponding video frame number.

### Show Thumbnails



Allows you to activate/deactivate the thumbnails of the video track.

### RELATED LINKS

[Inspector Sections](#) on page 95

## Video Track Controls

The track list for the video track contains parameters to control the video track.



### Mute Video Track



Mutes the track.

### Name



Shows the name of the track. Double-click to rename the track.

### Lock



Disables all editing of all events on the track.

### Show Thumbnails



Allows you to activate/deactivate the thumbnails of a video track.

**Show Frame Numbers**



Allows you to show each thumbnail with the corresponding video frame number.

# Track Handling

Tracks are the building blocks of your project. In Cubase, events and parts are placed on tracks.

## Adding Tracks via the Add Track Dialog

You can add tracks via the **Add Track** dialog.

---

### PROCEDURE

1. In the global track controls area of the track list, click **Add Track** .
2. Do one of the following:
  - Click the track type and set up the options according to your needs.
  - To add track types that can only be added once, open the **More Tracks** section and click the track type.
3. Click **Add Track**.

---

### RESULT

The new track is added to the project below the selected track.

### RELATED LINKS

- [Add Track Dialog – Audio](#) on page 103
- [Add Track Dialog – Instrument](#) on page 107
- [Add Track Dialog – Sampler](#) on page 111
- [Add Track Dialog – MIDI](#) on page 114
- [Add Track Dialog – Effect](#) on page 120
- [Add Track Dialog – Group Channel](#) on page 117
- [Marker Track](#) on page 133
- [Add Track Dialog – Ruler](#) on page 123
- [Add Track Dialog – Folder](#) on page 125
- [Arranger Track](#) on page 128
- [Chord Track](#) on page 130
- [Signature Track](#) on page 134
- [Tempo Track](#) on page 135
- [Transpose Track](#) on page 137
- [Video Track](#) on page 137

## Adding Tracks Using Track Presets

You can add tracks based on track presets. Track presets contain sound and channel settings.

---

### PROCEDURE

1. In the global track controls area of the track list, click **Use Track Preset** .

2. Select **Using Track Preset**.
  3. In the **Choose Track Preset** dialog, select a track preset.  
The number and type of the added tracks depend on the selected track preset.
  4. Click **OK**.
- 

#### RESULT

The new tracks are added to the project below the selected track.

#### RELATED LINKS

[Track Presets](#) on page 162

## Adding Tracks by Dragging Files from the MediaBay

You can add tracks by dragging files from the **MediaBay**.

#### PREREQUISITE

One of the following prerequisites must apply:

- The **MediaBay** is open. To open the **MediaBay**, press **F5**.
  - The **Media** rack in the right zone of the **Project** window is open. Click **Show/Hide Right Zone** and click the **Media** tab to open it.
- 

#### PROCEDURE

1. In the **MediaBay**, select the files for which you want to add tracks.
  2. Drag the files into the track list.
    - The indicator highlights the position at which the new tracks will be added.
    - If you drag multiple audio files into the track list, choose if you want to place all files on one track or on different tracks.
    - If you drag multiple audio files into the track list, the **Import Options** dialog opens that allows you to edit the import options.
- 

#### RESULT

The new tracks are added at the position that was highlighted by the indicator in the track list. The audio files are inserted at the cursor position.

#### RELATED LINKS

[MediaBay and Media Rack](#) on page 494

[Media Rack in Right Zone](#) on page 494

[Import Options Dialog for Audio Files](#) on page 252

## Exporting MIDI Tracks as Standard MIDI Files

You can export MIDI tracks as standard MIDI files. This allows you to transfer MIDI material to virtually any MIDI application on any platform.

#### PROCEDURE

1. Select **File > Export > MIDI File**.
2. In the file dialog that opens, specify a location and name for the file.
3. Click **Save**.

4. In the **Export Options** dialog, activate the options for the settings that you want to export, and click **OK**.

---

#### RESULT

The MIDI file is exported. It includes the tempo and time signature events of the **Tempo Track Editor** or, if the tempo track is deactivated on the **Transport** panel, the current tempo and time signature.

#### NOTE

If you want to include other **Inspector** settings than those specified in the **Export Options**, use **Merge MIDI in Loop** to convert these settings to real MIDI events.

---

#### RELATED LINKS

[Export Options Dialog for MIDI Files](#) on page 142

[Merging MIDI Events into a New Part](#) on page 609

## Export Options Dialog for MIDI Files

The **Export Options** for MIDI files allow you to specify what data is included in the exported MIDI files.

- To open the **Export Options** for MIDI files, select **File > Export > MIDI File**.

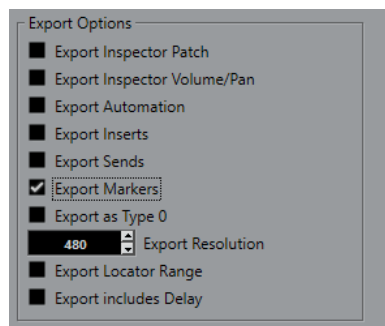

### Export Inspector Patch

Includes MIDI patch settings in the **Inspector** as MIDI bank select and program change events in the MIDI file.

### Export Inspector Volume/Pan

Includes volume and pan settings in the **Inspector** as MIDI volume and pan events in the MIDI file.

### Export Automation

Includes automation as MIDI controller events in the MIDI file. This also includes automation recorded with the **MIDI Control** plug-in.

If you record a continuous controller (CC7, for example) and deactivate **Read Automation** for the automation track, only the part data for this controller is exported.

### Export Inserts

Includes MIDI modifiers and MIDI inserts in the MIDI file.

### Export Sends

Includes MIDI sends in the MIDI file.

### Export Markers

Includes markers as standard MIDI file marker events in the MIDI file.

### Export as Type 0

Exports a type 0 MIDI file with all data on a single track, but on different MIDI channels. If you deactivate this option, a type 1 MIDI file with data on separate tracks is exported.

### Export Resolution

Allows you to set a MIDI resolution between 24 and 960 for the MIDI file. The resolution is the number of pulses, or ticks, per quarter note (PPQ) and determines the precision with which you will be able to view and edit the MIDI data. The higher the resolution, the higher the precision. The resolution should be chosen depending on the application or sequencer with which the MIDI file will be used, because certain applications and sequencers may not be able to handle certain resolutions.

### Export Locator Range

Exports only the range between the left and right locator.

### Export includes Delay

Includes delay settings you have made in the **Inspector** in the MIDI file.

#### RELATED LINKS

[Automation](#) on page 535

[Markers](#) on page 300

[MIDI Track Parameters](#) on page 591

[Merging MIDI Events into a New Part](#) on page 609

[Export Options](#) on page 899

## Removing Selected Tracks

You can remove selected tracks from the track list.

---

#### PROCEDURE

- Select **Project > Remove Selected Tracks**.  
If you delete tracks that are not empty, a warning message is displayed.

#### NOTE

You can deactivate this message. To reactivate the message, activate **Display Warning before Deleting Non-Empty Tracks** in the **Preferences** dialog (**Editing** page).

---

## Removing Empty Tracks

You can remove empty tracks from the track list.

---

#### PROCEDURE

- Select **Project > Remove Empty Tracks**.
- 

## Moving Tracks in the Track List

You can move tracks up or down in the track list.

---

#### PROCEDURE

- Select a track and drag it up or down in the track list.
-

## Renaming Tracks

You can rename tracks.

---

### PROCEDURE

1. Double-click the track name and type in a new name for the track.
2. Press **Return**.  
If you want all events on the track to get the same name, hold down any modifier key and press **Return**.

---

### AFTER COMPLETING THIS TASK

If the **Parts Get Track Names** option is activated in the **Preferences** dialog (**Editing** page), and you move an event from one track to another, the moved event will automatically be named according to its new track.

## Automatically Assigning Colors to New Tracks/Channels

You can automatically assign colors to newly added tracks or channels.

---

### PROCEDURE

1. Select **Edit > Preferences**.
2. Open the **User Interface** page, and select **Track & MixConsole Channel Colors**.
3. Open the **Auto Track/Channel Color Mode** pop-up menu and select an option.
4. Click **OK**.

---

### RESULT

Any tracks/channels that you added by using **Add Track**, or by dragging files from the **Media** rack to the event display are automatically colored according to your settings.

### RELATED LINKS

[User Interface - Track & MixConsole Channel Colors](#) on page 906

## Showing Track Pictures

You can add pictures to tracks to recognize your tracks easily. Track pictures are available for audio, instrument, MIDI, FX channel and group channel tracks.

### PREREQUISITE

Adjust the track height to at least 2 rows.

---

### PROCEDURE

1. Right-click any track in the track list.
2. From the track list context menu, select **Show Track Pictures**.

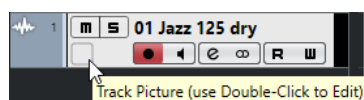

If you move the mouse to the left on a track, a highlighted rectangle appears.

---

### AFTER COMPLETING THIS TASK

Double-click the rectangle to open the **Track Pictures Browser** and set up a track picture.



RELATED LINKS

[Track Pictures Browser](#) on page 145

## Track Pictures Browser

The **Track Pictures Browser** allows you to set up and select pictures that can be shown in the track list and in the **MixConsole**. Track pictures are useful to recognize tracks and channels easily. You can select pictures from the factory content or add new ones to the user library.

- To open the **Track Pictures Browser** for a track, double-click in the lower left side of the track list.



### Factory

Shows the factory content in the pictures browser.

### Pictures browser

Shows the pictures that you can assign to the selected track/channel.

### User

Shows your user content in the pictures browser.

### Import

Opens a file dialog that allows you to select pictures in bmp, jpeg, or png format and add them to the user library.

### Remove Selected Pictures from User Library

Removes the selected pictures from the user library.

### Reset Current Picture

Removes the picture from the selected track/channel.

### Show Preview/Hide Preview

Opens/Closes a section with further color and zoom settings.

### Track Picture Preview

Shows the current track picture. When you zoom in the picture, you can drag it with the mouse to change its visible part.

### Track Color

Opens the **Color Picker** that allows you to select a track color.

### Intensity

Allows you to apply the track color to the track picture and set the color intensity.

### Zoom

Allows you to change the size of the track picture.

### Rotate

Allows you to rotate the track picture.

## Setting the Track Height

You can enlarge the track height to show the events on the track in detail, or you can decrease the height of several tracks to get a better overview of your project.

- To change the height of an individual track, click its lower border in the track list and drag up or down.
- To change the height of all tracks simultaneously, hold down **Ctrl/Cmd**, click the lower border of one track, and drag up or down.
- To set the number of tracks to view in the **Project** window, use the track zoom menu.
- To set the track height automatically when you select a track, click **Edit > Enlarge Selected Track**.

#### RELATED LINKS

[Track Zoom Menu](#) on page 146

[Track Controls Settings Dialog](#) on page 97

## Track Zoom Menu

The track zoom menu allows you to set the number of tracks and the track height in the **Project** window.

- To open the track zoom menu in the lower right of the **Project** window, click the arrow button above the vertical zoom control.

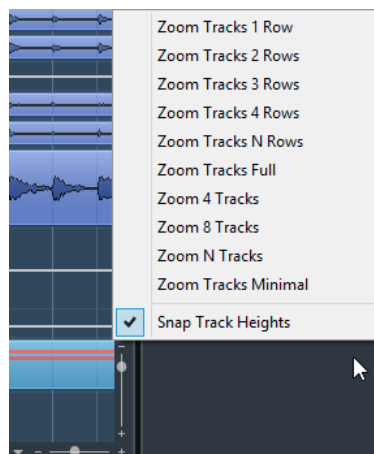

The following options are available:

### Zoom Tracks x Rows

Zooms all track heights to show the specified number of rows.

### Zoom Tracks Full

Zooms all tracks to fit in the active **Project** window.

### **Zoom Tracks N Rows**

Allows you to set the number of rows to fit in the active **Project** window.

### **Zoom x Tracks**

Zooms the specified number of tracks to fit in the active **Project** window.

### **Zoom N Tracks**

Allows you to set the number of tracks to fit in the active **Project** window.

### **Zoom Tracks Minimal**

Zooms all track heights to the minimum size.

### **Snap Track Heights**

Changes the track height in fixed increments when you resize it.

## Selecting Tracks

You can select one or multiple tracks in the track list.

- To select a track, click on it in the track list.
- To select several tracks, **Ctrl/Cmd**-click several tracks.
- To select a continuous range of tracks, **Shift**-click the first and last track in a continuous range of tracks.

Selected tracks are highlighted in the track list.

#### RELATED LINKS

[Track Selection Follows Event Selection](#) on page 889

[Scroll to Selected Track](#) on page 892

[Select Channel/Track on Solo](#) on page 892

[Select Channel/Track on Edit Settings](#) on page 892

## Selecting Tracks with Arrow Keys

You can select tracks and events with the **Up Arrow** key or the **Down Arrow** key on the computer keyboard. However, you can make the **Up Arrow** key and the **Down Arrow** key exclusively available for selecting tracks.

- To make the **Up Arrow** key and the **Down Arrow** key exclusively available for selecting tracks, activate **Use Up/Down Navigation Commands for Selecting Tracks Only** in the **Preferences** dialog (**Editing** page).

The following applies:

- If this option is deactivated and no event/part is selected in the **Project** window, the **Up Arrow** key and the **Down Arrow** key are used to step through the tracks in the track list.
- If this option is deactivated and an event/part is selected in the **Project** window, the **Up Arrow** key and the **Down Arrow** key still step through the tracks in the track list – but on the selected track, the first event/part will automatically be selected as well.
- If this option is activated, the **Up Arrow** key and the **Down Arrow** key are only used to change the track selection – the current event/part selection in the **Project** window is not altered.

## Deselecting Tracks

You can deselect tracks that are selected in the track list.

---

### PROCEDURE

- **Shift**-click a selected track.

---

### RESULT

The track is deselected.

## Duplicating Tracks

You can duplicate a track with all contents and channel settings.

---

### PROCEDURE

- Select **Project > Duplicate Tracks**.

---

### RESULT

The duplicated track appears below the original track.

## Disabling Tracks

You can disable audio, instrument, MIDI, and sampler tracks that you do not want to play back or process at the moment. Disabling a track zeroes its output volume and shuts down all disk activity and processing for the track.

---

### PROCEDURE

- Right-click in the track list and select **Disable Track** from the context menu.

---

### RESULT

The track color changes and the corresponding channel in the **MixConsole** is hidden.

To enable a disabled track and restore all channel settings, right-click in the track list and select **Enable Track**.

## Organizing Tracks in Folder Tracks

You can organize your tracks in folders by moving tracks into folder tracks. This allows you to perform editing on several tracks as one entity. Folder tracks can contain any type of track including other folder tracks.

- To add a folder track, click **Add Track** in the global track controls area of the track list, and click **Folder**.
- To add a folder track and move all selected tracks into it, open the **Project** menu and from the **Track Folding** submenu select **Move Selected Tracks to New Folder**.
- To move tracks into a folder, select them and drag them into the folder track.
- To remove tracks from a folder, select them and drag them out of the folder.
- To hide/show tracks in a folder, click the **Expand/Collapse Folder** button of the folder track.
- To hide/show data on a folder track, open the context menu for the folder track and select an option from the **Show Data on Folder Tracks** submenu.

- To mute/solo all tracks in a folder track, click the **Mute** or **Solo** button for the folder track.

#### NOTE

Hidden tracks are played back as usual.

---

## Moving Tracks to Folder Tracks

You can move your tracks to folder tracks to organize them and to perform editing on several tracks as one entity. You can move any type of track including other folder tracks to folder tracks.

---

#### PROCEDURE

- Select **Project > Track Folding > Move Selected Tracks to New Folder**.

---

#### RESULT

This creates a new folder and moves all selected tracks into it.

#### NOTE

You can also drag and drop tracks into or out of a folder track.

---

#### RELATED LINKS

[Folder Tracks](#) on page 125

## Handling Overlapping Audio

The basic rule for audio tracks is that each track can only play back a single audio event at a time. If two or more events overlap, only the one that is in front is played back. You can, however, select the event/region that you want to play back.

---

#### PROCEDURE

- Do one of the following:
  - Right-click the audio event in the event display and select the desired event or region from the **To Front** or **Set to Region** submenu.

#### NOTE

The available options depend on whether you performed a linear or a cycle recording and the record mode you used. When recording audio in cycle mode, the recorded event is divided in regions, one for each take.

- 
- Click the middle handle on the lower border of a stacked event and select an entry from the pop-up menu.
  - In the track list, activate **Show Lanes** and select the desired take.
- 

#### RELATED LINKS

[Lanes, Takes and Overlapping Events](#) on page 151

## Track Folding Menu

You can show, hide, or invert tracks that are displayed in the **Project** window event display. This allows you to divide the project into several parts by creating several folder tracks for the

different project elements and showing/hiding their contents by selecting a menu function or using a key command. You can also fold in automation tracks this way.

- To open the **Track Folding** menu, select **Project > Track Folding**.

The following options are available:

#### **Toggle Selected Track**

Reverses the fold state of the selected track.

#### **Fold Tracks**

Folds in all open folder tracks in the **Project** window.

##### **NOTE**

The behavior of this function depends on the **Deep Track Folding** setting in the **Preferences** dialog.

---

#### **Unfold Tracks**

Unfolds all folder tracks in the **Project** window.

##### **NOTE**

The behavior of this function depends on the **Deep Track Folding** setting in the **Preferences** dialog.

---

#### **Flip Fold States**

Flips the fold states of the tracks in the **Project** window. This means that all tracks that were folded in will be unfolded and all unfolded tracks will be folded in.

#### **Move Selected Tracks to New Folder**

Moves all selected tracks to the folder track. This menu option is available if at least one folder track is available.

##### **NOTE**

- You can assign key commands for these menu options in the **Key Commands** dialog in the **Project** category.
  - If you activate **Deep Track Folding** in the **Preferences** dialog (**Editing—Project & MixConsole** page), track folding is applied to all subelements of the tracks.
- 

## **Events Display on Folder Tracks**

Closed folder tracks can display data of the contained audio, MIDI, and instrument tracks as data blocks or as events.

When you close folder tracks, the contents of the contained tracks are displayed as data blocks or events. Depending on the folder track height, the display of the events can be more or less detailed.

## **Modifying Event Display on Folder Tracks**

You can modify the event display on folder tracks.

---

### **PROCEDURE**

1. Right-click the folder track.
2. On the context menu, select **Show Data on Folder Tracks**.

You have the following options:

- **Always Show Data**  
Displays data blocks or event details always.
- **Never Show Data**  
Displays nothing.
- **Hide Data When Expanded**  
Hides the display of events when you open folder tracks.
- **Show Event Details**  
Displays event details instead of data blocks.

**NOTE**

You can change these settings in the **Preferences** dialog (**Event Display—Folders** page).

---

RELATED LINKS

[Event Display - Folders](#) on page 895

## Lanes, Takes and Overlapping Events

In the following, we focus on cycle recordings with takes. However, you can also apply lane operations and comping methods on overlapping events or parts that you assemble on one track.

If you perform a cycle recording in the **Keep History** or **Cycle History + Replace** modes (audio) or in the **Stacked** or **Mix-Stacked** modes (MIDI), the recorded cycle laps are shown on the track with the last recorded take active and on top.

The **Show Lanes** mode gives you a good overview of all your takes. If you activate the **Show Lanes** button, the recorded takes are shown on separate lanes.

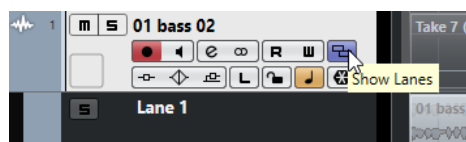

Lanes are handled differently, depending on whether you work with audio or MIDI:

### Audio

As each audio track can only play back one single audio event at a time, you only hear the take that is activated for playback, for example, the last lap of a cycle recording.

### MIDI

Overlapping MIDI takes (parts) can be played back simultaneously. If you recorded in **Mix-Stacked** mode, you hear all takes from all cycle laps.

Lanes can be reordered, sized, and zoomed like regular tracks.

To solo a lane, you can activate the **Solo** button for it. This allows you to hear the lane in the project context. If you want to hear the take without the project context, you also have to activate the main track's **Solo** button.

## Assembling a Perfect Take

You can play back, split, and activate takes to combine the best parts of your recording in a final take.

---

### PROCEDURE

1. Select the **Comp** tool or the **Object Selection** tool.
2. Bring a take to the front to select it for playback, and listen to it.
3. Audition different takes to compare them in more detail.
4. If necessary, split your takes into smaller sections, create new ranges, and bring them to the front.
5. Proceed until you are satisfied with the result.

---

### AFTER COMPLETING THIS TASK

After assembling your perfect take, you can improve your take.

- To automatically resolve overlaps and remove empty lanes, right-click the track and select **Clean Up Lanes**.

For audio, proceed as follows:

- Apply auto fades and crossfades to the comped takes.
- To put all takes on a single lane, and remove all takes in the background, select all takes and select **Audio > Advanced > Delete Overlaps**.
- To create a new and continuous event of all selected takes, select **Audio > Bounce Selection**.

For MIDI, proceed as follows:

- Open your takes in a MIDI editor to perform fine adjustments like removing or editing notes.
- To create a new and continuous part of all selected takes that is placed on a single lane, select all takes and select **MIDI > Bounce MIDI**.
- To create a new part and place it on a new track, select **MIDI > Merge MIDI in Loop**.

Finally, clean up the lanes as follows:

- Right-click a track and select **Create Tracks from Lanes**.  
The lane is converted into a new track.

## Assembling Operations

Unless otherwise stated, all operations can be performed in the **Project** window and in the **Audio Part Editor**. **Snap** is taken into account, and all operations can be undone.

To assemble a perfect take, you can use the **Comp** tool, the **Object Selection** tool, or the **Range Selection** tool.

- The **Comp** tool modifies all takes on all lanes simultaneously.  
This is useful if the recorded takes have the same start and end positions.
- The **Object Selection** tool and the **Range Selection** tool affect single takes on individual lanes.

If this is not what you want, you can either perform your edits on the main track or use the **Comp** tool.



NOTE

If you assemble stacked events on an audio track, deactivate **Treat Muted Audio Events like Deleted** in the **Preferences** dialog (**Editing—Audio** page).

You can perform the following operations:

**Assembling Operations**

Operation	Comp tool	Object Selection/Range Selection tool
Select ( <b>Project</b> window only)	Hold down <b>Shift</b> and click on a take.	Click on a take.
Bring to front	Click on a take. Click twice to toggle.	Position the mouse pointer over the middle of the lower border of a take until it changes to a <b>Comp</b> symbol, and click. Click twice to toggle.  For MIDI this mutes/unmutes a take.
Comping (create a new range and bring it to front, <b>Project</b> window only)	Click and drag on a lane. All takes are split at the range start and end.  If the audio takes are adjacent without gaps or fades and the material itself matches, the takes are merged within the range.	-
Audition	Press <b>Ctrl/Cmd</b> to activate the <b>Speaker</b> tool and click at the position where you want playback to start.	See left.
Move	Click and drag on the main track.	Click and drag on any lane.
Resize	Drag the resize handles. All takes with the same start and end positions are affected. Resizing is constrained to the end or start of the adjacent takes. This ensures that you do not create overlaps accidentally.	Drag the resize handles.
Correct timing (Slip Event)	Select a take, hold down <b>Alt-Shift</b> (the tool modifier for Slip Event) and drag with the mouse.	See left.

Operation	Comp tool	Object Selection/Range Selection tool
Split	<b>Alt</b> -click on a take. If you split a MIDI part and the split position intersects one or several MIDI notes, the result depends on the <b>Split MIDI Events</b> option in the <b>Preferences</b> dialog ( <b>Editing—MIDI</b> page).	See left.
Adjust splits	Position the mouse pointer over a split and drag to the left or to the right.	See left.
Gluing splits	Bring a new range to front.	Select a range spanning all the splits that you want to glue, and double-click.

RELATED LINKS

[Splitting Events](#) on page 181

## Defining the Track Time Base

The time base of a track determines if the events on a track are positioned to bars and beats (musical time base) or to the timeline (linear time base). Changing the playback tempo affects only the time position of events on tracks with a musical time base.

PROCEDURE

- In the track list, click **Toggle Timebase**  to change the time base.

RESULT

Musical time base is indicated by a note symbol:



Linear time base is indicated by a clock symbol:



NOTE

Switching between linear and musical time base results in a very small loss of positioning precision. Therefore, you should avoid switching repeatedly between the two modes.

RELATED LINKS

[Editing Tempo and Time Signature](#) on page 782

## Track Versions

Track versions allow you to create and manage multiple versions of events and parts on the same track.

Track versions are available for audio, MIDI, and instrument tracks. You can also have track versions of the chord track, the signature track, and the tempo track.

Track versions are useful for the following tasks:

- Starting new recordings from scratch.
- Comparing different takes and comps.
- Managing takes that were recorded in a multi-track recording.

### NOTE

Track versions are not available for automation tracks.

---

Track versions are included in track archives and project backups.

The track version key commands can be found in the **Track Versions** category of the **Key Commands** dialog.

## Track Versions Pop-Up Menu

The **Track Versions** pop-up menu is available for all track types that support track versions. It contains the most important functions for managing track versions and a track versions list.

- To open the **Track Versions** pop-up menu for a track, click the arrow to the right of the track name.



The following options are available:

### Track Version list

Lists all track versions of the track for which you opened the **Track Versions** pop-up menu and allows you to activate a track version.

### New Version

Creates a new, empty track version for all selected tracks.

### Duplicate Version

Creates a copy of the active track version for all selected tracks.

### Rename Version

Opens a dialog that allows you to change the track version name for the selected tracks.

### Delete Version

Deletes the active track version for all selected tracks. This is only available if the track has more than one track version.

### Select Tracks with Same Version ID

Selects all tracks that have a track version with the same ID.

## Track Versions Section

The **Track Versions** section in the **Inspector** allows you to view and manage track versions for a selected track. It is available for audio tracks, MIDI tracks, instrument tracks, the sampler track and the chord track.

- To open the **Track Versions** section for a track, select the track, and in the **Inspector**, click the **Track Versions** section.

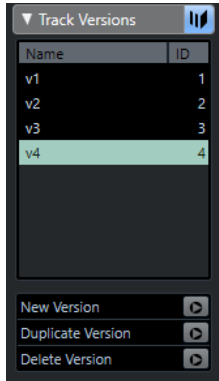

### Track Version Indicator

Indicates that more than one track version exists.

### Name

Shows the version name. Double-click to change it. The name will be changed for all selected tracks.

### ID

Shows the track version ID.

### Track Version list

Lists all track versions and allows you to activate one of them for all selected tracks.

### New Version

Creates a new, empty track version for all selected tracks.

### Duplicate Version

Creates a copy of the active track version for all selected tracks.

### Delete Version

Deletes the active track version for all selected tracks. This function is only available if the track has more than one track version.

## Creating New Track Versions

You can create new, empty track versions for selected tracks.

---

### PROCEDURE

1. In the track list, select the tracks for which you want to create a new track version.
2. Select **Project > Track Versions > New Version**.

### NOTE

You can also use the **Track Versions** section in the **Inspector** (only available for audio tracks, MIDI tracks, instrument tracks, and the chord track) or the **Track Versions** pop-up menu in the track list to create a new track version.

---

#### RESULT

The event display shows a new, empty track version. Events of previous track versions are hidden. The track list shows a default version name.

## Track Version IDs

All track versions are automatically assigned an ID. Track versions that are created together get the same track version ID and can be selected together.

In the **Track Versions** section in the **Inspector**, the track version ID is shown in the **ID** column of the track version list.

In the track list, you can open the **Track Versions** pop-up menu to see the track version ID.

## Selecting Tracks by Track Version ID

You can simultaneously select all tracks that share the same track version ID.

---

#### PROCEDURE

1. Activate the track version.
2. Select **Project > Track Versions > Select Tracks with Same Version ID**.

---

#### RESULT

All tracks that have track versions with the same ID are selected.

## Assigning a Common ID

Track versions on different tracks that were not created together have different track version IDs. Track versions with different IDs cannot be activated together. To do this, you must assign a new version ID to these tracks.

---

#### PROCEDURE

1. Select the tracks and activate the track versions to which you want to assign a common version ID.
2. Select **Project > Track Versions > Assign Common Version ID**.

---

#### RESULT

A new ID is assigned to all active track versions on the selected tracks. The tracks are now marked as belonging together. You can now activate them together.

## Active Track Version

If you created more than one track version for a track, you can show the events of a specific track version in the event display. This process is referred to as activating track versions.

## Activating Track Versions

You can activate one of your track versions. This also shows its events in the event display.

---

#### PROCEDURE

1. Click the arrow to the right of the track name to open the **Track Versions** pop-up menu.

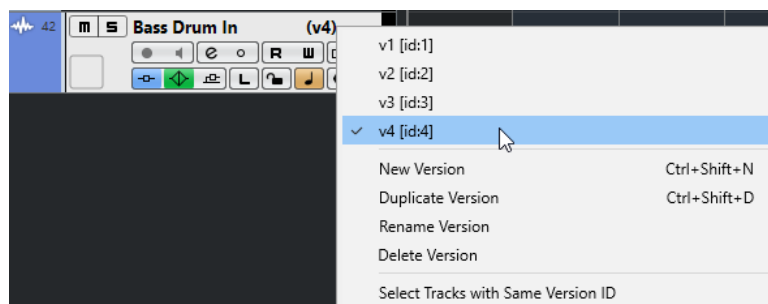

2. Select the track version that you want to activate.
- 

#### RESULT

The selected version is activated and its events are shown in the event display.

#### NOTE

If you work with audio tracks, MIDI tracks, instrument tracks, the sampler track or the chord track, you can also use the **Track Versions Inspector** to activate a track version.

---

## Activating Track Versions on Multiple Tracks

You can simultaneously activate track versions on multiple tracks if these track versions share the same ID.

---

#### PROCEDURE

1. Select all tracks for which you want to activate a specific track version.
  2. Click the arrow to the right of a track name to open the **Track Versions** pop-up menu.
  3. Select the track version that you want to activate from the list.
- 

#### RESULT

The selected track version is activated for all selected tracks, and the corresponding events are shown in the event display.

#### NOTE

If you work with audio tracks, MIDI tracks, instrument tracks, or the chord track, you can also use the **Track Versions Inspector** to activate a track version.

---

## Duplicating Track Versions

You can duplicate a track version by creating a new track version that contains a copy of the active track version.

---

#### PROCEDURE

1. In the track list, select the tracks and activate the track version that you want to duplicate.
2. Select **Project > Track Versions > Duplicate Version**.  
In the event display, a duplicate track version is displayed. In the track list, a default version name for the duplicate is shown.

**NOTE**

You can also use the **Track Versions Inspector** for audio tracks, MIDI tracks, instrument tracks, and chord tracks or the **Track Versions** pop-up menu in the track list to duplicate a track version.

---

## Deleting Track Versions

You can delete track versions that you no longer need.

---

**PROCEDURE**

1. Select the tracks and activate the track versions that you want to delete.
2. Select **Project > Track Versions > Delete Version**.

**NOTE**

You can also use the **Track Versions Inspector** for audio tracks, MIDI tracks, instrument tracks, and chord tracks or the **Track Versions** pop-up menu in the track list to delete the active track version for selected tracks.

---

## Copying and Pasting Selection Ranges Between Track Versions

You can copy and paste ranges between different track versions, even across multiple tracks.

**PREREQUISITE**

You have at least 2 track versions.

---

**PROCEDURE**

1. Select the **Range Selection** tool.
  2. Select a range of the track version that you want to copy.
  3. Select **Edit > Copy**.
  4. Activate the track version into which you want to insert the copied range.
  5. Select **Edit > Paste**.
- 

**RESULT**

The copied range from the first track version is pasted to the second track version at the exact same position.

**NOTE**

If you want to perform more complicated comping tasks, we recommend that you select **Project > Track Versions > Create Lanes from Versions** and proceed with the **Comp** tool.

---

## Copying and Pasting Selected Events between Track Versions

You can copy and paste selected events between different track versions, even across multiple tracks.

**PREREQUISITE**

You have at least 2 track versions, and you have split the corresponding events with the **Split** tool, for example.

#### PROCEDURE

1. Select the **Object Selection** tool.
  2. Select the events that you want to copy.
  3. Select **Edit > Copy**.
  4. Activate the track version into which you want to insert the copied events.
  5. Select **Edit > Functions > Paste at Origin**.  
This ensures that the events are inserted at the exact same position.
- 

#### RESULT

The copied events from the first track version are pasted to the second track version at the exact same position.

## Track Version Names

Each track version has a default track version name.

If more than one version is available for the track, the track version name is shown in the track list and in the **Track Versions** section in the **Inspector**. By default, track versions are named v1, v2, etc. However, you can rename each track version to your liking.

## Renaming a Track Version

You can rename track versions.

#### PROCEDURE

- In the **Track Versions** section in the **Inspector**, double-click the track version name and enter a new name.

The name is changed. If the available space in the track list is too small, the name is abbreviated automatically.

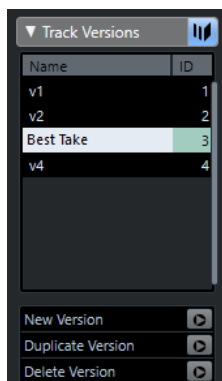

## Renaming Track Versions on Multiple Tracks

You can rename track versions on multiple tracks.

#### PROCEDURE

1. Activate all track versions that you want to rename, and select the corresponding tracks.
2. Select **Project > Track Versions > Rename Version**.
3. Enter a new track version name and click **OK**.



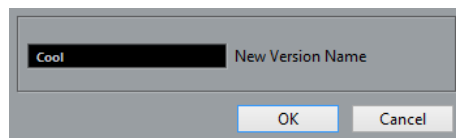

---

RESULT

In the track list, the new track version name is shown.

NOTE

If you want to assign the same ID to track versions, select **Project > Track Versions > Assign Common Version ID**.

---

## Track Versions vs. Lanes

Track versions and lanes are individual features that complement each other. Every track version can have its own set of lanes.

## Creating Lanes from Track Versions

If your project contains track versions and you want to continue working with lanes, using the **Comp** tool, for example, you can create lanes from track versions.

---

PROCEDURE

1. Select the tracks for which you want to create lanes.
  2. Select **Project > Track Versions > Create Lanes from Versions**.  
A new track version named **Lanes from Version** is added. This track version contains all track versions on separate lanes. The original track versions are kept. Lanes that you create from MIDI track versions are muted.
  3. In the track list or in the **Inspector**, activate the **Show Lanes** button for the track.
  4. On the **Project** window toolbar, activate the **Comp** tool and continue as usual.
- 

## Creating Track Versions from Lanes

If your project contains lanes and you want to continue working with the track version functions, you can create track versions from lanes.

---

PROCEDURE

1. Select the tracks for which you want to create track versions.  
If you only want to convert specific lanes, select these lanes.
  2. Select **Project > Track Versions > Create Versions from Lanes**.
- 

RESULT

New track versions are added, one for each separate lane. The original lanes are kept. Any crossfades that you have created between different lanes are discarded.

## Track Presets

Track presets are templates that can be applied to newly created or existing tracks of the same type.

You can create them from virtually all track types (audio, MIDI, instrument, sampler, group, FX, VST instrument return, input, and output channels). They contain sound and channel settings, and allow you to quickly browse, preview, select, and change sounds, or reuse channel settings across projects.

Track presets are organized in the **MediaBay**. There, you can categorize them with attributes.

When you apply a track preset, all the settings that are saved in the preset are applied.

Track presets can only be applied to tracks of their own type. The only exception are instrument tracks: for these, VST presets are also available.

### NOTE

- Once a track preset is applied, you cannot undo the changes. It is not possible to remove an applied preset from a track and return to the previous state. If you are not satisfied with the track settings, you have to either edit the settings manually or apply another preset.
  - Applying VST presets to instrument tracks leads to removal of modifiers, MIDI inserts, inserts, or EQs. These settings are not stored in VST presets.
- 

## Audio Track Presets

Track presets for audio tracks, group tracks, FX tracks, VST instrument channels, input channels, and output channels include all settings that define the sound.

You can use the factory presets as a starting point for your own editing and save the audio settings that you optimized for an artist that you often work with as a preset for future recordings.

The following data is saved in audio track presets:

- Insert effects settings (including VST effect presets)
- EQ settings
- Volume and pan
- Input gain and phase

### NOTE

To access the track presets functions for input and output channels, activate the **Write** buttons for input and output channels in the **MixConsole**. This creates input and output channel tracks in the track list.

---

## MIDI Track Presets

You can use MIDI track presets for multitimbral VST instruments.

When creating MIDI track presets, you can either include the channel or the patch.

The following data is saved in MIDI track presets:

- MIDI modifiers (Transpose, etc.)
- MIDI insert effects
- Output and Channel or Program Change
- Input Transformer settings

- Volume and pan
- Staff settings
- Color settings
- Drum map settings

## Creating a Track Preset

You can create a track preset from a single track or from a combination of tracks.

---

### PROCEDURE

1. In the **Project** window, select one or more tracks.
2. In the track list, right-click one of the selected tracks and select **Save Track Preset**.
3. In the **New Preset** section, enter a name for the new preset.

### NOTE

You can also define attributes for the preset.

4. Click **OK** to save the preset and exit the dialog.
- 

### RESULT

Track presets are saved within the application folder in the track presets folder. They are saved in default subfolders named according to their track type: audio, MIDI, instrument, and multi.

### RELATED LINKS

[Attribute Inspector](#) on page 524

## Loading Presets for Tracks

You can choose from a variety of track presets.

---

### PROCEDURE

1. In the **Inspector**, click the **Preset Management** icon on the right of the **Inserts** section.
  2. Select **From Track Preset**.
  3. In the **Results** browser, double-click a track preset to apply it.
- 

### RELATED LINKS

[Track Presets](#) on page 162

## Loading Presets for VST Instruments

When working with VST instruments, you can choose from a variety of presets via the **Results** browser.

---

### PROCEDURE

1. In the track list, right-click the instrument track and select **Load Track Preset**.
  2. In the **Results** browser, double-click a preset to apply it.
-

## Instrument Track Presets

Instrument track presets offer both MIDI and audio features and are the best choice when handling sounds of simple, mono-timbral VST instruments.

Use instrument track presets for auditioning your tracks or saving your preferred sound settings, for example. You can also extract sounds from instrument track presets for use in instrument tracks.

The following data is saved in instrument track presets:

- Audio insert effects
- Audio EQ
- Audio volume and pan
- Audio input gain and phase
- MIDI insert effects
- MIDI track parameters
- Input Transformer settings
- The VST instrument used for the track
- Staff settings
- Color settings
- Drum map settings

## VST Presets

VST instrument presets behave like instrument track presets. You can extract sounds from VST presets for use in instrument tracks.

The following data is saved in VST instrument presets:

- VST instrument
- VST instrument settings

### NOTE

Modifiers, inserts, and EQ settings are not saved.

---

VST effect plug-ins are available in VST 3 and VST 2 format.

### NOTE

In this manual, VST presets stands for VST 3 instrument presets, unless stated otherwise.

---

## Extracting the Sound from an Instrument Track or VST Preset

For instrument tracks, you can extract the sound of an instrument track preset or VST preset.

---

### PROCEDURE

1. Select the instrument track to which you want to apply a sound.
  2. In the **Inspector**, click **Extract Sound from Track Preset**.
  3. In the preset browser, select an instrument track preset or VST preset.
  4. Double-click the preset to load the settings.
-

#### RESULT

The VST instrument and its settings (but no inserts, EQs, or modifiers) on the existing track are overwritten with the data of the track preset. The previous VST instrument for this instrument track is removed and the new VST instrument with its settings is set up for the instrument track.

## Multi-Track Presets

You can use multi-track presets, for example, when recording setups that require several microphones (a drum set or a choir, where you always record under the same conditions), and you have to edit the resulting tracks in a similar way. Furthermore, they can be used when working with layered tracks, where you use several tracks to generate a certain sound instead of manipulating only one track.

If you select more than one track when creating a track preset, the settings of all selected tracks are saved as one multi-track preset. Multi-track presets can only be applied if the target tracks are of the same type, number, and sequence as the tracks in the track preset, therefore, they should be used in recurring situations with similar tracks and settings.

## Loading Multi-Track Presets

You can apply multi-track presets to several selected tracks.

---

#### PROCEDURE

1. In the **Project** window, select several tracks.

#### NOTE

Multi-track presets can only be applied if track type, number, and sequence are identical for the selected tracks and the track preset.

2. In the track list, right-click a track and select **Load Track Preset**.
3. In the preset browser, select a multi-track preset.
4. Double-click the preset to load it.

---

#### RESULT

The preset is applied.

## Sampler Track Presets

You can use sampler track presets to reuse created sounds in later projects or newly created sampler tracks.

The following data is saved in sampler track presets:

- Audio insert effects
- Audio EQ
- Audio volume and pan
- Audio input gain and phase
- MIDI insert effects
- MIDI track parameters
- Input Transformer settings
- Color settings

#### RELATED LINKS

[Sampler Tracks](#) on page 110

## Creating a Sampler Track Preset

You can create a sampler track preset from a sampler track or you can use the **Sampler Control** toolbar.

---

### PROCEDURE

1. In the **Sampler Control** toolbar, click **Preset Management** .
2. Click **Save Track Preset**.
3. In the **Save Track Preset** dialog, type in a name for the new preset.
4. Click **OK** to save the preset and exit the dialog.

---

### RESULT

The new sampler track preset is saved. It is displayed in the **Preset Name** field on the info line. Sampler track presets are saved within the application folder in the sampler track presets folder.

### RELATED LINKS

[Creating a Track Preset](#) on page 163

## Pattern Banks

Pattern banks are presets that are created for the **Beat Designer** MIDI effect.

They behave much like track presets.

### RELATED LINKS

[Pattern Banks Previewer](#) on page 519

[Track Presets](#) on page 162

## Loading Track or VST Presets

You can apply track or VST presets to selected tracks.

---

### PROCEDURE

1. In the **Project** window, select a track.
2. Do one of the following:
  - In the **Inspector**, click **Load Track Preset**.
  - In the track list, right-click the track and select **Load Track Preset**.
  - In the **Sampler Control** toolbar, click the **Preset Management** button next to the **Preset Name** field and select **Load Track Preset**.
3. In the preset browser, select a track, VST, or sampler track preset.
4. Double-click the preset to load it.

---

### RESULT

The preset is applied.

### NOTE

You can also drag and drop track presets from the **MediaBay** or the File Explorer/macOS Finder onto a track of the same type.

---

RELATED LINKS

[Filters Section](#) on page 520

## Loading Inserts and EQ from Track Presets

Instead of loading complete track presets, you can also apply insert or equalizer settings from track presets.

---

PROCEDURE

1. Select a track, open the **Inspector** or the **Channel Settings** window, and click the **Preset Management** button on the **Inserts** or **Equalizer** section.
  2. Select **From Track Preset**.
  3. In the preset browser, select a track preset.
  4. Double-click the preset to load the settings.
- 

## Track Quick Control Presets

For audio, instrument, MIDI, FX, and group tracks, you can save and load your own **Quick Control** assignments as presets or use the factory presets.

### Saving/Loading Track Quick Control Assignments as Presets

You can save track quick control assignment, as presets and load them later or in other projects.

---

PROCEDURE

1. In the **Inspector** for your track, open the **Quick Controls** section.  
For instrument tracks, the track quick controls are set to the 8 default VST quick controls of the loaded instrument by default.
2. Click **Preset Management** in the top right corner of the **Quick Controls** section and select one of the presets.

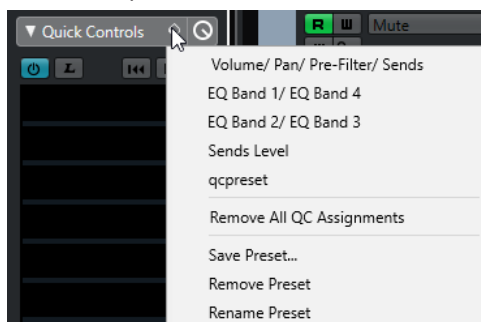

The **Track Quick Control** assignment changes and gives you access to the channel parameters.

**NOTE**

You can also make your own assignments and save them as presets, and delete, rename, or reset the presets to the default assignments.

---

# Parts and Events

Parts and events are the basic building blocks in Cubase.

## Events

In Cubase, most event types can be viewed and edited on their specific tracks in the **Project** window.

Events can be added by importing or recording.

RELATED LINKS

[Audio Regions](#) on page 170

[MIDI Events](#) on page 171

## Audio Events

Audio events are created automatically when you record or import audio in the **Project** window.

You can view and edit audio events in the **Project** window and in the **Sample Editor**.

An audio event triggers the playback of the corresponding audio clip. By adjusting the **Offset** and the **Length** values of the event, you can determine which section of the audio clip is played back. The audio clip itself remains unchanged.

RELATED LINKS

[Project Window](#) on page 30

[Sample Editor](#) on page 413

[Audio Files and Audio Clips](#) on page 169

[Basic Recording Methods](#) on page 230

## Creating Audio Events

You can create audio events by recording or importing audio into the **Project** window.

---

PROCEDURE

- Do one of the following:
  - Record some audio.
  - Select **File > Import > Audio File** to import an audio file from your hard disk or any external storage device.
  - Select **File > Import > Audio CD** to import an audio file from an audio CD.
  - Select **File > Import > Audio from Video File** to import the audio from a video file on your hard disk or any external storage device.
  - Drag an audio file from the **MediaBay**, the **Audio Part Editor**, or the **Sample Editor**, and drop it in the event display.



- Copy an event from a different Cubase project and paste it in the event display.
- 

#### RELATED LINKS

- [Basic Recording Methods](#) on page 230
- [Audio File Import](#) on page 251
- [Importing Audio CD Tracks](#) on page 254
- [Importing Audio from Video Files](#) on page 257
- [MediaBay and Media Rack](#) on page 494
- [Audio Part Editor](#) on page 452
- [Sample Editor](#) on page 413

## Creating New Files From Events

An audio event plays a section of an audio clip, which in turn refers to one or more audio files on the hard disk. However, you can create a new file that consists only of the section that is played by the event.

---

#### PROCEDURE

1. Select one or several audio events.
  2. Set up fade in, fade out, and event volume.  
These settings will be applied to the new file.
  3. Select **Audio > Bounce Selection**.  
You are asked whether you want to replace the selected event or not.
  4. Do one of the following:
    - To create a new file that only contains the audio in the original event, click **Replace**.
    - To create a new file and add a clip for the new file to the **Pool**, click **No**.
- 

#### RESULT

If you clicked **Replace**, a clip for the new file is added to the **Pool**, and the original event is replaced by a new event playing the new clip.

If you clicked **No**, the original event is not replaced.

#### NOTE

You can also apply the **Bounce Selection** function to audio parts. In that case, the audio from all events in the part is combined to a single audio file. If you select **Replace** when asked, the part is replaced with a single audio event playing a clip of the new file.

---

#### RELATED LINKS

- [Event-Based Fades](#) on page 271

## Audio Files and Audio Clips

In Cubase, audio editing and processing are non-destructive.

When you edit or process audio in the **Project** window, the audio file on the hard disk remains untouched. Instead, your changes are saved to an audio clip that is automatically created on import or during recording, and that refers to the audio file. This allows you to undo changes or revert to the original version.

If you apply processing to a specific section of an audio clip, a new audio file that contains only this section is created. The processing is applied to the new audio file only and the audio clip is automatically adjusted, so that it refers both to the original file and to the new, processed file. During playback, the program will switch between the original file and the processed file at the

correct positions. You will hear this as a single recording, with processing applied to one section only.

This allows you to undo processing at a later stage, and to apply different processing to different audio clips that refer to the same original file.

You can view and edit audio clips in the **Pool**.

RELATED LINKS

[Pool](#) on page 476

[Audio Regions](#) on page 170

[Replacing Clips in Events](#) on page 170

## Replacing Clips in Events

You can replace the clips in audio events.

---

PROCEDURE

- Do one of the following:
  - Hold down **Shift**, drag an audio file from the File Explorer/macOS Finder, and drop it on the event.
  - Click a clip in the **Pool**, hold down **Shift**, and drop it on the event.

---

RESULT

The clip in the event is replaced. However, the event edits remain unchanged. If the new clip is shorter than the replaced clip, the length of the event is adapted. If the new clip is longer than the replaced clip, the length of the event stays the same.

RELATED LINKS

[Inserting Clips into a Project via Drag and Drop](#) on page 482

## Audio Regions

Cubase allows you to create audio regions within audio clips to mark important sections in the audio.

You can view audio regions in the **Pool**. You can create and edit them in the **Sample Editor**.

NOTE

If you want to use one audio file in different contexts, or if you want to create several loops from one audio file, convert the corresponding regions of the audio clip to events and bounce them into separate audio files. This is necessary because different events that refer to the same clip access the same clip information.

---

RELATED LINKS

[Pool](#) on page 476

[Regions List](#) on page 429

## Creating Regions

You can create regions from several selected audio events or from selection ranges.

---

PROCEDURE

1. Select several audio events or selection ranges.
2. Select **Audio > Advanced > Event or Range as Region**.

3. In the **Create Regions** dialog, enter a name for the regions, and click **OK**.
- 

RESULT

A region is created in the corresponding clip, with the start and end position of the region determined by the start and end position of the event or selection range within the clip.

RELATED LINKS

[Creating Regions](#) on page 429

## Creating Events from Regions

You can create events from regions. These replace the original event.

---

PROCEDURE

1. Select an audio event whose clip contains regions within the boundaries of the event.
  2. Select **Audio > Advanced > Events from Regions**.
- 

RESULT

The original event is removed and replaced by events positioned and sized according to the regions.

## MIDI Events

MIDI events are created automatically when you record or import MIDI in the **Project** window.

The **In-Place Editor** allows you to view and edit MIDI events in the **Project** window. You can also view and edit MIDI events in the **Key Editor**, the **Drum Editor**, **List Editor**, or the **Score Editor**.

RELATED LINKS

[Project Window](#) on page 30

[In-Place Editor](#) on page 703

[List Editor](#) on page 689

[Key Editor](#) on page 638

[Drum Editor](#) on page 670

[Score Editor](#) on page 656

[Basic Recording Methods](#) on page 230

## Creating MIDI Events

You can create MIDI events by recording or importing MIDI into the **Project** window.

---

PROCEDURE

- Do one of the following:
    - Record MIDI.
    - Select **File > Import > MIDI File** to import a MIDI file from your hard disk.
    - Drag a MIDI file from the File Explorer/macOS Finder, from one of the MIDI editors, or from the **MediaBay**, and drop it in the event display.
    - Copy an event from a different Cubase project and paste it in the event display.
- 

RELATED LINKS

[Basic Recording Methods](#) on page 230

[Importing MIDI Files](#) on page 259

[MIDI Editors](#) on page 618  
[MediaBay and Media Rack](#) on page 494

## Parts

Parts are containers for MIDI or audio events, and for tracks.

### RELATED LINKS

[Audio Parts](#) on page 172  
[MIDI Parts](#) on page 172  
[Folder Parts](#) on page 172

## Audio Parts

Audio parts are containers for audio events. If you want to treat several audio events as one unit in the **Project** window, you can convert them to a part.

You can create audio parts in the following ways:

- Select the **Draw** tool and draw on the audio track.
- Press **Alt**, select the **Object Selection** tool, and draw on the audio track.
- Select the **Object Selection** tool and double-click on the audio track, between the left and right locator.
- Select several audio events on an audio track and select **Audio > Events to Part**.

### NOTE

To make the events appear as independent objects on the track again, select the part and select **Audio > Dissolve Part**.

---

### RELATED LINKS

[Audio Part Editor](#) on page 452

## MIDI Parts

A MIDI part is automatically created when you record. It contains the recorded events.

However, you can also create empty MIDI parts in the following ways:

- Select the **Draw** tool and draw on the MIDI track.
- Press **Alt**, select the **Object Selection** tool and draw on the MIDI track.
- Select the **Object Selection** tool and double-click on the MIDI track, between the left and right locator.

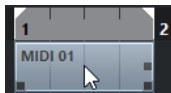

## Folder Parts

A folder part is a graphic representation of events and parts on the tracks in the folder.

Folder parts indicate the time position as well as the vertical track position. If part colors are used, these are also shown in the folder part.

Any editing that you perform to a folder part affects all the events and parts it contains. Tracks inside a folder can be edited as one entity.

NOTE

If you want to edit the individual tracks within the folder, you can double-click the folder part. This opens the editors for the events and parts that are present on the tracks.

---

RELATED LINKS

[Event Colors Menu](#) on page 619

## Editing Techniques for Parts and Events

This section describes techniques for editing in the **Project** window. If not explicitly stated, all descriptions apply to both events and parts, even though we use the term event for convenience.

In the **Project** window, you can edit events using the following techniques:

- By selecting and using one of the tools in the **Project** window toolbar.

NOTE

Some editing tools feature additional functions if you press modifier keys. You can customize the default modifier keys in the **Preferences** dialog (**Editing—Tool Modifiers** page).

---

- By opening the **Edit** menu and selecting one of the functions.
- By editing in the info line.
- By using a key command.

NOTE

**Snap** is taken into account.

---

RELATED LINKS

[Editing - Tool Modifiers](#) on page 892

## Auditioning Audio Parts and Events

You can audition audio parts and events in the **Project** window by using the **Audition** tool.

---

PROCEDURE

1. Click **Play** and select **Play**.
  2. Click where you want playback to start, and keep the mouse button pressed.
  3. Optional: Select **Media > MediaBay**, and in the **Previewer** section, adjust the **Preview Level**.
- 

RESULT

The track on which you click is played back, starting at the click position. Playback is stopped when you release the mouse button.

NOTE

When auditioning, the **Main Mix** bus is always used for monitoring.

---

RELATED LINKS

[Project Window Toolbar](#) on page 32  
[Previewer Section](#) on page 515

## Scrubbing

The **Scrub** tool allows you to locate positions in events by playing back, forwards or backwards.

---

### PROCEDURE

1. Click **Play**.
2. Click again to open a pop-up menu.
3. Select **Scrub**.
4. Click the event and keep the mouse button pressed.
5. Drag to the left or right.

---

### RESULT

The project cursor moves correspondingly and the event is played back. The speed and the pitch of the playback depend on how fast you move the mouse.

---

### NOTE

Insert effects are bypassed when scrubbing with the mouse.

---

### RELATED LINKS

[Project Window Toolbar](#) on page 32

## Scrub Tool

Scrubbing can be quite a burden on your system. If playback problems occur, open the **Preferences** dialog (**Transport—Scrub** page), and deactivate **Use High Quality Scrub Mode**. This lowers the resampling quality, but makes scrubbing less demanding on the processor, especially in large projects.

In the **Preferences** dialog (**Transport—Scrub** page), you can also adjust the **Scrub** volume.

## Selecting with the Object Selection Tool

---

### PROCEDURE

1. Click **Object Selection**.
2. In the event display, click the events that you want to select.

---

### NOTE

You can also use the **Up Arrow**, **Down Arrow**, **Left Arrow** or **Right Arrow** keys on the computer keyboard to select the event on the upper or lower track or the previous or next event on the same track.

---

### RELATED LINKS

[Project Window Toolbar](#) on page 32

## Combine Selection Tools Mode

The **Combine Selection Tools** mode allows you to combine the **Object Selection** tool and the **Range Selection** tool. This is useful in situations where you often switch between these tools.

If you activate **Combine Selection Tools**  on the **Project** window toolbar and the track height is set to at least 2 rows, the vertical track height of each track is divided into two areas. The mouse

pointer changes automatically from **Object Selection** to **Range Selection** tool and vice versa according to the track area where you click.

- If you move the mouse pointer to the upper area of the track, the **Range Selection** tool is activated, and you can select ranges that are independent from event and part boundaries.

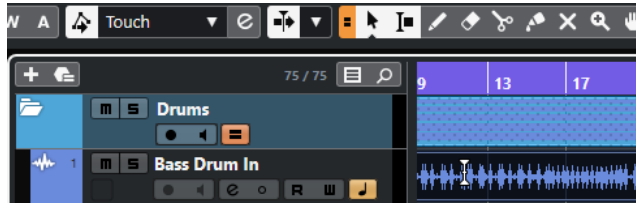

- If you move the mouse pointer to the lower area of the track, the **Object Selection** tool is activated, and you can select entire events or parts.

#### NOTE

You can also activate/deactivate the **Combine Selection Tools** mode by pressing **Alt-Shift-1**.

---

#### RELATED LINKS

[Project Window Toolbar](#) on page 32

[Setting the Track Height](#) on page 146

[Creating a Selection Range](#) on page 189

[Resizing Events with the Object Selection Tool - Normal Sizing](#) on page 179

[Resizing Events with the Object Selection Tool - Sizing Moves Contents](#) on page 179

[Resizing Events with the Object Selection Tool - Sizing Applies Time Stretch](#) on page 180

## Select Submenu

If the **Object Selection** tool is selected, the **Select** submenu features specific options for selecting events in the **Project** window.

- To open the **Select** submenu, select **Edit > Select**.

#### All

Selects all events in the **Project** window.

#### None

Deselects all events in the **Project** window.

#### Invert

Inverts the selection. All selected events are deselected and all events that were not selected are selected instead.

#### In Loop

Selects all events that are partly or wholly between the left and right locator.

#### From Start to Cursor

Selects all events that end to the left of the project cursor.

#### From Cursor to End

Selects all events that start to the right of the project cursor.

#### Equal Pitch all Octaves/Equal Pitch same Octave

These functions are available in the MIDI editors and the **Sample Editor**.

#### Select Controllers in Note Range

This function is available in the MIDI editors.

### All on Selected Tracks

Selects all events on the selected track.

### Events under Cursor

Automatically selects all events on the selected tracks that are touched by the project cursor.

### Select Event

This function is available in the **Sample Editor**.

### Left Selection Side to Cursor/Right Selection Side to Cursor

These functions are only used for range selection editing.

### NOTE

When the **Range Selection** tool is selected, the **Select** submenu features different functions.

---

### RELATED LINKS

[Select Menu for Selection Ranges](#) on page 189

[Range Editing](#) on page 425

## Removing Events

You can remove events from the **Project** window.

---

### PROCEDURE

- To remove an event from the **Project** window, do one of the following:
    - On the **Project** window toolbar, activate **Erase** and click the event.
    - In the event display, select the events and select **Edit > Delete**.
    - In the event display, select the events and press **Backspace**.
- 

### RELATED LINKS

[Project Window Toolbar](#) on page 32

## Event Movement Options

Cubase provides several methods to move events in the **Project** window.

You can move events using any of the following methods:

- Use the **Object Selection** tool.
- Use the **Nudge** tool.
- Select **Edit > Move to** and select one of the options.
- Select the event and edit the start position on the info line.
- Select multiple events and use the **Set Spacer Between Selected Events** function.

### RELATED LINKS

[Moving Events with the Object Selection Tool](#) on page 177

[Moving Events with the Nudge Buttons](#) on page 177

[Move to Submenu](#) on page 177

[Moving Events via the Info Line](#) on page 178

[Setting Spacers between Events](#) on page 178



## Moving Events with the Object Selection Tool

You can select one or several events with the **Object Selection** tool and drag them to a new position.

---

### PROCEDURE

1. Select **Object Selection** .
2. Click the events that you want to move and drag them to a new position.

### NOTE

You can only drag events to tracks of the same type. If you hold down **Ctrl/Cmd** while dragging, you can restrict the movement either horizontally or vertically.

---

### RESULT

The events are moved. If you moved several events, their relative positions are kept.

### NOTE

To avoid accidentally moving events when you click them in the **Project** window, the response when you move an event by dragging is slightly delayed. You can adjust this delay with the **Drag Delay** setting in the **Preferences** dialog (**Editing** page).

---

## Moving Events with the Nudge Buttons

You can move one or several selected events by using the nudge buttons on the **Project** window toolbar.

---

### PROCEDURE

1. Right-click the **Project** window toolbar and activate **Nudge Palette**.  
The nudge buttons become available on the toolbar.  

  2. Select the events that you want to move, and click **Move Left** or **Move Right**.  
The selected events or parts are moved.
- 

### RELATED LINKS

[Project Window Toolbar](#) on page 32

## Move to Submenu

If the **Object Selection** tool is selected, the **Move to** submenu features options for moving events to specific positions in the **Project** window.

- To open the **Move to** submenu, select **Edit > Move to**.

The following options are available:

### Cursor

Moves the selected event to the project cursor position. If you selected several events on the same track, the following events keep their relative position.

### Origin

Moves the selected events to the positions at which they were originally recorded.

### **Selected Track**

Moves the selected events to separate tracks, starting on the selected track. The events are placed at their current positions.

### **Front/Back**

Moves the selected events to the front or back, respectively. This is useful if you have overlapping audio events and you want to play back another event.

## **Moving Events via the Info Line**

You can move a selected event by changing its start value in the info line.

---

### PROCEDURE

1. Select the event that you want to move.
2. On the info line, double-click the **Start** field and enter a new value for the event start.

---

### RESULT

The event is moved by the set value.

## **Setting Spacers between Events**

You can rearrange multiple events on a track so that they are at a specified distance from each other.

### PREREQUISITE

- A track contains multiple events.
- The events are not locked.

---

### PROCEDURE

1. Select all events that you want to rearrange.
2. Select **Edit > Functions > Set Spacer between Selected Events**.
3. Set the **Spacer in Seconds** value.
4. Click **OK**.

---

### RESULT

All selected events on the track are at the specified distance from each other.

### NOTE

- Grouped events are handled like single events.
- This function does not work for automation and signature tracks.

---

### RELATED LINKS

[Locking Events](#) on page 186

[Grouped Events](#) on page 186

## **Renaming Events**

---

### PROCEDURE

- Do one of the following:
  - Select the events and type in a new name in the **File** field on the info line.

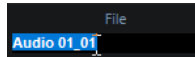

- Change the track name, hold down a modifier key, and press **Return** to rename all events according to the track.
- 

## Event Resize Options

You can resize events by moving their start or end positions individually.

To resize events, you can use the **Object Selection**, the **Scrub** tool or the **Trim** tools on the **Nudge** palette.

Resizing also works, if the **Combine Selection Tools** mode is active.

### IMPORTANT

When resizing events, automation data is not taken into account.

---

#### RELATED LINKS

[Combine Selection Tools Mode](#) on page 174

[Resizing Events with the Object Selection Tool - Normal Sizing](#) on page 179

[Resizing Events with the Object Selection Tool - Sizing Moves Contents](#) on page 179

[Resizing Events with the Object Selection Tool - Sizing Applies Time Stretch](#) on page 180

[Resizing Events with the Trim Tools](#) on page 180

[Resizing Events with the Scrub Tool](#) on page 181

[Snap Function](#) on page 67

## Resizing Events with the Object Selection Tool - Normal Sizing

You can move the start or end point of the event.

---

#### PROCEDURE

1. Select **Object Selection**.
2. Click the **Object Selection** tool again, and select **Normal Sizing** from the pop-up menu.
3. Click and drag the lower left or right corner of the event.



#### RESULT

The event is resized and according to where you dragged, more or less of the content is revealed. If several events are selected, they are all resized in the same way.

#### RELATED LINKS

[Project Window Toolbar](#) on page 32

## Resizing Events with the Object Selection Tool - Sizing Moves Contents

You can move the start or end point of the event and move the content.

---

#### PROCEDURE

1. Select **Object Selection**.

2. Click the **Object Selection** tool again, and select **Sizing Moves Contents** from the pop-up menu.
3. Click and drag the lower left or right corner of the event.



---

RESULT

The event is resized and the content follows. If several events are selected, they are all resized in the same way.

RELATED LINKS

[Project Window Toolbar](#) on page 32

## Resizing Events with the Object Selection Tool - Sizing Applies Time Stretch

You can move the start or end point of the event and time stretch the content to fit the new event length.

---

PROCEDURE

1. Select **Object Selection**.
2. Click the **Object Selection** tool again, and select **Sizing Applies Time Stretch** from the pop-up menu.
3. Click and drag the lower left or right corner of the event.

---

RESULT

The part is stretched or compressed to fit the new length.

- If you resize MIDI parts, the note events are stretched (moved and resized). Controller data and Note Expression data are stretched, too.
  - If you resize audio parts, the events are moved, and the referenced audio files are time stretched to fit the new length.
- If several events are selected, they are all resized in the same way.

RELATED LINKS

[Time Stretch](#) on page 399

[Project Window Toolbar](#) on page 32

## Resizing Events with the Trim Tools

You can move the start or end point of the event by the amount set on the **Grid Type** pop-up menu.

PREREQUISITE

The **Object Selection** tool is set to **Normal Sizing** or to **Sizing Moves Contents**.

---

PROCEDURE

1. Right-click the **Project** window toolbar and activate **Nudge Palette**.  
The nudge buttons become available on the toolbar.



2. Select the event.

3. Do one of the following:
    - Click **Trim Start Left**.
    - Click **Trim Start Right**.
    - Click **Trim End Left**.
    - Click **Trim End Right**.
- 

RESULT

The start or end position of the selected events are moved by the amount set on the **Grid Type** pop-up menu.

RELATED LINKS

[Project Window Toolbar](#) on page 32

## Resizing Events with the Scrub Tool

You can scrub the event when moving the start or end point of the event.

---

PROCEDURE

1. Click **Play**.
  2. Click **Play** again to open a pop-up menu.
  3. Select **Scrub**.
  4. Click and drag the lower left or right corner of the event.
- 

RESULT

The event is resized and you get an acoustic feedback while dragging.

RELATED LINKS

[Project Window Toolbar](#) on page 32

## Splitting Events

---

PROCEDURE

- Do one of the following:
  - Select **Split** and click the event that you want to split.
  - Select **Object Selection**, hold down **Alt** and click the event.
  - Move the project cursor to the position where you want to split the events, and select **Edit > Functions > Split at Cursor**.

NOTE

This splits all events on all tracks that are intersected by the project cursor. If you select specific events, only these events are split.

---

- Set up the left and right locators at the position where you want to split the events, and select **Edit > Functions > Split Loop**.

NOTE

This splits all events on all tracks that are intersected by the locators. If you select specific events, only these events are split.

---

RESULT

The events are split.

NOTE

If you split a MIDI part so that the split position intersects one or several MIDI notes and **Split MIDI Events** is activated in the **Preferences** dialog (**Editing—MIDI** page), the intersected notes are split and new notes are created at the beginning of the second part. If it is deactivated, the notes remain in the first part, but stick out after the end of the part.

---

RELATED LINKS

[Project Window Toolbar](#) on page 32

## Splitting Events Repeatedly

You can split events repeatedly into multiple events of equal size.

PROCEDURE

- Select **Split** , hold down **Alt** and click the event where you want to make the first split.
- 

RESULT

The event is automatically split into as many equal events as the length of the original event allows.

## Using Cut Head and Cut Tail

You can cut everything to the left or right of the cursor or a selected range.

PROCEDURE

- Do one of the following:
    - Select **Edit > Range > Cut Head** to delete everything to the left of the cursor/selection range.
    - Select **Edit > Range > Cut Tail** to delete everything to the right of the cursor/selection range.
- 

## Gluing Events

In the **Project** window, you can glue two or more events on the same track.

PROCEDURE

- Do one of the following:
    - Select the events that you want to glue, and select **Edit > Glue**.
    - Select **Glue** and click the event that you want to glue to the next event.
    - Select **Glue**, hold down **Alt**, and click the event that you want to glue to all following events.
- 

RESULT

The events are glued together.

#### NOTE

If you first split an audio event and then glue the parts together again, an event is created. In any other case, a part is created.

---

#### RELATED LINKS

[Project Window Toolbar](#) on page 32

## Pasting Events

You can paste events from the clipboard.

---

#### PROCEDURE

- Do one of the following:
    - Select the events and select **Edit > Functions > Paste at Origin** to paste the event at the same position from which you cut or copied it.
    - Select the events, select the track where you want to paste them, and select **Edit > Functions > Paste Relative to Cursor** to paste the event while keeping its relative position to the project cursor.
- 

#### RESULT

If you paste an audio event, it is inserted on the selected track, positioned so that its snap point is aligned with the cursor position.

If the selected track is of the wrong type, the event is inserted on its original track.

## Pasting Events to Matching Track Names

You can copy events in one project and paste them at the first track that matches the exact track name in another project.

---

#### PROCEDURE

1. Copy the events in one project.
  2. Activate the project where you want to paste the events.
  3. Select **Edit > Functions > Paste to Matching Track Name**.
- 

#### RESULT

The events are inserted on the track with the name that exactly matches the original track name. For all events that have no matching track name, new tracks are created.

## Duplicating Events

In the **Project** window, you can duplicate selected events.

---

#### PROCEDURE

- Select the event and do one of the following:
  - Select **Edit > Functions > Duplicate**.
  - Hold down **Alt** and drag the event to a new position.

**NOTE**

If you hold down **Ctrl/Cmd** as well, movement direction is restricted to either horizontal or vertical.

---

**RESULT**

A copy of the selected event is created and placed after the original. If several events are selected, all of these are copied as one unit, maintaining the relative distance between the events.

**NOTE**

If you duplicate audio events, the copies always refer to the same audio clip.

---

## Repeating Events

---

**PROCEDURE**

- Do one of the following:
  - Select the events and select **Edit > Functions > Repeat** to open the **Repeat Events** dialog, that allows you to create a number of real or shared copies of the selected events.
  - Select the events, hold down **Alt**, click the handle in the lower right corner of the last selected event, and drag to the right to create a real copy.
  - Move the mouse pointer over the middle of the right event border so that it becomes a pointing hand symbol, click and drag to the right to create a real copy.
  - Select the events, hold down **Alt-Shift**, and drag to the right to create a shared copy.

**NOTE**

This applies to MIDI events only.

---

- Move the mouse pointer over the middle of the right event border so that it becomes a pointing hand symbol, hold down **Shift**, click and drag to the right to create a shared copy.

**NOTE**

Repeating by dragging only works if the track has a height of at least 2 rows.

---

**RELATED LINKS**

[Shared Copies](#) on page 185

[Repeat Events Dialog](#) on page 184

[Setting the Track Height](#) on page 146

## Repeat Events Dialog

The **Repeat Events** dialog allows you to create a number of real or shared copies of the selected events.

- To open the **Repeat Events** dialog, select **Edit > Functions > Repeat**.



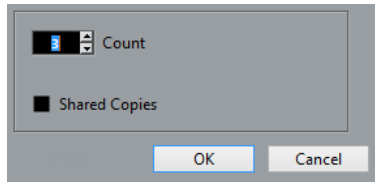

### Count

Allows you to specify how many times you want the event to be repeated.

### Shared Copies

Activate this to create a shared copy.

#### RELATED LINKS

[Shared Copies](#) on page 185

## Shared Copies

Shared copies are useful if you want to create copies that are automatically edited in the same way as the original event.

You can convert a shared copy to a real copy by selecting **Edit > Functions > Convert to Real Copy**. This creates a new version of the clip that you can edit independently. The new clip is automatically added to the **Pool**.

#### RELATED LINKS

[Repeating Events](#) on page 184

[Repeat Events Dialog](#) on page 184

## Fill Loop

You can create a number of copies between the right and left locators.

- Select **Edit > Functions > Fill Loop** to create a number of copies starting at the left locator and ending at the right locator.  
The last copy is automatically shortened to end at the right locator position.

## Sliding the Contents of Events

You can move the contents of an event without changing its position in the **Project** window.

---

#### PROCEDURE

- Hold down **Ctrl/Cmd-Alt**, click the event, and drag to the left or right.

---

#### RESULT

The content of the event is moved.

---

#### NOTE

You cannot slide an audio event past the start or end of the actual audio clip. If the event plays the whole clip, you cannot slide the audio at all.

---

## Grouping Events

You can treat several events on the same or different tracks as one unit by grouping them.

---

### PROCEDURE

- Select the events and select **Edit > Group**.

---

### RESULT

The events are grouped. This is indicated by an icon.

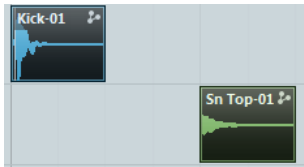

## Grouped Events

If you edit one of the grouped events in the **Project** window, all other events in the same group are affected too.

Group editing operations include:

- Selecting
- Moving and duplicating
- Resizing
- Adjusting fade-in and fade-out (audio events only)
- Splitting
- Locking
- Muting
- Deleting

### RELATED LINKS

[Fades, Crossfades, and Envelopes](#) on page 271

## Locking Events

If you want to make sure that you do not edit or move an event by accident, you can lock it.

---

### PROCEDURE

- Do one of the following:
  - Select the events and select **Edit > Lock** to lock the selected events.
  - Click the padlock button in the track list or in the **Inspector** to lock all events on a track.

---

### RESULT

The events are locked. This is indicated by a padlock symbol.

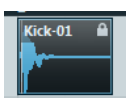

To unlock an event, select the event and select **Edit > Unlock**.

## Lock Event Attributes Dialog

The **Lock Event Attributes** dialog allows you to lock specific event attributes.

- To open the **Lock Event Attributes** dialog, select a locked event and select **Edit > Lock**.

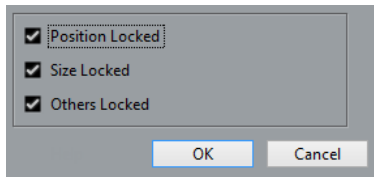

### Position Locked

Activate this to prevent the event from being moved.

### Size Locked

Activate this to prevent the event from being resized.

### Others Locked

Activate this to prevent the event from being edited. This includes adjusting the fades and event volume, processing, etc.

### NOTE

You can also set these attributes in the **Preferences** dialog (**Editing** page).

---

### RELATED LINKS

[Lock Event Attributes](#) on page 888

## Inverting the Phase of Audio Events

You can invert the phase of audio events in the **Project** window.

### PROCEDURE

1. In the **Project** window, select one or multiple audio events.
2. On the info line, click the **Invert Phase** field.

### RESULT

The phase of the events is inverted. This is reflected on the info line.

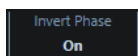

### RELATED LINKS

[Info Line](#) on page 43

## Muting Events

You can mute events in the **Project** window. Muted events can be edited as usual with the exception of adjusting fades, but are not played back.

### PROCEDURE

- Do one of the following:
    - Select the **Mute** tool and click the events or drag a selection rectangle around them.
    - Select the events and select **Edit > Mute**.
-

#### RESULT

The events are muted and grayed out.



You can unmute events by selecting them and selecting **Edit > Unmute**.

#### RELATED LINKS

[Project Window Toolbar](#) on page 32

# Range Editing

Editing in the **Project** window is not restricted to handling whole events and parts. You can also work with selection ranges, which are independent from the event/part and track boundaries.

## Creating a Selection Range

### PROCEDURE

1. On the **Project** window toolbar, select **Range Selection**.
2. Do one of the following:
  - Draw a selection rectangle around the range that you want to select.
  - Select **Edit > Select**, and select one of the menu functions.
  - Double-click an event to create a selection range that encompasses it.

### NOTE

If you hold down **Shift** and double-click several events in a row, you can create a selection range that encompasses several events.

### RELATED LINKS

[Select Menu for Selection Ranges](#) on page 189

[Combine Selection Tools Mode](#) on page 174

## Select Menu for Selection Ranges

If the **Range Selection** tool is selected, the **Select** submenu features specific options for selecting ranges in the **Project** window.

- To open the range selection options menu, select the **Range Selection** tool and select **Edit > Select**.

### All

Makes a selection that covers all tracks, from the start of the project to the end. You can define the track length with the **Project Length** setting in the **Project Setup** dialog.

### None

Removes the current selection range.

### Invert

Inverts the selection. All selected events are deselected, and all events that were not selected are selected. Only used for event selection.

### In Loop

Makes a selection between the left and right locator on all tracks.

**From Start to Cursor**

Makes a selection on all tracks, from the start of the project to the project cursor.

**From Cursor to End**

Makes a selection on all tracks, from the project cursor to the end of the project.

**Equal Pitch - all Octaves**

This function requires that a single note is selected. It selects all notes of this part that have the same pitch in any octave as the selected note.

**Equal Pitch - same Octave**

This function requires that a single note is selected. It selects all notes of this part that have the same pitch and the same octave as the selected note.

**Select Controllers in Note Range**

Selects the controllers within the note range.

**All on Selected Tracks**

Selects all events on the selected track. Only used for event selection.

**Events under Cursor**

Selects all events on the selected tracks that are touched by the project cursor.

**Select Event**

This is available in the **Sample Editor**.

**Left Selection Side to Cursor**

Moves the left side of the current selection range to the project cursor position.

**Right Selection Side to Cursor**

Moves the right side of the current selection range to the project cursor position.

**Range to Next Event**

Moves the selection range to the next event head or tail on the selected tracks and turns the selection range to a zero selection.

**Range to Previous Event**

Moves the selection range to the previous event head or tail on the selected tracks and turns selection range to a zero selection.

**Enlarge Range to Next Event**

Moves the right side of the current selection range to the next event head or tail on the selected tracks.

**Enlarge Range to Previous Event**

Moves the left side of the current selection range to the previous event head or tail on the selected tracks.

RELATED LINKS

[Project Setup Dialog](#) on page 86

[Selecting with the Object Selection Tool](#) on page 174

[Select Submenu](#) on page 175

## Selecting Ranges for Several Tracks

You can create selection ranges that cover several tracks. It is also possible to exclude tracks from a selection range.

---

### PROCEDURE

1. Create a selection range from the first to the last track.
  2. Press **Ctrl/Cmd** and click in the selection range on the tracks that you want to exclude from the selection.
- 

## Editing Selection Ranges

You can edit selection ranges, that is, adjust their size, move or duplicate them, split them, etc.

## Adjusting the Size of Selection Ranges

You can adjust the size of a selection range in the following ways:

- By dragging its edges.  
The pointer takes the shape of a double arrow when you move it over an edge of the selection range.
- By holding down **Shift** and clicking.  
The closest selection range edge is moved to the position at which you clicked.
- By adjusting the selection range length, or the start or end position on the info line.
- By using the trim buttons on the toolbar.  
The left trim buttons move the start of the selection range and the right buttons move the end. The edges are moved by the amount specified on the **Grid** pop-up menu.

---

### NOTE

The trim buttons are located on the **Nudge Palette**, which is not visible on the toolbar by default.

- By using **Move Left** and **Move Right** on the toolbar.  
These move the whole selection range to the left or the right. The amount of movement depends on the selected display format and the value specified on the **Grid** pop-up menu.

---

### IMPORTANT

The contents of the selection are not moved. Using **Move Left/Move Right** is the same as adjusting the start and end of the selection range at the same time by the same amount.

---

### NOTE

The move buttons are located on the **Nudge Palette**, which is not visible on the toolbar by default.

- To crop all events or parts that are partially within the selection range, select **Edit > Range > Crop**.  
Events that are fully inside or outside the selection range are not affected.

---

### RELATED LINKS

[Setup Context Menus](#) on page 876

## Moving Selection Ranges

### PREREQUISITE

You have created a selection range.

---

### PROCEDURE

- Click the selection range and drag it to a new position.
- 

### RESULT

The contents of the selection range are moved to the new position. If the range intersected events or parts, these are split before moving, so that only the sections within the selection range are affected.

### RELATED LINKS

[Creating a Selection Range](#) on page 189

[Duplicating Events](#) on page 183

## Duplicating Selection Ranges

### PREREQUISITE

You have created a selection range.

---

### PROCEDURE

- Click the selection range, hold down **Alt**, and drag.
- 

### RELATED LINKS

[Creating a Selection Range](#) on page 189

## Cut, Copy, and Paste of Selection Ranges

You can cut or copy and paste selection ranges, using the functions on the **Edit** menu. You can also use the **Cut Time** and **Paste Time** options.

### Cut

Cuts the data in the selection range and moves it to the clipboard. The selection range is replaced by empty track space in the **Project** window, meaning that events to the right of the range keep their positions.

### Copy

Copies the data in the selection range to the clipboard.

### Paste

Pastes the clipboard data to the start position and track of the current selection. Existing events on the tracks remain at their original position.

### Paste at Origin

Pastes the clipboard data back at its original position. Existing events on the tracks remain at their original position.

This option is available in **Edit > Functions**.

### Cut Time

Cuts the selection range and moves it to the clipboard. Events to the right of the removed range are moved to the left to fill the gap.



This option is available in **Edit > Range**.

#### **Paste Time**

Pastes the selection range from the clipboard to the start position and track of the current selection. Existing events are moved to make room for the pasted data.

This option is available in **Edit > Range**.

#### **Paste Time at Origin**

Pastes the selection range from the clipboard to its original position. Existing events are moved to make room for the pasted data.

This option is available in **Edit > Range**.

#### **Global Copy**

Copies everything between the left and right locator.

This option is available in **Edit > Range**.

## **Deleting Data in Selection Ranges**

- To replace data within the deleted selection range with empty track space, select **Edit > Delete** or press **Backspace**.  
Events to the right of the range keep their position.
- To remove the selection range and make the events to the right move to the left to fill the gap, select **Edit > Range > Delete Time**.

## **Splitting Selection Ranges**

- To split any events or parts that are intersected by the selection range, at the positions of the selection range edges, select **Edit > Range > Split**.

## **Inserting Silence**

You can insert empty track space from the start of the selection range. The length of the silence equals the length of the selection range.

- To insert silence, select **Edit > Range > Insert Silence**.  
Events to the right of the selection range start are moved to the right to make room.  
Events that are intersected by the selection range start are split, and the right section is moved to the right.

# Playback and Transport

Cubase offers multiple methods and functions to control playback and transport.

## RELATED LINKS

[Transport](#) on page 904

## Transport Panel

The **Transport** panel contains the main transport functions as well as many other options related to playback and recording.

- To show the **Transport** panel, select **Transport > Transport Panel** or press **F2**.

## Transport Panel Sections

The **Transport** panel has different sections that you can show or hide by activating the corresponding options on the **Transport** panel context menu.

- To show all **Transport** panel sections, right-click anywhere on the **Transport** panel and select **Show All**.

The following sections are available:

### System Performance Meter

#### System Performance Meter



Shows the meters for average audio processing load and the disk cache load.

### Common Record Modes

#### Common Record Modes



Allow you to determine what happens if you click **Record** during an audio or MIDI recording, and where the recording should start.

### Audio Record Modes

#### Audio Record Modes

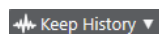

Allow you to select what happens when you record over existing audio events.

### MIDI Record Modes

#### MIDI Record Modes

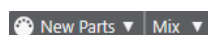

Allow you to select what happens when you record over existing MIDI parts.

## MIDI Auto Quantize

### Automatic MIDI Record Quantize



Activates automatic quantizing during a MIDI recording.

## Locators

### Go to Left Locator Position



Allows you to go to the left locator position.

### Left Locator Position

1. 5. 1. 0

Shows the left locator position.

### Go to Right Locator Position



Allows you to go to the right locator position.

### Right Locator Position

4. 8. 1. 0

Shows the right locator position.

## Locator Range Duration

### Locators to Selection



Allows you to set the locators to the selection.

### Locator Range Duration

4. 8. 1. 0

Shows the duration of the locator range.

## Punch Points

### Lock Punch Points to Locators



Locks the punch points to the left and right locator positions.

### Punch In



Activates **Punch In**.

### Punch In Position

20. 1. 1. 0

Allows you to set up the punch in position. For this to work, **Lock Punch Points to Locators** must be deactivated. To show/hide this, click the points on the divider.

### Punch Out



Activates **Punch Out**.

### Punch Out Position

**1. 1. 1. 0**

Allows you to set up the punch out position. For this to work, **Lock Punch Points to Locators** must be deactivated. To show/hide this, click the points on the divider.

## Transport Controls

### Go to Previous Marker/Zero



Moves the project cursor to the previous marker/zero position on the timeline.

### Go to Next Marker/Project End



Moves the project cursor to the next marker/project end.

### Rewind



Moves backward.

### Forward



Moves forward.

### Cycle



Activates/Deactivates cycle mode.

### Stop



Stops playback.

### Start



Starts playback.

### Transport Record



Activates/Deactivates record mode.

## Time Display

### Select Primary Time Format



Allows you to select a time format for the primary time display.

### Primary Time Display

**6. 1. 1. 0**

Shows the position of the project cursor in the selected time format.

### Select Secondary Time Format



Allows you to select a time format for the secondary time display.

### Secondary Time Display

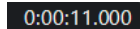
 0:00:11.000

Shows the position of the project cursor in the selected time format.

### Markers

#### Jump to Marker

 1 2 3 4 5 6 7 8

Allows you to set and locate marker positions.

#### Open Markers Window



Opens the **Markers** window.

### Pre-roll & Post-roll

#### Activate Pre-roll



Activates pre-roll.

#### Pre-roll Amount

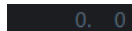
 0. 0

Allows you to set the pre-roll position. To show/hide this, click the points on the divider.

#### Activate Post-roll



Activates post-roll.

#### Post-roll Amount

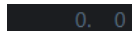
 0. 0

Allows you to set the post-roll position. To show/hide this, click the points on the divider.

### Tempo & Time Signature

#### Activate Tempo Track



Allows you to activate/deactivate the tempo track.

#### Tempo

 120.000

Allows you to set the tempo value.

#### Time Signature

 4/4

Allows you to set the first time signature value. To show/hide this, click the points on the divider.

### Activate External Sync

#### Activate External Sync



Activates external synchronization.

### Open Synchronization Setup



Allows you to open the **Project Synchronization Setup** dialog.

### Click & Count-In & Click Pattern

#### Activate Metronome Click



Activates the metronome click.

#### Activate Count-in



Activates the metronome click in count-in.

#### Click Pattern



Allows you to set up a click pattern. To show/hide this, click the points on the divider.

### Open Metronome Setup



Opens the **Metronome Setup** dialog. To show/hide this, click the points on the divider.

### Input/Output Activity

#### MIDI In Activity



Displays the MIDI input signals.

#### MIDI Out Activity



Displays the MIDI output signals.

#### Audio Activity



Displays the audio input/output signals.

#### Audio Clipping



Displays audio clipping.

#### Level Display



Displays the output level.

#### Level Control



Allows you to control the output level.

### Set up Transport

#### Set up Transport



Opens a pop-up menu where you can set up which elements are visible.

RELATED LINKS

[Transport](#) on page 904

[Transport - Scrub](#) on page 905

## Transport Menu

The **Transport** menu contains several transport functions as well as many other options related to playback and recording.

### Transport Panel

Opens the **Transport** panel.

### Transport Commands

#### Start

Starts playback.

#### Stop

Stops playback.

#### Start/Stop

Starts/Stops playback.

#### Cycle

Activates/Deactivates cycle mode.

#### Record

Activates/Deactivates record mode.

#### Rewind

Moves backward.

#### Forward

Moves forward.

#### Fast Rewind

Moves backward at a faster speed.

#### Fast Forward

Moves forward at a faster speed.

#### Nudge Cursor Left

Moves the project cursor position to the left.

#### Nudge Cursor Right

Moves the project cursor position to the right.

#### Enter Project Cursor Position

Allows you to enter the project cursor position manually.

#### Enter Tempo

Allows you to enter the tempo manually.

#### Enter Time Signature

Allows you to enter the time signature manually.

**Go to Project Start**

Moves the project cursor position to the start of the project.

**Go to Project End**

Moves the project cursor position to the end of the project.

**Exchange Time Formats**

Switches the primary and the secondary time display.

**Locators**

**Go to Left Locator Position**

Moves the project cursor position to the left locator.

**Go to Right Locator Position**

Moves the project cursor position to the right locator.

**Set Left Locator to Project Cursor Position**

Sets the left locator to the project cursor position.

**Set Right Locator to Project Cursor Position**

Sets the right locator to the project cursor position.

**Enter Left Locator Position**

Allows you to enter the position of the left locator manually.

**Enter Right Locator Position**

Allows you to enter the position of the right locator manually.

**Enter Locator Range Duration**

Allows you to enter the duration of the locator range manually.

**Set Locators to Selection Range**

Sets the locators to encompass the selection.

**Exchange Left & Right Locator Positions**

Switches the positions of the left and right locator.

**Loop Selection Range**

Activates playback from the start of the current selection and keeps starting over again when reaching the selection end.

**Punch Points**

**Activate Punch In**

Activates/Deactivates punch in.

**Activate Punch Out**

Activates/Deactivates punch out.

**Go to Punch In Position**

Moves the project cursor position to the punch in position.

**Go to Punch Out Position**

Moves the project cursor position to the punch out position.

**Lock Punch Points to Locators**

Allows you to unlock/lock the punch in and punch out position to the left and the right locator.



**Set Punch In to Project Cursor Position**

Moves the punch in position to the project cursor position.

**Set Punch Out to Project Cursor Position**

Moves the punch out position to the project cursor position.

**Enter Punch In Position**

Allows you to enter the punch in position manually.

**Enter Punch Out Position**

Allows you to enter the punch out position manually.

**Set Punch Points to Selection Range**

Sets the punch in and the punch out position to the selected event range.

**Set Project Cursor Position**

**Locate Selection Start**

Moves the project cursor to the beginning of the selection.

**Locate Selection End**

Moves the project cursor to the end of the selection.

**Locate Next Marker**

Moves the project cursor to the next marker.

**Locate Previous Marker**

Moves the project cursor to the previous marker.

**Locate Next Hitpoint**

Moves the project cursor to the next hitpoint on the selected track.

**Locate Previous Hitpoint**

Moves the project cursor to the previous hitpoint on the selected track.

**Locate Next Event**

Moves the project cursor to the next event on the selected track.

**Locate Previous Event**

Moves the project cursor to the previous event on the selected track.

**Play Project Range**

**Play from Selection Start**

Activates playback from the start of the current selection.

**Play from Selection End**

Activates playback from the end of the current selection.

**Play until Selection Start**

Activates playback two seconds before the start of the current selection and stops at the selection start.

**Play until Selection End**

Activates playback two seconds before the end of the current selection and stops at the selection end.

**Play until Next Marker**

Activates playback from the project cursor and stops at the next marker.

### **Play Selection Range**

Activates playback from the start of the current selection and stops at the selection end.

### **Pre-roll & Post-roll**

#### **Use Pre-roll**

Activates/Deactivates the pre-roll.

#### **Use Post-roll**

Activates/Deactivates the post-roll.

#### **Post-roll from Selection Start**

Starts playback from the beginning of the selected range and stops after the time set in the post-roll field on the **Transport** panel.

#### **Post-roll from Selection End**

Starts playback from the end of the selected range and stops after the time set in the post-roll field on the **Transport** panel.

#### **Pre-roll to Selection Start**

Stops playback at the selection start. The playback start position is set in the pre-roll field on the **Transport** panel.

#### **Pre-roll to Selection End**

Stops playback at the selection end. The playback start position is set in the pre-roll field on the **Transport** panel.

### **Use Tempo Track**

Activates/Deactivates the tempo track.

### **Common Record Modes**

#### **Punch In/Out**

Activates/Deactivates punch in/out.

#### **Re-Record**

Activates/Deactivates the re-record mode.

#### **Start Recording at Project Cursor Position**

Activates/Deactivates the start of the recording at the project cursor position.

#### **Start Recording at Left Locator/Punch In Position**

Activates/Deactivates the start of the recording at the left locator.

### **Audio Record Mode**

These options allow you to select what happens when you record over existing events.

#### **Keep History**

Keeps existing events or portions of events.

#### **Cycle History + Replace**

Replaces existing events or portions of events by the new recording. In cycle mode, all takes from the current cycle recording are kept.

#### **Replace**

Replaces existing events or portions of events by the last take.

## MIDI Record Mode

These options allow you to select what happens when you record over existing parts.

### New Parts

Keeps existing parts and saves the new recording as a new part.

### Merge

Keeps existing events in parts and adds the newly recorded events.

### Replace

Replaces existing events in parts by the new recording.

### Auto Quantize in Record

Activates automatic quantizing during recording.

## MIDI Cycle Record Mode

### Mix

Adds everything you record to what was previously recorded.

### Overwrite

Overwrites all MIDI that you have recorded on previous laps as soon as you play a MIDI note or send any MIDI message.

### Keep Last

Replaces previously recorded laps only if the new lap is completed.

### Stacked

Turns each recorded cycle lap into a separate MIDI part, and divides the track into lanes for each cycle lap. The parts are stacked above each other, each on a different lane. All takes but the last one are muted.

### Mix-Stacked (No Mute)

Same as **Stacked**, but parts are not muted.

### Auto Quantize in Record

Activates automatic quantizing during recording.

## MIDI Retrospective Recording

Allows you to recover MIDI data that you play in **Stop** mode or during playback. The following options are available:

### Insert from All MIDI Inputs

Inserts MIDI data that was sent to all track inputs as a linear MIDI part on the selected track.

### Insert from Track Input as Linear Recording

Inserts MIDI data that was sent to the track input as a linear MIDI part on the selected track.

### Insert from Track Input as Cycle Recording

Inserts MIDI data that was sent to the track input as stacked MIDI parts on the selected track.

### Empty All Buffers

Empties the retrospective record buffer for the selected track.

### Metronome Setup

Opens the **Metronome Setup** dialog.

### Activate Metronome

Activates/Deactivates the metronome click.

### Project Synchronization Setup

Opens the **Project Synchronization Setup** dialog.

### Activate External Sync

Sets Cubase to be synchronized externally.

#### RELATED LINKS

[Left and Right Locators](#) on page 211

[Punch In and Punch Out](#) on page 217

[Pre-Roll and Post-Roll](#) on page 216

[Common Record Modes Menu](#) on page 234

[Audio Record Modes](#) on page 239

[MIDI Record Modes](#) on page 246

[Recovery of MIDI Recordings](#) on page 247

[Metronome Click](#) on page 217

## Transport Bar

The **Transport Bar** contains all transport functions in an integrated and fixed zone of the **Project** window.

- To activate the **Transport Bar**, click **Set up Window Layout** on the **Project** window toolbar and activate **Transport Bar**.
- To display all transport elements, right-click in an empty area of the **Transport Bar** and select **Show All**.
- To show all controls of a section, click the points to the right of the section and drag all the way to the right. To hide the controls again, drag to the left.



#### RELATED LINKS

[Transport Bar](#) on page 44

[Project Window Toolbar](#) on page 32

## Transport Bar Sections

The **Transport Bar** has different sections that you can show or hide by activating the corresponding options on the context menu.

- To activate the **Transport Bar**, click **Set up Window Layout** on the **Project** window toolbar and activate **Transport Bar**.
- To show/hide tools, open the **Transport Bar** context menu by right-clicking in an empty area of the **Transport Bar** and activate the tools that you want to display. To show all tools, select **Show All**.

## Constrain Delay Compensation

### Constrain Delay Compensation



Minimizes the latency effects of the delay compensation.

## Common Record Modes

### Common Record Modes



Allow you to determine what happens if you click **Record** during an audio or MIDI recording, and where the recording should start.

## Audio Record Modes

### Audio Record Modes

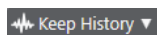

Allow you to select what happens when you record over existing audio events.

## MIDI Record Modes

### MIDI Record Modes

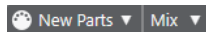

Allow you to select what happens when you record over existing MIDI parts.

## MIDI Auto Quantize

### Automatic MIDI Record Quantize



Activates automatic quantizing during a MIDI recording.

## Left Divider

### Left Divider



Tools that are placed to the left of the divider are always shown.

## System Performance Meter

### System Performance Meter



Shows the meters for average audio processing load and the disk cache load.

## Locators

### Go to Left Locator Position



Allows you to go to the left locator position.

### Left Locator Position

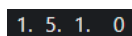

Shows the left locator position.

### Go to Right Locator Position



Allows you to go to the right locator position.

### Right Locator Position

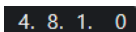
 4. 8. 1. 0

Shows the right locator position.

### Locator Range Duration

#### Locators to Selection



Allows you to set the locators to the selection.

#### Locator Range Duration

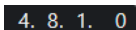
 4. 8. 1. 0

Shows the duration of the locator range.

### Punch Points

#### Punch In



Activates **Punch In**.

#### Punch Out



Activates **Punch Out**.

#### Lock Punch Points to Locators



Locks the punch points to the left and right locator positions.

#### Punch In Position

 20. 1. 1. 0

Allows you to set up the punch in position. For this to work, **Lock Punch Points to Locators** must be deactivated. To show/hide this, click the points on the divider.

#### Punch Out Position

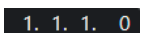
 1. 1. 1. 0

Allows you to set up the punch out position. For this to work, **Lock Punch Points to Locators** must be deactivated. To show/hide this, click the points on the divider.

### Transport Controls

#### Go to Previous Marker/Zero



Moves the project cursor to the previous marker/zero position on the timeline.

#### Go to Next Marker/Project End



Moves the project cursor to the next marker/project end.

#### Rewind



Moves backward.

### Forward



Moves forward.

### Cycle



Activates/Deactivates cycle mode.

### Stop



Stops playback.

### Start



Starts playback.

### Transport Record



Activates/Deactivates record mode.

## Retrospective Record

### Insert Retrospective Recording from All MIDI Inputs on Selected Track



Allows you to recover MIDI notes that you played in stop mode or during playback.

## Time Displays

### Select Primary Time Format



Allows you to select a time format for the primary time display.

### Primary Time Display

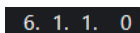

Shows the position of the project cursor in the selected time format.

### Select Secondary Time Format



Allows you to select a time format for the secondary time display.

### Secondary Time Display

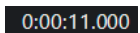

Shows the position of the project cursor in the selected time format.

## Markers

### Jump to Marker



Allows you to set and locate marker positions.

### Open Markers Window



Opens the **Markers** window.

## Pre-roll & Post-roll

### Activate Pre-roll



Activates pre-roll.

### Pre-roll Amount

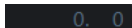

Allows you to set the pre-roll position. To show/hide this, click the points on the divider.

### Activate Post-roll



Activates post-roll.

### Post-roll Amount

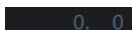

Allows you to set the post-roll position. To show/hide this, click the points on the divider.

## Tempo & Time Signature

### Activate Tempo Track



Allows you to activate/deactivate the tempo track.

### Tempo



Allows you to set the tempo value.

### Time Signature



Allows you to set the first time signature value. To show/hide this, click the points on the divider.

## Right Divider

### Right Divider



Tools that are placed to the right of the divider are always shown.

## Activate External Sync

### Activate External Sync



Activates external synchronization.

### Open Synchronization Setup



Allows you to open the **Project Synchronization Setup** dialog.

## Click & Count-in

### Activate Metronome Click





Activates the metronome click.

#### Activate Count-in



Activates the metronome click in count-in.

#### Click Pattern



Allows you to set up a click pattern. To show/hide this, click the points on the divider.

#### Open Metronome Setup



Opens the **Metronome Setup** dialog. To show/hide this, click the points on the divider.

### Input/Output Activity

#### MIDI In Activity



Displays the MIDI input signals.

#### MIDI Out Activity



Displays the MIDI output signals.

#### Audio Activity



Displays the audio input/output signals.

#### Audio Clipping



Displays audio clipping.

#### Level Display



Displays the output level.

#### Level Control



Allows you to control the output level.

### Set up Transport Bar

#### Set up Transport



Opens a pop-up menu where you can set up which elements are visible.

## Transport Pop-Up Window

The **Transport** pop-up window allows you to access specific transport commands if the **Transport** panel, the **Transport Bar**, and the **Transport Controls** in the **Project** window toolbar are closed or hidden.

The following default key commands open the **Transport Bar** pop-up window:

**Enter Left Locator**

Shift-L

**Enter Right Locator**

Shift-R

**Enter Project Cursor Position**

Shift-P

**Enter Tempo**

Shift-T

**Enter Time Signature**

Shift-C

**Enter Punch In Position**

Shift-I

**Enter Punch Out Position**

Shift-O

**Go to Left Locator**

Num 1

**Go to Right Locator**

Num 2

Using a specific key command opens the corresponding section of the **Transport** pop-up window:

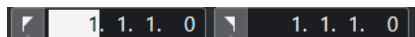

Transport pop-up window for entering the left **Locator** position.

**NOTE**

To close the **Transport** pop-up window, press **Esc**.

---

## Time Display Window

The **Time Display** window allows you to view the current time position in a separate window. You can adjust its size and specify the time format that you want to display.

- To open the **Time Display** window, select **Studio > More Options > Time Display**.

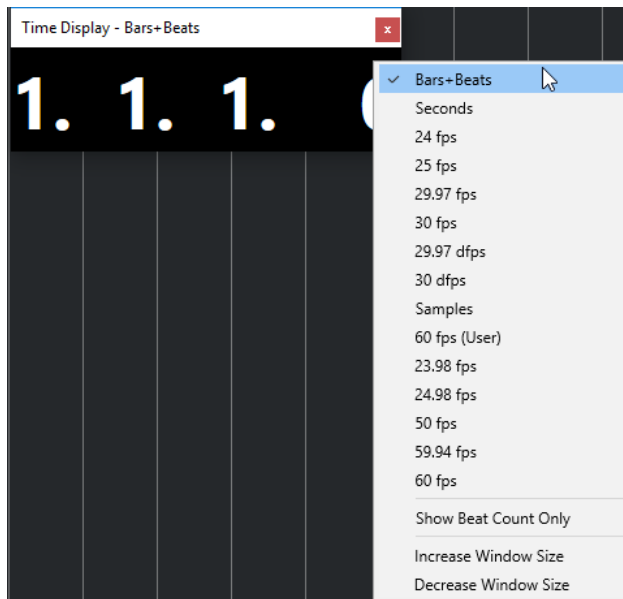

Right-click the window to access the following options:

**Bars+Beats**

Displays the time in bars and beats.

**Seconds**

Displays the time in seconds.

**fps**

Displays the time in frames per second.

**Samples**

Displays the time in samples.

**Show Beat Count Only**

Shows the beat counts only. This is useful if you want to use the **Time Display** window as a visual metronome.

**Increase Window Size**

Increases the size of the window and the displayed values.

**Decrease Window Size**

Decreases the size of the window and the displayed values.

**NOTE**

You can set up the **Window Transparency** in the **Studio Setup** dialog (**Time Display** page).

---

RELATED LINKS

[Time Signature Events](#) on page 792

## Left and Right Locators

The left and right locators are a pair of markers that you can use as reference positions in the **Project** window and in the editors.

Locators help you, for example, to do the following:

- Positioning the project cursor.

- Defining start and stop positions for recording.
- Defining start positions for importing or exporting events.
- Setting up a cycle range.
- Selecting, copying, creating or splitting events.



Locators are indicated by the flags in the ruler.

The area between the left and the right locator is the locator range. The locator range is highlighted in the ruler and the event display.

#### NOTE

In the event display of the MIDI editors, the locator range is only highlighted if **Show Part Borders** is deactivated.

- To activate/deactivate cycle mode, click the locator range in the upper part of the ruler, or activate **Activate Cycle** in the transport controls.

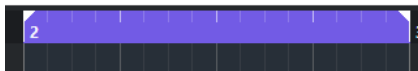

- **NOTE**

If you activate cycle mode, and the right locator is positioned before the left locator, the locator range is skipped during playback.



#### RELATED LINKS

- [Project Window Toolbar](#) on page 32
- [Setting the Project Cursor](#) on page 214
- [Activating Recording Manually](#) on page 231
- [Activating Recording Automatically](#) on page 231
- [Cycle Recording](#) on page 233
- [Punch In and Punch Out](#) on page 217
- [Common Record Modes Menu](#) on page 234
- [Import Options for MIDI Files](#) on page 258
- [Export Options Dialog for MIDI Files](#) on page 142
- [Export Audio Mixdown](#) on page 800
- [Setting the Locators Using Cycle Markers](#) on page 300
- [Select Submenu](#) on page 175
- [Select Menu for Selection Ranges](#) on page 189
- [Cut, Copy, and Paste of Selection Ranges](#) on page 192
- [Audio Parts](#) on page 172
- [MIDI Parts](#) on page 172
- [Signature Track Controls](#) on page 135
- [Fill Loop](#) on page 185
- [Splitting Events](#) on page 181
- [Transport](#) on page 904

## Setting the Left Locator

Setting the left locator can be useful if you want to add a reference position in the **Project** window and in the editors.

---

### PROCEDURE

- Do one of the following:
    - Press **Ctrl/Cmd** and click in the upper part of the ruler to set the left locator to that position.
    - Adjust the **Left Locator Position** value.  
This is available in the **Locators** section of the **Project** window toolbar, the editor toolbars, the **Transport** panel, and the **Transport Bar**.
    - Drag the left locator handle in the upper part of the ruler.
    - Press **Ctrl/Cmd**, and on the numeric keypad press **1** to set the left locator to the project cursor position.
    - Press **Alt** and click **Go to Left Locator Position** on the **Transport** panel.
- 

## Setting the Right Locator

Setting the right locator can be useful if you want to add a reference position in the **Project** window and in the editors.

---

### PROCEDURE

- Do one of the following:
    - Press **Alt** and click in the upper part of the ruler to set the right locator to that position.
    - Adjust the **Right Locator Position** value.  
This is available in the **Locators** section of the **Project** window toolbar, the editor toolbars, the **Transport** panel, and the **Transport Bar**.
    - Drag the right locator handle in the upper part of the ruler.
    - Press **Ctrl/Cmd**, and on the numeric keypad press **2** to set the right locator to the project cursor position.
    - Press **Alt** and click **Go to Right Locator Position** on the **Transport** panel.
- 

## Setting up Locator Ranges

You can set up the locator range, that is, the area between the left and the right locator.

---

### PROCEDURE

- Do one of the following:
    - Click and drag in the upper part of the ruler.
    - Select a range or an event and press **P** to set the locators to the selection.
    - Double-click a cycle marker.
    - Press **Ctrl/Cmd-Alt** and click at a position in the upper part of the ruler to set both locators to the nearest snap position.
- 

### RESULT

The locator range is set up and highlighted in the ruler and the event display.

## Moving Locator Ranges

In the ruler, you can move the locator range.

### PREREQUISITE

You have set up a locator range.

---

### PROCEDURE

1. Move the mouse pointer to the upper part of the ruler inside a locator range.  
A hand symbol is shown.
  2. Click and drag to the left or to the right to move the locator range.
- 

## Setting the Project Cursor

You can set the project cursor to the position where you click, or to markers or other predefined positions.

---

### PROCEDURE

- Do one of the following:
    - Hold down **Shift-Alt** and click in the **Project** window event display.
    - Click **Go to Previous Marker/Zero** or **Go to Next Marker/Project End**.  
These are available in the **Transport Controls** section of the **Project** window toolbar, the editor toolbars, the **Transport** panel, and the **Transport Bar**.
    - Click in the lower part of the ruler.
    - Select **Transport > Set Project Cursor Position**, and select an entry in the submenu.
- 

### RELATED LINKS

[Transport Panel Sections](#) on page 194

[Ruler](#) on page 42

[Transport Menu](#) on page 199

[Transport](#) on page 904

[Transport Bar](#) on page 204

[Left and Right Locators](#) on page 211

[Key Commands](#) on page 854

## Auto-Scroll Settings Menu

**Auto-Scroll** allows you to keep the project cursor visible in the window during playback.

If you activate **Auto-Scroll** on the toolbar of the **Project** window or one of the editors, the following modes are available in the **Select Auto-Scroll Settings** pop-up menu:

### Page Scroll

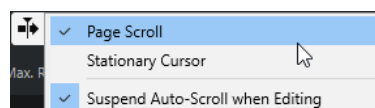

The project cursor moves from the left side to the right side of the window. When the project cursor reaches the right side of the window, the ruler and the project cursor jump to the left side of the window and start over again. This behavior can be compared to turning a page of a book.

### Stationary Cursor

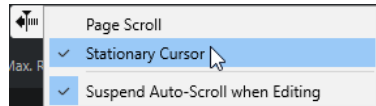

The project cursor is kept in the middle of the window and the ruler scrolls continuously to the left.

#### RELATED LINKS

[Project Window Toolbar](#) on page 32

## Suspend Auto-Scroll When Editing

If you do not want the **Project** window display to change when editing during playback, activate **Suspend Auto-Scroll when Editing**.

**Suspend Auto-Scroll when Editing** is available as an option in the **Select Auto-Scroll Settings** pop-up menu to the right of the **Auto-Scroll** button.

If this option is activated, auto-scrolling is suspended as soon as you click anywhere in the event display during playback until playback stops or you click **Auto-Scroll** again.

As a visual feedback, the **Auto-Scroll** button changes its color.

## Time Formats

You can set up different time formats.

### Selecting the Primary Time Format

On the **Transport** panel, you can select the primary time format. This is the global display format that is used for all rulers and position displays in the program, except the ruler tracks.

---

#### PROCEDURE

1. In the main transport section on the **Transport** panel, click **Select Primary Time Format**.
2. Select a time format from the pop-up menu.

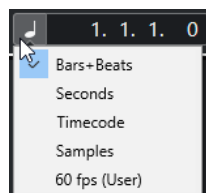

You can also select **Project > Project Setup > Display Format** to select the primary time format.

---

#### RESULT

The time format on the **Transport** panel and all rulers and position displays is updated.

## Independent Time Displays

You can show time displays that are independent from the global display format.

To select an independent time display, do one of the following:

- In the ruler of the **Project** window or any editor, click the arrow button to the right of the ruler.

- Select **Project > Add Track > Ruler** to add a ruler track, and right-click the ruler.
- In the **Main Transport** section of the **Transport** panel, click **Select Secondary Time Format**.

RELATED LINKS

[Ruler](#) on page 42

[Ruler Track](#) on page 123

## Pre-Roll and Post-Roll

You can activate pre-roll and post-roll with the corresponding buttons in the **Pre-roll & Post-roll** section on the **Transport** panel or by selecting **Transport > Pre-roll & Post-roll > Use Pre-roll/Use Post-roll**.

NOTE

To show the **Pre-roll & Post-roll** section, right-click anywhere in the **Transport** panel or in the **Transport Bar** and activate **Pre-roll & Post-roll**.

---

- By setting a pre-roll value, you instruct Cubase to roll back a short section whenever playback is activated.

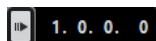

- By setting a post-roll value, you instruct Cubase to play back a short section after automatic punch out before stopping.

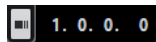

NOTE

This only works if **Punch Out** is activated on the **Transport** panel, and if **Stop after Automatic Punch Out** is activated in the **Preferences** dialog (**Record** page).

---

## Using Pre-Roll and Post-Roll



You can set up a pre-roll and a post-roll value for recording.

PREREQUISITE

On the **Transport** panel, **Lock Punch Points to Locators** is activated.

---

PROCEDURE

1. Set the locators to where you want to start and end recording.
  2. On the **Transport** panel or in the **Transport Bar**, activate **Punch In** and **Punch Out**.
  3. In the **Preferences** dialog, select **Record**.
  4. Activate **Stop after Automatic Punch Out**.
  5. Right-click anywhere on the **Transport** panel or in the **Transport Bar** and activate **Pre-roll & Post-roll**.
  6. In the **Pre-roll & Post-roll** section, activate **Pre-roll**  and **Post-roll** .
  7. In the **Pre-roll Amount** and **Post-roll Amount** fields, enter the pre-roll and post-roll values.
  8. Activate **Record**.
-



#### RESULT

The project cursor rolls back by the specified pre-roll value and playback starts. When the cursor reaches the left locator, recording is automatically activated. When the cursor reaches the right locator, recording is deactivated, but playback continues for the specified post-roll value before stopping.

## Punch In and Punch Out

The punch in and the punch out points are a pair of markers that you can use for punch in and punch out of recordings. The punch in position determines the record start position and the punch out position determines the record stop position.

You can activate punch in and punch out by activating the corresponding buttons on the **Transport** panel.

The punch in position is locked to the left locator position and the punch out position to the right locator position. The punch position fields are unavailable.



However, you can detach the punch points from the locators by deactivating **Lock Punch Points to Locators**.

If you do so, the value fields become available and you can use them to set up the punch positions independently from the locator positions.

You can also drag the punch in and punch out handles in the ruler to set the punch positions.

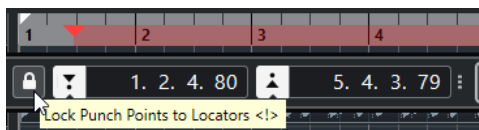

#### RELATED LINKS

[Activating Recording Automatically](#) on page 231

[Stopping Recording Automatically with Punch Out](#) on page 232

## Metronome Click

You can use the metronome click as a timing reference for playing along and recording. The two parameters that govern the timing of the metronome are project tempo and the time signature that you can set up on the **Transport** panel.

- To activate the metronome click, activate **Activate Metronome Click** on the **Transport** panel.  
You can also select **Transport > Activate Metronome** or use the corresponding key command.
- To define if the metronome click is played during playback, recording or count-in, select **Transport > Metronome Setup** and make your changes on the **General** tab.
- To set up the sounds for the metronome click, select **Transport > Metronome Setup** and make your changes on the **Click Sounds** tab.

#### RELATED LINKS

[Transport Panel Sections](#) on page 194

[Project Tempo Modes](#) on page 782

## Click Patterns

Click patterns allow you to create a custom metronome click.

By default, the metronome click in Cubase has a 4/4 pattern with a fixed number of 4 clicks. The click level of the first click is high, while the level of the other beats is low.



The default metronome click pattern with 4 clicks at a 4/4 time signature

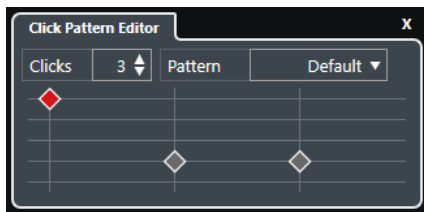

A metronome click pattern with 3 clicks at a 3/4 time signature

By setting up click patterns for the metronome at the current time signature, you can create a custom metronome click. You can determine the number of clicks and the level of the clicks to your liking.

If you have different project parts with different time signatures or tempos, and you want to set up different click patterns to match the rhythm and feel of these parts, you can set up a metronome click pattern for each signature event in your project.

You can also add the same time signature for different sections and set up different patterns for them.

### NOTE

- If you want to visualize the current click pattern in the **Project** window, **Key Editor** or **Drum Editor** event display, activate **Use Metronome Click Pattern Level for Grid Line Emphasis** in the corresponding ruler context menu. This is useful if **Snap** is activated and the **Snap Type** is set to **Grid**.
- Grid lines are only emphasized if they are shown. If you want to visualize a click pattern that is set to 6 **Clicks** and a 4/4 **Time Signature**, you must set the **Grid Type** to a triplet value.

---

The **Click Patterns** tab in the **Metronome Setup** dialog allows you to manage the available click patterns. You can remove and rename them or create new click patterns for specific time signatures.

### RELATED LINKS

[Click Pattern Editor](#) on page 219

[Setting up a Metronome Click Pattern](#) on page 219

[Setting up Metronome Click Patterns for Signature Events](#) on page 220

[Project Window Toolbar](#) on page 32

## Click Pattern Editor

The **Click Pattern Editor** allows you to set up a click pattern for your project to create new grooves and feels for the metronome click. This is useful if you want to create a triplet pattern for a 4/4 signature, for example.

The **Click Pattern Editor** is available in the **Transport Bar**. If you add a signature track, it is available in the **Inspector** and on the info line.

- To open the **Click Pattern Editor** in the **Transport Bar**, click the points to the right of the **Click & Count-in & Click Pattern** section and drag all the way to the right. Click the pattern field to open the **Click Pattern Editor**.

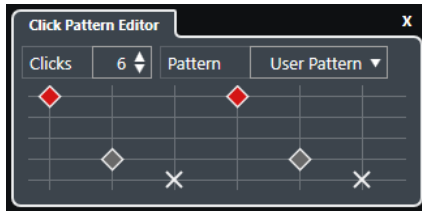

### Clicks

Allows you to define the number of clicks that are used in the pattern.

### Pattern

Allows you to select a pattern preset or to save your own ones. Which patterns are available depends on the current time signature, and on the settings in the **Metronome Setup** dialog on the **Click Patterns** tab.

#### NOTE

To view, edit and rename the pattern presets, open the **Click Patterns** tab in the **Metronome Setup** dialog.

---

### Event display

Shows the defined number of beats for the selected pattern.

You can change the accent level for a beat by changing its vertical position in the event display. There are 4 different settings. These correspond to the settings in the **Metronome Setup** dialog on the **Click Sounds** tab. You can mute a beat by clicking the lowest vertical position.

#### RELATED LINKS

[Transport Bar Sections](#) on page 204

[Signature Track](#) on page 134

## Setting up a Metronome Click Pattern

You can set up a different metronome click pattern for your project.

---

#### PROCEDURE

1. In the **Transport Bar**, click the points to the right of the **Click & Count-in & Click Pattern** section and drag all the way to the right to show the click pattern section.
2. Click the pattern field to open the **Click Pattern Editor**.
3. Do one of the following:
  - Open the **Pattern** pop-up menu and select one of the presets.
  - Use the **Clicks** setting to define the number of clicks that you want to hear, and click in the event display to set up a new click pattern.
4. When you are done, click outside the **Click Pattern Editor** to close it.

5. Activate the metronome click.
- 

#### RESULT

The metronome click is played back with the defined click pattern.

#### RELATED LINKS

[Click Pattern Editor](#) on page 219

[Transport Bar Sections](#) on page 204

## Setting up Metronome Click Patterns for Signature Events

You can set up a metronome click pattern for each signature event in your project. This is useful if you have different project parts with different time signatures, and you want to customize click patterns to the rhythm and feel of these parts. You can also add the same time signature for different sections and set up different patterns for them.

---

#### PROCEDURE

1. Double-click the plus sign to open the **Click Pattern Editor**.
  2. Do one of the following:
    - Open the **Pattern** pop-up menu and select one of the presets.
    - Use the **Clicks** setting to define the number of clicks that you want to hear, and click in the event display to set up a new click pattern.
  3. When you are done, click outside the **Click Pattern Editor** to close it.
  4. Repeat this for each signature event for which you want to set up a click pattern.
- 

#### RESULT

If you play back the project and activate the metronome click, the different project parts use the defined click patterns. The **Click Pattern Editor** in the **Transport Bar** shows the pattern at the project cursor position.

#### RELATED LINKS

[Click Pattern Editor](#) on page 219

[Signature Track](#) on page 134

[Time Signature Events](#) on page 792

## Metronome Setup Dialog

The **Metronome Setup** dialog allows you to make settings for the metronome.

To open the **Metronome Setup** dialog, do one of the following:

- Select **Transport > Metronome Setup**.
- In the **Transport Bar**, open the **Click & Count-in & Click Pattern** section, and click **Open Metronome Setup**.

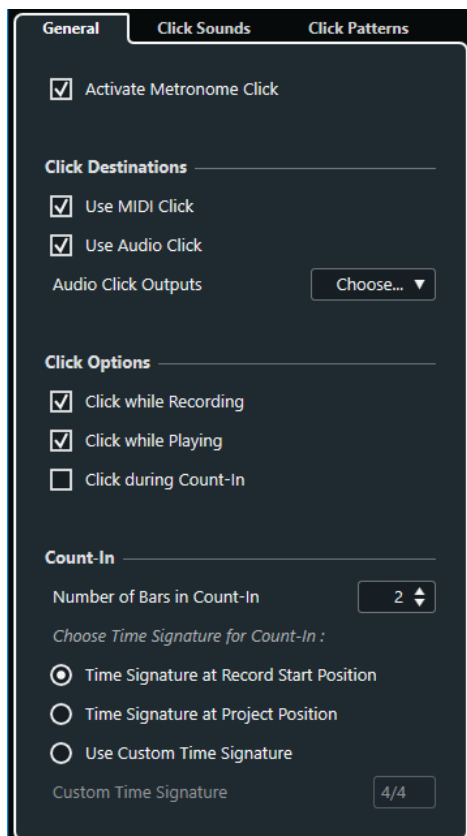

#### RELATED LINKS

[General Tab](#) on page 222

[Click Sounds Tab](#) on page 223

[Click Patterns Tab](#) on page 225

[Transport Bar Sections](#) on page 204

## General Tab

The **General** tab allows you to make basic metronome settings.

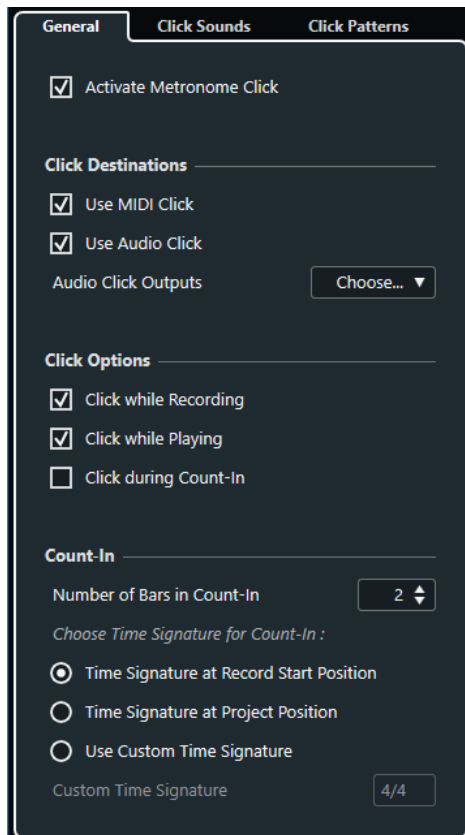

In the topmost section, the following options are available:

### Activate Metronome Click

Activates/Deactivates the metronome click.

In the **Click Destinations** section, the following options are available:

### Use MIDI Click

Activates a MIDI click for the metronome.

### Use Audio Click

Activates an audio click for the metronome that is output via the audio hardware.

### Audio Click Outputs

If you use multiple output busses, this allows you to activate the output bus where you want to route the metronome click.

In the **Click Options** section, the following options are available:

### Click while Recording

Activates the metronome click during recording.

### Click while Playing

Activates the metronome click during playback.

### Click during Count-In

Activates a musical count-in that is played when you start recording from stop mode.

In the **Count-In** section, the following options are available:

- **Number of Bars in Count-In**  
Allows you to set the number of bars that the metronome counts in before recording starts.
- **Time Signature at Record Start Position**  
Activate this to let the count-in automatically use the time signature and tempo set at the position where recording starts.
- **Time Signature at Project Position**  
Activate this to let the count-in use the time signature at the project position.
- **Use Custom Time Signature**  
Allows you to set a time signature for the count-in. In this mode, signature changes in the project do not affect the count-in.

## Click Sounds Tab

The **Click Sounds** tab allows you to set up and audition the MIDI click and the audio click. You can use the default audio or MIDI click, choose from a list of factory preset sounds, or assign your own custom sounds.

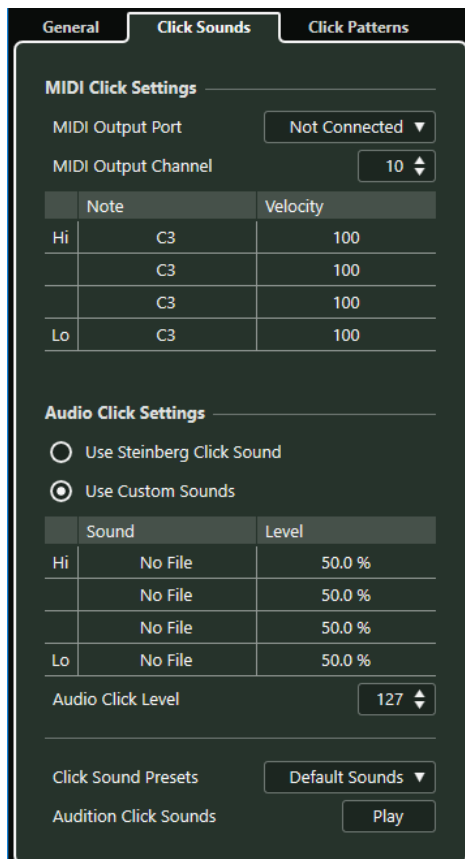

The **MIDI Click Settings** section allows you to set up the MIDI click that sounds if you activate **Use MIDI Click** in the **Click Destinations** section on the **General** tab.

### MIDI Output Port

Allows you to select a MIDI output port for the MIDI click. You can also select a VST instrument previously set up in the **VST Instruments** window.

### MIDI Output Channel

Allows you to select a MIDI output channel for the MIDI click.

### Note

Allows you to set the MIDI note number, that is, the pitch from C-2 to G8. Set the note number for the first beat in a bar in the top row, and the note numbers for the other beats in the rows below.

### Velocity

Allows you to set the velocity of the MIDI click sound. Set the velocity for the first beat in a bar in the top row, and the velocities for the other beats in the rows below.

The **Audio Click Settings** section allows you to set up the audio click that sounds if you activate **Use Audio Click** in the **Click Destinations** section on the **General** tab.

### Use Steinberg Click Sound

Activates the default sounds for the metronome click.

### Pitch

Allows you to set the pitch for the default sounds. Set the pitch for the first beat in a bar in the top row, and the pitches for the other beats in the rows below.

### Level

Allows you to set the level for the default sounds. Set the level for the first beat in a bar in the top row, and the levels for the other beats in the rows below.

### Use Custom Sounds

Activates custom sounds for the metronome click. For this to work, you must select an audio file for the custom sounds by clicking in the **Sound** column.

### Sound

Allows you to select an audio file for the custom sounds. Select an audio file for the first beat in a bar in the top row, and the audio files for the other beats in the rows below.

### Level

Allows you to set the level for the custom sounds. Set the level for the first beat in a bar in the top row, and the levels for the other beats in the rows below.

### Audio Click Level

Allows you to adjust the level of the audio click.

### Click Sound Presets

Allows you to load one of the click sound presets that supports up to 4 accents. Amongst other click sounds that are suited for a broad range of applications, you can also select **Steinberg Click Sound**, the default click sound of Cubase.

You can also create your own presets and save them.

### Audition Click Sounds

Click **Play** to audition the activated click sounds.

## Setting up a Custom Audio Click Sound

If you do not want to use the default click sound, you can set up your own custom sound.

### PREREQUISITE

In the **Metronome Setup** dialog on the **General** tab, **Activate Metronome Click** is activated. In the **Click Destinations** section, **Use Audio Click** is activated.

---

### PROCEDURE

1. Open the **Click Sounds** tab, and in the **Audio Click Settings** section, activate **Use Custom Sounds**.



2. In the **Sound** column, click the top row.
3. In the file dialog, navigate to the audio file that you want to use as a custom sound for the first beat and select it.
4. Click **Open**.
5. Click the other rows to select audio files for the other beats.
6. Set the level of the sounds by clicking the respective rows in the **Level** column and adjusting the value.
7. Optional: Click **Play** to audition the custom sounds.

#### RESULT

The metronome uses the defined custom sounds for the audio click.

#### AFTER COMPLETING THIS TASK

Open the **Click Sound Presets** pop-up menu and save your custom sounds as a preset.

## Click Patterns Tab

The **Click Patterns** tab allows you to manage click patterns. Click patterns allow you to edit the default metronome click.

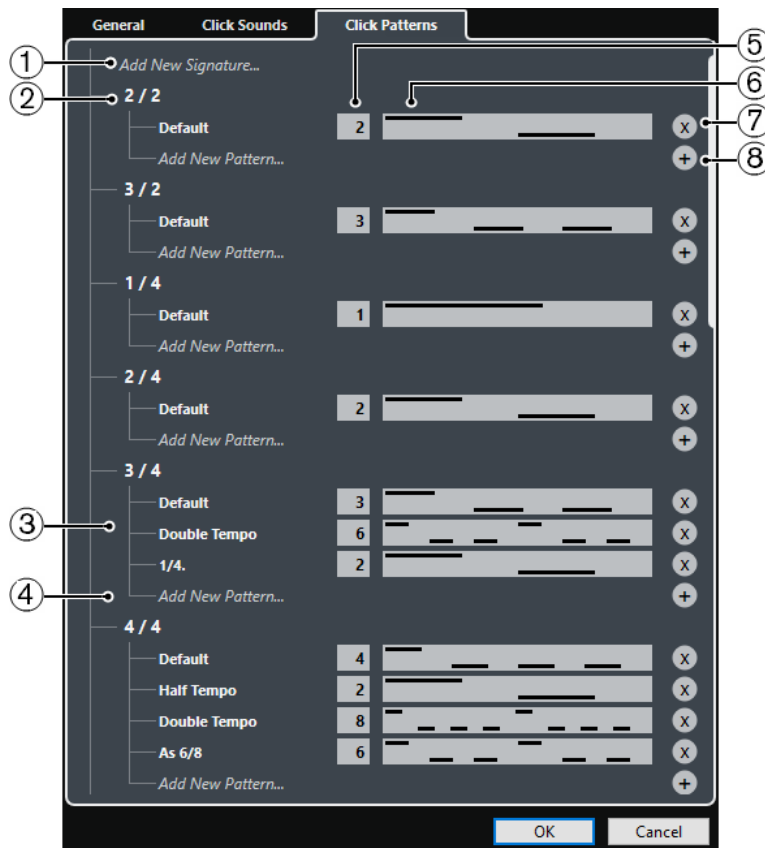

The following options are available:

- 1 **Add New Signature**  
Click and enter a time signature value to add a new time signature.
- 2 **Available Time Signatures**  
Shows the available time signatures.
- 3 **Available Patterns**  
Shows the available click patterns.

- 4 Add New Pattern**  
Double-click to add a new click pattern for the time signature.
- 5 Clicks**  
Allows you to change the number of clicks used in the click pattern.
- 6 Click Pattern**  
Shows the click pattern. You can open the **Click Pattern Editor** by clicking the pattern.
- 7 Remove Click Pattern**  
Removes the click pattern from the list of available patterns.
- 8 Add New Pattern**  
Adds a new default click pattern for the time signature.

#### NOTE

If you scroll all the way down, you can reset all click patterns to the factory settings by clicking **Reset to Factory Patterns**.

You can double-click the name of a pattern to rename it.

---

## Creating a Click Track

You can create an audio or a MIDI track that contains the click.

---

#### PROCEDURE

- Do one of the following:
    - Select **Project > Signature Track > Render Audio Click between Locators**.
    - Select **Project > Signature Track > Render MIDI Click between Locators**.
- 

#### RESULT

- An audio track containing an audio event with the click is added to your project. The level corresponds to the **Audio Click Level** setting on the **Click Sounds** tab of the **Metronome Setup** dialog.
- A MIDI track containing a MIDI part with the click is added to your project. The output of the MIDI track is routed to the **MIDI Output Port** that you set up on the **Click Sounds** tab of the **Metronome Setup** dialog.

## Chase

**Chase** is a function that makes sure your MIDI instruments sound as they should when you locate to a new position and start playback. This is accomplished by the program transmitting a number of MIDI messages to your instruments each time that you move to a new position in the project, making sure all MIDI devices are set up correctly with regard to program change, controller messages (such as MIDI volume), etc.

---

#### EXAMPLE

You have a MIDI track with a program change event inserted at the beginning. This event makes a synth switch to a piano sound.

At the beginning of the first chorus, you have another program change event which makes the same synth switch to a string sound.

You now play back the song. It begins with the piano sound and then switches to the string sound. In the middle of the chorus you stop and rewind to some point between the beginning and the second program change. The synth now still plays the string sound although in this section it really should be a piano.

The **Chase** function takes care of that. If program change events are set to be chased, Cubase tracks the music back to the beginning, finds the first program change, and transmits it to your synth, setting it to the correct sound.

---

The same can apply to other event types as well. In the **Preferences** dialog (**MIDI** page), the **Chase Events** settings determine which event types are chased when you locate to a new position and start playback.

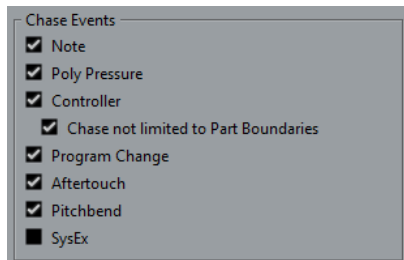

RELATED LINKS

[Chase Events](#) on page 898

# On-Screen Keyboard

The **On-Screen Keyboard** allows you to play and record MIDI notes by using your computer keyboard or mouse. This is useful if you have no external MIDI instrument at hand and you do not want to draw in notes with the **Draw** tool.

When the **On-Screen Keyboard** is displayed, the usual key commands are blocked because they are reserved for the **On-Screen Keyboard**. The only exceptions are:

- Save: **Ctrl/Cmd-S**
- Start/Stop Record: **Num \***
- Start/Stop Playback: **Space**
- Jump to Left Locator: **Num 1**
- Delete: **Delete** or **Backspace**
- Cycle on/off: **Num /**
- Show/Hide Transport panel: **F2**
- Show/Hide On-Screen Keyboard: **Alt-K**

## Recording MIDI With the On-Screen Keyboard

You can use the **On-Screen Keyboard** to record MIDI in Cubase.

### PREREQUISITE

You have selected a MIDI or instrument track and activated **Record Enable**.

---

### PROCEDURE

1. Select **Studio > On-Screen Keyboard**.
2. Activate **Record**.
3. Perform one of the following actions to enter some notes:
  - Click on the keys of the **On-Screen Keyboard**.
  - Press the corresponding key on your computer keyboard.

### NOTE

Press several keys simultaneously to enter polyphonic parts. The maximum number of notes that can be played at one time varies between the different operating systems and hardware configurations.

---

### AFTER COMPLETING THIS TASK

Close the **On-Screen Keyboard** to make all key commands available again.

## On-Screen Keyboard Options

The **On-Screen Keyboard** offers different display modes as well as other options.

- To open the **On-Screen Keyboard**, select **Studio > On-Screen Keyboard**.

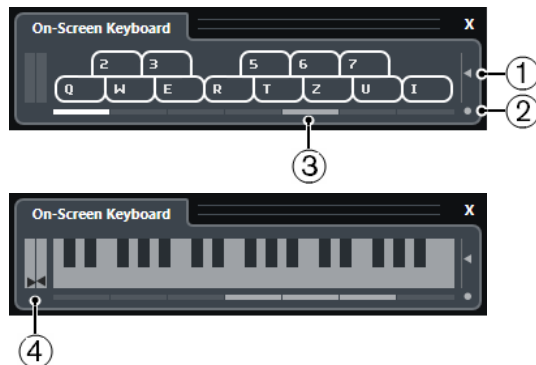

### 1 Note Velocity Level

This slider allows you to adjust the volume of the **On-Screen Keyboard**. You can also use **Up Arrow** or **Down Arrow** for this.

### 2 Change On-Screen Keyboard Type

This button allows you to switch between computer keyboard and piano keyboard display mode.

In computer keyboard mode, you can use the two rows of keys that are displayed on the **On-Screen Keyboard** to enter notes.

The piano keyboard has a wider range of keys. It allows you to enter more than one voice simultaneously. You can also use **Tab** for this.

### 3 Octave Offset

These buttons allow you to switch the keyboard range to a lower or higher octave. You have seven full octaves at your disposal. You can also use **Left Arrow** or **Right Arrow** for this.

### 4 Pitchbend/Modulation Sliders

These sliders are only available in piano keyboard mode. The left slider displays pitchbend, the right slider shows modulation changes. To introduce modulation, click on a key and drag upwards or downwards. To introduce pitchbend, drag left or right.

# Recording

In Cubase, you can record audio and MIDI.

Make the following initial preparations:

- Set up, connect, and calibrate your audio hardware.
- Open a project and set up the parameters in the **Project Setup** dialog according to your specifications.  
The parameters in the **Project Setup** dialog determine the record file format, sample rate, project length, etc. that affect the audio recordings that you make during the course of the project.
- If you plan to record MIDI, set up and connect your MIDI equipment.

## RELATED LINKS

[Setting up Audio](#) on page 13

[Setting up MIDI](#) on page 20

[Setting up a Metronome Click Pattern](#) on page 219

## Basic Recording Methods

The basic recording methods apply to audio and MIDI recordings.

## Record Enabling Tracks

To be able to record, you must record-enable the tracks on which you want to record.

---

### PROCEDURE

- Do one of the following:
  - Activate **Record Enable** in the track list.
  - Activate **Record Enable** in the **MixConsole**.
  - Select the track that you want to record-enable, and activate **Record Enable** in the **Inspector**.

---

### RESULT

The tracks are record-enabled.

---

### NOTE

If you set up a key command for **Activate Record Enable for all Audio Tracks** in the **Mixer** category of the **Key Commands** dialog, you can record-enable all audio tracks simultaneously. The exact number of audio tracks that you can record simultaneously depends on your computer CPU and hard disk performance. Activate the **Warn on Processing Overloads** option in the **Preferences** dialog (**VST** page) to show a warning message as soon as the CPU overload indicator lights up during recording.

---

RELATED LINKS

[Editing - Project & MixConsole](#) on page 892

[VST](#) on page 907

## Record Enabling Tracks on Selection

You can set up a preference so that tracks are record-enabled when you select them.

---

PROCEDURE

1. Select **Edit > Preferences**.
2. Open the **Editing—Project & MixConsole** page and activate **Enable Record on Selected Audio Track** or **Enable Record on Selected MIDI Track**.

---

RESULT

The tracks are record-enabled when you select them.

## Activating Recording Manually

You can activate recording manually.

---

PROCEDURE

- Do one of the following:
  - Click **Record** on the **Transport** panel, on the toolbar, or in the **Transport Bar**.
  - Press **Num \***.

---

RESULT

Recording starts from the current cursor position.

NOTE

When you start recording in stop mode, you can start recording from the left locator. For this to work, you must select **Transport > Common Record Modes** and activate **Start Record at Left Locator/Punch In Position**. The pre-roll setting or the metronome count-in will be applied.

---

## Activating Recording Automatically

Cubase can automatically switch from playback to recording at a given position. This is useful if you must replace a section of a recording and want to listen to what is already recorded up to the recording start position.

---

PROCEDURE

1. Set the left locator to the position where you want to start recording.  
If you want to set up the punch points independently from the locators, deactivate **Lock Punch Points to Locators** on the **Transport** panel, and set up the punch in and punch out positions in the value fields to the right.
2. Activate **Punch In** on the **Transport** panel.
3. Activate playback from any position before the left locator.

---

RESULT

If you have unlocked the punch positions from the locator positions, recording is automatically activated when the project cursor reaches the punch in position.

If cycle mode is activated, and the punch in point corresponds to the left locator position, and the punch out point is positioned before the right locator, recording is stopped at the punch out position and resumed at the punch in position.



If the punch positions are locked to the locators, recording is automatically activated when the project cursor reaches the left locator.

RELATED LINKS

[Punch In and Punch Out](#) on page 217

## Stopping Recording

You can stop recording manually.

---

PROCEDURE

- Do one of the following:
  - Click **Stop** on the **Transport** panel.
  - Press **Num \***.

---

RESULT

Recording stops while playback continues.

## Stopping Recording Automatically with Punch Out

Activating **Punch Out** allows you to stop recording automatically at the defined punch out position.

---

PROCEDURE

- Activate **Punch Out** on the **Transport** panel.

---

RESULT

Recording stops automatically when the project cursor reaches the punch out position. Playback continues.

**NOTE**

If you have unlocked the punch positions from the locator positions, recording is automatically stopped when the project cursor reaches the punch out position.

**NOTE**

If cycle mode is activated, the punch in point is set after the left locator, and the punch out point corresponds to the right locator, recording is started at the punch in position, stopped at the punch out position, and resumed at the punch in position.

---

RELATED LINKS

[Punch In and Punch Out](#) on page 217



## Stopping Recording and Playback

You can stop recording and playback manually.

---

### PROCEDURE

- Do one of the following:
  - Click **Stop** on the **Transport** panel.
  - Press **Num 0**.

---

### RESULT

Recording and playback stops.

## Cycle Recording

You can record in a cycle, that is, you can record a selected section repeatedly and seamlessly.

### PREREQUISITE

A cycle is set up with the left and right locators.

---

### PROCEDURE

1. Click **Activate Cycle** on the **Transport** panel to activate cycle mode.
2. Activate recording from the left locator, before or within the cycle.  
As soon as the project cursor reaches the right locator, it jumps back to the left locator and continues recording a new lap.

---

### RESULT

The results of cycle recording depend on the selected record mode. They also differ for audio and MIDI.

### RELATED LINKS

[Left and Right Locators](#) on page 211

[MIDI Recording](#) on page 244

[Audio Recording](#) on page 239

## Using Pre-Roll and Post-Roll

You can set up a pre-roll and a post-roll for recording.

### PREREQUISITE

Activate **Stop after Automatic Punch Out** in the **Preferences** dialog (**Record** page).

---

### PROCEDURE

1. Set the locators to where you want to start and end recording.
  2. On the **Transport** panel, activate **Punch In** and **Punch Out**.
  3. Activate **Pre-roll** and **Post-roll**.
  4. Specify a **Pre-roll Amount** and a **Post-roll Amount**.
  5. Click **Record**.
-

#### RESULT

The project cursor rolls back and starts playback at the time that has been set as pre-roll amount. When the cursor reaches the left locator, recording is automatically activated. When the cursor reaches the right locator, recording is deactivated, and playback continues for the time that has been set as post-roll amount.

## Common Record Modes Menu

The **Common Record Modes** determine what happens if you click **Record** during an audio or MIDI recording.

- To access the record modes, select **Transport > Common Record Modes**.  
You can also access the **Common Record Modes** by clicking the upper part of the **Record Modes** section on the **Transport** panel.

#### Punch In/Out

In this mode, the recording is stopped.

#### Re-Record

In this mode, the recording is reinitiated, the events are removed, and recording is restarted from the exact same position.

#### Start Recording at Project Cursor Position

In this mode, recording starts from the cursor position.

#### Start Recording at Left Locator/Punch In Position

In this mode, recording starts from the left locator.

#### RELATED LINKS

[Transport Menu](#) on page 199

[Transport Panel Sections](#) on page 194

## Re-Recording

If you activate the **Re-Record** mode, you can reinitiate your recording by hitting the **Record** button again. Recording will restart from the initial position.

---

#### PROCEDURE

1. Select **Transport > Common Record Modes**, and activate **Re-Record**.
2. Activate recording.
3. Click **Record** again to restart recording.

---

#### RESULT

The project cursor jumps back to the record start position and recording is reinitiated. Pre-roll and count-in settings are taken into account.

#### NOTE

The previous recordings are removed from the project and cannot be retrieved using **Undo**. However, they remain in the **Pool**.

---

## Monitoring

In Cubase, monitoring means listening to the input signal while preparing to record or while recording.

The following ways of monitoring are available.

- Via Cubase.
- Externally by listening to the signal before it reaches Cubase.
- By using ASIO Direct Monitoring.  
This is a combination of both other methods.

## Monitoring via Cubase

If you use monitoring via Cubase, the input signal is mixed with the audio playback. This requires an audio hardware configuration with a low latency value.

---

### PROCEDURE

1. In the track list, activate **Monitor**.



2. In the **MixConsole**, adjust the monitoring level and the panning.  
You can add effects and EQ to the monitor signal using the track's channel. If you are using plug-in effects with large inherent delays, the automatic delay compensation function in Cubase will increase the latency. If this is a problem, you can use the **Constrain Delay Compensation** function while recording.
3. In the **Preferences** dialog, select **VST**.
4. Open the **Auto Monitoring** pop-up menu and select a monitoring mode.

---

### RESULT

The monitored signal will be delayed according to the latency value which depends on your audio hardware and drivers. You can check the latency of your hardware in the **Studio Setup** dialog (**VST Audio System** page).

### RELATED LINKS

[VST on page 907](#)

## External Monitoring

External monitoring means listening to the input signal before it is sent into Cubase. It requires an external mixer for mixing the audio playback with the input signal. The latency value of the audio hardware configuration does not affect the monitor signal. When using external monitoring, you cannot control the level of the monitor signal from within Cubase or add VST effects or EQ to the monitor signal.

---

### PROCEDURE

1. In the **Preferences** dialog, select **VST**.
  2. Open the **Auto Monitoring** pop-up menu and select **Manual**.
  3. Deactivate **Monitor** in Cubase.
  4. On your mixing desk or mixer application for your audio hardware, activate the **Thru** or **Direct Thru** mode to send the input audio back out again.
-

## ASIO Direct Monitoring

If your audio hardware is ASIO 2.0 compatible, it may support ASIO Direct Monitoring. This feature may also be available for audio hardware with macOS drivers. In ASIO Direct Monitoring mode, the monitoring is done in the audio hardware, and monitoring is controlled from Cubase. The latency value of the audio hardware configuration does not affect the monitor signal when using ASIO Direct Monitoring.

---

### PROCEDURE

1. In the track list, activate **Monitor**.



2. Select **Studio > Studio Setup**.
  3. In the **Devices** list, select your audio hardware driver, and activate **Direct Monitoring**. If the checkbox is grayed out, your audio hardware (or its driver) does not support ASIO Direct Monitoring. Consult the audio hardware manufacturer for details.
  4. In the **Preferences** dialog, select **VST**.
  5. Open the **Auto Monitoring** pop-up menu and select a monitoring mode.
  6. In the **MixConsole**, adjust the monitoring level and panning. Depending on the audio hardware, this might not be possible.
- 

### AFTER COMPLETING THIS TASK

You can monitor the input levels of audio tracks, that is, you can map the input bus metering to monitor-enabled audio tracks and watch the input levels of your audio tracks when working in the **Project** window.

- Activate **Map Input Bus Metering to Audio Track (in Direct Monitoring)** in the **Preferences** dialog (**Metering** page).  
As the tracks are mirroring the input bus signal you will see the same signal in both places. When using mapped metering, any functions that you apply to the audio track are not reflected in its meters.

### RELATED LINKS

[VST](#) on page 907

## Monitoring MIDI Tracks

You can monitor everything you play and record through the MIDI output and channel that are selected for the MIDI track.

### PREREQUISITE

Local Off is activated on your MIDI instrument.

---

### PROCEDURE

1. In the **Preferences** dialog, select **MIDI**.
2. Make sure **MIDI Thru Active** is activated.
3. In the track list, activate **Monitor**.



RESULT

Incoming MIDI is echoed back out again.

RELATED LINKS

[MIDI](#) on page 897

## Audio Recording Specifics

Specific preparations and settings are required for audio recording.

### Audio Recording Preparations

Before you can record audio, you must make some preparations.

#### Selecting a Record File Format

You can set up the record file format, that is, the sample rate, bit depth, and record file type for new audio files.

---

PROCEDURE

1. Select **Project > Project Setup**.
2. Set up the settings for **Sample Rate**, **Bit Depth**, and **Record File Type**.

**IMPORTANT**

The bit depth and file type can be changed at any time while the sample rate of a project cannot be changed at a later stage.

---

RELATED LINKS

[Creating New Projects](#) on page 80

#### Setting the Audio Record Folder

Each Cubase project has a project folder containing an **Audio** folder. By default, this is where recorded audio files are stored. However, you can select record folders independently for each audio track if needed.

---

PROCEDURE

1. In the track list, select all tracks to which you want to assign the same record folder.
2. Right-click one of the tracks to open the context menu.
3. Select **Set Record Folder**.
4. In the file dialog, navigate to the folder that you want to use as record folder or create a new folder by clicking **New Folder**.

If you want to have separate folders for different types of material (speech, ambient sounds, music, etc.), you can create subfolders within the project **Audio** folder and assign different tracks to different subfolders. This way, all audio files still reside within the project folder, which makes managing the project easier.

---

## Getting the Track Ready for Recording

Before you can record audio, you must add a track and set it up.

### Adding a Track and Setting the Channel Configuration

To record audio, you must add an audio track and set up its channel configuration. The channel configuration of the track determines the channel configuration of the recorded audio file.

---

#### PROCEDURE

1. In the global track controls area of the track list, click **Add Track** .
  2. Click **Audio**.
  3. In the **Count** value field, select the number of tracks that you want to add.
  4. Open the **Configuration** pop-up menu and select a channel configuration.
  5. Optional: In the **Name** field, enter a track name.
  6. Click **Add Track**.
- 

#### RELATED LINKS

[Add Track Dialog – Audio](#) on page 103

## RAM Requirements for Recording

Each track on which you record requires a certain amount of RAM, and the memory usage increases the longer the recording lasts. For each audio channel, 2.4 MB of RAM are required for **MixConsole** settings, etc. The memory usage increases with the length of the recording, the sample rate, and the number of tracks you record. Consider the RAM limitation of your operating system when setting up your project for recording.

## Selecting an Input Bus for the Track

Before you can record on your track, you must add and set up the required input busses and specify from which input bus the track will record.

---

#### PROCEDURE

1. In the **Inspector** for the audio track, open the **Input Routing** pop-up menu.

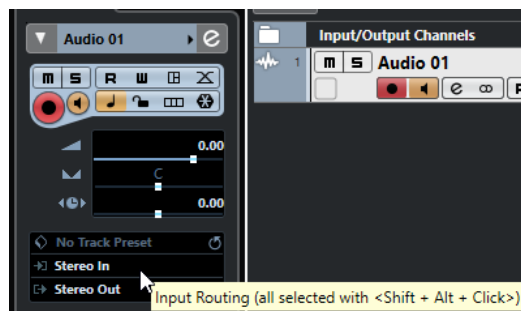

2. Select an input bus.
- 

#### RELATED LINKS

[Setting up Input and Output Ports](#) on page 19

[Audio Bus Setup](#) on page 19

[Audio Track Inspector](#) on page 105

## Audio Recording

You can record audio using any of the basic recording methods.

When you finish recording, an audio file is created in the **Audio** folder within the project folder. In the **Pool**, an audio clip is created for the audio file, and an audio event that plays the whole clip appears on the recording track. Finally, a waveform image is calculated for the audio event. If the recording was very long, this may take a while.

### NOTE

The waveform image is calculated and displayed during the actual recording process. This real-time calculation uses some processing power. If your processor is slow or if you are working on a CPU-intensive project, deactivate **Create Audio Images during Record** in the **Preferences** dialog (**Record—Audio** page).

---

### RELATED LINKS

[Basic Recording Methods](#) on page 230

[Cycle Recording](#) on page 233

## Audio Record Modes

By selecting an **Audio Record Mode**, you decide what happens to your recording and to any existing events on the track where you are recording. This is necessary because you will not always record on an empty track. There may be situations where you record over existing events, especially in cycle mode.

- To access the record modes, select **Transport > Audio Record Mode**.  
You can also access the **Audio Record Modes** by clicking to the right of the audio symbol in the **Record Modes** section on the **Transport** panel.

### Keep History

Existing events or portions of events that are overlapped by a new recording are kept.

### Cycle History + Replace

Existing events or portions of events that are overlapped by a new recording are replaced by the new recording. However, if you record in cycle mode, all takes from the current cycle recording are kept.

### Replace

Existing events or portions of events that are overlapped by a new recording are replaced by the last recorded take.

### RELATED LINKS

[Transport Menu](#) on page 199

[Transport Panel Sections](#) on page 194

## Recording and Effects

Cubase allows you to add effects and/or EQ directly while recording. This is done by adding insert effects and/or making EQ settings for the input channel in the **MixConsole**.

### IMPORTANT

If you record with effects, the effects become part of the audio file itself. You cannot change the effect settings after recording.

---

When you are recording with effects, consider using 32-bit float or 64-bit float format. This way, the bit depth will not be reduced, which means there is no risk of clipping at this stage. Also, this preserves the signal quality perfectly. If you record in 16-bit or 24-bit format, the available headroom is lower, which means clipping can occur if the signal is too loud.

## Recording a Mix of Separate Tracks

You can create a downmix of separate tracks, bass drum, hi-hats, or snare, for example. This is done by selecting an output bus, a group bus, or an FX channel bus as an input for your recording.

---

### PROCEDURE

1. Set up your separate tracks and add a group track.
2. For each of the drum tracks, open the **Output Routing** pop-up menu and select the group track as output.
3. Create a new audio track, open the **Input Routing** pop-up menu and select the group track as input for this audio track.
4. Record-enable this audio track and start recording.

---

### RESULT

The output of the group track will be recorded on the new track and you will get a mix of your separate tracks.

### NOTE

You can also select an FX channel as recording source. In this case, only the output of the FX channel will be recorded.

---

### RELATED LINKS

[Routing](#) on page 332

## Undoing Recordings

You can undo a recording immediately after recording it.

---

### PROCEDURE

- Select **Edit > Undo**.

---

### RESULT

- The events that you just recorded are deleted from the **Project** window.
- The audio clips in the **Pool** are moved to the trash folder.

### AFTER COMPLETING THIS TASK

To remove the recorded audio files from the hard disk, select **Media > Open Pool Window**, right-click the **Trash** icon and select **Empty Trash**.

### RELATED LINKS

[Pool Window](#) on page 476

## Recovery of Audio Recordings

Cubase allows you to recover audio recordings.

You can recover audio recordings in two situations:



- You hit **Record** too late.  
For this to work, you must specify an audio pre-record time.
- The system failed during recording.

## Specifying an Audio Pre-Record Time

You can capture up to 1 minute of any incoming audio that you play in stop mode or during playback. This is possible because Cubase can capture audio input in buffer memory, even when not recording.

---

### PROCEDURE

1. In the **Preferences** dialog, select **Record > Audio**.
2. Specify a time (up to 60 seconds) in the **Audio Pre-Record Seconds** field.  
This activates the buffering of audio input, making pre-record possible.
3. Make sure that an audio track is record-enabled and receives audio from the signal source.
4. When you have played some audio material that you want to capture (either in stop mode or during playback), click **Record**.
5. Stop the recording after a few seconds.  
This creates an audio event that starts where the cursor position was when you activated recording. If you were in stop mode, and the cursor was at the beginning of the project, you may have to move the event to the right in the next step. If you were playing along to a project, you leave the event where it is.
6. Select the **Object Selection** tool and place the cursor on the bottom left edge of the event so that a double arrow appears. Then click and drag to the left.

---

### RESULT

The event is now extended, and the audio that you played before activating the recording is inserted. This means that if you played along during playback, the captured notes end up exactly where you played them in relation to the project.

### RELATED LINKS

[Record - Audio](#) on page 902

## Recovery of Audio Recordings after System Failure

Cubase allows you to recover audio recordings after a system failure, because of a power cut or other mishap, for example.

When you experience a computer crash during a recording, relaunch the system and check the project record folder. By default, this is the **Audio** subfolder inside the project folder. It should contain the audio file that you recorded, from the moment when you started recording to the time when your computer crashed.

### NOTE

- This feature does not constitute an overall guarantee by Steinberg. While the program itself was improved in such a way that audio recordings can be recovered after a system failure, it is always possible that a computer crash, power cut, etc. might have damaged another component of the computer, making it impossible to save or recover any of the data.
  - Do not try to actively bring about this kind of situation to test this feature. Although the internal program processes have been improved to cope with such situations, Steinberg cannot guarantee that other parts of the computer are not damaged as a consequence.
-

## MIDI Recording Specifics

Specific preparations and settings are required for MIDI recordings.

### RELATED LINKS

[MIDI Recording Specifics](#) on page 242

[Recording in MIDI Editors](#) on page 243

[MIDI Record Modes](#) on page 246

## MIDI Recording Preparations

The preparations described in the following sections mainly focus on external MIDI devices.

### MIDI Instruments and Channels

Most MIDI synthesizers can play several sounds at the same time, each on a different MIDI channel. This allows you to play back several sounds (bass, piano, etc.) from the same instrument.

Some devices, such as General MIDI compatible sound modules, always receive on all 16 MIDI channels. If you have such an instrument, there is no specific setting to make in the instrument.

On other instruments, you must use the front panel controls to set up a number of parts, timbres, or similar so that they all receive on one MIDI channel.

For more information, refer to the manual that came with your instrument.

### Naming MIDI Ports

MIDI inputs and outputs are often displayed with long and complicated names. In Cubase, you can rename your MIDI ports to more descriptive names.

---

#### PROCEDURE

1. Select **Studio > Studio Setup**.
  2. In the **Devices** list, select **MIDI Port Setup**.  
The available MIDI inputs and outputs are listed. On Windows, the device to choose depends on your system.
  3. Click in the **Show As** column and type in a new name.
  4. Click **OK**.
- 

#### RESULT

The new port names appear on the **Input Routing** and **Output Routing** pop-up menus.

### Setting the MIDI Input

In the **Inspector**, you set the MIDI input for the track.

---

#### PROCEDURE

1. In the track list, select the track to which you want to assign a MIDI input.
2. In the topmost **Inspector** section, open the **Input Routing** pop-up menu and select an input.  
The available inputs on the menu depend on the type of MIDI interface that you are using. If you hold down **Shift-Alt**, the selected MIDI input is used for all selected MIDI tracks.

**NOTE**

If you select **All MIDI Inputs**, the track will receive MIDI data from all available MIDI inputs.

---

## Setting the MIDI Channel and Output

The MIDI channel and output settings determine where the recorded MIDI is routed during playback. They are also relevant for monitoring MIDI in Cubase. You can select the channel and output in the track list or in the **Inspector**.

---

PROCEDURE

1. In the track list, select the track to which you want to assign a MIDI channel and output.
2. In the topmost **Inspector** section, open the **Output Routing** pop-up menu and select an output.  
The available outputs on the menu depend on the type of MIDI interface that you are using. If you hold down **Shift-Alt**, the selected MIDI output is used for all selected MIDI tracks.
3. Open the **Channel** pop-up menu and select a MIDI channel.

**NOTE**

If you select the **Any** MIDI channel, the MIDI material is routed to the channels that are used by your MIDI instrument.

---

## Selecting a Sound

You can select sounds from within Cubase by instructing the program to send Program Change and Bank Select messages to your MIDI device.

---

PROCEDURE

1. In the track list, select the track to which you want to assign a sound.
2. In the track list or the **Inspector**, open the **Program Selector** pop-up menu and select a program.  
Program Change messages give access to 128 different program locations.
3. If your MIDI instruments have more than 128 programs, you can open the **Bank Selector** pop-up menu and select different banks, each containing 128 programs.

**NOTE**

Bank Select messages are recognized differently by different MIDI instruments. The structure and numbering of banks and programs may also vary. Refer to the documentation of your MIDI instruments for details.

---

RELATED LINKS

[MIDI Track Inspector](#) on page 115

## Recording in MIDI Editors

You can record MIDI data into the MIDI part that is opened in a MIDI editor.

PREREQUISITE

You have selected **Merge** or **Replace** as **MIDI Record Mode**.

---

#### PROCEDURE

1. Click in the MIDI editor so that it gets the focus.
  2. In the MIDI editor toolbar, activate **Record in Editor**.
  3. Do one of the following to activate recording:
    - Click **Record** on the **Transport** panel.
    - Click **Record** on the toolbar.
- 

#### RESULT

The MIDI data is recorded into the MIDI part that is opened in the MIDI editor. If you record outside the part borders, the part is automatically enlarged.

#### RELATED LINKS

[Key Editor Toolbar](#) on page 640

## MIDI Recording

You can record MIDI using any of the basic recording methods.

When you finish recording, a part that contains MIDI events is created in the **Project** window.

#### NOTE

If you perform a live recording on a VST instrument, you usually compensate the latency of the audio card by playing earlier. In consequence, the timestamps are recorded too early. If you activate **ASIO Latency Compensation** on the track list, all recorded events are moved by the current latency setting.

---

The following preferences affect MIDI recording:

- Length Adjustment
- Snap MIDI Parts to Bars
- MIDI Record Catch Range in ms
- ASIO Latency Compensation Active by Default

You can find them in the **Preferences** dialog on the **MIDI** and on the **Record—MIDI** page.

#### RELATED LINKS

[Basic Recording Methods](#) on page 230

[MIDI](#) on page 897

[Record - MIDI](#) on page 903

## Types of MIDI Messages

You can record different types of MIDI messages.

- To specify which event types are recorded, deactivate the options for the type of MIDI message that you want to record in the **Preferences** dialog (**MIDI—MIDI Filter** page).

#### RELATED LINKS

[MIDI - MIDI Filter](#) on page 901

## Note Messages

Cubase records note on, note off, and MIDI channel messages.

If you press and release a key on your synthesizer or on another MIDI keyboard, the following messages are recorded:

- Note On (key down)
- Note Off (key up)
- MIDI channel

### NOTE

Normally, the MIDI channel information is overridden by the MIDI channel setting for the track. However, if you set the track to the **Any** MIDI channel, the notes will be played back on their original channels.

---

## Continuous Messages

Pitchbend, aftertouch, and controllers, such as modulation wheel, sustain pedal, volume, etc. are considered MIDI continuous events, as opposed to the momentary key down and key up messages.

You can record continuous messages together or independently from the notes, that is, afterwards or before.

You can record continuous messages on their own tracks, separately from the notes to which they belong. As long as you set the two tracks to the same output and MIDI channel, it will appear to the MIDI instrument as if you made the two recordings at the same time.

## Program Change Messages

When you switch from one program to another on your synthesizer or on another MIDI keyboard, a number corresponding to that program is sent out via MIDI as a Program Change Message.

You can record Program Change Messages together or independently from the notes, that is, afterwards or before.

You can record Program Change Messages on their own tracks, separately from the notes to which they belong. As long as you set the two tracks to the same output and MIDI channel, it will appear to the MIDI instrument as if you made the two recordings at the same time.

## System Exclusive Messages

System Exclusive (SysEx) messages are special types of MIDI messages that are used to send data that only makes sense to a unit of a certain make and type.

SysEx can be used to transmit a list of the numbers that make up the settings of one or more sounds in a synth.

## Reset Function

The **Reset** function sends out note-off messages and resets controllers on all MIDI channels. This is sometimes necessary if you experience hanging notes, constant vibrato, etc. when punching in and out on MIDI recordings with pitchbend or controller data.

- To perform a MIDI reset manually, select **MIDI > Reset**.
- If you want Cubase to perform a MIDI reset on stop, activate **Reset on Stop** in the **Preferences** dialog (**MIDI** page).

- If you want Cubase to insert a reset event at the end of a recorded part, activate **Insert Reset Events after Record** in the **Preferences** dialog (**MIDI** page).  
This resets controller data such as sustain, aftertouch, pitchbend, modulation, and breath control. This is useful if a MIDI part is recorded and the sustain pedal is still held after stopping recording. Usually, this would cause all following parts to be played with sustain, as the pedal off command was not recorded.

#### RELATED LINKS

[MIDI](#) on page 897

## MIDI Record Modes

By selecting a **MIDI Record Mode** you decide what happens to any existing parts on the track where you are recording. MIDI tracks can play back all events in overlapping parts. If you record several parts in the same locations or move parts so that they overlap, you will hear the events in all parts.

#### NOTE

If you activate **Record in Editor** to record MIDI data in the editor, all new recordings are merged into the active part, and the **MIDI Record Modes** do not apply.

- To access the record modes, select **Transport > MIDI Record Mode**.  
You can also access the **MIDI Record Modes** by clicking to the right of the MIDI symbol in the **MIDI Recording Modes** section on the **Transport** panel.

### MIDI Record Mode

#### New Parts

Existing parts that are overlapped by a new recording are kept. The new recording is saved as a new part.

#### Merge

Existing events in parts that are overlapped by a new recording are kept. The newly recorded events are added to the existing part.

#### Replace

Existing events in parts that are overlapped by a new recording are replaced.

### MIDI Cycle Record Mode

When you record MIDI in cycle mode, the result not only depends on the MIDI record mode, but also on the cycle record mode that is selected in the **Cycled MIDI Recording Only** section.

#### Mix

For each completed lap, everything you record is added to what was previously recorded. This is useful for building up rhythm patterns. Record a hi-hat part on the first lap, the bass drum part on the second lap, etc.

#### Overwrite

As soon as you play a MIDI note or send any MIDI message, all MIDI that you have recorded on previous laps is overwritten from that point. Make sure that you stop playing before the next lap begins. Otherwise, you will overwrite the entire take.

#### Keep Last

Each completed lap replaces the previously recorded lap. If you deactivate recording or press **Stop** before the cursor reaches the right locator, the previous take will be kept. If you do not play or input any MIDI during a lap, nothing happens, and the previous take will be kept.

### Stacked

Each recorded cycle lap is turned into a separate MIDI part, and the track is divided into lanes, one for each cycle lap. The parts are stacked above each other, each on a different lane. All takes but the last one are muted.

### Mix-Stacked (No Mute)

Same as **Stacked**, but parts are not muted.

#### RELATED LINKS

[MIDI Recording Specifics](#) on page 242

[Recording in MIDI Editors](#) on page 243

[Transport Menu](#) on page 199

[Transport Panel Sections](#) on page 194

## Automatic MIDI Record Quantize

Cubase can automatically quantize MIDI notes on recording.

- **Automatic MIDI Record Quantize**  is available in the **MIDI Auto Quantize** section of the **Transport Bar**.

If you activate **Auto Quantize**, the notes that you record are automatically quantized according to the quantize settings.

#### RELATED LINKS

[Quantizing MIDI and Audio](#) on page 261

[Quantize Panel](#) on page 264

## Recovery of MIDI Recordings

Cubase allows you to recover MIDI data, including controller data, that was captured in **Stop** mode or during playback.

The MIDI data is stored in the retrospective record buffer, and you can insert it as a MIDI part on the selected MIDI track.

The buffer captures up to 10000 MIDI events. This can correspond to a MIDI recording of around 2 minutes and 30 seconds. However, if you use a keyboard that produces a large amount of MIDI controller events, such as the ROLI Seaboard, this only corresponds to a recording of around 20 seconds.

#### NOTE

In the **Preferences** dialog (**Record—MIDI** page), you can specify a **Retrospective Record Buffer Size**.

If the buffer is full, the MIDI events that were captured first are replaced by the new events. MIDI events in the buffer are also replaced in the following situations:

- When you have inserted the retrospective recording on a track and you play new events in **Stop** mode or during playback.
- When you play MIDI notes in **Stop** mode and you do not play for more than 30 seconds, before playing more MIDI events in **Stop** mode.

#### NOTE

You can also empty the buffer manually.

---

RELATED LINKS

[Record - MIDI](#) on page 903

[Emptying the Retrospective Record Buffer](#) on page 250

## Inserting a Retrospective Recording from All MIDI Inputs on the Selected Track

You can insert a retrospective recording, that is, MIDI data that was sent to **All MIDI Inputs** in **Stop** mode or during playback, on the selected track.

PREREQUISITE

You have played some MIDI notes in **Stop** mode or during playback, and you want to recover them.

---

PROCEDURE

1. Select the MIDI track on which you want to insert the captured MIDI data.
2. Select **Transport > MIDI Retrospective Recording > Insert from All MIDI Inputs**.

---

RESULT

The MIDI data that was captured at **All MIDI Inputs** is inserted on the selected track as one, linear MIDI part.

NOTE

If you insert buffer data from multiple selected tracks, the timing offsets between the data played on the different tracks are retained.

---

NOTE

If your MIDI track uses MIDI inserts, and **Record Output to Track** is enabled in the **MIDI Inserts** section, the buffer data includes the events that are created by the MIDI inserts.

---

RELATED LINKS

[Recording a MIDI Insert Effect](#) on page 599

[MIDI Inserts](#) on page 598

## Inserting a Retrospective Track Recording

You can insert a retrospective track recording, that is, MIDI data that was sent to the track input in **Stop** mode or during playback, on the selected track.

PREREQUISITE

You have played some MIDI notes in **Stop** mode or during playback, and you want to recover them.

---

PROCEDURE

1. Select the MIDI track on which you want to insert the captured MIDI data.
2. In the top section of the MIDI track **Inspector**, click **Retrospective Recording**.



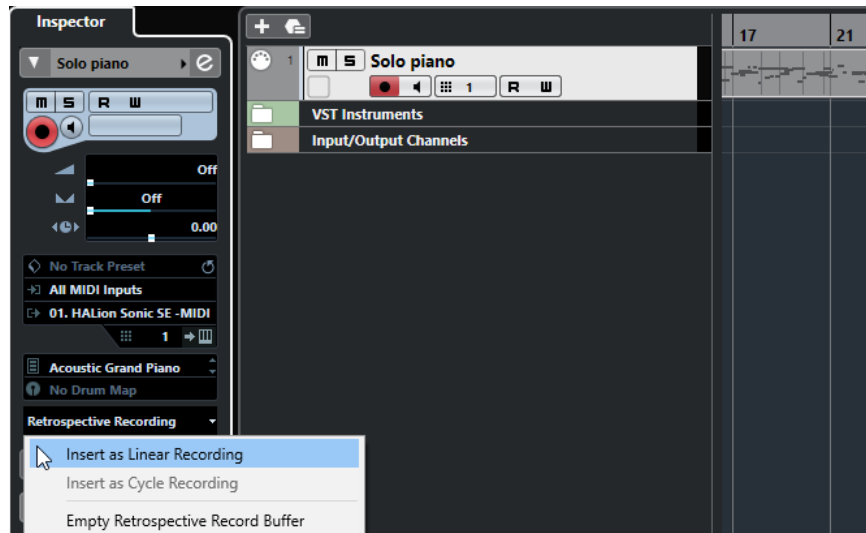

3. From the pop-up menu, select one of the following:
  - To insert the MIDI data as one, continuous MIDI part, select **Insert as Linear Recording**.
  - To insert the MIDI data as stacked MIDI parts, select **Insert as Cycle Recording**.

**NOTE**

This is only available if your MIDI data was captured during playback, and cycle mode was active.

---

**RESULT**

The MIDI data that was captured at the track input is inserted on the track.

**NOTE**

If the data was captured during playback, it is inserted at the position where you played it. If the data was captured in **Stop** mode, it is inserted at the project cursor position.

---

## Inserting a Retrospective Track Recording into an Editor

You can insert a retrospective track recording, that is, MIDI data that was sent to the track input in **Stop** mode or during playback, into the MIDI part that is opened in a MIDI editor.

**PREREQUISITE**

You have played some MIDI notes in **Stop** mode or during playback, and you want to recover them.

---

**PROCEDURE**

1. Double-click the MIDI part where you want to insert the captured MIDI data to open it in a MIDI editor.
  2. On the MIDI editor toolbar, click **Insert MIDI Retrospective Recording in Editor**.
- 

**RESULT**

The MIDI data that was captured on the track input is inserted into the MIDI part.

- If the data was captured during playback, it is inserted into the MIDI part along the timeline.
- If the data was captured in **Stop** mode, it is inserted at the project cursor position.

## Emptying the Retrospective Record Buffer

You can empty the retrospective record buffer manually.

---

### PROCEDURE

- Do one of the following:
    - In the top section of the MIDI track **Inspector**, open the **Retrospective Recording** pop-up menu, and select **Empty Retrospective Record Buffer**.
    - Select a track, and select **Transport > MIDI Retrospective Recording > Empty All Buffers**.
- 

## Remaining Record Time

The **Max. Record Time** display lets you see how much time you have left for recording.

**51h 25min**

The available time depends on the current setup, for example, on the amount of tracks that are record-enabled, the sample rate for your project, and the available hard disk space.

- To open the display, select **Studio > More Options > Max. Record Time**.

---

### NOTE

The remaining record time is also shown in the status line above the track list.

---

If you use individual record folders to store your tracks on different drives, the time display refers to the medium with the least storage space available.

## Lock Record

The **Lock Record** function prevents you from accidentally deactivating record mode.

- Select **Edit > Key Commands** and in the **Transport** category, assign key commands to the **Lock Record** and **Unlock Record** commands.

If **Lock Record** is activated and you want to enter stop mode, a dialog opens in which you need to confirm that you want to stop recording. You can also use the **Unlock Record** key command first and then enter stop mode as usual.

---

### NOTE

An automatic punch out at the right locator position will be ignored in **Lock Record** mode.

---

# Importing Audio and MIDI Files

You can add audio and MIDI files to your project by importing them.

## Audio File Import

You can import compressed and uncompressed audio files in a variety of different formats. You can also import audio from audio CDs or extract the audio of video files.

### RELATED LINKS

[Importing Audio Files](#) on page 253

[Importing Audio CD Tracks](#) on page 254

[Importing Audio from Video Files](#) on page 257

[Importing ReCycle Files](#) on page 257

[Importing Media](#) on page 488

## Setting up Audio File Import Options

You can specify how audio files should be handled on import.

### PROCEDURE

1. In the **Preferences** dialog, select **Editing > Audio**.
2. Select an option from the **On Import Audio Files** pop-up menu.

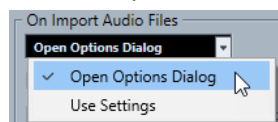

3. Click **OK**.

### RESULT

The import settings are saved and will take effect when you import audio. If you selected **Open Options Dialog**, the **Import Options** dialog opens on every import and allows you to make your changes. If you selected **Use Settings**, the settings specified in the **On Import Audio Files** section of the **Preferences** dialog are used.

### RELATED LINKS

[Import Options Dialog for Audio Files](#) on page 252

[On Import Audio Files Settings](#) on page 253

## Import Options Dialog for Audio Files

The **Import Options** dialog allows you to make specific settings for the audio import.

- When you import audio files and **Open Options Dialog** is activated in the **On Import Audio Files** section of the **Preferences** dialog (**Editing—Audio** page), the **Import Options** dialog opens.

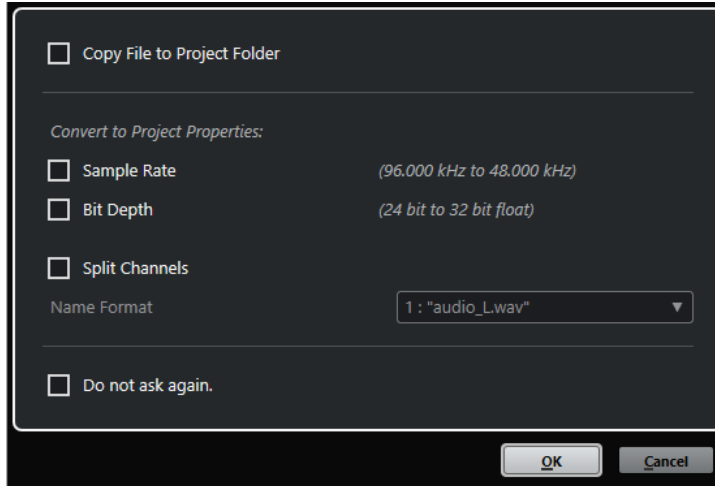

**Import Options** dialog for single file import

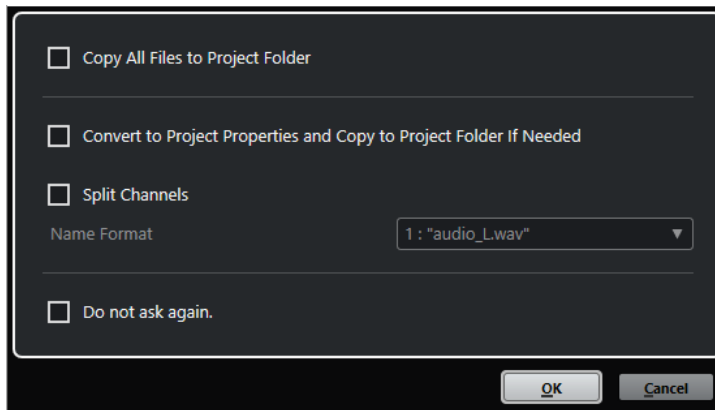

**Import Options** dialog for multiple file import

### Copy File to Project Folder/Copy All Files to Project Folder

Copies the audio file to the **Audio** folder of the project, and has the clip refer to the copy.

Deactivate this option to have the clip refer to the original file in the original location. In this case, it is marked as "external" in the **Pool**.

### Convert to Project Settings/Convert to Project Settings and Copy to Project Folder If Needed

Converts the imported file if the sample rate or the bit depth differ from the settings in the **Project Setup** dialog. For single file import, you can choose which properties are converted.

### Split Channels

Splits stereo or multichannel audio files into a corresponding number of mono files, one for each channel, and copies the imported files to the **Audio** folder of the project.

The split files are inserted into the project and into the **Pool** as separate mono tracks.

The **Name Format** pop-up menu allows you to specify how the split files are named. This allows for compatibility with other products when exchanging audio files.

#### Do not ask again

Always imports files according to the settings without opening the dialog again. You can reset this option in the **Preferences** dialog (**Editing—Audio** page).

#### RELATED LINKS

[Setting up Audio File Import Options](#) on page 251

## On Import Audio Files Settings

You can set up standard settings that are performed automatically each time you import audio files.

- When you import audio files and **Use Settings** is activated in the **On Import Audio Files** section of the **Preferences** dialog (**Editing—Audio** page), the settings are used for importing audio.

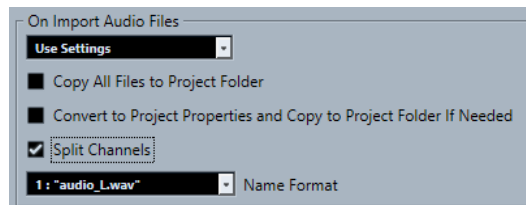

#### Copy File to Project Folder/Copy All Files to Project Folder

Copies the audio file to the **Audio** folder of the project, and has the clip refer to the copy.

Deactivate this option to have the clip refer to the original file in the original location. In this case, it is marked as “external” in the **Pool**.

#### Convert to Project Settings/Convert to Project Settings and Copy to Project Folder If Needed

Converts the imported file if the sample rate or the bit depth differ from the settings in the **Project Setup** dialog. For single file import, you can choose which properties are converted.

#### Split Channels

Splits stereo or multichannel audio files into a corresponding number of mono files, one for each channel, and copies the imported files to the **Audio** folder of the project.

The split files are inserted into the project and into the **Pool** as separate mono tracks.

The **Name Format** pop-up menu allows you to specify how the split files are named. This allows for compatibility with other products when exchanging audio files.

## Importing Audio Files

You can import uncompressed audio and compressed audio in several formats.

---

#### PROCEDURE

1. Select **File > Import > Audio File**.
2. In the file dialog that opens, locate and select the audio file and click **Open**.
3. Make your changes in the **Import Options** dialog.

**NOTE**

If **Use Settings** is activated in the **Preferences** dialog (**Editing—Audio** page), the corresponding import settings are used instead.

---

**RESULT**

In the **Project** window, an event referencing the audio file is inserted on the selected track at the project cursor position. If no track was selected, a new track is created.

A new audio clip is created and added to the **Pool**.

If you chose a compressed audio file other than FLAC, Cubase copies the original compressed file and converts it to wave format (Windows) or AIFF format (macOS).

**NOTE**

The resulting Wave/AIFF file is significantly larger than the original compressed file.

---

The imported file is placed in the **Audio** folder of the project.

**RELATED LINKS**

[Setting up Audio File Import Options](#) on page 251

## Supported Compressed Audio File Formats

In Cubase, you can import compressed audio files.

The following compressed audio file formats are supported:

**FLAC File**

This is an open source format that reduces the size of audio files by 50 % to 60 % compared to regular Wave files. The files have the extension **.flac**.

**MPEG 1 Layer 3 File**

This is a family of standards used for encoding audio-visual information such as movies, video, and music in a digital compressed format. Cubase can read MPEG Layer 2 and MPEG Layer 3. MP3 files are highly compressed files that still provide good audio quality. The files have the extension **.mp3**.

**Ogg Vorbis File**

This is an open source, patent-free audio encoding and streaming technology. The Ogg Vorbis encoder uses variable bit rate encoding. It offers compressed audio files of small size, but with comparatively high audio quality. The files have the extension **.ogg**.

**Windows Media Audio File (Windows only)**

This is an audio file format defined by Microsoft Inc. WMA files can be decreased in size with no loss of audio quality. WMA Pro features the possibility of mixing down to 5.1 surround sound. The files have the extension **.wma**.

## Importing Audio CD Tracks

You can import audio from audio CDs into Cubase projects.

---

**PROCEDURE**

1. Select **File > Import > Audio CD** to import the CD tracks into the **Project** window.
2. Activate every audio file that you want to import in the **Copy** column.
3. Optional: Set a **Default Name** and a **Destination Folder** for the imported audio files.

4. Click the **Copy** button to create a local copy of the audio files or sections.
  5. Click **OK**.
- 

#### RESULT

The copied audio files are imported into the **Project** window and inserted on new tracks at the project cursor position. By default, imported audio CD tracks are saved as wave files (Windows) or AIFF files (macOS) in the **Audio** folder of the current project.

New audio clips are created and added to the **Pool**.

#### NOTE

You can also import audio files to the **Pool** only without importing them into the **Project** window.

---

#### RELATED LINKS

[Importing Media](#) on page 488

## Import From Audio CD Dialog

The **Import from Audio CD** dialog allows you to specify how the CD tracks are imported.

- To open the **Import from Audio CD** dialog, select **File > Import > Audio CD**.

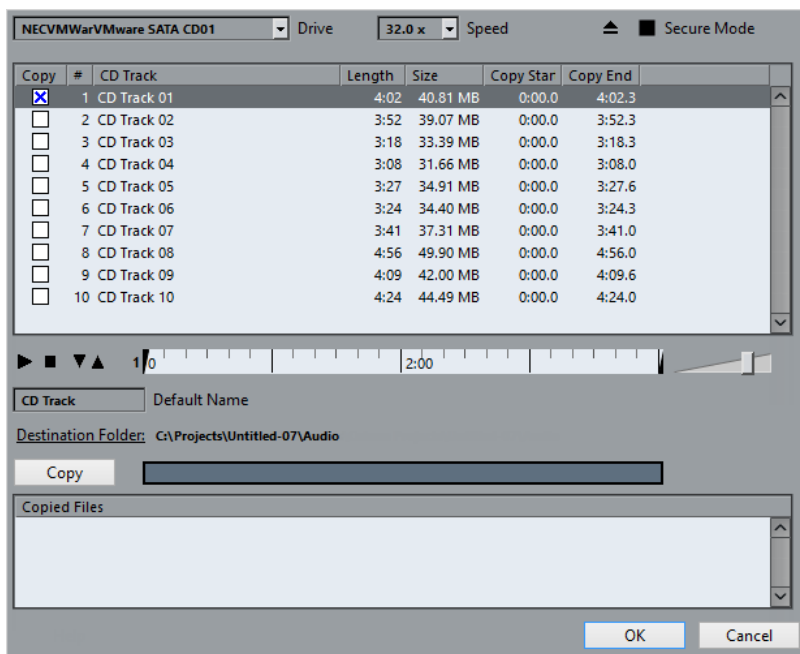

#### Drive

Opens a pop-up menu that allows you to select the correct CD drive.

#### Speed (Windows only)

Allows you to select the data transfer speed.

#### NOTE

While you normally want to use the fastest possible speed, you may have to select a slower speed for flawless audio extraction.

---

#### Eject CD

Opens the CD drive.

### Secure Mode (Windows only)

Activates error checking and correction when reading the CD.

## Columns

The columns in the dialog have the following functions:

### Copy

Activate this option for the tracks that you want to copy/import.

### #

Shows the track number.

### CD Track

The name of the CD track. On import, this is used as file name. It is provided automatically from CDDb, if available.

To rename a track, click the track name and enter a new name.

### Length

The length of the audio CD track in minutes and seconds.

### Size

The file size of the audio CD track in MB.

### Copy Start

The start of the section that is imported. On the ruler, drag the **Left Marker** to the right to adjust this.

### Copy End

The end of the section that is imported. On the ruler, drag the **Right Marker** to the left to adjust this.

## The Ruler

The ruler has the following functions:

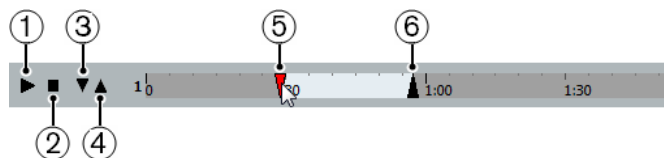

### 1 Play Tracks

Plays back the selected track from the start to the end or from the left marker to the right marker.

### 2 Stop Playback

Stops playback.

### 3 Play from Left Marker

Starts playback at the left marker.

### 4 Play to Right Marker

Starts playback some moments before the right marker and stops at the right marker.

### 5 Left Marker

Allows you to set the copy start manually.

### 6 Right Marker

Allows you to set the copy end manually.



#### Destination Folder

Allows you to select a folder for the imported files.

#### Copy

Copies the files.

#### Copied Files

Lists the files that you copied for import.

## Importing Audio from Video Files

You can import the audio from a video file without importing the video itself.

---

#### PROCEDURE

1. Select **File > Import > Audio from Video File**.
2. In the file dialog that opens, locate and select the video file, and click **Open**.

---

#### RESULT

The audio of the selected video file is extracted and converted to a wave file that is saved in the **Audio** folder.

A new audio clip is created and added to the **Pool**. In the **Project** window, an event referencing the audio file is inserted on the selected track at the project cursor position. If no track was selected, a new track is created.

#### RELATED LINKS

- [Extracting Audio from Video](#) on page 843
- [Importing Video Files](#) on page 835

## Importing ReCycle Files

You can import REX and REX 2 audio files created by ReCycle from Propellerhead Software. ReCycle slices a loop and creates separate samples of each beat, so that you can tempo match and edit a loop as if it was built of individual sounds.

#### PREREQUISITE

REX Shared Library is installed on your system.

---

#### PROCEDURE

1. Select an audio track and move the project cursor to where you want the imported file to start.  
If you set the audio track to musical time base you can change the tempo later on and the imported REX file automatically adjusts.
2. Select **File > Import > Audio File**.
3. In the file dialog, open the file type pop-up menu and select **REX File** or **REX 2 File**.
4. Select the file you want to import, and click **Open**.

---

#### RESULT

The file is imported and automatically adjusted to the current Cubase tempo.

The imported REX file consists of several events, one for each slice in the loop. The events are automatically placed in an audio part on the selected track and positioned so that the original internal timing of the loop is preserved.

#### AFTER COMPLETING THIS TASK

Open the part in the **Audio Part Editor** to edit each slice separately by muting, moving, and resizing events, adding effects and processing, for example.

You can also adjust the tempo and have the REX file automatically follow, provided that its track is set to a musical time base.

#### NOTE

You can achieve similar results by using Cubase's own loop slicing features.

---

#### RELATED LINKS

[Slices](#) on page 438

## MIDI File Import

Cubase can import standard MIDI files. This allows you to transfer MIDI material to and from virtually any MIDI application on any platform.

### Import Options for MIDI Files

The **Import Options** for MIDI files allow you to specify what data is included in imported MIDI files.

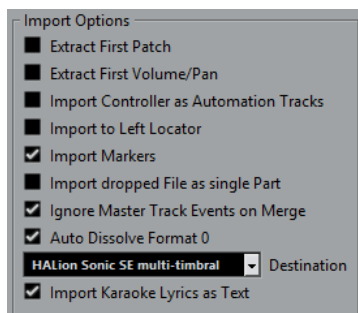

#### Extract First Patch

Converts the first **Program Change** and **Bank Select** events for each track to **Inspector** settings for the track.

#### Extract First Volume/Pan

Converts the first **MIDI Volume** and **Pan** events for each track to **Inspector** settings for the track.

#### Import Controller as Automation Tracks

Converts **MIDI Controller** events in the MIDI file to automation data for the MIDI tracks.

#### Import to Left Locator

Aligns the imported MIDI file at the position of the left locator.

#### Import Markers

Imports Standard MIDI File Markers in the file and converts them to Cubase markers.

#### Import Dropped File as Single Part

Places the file on one track if you drag a MIDI file into the project.

#### Ignore Master Track Events on Merge

Ignores tempo track data if you import a MIDI file into the current project. The imported MIDI file will play according to the current tempo track in the project.

### Auto Dissolve Format 0

Automatically dissolves imported MIDI files of type 0. Each embedded MIDI channel in the file is placed on a separate track in the **Project** window.

### Destination

Allows you to specify what happens when you drag a MIDI file into the project.

- **MIDI Tracks** creates MIDI tracks for the imported file.
- **Instrument Tracks** creates instrument tracks for each MIDI channel in the MIDI file and lets the program automatically load appropriate presets.
- **HALion Sonic SE multi-timbral** creates several MIDI tracks, each routed to a separate instance of HALion Sonic SE in the **VST Instruments** window, and loads the appropriate presets.

### Import Karaoke Lyrics as Text

Converts karaoke lyrics in the MIDI file to text that can be displayed in the **Score Editor**. If this option is deactivated, lyrics are only shown in the **List Editor**.

## Importing MIDI Files

In Cubase, you can import MIDI files.

---

### PROCEDURE

1. Select **File > Import > MIDI File**.
  2. Optional: If a project is open, choose if you want to create a new project. If you select **No**, the MIDI file is imported into the current project.
  3. In the file dialog that opens, locate and select the MIDI file and click **Open**.
- 

### RESULT

The MIDI file is imported. The result depends on the contents of the MIDI file and the setting you made in the **Import Options** section in the **Preferences** dialog (**MIDI—MIDI File** page).

It is also possible to import a MIDI file from disk by dragging it from the File Explorer/macOS Finder into the **Project** window. The **Import Options** apply as well.

### RELATED LINKS

[Import Options for MIDI Files](#) on page 258  
[Markers](#) on page 300

## Yamaha XF Format

Cubase supports the Yamaha XF format. XF is an extension of the standard MIDI file format that allows you to save song-specific data with a MIDI file of type 0.

When importing a MIDI file containing XF data, this data is placed in parts on separate tracks called **XF Data**, **Chord Data**, or **SysEx Data**. You can edit such a part in the **List Editor** to add or change lyrics, for example.

### IMPORTANT

Do not change the order of events within the XF data or the event data itself, unless you have a lot of experience with XF data.

---

Cubase can also export XF data as part of a MIDI file of type 0. If you do not want to export the XF data together with the MIDI data, mute or delete the tracks containing the XF data.

## MIDI Loops

In Cubase, you can import MIDI loops.

To import MIDI loops, use the **MediaBay**. MIDI loops have the file extension `.midiloop`.

### RELATED LINKS

[Importing MIDI Loops](#) on page 558

# Quantizing MIDI and Audio

Quantizing means moving recorded audio or MIDI and positioning it on the nearest grid position that is musically relevant. Quantizing is designed to correct errors, but you can also use it in a creative way.

You can quantize audio and MIDI to a grid or to a groove.

Audio and MIDI can be quantized at the same time. However, what exactly happens during quantizing differs for audio and MIDI:

- Audio quantizing affects the audio event starts or the content of your audio.
- MIDI quantizing can affect the starts of MIDI events in a part, the MIDI event lengths, or the MIDI event ends.

## NOTE

Quantizing is based on the original position of the events. Therefore, you can freely try out different quantize settings without the risk of destroying anything.

## RELATED LINKS

[Quantizing Audio Event Starts](#) on page 263

[Quantizing Audio Event Lengths \(AudioWarp Quantizing\)](#) on page 264

[Quantizing MIDI Event Starts](#) on page 262

[Quantizing MIDI Event Lengths](#) on page 263

[Quantizing MIDI Event Ends](#) on page 263

## Quantize Functions

The quantize functions are available in the **Edit** menu and in the **Snap** and **Quantize** sections of the **Project** window toolbar.

### Quantize Functions on the Edit Menu

#### Quantize

Quantizes audio or MIDI event starts.

#### Reset Quantize

Reverts your audio or MIDI to its original, unquantized state, and resets any length changes that you performed in the **Quantize Panel**.

#### Quantize Panel

Opens the **Quantize Panel**.

#### Advanced Quantize

From this submenu, you can select the following functions:

- **Quantize MIDI Event Lengths**

Cuts off the ends of selected MIDI events so that the events match the length quantize value. The start positions are kept.

- **Quantize MIDI Event Ends**  
Moves the ends of MIDI events to the nearest grid positions.
- **Freeze MIDI Quantize**  
Makes the start and end positions of MIDI events permanent. This function is useful in situations where you want to quantize a second time, based on the current quantized positions rather than the original positions.
- **Create Groove Quantize Preset**  
Creates a groove quantize map based on hitpoints that you have created in the **Sample Editor**.

## Quantize Functions on the Project Window Toolbar

### Iterative Quantize On/Off



Activates/Deactivates iterative quantize.

### AudioWarp Quantize On/Off



Activates/Deactivates **AudioWarp** quantize.

### Quantize Presets



Allows you to select a quantize preset.

### Apply Quantize



Applies the quantize settings.

### Open Quantize Panel



Opens the **Quantize Panel**.

## Quantizing MIDI Event Starts

You can quantize the MIDI event start positions.

### PREREQUISITE

You have set up a quantize grid on the **Quantize Presets** pop-up menu on the **Project** window toolbar.

---

### PROCEDURE

1. Perform one of the following actions:
  - In the **Key Editor**, select the MIDI events that you want to quantize.
  - In the **Project** window, select a MIDI part.
2. Select **Edit > Quantize**.

---

### RESULT

The starts of the selected MIDI events or all events of the selected MIDI part are quantized. Events that do not match exact note positions are moved to the closest grid position. The note lengths are maintained.

## Quantizing MIDI Event Lengths

You can quantize the MIDI event lengths.

### PREREQUISITE

You have set up a length quantize value on the **Length Quantize** pop-up menu on the **Key Editor** toolbar.

---

### PROCEDURE

1. Perform one of the following actions:
  - In the **Key Editor**, select the MIDI events that you want to quantize.
  - In the **Project** window, select a MIDI part.
2. Select **Edit > Advanced Quantize > Quantize MIDI Event Lengths**.

---

### RESULT

The ends of the selected MIDI events are cut off so that the events match the length quantize value. The start positions are kept.

### NOTE

If you have selected **Quantize Link**, the events are resized according to the grid that is set up in the **Quantize Presets** pop-up menu. The **Swing**, **Tuplet**, and **Catch Range** settings on the **Quantize Panel** are taken into account.

---

## Quantizing MIDI Event Ends

You can quantize the MIDI event end positions.

### PREREQUISITE

You have set up a quantize grid on the **Quantize Presets** pop-up menu on the **Project** window toolbar.

---

### PROCEDURE

1. Perform one of the following actions:
  - In the **Key Editor**, select the MIDI events that you want to quantize.
  - In the **Project** window, select a MIDI part.
2. Select **Edit > Advanced Quantize > Quantize MIDI Event Ends**.

---

### RESULT

The ends of the MIDI events are moved to the nearest grid positions.

## Quantizing Audio Event Starts

You can quantize the audio event start positions.

### PREREQUISITE

You have set up a quantize grid on the **Quantize Presets** pop-up menu on the **Project** window toolbar.

---

PROCEDURE

1. In the **Project** window, select an audio event, a sliced loop, or an audio part.
  2. Select **Edit > Quantize**.
- 

RESULT

The event snap point, or, if not available, the start of the audio event, is quantized. Event starts that do not match exact note positions are moved to the closest grid positions.

NOTE

If you use the **Quantize** function on an audio part, the starts of the events inside the part are quantized.

---

## Quantizing Audio Event Lengths (AudioWarp Quantizing)

You can quantize an audio event or an audio selection range by applying time stretch to the content of the audio event.

---

PROCEDURE

1. Perform one of the following actions:
    - Select the audio event that you want to quantize.
    - Select a range of the event that you want to quantize.
  2. On the toolbar, activate **AudioWarp Quantize On/Off**.
  3. Perform one of the following actions:
    - Click **Quantize Presets**, and select a quantize grid preset from the pop-up menu.
    - Click **Open Quantize Panel**, and define the quantize grid with the available parameters.
  4. Select **Edit > Quantize**.
- 

RESULT

The audio event is quantized, that is, its warp markers are aligned with the quantize grid by applying time stretch, and the audio sections between the warp markers are stretched or compressed to fit into the time interval that you set up on the **Quantize Presets** pop-up menu.

NOTE

If you use a quantize value of 1/4 on audio that is based on 16th notes, the warp markers at the 1/4 note positions are quantized to the grid, and the remaining warp markers are moved, keeping the relative distances between the warp markers.

---

RELATED LINKS

[Quantize Panel](#) on page 264  
[Slices](#) on page 438

## Quantize Panel

The **Quantize Panel** allows you to define how to quantize audio or MIDI to the grid or to a groove. Depending on what method you choose, different parameters are shown.

To open the **Quantize Panel**, perform one of the following actions:

- Click **Open Quantize Panel** on the toolbar.



- Select **Edit > Quantize Panel**.

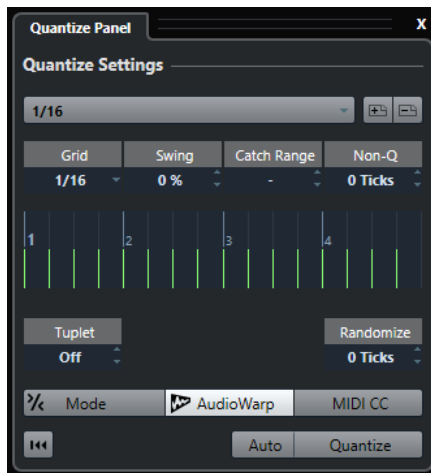

## Quantize Presets

To the top of the **Quantize Panel** the quantize presets are shown. Here, you can load and save presets that include all settings for quantizing.

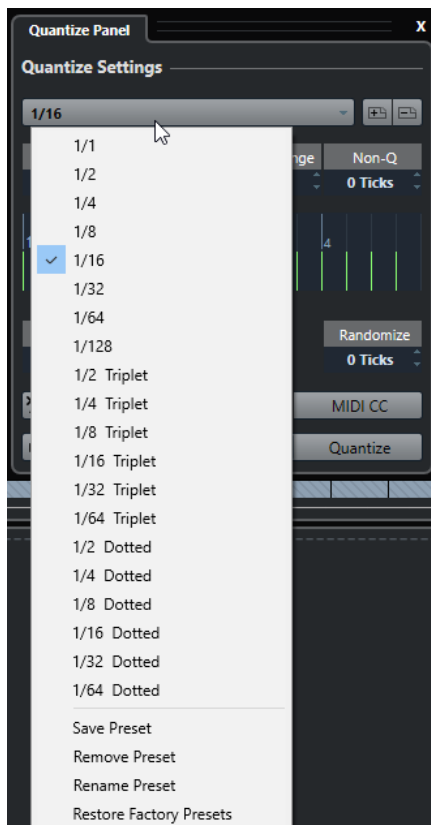

### Select Preset

Allows you to select a preset.

### Save Preset

Allows you to save the current settings as a preset, so that they become available on all **Quantize Presets** pop-up menus.

**Remove Preset**

Allows you to remove the selected preset.

**Rename Preset**

Opens a dialog where you can rename the selected preset.

**Restore Factory Presets**

Allows you to restore the factory presets.

## Creating Groove Quantize Presets

You can create a groove quantize map based on hitpoints that you have created in the **Sample Editor**.

---

PROCEDURE

1. In the **Project** window, double-click the audio event from which you want to extract the timing.  
The **Sample Editor** opens.
  2. Open the **Hitpoints** section.  
The hitpoints for the audio event are detected and displayed automatically.
  3. Click **Create Groove**.  
The groove is extracted.
- 

RESULT

The groove is extracted from the audio event and made available in the **Quantize Presets** pop-up menu on the **Project** window toolbar.

AFTER COMPLETING THIS TASK

Open the **Quantize Panel** and save the groove as a preset.

RELATED LINKS

[Creating a Groove Quantize Map](#) on page 440

[Quantize Presets](#) on page 265

## Options For Quantizing to a Musical Grid

You can use the musical grid to quantize your recorded music.

- To access the options for quantizing to a musical grid, select a musical time format from the **Select Preset** pop-up menu on the **Quantize Panel**.

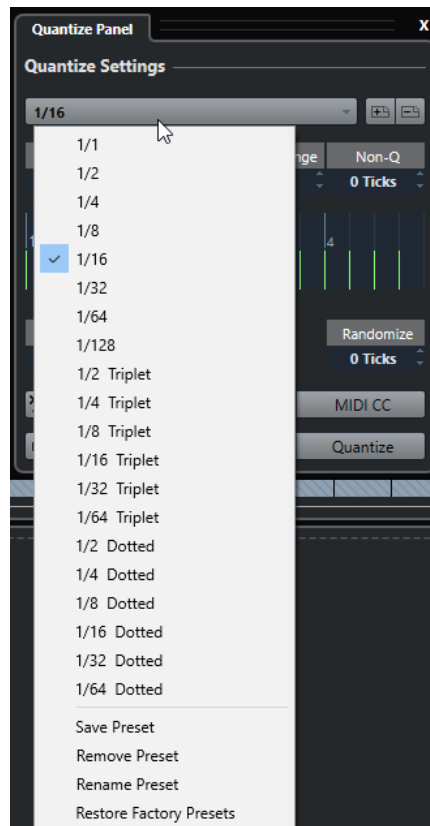

The following options are available:

### Grid

Allows you to select the basic value for the quantize grid.

### Swing

Offsets every second position in the grid, creating a swing or shuffle feel.

#### NOTE

**Swing** is only available if **Grid** is set to a straight value and **Tuplet** is deactivated.

### Catch Range

Allows you to set a value that determines that quantizing affects only audio or MIDI within the set distance from the grid lines. This is reflected in the grid display.

### Non-Quantize Range

Creates a safe zone before and after the quantize positions. If you specify a distance in ticks (120 ticks = one 16th note), events that lie within this zone are not quantized. This way, slight variations are kept.

### Grid display

Shows the quantize grid. Quantized audio or MIDI is moved to the positions indicated by the vertical grid lines.

### Tuplet

Creates rhythmically more complex grids by dividing the grid into smaller steps, and thereby creating n-tuplets.

### Randomize

Allows you to set a distance in ticks, so that your audio or MIDI is quantized to random positions within the specified distance from the quantize grid. This allows for

slight variations and, at the same time, prevents your audio or MIDI from ending up too far away from the grid.

#### Mode

Applies a loose quantization so that your audio or MIDI moves only part of the way to the closest quantize grid position. The **Iterative Strength** value to the right determines how close your audio or MIDI moves towards the grid.

#### NOTE

Iterative quantizing is based on the current, quantized positions and not on the original event positions. You can repeatedly use the **iQ** mode to gradually move your audio or MIDI closer to the quantize grid until you have found the right timing.

---

#### AudioWarp

Quantizes the content of your audio event by applying time stretch. The warp markers are aligned with the defined quantize grid.

#### MIDI CC

Moves controllers related to MIDI notes (pitchbend, etc.) automatically with the notes when these are quantized.

#### Reset Quantize

Resets your audio or MIDI to its original, unquantized state.

#### IMPORTANT

This function has no effect on an event that was moved manually.

---

#### Auto

Applies any changes immediately to the selected parts or events. A way of using this feature is to set up a playback loop and adjust the settings until you are satisfied with the result.

#### Quantize

Applies your settings.

## Options for Quantizing to a Groove

You can generate a timing grid from a MIDI part or an audio loop, and use this groove to quantize your recorded music. This way, you can recreate the rhythmic feel of this specific event or part.

To access the options for quantizing to a groove, select a MIDI part from an audio loop, an audio event with hitpoints, or sliced audio, and perform one of the following actions:

- Drag the part or event to the grid display in the middle of the **Quantize Panel**.
- Select **Edit > Advanced Quantize > Create Groove Quantize Preset**.

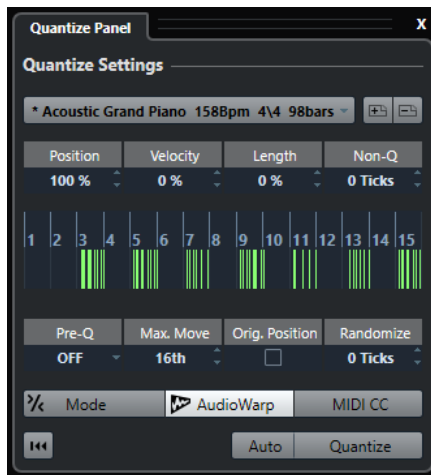

The following options become available:

### Position

Determines how much the timing of the groove affects the music.

### Velocity (MIDI Only)

Determines how much the velocity values within the groove affect the music.

NOTE

Not all grooves contain velocity information.

---

### Length (MIDI Only)

Allows you to specify how much the lengths of the notes are affected by the groove.

NOTE

For drums, the **Length** setting is ignored.

---

### Non-Quantize Range

Allows you to create a safe zone before and after the quantize positions. If you specify a distance in ticks (120 ticks = one 16th note), events that lie within this zone are not quantized. This way, slight variations are kept.

### Grid display

Shows the quantize grid. Quantized audio or MIDI is moved to the positions indicated by the vertical grid lines.

### Pre-Q

Allows you to select a musical grid to which you can quantize your audio or MIDI first. This gets the notes closer to their groove destination.

NOTE

If you apply a shuffle groove to a 16th-note pattern, for example, set up a pre-quantize value of 16 to straighten up the timing before applying the groove quantizing.

---

### Max. Move

Allows you to select a note value to specify a maximum distance that the audio or MIDI can be moved.

### **Orig. Position**

Sets the original starting position of the quantized material as starting point of the quantizing. This allows you to synchronize material that does not start from bar 1 of the project.

### **Randomize**

Allows you to set a distance in ticks so that your audio or MIDI is quantized to random positions within the specified distance from the quantize grid. This allows for slight variations and, at the same time, prevents your audio or MIDI from ending up too far away from the grid.

### **iQ Mode**

Applies a loose quantization so that your audio or MIDI moves only part of the way to the closest quantize grid position. The **Iterative Strength** value to the right determines how close your audio or MIDI moves towards the grid.

#### **NOTE**

Iterative quantizing is based on the current, quantized positions and not on the original event positions. You can repeatedly use the **iQ** mode to gradually move your audio or MIDI closer to the quantize grid until you have found the right timing.

---

### **AudioWarp**

Quantizes the content of your audio event by applying time stretch. The warp markers are aligned with the defined quantize grid.

### **MIDI CC**

Moves controllers related to MIDI notes (pitchbend, etc.) automatically with the notes when these are quantized.

### **Reset Quantize**

Resets your audio or MIDI to its original, unquantized state.

#### **IMPORTANT**

This function has no effect on an event that was moved manually.

---

### **Auto**

Applies any changes immediately to the selected parts or events. A way of using this feature is to set up a playback loop and adjust the settings until you are satisfied with the result.

### **Quantize**

Applies your settings.

#### RELATED LINKS

[Creating Groove Quantize Presets](#) on page 266

# Fades, Crossfades, and Envelopes

Fades allow you to gradually increase or decrease the volume at the start or end of audio events or audio clips, and to create smooth transitions.

You can create the following fades:

- **Fade ins/fade outs**

Fade ins and fade outs allow you to gradually increase or decrease the volume of audio events or audio clips. Fade ins and fade outs can be either event-based or clip-based.

Event-based fades are calculated in real time when you play back audio events. You can create different fade curves for several events, even if they refer to the same audio clip.

#### NOTE

The more event-based fades you apply, the more processing power is used.

Clip-based fades are applied to the audio clip. Events that refer to the same clip will have the same fades.

- **Crossfades**

Crossfades allow you to create smooth transitions for consecutive audio events on the same track. Crossfades are always event-based.

- **Auto fades**

Auto fades allow you to automatically apply short fade ins and fade outs to the events on specific audio tracks. You can also apply them globally on all audio tracks. This creates smooth transitions between events.

- **Event envelopes**

Event envelopes are volume curves for audio events or audio clips. They allow for volume changes not only at the start or the end, but also within the audio or clip. They can be either event-based or clip-based.

#### RELATED LINKS

[Event-Based Fades](#) on page 271

[Creating Clip-Based Fades](#) on page 275

[Crossfades](#) on page 276

[Auto Fades and Crossfades](#) on page 279

[Event Envelopes](#) on page 281

## Event-Based Fades

You can create event-based fade ins and fade outs. These are calculated in real time when you play back audio events. You can create different fade curves for several events, even if they refer to the same audio clip.

There are several ways to create event-based fades:

- By using the event handles

- By using range selections

You can edit event-based fades in the **Fade** dialogs.

#### RELATED LINKS

[Creating and Editing Fades with the Handles](#) on page 272

[Creating and Editing Fades with the Range Selection Tool](#) on page 273

[Fade Dialog for Event-Based Fades](#) on page 274

## Creating and Editing Fades with the Handles

You can create and edit event-based fade ins and fade outs using the event handles. This gives you a visual feedback and allows you to apply the same fade type to several selected events.

---

#### PROCEDURE

1. Select the audio events for which you want to create fades and point at one of them with the mouse.

Triangular fade handles become visible in the upper left and right corners.

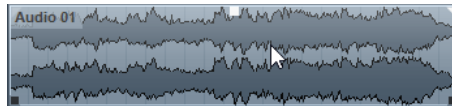

2. Perform one of the following actions:

- Drag the left fade handle to the right to create a fade in.

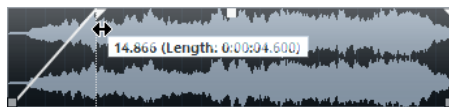

- Drag the right fade handle to the left to create a fade out.

---

#### RESULT

The fade is applied and shown in the event waveform. If you select multiple events, the same fade is applied to all selected events.

#### NOTE

You can change the length of the fades at any time by dragging the handles.

---

## Event Handles

Audio events have a fade-in and a fade-out handle, as well as a volume handle. These handles provide a quick way to change the fade length or the volume of events in the **Project** window.

Event handles become visible if you point the mouse at an event or if you select events.

#### NOTE

To show event handles and fade curves always and not only when you point at events, activate **Show Event Volume Curves Always** in the **Preferences** dialog (**Event Display—Audio** page).

---

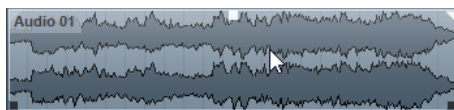



In the upper left and right corners, you find triangular fade handles that allow you to change the fade-in or fade-out length. In the top middle, you find a square handle that allows you to change the volume.

- To change the fade-in length, drag the fade handle in the upper left to the right or to the left.
- To change the fade-out length, drag the fade handle in the upper right to the left or to the right.
- To change the volume, drag the volume handle in the top middle up or down.

Fade and volume changes are reflected in the event waveform and on the info line.

#### NOTE

To change the event volume and the fades with the mouse wheel, activate **Use Mouse Wheel for Event Volume and Fades** in the **Preferences** dialog (**Editing—Audio** page). When you press **Shift** while moving the mouse wheel, and position the mouse pointer somewhere in the left half of the event, the fade in end point is moved. When the mouse pointer is in the right half of the event, the fade out start point is moved.

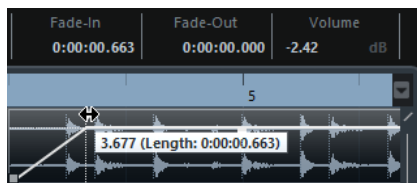

## Creating and Editing Fades with the Range Selection Tool

You can create and edit event-based fades with the **Range Selection** tool. This allows you to apply a fade in and a fade out at the same time. Using the **Range Selection** tool is also useful if you want to create fades for multiple audio events on separate tracks.

#### PROCEDURE

1. On the **Project** window toolbar, select the **Range Selection** tool.
2. Perform one of the following actions:
  - To create a fade in that starts at the event start, select a range that starts at the event start.
  - To create a fade out that ends at the event end, select a range that ends at the event end.
  - To create a fade in and a fade out, select a range in the middle of the event.
  - To create fades on multiple tracks, select a range that spans multiple audio events on multiple audio tracks.
3. Select **Audio > Adjust Fades to Range**.

## Removing Event-Based Fades

You can remove event-based fades for a whole event or for a range.

#### PROCEDURE

1. Perform one of the following actions:
  - To remove the fades for an event, select the event with the **Object Selection** tool.
  - To remove the fades for a range, select the fade area with the **Range Selection** tool.

2. Select **Audio > Remove Fades**.

## Fade Dialog for Event-Based Fades

The fade dialog for event-based fades allows you to set up the selected event-based fades.

- To open the dialog for event-based fades, create a fade for one or more audio events, select the events and select **Audio > Open Fade Editor(s)**.

### NOTE

If you select several events, you can adjust the fade curves for all selected events at the same time. This is useful if you want to apply the same type of fade in to more than one event, for example.

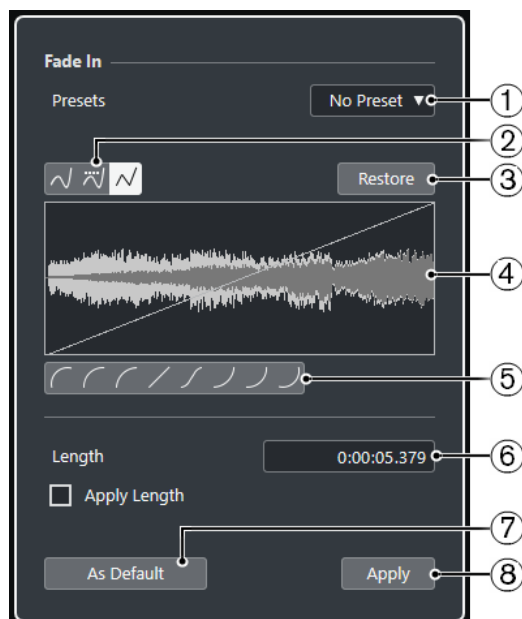

The following options are available:

### 1 Presets pop-up menu

Allows you to set up presets for fade-in or fade-out curves.

- To apply a saved preset, select it from the pop-up menu.
- To remove a saved preset, select it from the pop-up menu and click **Remove**.

### 2 Curve Type buttons

Apply a spline interpolation, a damped spline interpolation, or a linear interpolation to the curve.

### 3 Restore

Click this button to cancel any changes you have made since opening the dialog.

### 4 Fade display

Shows the shape of the fade curve. The resulting waveform shape is shown darker, the current waveform shape is shown lighter.

- To add points, click the curve.
- To change the curve shape, click and drag existing points.
- To remove a point from the curve, drag it outside the display.

### 5 Curve Shape buttons

Give you quick access to some common curve shapes.

## 6 Length field

Allows you to enter fade lengths numerically. The format of values displayed here is determined by the time display on the **Transport** panel.

- If you activate **Apply Length**, the value entered in the **Fade Length** value field is used when clicking **Apply** or **OK**.
- If you set the current fade as the default fade, the length value is included as part of the default settings.

## 7 As Default

Saves the current settings as default fade.

## 8 Apply

Applies the current fade settings to the selected events.

# Creating Clip-Based Fades

You can create and edit clip-based fade ins and fade outs using **Direct Offline Processing**. These fades are applied to the audio clip. Events that refer to the same clip get the same fades.

---

### PROCEDURE

1. In the **Project** window, select one or more audio events or a range for which you want to create a fade.  
The length of your selection determines the length of the fade area.
  2. Perform one of the following actions:
    - To create a fade in, select **Audio > Processes > Fade In**.
    - To create a fade out, select **Audio > Processes > Fade Out**.
  3. In the **Direct Offline Processing** window, click the **Curve Type** buttons to specify a fade curve, or click and drag with the mouse in the curve display to draw in a curve.
  4. Optional: Activate **Audition** to hear the effect of the specified fade on the selected audio event.
- 

### RESULT

The fade is applied to the audio. You can remove or modify the fades at any time using the **Direct Offline Processing** window.

### RELATED LINKS

[Direct Offline Processing](#) on page 386

[Fade In/Fade Out](#) on page 393

[On Processing Shared Clips](#) on page 275

# On Processing Shared Clips

If several events refer to the same audio clip, this clip is a shared clip. If you edit one of the events that refer to a shared clip, you can decide if you want to apply the processing to all events referring to this clip.

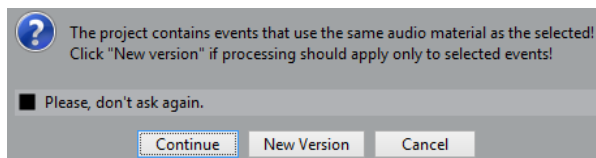

### Continue

Click **Continue** to apply the processing to all events that refer to the audio clip.

### New Version

Click **New Version** to create a separate, new version of the audio clip for the selected event.

## Crossfades

Crossfades allow you to create smooth transitions for consecutive audio events on the same track. Crossfades are always event-based.

You can only create crossfades if the consecutive events or their respective clips overlap.

- If the audio events overlap, a crossfade of the default shape (linear, symmetric) is applied in the overlapping area.

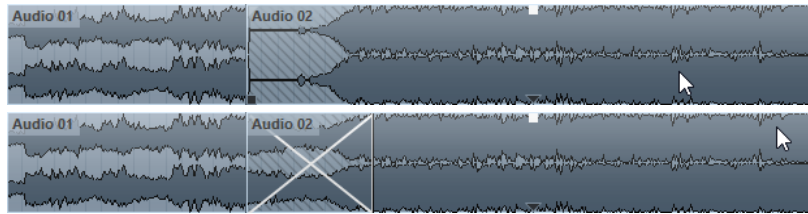

### NOTE

You can edit the default crossfade length and shape in the **Crossfade** editor.

- If the respective audio clips overlap, the two events are resized so that they overlap, and a crossfade of the default length and shape is applied in the overlapping area.
- If neither the audio events nor the clips overlap, a crossfade cannot be created.

### RELATED LINKS

[Crossfade Editor](#) on page 277

## Creating Crossfades

You can create crossfades between two consecutive audio events.

### PROCEDURE

1. Perform one of the following actions:
  - To create a crossfade between two events, select the **Object Selection** tool, and select two consecutive audio events.
  - To create a crossfade to a selected range between two events, select the **Range Selection** tool, and select a range covering the area where you want to apply a crossfade.
2. Select **Audio > Crossfade** or use the key command **X**.

### RESULT

The crossfade is applied.

## Changing the Crossfade Length

You can change the length of a crossfade.

### PROCEDURE

1. Select the **Range Selection** tool.

2. Select a range between two events that covers the length of the crossfade you want to apply.
3. Select **Audio > Adjust Fades to Range**.

#### RESULT

The crossfade length is adjusted to the selected range.

## Crossfade Editor

The **Crossfade** editor allows you to edit crossfades. It contains fade-in and fade-out curve settings, and common settings.

- To open the **Crossfade** editor, select one or both crossfaded events, and select **Audio > Crossfade**, or double-click the crossfade zone.

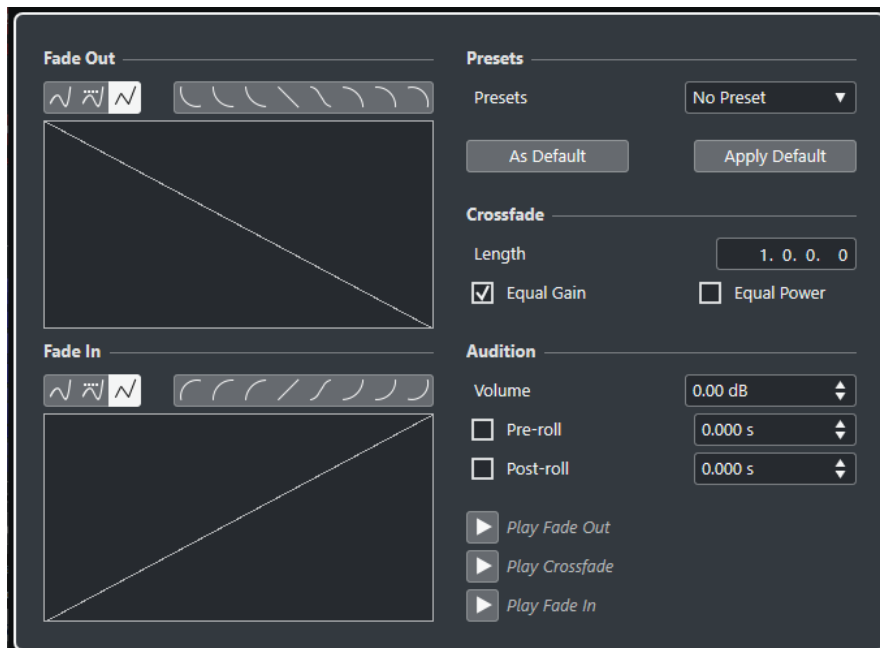

### Curve Type buttons

Determine whether the corresponding fade curve uses **Spline Interpolation** , **Damped Spline Interpolation** , or **Linear Interpolation** .

### Curve Shape buttons

Give you quick access to some common curve shapes.



### Fade Curve displays

Show the shape of the fade-out and fade-in curve, respectively.

- To add points, click a curve.
- To change the fade shape, click and drag existing points.
- To remove a point, drag a point outside the display.

### Presets

Click **Save Preset** on the **Presets** pop-up menu to store the crossfade settings so that you can apply them to other events.

- To remove a preset, select it on the pop-up menu and click **Remove Preset**.

### Default buttons

Click **As Default** to store the current settings as default. Default settings are used whenever you create new crossfades.

Click **Recall Default** to apply the curves and settings of the default crossfade.

### Length

Specifies the length of the crossfade area. Cubase tries to center the crossfade, that is, the length change is applied equally to both sides. To be able to resize a crossfade, it must be possible to resize the corresponding event. For example, if the fade-out event already plays its audio clip to the end, its end point cannot be moved any further to the right.

### Equal Gain

Adjusts the fade curves so that the summed fade-in and fade-out amplitudes are the same all along the crossfade region. This is often suitable for short crossfades.

### Equal Power

Adjusts the fade curves so that the energy (power) of the crossfade is constant all along the crossfade region.

**Equal Power** curves have only one editable curve point. You cannot change the curve shape if this mode is selected.

### Volume

Allows you to set the audition level.

### Pre-roll and Post-roll

- To start playback before the fade area, activate **Use Pre-roll**.
- To stop playback after the fade area, activate **Use Post-roll**.
- To adjust the pre-roll time, use the **Pre-roll Amount** value field.
- To adjust the post-roll time, use the **Post-roll Amount** value field.

### Audition buttons

- To audition the fade-out part of the crossfade, click **Play Fade Out**.
- To audition the whole crossfade, click **Play Crossfade**.
- To audition the fade-in part of the crossfade, click **Play Fade In**.

You can set up key commands for this in the **Key Commands** dialog.

### RELATED LINKS

[Key Commands](#) on page 854

[Event Handles](#) on page 272

[Auto-Scroll Settings Menu](#) on page 214

## Removing Crossfades

You can remove crossfades.

---

### PROCEDURE

1. Perform one of the following actions:
    - Select the **Object Selection** tool and select one of the crossfaded events.
    - Select the **Range Selection** tool and select the crossfades you want to remove.
  2. Select **Audio > Remove Fades**.
-

RESULT

The selected crossfades are removed.

NOTE

You can also remove a crossfade by clicking and dragging it outside the track.

---

## Auto Fades and Crossfades

Cubase features an **Auto Fade** function that can be set both globally and separately for each audio track. Auto fades allow you to create smoother transitions between events by applying fade ins and fade outs with a length between 1 and 500 ms.

IMPORTANT

As event-based fades are calculated in real time during playback, applying auto fades to a higher number of audio events results in a higher demand on the processor.

---

NOTE

Auto fades are not indicated by fade lines.



---

## Auto Fades Dialog

The **Auto Fades** dialog allows you to set up auto fades and crossfades for the whole project, or separately for each audio track.

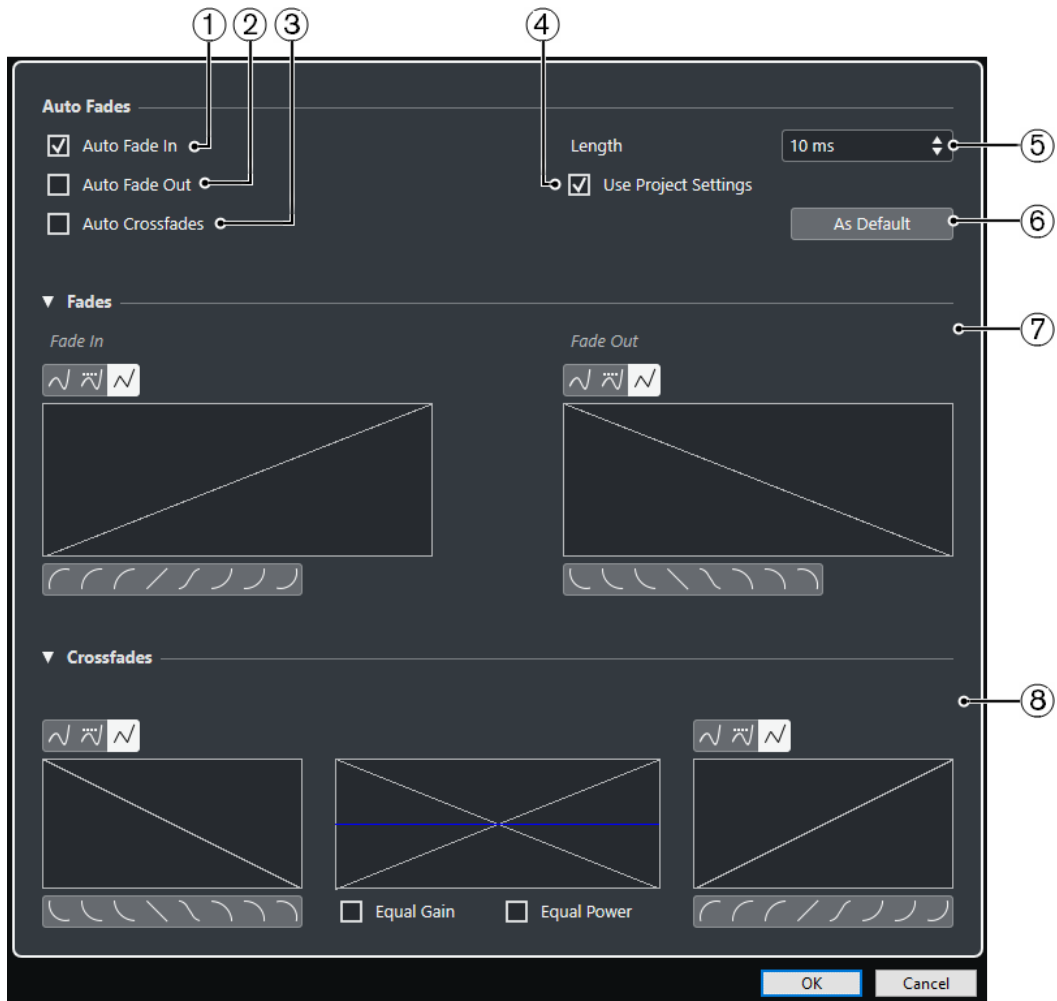
- To open the global **Auto Fades** dialog, select **Project > Auto Fades Settings**.
- To open the **Auto Fades** dialog for a track, right-click in the track list and select **Auto Fades Settings**.



- 1 Auto Fade In**  
Activates auto fade ins.
- 2 Auto Fade Out**  
Activates auto fade outs.
- 3 Auto Crossfades**  
Activates auto crossfades.
- 4 Use Project Settings**  
This is only available if you opened the **Auto Fades** dialog for individual tracks. Deactivate this to set up and apply the settings to individual tracks only. If you want a track with individual auto fade settings to use the global settings again, activate **Use Project Settings**.
- 5 Length**  
Specifies the length of the auto fades or crossfades.
- 6 As Default**  
Saves the current settings as default.
- 7 Fades section**  
Provides the settings for auto fades.  
The **Curve Type** buttons allow you to determine whether the corresponding fade curve uses **Spline Interpolation** , **Damped Spline Interpolation**  or **Linear Interpolation** .  
The **Curve Shape** buttons give you quick access to common curve shapes.
- 8 Crossfades section**



Provides the settings for auto crossfades.

**Equal Gain** allows you to adjust the fade curves so that the summed fade-in and fade-out amplitudes are the same all along the crossfade region.

**Equal Power** allows you to adjust the fade curves so that the energy (power) of the crossfade is constant all along the crossfade region.

## Making Global Auto Fade Settings

You can set up auto fades and crossfades for the whole project.

---

### PROCEDURE

1. Select **Project > Auto Fades Settings**.  
This opens the **Auto Fades** dialog for the project.
  2. Set up the fades as desired.
  3. Click **OK**.
- 

### RELATED LINKS

[Fade Dialog for Event-Based Fades](#) on page 274

[Crossfade Editor](#) on page 277

## Making Auto Fade Settings for Individual Tracks

As auto fades use computing power, you might consider to turn auto fades off globally and activate them only for individual tracks.

---

### PROCEDURE

1. Perform one of the following actions:
    - Right-click the track in the track list, and from the context menu, select **Auto Fades Settings**.
    - Select the track, and in the **Inspector**, click **Auto Fades Settings**.The **Auto Fades** dialog for the track opens.
  2. Deactivate **Use Project Settings**.  
Any settings you now make are applied to the track only.
  3. Set up the auto fades.
  4. Click **OK**.
- 

## Event Envelopes

Event envelopes are volume curves for audio events. They allow you to create volume changes within the event, not only at the start or end.

On the event envelopes, you can create volume changes by adding curve points with the **Draw** tool.

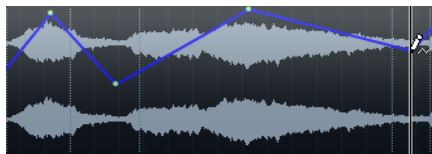

The envelope curve is a part of the audio event. If you move or copy the event, the event envelope follows.

## Creating Event-Based Volume Changes

You can create volume changes for the audio event.

---

### PROCEDURE

1. Zoom in on the event so that you can view its waveform properly.
2. Select the **Draw** tool and click at the position in the event where you want to change the volume.
3. Click with the **Draw** tool.



A curve point is added to the envelope curve.

4. Drag the curve point to adjust the volume curve.

---

### RESULT

The volume change is created. The waveform image of the event changes according to the volume change.

## Removing Event Envelopes

You can remove the entire event envelope or single curve points.

---

### PROCEDURE

- Perform one of the following actions:
  - To remove a curve point from the envelope, click on it and drag it outside the event.
  - To remove an event envelope curve from a selected event, select **Audio > Remove Volume Curve**.

## Creating Clip-Based Volume Changes

You can create volume changes for the audio clip. The audio event changes accordingly.

---

### PROCEDURE

1. In the **Project** window, select the event.
2. Select **Audio > Processes > Envelope**.
3. In the **Direct Offline Processing** dialog, make your changes, and click **Apply**.

---

### RESULT

The volume change is created. The waveform image of the event changes according to the volume change.

### RELATED LINKS

[Envelope](#) on page 393

# Arranger Track

The arranger functions in Cubase allow you to work in a non-linear fashion. Using an arranger track allows you to specify how and when specific sections are played back, even in live performances. This way, you do not need to move, copy, and paste events in the **Project** window.

## NOTE

There can be only one arranger track in a project.

To use the arranger functions, you must add an arranger track and define arranger events. Arranger events can be of any length. They can overlap and are not bound to the start or end of existing events and parts. You can order them in a list, and add repeats as desired.

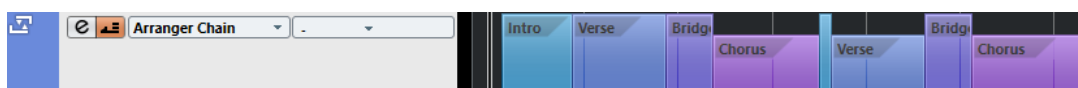

You can edit arranger events using the standard techniques. Copies from arranger events are independent from the original event.

You can create several arranger chains that allow you to save different versions of a song within the project.

You can flatten arranger chains to convert them into a linear project.

## RELATED LINKS

[Adding Arranger Events on the Arranger Track](#) on page 283

[Setting up an Arranger Chain and Adding Events](#) on page 287

[Flattening the Arranger Chain](#) on page 289

## Adding Arranger Events on the Arranger Track

On the arranger track, you can add arranger events that define specific sections of the project.

### PREREQUISITE

**Snap** is activated, and **Snap Type** is set to **Events**.

### PROCEDURE

1. Select **Project > Add Track > Arranger**.  
The arranger track is added.
2. Select the **Draw** tool and draw an arranger event on the arranger track.  
An arranger event is added.
3. Draw as many events as you need.

### RESULT

The arranger events are added to your project.

#### AFTER COMPLETING THIS TASK

Use the functions of the **Arranger Editor** to arrange the events.

#### RELATED LINKS

[Arranger Track](#) on page 128

[Setting up an Arranger Chain and Adding Events](#) on page 287

[Snap Function](#) on page 67

[Snap Types Menu](#) on page 68

## Renaming Arranger Events

When you add arranger events, they are automatically named in alphabetical order. You can change the names so that they reflect the structure of your project, such as Intro, Chorus, Bridge, for example.

---

#### PROCEDURE

1. Select the arranger event that you want to rename.
  2. Perform one of the following actions:
    - Select the event name on the info line.
    - Hold down **Alt** and double-click the name in the arranger chain.
  3. Enter a new name.
- 

## Arranger Editor

The **Arranger Editor** allows you to set up arranger chains.

- To open the **Arranger Editor**, select an arranger track, and click **Open Arranger Editor** in the track list.

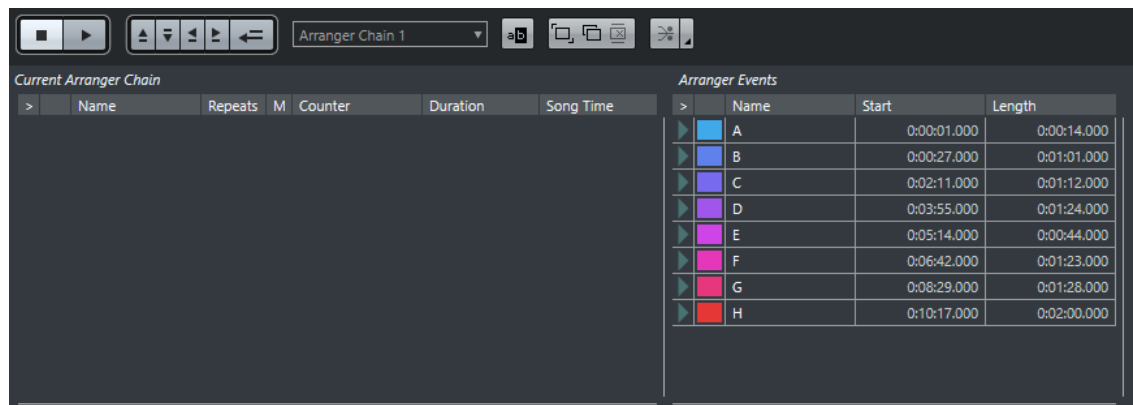

#### Arranger toolbar

Shows the transport buttons, the arranger transport buttons, and the arranger tools.

#### Current Arranger Chain

Shows the order in which the events are played back, from top to bottom, and how many times they are repeated.

#### NOTE

Initially, the arranger chain is empty. To fill it up, you must add events from the **Arranger Events** list.

---

### Arranger Events

Lists the available arranger events in the order they appear on the timeline.

## Arranger Editor Toolbar

The **Arranger Editor** contains tools and shortcuts for setting the flatten options.

- To open the **Arranger Editor**, select an arranger track, and click **Open Arranger Editor**  in the track list.

### Stop



Stops playback.

### Play



Starts playback.

### Previous Chain Step



Navigates to the previous entry in the current arranger chain list.

### Next Chain Step



Navigates to the next entry in the current arranger chain list.

### First Repeat of Current Chain Step



Navigates to the first repeat of the current entry in the current arranger chain list.

### Last Repeat of Current Chain Step



Navigates to the last repeat of the current entry in the current arranger chain list.

### Activate Arranger Mode



Activates playback in arranger mode.

### Select Active Chain

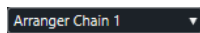

Allows you to select and activate an arranger chain.

### Rename Current Chain



Allows you to rename the current arranger chain.

### Create New Chain



Creates a new, empty arranger chain.

### Duplicate Current Chain



Creates a duplicate of the current arranger chain, containing the same events.

### Remove Current Chain



Removes the selected arranger chain. This is only available if you have created more than one arranger chain.

### Flatten



Converts the current arranger chain into a linear project.

### Flatten (with Options & Preferences)



Allows you to set up the flatten options.

## Arranger Chain Repeat Modes

The **Arranger Editor** features a function that allows you to repeat and loop your arranger events. This way, you can create a sketch of a song structure.

- To open the **Arranger Editor**, select an arranger track, and click **Open Arranger Editor** in the track list.

To select one of the repeat modes, click the **Mode** column in the **Current Arranger Chain** list.

#### 1 Normal

Plays back the arranger chain exactly the way you set it up.

#### 2 Repeat Forever

Repeats the current arranger event in a loop until you click another event in the **Arranger Editor** or until you click **Play** once again.

#### 3 Pause After Repeats

Pauses playback after all repeats of the current arranger event have been played back.

#### NOTE

During playback, the **Counter** column indicates which repetition of the event is playing.

## Flatten Options & Preferences

The flatten options allow you to define what happens when you flatten the arranger track.

- To show the flatten options, open the **Arranger Editor**, and click **Flatten (with Options & Preferences)**.

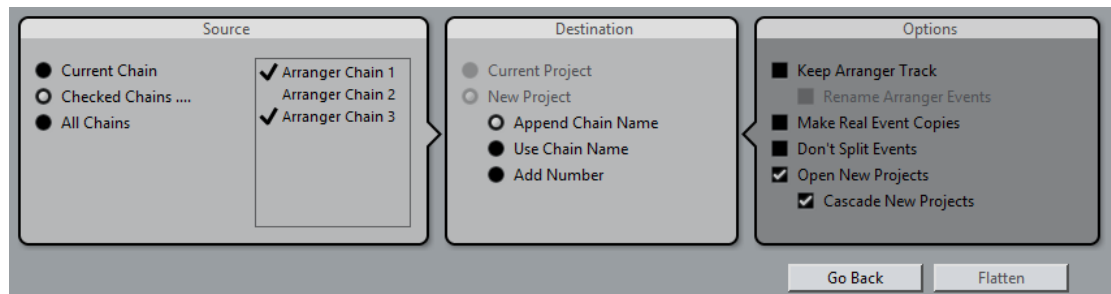

In the **Source** section, you can specify which arranger chains are flattened.

#### Current Chain

Flattens the current chain only.

### Checked Chains

Opens a list of the available arranger chains where you can activate the arranger tracks that you want to flatten.

### All Chains

Flattens all arranger chains of the current project.

The **Destination** section allows you to choose where the result of the flattening is saved.

### Current Project

This is only available if **Source** is set to **Current Chain**. Activate this option if you want to save the flattened chain in the current project.

### New Project

Allows you to flatten one or more chains in a new project with the following naming options:

- **Append Chain Name**  
Appends the chain names to the project name.
- **Use Chain Name**  
Names the new projects after the current arranger chains.
- **Add Number**  
Names the new projects after the old ones and adds a number.

The **Options** section contains further settings.

### Keep Arranger Track

Keeps the arranger track after flattening. Activate **Rename Arranger Events** to append numbers to the events.

### Make Real Event Copies

Allows you to create real copies of the arranger track instead of shared copies.

### Don't Split Events

Excludes MIDI notes that start before or are longer than the arranger event. Only MIDI notes that begin and end inside the arranger event are taken into account.

### Open New Projects

Creates a new project for every flattened arranger chain. If you activate **Cascade New Projects**, the opened projects are cascaded.

#### RELATED LINKS

[Flattening the Arranger Chain](#) on page 289

## Setting up an Arranger Chain and Adding Events

In the **Arranger Editor** you can set up arranger chains and add events to them.

---

#### PROCEDURE

1. Click **e** to open the **Arranger Editor**.
2. Activate **Activate Arranger Mode**.

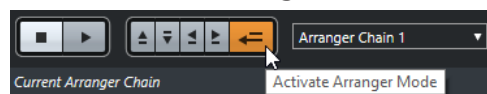

3. Perform one of the following actions to add arranger events to the arranger chain:
  - Double-click an event in the **Arranger Events** list.

- Select one or more events in the **Arranger Events** list, right-click, and select **Append Selected In Arranger Chain**.
- Drag an arranger event from the **Arranger Events** list and drop it in the **Current Arranger Chain** list.
- Drag an arranger event from the **Project** window and drop it in the **Current Arranger Chain** list.

4. Click **Play**.

---

#### RESULT

The arranger events are played back in the order that you specified in the arranger chain.

#### RELATED LINKS

[Arranger Chain Repeat Modes](#) on page 286

## Adding a New Arranger Chain

You can create several arranger chains in order to set up alternative versions for playback.

#### PREREQUISITE

**Arranger Mode** is activated.

---

#### PROCEDURE

1. Open the **Arranger Editor**.
  2. Click **Create New Chain**.
- 

#### RESULT

A new, empty arranger chain is activated. This is reflected by a new name in the **Select Active Chain** pop-up menu and a new, empty **Current Arranger Chain** list.

## Editing Arranger Events in the Arranger Chain

In the **Current Arranger Chain** list, you can edit your arranger events.

You can perform the following actions:

- To select multiple events, **Ctrl/Cmd**-click or **Shift**-click them.
- To move events in the list, drag them up or down.
- To copy events, select them, hold **Alt** and drag.
- To repeat events, click in the **Repeats** column and enter the number of repeats.
- To specify how the event is repeated, click in the **Mode** column and select a **Repeat Mode** from the pop-up menu.
- To move the playback position to the start of an event, click the arrow to the left of the event.
- To remove an event from the list, right-click on it, and from the context menu, select **Remove Touched**.
- To remove several events, select them, right-click, and from the context menu, select **Remove Selected**.

#### RELATED LINKS

[Arranger Chain Repeat Modes](#) on page 286



## Flattening the Arranger Chain

When you have set up an arranger chain that you like, and you are sure that you do not want to edit it any more, you can convert it to a linear project.

### PREREQUISITE

You have saved a copy of the project before flattening the arranger chain.

### NOTE

Flattening the arranger chain may remove events and parts from the project. Only use **Flatten** when you know you do not want to edit the arranger track/chain any more. If in doubt, save a copy of the project before flattening the arranger chain.

---

### PROCEDURE

1. Select the arranger chain that you want to convert into a linear project.
2. Optional: Click **Flatten (with Options & Preferences)**

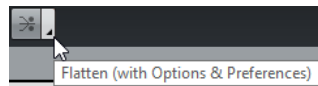

3. Optional: Activate the desired flattening options.

### NOTE

If you realize that you want to do further adjustments, click **Go Back**. The activated flatten options are kept.

---

4. Click **Flatten**.
- 

### RESULT

The events and parts in the project are reordered, repeated, resized, moved and/or deleted, so that they correspond exactly to the arranger chain.

## Jump Mode

If you have set up an arranger track and play it back, you have live access to the playback order. This way, you can loop your arranger events with more flexibility regarding the length of the playback.

### PREREQUISITE

An arranger chain is set up and the arranger mode is activated.

---

### PROCEDURE

1. Click **Play** to play back your project.
2. In the lower part of the **Inspector**, open the **Jump Mode** pop-up menu, and select an option from the pop-up menu.

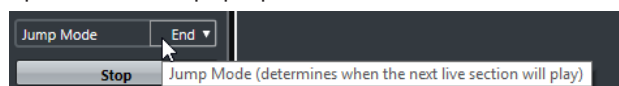

This determines how long the active arranger event is played, before jumping to the next one.

3. In the **Arranger Events** list of the **Inspector**, click the arrow to the left of the arranger event that you want to trigger.
-

#### RESULT

The arranger event is looped according to your settings, until you click another arranger event.

#### NOTE

You can assign key commands to trigger arranger events in the **Arranger** category of the **Key Commands** dialog.

---

#### AFTER COMPLETING THIS TASK

- To stop **Jump Mode**, click **Stop**.
- To continue playback from a specific arranger event, click the arranger event in the **Current Arranger Chain** list.

#### RELATED LINKS

[Jump Mode Options](#) on page 290

## Jump Mode Options

The **Jump Mode** pop-up menu allows you to define how long the active arranger event is played before jumping to the next one.

- To show the **Inspector** for the arranger track, select the arranger track in the track list.

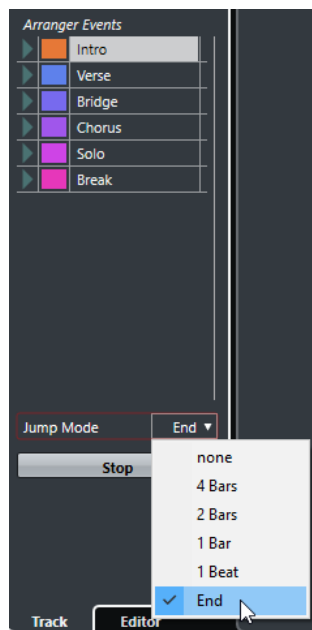

The following options are available:

#### None

Jumps to the next section immediately.

#### 4 Bars, 2 Bars

Jumps to the next arranger event after 2 or 4 bars. If the current arranger event is shorter than 2 or 4 bars, playback jumps to the next arranger event at the event end.

#### 1 Bar

Jumps to the next section at the next barline.

#### 1 Beat

Jumps to the next section at the next beat.

### End

Plays the current section to the end, then jumps to the next section.

## Arranging Music to Video

When you compose music for video, you can use arranger events to fill a specific video section with music. The following is an example on how you could do that.

### PREREQUISITE

You have connected and set up an external sync master device to your computer. You have created a new, empty project and added a MIDI track.

---

### PROCEDURE

1. Create a MIDI part that starts at position 00:00:00:00 and ends at position 00:01:00:00.
2. Create a MIDI part that starts at position 00:01:00:00 and ends at position 00:02:00:00.
3. Create a MIDI part that starts at position 00:02:00:00 and ends at position 00:03:00:00.
4. On the **Transport** panel, activate **Sync**.
5. Select **Project > Add Track > Arranger**.  
The arranger track is added.
6. On the arranger track, add arranger events at the positions of the MIDI parts.
7. Set up the arranger chain A-A-B-B-C-C.
8. Activate **Arranger** mode and click **Play**.
9. On your external sync master device, start external timecode at position 00:00:10:00.  
In your project, the position 00:00:10:00 is located, and arranger part A is played back.
10. Start your external sync master device at a position that does not match the project start time, for example, 00:01:10:00.  
In your project, the position 00:01:10:00 is located, and arranger part A is played back.

---

### RESULT

If you position the external sync master device to a position that does not match the project start time, Cubase automatically jumps to the right position in the arranger track.

### NOTE

The reference for the external timecode can be MIDI or any other timecode that can be interpreted by Cubase.

---

### RELATED LINKS

[Arranger Track](#) on page 128

# Transpose Functions

The transpose functions for audio and MIDI in Cubase allow you to change the pitches of audio and MIDI for playback without changing the actual MIDI notes or the audio.

You can transpose the following:

- An entire project by changing the **Project Root Key** on the **Project** window toolbar.
- Specific sections of your project by creating a transpose track and adding transpose events.
- Individual parts or events by changing their transpose value on the **Project** window info line.

## IMPORTANT

As a general rule, always set the root key first when you work with content with a defined root key.

## NOTE

To transpose MIDI notes on a selected track, you can also use MIDI modifiers. If you want to change the actual notes, use the MIDI transpose functions in the **Transpose Setup** dialog and in the MIDI effects (see the separate document **Plug-in Reference**).

## RELATED LINKS

[Transposing with the Project Root Key](#) on page 293

[Transposing Sections of a Project with Transpose Events](#) on page 296

[Transposing Individual Parts or Events using the Info Line](#) on page 298

[MIDI Modifiers](#) on page 593

[Transpose and Velocity on the Info Line](#) on page 601

[Transpose Setup Dialog](#) on page 608

## Project Root Key

The **Project Root Key** allows you to transpose your project. Audio or MIDI events in your project use it as a reference.

To change the **Project Root Key**, use the **Project Root Key** pop-up menu on the **Project** window toolbar.



If you change the project root key, loops that already contain root key information will follow automatically.

## RELATED LINKS

[Transposing with the Project Root Key](#) on page 293

## Transposing with the Project Root Key

The loops included in Cubase already contain root key information. If you change the project root key, these loops will follow automatically.

### PREREQUISITE

You have opened a project that contains audio loops with different root keys.

---

### PROCEDURE

1. Optional: Select the drum and percussion loops in your project and set the **Global Transpose** setting on the info line to **Independent**.  
This setting excludes the loops from being transposed.
2. On the **Project** window toolbar, open the **Project Root Key** pop-up menu and set a root key for the project.

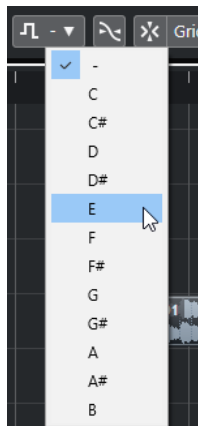

This changes the root key for the entire project and transposes the loops to match this key.

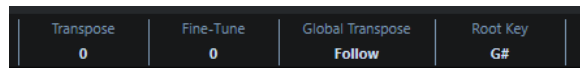

### RESULT

The loops follow the project root key.

### AFTER COMPLETING THIS TASK

Record audio or MIDI. The newly recorded events get the project root key. Change the project root key. The events with root key information follow.

### RELATED LINKS

[Excluding Individual Parts or Events from Global Transpose](#) on page 299

[Transpose Track and Recording](#) on page 298

## Assigning the Project Root Key to Parts or Events

Some audio or MIDI events that you have created by recording, for example, might not contain root key information. If you want them to follow the transposition changes, you must set them to the **Project Root Key**.

---

### PROCEDURE

1. On the **Project** window toolbar, open the **Project Root Key** pop-up menu and set a root key for the project.
2. Optional: Select the drum and percussion loops in your project and set the **Global Transpose** setting on the info line to **Independent**.

This setting excludes the loops from being transposed.

3. Select **Project > Add Track > Transpose**.

The transpose track is added to the track list. You can only have one transpose track in a project.

4. In the track list, right-click the transpose track, and from the context menu select **Set root key for unassigned events**.

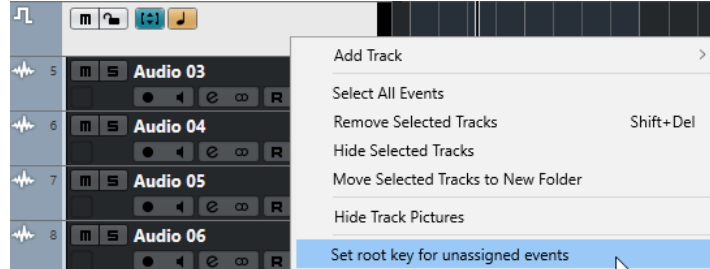

---

RESULT

All parts or events that do not contain any root key information are set to the project root key.

RELATED LINKS

[Excluding Individual Parts or Events from Global Transpose](#) on page 299

## Recording with a Project Root Key

If you record with a project root key, the recorded events follow this root key automatically. This function is useful if you want to change the root key later and you want the events to follow.

---

PROCEDURE

1. Optional: Select the drum and percussion loops in your project and set the **Global Transpose** setting on the info line to **Independent**.  
This setting excludes the loops from being transposed.
2. On the **Project** window toolbar, open the **Project Root Key** pop-up menu and set the root key.  
All parts and events are transposed in order to match the root key.
3. Record your music.

---

RESULT

All recorded audio events and MIDI parts get the project root key information. On the info line, the **Global Transpose** setting for recorded events is set to **Follow**.

AFTER COMPLETING THIS TASK

Change the project root key. Your events will follow.

## Changing the Root Key of Individual Audio Events

You can change or set the root key information for individual audio events or parts in the **Pool**.

---

PROCEDURE

1. Select **Media > Open Pool Window**.
2. Open the **View/Attributes** pop-up menu, and activate the **Root Key** option.  
The **Key** column is displayed in the **Pool** window.

3. Click the **Key** column for the audio event or part that you want to assign a different root key to, and select a key from the pop-up menu.
- 

RESULT

The root key of the audio event or part is changed. The corresponding audio file, however, remains unchanged. If you change the project root key, the audio events or parts keep their own root key settings, and are transposed to match the **Project Root Key**.

NOTE

You can also assign root keys in the **MediaBay**.

---

NOTE

Save the root key in the audio file by selecting the audio event in the event display, and by selecting **Audio > Bounce Selection**.

---

## Changing the Root Key of Individual MIDI Parts

You can change the root key information for individual MIDI parts in the **Project** window info line.

---

PROCEDURE

1. In the event display, select the MIDI part.
  2. In the **Project** window info line, click **Root Key** and select a key from the pop-up menu.
- 

RESULT

The root key of the MIDI part is changed. If you change the project root key, the MIDI parts keep their own root key settings, and are transposed to match the **Project Root Key**.

## Transpose Track

The transpose track allows you to transpose the entire project or sections of it. This function is useful if you want to create harmonic variations.

For this function to work, you must add transpose events. These transpose events allow you to transpose specific sections of your project in semitones.

---

EXAMPLE

If your singer does not reach a certain pitch, you can transpose the entire project by adding a transpose track and creating a transpose event with the value -2 semitones. After recording, set the transpose event back to 0.

---

EXAMPLE

If you want to brighten up your loops in C major, you can transpose them by adding a transpose track and creating a transpose event with the value 5. This transposes them by 5 semitones, so that the subdominant on F major is played back.

---

EXAMPLE

If you want to turn your song more interesting, you can transpose the last chorus of your project by adding a transpose track and creating a transpose event with the value 1.

---

## Transposing Sections of a Project with Transpose Events

You can transpose specific sections of your project by creating transpose events on the transpose track.

---

### PROCEDURE

1. Select **Project > Add Track > Transpose**.

The transpose track is added to the track list. You can only have one transpose track in a project.

2. Select the **Draw** tool and click on the transpose track.

A transpose event is created from the point where you clicked until the end of the project.

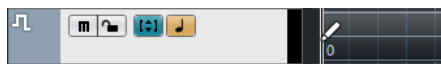

3. Click at a new position to add another transpose event.



4. Click the value in the lower left corner of the event, and enter a transpose value between -24 and 24 semitones.

5. Play back your project.

---

### RESULT

The sections of your project that are situated at the same time positions as the transpose events are transposed.

### RELATED LINKS

[Excluding Individual Parts or Events from Global Transpose](#) on page 299

## Muting Events on the Transpose Track

You can mute transpose events on the transpose track. This is useful if you want to compare the effect of the transposition with the original sound, for example.

---

### PROCEDURE

- In the track list of the transpose track, click **Mute Transpose Events**.

---

### RESULT

The transpose events are not taken into account during playback.

## Transpose Lock

The lock function on the transpose track allows you to prevent your transpose events from being moved or changed by mistake.

To lock the transpose track, activate **Lock** in the track list.





## Keep Transpose in Octave Range

**Keep Transpose in Octave Range** on the transpose track keeps the transposition in the octave range.

This ensures that nothing is transposed by more than seven semitones, and that your music never sounds unnatural because the pitch was raised too high or too low. We also recommend activating this function, when you work with audio loops.

---

### EXAMPLE

You have opened the **Key Editor** and activated **Indicate Transpositions** .

You have added a transpose track and activated **Transpose in Octave Range** .

If you add a transpose event with a value of 8 semitones or higher, the chord is transposed to the nearest interval or pitch.

---

## Indicate Transpositions

For MIDI parts, you can get a visual feedback that allows you to compare the original sounds and the music transposed for playback.

- To activate **Indicate Transpositions** for a MIDI part, open the part in the **Key Editor**, and click **Indicate Transpositions**.

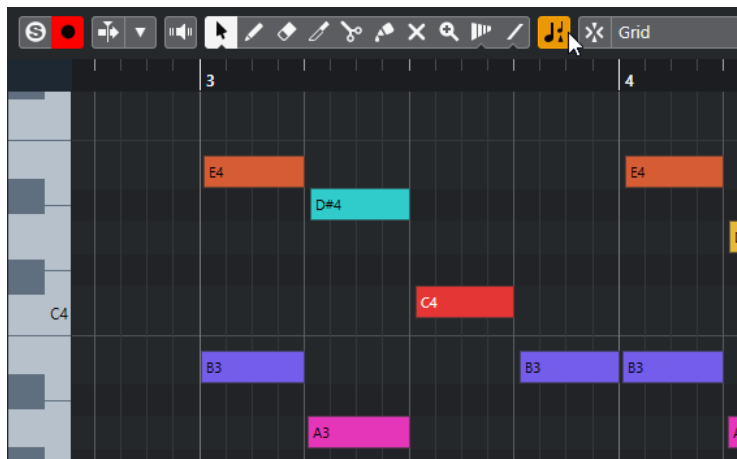

If **Indicate Transpositions** is activated, the transposed note pitches are shown.

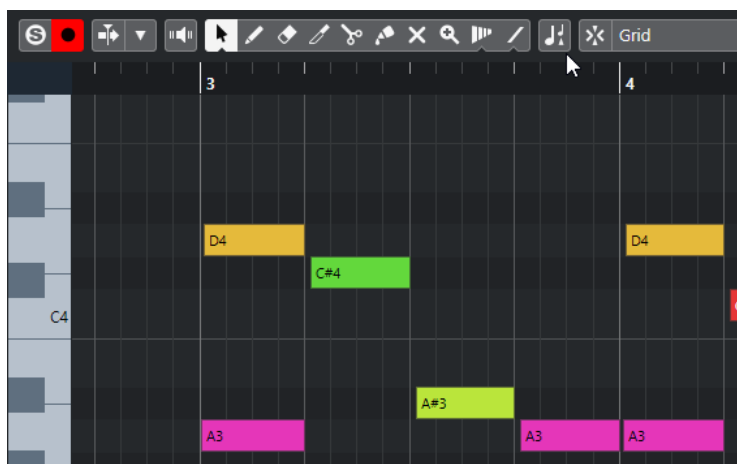

If **Indicate Transpositions** is deactivated, the original pitches of the notes in the MIDI part are shown.

## Transpose Track and Recording

The transpose track affects the result of the recorded parts or events.

If your project contains a transpose track with transpose events, and you record audio or MIDI, the following happens:

- **Global Transpose** is automatically set to **Independent** for the recorded parts or events.
- The project root key is not taken into account.

If your project does not contain a transpose track or if no transpose events are added, the following happens:

- **Global Transpose** is automatically set to **Follow** for the recorded parts or events.
- The recorded parts or events get the project root key.

## Transpose on the Info Line

In the **Project** window info line, you can change the transpose value for individual parts or events.

To do this, change the transpose value in the **Transpose** field on the info line.

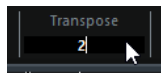

The Transpose field also indicates transpositions introduced by changing the **Project Root Key**.

## Transposing Individual Parts or Events using the Info Line

You can transpose individual audio events and MIDI parts on the info line **Transpose** field.

---

### PROCEDURE

1. Select the event or part that you want to transpose.
2. On the **Project** window info line, click the **Transpose** field and enter a transpose value in semitones.

### NOTE

If the project already contains global transpose changes, it might be useful to activate **Keep Transpose in Octave Range**.

---

### RESULT

The event is transposed accordingly. The transpose value is added to any global transpose change that you have created by using the root key or the transpose track.

### RELATED LINKS

[Keep Transpose in Octave Range](#) on page 297

## Excluding Individual Parts or Events from Global Transpose

If you add global transposition, for example, by changing the root key or by creating transpose events, you can exclude specific events from being transposed. This is useful for drum and percussion loops or special effects (FX) loops.

---

### PROCEDURE

1. Select the event or part that you want to exclude from being transposed.
2. On the info line, click the **Global Transpose** field to set the value to **Independent**.  
Events that are excluded from **Global Transpose** show a symbol in the upper right corner.

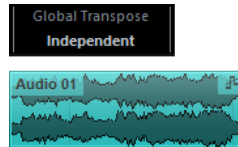

---

### RESULT

If you change the project root key or add transpose events, the **Independent** parts or events are not affected.

### NOTE

Ready-made parts or events that are tagged as drums or FX, are automatically set to **Independent**.

---

# Markers

Markers are used to locate certain positions quickly. There are two types of markers: position markers and cycle markers.

If you often find yourself jumping to a specific position within a project, you should insert a marker at this position. You can also use markers to make range selections or for zooming.

Markers are located on the marker track. You can add 1 marker track.

## RELATED LINKS

[Position Markers](#) on page 300

[Cycle Markers](#) on page 300

[Marker Track](#) on page 304

## Position Markers

Position markers allow you to save a specific position.

Position markers on the marker track are shown as marker events: vertical lines with the marker description (if assigned) and number beside it. If you select a marker track, all its markers are shown in the **Inspector**.

## Cycle Markers

By creating cycle markers you can save any number of left and right locator positions as start and end positions of a range and recall them by double-clicking on the corresponding marker.

Cycle markers are shown on a marker track as two markers bridged by a horizontal line. Cycle markers are ideal for saving sections of a project.

By defining cycle markers for the intro, verse, and chorus of a song, for example, you can quickly navigate to the song sections and repeat the section by activating **Activate Cycle** on the **Transport** panel.

## Setting the Locators Using Cycle Markers

Cycle markers represent ranges in your project. You can use them for moving the left and right locators.

---

### PROCEDURE

- To set the left locator to the cycle marker start and the right locator to the cycle marker end, perform one of the following actions:
    - Double-click on a cycle marker.
    - From the **Cycle** pop-up menu in the track list, select a cycle marker.
-

#### RESULT

The left and right locators are moved to encompass the cycle marker.

#### AFTER COMPLETING THIS TASK

Now you can move the project cursor position to the start or the end of the cycle marker by moving it to the corresponding locator or use cycle markers to export specific ranges of your project with the **Export Audio Mixdown** dialog.

## Editing Cycle Markers

When editing cycle markers on a marker track, snap is taken into account.

- To add a cycle marker, press **Ctrl/Cmd**, click and drag on the marker track.
- To change the start/end position of a cycle marker, drag the start/end handle.
- To move a cycle marker to another position, drag the upper border.
- To delete a cycle marker, click with the **Erase** tool.  
If you hold down **Alt** when you click, all consecutive markers are deleted.
- To cut a range in a cycle marker, select a range in the cycle marker and press **Ctrl/Cmd-X**.
- To set the marker start/end of the selected cycle marker to the cursor position, select **Project > Markers** to open the **Markers** window, and select **Functions > Set Marker Start/End to Cursor**.
- To set the left and right locators, double-click a cycle marker.
- To zoom in on a cycle marker, press **Alt** and double-click the cycle marker.

## Markers Window

In the **Markers** window, you can view and edit markers. The markers on the marker track are displayed in the marker list in the order in which they occur in the project.

To open the **Markers** window, you have the following possibilities:

- Select **Project > Markers**.
- On the **Transport** panel in the marker section, click **Show**.
- Use a key command (by default **Ctrl/Cmd-M**).

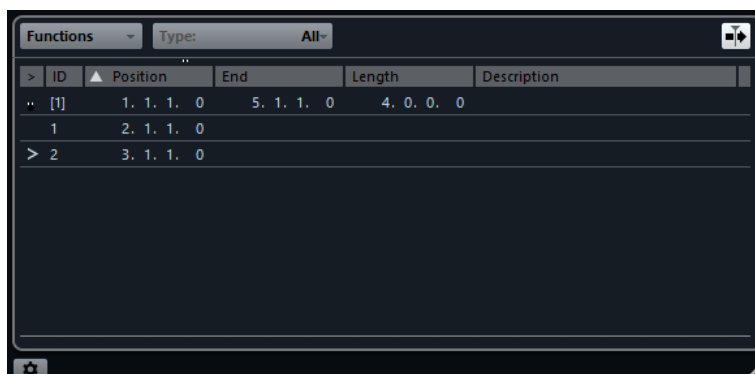

#### Functions menu

Lists all functions available in the **Marker** window.

#### Filter Markers

Allows you to specify which marker type is shown in the marker list.

### Auto-Scroll with Project Cursor

Allows you to keep track of the locate arrow, even if your project contains a large number of markers. If this option is activated, the **Marker** window is automatically scrolled to keep the locate arrow visible.

### Markers list

Shows the markers in the order in which they occur in the project.

### Marker Settings

Shows the marker settings.

## Editing in the Markers Window

In the **Markers** window, you can select, edit, add, move, and remove markers.

- To select or edit a marker, click on it.  
Select multiple markers by **Shift-** or **Ctrl/Cmd-**clicking them.
- To add a position marker at the cursor position, select **Functions > Insert Marker**.  
A position marker is added at the current project cursor position on the marker track.
- To add a cycle marker at the cursor position, select **Functions > Insert Cycle Marker**.  
This adds a cycle marker between the left and right locators on the marker track.
- To move a marker to the cursor position, select the marker and select **Functions > Move Markers to Cursor**.  
You can also enter the new position numerically in the **Position** column. If a cycle marker is selected, the move operation affects the cycle marker start position.
- To remove a marker, select it and select **Functions > Remove Marker**.

## Navigating in the Marker List

You can navigate in the marker list using your computer keyboard and select entries by pressing **Return**. This is a quick and easy way to jump to markers during playback or recording.

- To move to the previous/next marker in the list, press the **Up Arrow/Down Arrow** keys.
- To jump to the first/last marker, press the **Page Up/Page Down** keys.

## Sorting and Reordering the Marker List

You can customize the display of the marker attributes in the marker list by sorting or reordering the columns.

- To sort the marker list by a specific attribute, click on the corresponding column header.
- To reorder the marker attributes, drag and drop the corresponding column headers.
- To adjust the width of a column, place the mouse pointer between two column headers and drag left or right.

### NOTE

No matter by which attribute you sort, the second sort criterion will always be the position attribute.

---

## Marker Settings

You can make general marker settings for your project.

- To open the marker settings, select **Project > Markers**, and click **Marker Settings** .

### Cycle follows when locating to Markers

This sets the left and right locators automatically to a position or cycle marker, when locating to this marker. This is useful if you need to set the locators on the fly during recording for Punch In/Punch Out, for example.

### Show marker IDs on marker track

If this option is activated, the marker IDs are shown on the marker track.

### Sync Selection

If this option is activated, the **Markers** window selection is linked to the selection in the **Project** window.

## Marker Attributes

Marker attributes are shown in the marker list of the **Markers** window.

- To open the **Markers** window, select **Project > Markers**.

The following attributes are available:

#### Locate

An arrow indicates which marker is at the project cursor position (or closest to the project cursor). If you click in this column, the project cursor is moved to the corresponding marker position. This column cannot be hidden.

#### ID

This column shows the marker ID numbers.

#### Position

In this column, you can view and edit the markers' time positions (or start positions for cycle markers). This column cannot be hidden.

#### End

In this column, you can view and edit the end positions of cycle markers.

#### Length

In this column, you can view and edit the length of cycle markers.

#### Description

Here you can enter names or descriptions for markers.

#### RELATED LINKS

[Marker IDs](#) on page 304

[Cycle Markers](#) on page 300

## Editing Attributes

- To edit a marker attribute, select the corresponding marker, click in the desired attribute column, and make your changes.
- To change the attributes of several markers, select the markers and activate the checkbox for the attribute.

All selected markers change their attributes accordingly. Note that this does not work when clicking on a timecode value or a text field.

#### NOTE

To navigate in the list of marker attributes, you can also use the **Tab** key and the **Up Arrow**, **Down Arrow**, **Left Arrow**, and **Right Arrow** keys.

---

## Sorting and Reordering Columns

You can customize the display of the marker attributes in the marker list by sorting or reordering the columns.

- To sort the marker list by a specific attribute, click on the corresponding column header.

### NOTE

No matter by which attribute you sort, the second sort criterion will always be the position attribute.

- To reorder the marker attributes, drag and drop the corresponding column headers.
- To adjust the width of a column, place the mouse pointer between two column headers and drag left or right.

## Marker IDs

Each time you add a marker, it is automatically and sequentially assigned an ID number, starting from 1.

IDs for cycle markers are shown in brackets and start from 1. ID numbers can be changed at any time – this allows you to assign specific markers to key commands.

## Reassigning Marker IDs

Sometimes, especially when setting markers on the fly, you may forget or miss to set a marker. When added later, this marker's ID will not correspond to its position on the marker track. Therefore, it is possible to reassign the IDs for all markers on a track.

### PROCEDURE

1. Open the **Markers** window.
2. Open the **Functions** pop-up menu and select either **Reassign Position Marker IDs** or **Reassign Cycle Marker IDs**.

### RESULT

The marker IDs of the selected type are reassigned to match the order of markers on the marker track.

## Marker Track

A marker track is used for adding and editing markers.

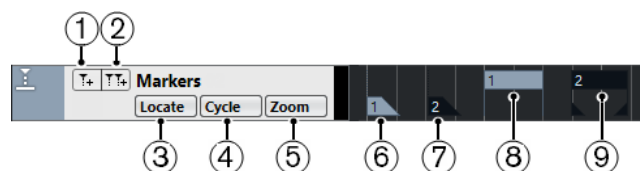

### 1 Add Marker

Adds a position marker at the cursor position.

### 2 Add Cycle Marker

Adds a cycle marker at the cursor position.

### 3 Locate pop-up menu

If you select a position or a cycle marker in this pop-up menu, the corresponding marker in the event display or in the **Markers** window is selected.



- 4 Cycle pop-up menu**  
If you select a cycle marker in this pop-up menu, the left and right locators are set to the corresponding cycle marker.
- 5 Zoom pop-up menu**  
If you select a cycle marker in this pop-up menu, the view zooms to the corresponding cycle marker.
- 6 Toggle Time Base**  
Sets the track time base.
- 7 Lock**  
Locks the marker track. When a marker track is locked, you cannot edit the track and its markers.
- 8 Marker event (inactive)**  
Shows an inactive marker event.
- 9 Marker event (active)**  
Shows an active marker event.
- 10 Cycle marker event (inactive)**  
Shows an inactive cycle marker event.
- 11 Cycle marker event (active)**  
Shows an active cycle marker event.

## Adding, Moving, and Removing the Marker Track

You can add, move, and remove the marker track.

- To add a marker track to the project, select **Project > Add Track > Marker**.
- To move a marker track to another position in the track list, click and drag it up or down.
- To remove the marker track, right-click it in the track list and select **Remove Selected Tracks**.
- To remove an empty marker track, select **Project > Remove Empty Tracks**. This also removes any other tracks that are empty.

## Editing Markers on the Marker Track

You can edit markers on the marker track.

- To add a position marker, click **Add Marker** or use the **Draw** tool.
- To add a cycle marker, click **Add Cycle Marker** or use the **Draw** tool.
- To select a marker, use the standard techniques.
- To resize a cycle marker, select it and drag the handles. You can also do this numerically on the info line.
- To move a marker, select it and drag it. You can also edit marker positions on the info line.
- To remove a marker, select it and press **Delete** or use the **Erase** tool.

### RELATED LINKS

[Marker Track](#) on page 304

## Using Markers to Select Ranges

Markers can be used in conjunction with the **Range Selection** tool to make range selections in the **Project** window. This is useful if you quickly want to make a selection that spans all tracks in the project.

---

### PROCEDURE

1. Set markers at the start and end of the section that you want to move or copy.
  2. Select the **Range Selection** tool and double-click on the marker track between the markers.  
Everything in the project within the marker boundaries is selected. Any functions or processing you perform now affect the selection only.
  3. Click on the marker track in the selected range and drag the range to a new position.  
If you hold down **Alt** while you drag the range, the selection in the **Project** window is copied instead.
- 

## Importing and Exporting Markers

Markers and marker tracks can be imported and exported.

The following files can contain markers:

- MIDI files

### Importing Markers via MIDI

You can import position markers by importing MIDI files containing markers. This is useful if you want to use your marker tracks in other projects or if you want to share them with other Cubase users. Any markers you have added are included in the MIDI file as standard MIDI file marker events.

- Activate **Import Markers** in the **Preferences** dialog (**MIDI—MIDI File** page).

The following settings are imported:

- The start position of position markers and cycle markers

### RELATED LINKS

[Importing MIDI Files](#) on page 259

### Exporting Markers via MIDI

You can export your markers as part of a MIDI file.

- To include any markers in the MIDI file, activate **Export Markers** in the **Export Options** dialog.

The following settings are exported:

- The start position of position markers and cycle markers

### NOTE

To be able to export markers via MIDI export, your project must contain a marker track.

---

### RELATED LINKS

[Exporting MIDI Tracks as Standard MIDI Files](#) on page 141

# MixConsole

The **MixConsole** provides a common environment for producing mixes in stereo or surround. It allows you to control level, pan, solo/mute status, etc. for audio and MIDI channels. Furthermore, you can set up the input and output routing for multiple tracks or channels at the same time. You can undo/redo **MixConsole** parameter changes for an open project at any time.

You can open the **MixConsole** in a separate window or in the lower zone of the **Project** window.

While the **MixConsole** in the lower zone of the **Project** window features the key functions for mixing, the separate **MixConsole** window gives you access to additional functions and settings.

## RELATED LINKS

[MixConsole in Lower Zone](#) on page 307

[MixConsole Window](#) on page 310

## MixConsole in Lower Zone

You can show a **MixConsole** in the lower zone of the **Project** window. This is useful if you want to access the most important **MixConsole** functions from within a fixed zone of the **Project** window. The **MixConsole** in the lower zone of the **Project** window is a separate **MixConsole** that does not follow any visibility changes you perform in the **MixConsole** window.

To open a **MixConsole** in the lower zone of the **Project** window, do one of the following:

- Press **Alt-F3**.
- Select **Studio > MixConsole in Project Window**.

The **MixConsole** in the lower zone of the **Project** window is divided into the following sections:

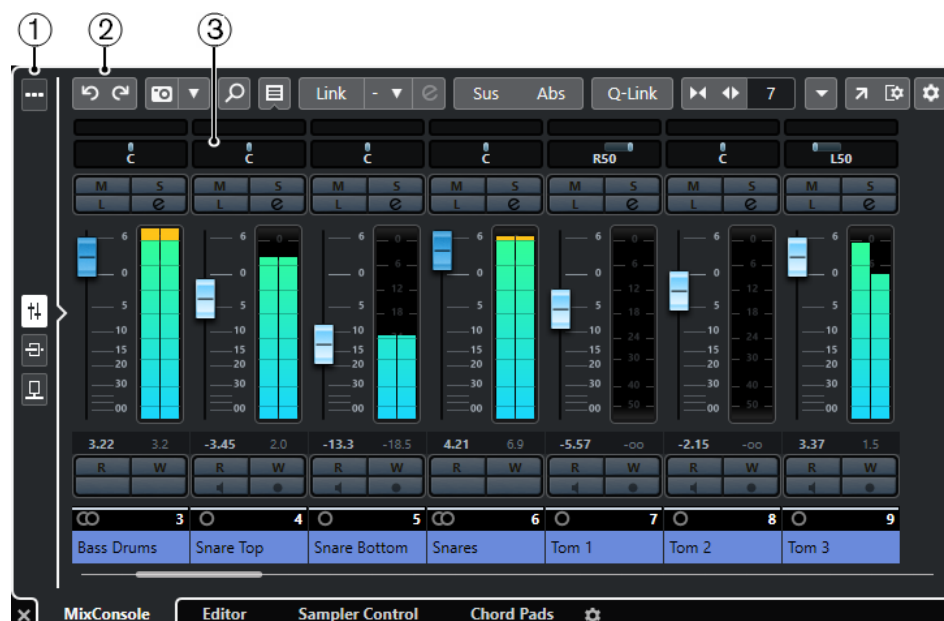

**1 Page selector**

Allows you to select what page is displayed in the fader section: the channel faders, the insert effects for a channel, or the send effects. The top button allows you to show/hide the toolbar.

**2 Toolbar**

The toolbar shows tools and shortcuts for settings and functions in the **MixConsole**.

**3 Fader section**

The fader section is always visible and shows all channels in the same order as in the track list.

RELATED LINKS

[Fader Section](#) on page 326

[Inserts](#) on page 335

[Sends](#) on page 346

[Filtering Channel Types](#) on page 320

[Undoing/Redoing MixConsole Parameter Changes](#) on page 319

[Linking Channels](#) on page 324

[Functions Menu](#) on page 324

## Showing/Hiding MixConsole Channels in the Lower Zone

To determine what channels are visible in the **MixConsole** in the lower zone of the **Project** window, you must use the **Visibility** tab in the left zone of the **Project** window.

---

PROCEDURE

1. Click **Show/Hide Left Zone** on the **Project** window toolbar to activate the **Left Zone**.
2. At the top of the left zone, click the **Visibility** tab.
3. At the bottom of the left zone, click the **Track** tab.

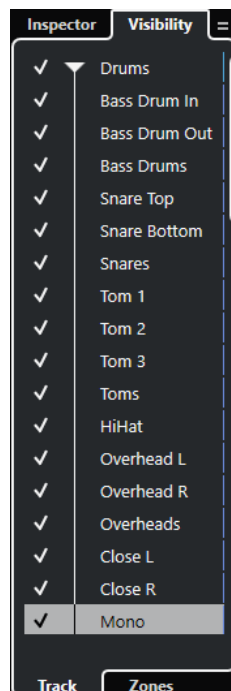

4. Click to the left of a track name to activate/deactivate the visibility for a channel.
-

#### RESULT

The track in the track list and the corresponding **MixConsole** channel are shown/hidden in the lower zone of the **Project** window.

#### RELATED LINKS

[Opening the Visibility](#) on page 50

[Visibility](#) on page 49

## Determining the MixConsole Channel Order in the Lower Zone

You can determine and lock the position of **MixConsole** channels in the lower zone of the **Project** window.

---

#### PROCEDURE

1. At the top of the left zone, click the **Visibility** tab.
2. At the bottom of the left zone, click the **Zones** tab.

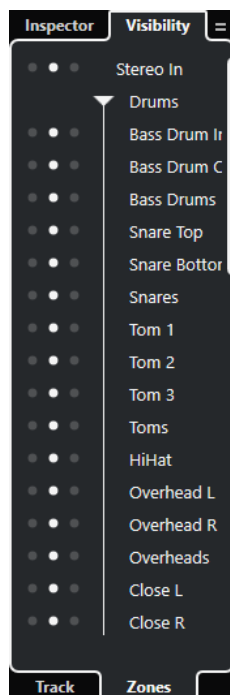

3. Do one of the following:
    - To lock a channel on the left of the fader section, click the left dot next to the channel name.
    - To lock a channel on the right of the fader section, click the right dot next to the channel name.
- 

#### RESULT

The channel is locked. Locked channels are always displayed.

#### RELATED LINKS

[Opening the Zones](#) on page 51

## MixConsole Window

You can open the **MixConsole** in a separate window.

To open the **MixConsole**, do one of the following:

- Press **F3**.
- Select **Studio > MixConsole**.
- On the **Project** window toolbar, click **Open MixConsole**.

### NOTE

This is only visible on the toolbar if the **Media & MixConsole Windows** section is activated.



The **MixConsole** is divided into the following sections:

### 1 Toolbar

The toolbar shows tools and shortcuts for settings and functions in the **MixConsole**.

### 2 Left Zone

The left zone features the following tabs:

- The **Visibility** tab with the following tabs:
  - The **Channel** tab allows you to show/hide individual channels from the **MixConsole**.
  - The **Zones** tab allows you to determine and lock the position of certain **MixConsole** channels.
- The **History** tab lists all **MixConsole** parameter changes, and allows you to undo/redo specific changes.

### 3 Fader section

The fader section is always visible and shows all channels in the same order as in the track list.



Apart from the main sections, you can also access the following sections from within the **MixConsole** window:

- 1 Channel overview**  
Displays all channels as boxes. If you have more channels than can be displayed in the window, you can use the channel overview to navigate to other channels and select them.
- 2 Meter bridge**  
Allows you to monitor the levels of your channels.
- 3 Equalizer curves**  
Allows you to draw an EQ curve. Click in the curve display to open a larger view where you can edit the curve points.
- 4 Channel racks**  
Allows you to show additional channel controls as needed.
- 5 Pictures**

Allows you to add a picture to the selected channel. Pictures can help you identify your **MixConsole** channels quickly.

## 6 Notepads

Allows you to enter notes and comments about a channel. Each channel has its own notepad.

## 7 Channel Latencies

Allows you to show the latencies caused by insert effects or channel strip modules.

### RELATED LINKS

[MixConsole Left Zone](#) on page 312

[MixConsole Toolbar](#) on page 314

[Project Window Toolbar](#) on page 32

[Fader Section](#) on page 326

[Channel Racks Selector](#) on page 322

[Track Pictures Browser](#) on page 145

[Adding Notes to a MixConsole Channel](#) on page 348

[Channel Latency Overview](#) on page 348

[Channel Strips](#) on page 339

## MixConsole Left Zone

The left zone of the **MixConsole** shows several tabs that allow you to change the visibility and the position of specific channels or to undo parameter changes.

- To show/hide the left zone of the **MixConsole**, click **Show/Hide Left Zone** in the **MixConsole** window toolbar.

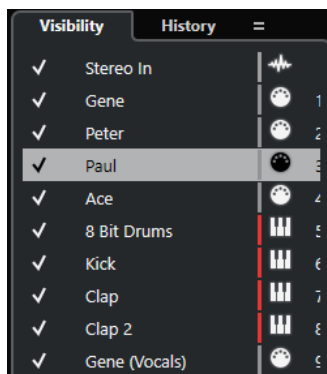

The following tabs are available at the top of the left zone:

### Visibility

Lists all channels contained in your project, and allows you to show/hide specific channels.

### History

Lists all **MixConsole** parameter changes, and allows you to undo/redo specific changes.

The following tabs are available at the bottom of the left zone:

### Channel

Lists all channels contained in your project.

### Zones

Allows you to lock the position of specific channels.



RELATED LINKS

[Undoing/Redoing MixConsole Parameter Changes](#) on page 319

[MixConsole Toolbar](#) on page 314

## MixConsole Visibility

The **Visibility** tab in the **MixConsole** lists all channels contained in your project, and allows you to show/hide specific channels.

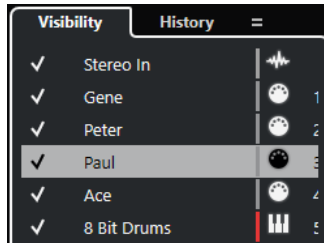

- To show/hide channels, check/uncheck them by clicking to the left of the channel name.
- To collapse/expand groups and folders, click the group or folder name.

### NOTE

The **MixConsole** in the lower zone of the **Project** window does not follow any visibility changes that you perform in the **MixConsole** window and vice versa.

---

RELATED LINKS

[Synchronizing Channel and Track Visibility](#) on page 313

## Synchronizing Channel and Track Visibility

You can synchronize the channel visibility in the **MixConsole** with the track visibility in the **Project** window.

---

### PROCEDURE

1. In the left zone of the **MixConsole**, open the **Visibility** tab.
  2. Click **Sync Visibility of Project and MixConsole: On/Off** .
  3. Select **Sync Project and MixConsole** to synchronize the channel visibility with the track visibility.
- 

### RESULT

The track and channel visibility are synchronized.

### NOTE

Channels that are locked on the **Zones** tab are not synchronized.

---

RELATED LINKS

[MixConsole Visibility](#) on page 313

[Synchronizing Track and Channel Visibility](#) on page 51

## MixConsole Zones

The **Zones** tab lists all channels contained in your project, and allows you to lock the position of specific channels.

- To lock channels on the left/right of the fader section, click the left or right dots next to the channel names.  
Locked channels are excluded from scrolling. They are always visible.

### NOTE

The **MixConsole** in the lower zone of the **Project** window does not follow any visibility changes that you perform in the **MixConsole** window and vice versa.

---

## MixConsole History

The **History** tab lists all **MixConsole** parameter changes, and allows you to undo/redo specific changes.

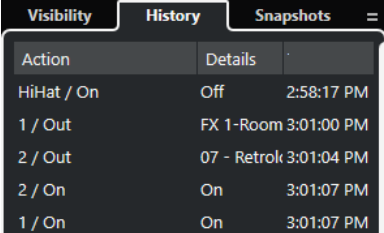

Action	Details	
HiHat / On	Off	2:58:17 PM
1 / Out	FX 1-Room	3:01:00 PM
2 / Out	07 - Retrok	3:01:04 PM
2 / On	On	3:01:07 PM
1 / On	On	3:01:07 PM

- To undo **MixConsole** parameter actions, click the orange line in the history list and drag it up.
- To redo **MixConsole** parameter actions, click the orange line in the history list and drag it down.

### NOTE

You can also undo/redo **MixConsole** parameter actions by using the corresponding buttons in the **MixConsole** toolbar.

---

### RELATED LINKS

[Undoing/Redoing MixConsole Parameter Changes](#) on page 319

## MixConsole Toolbar

The toolbar contains tools and shortcuts for settings and functions in the **MixConsole**.

### NOTE

The **MixConsole** toolbar in the lower zone of the **Project** window contains a limited set of tools.

---

## MixConsole History

### Undo/Redo



These buttons allow you to undo/redo **MixConsole** parameter changes.

## Left Divider

### Left Divider



Allows you to use the left divider. Tools that are placed to the left of the divider are always shown.

## Search

### Find Track/Channel



Opens a selector that lists all tracks/channels.

## Channel Visibility Configuration

### Channel Visibility Configurations

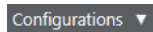

Allows you to create configurations that are useful for switching quickly between different visibility setups.

### Set Channel Type Filter



Opens the channel filter that allows you to show/hide all channels of a certain channel type.

## Racks

### Select Rack Types



Opens the rack selector that allows you to show/hide specific racks.

### Rack Settings



Opens a pop-up menu with settings for the racks.

## Locators

### Go to Left Locator Position



Allows you to go to the left locator position.

### Left Locator Position

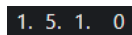

Shows the left locator position.

### Go to Right Locator Position



Allows you to go to the right locator position.

### Right Locator Position

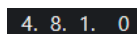

Shows the right locator position.

## Locator Range Duration

### Locators to Selection



Allows you to set the locators to the selection.

### Locator Range Duration

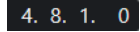

Shows the duration of the locator range.

## Transport Buttons

### Go to Previous Marker/Zero



Moves the project cursor to the previous marker/zero position on the timeline.

### Go to Next Marker/Project End



Moves the project cursor to the next marker/project end.

### Rewind



Moves backward.

### Forward



Moves forward.

### Activate Cycle



Activates/Deactivates cycle mode.

### Stop



Stops playback.

### Start



Starts playback.

### Transport Record



Activates/Deactivates record mode.

## Time Displays

### Primary Time Display

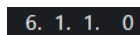

Shows the position of the project cursor in the selected time format.

### Select Primary Time Format



Allows you to select a time format for the primary time display.

### Secondary Time Display

**0:00:11.000**

Shows the position of the project cursor in the selected time format.

### Select Secondary Time Format



Allows you to select a time format for the secondary time display.

### Markers

#### Jump to Marker



Allows you to set and locate marker positions.

#### Open Markers Window



Opens the **Markers** window.

### State Buttons

#### Deactivate All Mute States



Deactivates all mute states.

#### Deactivate All Solo States



Deactivates all solo states.

#### Activate/Deactivate Read for All Tracks



Activates/Deactivates read automation for all tracks.

#### Activate/Deactivate Write for All Tracks



Activates/Deactivates write automation for all tracks.

#### Suspend All Read/Write Automation



Suspends all read/write automation.

#### Bypass Inserts



Bypasses all inserts.

#### Bypass EQs



Bypasses all EQs.

#### Bypass Channel Strip



Bypasses all channel strip modules.

#### Bypass Sends



Bypasses all sends.

## Link Group

### Temporary Link Mode



Synchronizes all touched parameters of selected channels.

## Zoom Palette

### Reduce Channel Width



Allows you to reduce the channel width.

### Set Number of Channels



Displays the set number of channels.

### Increase Channel Width



Allows you to increase the channel width.

### Reduce Rack Height



Allows you to reduce the rack height.

### Increase Rack Height



Allows you to increase the rack height.

## System Performance Meter

### System Performance Meter



Shows the meters for average audio processing load and the disk cache load.

## Right Divider

### Right Divider



Tools that are placed to the right of the divider are always shown.

## Mixer Functions Menu

### Functions Menu



Opens a pop-up menu where you can select a **MixConsole** function.

## Window Zone Controls

### Show/Hide Left Zone



Shows/Hides the left zone of the window.

### Set up Window Layout



Allows you to set up the window layout.

### Set up Toolbar

#### Set up Toolbar



Opens a pop-up menu where you can set up which toolbar elements are visible.

## Finding Channels

The **Find Track/Channel** function allows you to find specific channels. This is useful if you have a large project with many channels or if you have hidden channels using the visibility features.

---

#### PROCEDURE

1. Click **Find Track/Channel** on the **MixConsole** toolbar to open a selector that lists all channels.
2. In the search field, enter the name of the channel.  
As you type, the selector filters automatically.
3. In the selector, select the channel and press **Return**.

---

#### RESULT

The channel is selected in the channel list.

#### NOTE

If the channel was outside the view or hidden, it is now shown. Channels that are hidden using **Set Channel Type Filter** are not shown.

---

## Undoing/Redoing MixConsole Parameter Changes

You can undo/redo **MixConsole** parameter changes and experiment with different **MixConsole** settings.

#### NOTE

**MixConsole** parameters that change due to read automation actions are not part of the **MixConsole** history.

---

To undo/redo a **MixConsole** parameter, do one of the following:

- On the **MixConsole** toolbar in the **MixConsole** window or in the lower zone of the **Project** window, click **Undo** or **Redo**.
- Press **Alt-Z** to undo **MixConsole** parameter changes or press **Alt-Shift-Z** to redo parameter changes.

The following **MixConsole** parameter changes can be undone/redone:

- Volume changes
- Panorama changes
- Changes on the **Routing** rack
- Filter, gain, and phase changes in the **Pre** rack
- Plug-in changes in the **Inserts** rack
- EQ changes

- Changes on the **Channel Strip** rack
- Changes on the **Sends** rack

#### IMPORTANT

The **MixConsole** history is not saved with the project.

---

#### RELATED LINKS

[MixConsole History](#) on page 314

[MixConsole Toolbar](#) on page 314

## Filtering Channel Types

The channel types filter on the **MixConsole** toolbar allows you to determine which channel types are shown.

---

#### PROCEDURE

1. Click **Set Channel Type Filter**.  
This opens the channel types filter.

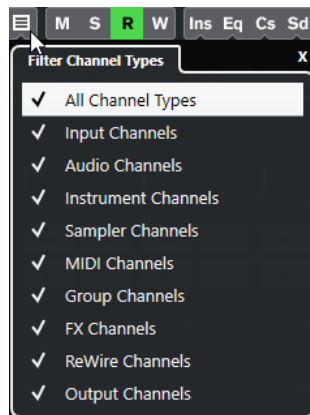

2. Click to the left of a channel type to uncheck it and hide all channels of that type.
- 

#### RESULT

Channels of the filtered type are removed from the fader section and the color of the **Set Channel Type Filter** button changes to indicate that a channel type is hidden.

## Channel Visibility Configurations Menu

The **Channel Visibility Configurations** button on the **MixConsole** toolbar allows you to create configurations that are useful for switching quickly between different visibility setups.

The button displays the name of the active configuration. A list of configurations is shown as soon as you create at least one configuration. To load a configuration, select it from the menu. Channel visibility configurations are saved with the project.

#### Add Configuration

Opens the **Add Configuration** dialog that allows you to save the configuration and enter a name for it.

#### Update Configuration

If you change the active configuration, this is indicated by an asterisk after the configuration name. Use this function to save changes to the active configuration.



### **Rename Configuration**

Opens the **Rename Configuration** dialog that allows you to rename the active configuration.

### **Delete Configuration**

Allows you to delete the active configuration.

### **Move Configuration to Position**

This function becomes available if 2 or more configurations exist. It allows you to change the position of the active configuration on the menu. This is useful as you can assign key commands to the first 8 configurations in the **Channel & Track Visibility** category of the **Key Commands** dialog.

## **Saving Configurations**

To quickly switch between different channel setups, you can save configurations. The configurations contain visibility and zone settings as well as the show/hide status of channel types and racks.

---

### PROCEDURE

1. Set up the configuration that you want to save.
2. On the toolbar, click **Channel Visibility Configurations**.
3. From the pop-up menu, select **Add Configuration**.
4. In the **Add Configuration** dialog, enter a name for the configuration.
5. Click **OK**.

---

### RESULT

The configuration is saved and you can return to it at any time.

## **Channel Visibility Agents**

Channel visibility agents allow you to show or hide all channels, selected channels, or channels with certain properties.

To open the **Channel Visibility Agents** pop-up menu, do one of the following:

- Click **Channel Visibility Agents** on the toolbar.
- In the left zone of the **MixConsole**, select the **Visibility** tab and right-click an empty area to open the context menu.

## **Channel Visibility Agents Menu**

Channel visibility agents menu contains options that allow you to show or hide all channels, selected channels, or channels with certain properties.

- To open the **Channel Visibility Agents** pop-up menu, click **Channel Visibility Agents** on the toolbar.

### **Show All Channels**

Shows all channels of your project.

### **Show Only Selected Channels**

Shows only channels that are selected.

### **Hide Selected Channels**

Hides all channels that are selected.

### Show Channels for Tracks with Data

Shows all channels for tracks with events or parts.

### Show Channels for Tracks with Data at the Cursor Position

Shows all channels for tracks with events or parts at the cursor position.

### Show Channels for Tracks with Data between the Locators

Shows all channels for tracks with events or parts between the locators.

### Show Channels that are Connected to the First Selected Channel

Shows all channels that are connected to the channel you first selected.

### Undo Visibility Change

Undoes visibility changes.

### Redo Visibility Change

Redoes visibility changes.

#### NOTE

You can assign key commands for the channel visibility agents in the **Channel & Track Visibility** category of the **Key Commands** dialog.

---

## Undoing/Redoing Visibility Changes

You can undo/redo up to 10 visibility changes.

---

#### PROCEDURE

1. On the **MixConsole** toolbar, click **Channel Visibility Agents**.
  2. Select **Undo Visibility Change** or **Redo Visibility Change**.
- 

## Rack Selector

The rack selector allows you to activate specific **MixConsole** functions that are organized in racks, such as routing, insert, or send handling.

### Channel Racks Selector

You can activate and deactivate the different channel racks in the **MixConsole**.

- To open the rack selector, click **Select Rack Types** on the **MixConsole** toolbar.

Depending on the channel type, you can activate/deactivate the following racks:

#### Hardware

Allows you to control your audio hardware effects. This rack is only available if supported by your hardware.

#### Routing

Allows you to set up the input and output routing. For MIDI, you can also select the MIDI channel.

#### Pre (Filters/Gain/Phase)

For audio-related channels, it contains input filter and gain controls along with **Phase** and **Gain** controls. For MIDI channels, it contains an **Input Transformer** control.

#### Inserts

Allows you to select insert effects for your channel.

### **Equalizers (audio-related channels only)**

Allows you to set the channel EQ.

### **Channel Strip (audio-related channels only)**

Allows you to integrate channel strip modules, such as Gate, Compressor, EQ, Transformer, Saturator, and Limiter that allow you to enhance your sound.

### **Sends**

Allows you to select send effects for your channel.

### **Track Quick Controls**

Allows you to add quick controls for instant access.

#### RELATED LINKS

[MixConsole Toolbar](#) on page 314

## **Rack Settings Menu**

The **Rack Settings** pop-up menu allows you to make settings for the racks.

- To open the **Rack Settings** pop-up menu, click **Rack Settings** on the **MixConsole** toolbar.

### **Exclusive Expanded Rack**

Shows the selected rack exclusively and collapses the other racks.

### **Fixed Number of Slots**

Shows all available slots for the **Inserts**, **Sends**, **Cues**, and **Quick Controls** racks.

### **Link Racks to Configurations**

If this option is activated, the rack status is taken into account when you save and load a configuration.

### **Show Pre/Filters as <Combined Label & Setting>**

Select **Combined Label & Setting** if you want to show the label and the setting in one line.

Select **Separate Label & Setting** if you want to show the label and the setting in separate lines.

### **Show Inserts as <Plug-in Names & Insert Controls>**

Select **Plug-in Names** if you want to show the plug-in names only.

Select **Plug-in Names & Insert Controls** if you want to show the plug-in names and the insert controls.

### **Show All Channel Strip Controls**

Shows all available controls on the **Channel Strip** rack.

### **Show One Channel Strip Type**

Shows only one channel strip type at a time.

### **Show Sends as <Send Destination & Gain>**

Select **Send Destination & Gain** if you want to show the destination and the gain in one line.

Select **Send Destination, Gain & Send Controls** if you want to show the destination, the gain and the send controls.

### **Show Quick Controls as <Combined Destination & Value>**

Select **Combined Destination & Value** if you want to show the destination and the value in one line.

Select **Separate Destination & Value** if you want to show the destination and the value in separate lines.

RELATED LINKS

[MixConsole Toolbar](#) on page 314

## Linking Channels

You can link selected channels in the **MixConsole** temporarily. Any change that is applied to one channel is mirrored by all linked channels.

## Using Quick Link

You can activate the **Temporary Link Mode** to synchronize all touched parameters of selected channels.

---

PROCEDURE

1. Select the channels that you want to link.
2. On the **MixConsole** toolbar, activate **Q-Link**.

NOTE

You can also press **Shift-Alt** to temporarily link channels. In that case, the link is only active as long as you press the keys.

3. Change the parameters for one of the selected channels.
- 

RESULT

The changes are applied to all selected channels until you deactivate **Q-Link**.

## Functions Menu

The **Functions Menu** contains tools and shortcuts for settings and functions in the **MixConsole**.

- To open the **Functions Menu**, click **Functions Menu** on the **MixConsole** toolbar.

### Scroll to Selected Channel

If this option is activated and you select a channel on the **Visibility** tab, the selected channel is automatically displayed in the fader section.

### Copy First Selected Channel's Settings

Copies the settings of the first selected channel.

### Paste Settings to Selected Channels

Pastes the settings to the selected channels.

### Zoom

Opens a submenu where you can increase or reduce the channel width and the rack height.

### Open Audio Connections

Opens the **Audio Connections** window.

### Constrain Delay Compensation

Allows you to activate/deactivate the **Constrain Delay Compensation** that keeps all channels in perfect sync and automatically compensates any delay inherent in VST plug-ins during playback.

### **EQ/Filter Transition**

Allows you to change the **EQ/Filter Transition** mode from **Soft** to **Quick**.

### **Save Selected Channels**

Saves the settings for the selected channels.

### **Load Selected Channels**

Loads the settings for the selected channels.

### **Global Meter Settings**

Opens a submenu where you can set up the global meter settings.

### **Reset MixConsole Channels**

Allows you to reset EQ, insert, and send effect settings for all or selected channels.

Solo and mute buttons are deactivated, the volume fader is set to 0 dB, and pan is set to the center position.

#### RELATED LINKS

[MixConsole Toolbar](#) on page 314

## **Saving MixConsole Settings**

You can save **MixConsole** settings for selected audio-related channels and load them into any project.

---

#### PROCEDURE

1. Select the channels with the settings that you want to save.
2. Select **Functions Menu > Save Selected Channels**.
3. In the file dialog, specify the file name and location.
4. Click **Save**.

---

#### RESULT

The settings for the selected channels are saved with the file extension `.vmx`. The input/output routing is not saved.

## **Loading MixConsole Settings**

You can load **MixConsole** settings that have been saved for selected channels.

---

#### PROCEDURE

1. Select the same number of channels that you selected when you saved your **MixConsole** settings.  
The loaded **MixConsole** settings are applied in the same order as originally saved. For example, if you have saved the settings for channels 4, 6, and 8, and apply these settings to channels 1, 2, and 3, the settings saved for channel 4 are applied to channel 1, the settings saved for channel 6 to channel 2, and so on.
2. Select **Functions Menu > Load Selected Channels**.
3. In the **Load Selected Channels** dialog, select the `.vmx` file and click **Open**.

---

#### RESULT

The channel settings are applied to the selected channels.

NOTE

When you apply loaded **MixConsole** settings to fewer channels, some of the saved settings are not applied. Since the saved settings are applied from left to right as shown in the **MixConsole**, the settings for the channels furthest to the right are not applied to any channels.

---

## Fader Section

The fader section is the heart of the **MixConsole**. It shows input and output channels together with audio, instrument, MIDI, group, FX, and ReWire channels.

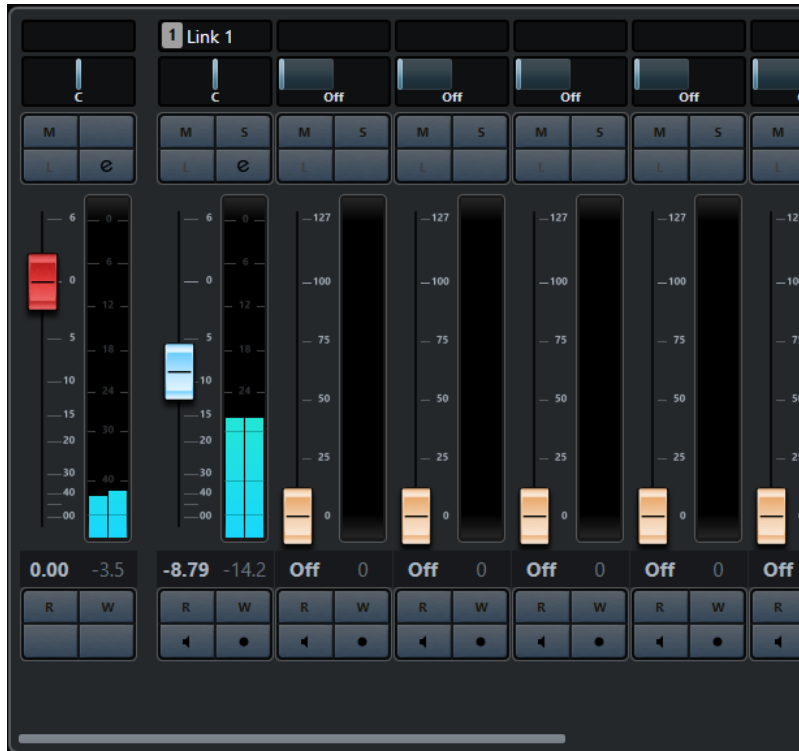

NOTE

If a channel is deactivated on the **Visibility** tab or if its channel type is deactivated, it is not shown in the fader section. The **MixConsole** in the lower zone of the **Project** window does not follow any visibility changes you perform in the **MixConsole** window and vice versa. It is linked to the track visibility of the **Project** window.

---

The fader section allows you to do the following:

- Set panorama
- Activate mute and solo
- Open channel settings
- Set volume
- Enable automation
- Set input levels

NOTE

All fader section functions and settings are also available in the **MixConsole** in the lower zone of the **Project** window.

---

RELATED LINKS

[Channel Settings](#) on page 349

[Write/Read Automation](#) on page 536

## Pan Control

For each audio-related channel with at least a stereo output configuration, you can find a pan control at the top of the fader section. For MIDI channels, the pan control sends out MIDI pan messages. The result depends on how your MIDI instrument is set to respond to pan.

The pan control allows you to position a channel in the stereo spectrum.

- To make fine adjustments, hold down **Shift** when you move the pan control.
- To select the default center pan position, hold down **Ctrl/Cmd**, and click the pan control.
- To edit the value numerically, double-click the pan control.

RELATED LINKS

[Creating New Projects](#) on page 80

## Stereo Balance Panner

The stereo balance panner allows you to control the balance between the left and right channels. It is activated by default.

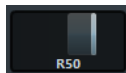

## Pan Bypass

You can bypass the panning for all audio-related channels.

- To activate panning bypass, click the button to the left or press **Ctrl/Cmd-Alt-Shift** and click the pan control.
- To deactivate panning bypass, press **Ctrl/Cmd-Alt-Shift** and click again.

When panning is bypassed for a channel, the following happens:

- Mono channels are panned center.
- Stereo channels are panned hard left and right.

## Using Solo and Mute

You can silence one or several channels using **Solo** and **Mute**.

- To silence a channel, click **Mute**.  
Click again to deactivate the mute state for the channel.
- To mute all other channels, click **Solo** for a channel.  
Click again to deactivate the solo state.
- To deactivate the mute or solo states for all channels simultaneously, click **Deactivate All Mute States** or **Deactivate All Solo States** on the toolbar.
- To activate exclusive solo mode, hold down **Ctrl/Cmd** and click **Solo** for the channel.  
The **Solo** buttons of all other channels are deactivated.
- To activate solo defeat for a channel, **Alt-click Solo**.



You can also click and hold **Solo** to activate solo defeat. In this mode, the channel is not muted when you solo another channel. **Alt-click** again to deactivate solo defeat.

## Volume

Each channel in the fader section of the **MixConsole** has a volume fader. The fader levels are displayed below the fader, in dB for audio-related channels and as MIDI volume (0 to 127) for MIDI channels.

- To change the volume, move the fader up or down.
- To make fine volume adjustments, press **Shift** while moving the faders.
- To reset the volume to its default value, press **Ctrl/Cmd** and click a fader.

For audio channels, the volume fader controls the volume of the channel before it is routed to an output bus, directly or via a group channel. For output channels, the volume fader controls the master output level of all audio channels that are routed to an output bus. For MIDI channels, the volume fader controls the volume changes in the **MixConsole** by sending out MIDI volume messages to the connected instruments that are set to respond to MIDI messages.

## Global Meter Settings Menu

You can change the meter characteristics for audio channels using the context menu of the channel meter.

Right-click the channel meter and select one of the following options from the **Global Meter Settings** menu:

### Meter Peak Options - Hold Peaks

The highest registered levels are held and shown as static horizontal lines in the meter.

### Meter Peak Options - Hold Forever

If this option is activated, the peak levels are shown until you reset the meters. If this option is deactivated, you can use the **Meters' Peak Hold Time** parameter in the **Preferences** dialog (**Metering** page) to specify for how long the peak levels are held. The peak hold time can be between 500 and 30000 ms.

### Meter Position - Input

If this option is activated, the meters show input levels for all audio channels and input/output channels. The input meters are post input gain.

### Meter Position - Post-Fader

If this option is activated, the meters show post-fader levels.

### Meter Position - Post-Panner

If this option is activated, the meters show post-fader levels and also reflect pan settings.

### Reset Meters

Resets the meters.

## Setting up Meter Colors

Setting up meter colors can help you to keep an overview of what levels are being reached.

---

### PROCEDURE

1. In the **Preferences** dialog, select **Metering > Appearance**.



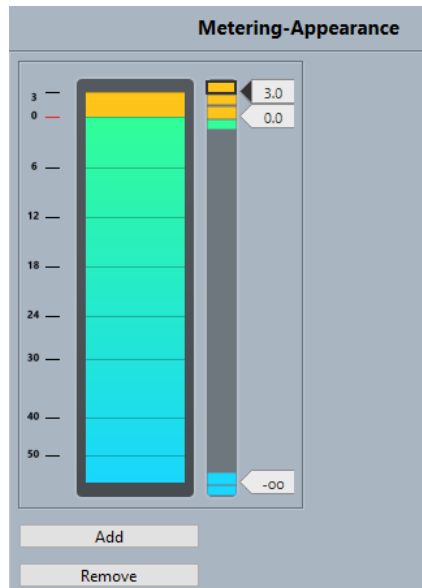

2. Do one of the following to set the level position for a color change:
  - Double-click a level position to the right of the meter scale and enter the level (dB) value. To enter dB values smaller than zero, add a minus sign before the entered number.
  - Click a level position and drag it to a specific level, and press **Shift** for more accurate positioning.
  - Click a level position and nudge it up or down with the **Up Arrow/Down Arrow** keys, and press **Shift** for faster positioning.

3. Click the upper or lower part of a color handle so that a frame is shown, and in the color picker, select a color.  
Selecting the same color for the upper and lower part of the handle results in a meter that changes its colors gradually. Different colors indicate level changes even more precisely.

#### NOTE

- To add more color handles, click **Add**, or **Alt**-click at a level position to the right of the meter scale. Each new handle is automatically associated with a default color.
- To remove a handle, select the handle and click **Remove**, or **Ctrl/Cmd**-click the handle.

4. Click **OK**.
- 

#### RELATED LINKS

[Metering - Appearance](#) on page 902

## Level Meters

The channel meters show the level when you play back audio or MIDI. The **Meter Peak Level** indicator shows the highest registered level.

- To reset the peak level, **Alt**-click the **Meter Peak Level** value.

#### NOTE

Input and output channels have clipping indicators. When they light up, lower the gain or the levels until the indicator is no longer lit.

---

## Input Levels

When recording digital sound, it is important to set the input levels high enough to ensure low noise and high audio quality. At the same time, you must avoid clipping (digital distortion).

### Setting Input Levels

In the **MixConsole**, you can set the input level. Make sure that the signal is loud enough but does not exceed 0 dB.

---

#### PROCEDURE

1. Select **Functions Menu > Global Meter Settings > Meter Position** and activate **Input**.  
In this mode, the input channel level meters show the level of the signal at the input of the bus, before any adjustments, such as input gain, EQ, effects, level, or pan are made. This allows you to check the level of the unprocessed signal coming into the audio hardware.
2. Play back the audio and check the level meter for the input channel.  
The signal should be as loud as possible without exceeding 0 dB, that is, the clipping indicator for the input bus should not light up.
3. If necessary, adjust the input level in one of the following ways:
  - Adjust the output level of the sound source or the external mixer.
  - If possible, use the audio hardware's own application program to set the input levels. Refer to the documentation for the audio hardware.
  - If your audio hardware supports the ASIO control panel function, it may be possible to make input level settings. To open the ASIO control panel, select **Studio > Studio Setup** and in the **Devices** list, select your audio card. When this is selected, you can open the control panel by clicking **Control Panel** in the settings section to the right.
4. Optional: Select **Functions Menu > Global Meter Settings > Meter Position** and activate **Post-Fader**.

#### NOTE

This allows you to check the level of the audio being written to a file on your hard disk, which is only necessary if you make any adjustments to the input channel.

---

5. Optional: In the **Channel Racks** section, in the **Inserts** rack, click a slot and select an effect, or in the **Equalizers** rack, make your EQ settings.  
For some effects you may want to adjust the level of the signal going into the effect. Use the input gain function for this. Press **Shift** or **Alt** to adjust the input gain.
  6. Play back the audio and check the level meter of the input channel.  
The signal should be reasonably loud without exceeding 0 dB, that is, the clipping indicator for the input bus should not light up.
  7. If necessary, use the input channel fader to adjust the signal level.
- 

## Clipping

Clipping typically occurs in the audio hardware when an analog signal is too loud and therefore converted to digital in the hardware's A/D converters.

Clipping can also occur when the signal from the input bus is written to a file on your hard disk. The reason for this is that you can make settings for the input bus, adding EQ, effects, etc. to the signal while it is being recorded. This may raise the level of the signal, which causes clipping in the recorded audio file.

## Channel Racks

The **Channel Racks** section contains specific **MixConsole** functions, such as routing, insert, or send handling. These are organized in racks.

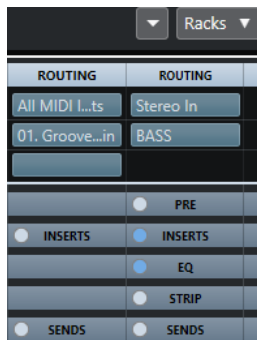

### NOTE

The **MixConsole** in the lower zone of the **Project** window features the **Inserts** and the **Sends** rack only.

---

### RELATED LINKS

- [Routing](#) on page 332
- [Pre \(Filters/Gain/Phase\)](#) on page 333
- [Inserts](#) on page 335
- [Equalizers \(EQ\)](#) on page 336
- [Channel Strips](#) on page 339
- [Sends](#) on page 346
- [Track Quick Controls](#) on page 347

## Copying and Moving Rack and Channel Settings

You can use drag and drop to copy or move rack and channel settings.

### NOTE

This function is only available in the **MixConsole** window.

---

Drag and drop works between different channels or different rack slots on the same channel. When you drag, a visual feedback indicates the sections where you can drop your settings.

The following applies:

- To move the rack settings from one rack to another, drag the rack and drop it on the rack to which you want to move the settings.
- To copy the rack settings from one rack to another, press **Alt**, drag the rack, and drop it on the rack to which you want to copy the settings.
- To copy the channel settings from one channel to another, drag the channel and drop it on the channel to which you want to copy the settings.
- To copy the channel settings from one channel to another, including the output routing settings, press **Alt**, drag the channel, and drop it on the channel to which you want to copy the settings.

You can copy rack and channel settings between different types of channels, provided that the target channels have corresponding settings.

- For example, copying from input/output channels leaves the sends settings in the target channel unaffected.

## Routing

The **Routing** rack allows you to configure input and output routing, that is, setting up input and output busses.

### NOTE

This channel rack is only available in the **MixConsole** window.

---

Input busses are used when you record on an audio track. In this case, you must select from which input bus the audio is received.

### NOTE

The settings that you make for the input channel will be a permanent part of the recorded audio file.

---

Output busses are used when you play back an audio, group, or FX channel. In this case, you must route the channel to an output bus.

You can route the outputs from multiple audio channels to a group. For example, to control the channel levels using one fader, and to apply the same effects and equalization to all the channels.

## Setting up Routing

You can set up the input and output busses in **Routing** rack of the **MixConsole**.

### PREREQUISITE

Set up busses and group channels in the **Audio Connections** window.

---

### PROCEDURE

1. On the **MixConsole** toolbar, click **Racks** and activate **Routing** to show the **Routing** rack above the fader section.
  2. Click one of the slots of the **Routing** rack to open the input or the output routing pop-up menu for a channel.
  3. In the routing selector, select an entry.
    - To set up the routing for multiple selected channels simultaneously, press **Shift-Alt** and select a bus.
    - To set several selected channels to incrementing busses (the second selected channel to the second bus, the third to the third bus, etc.), press **Shift** and select a bus.
    - To disconnect input or output bus assignments, select **No Bus**.
- 

## Input Busses

The input routing selector only lists busses that correspond to the channel configuration.

### NOTE

If you select a group channel as input for an audio channel, you can record a downmix.

---

### Input Routing Configurations for Mono Channels

For mono channels, the following input routing configurations are available.

- Mono input busses or individual channels within a stereo input bus.

- Mono output busses, mono group output busses, or mono FX channel output busses. These should not lead to feedback.

RELATED LINKS

[Routing](#) on page 332

### Input Routing Configurations for Stereo Channels

For stereo channels, the following input routing configurations are available.

- Mono or stereo input busses.
- Mono or stereo output busses, mono or stereo group output busses, and mono or stereo FX channel output busses. These should not lead to feedback.

RELATED LINKS

[Routing](#) on page 332

### Output Busses

For output busses any assignment is possible.

### Using Group Channels

You can route the outputs from multiple audio channels to a group. This enables you to control the channel levels using one fader, apply the same effects and EQ to all channels, etc. You can also select a group channel as input for an audio track, to record a downmix of separate tracks, for example.

PREREQUISITE

You have created and set up a group channel track in stereo.

---

PROCEDURE

1. Route the group channel track to an output bus.
2. Add effects to the group channel as insert effects.
3. Route the mono audio track to the group channel.

---

RESULT

The signal from the mono audio track is sent directly to the group, where it passes through the insert effect in stereo.

### Pre (Filters/Gain/Phase)

The **Pre** rack for audio-related channels features a high-cut and a low-cut filter as well as gain and phase settings.

**NOTE**

This channel rack is only available in the **MixConsole** window.

For MIDI channels, the **Pre** rack allows you to open the **Input Transformer**.

**NOTE**

You cannot edit the **Pre** rack settings in the EQ curve display.

---

RELATED LINKS

[Input Transformer Window](#) on page 592

[Equalizer Settings](#) on page 337

## Making Filter Settings

Each audio-related channel has separate high-cut and low-cut filters that allow you to attenuate signals with frequencies that are higher or lower than the cutoff frequency.

---

PROCEDURE

1. On the **MixConsole** toolbar, click **Racks** and activate **Pre (Filters/Gain/Phase)** to show the **Pre** rack above the fader section.
  2. Click to the left of the high-cut filter to activate the high-cut filter. You have the following options:
    - Drag the slider to adjust the cutoff frequency.  
The available range spans from 20 kHz to 50 Hz.
    - Click **Select Filter Slope** on the right of the high-cut filter to select a filter slope.  
You can choose between 6, 12, 24, 36, and 48 dB. The default value is 12 dB.
  3. Click to the left of the low-cut filter to activate the low-cut filter. You have the following options:
    - Drag the slider to adjust the cutoff frequency.  
The available range spans from 20 Hz to 20 kHz.
    - Click **Select Filter Slope** on the right of the low-cut filter to select a filter slope.  
You can choose between 6, 12, 24, 36, and 48 dB. The default value is 12 dB.
- 

RESULT

The changed settings are visible in the curve display. If you deactivate the high-cut and low-cut filters, the filter curves are removed from the display. Bypassed high-cut and low-cut filters are displayed in a different color.

## Making Input Gain Settings

The **Pre-Gain** slider allows you to change the level of a signal before it reaches the EQ and the effects section. This is useful as the level going into certain effects can change the way the signal is affected. A compressor, for example, can be driven harder by raising the input gain. Gain can also be used to boost the level of poorly recorded signals.

---

PROCEDURE

1. On the **MixConsole** toolbar, click **Racks** and activate **Pre (Filters/Gain/Phase)** to show the **Pre** rack above the fader section.
  2. Drag the **Gain** slider to the left or to the right to cut or boost the gain.
- 

## Making Phase Settings

Each audio-related channel and input/output channel has a **Phase** button that allows you to correct the phase for balanced lines and microphones that are wired backwards or that are out of phase due to their positioning.

---

PROCEDURE

1. On the **MixConsole** toolbar, click **Racks** and activate **Pre (Filters/Gain/Phase)** to show the **Pre** rack above the fader section.
  2. Activate **Phase** to invert the phase polarity for the signal.
-

## Inserts

The **Inserts** rack for audio-related channels features insert effect slots that allow you to load insert effects for a channel. For MIDI channels you can load MIDI inserts.

For further information, see the separate document **Plug-in Reference**.

### RELATED LINKS

[Audio Effects](#) on page 361

## Adding Insert Effects

You can add insert effects to **MixConsole** channels.

---

### PROCEDURE

1. On the **MixConsole** toolbar, click **Racks** and activate **Inserts** to show the **Inserts** rack above the fader section.
2. Click one of the insert slots to open the insert selector.
3. Click an insert effect to select it.

---

### RESULT

The selected insert effect is loaded and automatically activated. Its plug-in panel opens.

## Changing the Number of Pre-Fader/Post-Fader Slots

For each audio-related channel, you can add pre-fader and post-fader inserts, and you can adjust their number.

---

### PROCEDURE

- Do one of the following:
  - Right-click an insert effect in a pre-fader position, and from the context menu, select **Set as last Pre-Fader Slot**.
  - Click and drag the separator for pre-/post-fader slots up or down.

---

### RESULT

The number of pre-fader and post-fader slots is adjusted. The color and the separator line show which effect is pre-fader and which is post-fader.

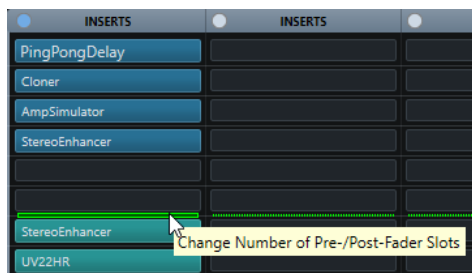

## Bypassing Insert Effects

You can bypass all insert effects.

- To bypass all inserts, click **Bypass** at the top of the **Inserts** rack.
- To bypass a single insert, click the button on the left of the inserts slot.
- To deactivate bypass, click the button again.

## Activating Side-Chain for Inserts

Some of the inserts feature side-chain functionality.

---

### PROCEDURE

1. Right-click an insert effect.
  2. From the context menu, select **Activate Side-Chain**.
- 

## Saving/Loading FX Chain Presets

You can save and load all insert rack settings using FX chain presets. FX chain presets have the file name extension `.fxchainpreset`.

---

### PROCEDURE

- In the top right corner of the **Inserts** rack, open the **Presets** pop-up menu and perform one of the following actions:
  - To save the current settings as a preset, select **Save FX Chain Preset** and name your preset.
  - To load a preset, select **Load FX Chain Preset** and select a preset.

### NOTE

You can also apply inserts together with EQ and channel strip settings from track presets. You can load, tag, and save FX chain presets in the **MediaBay**.

---

## Equalizers (EQ)

The **Equalizers (EQ)** rack is only available for audio-related channels. It features a built-in parametric equalizer with up to 4 bands for each audio channel.

### NOTE

This channel rack is only available in the **MixConsole** window.

---

## Activating Equalizer Bands

On the **EQ** rack, you can activate up to 4 EQ bands for each audio channel.

---

### PROCEDURE

1. On the **MixConsole** toolbar, click **Racks** and activate **Equalizers** to show the **EQ** rack above the fader section.
2. Click **Activate/Deactivate Band** to activate an EQ band.



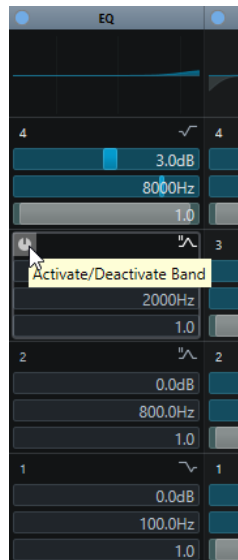

## Equalizer Settings

You can make equalizer settings for the 4 bands. These have different default frequency values and different Q names. However, they all have the same frequency range (20 Hz to 20 kHz). You can specify different filter types for each individual module.

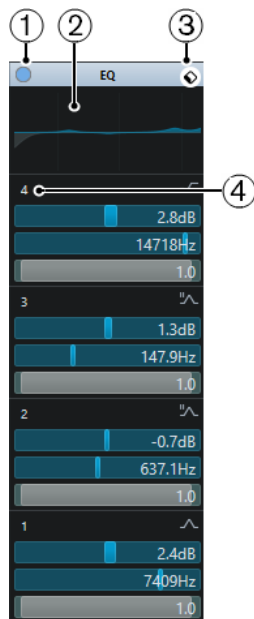

**1 Bypass EQ**

Click to bypass all EQ bands.

**2 Curve display**

Click on the display in a channel to show a larger version. The display is also available in the **Equalizers** section of the **Project window Inspector** and in the **Channel Settings** window.

Clicking the curve display enlarges the view and shows a cross-hair cursor. The current mouse position shows the frequency, note value, offset, and level at the top or bottom of the display.

- Click to add a curve point and activate the corresponding EQ band.
- Double-click the curve point to deactivate it.

- Drag the curve point up or down to adjust the gain.
- Press **Ctrl/Cmd** to edit only the gain.
- Drag left or right to adjust the frequency.
- Press **Alt** to edit only the frequency.
- Press **Shift** while dragging to set the Q-factor.
- To invert the EQ curve, open the context menu and select **Invert EQ Settings**.

The final curve shows the EQ settings as well as active high-cut and low-cut filters of the **Pre** rack settings. Bypassed filter settings are shown in a different color than the active settings. Disabled filter settings are hidden from the display.

#### NOTE

You cannot edit the high-cut and low-cut filters in the curve display. To edit the filters, open the **Pre** rack.

### 3 Select Preset

Opens a pop-up menu where you can load/save a preset.

### 4 Activate/Deactivate Band

Click to activate/deactivate an EQ band.

## Band Settings

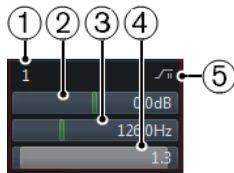

### 1 Activate/Deactivate Band

Activates/Deactivates the equalizer band.

### 2 Gain

Sets the amount of cut or boost. The range is  $\pm 24$  dB.

### 3 Frequency

Sets the center frequency of the frequency range to be cut or boosted. You can set the frequency either in Hz or as a note value. If you enter a note value, the frequency is automatically displayed in Hz. For example, a note value of A3 sets the frequency to 440 Hz. When you enter a note value, you can also enter a cent offset. For example, enter A5 -23 or C4 +49.

#### NOTE

Ensure that you enter a space between the note and the cent offset. Only in this case, the cent offsets are taken into account.

### 4 Q-Factor

Determines the width of the affected frequency range. Higher values give narrower frequency ranges.

### 5 Select EQ Band Type

Opens a pop-up menu where you can select an EQ type for the band. Bands 1 and 4 can act as parametric, shelving, or high/low-cut filters. EQ bands 2 and 3 are always parametric filters.

#### RELATED LINKS

[Making Filter Settings](#) on page 334

## Saving/Loading EQ Presets

You can save and load EQ presets.

---

### PROCEDURE

- In the top right corner of the **EQ** rack, open the presets pop-up menu and perform one of the following actions:
  - To save the current settings as a preset, select **Save Preset** and name your preset.
  - To load a preset, select **Load Preset** and select a preset.

### NOTE

You can also apply EQ together with insert and channel strip settings from track presets. You can load, tag, and save EQ presets in the **MediaBay**.

---

## Channel Strips

The **Channel Strip** rack is only available for audio-related channels. It allows you to load built-in processing modules for separate channels. You can change the position of specific modules in the signal flow via drag and drop.

### NOTE

The **Channel Strip** rack is only available in the **MixConsole** window.

---

### Noise Gate

Allows you to silence audio signals below a set threshold level. As soon as the signal level exceeds the set threshold, the gate opens to let the signal through.

### Compressor

Allows you to create smooth compression effects. Drag the compressor up or down to change its position in the signal flow.

### EQ

Allows you to make EQ settings.

### Tools

Provides various tools.

### Sat

Allows you to add warmth to the sound.

### Limit

Allows you to avoid clipping even at high levels.

## Noise Gate

Noise gating silences audio signals below a set threshold. As soon as the signal level exceeds the threshold, the gate opens to let the signal through.

### Threshold

Determines the level at which **Gate** is activated. Signal levels above the set threshold trigger the gate to open, and signal levels below the set threshold close the gate.

### Range

Adjusts the attenuation of the gate when it is shut. The higher the value, the higher the level of the signal that passes through the shut gate.

**Attack**

Sets the time after which the gate opens when it is triggered.

**Release**

Sets the time after which the gate closes.

**Listen Filter**

Allows you to monitor the filtered signal.

**Activate Filter**

Activates/Deactivates the internal side-chain and allows you to set up a filter to modify the signal detection.

**Auto Release**

Automatically finds the best release setting for the audio material.

**Filter Frequency**

If the internal side-chain is activated, this parameter sets the filter frequency for the signal detection.

**Q-Factor**

If the internal side-chain is activated, this parameter sets the resonance of the filter for the signal detection.

**State LED**

Indicates whether the gate is open (LED lights up in green), closed (LED lights up in red), or in an intermediate state (LED lights up in yellow).

## Compressor

This channel strip module reduces the dynamic range of the audio, making softer sounds louder or louder sounds softer, or both.

Open the pop-up menu to select between **Standard Compressor**, **Tube Compressor**, and **VintageCompressor**.

### Standard Compressor

The **Standard Compressor** allows you to create smooth compression effects. Drag the compressor up or down to change its position in the signal flow.

**Threshold**

Determines the level where the compressor kicks in. Only signal levels above the set threshold are processed.

**Ratio**

Sets the amount of gain reduction that is applied to signals above the set threshold. A ratio of 3:1 means that for every 3 dB the input level increases, the output level increases by 1 dB.

**Attack**

Determines how fast the compressor responds to signals above the set threshold. If the attack time is long, more of the early part of the signal passes through unprocessed.

**Release**

Sets the time after which the gain returns to the original level when the signal drops below the threshold.

**Auto Make-Up**

Automatically adjusts the output for gain loss.

### **Auto Release**

Automatically finds the best **Release** setting for the audio material.

### **Make-Up Gain**

Compensates for output gain loss that is caused by compression.

### **Gain Reduction LED**

Indicates the amount of compression of the signal.

#### RELATED LINKS

[Standard Compressor – Details View](#) on page 355

## **Tube Compressor**

The **Tube Compressor** with integrated tube-simulation allows you to achieve smooth and warm compression effects. The VU meter shows the amount of gain reduction. This compressor features an internal side-chain section that lets you filter the trigger signal.

### **Input Gain**

Determines the compression amount. The higher the input gain, the more compression is applied.

### **Output Gain**

Sets the output gain.

### **Gain Reduction LED**

Indicates the amount of compression of the signal.

### **Attack**

Determines how fast the compressor responds. If the attack time is long, more of the initial part of the signal passes through unprocessed.

### **Release**

Sets the time after which the gain returns to the original level.

### **Auto Release**

Automatically finds the best **Release** setting for the audio material.

### **Drive**

Controls the amount of tube saturation.

### **Mix**

Sets the level balance between the dry signal and the wet signal.

#### RELATED LINKS

[Tube Compressor – Details View](#) on page 355

## **VintageCompressor**

The **VintageCompressor** is modeled after vintage type compressors.

### **Input Gain**

In combination with the **Output Gain** setting, this parameter determines the compression amount. The higher the input gain setting and the lower the output gain setting, the more compression is applied.

### **Output Gain**

Sets the output gain.

### Attack

Determines how fast the compressor responds. If the attack time is long, more of the early part of the signal passes through unprocessed.

### Release

Sets the time after which the gain returns to its original level.

### Attack Mode (Punch)

If this option is activated, the early attack phase of the signal is preserved, retaining the original punch in the audio material, even with short **Attack** settings.

### Auto Release

Automatically finds the best **Release** setting for the audio material.

### Gain Reduction LED

Indicates the amount of compression of the signal.

#### RELATED LINKS

[VintageCompressor - Details View](#) on page 356

## EQ

You can make equalizer settings for the 4 bands. These have different default frequency values and different Q names. However, they all have the same frequency range (20 Hz to 20 kHz). You can specify different filter types for each individual module.

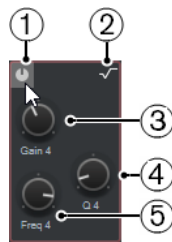

#### 1 **Activate/Deactivate Band**

Activates/Deactivates the equalizer band.

#### 2 **Select EQ Band Type**

Opens a pop-up menu where you can select an EQ type for the band. Bands 1 and 4 can act as parametric, shelf, or high/low-cut filters. EQ bands 2 and 3 are always parametric filters.

#### 3 **Gain**

Sets the amount of cut or boost. The range is  $\pm 24$  dB.

#### 4 **Q-Factor**

Determines the width of the affected frequency range. Higher values give narrower frequency ranges.

#### 5 **Frequency**

Sets the center frequency of the frequency range to be cut or boosted.

## Tools

### DeEsser

This channel strip module reduces excessive sibilance, primarily for vocal and speech recordings. Basically, it is a special type of compressor that is tuned to be sensitive to the frequencies produced by the s-sound. Close proximity microphone placement and equalizing can lead to situations where the overall sound is just right, but there is a problem with sibilants.

### **Threshold**

Sets a threshold for the incoming signal level above which the plug-in starts to reduce the sibilants.

### **Reduction**

Controls the intensity of the de-essing effect.

### **Auto Threshold**

Automatically and continually chooses an optimum threshold setting independent of the input signal. The **Auto Threshold** option does not work for low-level signals (<-30 dB peak level). To reduce the sibilants in such a signal, set the threshold manually.

### **Release**

Sets the time after which the de-essing effect returns to zero when the signal drops below the threshold.

### **Solo**

Allows you to solo the frequency band to find the appropriate position and width of that band.

### **Diff**

Allows you to listen to the sounds that the de-esser removes from the signal.

### **Low-Frequency**

Allows you to set the low frequency band.

### **High-Frequency**

Allows you to set the high frequency band.

### **Gain Reduction LED**

Indicates the amount of compression of the signal.

## **EnvelopeShaper**

This channel strip module can be used to attenuate or boost the gain of the attack and release phase of audio material. You can use the knobs to change parameter values. Be careful with levels when boosting the gain and if needed reduce the output level to avoid clipping.

### **Attack**

Changes the gain of the attack phase of the signal.

### **Release**

Changes the gain of the release phase of the signal.

### **Attack Length**

Determines the length of the attack phase.

### **Output Gain**

Sets the output level.

## **Sat**

Allows you to add warmth to the sound. Open the pop-up menu to select between **Magneto II**, **Tape Saturation**, and **Tube Saturation**.

## Magneto II

This channel strip module simulates the saturation and compression of recording on analog tape machines.

### Saturation

Determines the amount of saturation and the generation of overtones. This leads to a small increase in input gain.

### Low-Frequency

Sets the frequency range of the spectrum band to which the tape effect is applied. To avoid the saturation of lower frequencies, set the value to 200 Hz or 300 Hz.

### HF-Adjust

Sets the amount of high frequency content of the saturated signal.

### High-Frequency

Sets the frequency range of the spectrum band to which the tape effect is applied. To avoid the saturation of very high frequencies, set this parameter to values below 10 kHz.

### HF-Adjust On/Off

Activates/Deactivates the **HF-Adjust** filter.

### Solo

Allows you to hear only the set frequency range including the tape simulation effect. This helps you to determine the appropriate frequency range.

### Output

Allows you to adjust the output level.

### Saturation Amount LED

Indicates the amount of saturation of the signal.

## Tape Saturation

This channel strip module simulates the saturation and compression of recording on analog tape machines.

### Drive

Controls the amount of tape saturation.

### Low-Frequency

This is a low shelving filter with fixed frequency.

### High-Frequency

This is a high-cut filter. Use the frequency fader to reduce harshness of the output signal.

### Dual

Simulates the use of two tape machines.

### Auto Gain

Adjusts the gain automatically.

### Output

Sets the output gain.

### Drive Amount LED

Indicates the amount of drive of the signal.



## Tube Saturation

This channel strip module simulates the saturation and compression of recording of analogue tube compressors.

### Drive

Controls the amount of tube saturation.

### Low-Frequency

This is a low shelving filter with fixed frequency.

### High-Frequency

This is a high-cut filter. Use the frequency fader to reduce harshness.

### Output Gain

Sets the output gain.

### Drive Amount LED

Indicates the amount of drive of the signal.

## Limit

Allows you to avoid clipping even at high levels. Open the pop-up menu to select between **Brickwall Limiter**, **Maximizer**, and **Standard Limiter**.

### Brickwall Limiter

**Brickwall Limiter** ensures that the output level never exceeds a set limit. Due to its fast attack time, **Brickwall Limiter** can reduce even short audio level peaks without creating audible artifacts. However, this channel strip module creates a latency of 1 ms.

#### Threshold

Determines the level where the limiter kicks in. Only signal levels above the set threshold are processed.

#### Release

Sets the time after which the gain returns to the original level when the signal drops below the threshold.

#### Auto Release

Automatically finds the best **Release** setting for the audio material.

#### Gain Reduction LED

Displays the amount of gain reduction.

### Maximizer

This channel strip module raises the loudness of audio material without the risk of clipping.

#### Optimize

Determines the loudness of the signal.

#### Mix Amount

Sets the level balance between the dry signal and the wet signal.

#### Output

Determines the maximum output level. Set this to 0 dB to avoid clipping.

#### Gain Reduction LED

Displays the amount of gain reduction.

## Standard Limiter

This channel strip module is designed to ensure that the output level does not exceed a set output level, to avoid clipping in following devices. **Standard Limiter** can adjust and optimize the **Release** parameter automatically according to the audio material, or it can be set manually.

### Input

Adjusts the input gain.

### Release

Sets the amount of time it takes for the gain to return to its original level. If **Auto Release** is activated, **Standard Limiter** automatically finds the best release setting for the audio material.

### Output

Determines the maximum output level.

### Gain Reduction LED

Displays the amount of gain reduction.

## Saving/Loading Strip Presets

You can save and load strip presets. Strip presets have the file name extension `.stripreset`.

---

### PROCEDURE

- In the top right corner of the **Channel Strip** rack, open the **Presets** pop-up menu and perform one of the following actions:
  - To save the current settings as a preset, select **Save Strip Preset** and name your preset.
  - To load a preset, select **Load Strip Preset** and select a preset.

### NOTE

You can also apply channel strip settings together with insert and EQ settings from track presets. You can load, tag, and save strip presets in the **MediaBay**.

---

### RELATED LINKS

[Loading Strip Presets on page 531](#)

## Sends

The **Sends** rack for audio-related channels features send effect slots that allow you to load send effects and value sliders that for determining the send level for a channel. For MIDI channels, the **Sends** rack features send effect slots that allow you to load send effects.

## Adding Send Effects

On the **Sends** rack, you can add send effects.

---

### PROCEDURE

1. On the **MixConsole** toolbar, click **Racks** and activate **Sends** to show the rack above the fader section.
2. Click one of the send slots to open the send selector.
3. Click a send effect to select it.  
The selected send effect is loaded.

4. Click on the left of the slot to activate the send.
- 

## Bypassing Send Effects

You can bypass all send effects.

- To bypass all sends, click the bypass button at the top of the **Sends** rack.
- To deactivate bypass, click the button again.

## Adding FX Channels to a Send

You can add an FX channel track that is routed to a send from within the **MixConsole**.

---

### PROCEDURE

1. Right-click on the send slot to open the context menu.
  2. Select **Add FX Channel to <send name>**.
  3. In the **Add FX Channel Track** window, select the effect and configuration.
  4. Click **OK**.
- 

### RESULT

The FX channel track is added in the **Project** window, and the send is automatically routed to it.

## Track Quick Controls

**Track Quick Controls** give you instant access to up to 8 different parameters, for example, track, effect, or instrument controls.

This saves you from having to click your way through the various windows and sections pertaining to your track.

### NOTE

This channel rack is only available in the **MixConsole** window.

---

## Adding Track Quick Controls in the MixConsole

You can add **Track Quick Controls** in the **MixConsole**.

---

### PROCEDURE

1. On the **MixConsole** toolbar, click **Racks** and activate **Track Quick Controls** to show the rack above the fader section.
  2. Click one of the slots to open a selector.
  3. Select a parameter from the list.
- 

### RESULT

The selected parameter is loaded and automatically activated as **Track Quick Control**.

### RELATED LINKS

[Parameter Assignment](#) on page 570

## Adding Notes to a MixConsole Channel

You can add annotations to **MixConsole** channels.

---

### PROCEDURE

1. On the **MixConsole** toolbar, click **Set up Window Layout**, and activate **Notepads**.  
The **Notepads** section is shown above the fader section.
  2. Select the channel for which you want to add notes, click in the notepad section and enter your notes.
  3. To close the notepad, press **Esc**, or click in another section of the **MixConsole**.
- 

## Applying Channel Colors to Channel Controls

You can apply channel colors to the channel controls as well. This is useful if you have many channels in the **MixConsole** and you want to discern them by their color.

### PREREQUISITE

You have manually or automatically assigned track/channel colors.

---

### PROCEDURE

1. Select **Edit > Preferences**.
2. Open the **User Interface** page, and select **Track & MixConsole Channel Colors**.
3. In the **Colorize Tracks and MixConsole Channels** section, activate **MixConsole Channels**.
4. Optional: To adjust the brightness of a selected channel, adjust the **Selected Channel Brightness** slider.

### NOTE

By default, the selected channel is shown in gray. If you want to display the selected channel in color, activate **Show Color for Selected Channel**. You can then discern it from the other channels by its pronounced color strength

5. Click **OK**.
- 

### RESULT

The channel colors are applied to the channel controls.

### RELATED LINKS

[Automatically Assigning Colors to New Tracks/Channels](#) on page 144

[Colorizing Single Tracks](#) on page 73

[Colorizing Selected Tracks](#) on page 72

[User Interface](#) on page 905

[User Interface - Track & MixConsole Channel Colors](#) on page 906

## Channel Latency Overview

The **Channel Latencies** display the latencies caused by insert effects or channel strip modules for audio-related channels in the **MixConsole**.

- To show the channel latency display in the fader section of the **MixConsole**, click **Set up Window Layout** on the toolbar and activate **Channel Latencies**.
- To open an overview of the latencies for a specific channel, click **Open Channel Latency Overview**.

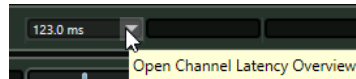

The **Channel Latency Overview** shows the following information:

Name	Type	Latency (ms)	Latency (Samples)
MultibandCompressor	Insert 1	123.0	5426
Brickwall Limiter	Strip 6	1.0	44
VST AmbiDecoder	Panner	23.2	1024
<i>Total Channel Latency</i>		<b>147.3</b>	<b>6494</b>

#### **Name**

The name of the effect that causes the latency.

#### **Type**

Indicates if the latency is caused by an insert effect, a channel strip module or a panner.

#### **Latency (ms)**

Shows the latency in milliseconds.

#### **Latency (Samples)**

Shows the latency in samples.

#### **Total Channel Latency**

Shows the total latency for that channel in milliseconds and in samples.

#### **NOTE**

If you want any plug-in delay to be compensated during playback, make sure that **Constrain Delay Compensation** is deactivated.

---

#### **RELATED LINKS**

[Plug-In Delay Compensation](#) on page 363

[Functions Menu](#) on page 324

[Constrain Delay Compensation](#) on page 558

[MixConsole Window](#) on page 310

## **Channel Settings**

You can open each **MixConsole** channel in a separate **Channel Settings** window. This allows for better overview and editing of individual channels and their settings.

The channel selection in the **Channel Settings** window is synchronized with the channel selection in the **MixConsole**, and the track selection in the **Project** window.

#### **NOTE**

To separate the channel selection in the **Channel Settings** window from the channel selection in the **MixConsole**, open the **Functions Menu** on the toolbar of the **Channel Settings** window, and deactivate **Follow 'e' buttons or selection changes**.

To separate the channel selection in the **Channel Settings** window from the track selection in the **Project** window, deactivate **Sync Selection in Project Window and MixConsole** in the **Preferences** dialog (**Editing—Project & MixConsole** page).

---

To open the channel settings for an audio-related channel, do one of the following:

- In the fader section of the **MixConsole**, select the channel, and click **Edit Channel Settings**.
- In the track list, select the track, and in the top section of the **Inspector**, click **Edit Channel Settings**.
- In the track list, select the track, and on the track click **Edit Channel Settings**.

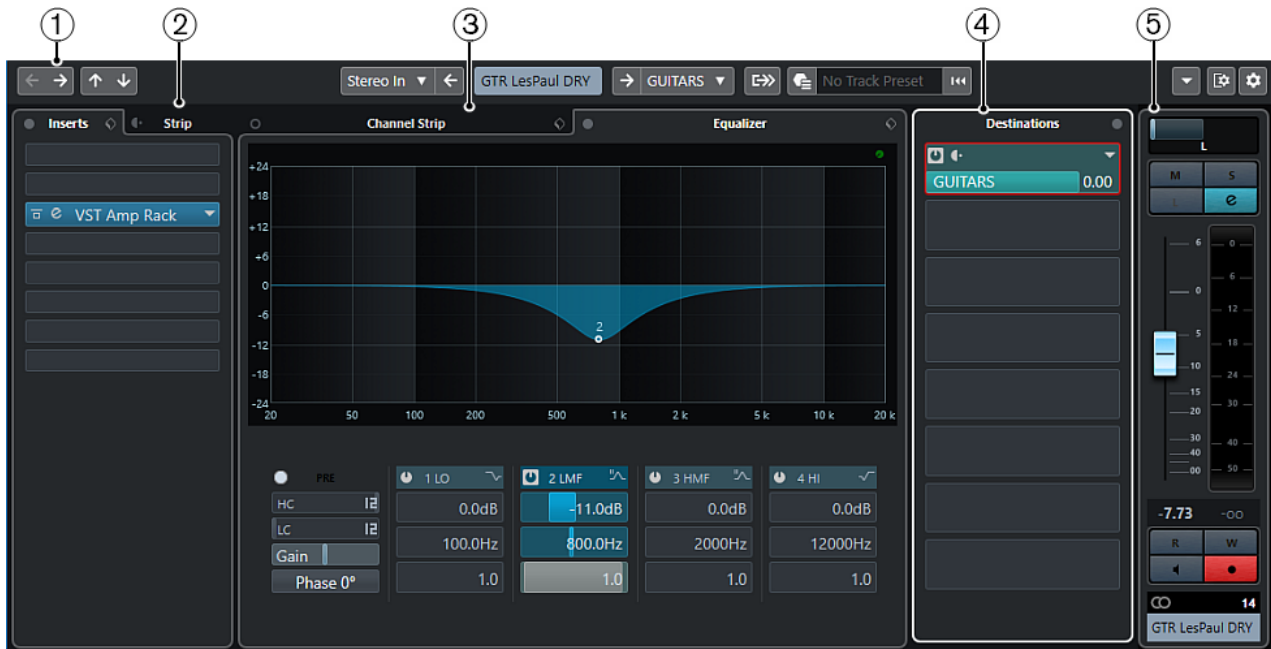

The **Channel Settings** window is divided into several sections:

**1 Toolbar**

The toolbar shows tools and shortcuts for settings and functions in the **Channel Settings** window.

**2 Inserts/Strip**

The **Inserts** section features insert effect slots that allow you to load insert effects for a channel. The **Strip** section allows you to load built-in processing modules for separate channels.

**3 Channel Strip/Equalizer**

The **Channel Strip** section allows you to load built-in processing modules for separate channels. The **Equalizer** section features a built-in parametric equalizer with up to 4 bands for each audio channel.

**4 Destinations**

The **Destinations** section features send effect slots that allow you to load send effects.

**5 Fader**

The fader section shows the current channel.

The sections are arranged in zones at the left and right of the **Channel Settings** window.

RELATED LINKS

[Channel Settings – Channel Inserts](#) on page 353

[Channel Settings – Channel Strip](#) on page 354

[Channel Settings – Equalizer](#) on page 357

[Channel Settings – Destinations](#) on page 359

[Channel Settings – Channel Faders](#) on page 359

[Equalizer Settings](#) on page 337

## Channel Settings Toolbar

The toolbar in the **Channel Settings** window contains tools and shortcuts for settings and functions in the **Channel Settings** window.

### Channel Navigation

#### Go to Last Edited Channel



Shows the channel that you last edited in the **Channel Settings** window. This is only available if you have edited at least 2 channels.

#### Go to Next Edited Channel



Shows the next channel in the **Channel Settings** window. This is only available if you have edited at least 2 channels.

#### Go to Previous MixConsole Channel



Shows the previous **MixConsole** channel in the **Channel Settings** window.

#### Go to Next MixConsole Channel



Shows the next **MixConsole** channel in the **Channel Settings** window.

#### Search Channels



Allows you to search for specific channels and show them in the **Channel Settings** window.

### Left Divider

#### Left Divider



Tools that are placed to the left of the divider are always shown.

### Channel Sources

#### Input

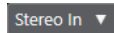

Opens the name of the input channel.

#### Go to Input/Select an Input



Shows the input channel in the **Channel Settings** window.

### Channel Name

#### Channel Name



Shows the name of the channel that is shown in the **Channel Settings** window.

## Channel Destinations

### Go to Output/Select an Output



Opens the output channel in the **Channel Settings** window.

### Output

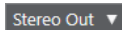

Shows the name of the output channel.

## Edit Instrument

### Edit VST Instrument



Allows you to open the VST instrument control panel. This is only available for MIDI and instrument channels.

## Output Chain

### Show Output Chain



Shows the output chain. This allows you to keep track of more complicated output routings.

## Track Templates

### Load/Save Track Preset



Allows you to load/save track presets.

### Reload Track Preset



Allows you to reload track presets.

## Channel Functions

### Functions Menu



Opens a pop-up menu where you can select a **Channel Settings** function.

## Window Zone Controls

### Set up Window Layout



Allows you to set up the window layout.

### Set up Toolbar



Opens a pop-up menu where you can set up which toolbar elements are visible.



## Channel Settings – Channel Inserts

The **Channel Inserts** section is shown in the **Channel Settings** window.

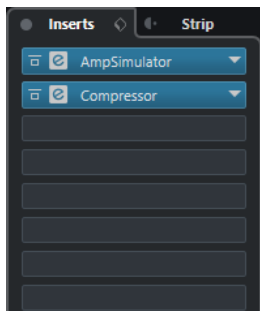

### **Bypass Inserts**

Bypasses the insert effects for the channel.

### **Inserts**

Allows you to add insert effects for the channel.

### **Preset Management**

Allows you to load or save FX Chain presets.

### **Move Channel Strip to Pre/Post-Inserts Position**

Allows you to move the channel strip to pre-fader position or to post-fader position in the signal flow.

### **Strip**

Allows you to activate and set up channel strip modules for the channel.

### **Routing**

Allows you to set up the routing for insert effects.

### RELATED LINKS

[Channel Settings](#) on page 349

## Channel Settings – Channel Strip

The **Channel Strip/Equalizer** section is shown in the **Channel Settings** window.



### Bypass Channel Strip

Bypasses the channel strip modules for the channel.

### Channel Strip

Allows you to activate and set up channel strip modules for the channel.

### Preset Management

Allows you to load or save strip presets.

## Channel Strip Modules

The following channel strip modules are shown:

- Noise Gate
- Compressor
- EQ
- Tools
- Sat
- Limit

You can change the position of channel strip modules in the signal chain by dragging.

### RELATED LINKS

[Noise Gate](#) on page 339

[Compressor](#) on page 340

[EQ](#) on page 342

[Tools](#) on page 342

[Sat](#) on page 343

[Limit](#) on page 345

[Channel Settings](#) on page 349

## Standard Compressor – Details View

The **Standard Compressor** features a details view with more controls and value readouts for the meters.

- To open the details view, click **Edit Module** .



In the details view, the following additional parameters are available:

- Soft Knee/High Ratio
- Hold
- Analysis
- Dry Mix
- Input Gain meter
- Output Gain meter
- Gain Reduction meter

You can close the details view by clicking **Close Module** .

### RELATED LINKS

[Standard Compressor](#) on page 340

## Tube Compressor – Details View

The **Tube Compressor** features a details view with more controls and value readouts for the meters.

- To open the details view, click **Edit Module** .



In the details view, the following additional parameters are available:

- Character
- Low/High switch for Ratio
- Side-chain section with Frequency, Filter Type, Q-Factor, and Monitor
- Input Gain meter
- Output Gain meter

You can close the details view by clicking **Close Module** .

#### RELATED LINKS

[Tube Compressor](#) on page 341

## VintageCompressor - Details View

The **VintageCompressor** features a details view with more controls and value readouts for the meters.

- To open the details view, click **Edit Module** .



In the details view, the following additional parameters are available:

- Mix
- Ratio buttons
- Input Gain meter
- Output Gain meter
- Gain Reduction meter

You can close the details view by clicking **Close Module** .

#### RELATED LINKS

[VintageCompressor](#) on page 341

## Channel Settings – Equalizer

The **Channel Strip/Equalizer** section is shown in the **Channel Settings** window.



### **Bypass Equalizers**

Bypasses the equalizer settings for the channel.

### **Preset Management**

Allows you to load or save equalizer presets.

### **Equalizer Settings**

Opens the **Equalizer Settings** panel.

### **Equalizer display**

Allows you to make equalizer settings for the 4 bands in a large EQ curve display with several modes.

### **Equalizer Controls**

Allows you to make equalizer settings for the 4 bands in a large EQ curve display with several modes.

#### RELATED LINKS

[Channel Settings](#) on page 349

## **Equalizer Settings Panel**

The **Equalizer Settings** panel allows you to set up the equalizer.

- To open the **Equalizer Settings** panel, click **Equalizer Settings** in the **Equalizer** section of the **Channel Settings** window.

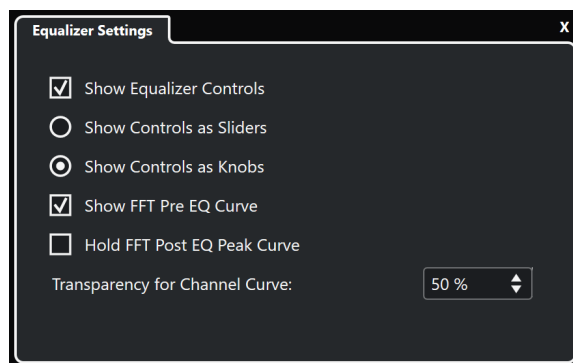

### **Show Equalizer Controls**

Shows/Hides the equalizer controls.

### **Show Controls as Sliders**

Shows the equalizer controls as sliders.

### **Show Controls as Knobs**

Shows the equalizer controls as knobs.

### **Show FFT Pre EQ Curve**

Shows/Hides the FFT (Fast Fourier Transform) input curve for the reference channel.

### **Hold FFT Post EQ Peak Curve**

Holds the peak values of the FFT (Fast Fourier Transform) output curve for the reference channel.

### **Transparency for Channel Curve**

Allows you to adjust the transparency of the filled area for the spectral curve.

## Channel Settings – Destinations

The **Channel Sends** section is shown in the **Channel Settings** window.

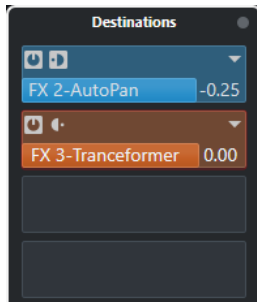

### Bypass Sends

Bypasses the send effects for the channel.

### Sends—Destinations

Allows you to set up a destination for the send effects for the channel.

### Sends—Panning

Allows you to set up panning for the send effects.

#### RELATED LINKS

[Channel Settings](#) on page 349

## Channel Settings – Channel Faders

The **Channel Faders** section is shown in the **Channel Settings** window.



The controls are the same as in the **MixConsole** fader section.

#### RELATED LINKS

[Fader Section](#) on page 326

[Channel Settings](#) on page 349

## Keyboard Focus in the MixConsole

The left zone, the channel rack section, and the fader section can be controlled with the computer keyboard.

For this to work, the section must have the focus. If a section has the keyboard focus, the border that surrounds it is highlighted in a specific color.

### Activating Keyboard Focus

To be able to control the **MixConsole** with the keyboard, you must activate the keyboard focus.

---

#### PROCEDURE

1. Click in an empty area of the section to activate the keyboard focus.
  2. Press **Tab** to activate the next section. This allows you to cycle forward through the sections.
  3. Press **Shift-Tab** to activate the previous section.
- 

### Navigating in a Section

Once you have activated the focus for a section, you can control it with the computer keyboard. In the channel racks section and in the fader section, controls that are selected for keyboard control are indicated by a red border.

- To navigate through the controls, use the **Up Arrow**, **Down Arrow**, **Left Arrow**, or **Right Arrow** keys.
- To activate or deactivate a switch, press **Return**.
- To expand or collapse an active rack, to open or close a value field in a slot, or to open the plug-in panel for a loaded plug-in, press **Return**.
- To access the controls in the left zone, press **Ctrl/Cmd-Return**.
- To access the controls in the middle zone, press **Return**.
- To access the controls in the right zone, press **Alt-Return**.
- To close a pop-up menu or a plug-in panel, press **Esc**.
- To enable or disable the loaded plug-in, press **Ctrl/Cmd-Alt-Return**.



# Audio Effects

Cubase comes with a number of included effect plug-ins that you can use to process audio, group, instrument, and ReWire channels.

The effects and their parameters are described in the separate document **Plug-in Reference**.

## Insert Effects and Send Effects

You can apply effects to audio channels by using insert effects or send effects.

### Insert Effects

Insert effects are inserted in the signal chain of an audio channel. This way, the whole channel signal passes through the effect.

You can add up to 16 different insert effects per channel.

Use insert effects for effects such as distortion, filters, or other effects that change the tonal or dynamic characteristics of the sound.

To add and edit insert effects, you can use the following inserts sections:

- The **Inserts** rack in the **MixConsole**.

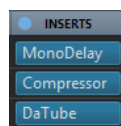

- The **Inserts** section in the **Channel Settings** window.

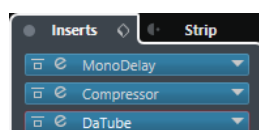

- The **Inserts** section in the **Inspector**.

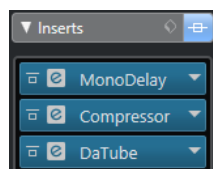

### Send Effects

Send effects can be added to FX channel tracks, and the audio data to be processed can be routed to the effect. This way, the send effects remain outside the audio channel's signal path.

Each audio channel has 8 sends, each of which can be freely routed to an effect (or to a chain of effects).

Use send effects in the following cases:

- To control the balance between the dry and wet sound individually for each channel.
- To use the same effect for several different audio channels.

To edit send effects, you can use the following sends sections:

- The **Sends** rack in the **MixConsole**.

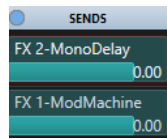

- 
- The **Sends** section in the **Inspector**.

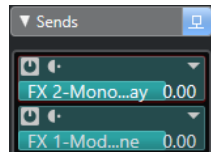

#### RELATED LINKS

[Direct Offline Processing](#) on page 386

## VST Standard

Audio effects can be integrated in Cubase thanks to the VST standard. At the moment, the VST 3 and VST 2 standards are supported.

The VST 3 plug-in standard offers improvements like smart plug-in processing and side-chain inputs. VST 3 retains full backwards compatibility to VST 2.

## Smart Plug-In Processing

Smart plug-in processing is a technology that allows to disengage the processing for plug-ins when no signal is present. This reduces the CPU load on silent passages and allows you to load more effects.

To activate smart plug-in processing, activate **Suspend VST 3 plug-in processing when no audio signals are received** in the **Preferences** dialog (**VST—Plug-ins** page).

#### NOTE

Check the processor for the passage with the largest number of events playing simultaneously to make sure that your system offers the required performance at every time position.

---

## Side-Chain Inputs

Several VST 3 effects feature side-chain inputs. These allow you to control the operation of the effect via external signals that are routed to the side-chain input.

The effect processing is still applied to the main audio signal.

#### RELATED LINKS

[Side-Chain Input](#) on page 373

## Plug-In Delay Compensation

Some audio effects, especially dynamics processors that feature a look-ahead functionality, may take a brief time to process the audio fed into them. As a result, the output audio is slightly delayed. To compensate for this, Cubase provides plug-in delay compensation.

Plug-in delay compensation is featured throughout the entire audio path maintaining the sync and timing of all audio channels.

VST 3 dynamics plug-ins with look-ahead functionality feature a **Live** button that allows you to disengage the look-ahead. This minimizes latency during real-time recording. For details, see the separate document **Plug-in Reference**.

To avoid latency during real-time recording or real-time playback of VST instruments, you can also use **Constrain Delay Compensation**.

### RELATED LINKS

[Constrain Delay Compensation](#) on page 558

[MixConsole Window](#) on page 310

## Tempo Sync

Plug-ins can receive timing and tempo information from Cubase. This is useful to synchronize plug-in parameters, such as modulation rates or delay times, to the project tempo.

Timing and tempo information is provided to plug-ins of the standard VST 2.0 or later.

To set up tempo sync, you must specify a base note value. Straight, triplet, or dotted note values (1/1 to 1/32) are supported.

For details about the included effects, see the separate document **Plug-in Reference**.

## Insert Effects

Insert effects can be inserted in the signal chain of an audio channel. This way, the whole channel signal passes through the effect.

You can add up to 16 different insert effects independently for each audio-related channel (audio track, group channel track, FX channel track, instrument channel, or ReWire channel) or output bus.

The signal passes through the insert effects corresponding to their slot position from top to bottom.

You can define post-fader insert slots for any channel. Post-fader insert slots are always post-EQ and post-fader.

### NOTE

To show all post-fader slots in the **MixConsole**, open the **Rack Settings** and activate **Fixed Number of Slots**.

Use post-fader slots for insert effects where you want the level to remain unchanged after the effect. Dithering and maximizers are typically used as post-fader insert effects for output busses, for example.

### NOTE

If you want to use an effect with identical settings on several channels, set up a group channel and apply your effect as a single insert for this group.

RELATED LINKS

- [Dither Effects](#) on page 376
- [Changing the Number of Pre-Fader/Post-Fader Slots](#) on page 335
- [Adding Insert Effects to Group Channels](#) on page 365
- [Rack Settings Menu](#) on page 323

## Adding Insert Effects

If you add insert effects to audio channels, the audio is routed through the insert effects.

---

PROCEDURE

1. Select the audio track.
2. In the track list, click **Edit Channel Settings**.  
The **Channel Settings** window for the audio channel opens.
3. In the **Inserts** section, click the first insert slot on the **Inserts** tab, and select an effect from the selector.

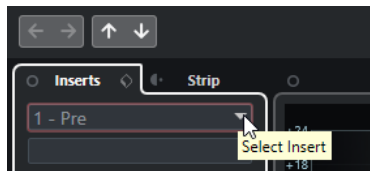

RESULT

The selected insert effect is loaded and activated, and the audio is routed through it. The effect control panel is opened.

RELATED LINKS

- [Effect Control Panel](#) on page 376

## Adding Insert Effects to Busses

If you add insert effects to input busses, the effects become a permanent part of the recorded audio file. If you add insert effects to output busses, all audio routed to that bus is affected. Insert effects that are added to output busses are sometimes referred to as master effects.

---

PROCEDURE

1. Select **Studio > MixConsole** to open the **MixConsole**.
  2. In the fader section, perform one of the following actions:
    - Locate the input channel and click **Edit Channel Settings** to edit the input bus.
    - Locate the output channel and click **Edit Channel Settings** to edit the output bus.The **Channel Settings** window for the selected channel opens.
  3. In the **Inserts** section, click the first insert slot on the **Inserts** tab, and select an effect from the selector.
- 

RESULT

The selected insert effect is added to the bus and activated. The effect control panel is opened.

## Adding Insert Effects to Group Channels

If you add insert effects to group channels, you can process several audio tracks through the same effect.

---

### PROCEDURE

1. In the global track controls area of the track list, click **Add Track** .
  2. Click **Group**.
  3. Open the **Audio Outputs** pop-up menu, and select the desired output bus.
  4. Click **Add Track**.  
The group track is added to the track list.
  5. In the **Inspector** for the group track, open the **Inserts** section.
  6. Click the first effect slot and select an effect from the selector.
  7. In the **Inspector** for the audio tracks, open the **Output Routing** pop-up menus and select the group.
- 

### RESULT

The signal from the audio track is routed through the group channel and passes through the insert effect.

### RELATED LINKS

[Add Track Dialog – Group Channel](#) on page 117

## Adding Group Channels to Selected Channels

You can add a group channel to several selected channels.

### PREREQUISITE

Your project contains some tracks that you want to route to a group channel.

---

### PROCEDURE

1. In the track list, right-click the tracks that you want to route to a group channel, and select **Add Track > Group Channel to Selected Channels**.
  2. In the **Add Track** dialog, open the **Configuration** pop-up menu, and select a channel configuration for the group channel track.
  3. Open the **Folder Setup** pop-up menu, and select if you want to create group channel tracks inside or outside a dedicated folder.
  4. Click **OK**.
- 

### RESULT

The group channel track is added to the track list. In the **Output Routing** pop-up menu of the selected tracks, the group is selected. The tracks are routed to the group channel.

### RELATED LINKS

[Add Track Dialog – Group Channel](#) on page 117

## Copying Insert Effects

You can add insert effects to audio channels by copying them from other audio channels or from other slots of the same audio channel.

### PREREQUISITE

You have added at least one insert effect to an audio channel.

---

### PROCEDURE

1. Select **Studio > MixConsole**.
2. In the **Inserts** rack, locate the insert effect that you want to copy.
3. Hold down **Alt**, and drag the insert effect on an insert slot.

---

### RESULT

The insert effect is copied. If the destination slot already contains an insert effect, it is replaced.

## Rearranging Insert Effects

You can change the position of an insert effect in the signal chain of the audio channel by moving it to a different slot of the same channel. You can also move an insert effect to another audio channel.

### PREREQUISITE

You have added at least one insert effect to an audio channel.

---

### PROCEDURE

1. Select **Studio > MixConsole**.
2. In the **Inserts** rack, locate the insert effect that you want to rearrange.
3. Drag the insert effect to another insert slot.

---

### RESULT

The insert effect is removed from the source slot and placed on the destination slot. If the destination slot already contains an insert effect, this effect is moved to the next insert slot.

## Deactivating Insert Effects

If you want to listen to a track without having it processed by an effect, but do not want to remove this effect completely from the insert slot, you can deactivate it.

### PREREQUISITE

You have added an insert effect to an audio channel.

---

### PROCEDURE

1. In the track list, select the audio track with the insert effect that you want to deactivate.
2. In the **Inspector**, open the **Inserts** section, and **Alt-click Bypass Insert**.

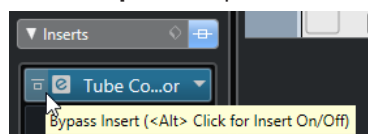

#### RESULT

The effect is deactivated and all processing is terminated, but the effect is still loaded.

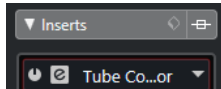

## Bypassing Insert Effects

If you want to listen to the track without having it processed by a particular effect, but do not want to remove this effect completely from the insert slot, you can bypass it. A bypassed effect is still processing in the background. This allows for crackle-free comparison of the original and the processed signal.

#### PREREQUISITE

You have added an insert effect to an audio channel.

---

#### PROCEDURE

1. In the track list, select the audio track with the insert effect that you want to bypass.
2. In the **Inspector**, open the **Inserts** section, and click **Bypass Insert**.

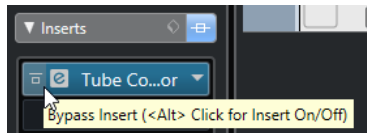

---

#### RESULT

The effect is bypassed, but still processing in the background.

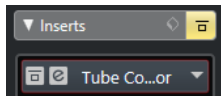

## Removing Insert Effects

---

#### PROCEDURE

1. In the track list, select the audio track with the insert effect that you want to remove.
2. In the **Inspector**, open the **Inserts** section and on the effect that you want to remove, click **Select Insert**.
3. In the effect selector, select **No Effect**.

---

#### RESULT

The insert effect is removed from the audio channel.

## Freezing Insert Effects

Freezing an audio track and its insert effects allows you to reduce processor power. However, frozen tracks are locked for editing. You cannot edit, remove, or add insert effects for the frozen track.

#### PREREQUISITE

You have made all settings for the track and you are sure that you do not need to edit it anymore.

---

## PROCEDURE

1. In the **Inspector** for the audio track that you want to freeze, click **Freeze Audio Channel**.



2. In the **Freeze Channel Options** dialog, specify a **Tail Size** in seconds.  
This adds time at the end of the rendered file. This way, reverb and delay tails can fully fade out.

---

## RESULT

The output of the track including all pre-fader insert effects is rendered to an audio file.

The frozen audio track is saved in the **Freeze** folder that can be found in the following location:

- Windows: within the **Project** folder
- macOS: User/Documents

In the **MixConsole**, the frozen audio channel is indicated by a snowflake symbol above the channel name. You can still adjust the level and panning, make EQ settings, and adjust the effect sends.

## AFTER COMPLETING THIS TASK

To unfreeze a frozen track, click **Freeze** again.

# VST Effect Selector

The VST effect selector allows you to select VST effects of the active collection.

- To open the VST effect selector, open the **Inserts** section of the audio track **Inspector**, and on an insert slot, click **Select Insert**.

The following controls are available:

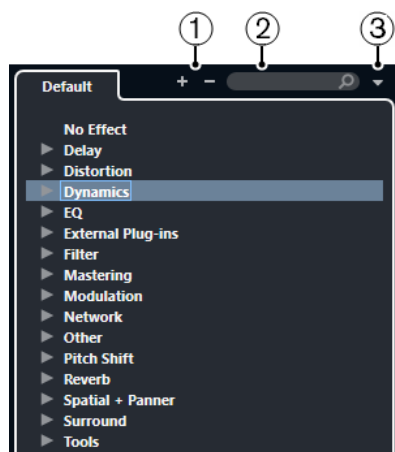

- 1 **Expand Tree/Collapse Tree**  
Expands/Collapses the tree.
- 2 **Search VST Effect**  
Allows you to search for VST effects by typing in the name or parts of the name, or the category.
- 3 **Plug-in Collections and Options**  
Allows you to select a collection.



If you select the **Default** collection, the options **Sort By Category** and **Sort by Vendor** become available. These allow you to sort the default collection.

## Send Effects

Send effects are outside the signal path of an audio channel. The audio data that is to be processed must be sent to the effect.

- You can select an FX channel track as routing destination for a send.
- You can route different sends to different FX channels.
- You can control the amount of signals sent to the FX channel by adjusting the effect send level.

### NOTE

In the **Preferences** dialog (**VST** page), you can set a default send level. Use **Ctrl/Cmd-click** to set the send level to this default value.

---

To do this, you must create FX channel tracks.

### RELATED LINKS

[FX Channel Tracks](#) on page 369

[VST](#) on page 907

## FX Channel Tracks

You can use FX channel tracks as routing destinations for audio sends. The audio is sent to the FX channel and through any insert effects set up for it.

- You can add several insert effects to an FX channel.  
The signal passes through the effects in series, from the top downward.
- You can rename FX channel tracks as any other tracks.
- You can add automation tracks to FX channel tracks.  
This allows for automating various effect parameters.
- You can route the effect return to any output bus.
- You can adjust the FX channel in the **MixConsole**.  
This includes adjusting the effect return level, the balance, and the EQ.

When you add an FX channel track, you can select if FX channel tracks are created inside or outside a dedicated folder. If you select **Create Inside Folder**, FX channel tracks are shown in a dedicated folder.

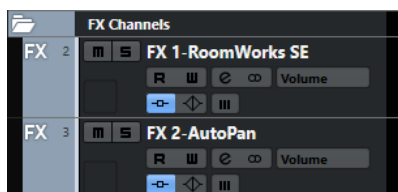

This allows for better overview and editing of the FX channel tracks.

### NOTE

By folding FX channel folders, you can save screen space.

---

RELATED LINKS

[Adding FX Channel Tracks](#) on page 370

## Adding FX Channel Tracks

---

PROCEDURE

1. In the global track controls area of the track list, click **Add Track** .
  2. Click **Effect**.
  3. Open the **Effect** pop-up menu, and select an effect for the FX channel track.
  4. Open the **Configuration** pop-up menu, and select a channel configuration for the FX channel track.
  5. Open the **Folder Setup** pop-up menu, and select if you want to create FX channel tracks inside or outside a dedicated folder.
  6. Click **Add Track**.
- 

RESULT

The FX channel track is added to the track list and the selected effect is loaded into the first available insert effect slot of the FX channel.

RELATED LINKS

[Add Track Dialog – Effect](#) on page 120

## Adding FX Channels to Selected Channels

---

PREREQUISITE

Your project contains some tracks to which you want to add an FX channel.

---

PROCEDURE

1. In the track list, right-click the tracks to which you want to add an FX channel, and select **Add Track > FX Channel to Selected Channels**.
  2. In the **Add Track** dialog, open the **Effect** pop-up menu and select an effect for the FX channel track.
  3. Open the **Configuration** pop-up menu, and select a channel configuration for the FX channel track.
  4. Open the **Folder Setup** pop-up menu, and select if you want to create FX channel tracks inside or outside a dedicated folder.
  5. Click **OK**.
- 

RESULT

The FX channel track is added to the track list. The selected effect is loaded into the first available insert effect slot of the FX channel, and to the first available send effect slot of all channels that you selected.

RELATED LINKS

[Add Track Dialog – Effect](#) on page 120

## Adding Insert Effects to FX Channel Tracks

You can add insert effects to FX channel tracks.

### PREREQUISITE

You have added an FX channel track and set up the correct output bus in the **Output Routing** pop-up menu.

---

### PROCEDURE

1. In the track list for the FX channel track, click **Edit Channel Settings**. The **Channel Settings** window for the FX channel track opens.
2. In the **Inserts** section, click an insert slot on the **Inserts** tab, and select an effect from the selector.

---

### RESULT

The selected effect is added as an insert effect to the FX channel track.

## Routing Audio Channels to FX Channels

If you route an audio channel send to an FX channel, the audio is routed through the insert effects that you have set up for the FX channel.

---

### PROCEDURE

1. Select the audio track.
2. In the track list, click **Edit Channel Settings** to open the **Channel Settings** window.
3. In the **Sends** section on the **Destinations** tab, click **Select Destination** for an effect slot, and select the FX channel track from the selector.

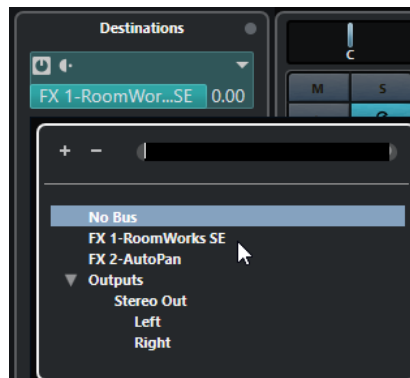

4. On the send slot, click **Activate/Deactivate Send**.

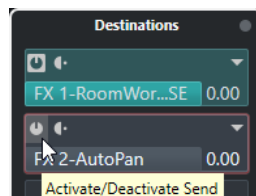

---

### RESULT

The audio is routed through the FX channel.

#### AFTER COMPLETING THIS TASK

In the **Channel Settings** window for the audio channel, you can hold down **Alt** and double-click to show the send destination. If you have routed the send to an FX channel, the effect control panel is opened.

#### RELATED LINKS

[Adding FX Channel Tracks](#) on page 370

## Pre/Post Fader Sends

You can send the signal from the audio channel to the FX channel before or after the audio channel volume fader.

- **Pre-fader sends**  
The audio channel signal is sent to the FX channel before the audio channel volume fader.
- **Post-fader sends**  
The audio channel signal is sent to the FX channel after the audio channel volume fader.
- To move a send to pre-fader position, open the **Channel Settings** window for the audio channel, right-click a send and select **Move to Pre-Fader**.

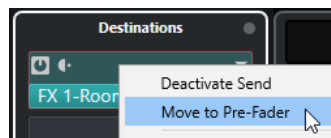

The **Pre-/Post-Fader** button indicates that the send is in pre-fader position.

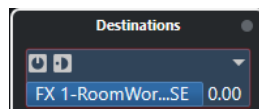

- To move a send to post-fader position, open the **Channel Settings** window for the audio channel, right-click a send and select **Move to Post-Fader**.

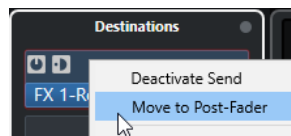

The **Pre-/Post-Fader** button indicates that the send is in post-fader position.

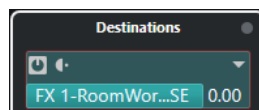

#### NOTE

If you activate **Mute Pre-Send when Mute** in the **Preferences** dialog (**VST** page), sends in pre-fader mode are muted if you mute their channels.

---

## Setting the Level for the Sends

#### PROCEDURE

1. In the track list, select the FX channel track that contains the effect for which you want to set the level.
2. Open the **Inserts** section of the **Inspector** and click the effect slot to open the effect control panel.
3. In the effect control panel, set the **Mix** control to 100.

This allows for full control of the effect level when you use the effect sends to control the signal balance later.

4. In the track list, select the audio track that is routed through the effect for which you want to set the level.
5. Click **Edit Channel Settings** to open the **Channel Settings** window for the audio track.
6. In the **Sends** section on the **Destinations** tab, locate the effect slot and drag to the left or right to set the send level. **Ctrl/Cmd**-click to set the level to the default send level specified in the **Preferences** dialog (**VST** page).

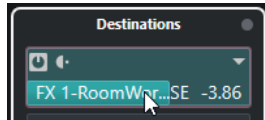

This determines how much of the signal from the audio channel is routed to the FX channel.

---

#### RESULT

The effect level is adjusted according to your settings.

#### NOTE

To determine how much of the signal from the FX channel is sent to the output bus, open the **Channel Settings** window for the FX channel track and adjust the effect return level.

---

## Side-Chain Input

Many VST 3 effects feature a side-chain input. Side-chaining allows you to use the output of one track to control the action of an effect on another track.

Effects from the following categories feature side-chain:

- Modulation
- Delay
- Filter

By activating the side-chain input you can do the following:

- Use the side-chain signal as a modulation source.
- Apply ducking to the instrument, that is, reduce the volume of the instrument track when a signal is present on the audio track.
- Compress the signals on one audio track when a second audio track starts.  
This is typically used to add compression on a bass sound when the drums are hit.

#### NOTE

For detailed descriptions of the plug-ins that feature side-chaining, see the separate document **Plug-in Reference**.

---

#### NOTE

- Certain combinations of tracks and side-chain inputs may lead to feedback loops and added latency. If this is the case, the side-chain options are not available.
  - Side-chain connections are only kept when you move an effect within a channel. When you drag and drop an effect between channels, or when you copy an effect into another effect slot, the side-chain connections are lost.
-

## Side-Chain and Modulation

Side-chain signals bypass the built-in LFO modulation and apply modulation according to the envelope of the side-chain signal. Since each channel is analyzed and modulated separately, this allows for creating astonishing spatial modulation effects.

## Triggering a Delay Effect with Side-Chain Signals

You can use side-chain signals to create a ducking delay effect. This is useful if you want to apply a delay effect that is audible only when no signal is present on a track.

---

### PROCEDURE

1. Select the audio track that contains the audio you want to delay.
2. Select **Project > Duplicate Tracks**.  
The events on the duplicated track are only used to reduce the volume of the effect that is added to the original track.
3. Select the original track.
4. In the **Inspector**, open the **Inserts** section and select **Delay > PingPongDelay**, for example.
5. On the effect control panel, make your effect settings, and click **Activate Side-Chain**.



6. Click **Set Up Side-Chain Inputs**.
7. Click **Add Side-Chain Input**, and select the duplicate track from the selector.
8. Optional: Adjust the send level in the **Level** value field.
9. In the **Project** window, select the duplicate track.
10. In the **Inspector**, click **Output Routing** and select the side-chain node for the **PingPongDelay** effect.

---

### RESULT

The signals from the duplicated track are routed to the effect. Every time the audio signals on the track set in, the delay effect is deactivated.

### NOTE

To ensure that audio signals of low or medium volume also silence the delay effect, you can adjust the volume of the duplicated track.

---

## Triggering a Compressor with Side-Chain Signals

Compression, expansion, or gating can be triggered by side-chain signals exceeding a specified threshold. This allows you to lower the volume of one audio signal every time another audio signal sets in.

### PREREQUISITE

You have set up a project with a bass guitar and a bass drum track, for example, and you want to lower the bass guitar volume each time the bass drum hits.

### PROCEDURE

1. Select the bass guitar track.
2. In the **Inspector**, open the **Inserts** section.
3. Click the first effect slot, and from the selector, select **Dynamics > Compressor**.
4. On the effect control panel, make your effect settings, and click **Activate Side-Chain**.
5. On the effect control panel, click **Set Up Side-Chain Inputs**.
6. Click **Add Side-Chain Input**, and select the bass drum track from the selector.
7. Optional: Adjust the send level in the **Level** value field.

### RESULT

You have connected the bass drum track side-chain to the **Compressor** on the destination track. The bass drum signal triggers the **Compressor** on the bass guitar track. When you now play back the project, the bass guitar is compressed whenever the signals on the bass drum track exceed the set threshold.

## Side-Chain Inputs

The **Side-Chain Inputs** panel allows you to set up the side-chain input for the selected plug-in.

- To open the **Side-Chain Inputs** panel, click **Set Up Side-Chain Inputs** on the plug-in control panel.

The following controls are available:

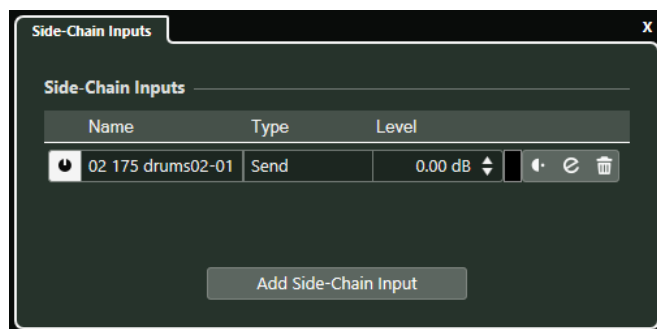

### Activate/Deactivate Side-Chain Input

Enables/Disables the side-chain input.

### Name

Shows the name of the side-chain input.

### Type

Shows the type of the side-chain input.

**Level**

Allows you to adjust the send level.

**Meter**

Shows the volume level of the input track.

**Pre-/Post-Fader**

Allows you to set the insert to pre-fader position or to post-fader position.

**Edit Channel Settings**

Opens the **Channel Settings** window for the selected side-chain input.

**Remove Side-Chain Input**

Removes the side-chain input.

**Add Side-Chain Input**

Opens a selector that allows you to add a side-chain input.

## Dither Effects

Dither effects allow you to control the noise that is produced by quantization errors that can occur when you mix down to a lower bit depth.

Dithering adds a special kind of noise at an extremely low level to minimize the effect of quantization errors. This is hardly noticeable and preferable to the distortion that otherwise occurs.

## Applying Dither Effects

---

**PROCEDURE**

1. Select **Studio > MixConsole**.
  2. Open the **Rack Settings** and activate **Fixed Number of Slots**.
  3. Click **Edit Channel Settings** for the output channel.
  4. In the **Inserts** section, click a post-fader effect slot, and select **Mastering > UV22HR**.
  5. On the plug-in panel, select a bit depth for the mixdown file you want to create.
- 

**RELATED LINKS**

[Export Audio Mixdown](#) on page 800

[Rack Settings Menu](#) on page 323

## Effect Control Panel

The effect control panel allows you to set up the parameters of the selected effect. The contents, design, and layout of the control panel depend on the selected effect.

- To open the control panel for a plug-in, click the effect slot.

The following controls are available for all effects:





- 1 Activate Effect**  
Activates/Deactivates the effect.
- 2 Bypass Effect**  
Allows you to bypass the effect.
- 3 Read Automation/Write Automation**  
Allows you to read/write automation for the effect parameter settings.
- 4 Switch between A/B Settings**  
Switches to setting B when setting A is active, and to setting A when setting B is active.
- 5 Copy A to B**  
Copies the effect parameters of effect setting A to effect setting B.
- 6 Activate Side-Chain**  
Activates the side-chain functionality.
- 7 Set Up Side-Chain Inputs**  
Allows you to set up the side-chain inputs for the selected plug-in.
- 8 Preset browser**  
Opens the preset browser where you can select another preset.
- 9 Preset Management**  
Opens a pop-up menu that allows you to save or load a preset.
- 10 Add VST Plug-in Picture to Media Rack**  
Adds a picture of the VST plug-in to the **Media** rack. This is only available for plug-ins of other vendors.
- 11 Functions menu**  
Opens a menu with specific functions and settings.

#### NOTE

For detailed information about the included effects and their parameters, see the separate document **Plug-in Reference**.

#### RELATED LINKS

[Hiding/Showing Effect Control Panels](#) on page 378

## Fine-Tuning Effect Settings

You can take your effect parameter settings as a starting point for further fine-tuning and then compare the new settings with the original settings.

### PREREQUISITE

You have adjusted the parameters for an effect.

---

### PROCEDURE

1. On the control panel for the effect, click **Switch between A/B Settings**.  
This copies the initial parameter setting A to setting B.
  2. Fine-tune the effect parameters.  
These parameter settings are now saved as setting B.
- 

### RESULT

You can now switch between both settings by clicking **Switch between A/B Settings**. You can compare them, make further adjustments or just go back to setting A. Settings A and B are saved with the project.

### AFTER COMPLETING THIS TASK

You can copy the settings between A and B by clicking **Copy A to B**. You can take these settings as a starting point for further fine-tuning.

## Hiding/Showing Effect Control Panels

When you add an audio effect, the respective plug-in control panel opens automatically. You can hide the control panels from view. This is useful to get a better overview if you added a number of plug-ins to your project whose control panels clutter up the screen.

---

### PROCEDURE

- Select **Window > Hide Plug-in Windows**.

#### NOTE

This also hides VST instrument control panels.

---

### RESULT

The control panels are hidden and sent to the back of the application. To show them again, select **Show Plug-in Windows**.

### RELATED LINKS

[Effect Control Panel](#) on page 376

## Closing All Control Panels

When you add an audio effect, the respective plug-in control panel opens automatically. You can close all control panels at once.

---

### PROCEDURE

- Select **Window > Close All Plug-in Windows**.

NOTE

This also closes VST instrument control panels.

RESULT

The control panels are closed.

RELATED LINKS

[Effect Control Panel](#) on page 376

## Effect Presets

Effect presets store the parameter settings of an effect. The included effects come with a number of presets that you can load, adjust, and save.

The following effect preset types are available:

- VST presets for a plug-in.  
These are plug-in parameter settings for a specific effect.
- Insert presets that contain insert effect combinations.  
These can contain the whole insert effects rack with settings for each effect.

Effect presets are saved in the following location:

- Windows: \Users\\My Documents\VST 3 Presets\- macOS: /Users/<user name>/Library/Audio/Presets/<company>/<plug-in name>

RELATED LINKS

[Loading Presets for Effects](#) on page 380

[Loading Insert Presets](#) on page 382

## Preset Browser

The preset browser allows you to select a VST preset for the loaded effect.

- To open the preset browser, click the preset browser field in the effect control panel.

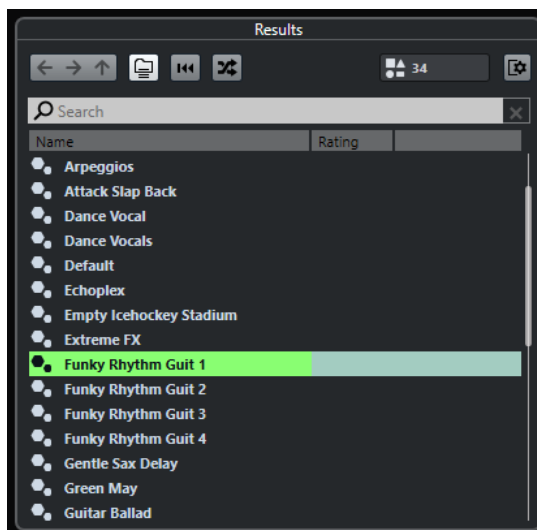

The **Results** section of the presets browser lists the available presets for the selected effect.

## Loading Presets for Effects

Most VST effect plug-ins come with a number of useful presets that you can instantly select.

### PREREQUISITE

You have loaded an effect, either as a channel insert or into an FX channel, and the effect control panel is open.

### PROCEDURE

1. Click the preset browser field at the top of the control panel.



2. In the **Results** section, select a preset from the list.
3. Double-click to load the preset that you want to apply.

### RESULT

The preset is loaded.

### AFTER COMPLETING THIS TASK

You can return to the preset that was selected when you opened the preset browser by clicking **Revert to Last Setting**.

## Saving Effect Presets

You can save your effect settings as presets for further use.

### PROCEDURE

1. Open the **Preset Management** pop-up menu.

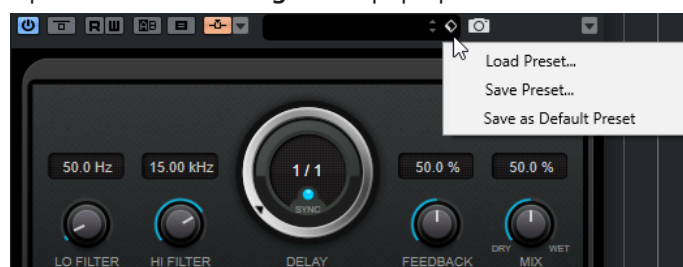

2. Select **Save Preset**.  
The **Save <plug-in name> Preset** dialog opens.
  3. In the **New Preset** section, enter a name for the new preset.
  4. Optional: Click **New Folder** to add a subfolder inside the effect preset folder.
  5. Optional: Click **Show Attribute Inspector** in the bottom left corner of the dialog and define attributes for the preset.
  6. Click **OK**.
- 

#### RESULT

The effect preset is saved.

#### RELATED LINKS

[Attribute Inspector](#) on page 524

## Saving Default Effect Presets

You can save your effect parameter settings as default effect preset. This allows you to load your parameter settings automatically every time you select the effect.

---

#### PROCEDURE

1. Open the **Preset Management** pop-up menu.

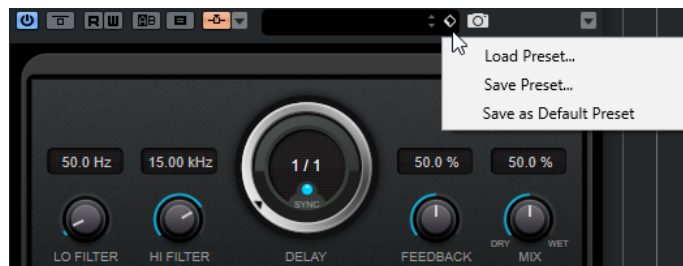

2. Select **Save as Default Preset**.  
You are asked if you want to save the current settings as default preset.
  3. Click **Yes**.
- 

#### RESULT

The effect settings are saved as default preset. Every time you load the effect, the default preset is loaded automatically.

## Copying and Pasting Presets Between Effects

You can copy and paste effect presets between different instances of the same plug-in.

---

#### PROCEDURE

1. Open the control panel for the effect that you want to copy.
  2. Right-click the control panel and select **Copy <plug-in name> Setting** from the context menu.
  3. Open another instance of the same effect.
  4. Right-click the control panel and select **Paste <plug-in name> Setting** from the context menu.
-

## Saving Insert Presets

You can save the inserts of the inserts effect rack for a channel as an inserts preset, together with all parameter settings. Insert presets can be applied to audio, instrument, FX channel, or group tracks.

### PREREQUISITE

You have loaded a combination of insert effects and the effect parameters are set up for each effect.

---

### PROCEDURE

1. Select the track.
2. In the **Inspector**, open the **Inserts** section.
3. On the **Inserts** tab, click **Preset Management** and select **Save FX Chain Preset**.

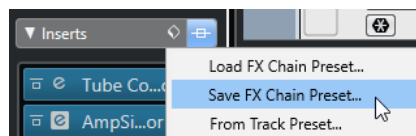

4. In the **Save FX Chain Preset** pane, enter a name for the new preset in the **New Preset** section.
  5. Click **OK**.
- 

### RESULT

The insert effects and their effect parameters are saved as insert preset.

## Loading Insert Presets

You can load insert presets to audio, group, instrument, and FX channels.

### PREREQUISITE

You have saved a combination of insert effects as insert presets.

---

### PROCEDURE

1. Select the track to which you want to apply the new preset.
2. In the **Inspector**, open the **Inserts** section.
3. On the **Inserts** section, click **Preset Management** and select **Load FX Chain Preset**.
4. Select an insert preset.

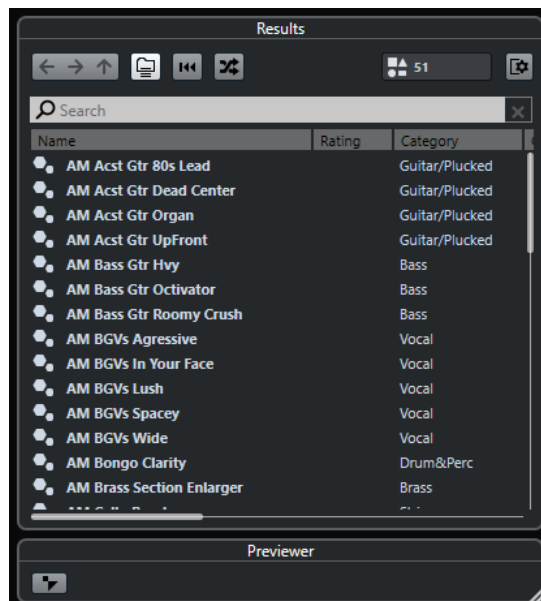

5. Double-click to apply the preset and close the pane.
- 

#### RESULT

The effects of the insert effect preset are loaded and any plug-ins that were previously loaded for the track are removed.

## Loading Insert Effect Settings from Track Presets

You can extract the effects that are used in a track preset and load them into your inserts rack.

---

#### PROCEDURE

1. Select the track to which you want to apply the new preset.
  2. In the **Inspector**, open the **Inserts** section.
  3. On the **Inserts** tab, click **Preset Management** and select **From Track Preset**.
  4. In the track preset pane, select the preset that contains the insert effects you want to load.
  5. Double-click to load the effects and close the pane.
- 

#### RESULT

The effects used in the track preset are loaded.

#### RELATED LINKS

[Track Presets](#) on page 162

## System Component Information Window

The **System Component Information** window lists all available MIDI plug-ins, audio-codec plug-ins, program plug-ins, project import-export plug-ins, and the virtual file system plug-ins.

- To open the **System Component Information** window, select **Studio > More Options > System Component Information**.

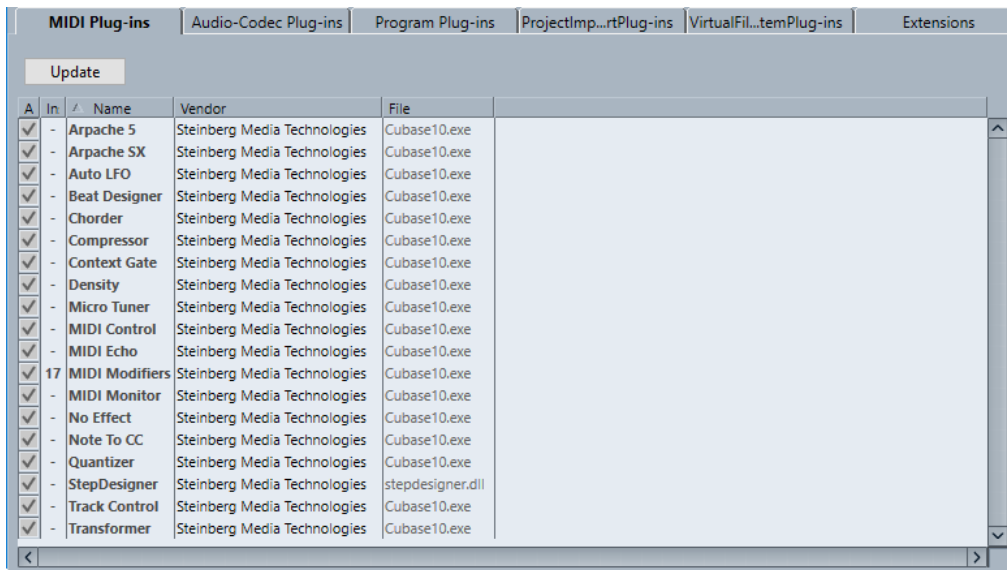

### Update (only available for MIDI Plug-ins)

Re-scans the designated plug-in folders for updated system component information.

The following columns are available:

#### Active

Allows you to activate or deactivate a plug-in.

#### Instances

The number of plug-in instances that are used in Cubase.

#### Name

The name of the plug-in.

#### Vendor

The manufacturer of the plug-in.

#### File

The name of the plug-in, including its file name extension.

#### Path

The path in which the plug-in file is located.

#### Category

The category of each plug-in.

#### Version

The version of the plug-in.

#### SDK

The version of the VST protocol with which the plug-in is compatible.

## Managing System Components in the System Component Information Window

- To make a plug-in available for selection, activate the checkbox in the left column. Only the activated plug-ins appear in the effect selectors.
- To see where a plug-in is used, click in the **Instances** column.



**NOTE**

A plug-in may be in use even if it is not activated in the left column. The left column only determines whether or not the plug-in is visible on the effect selectors.

---

## Exporting System Component Information Files

You can save system component information as an XML file, for example, for archiving purposes or troubleshooting.

- The system component information file contains information on the installed/available plug-ins, their version, vendor, etc.
- The XML file can then be opened in any editor application supporting the XML format.

**NOTE**

The export function is not available for program plug-ins.

---

**PROCEDURE**

1. In the **System Component Information** window, right-click in the middle of the window and select **Export**.
  2. In the dialog, specify a name and location for the system component information export file.
  3. Click **Save** to export the file.
-

# Direct Offline Processing

**Direct Offline Processing** allows you to instantly add audio processes to the selected audio events, clips, or ranges, without destructing the original audio.

Applying offline effects is common practice in dialogue editing and sound design. Offline processing has several advantages over applying real-time mixer effects:

- The workflow is clip-based. This allows you to apply different effects to events on the same track.
- The **MixConsole** can be kept clean from insert effects and parameter changes. This facilitates later mixing by another person, on a different system.
- Less CPU load is used.

**Direct Offline Processing** allows you to undo any changes regarding audio processes. You can always revert to the original version. This is possible because processing does not affect the actual audio files.

If you process an event, a clip, or a selection range, the following happens:

- A new audio file is created in the **Edits** folder within your project folder. This file contains the processed audio, and the processed section of the audio clip refers to it.
- The original file remains unaffected. The unprocessed sections still refer to it.

All applied offline processing is saved with the project and can still be modified after reopening the project. **Direct Offline Processing** operations on the selected audio are persistent in project backups.

Processing is always applied to the selection. This can be one or multiple events in the **Project** window or in the **Audio Part Editor**, an audio clip in the **Pool**, or a selection range on one or multiple events in the **Project** window or in the **Sample Editor**. If a selection is shorter than the audio file, only the selected range is processed.

If you select an event that is a shared copy, and therefore refers to a clip that is used by other events in the project, you can decide how to proceed:

- Select **Continue** to process all shared copies.
- Select **New Version** to process the selected event only.

## NOTE

This only works if **Open Options Dialog** is selected for the **On Processing Shared Clips** setting in the **Preferences** dialog (**Editing—Audio** page).

## RELATED LINKS

[Modifying Processes](#) on page 390

[Editing - Audio](#) on page 889

[Direct Offline Processing Workflow](#) on page 387

[Direct Offline Processing Window](#) on page 387

## Direct Offline Processing Workflow

You can perform offline processing operations in the **Direct Offline Processing** window. The window always shows the processing of the selected audio.

When you add or modify offline processing, the following applies:

- If you add a process, its last used parameter settings are loaded. You can reset it to its default settings by clicking **Reset to Default Values**.
- All changes are instantly applied to the audio.
- If you modify parameters or remove processing, these changes are instantly applied to the audio.
- You get a visual feedback while a process is running.

### NOTE

You can add, modify, or delete audio processes at any time, even if a process is running. A new rendering process is instantly started.

- You can undo and redo all **Direct Offline Processing** operations by using **Ctrl/Cmd-Z** or **Shift-Ctrl/Cmd-Z**.
- You can apply all offline processing permanently to the audio.
- If you load a project with offline processing of audio processes that are not available on your computer, these processes are shown as **Not available** in the **Direct Offline Processing** window.

### RELATED LINKS

[Direct Offline Processing Window](#) on page 387

[Key Commands for Direct Offline Processing](#) on page 401

[Applying Offline Processing Permanently](#) on page 392

## Direct Offline Processing Window

The **Direct Offline Processing** window allows you to add, modify, or delete audio processing instantly for one or multiple events, clips, or selection ranges in one window. Furthermore, you can undo any audio processing.

To open the **Direct Offline Processing** window, do one of the following:

- Select **Audio > Direct Offline Processing**.
- Press **F7**.
- On the **Project** window toolbar, click **Open Direct Offline Processing Window**.
- Select **Audio > Processes**, and from the submenu, select a process.

### NOTE

Processes without adjustable parameter settings, such as **Silence**, do not open the **Direct Offline Processing** window when applied from the menu or using a key command.

---

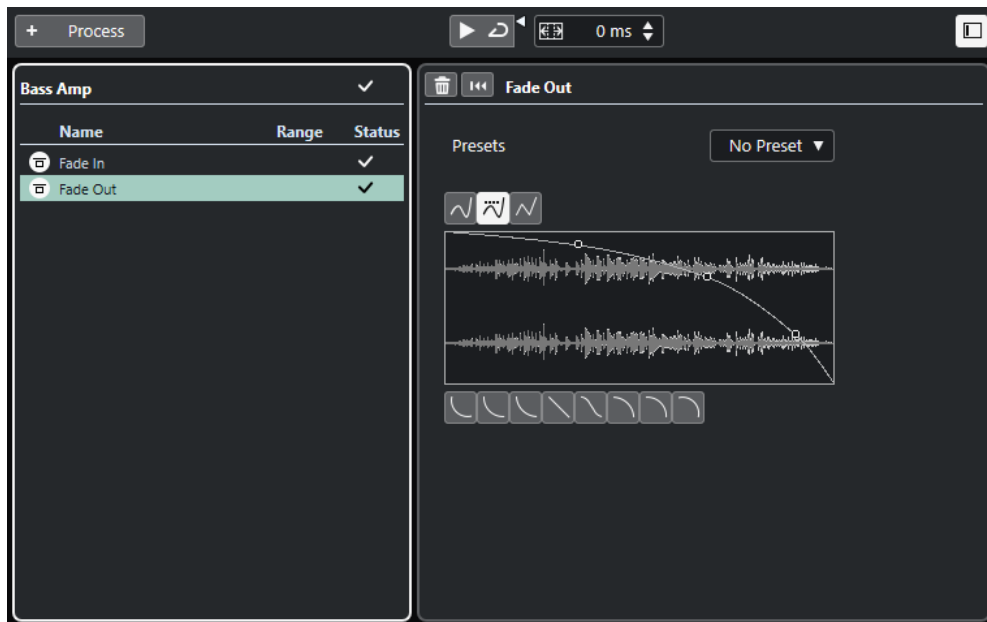

In the **Direct Offline Processing** window, the following options and settings are available:

### Toolbar

Allows you to add audio processing, to audition the audio with the current edits, and to make global settings for offline processing.

### Process list

Lists all built-in audio processes that you add to the selected event, clip, or range. You can bypass items in this list. An icon at the right of each process shows the status.

If only a range of a selected event is processed, this is indicated by a waveform icon in the **Range** column.

If more than one processed event or clip is selected, the **Count** column shows how many instances of each process are used on the whole selection.

You can copy or cut processes with all settings and paste them to other events, clips, or ranges, delete them, and make offline processing permanent by using the context menu.

### Process panel

Allows you to modify, reset, or delete the selected audio process.

### RELATED LINKS

[Applying Processing](#) on page 389

[Applying Processing to Multiple Events](#) on page 390

[Direct Offline Processing Toolbar](#) on page 388

## Direct Offline Processing Toolbar

The **Direct Offline Processing** toolbar allows you to add audio processing, to audition the audio with the current edits, and to make global settings for offline processing.

On the toolbar, the following options and settings are available:

### Add Processes

#### Add Process

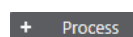

Allows you to add a built-in audio process to the selected event or clip.

## Left Divider

### Left Divider



Tools that are placed to the left of the divider are always shown.

## Audition

### Audition



Allows you to audition the selected audio with all processing from the top of the process list up to the selected process in the list. All processes below are ignored during playback.

### Audition Loop



Loops the playback until you deactivate the **Audition** button.

### Audition Volume



Allows you to adjust the volume.

## Extend Process Range

### Extend Process Range in ms



Allows you to extend the process range over the left and right of the event borders. This allows you to enlarge the event at a later stage with all applied processing.

#### RELATED LINKS

[Process Range Extension](#) on page 390

## Applying Processing

You can add processing to one or multiple events, clips, or ranges in the **Direct Offline Processing** window. This includes audio processes and **Sample Editor** operations, such as **Cut**, **Paste**, **Delete**, and using the **Draw** tool.

---

#### PROCEDURE

1. Do one of the following:
  - Select an event or a range in the **Project** window.
  - Select a clip in the **Pool**.
  - Select a range in the **Sample Editor**.
  - Select an event or a range in the **Audio Part Editor**.
2. Select **Audio > Direct Offline Processing**.
3. On the **Direct Offline Processing** toolbar, click **Add Process** and select an audio process. The selected audio process is added to process list in the left zone.
4. Activate **Audition** and make your changes on the process panel.

You get a visual feedback while a process is running. However, even if the processing is not finished, you can activate **Audition** at any time.

---

#### RESULT

The audio process is rendered into the audio.

In the **Project** window, the **Pool** or the **Audio Part Editor**, the processed events show a waveform symbol.

## Applying Processing to Multiple Events

**Direct Offline Processing** allows you to add the built-in audio processes to multiple events at once. You can also modify or delete processing on multiple events simultaneously.

- To apply audio processes to multiple events at once, select the audio and add, modify, or delete the processing.

#### NOTE

In the **Direct Offline Processing** window, you can also edit the audio processing of multiple clips in the **Pool** simultaneously.

---

#### RELATED LINKS

[Built-In Audio Processes](#) on page 393

[Direct Offline Processing Window](#) on page 387

## Process Range Extension

You can extend the process range over the left and right borders of the audio event.

This setting allows you to enlarge the event even after applying the processing.

- To extend the process range, click **Extend Process Range in ms** on the **Direct Offline Processing** toolbar and specify a value in milliseconds.

#### NOTE

- For this to work, audio must be available outside the event borders.
  - This setting works globally for all events.
- 

## Modifying Processes

You can delete or modify some or all processing from a clip in the **Direct Offline Processing** window. This includes the audio processes on the **Processes** menu and **Sample Editor** operations, such as **Cut**, **Paste**, **Delete**, and drawing with the **Draw** tool.

---

#### PROCEDURE

1. Do one of the following:
  - Select the processed event in the **Project** window or in the **Audio Part Editor**.

#### NOTE

In the **Project** window or in the **Audio Part Editor**, processed events are indicated by a waveform symbol in the upper right corner.

---

- Select the processed clip in the **Pool**.

**NOTE**

In the **Pool**, processed clips are indicated by a waveform symbol in the **Status** column.

---

- Select the processed range in the **Sample Editor**.
2. Select **Audio > Direct Offline Processing**.
  3. In the process list, select the process that you want to edit by clicking on it.
  4. Do one of the following:
    - Activate **Audition** and modify the settings of the process.
    - Reset the process to its default settings by clicking **Reset to Default Values**.
    - Delete the process by clicking **Delete**  on the process panel.

**NOTE**

Alternatively, you can right-click the process list and select **Delete**.

---

- To delete all processing applied to the event, right-click the process list and select **Delete All**.
- 

RELATED LINKS

- [Direct Offline Processing Window](#) on page 387
- [Pool Window Columns](#) on page 478

## Reordering the Process List

You can reorder the operations in the **Direct Offline Processing** process list by dragging.

---

PROCEDURE

- Click an audio process and move it by dragging.
- 

RESULT

The offline processing operations are rendered into the audio in the specified order.

## Bypass Processes

In the **Direct Offline Processing** window, you can bypass processes. This allows you to hear the audio without the processes.

- To activate/deactivate bypass for a process, click the **Bypass Process** button on the left of the process.

**NOTE**

- If you activate/deactivate **Bypass Process**, the complete process chain is recalculated. Depending on the length of the audio and number of processes, this may take some time. In the process list, you get a visual feedback while a process is running.
  - The bypass status is saved with the project.
-

## Copying and Pasting Processes

You can copy and paste audio processes together with their parameter settings between events, clips, and ranges.

---

### PROCEDURE

1. Select a processed audio event, clip, or range.

#### NOTE

Processing on selections of multiple events cannot be copied.

2. In the **Direct Offline Processing** window, select one or multiple items in the process list.
3. Right-click the process in the process list and select **Copy** from the context menu.
4. Select the events or clips where you want to paste the process.
5. In the **Direct Offline Processing** window, right-click the process in the process list and select **Paste**.

---

### RESULT

The copied processes and all parameter settings are added to the process list of the selected audio.

## Applying Offline Processing Permanently

You can apply all offline processing permanently to the audio.

### PREREQUISITE

You have applied audio processes to an event, clip, or range and you are sure that you do not need to edit the processing anymore.

#### IMPORTANT

Making offline processing permanent cannot be undone.

---

### PROCEDURE

1. Select the processed event, clip, or range.
2. Select **Audio > Make Direct Offline Processing Permanent**.

#### NOTE

Alternatively, select **Make All Permanent** in the context menu of the **Direct Offline Processing** process list.

3. Click **OK**.

---

### RESULT

- All processing and applied effects are permanently added to the selected event, clip, or range.
- The process list is emptied.
- The event or clip is no longer marked as offline-processed by a waveform symbol.



## Built-In Audio Processes

Cubase provides several built-in audio processes that can be used for **Direct Offline Processing**.

### Envelope

**Envelope** allows you to apply a volume envelope to the selected audio.

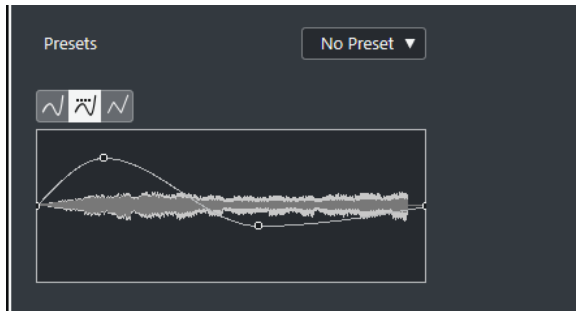

#### Curve Type buttons

Determine whether the corresponding envelope uses **Spline Interpolation**, **Damped Spline Interpolation**, or **Linear Interpolation**.

#### Envelope display

Shows the shape of the envelope. The resulting waveform shape is shown in a dark tone, with the current waveform shape in a light tone.

- To add a curve point, click the curve.
- To move a curve point, click and drag.
- To remove a curve point, click and drag it outside the display.

#### Presets pop-up menu

Allows you to manage your presets.

- To save a preset, select **Save Preset** from the pop-up menu, enter a name, and click **OK**.
- To apply a preset, select it from the pop-up menu.
- To remove a preset, select it from the pop-up menu, and click **Remove Preset**.

### Fade In/Fade Out

**Fade In** and **Fade Out** allow you to apply a fade to the selected audio.

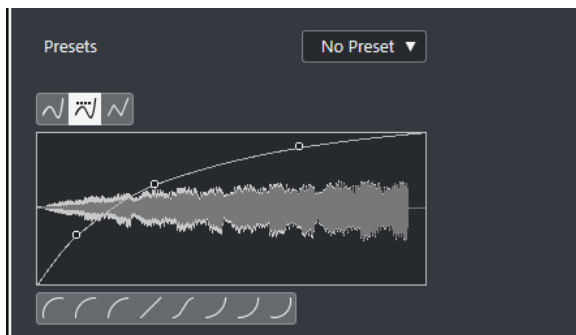

#### Curve Type buttons

Determine whether the corresponding envelope uses **Spline Interpolation**, **Damped Spline Interpolation**, or **Linear Interpolation**.

### Fade display

Shows the shape of the fade curve. The resulting waveform shape is shown in a dark tone, with the current waveform shape in a light tone.

- To add points, click the curve.
- To change the curve shape, click and drag existing points.
- To remove a point from the curve, drag it outside the display.

### Presets pop-up menu

Allows you to manage your presets.

- To save a preset, select **Save Preset** from the pop-up menu, enter a name, and click **OK**.
- To apply a preset, select it from the pop-up menu.
- To remove a preset, select it from the pop-up menu, and click **Remove Preset**.

### Curve Shape buttons

These buttons give you quick access to some common curve shapes.

## Gain

**Gain** allows you to change the gain, that is, the level of the selected audio.

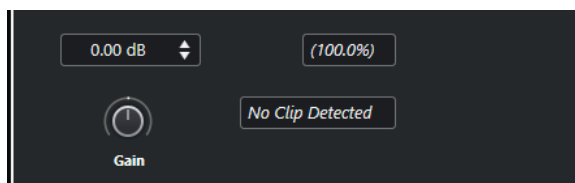

### Gain

Allows you to set a gain value between -50 dB and +20 dB.

### Clipping Detection text

This text is displayed if you use **Audition** and the gain setting results in audio levels above 0 dB.

#### NOTE

In case of clipping, lower the **Gain** value and use the **Normalize** audio process instead. This allows you to increase the level of the audio as much as possible without causing clipping.

#### RELATED LINKS

[Normalize](#) on page 395

## Invert Phase

**Invert Phase** allows you to invert the phase of the selected audio.

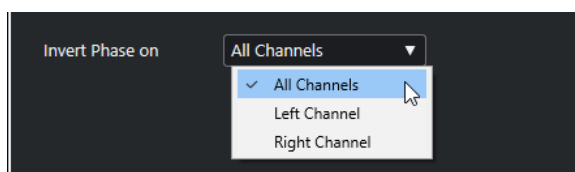

For stereo audio files, a pop-up menu is available. It allows you to specify which channels are phase-inverted: the left channel, the right channel, or both.

## Normalize

**Normalize** allows you to raise or lower the level of audio that was recorded at an inappropriate input level.

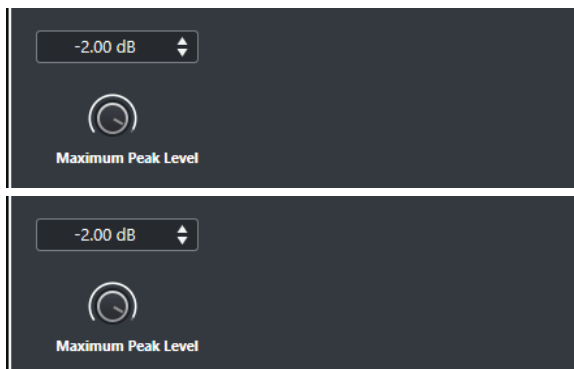

### Maximum Peak Level

Allows you to normalize your audio based on the maximum peak level. **Maximum Peak Level in dBFS** sets a maximum peak level for the audio, between -50 dB and 0 dB. From this maximum level, the current maximum level of the selected audio is subtracted, and the gain is raised or lowered by the resulting amount.

## Pitch Shift

**Pitch Shift** allows you to change the pitch of the audio with or without affecting its length. You can also create harmonies by specifying several pitches or apply pitch shift based on an envelope curve.

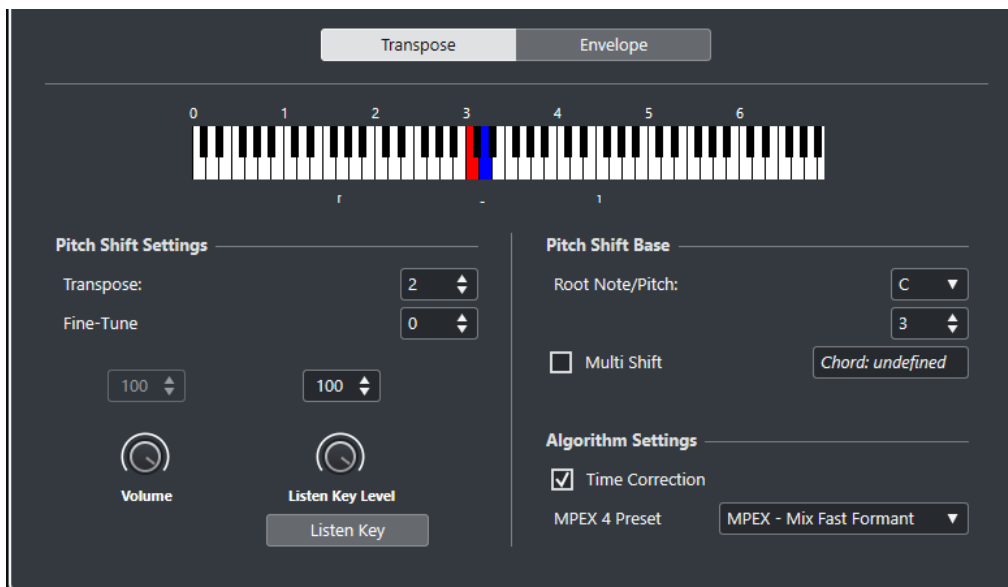

On the **Transpose** tab, the following options are available:

### Keyboard display

Shows a graphic overview of the transposition where the root note is indicated in red and the transposed key is indicated in blue.

**NOTE**

The indicated root note has nothing to do with the key or pitch of the original audio, it just provides a way to display transpose intervals.

---

- To change the root note, use the settings in the **Pitch Shift Base** section, or hold **Alt**, and click the keyboard display.
- To specify a transpose interval, click one of the keys.
- To specify a chord, activate **Multi Shift** and click several keys.  
To remove a transpose interval, click a blue key.

## Pitch Shift Settings

### Transpose

Allows you to specify the amount of pitch shift in semitones.

### Fine-Tune

Allows you to specify the amount of pitch shift in cents.

### Volume

Allows you to lower the volume of the pitch-shifted sound. This is not available if **Time Correction** is activated.

### Listen Key Level

Allows you to adjust the level of the pitch-shifted sound. Click **Listen Key/Listen Chord** to play a test tone of the pitch-shifted sound.

## Pitch Shift Base

### Root Note/Pitch

Allows you to set the root note.

**NOTE**

The indicated root note has nothing to do with the key or pitch of the original audio, it just provides a way to display transpose intervals.

---

### Multi Shift

Activate this to specify several transpose keys and create multi-part harmonies. If the intervals you add make up a standard chord, this chord is displayed to the right.

- To include the original, untransposed sound, click the root key in the keyboard display so that it is displayed in blue.

## Algorithm Settings

### Time Correction

Activate this option to shift the pitch without affecting the length of the audio. If this is deactivated and you raise the pitch, the audio section is shortened.

### MPEX 4 Preset

Allows you to select an MPEX 4 algorithm.

### RELATED LINKS

[Time Stretch and Pitch Shift Algorithms](#) on page 403

## Envelope-Based Pitch Shift

On the **Envelope** tab, you can specify an envelope curve as a base for the pitch shift.

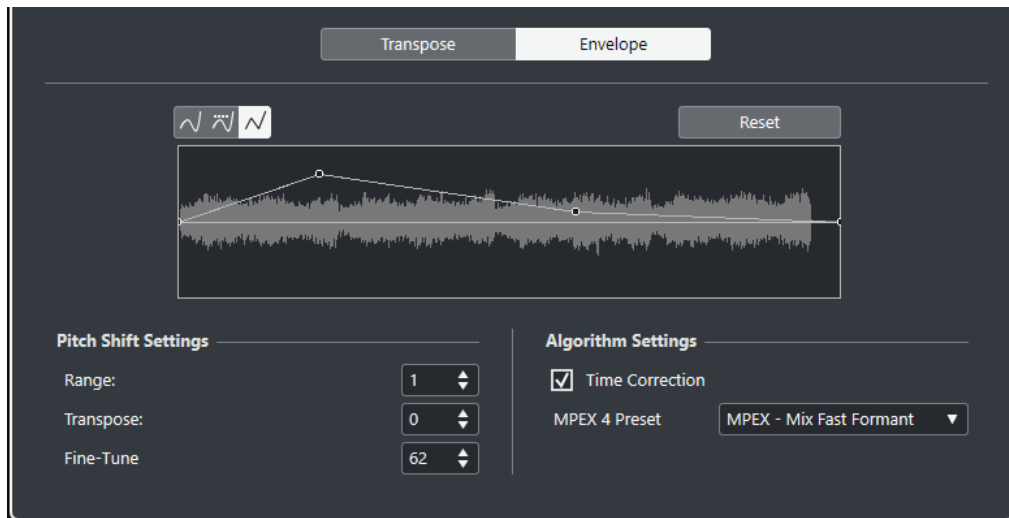

### Curve Type buttons

Determine whether the corresponding envelope uses **Spline Interpolation**, **Damped Spline Interpolation**, or **Linear Interpolation**.

### Envelope display

Shows the shape of the envelope curve over the waveform image of the audio selected for processing. Envelope curve points above the center line indicate a positive pitch shift, curve points below the center line indicate a negative pitch shift. Initially, the envelope curve is a horizontal, centered line, indicating zero pitch shift.

- To add a curve point, click the curve.
- To move a curve point, click and drag.
- To remove a curve point, click and drag it outside the display.
- To remove all curve points, click **Reset** above the envelope display.

### Pitch Shift Settings

#### Range

Allows you to determine the vertical pitch range of the envelope. Moving a curve point to the top of the display shifts the pitch by this value.

#### Transpose

Allows you to specify the amount of pitch shift in semitones.

#### Fine-Tune

Allows you to specify the amount of pitch shift in cents.

### Algorithm Settings

#### Time Correction

Activate this option to shift the pitch without affecting the length of the audio. If this is deactivated, raising the pitch shortens the audio section and vice versa, much like changing the playback speed on a tape recorder.

#### MPEX 4 Preset

Allows you to select an MPEX 4 algorithm.

RELATED LINKS

[MPEX](#) on page 403

## Remove DC Offset Option

**Remove DC Offset** allows you to remove any DC offset in the audio selection.

If your audio signal contains too large a component of direct current, you may notice that it is not centered around the zero level axis. This is called DC offset.

- To verify if your audio contains DC offsets, select the audio and select **Audio > Statistics**.

### IMPORTANT

DC offset is normally present throughout the entire recording. Therefore, always apply **Remove DC Offset** to complete audio clips.

---

There are no adjustable parameters for this audio process.



RELATED LINKS

[Statistics Window](#) on page 411

## Resample

**Resample** allows you to change the length, tempo, and pitch of an event.

If you resample to a higher sample rate, the event gets longer and the audio plays back at a slower speed with a lower pitch. If you resample to a lower sample rate, the event gets shorter and the audio plays back at a faster speed with a higher pitch.

File Sample Rate:	<input type="text" value="44100.00"/>
New Sample Rate	<input type="text" value="44100.0"/> 
Difference	<input type="text" value="0.000 %"/> 

### File Sample Rate

Shows the original sample rate of the event.

### New Sample Rate

Allows you to resample the event by specifying a sample rate.

### Difference

Allows you to resample the event by specifying the difference between the original sample rate and the new sample rate.

## Reverse

**Reverse** allows you to reverse the audio selection so that it sounds as if you play back a tape backwards. There are no adjustable parameters for this audio process.

## Silence

**Silence** allows you to replace the selection with silence. There are no adjustable parameters for this audio process.

## Stereo Flip

**Stereo Flip** allows you to manipulate the left and right channels of stereo audio selections.

In the **Mode** pop-up menu, the available options are:

### Flip Left-Right

Swaps the left and right channel.

### Left to Stereo

Copies the left channel sound to the right channel.

### Right to Stereo

Copies the right channel sound to the left channel.

### Merge

Merges both channels on each side for mono sound.

### Subtract

Subtracts the left channel information from the right. This function is typically used for karaoke background as it removes the centered mono material from a stereo signal.

## Time Stretch

**Time Stretch** allows you to change the length and tempo of the selected audio without affecting the pitch.

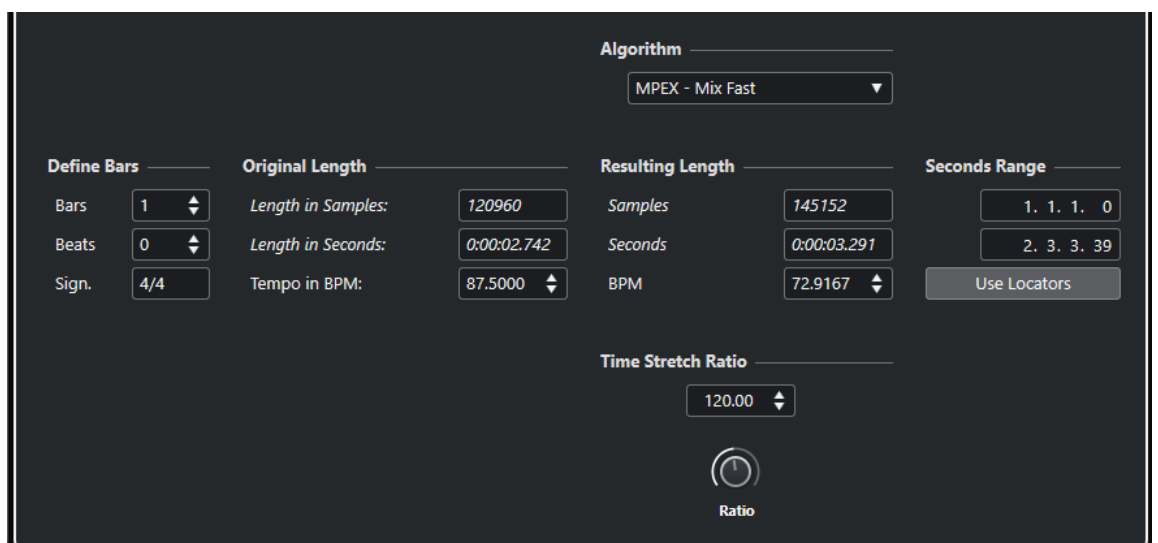

### Define Bars

You can set the length of the selected audio and the time signature in this section.

**Bars**

Allows you to set the length of the selected audio in bars.

**Beats**

Allows you to set the length of the selected audio in beats.

**Signature**

Allows you to set the time signature.

**Original Length**

This section contains information and settings regarding the audio that is selected for processing.

**Length in Samples**

Shows the length of the selected audio in samples.

**Length in Seconds**

Shows the length of the selected audio in seconds.

**Tempo in BPM**

Allows you to enter the actual tempo of the audio in beats per minute. This option allows you to time-stretch the audio to another tempo, without having to compute the actual time stretch amount.

**Resulting Length**

These values change automatically if you adjust the **Time Stretch Ratio** to stretch the audio so that it fits within a specific time span or tempo.

**Samples**

Shows the resulting length in samples.

**Seconds**

Shows the resulting length in seconds.

**BPM**

Shows the resulting tempo in beats per minute. For this to work, the **Original Length** values must be specified.

**Seconds Range**

These settings allow you to set a range for the time stretch.

**Arbitrary Range Start Time**

Allows you to set a start position for the range.

**Arbitrary Range End Time**

Allows you to set an end position for the range.

**Use Locators**

Allows you to set the **Seconds Range** values to the left and right locator positions, respectively.

**Algorithm**

Allows you to select a time stretch algorithm.



## Time Stretch Ratio

Allows you to set the amount of time stretch as a percentage of the original length. If you use the settings in the **Resulting Length** section to specify the amount of time stretch, this value changes automatically.

### RELATED LINKS

[Time Stretch and Pitch Shift Algorithms](#) on page 403

## Key Commands for Direct Offline Processing

You can apply offline processing by using key commands.

If you add audio processes via key commands, the following applies:

- The current settings are used.
- The **Direct Offline Processing** window opens. This does not apply if the selected process does not feature any adjustable parameters or if the window is in the background or minimized.
- You can apply offline processing by using key commands even if **Auto Apply** is deactivated.

If the corresponding section in the **Direct Offline Processing** window has the focus, the following default key commands apply:

Option	Key command
Open/Close <b>Direct Offline Processing</b> window	<b>F7</b>
Set focus within <b>Direct Offline Processing</b> window	<b>Tab</b>
Navigate in the process list	<b>Up Arrow/Down Arrow</b>
Activate/Deactivate Audition ( <b>Playback Toggle triggers Local Preview</b> must be activated in the <b>Preferences</b> dialog)	<b>Space</b>
Delete selected item from process list	<b>Delete</b>
Select all items in process list	<b>Ctrl/Cmd-A</b>
Cut selected items from process list	<b>Ctrl/Cmd-X</b>
Copy selected items in process list	<b>Ctrl/Cmd-C</b>
Paste items to process list	<b>Ctrl/Cmd-V</b>
Undo	<b>Ctrl/Cmd-Z</b>

To define key commands for further **Direct Offline Processing** operations, and for directly adding particular audio processes, use the **Key Commands** dialog.

RELATED LINKS

[Direct Offline Processing Window](#) on page 387

[Transport](#) on page 904

[Key Commands](#) on page 854

# Time Stretch and Pitch Shift Algorithms

In Cubase, time-stretching and pitch-shifting algorithms are used for offline processes, in the **Sample Editor**, or for the **Flattening Realtime Processing** function. Depending on the feature, **élastique**, **MPEX**, or **Standard** algorithm presets are available.

## RELATED LINKS

[Time Stretch](#) on page 399  
[Pitch Shift](#) on page 395  
[Sample Editor](#) on page 413  
[élastique](#) on page 403  
[MPEX](#) on page 403  
[Standard](#) on page 404  
[Limitations](#) on page 405

## élastique

The **élastique** algorithm is suited for polyphonic and monophonic material.

The following modes are available:

### élastique Pro

For best audio quality, without formant preservation.

### élastique Pro Formant

For best audio quality, but including formant preservation.

### élastique efficient

Requires less computing power, but has a lower audio quality than the **Pro** modes.

The modes support the following variants:

### Time

Favors timing accuracy over pitch accuracy.

### Pitch

Favors pitch accuracy over timing accuracy.

### Tape

Locks the pitch shift to the time stretch as if playing back a tape with varying speed. If you stretch the audio material, the pitch decreases automatically. This variant has no effect if you use it with event transpose or the transpose track.

## MPEX

**MPEX** is an alternative high-quality algorithm.

You can choose between the following quality settings:

**MPEX – Preview Quality**

For preview purposes.

**MPEX – Mix Fast**

A very fast mode for preview. This mode works best with composite music signals (mono or stereo material).

**MPEX – Solo Fast**

For single instruments (monophonic material) and voice.

**MPEX – Solo Musical**

Higher quality for single instruments (monophonic material) and voice.

**MPEX – Poly Fast**

For monophonic and polyphonic material. This is the fastest setting that still gives very good results. You can use this for drum loops, mixes, and chords.

**MPEX – Poly Musical**

For monophonic and polyphonic material. This is the recommended **MPEX** quality setting. You can use this for drum loops, mixes, or chords.

**MPEX – Poly Complex**

For complex material or for higher stretch factors. This high-quality setting is quite CPU-intensive.

**NOTE**

If you apply **Pitch Shift** as an offline process, you can choose between the regular setting and a setting where the formants are preserved for each quality setting.

---

## Standard

The **Standard** algorithm is optimized for CPU-efficient realtime processing.

The following presets are available:

**Standard – Drums**

For percussive sounds. This mode does not change the timing of your audio. If you use it with certain tuned percussion instruments, you may experience audible artifacts. In this case, try **Mix** mode as an alternative.

**Standard – Plucked**

For audio with transients and a relatively stable spectral sound character like plucked instruments.

**Standard – Pads**

For pitched audio with slower rhythm and a stable spectral sound character. This minimizes sound artifacts, but the rhythmic accuracy is not preserved.

**Standard – Vocals**

For slower signals with transients and a prominent tonal character like vocals.

**Standard – Mix**

For pitched material with a less homogenous sound character. This mode preserves the rhythm and minimizes the artifacts.

**Standard – Custom**

Allows you to set the time-stretching parameters manually.

### Standard – Solo

For monophonic material like solo woodwind/brass instruments or solo vocals, monophonic synths or string instruments that do not play harmonies. This mode preserves the timbre of the audio.

### Custom Warp Settings

If you select the **Standard – Custom** mode, a dialog opens where you can manually adjust the parameters that govern the sound quality of the time stretching:

#### Grain Size

Allows you to determine the size of the grains in which the standard time-stretching algorithm splits the audio. Low grain size values lead to good results for material that has many transients.

#### Overlap

This is the percentage of the whole grain that will overlap with other grains. Use higher values for material with a stable sound character.

#### Variance

This is a percentage of the whole length of the grains, and sets a variation in positioning, so that the overlapping area sounds smooth. A variance setting of 0 produces a sound akin to time stretching used in early samplers, whereas higher settings produce more rhythmic smearing effects but fewer audio artifacts.

## Limitations

Applying time stretching or pitch shifting to audio material can lead to a degradation in audio quality and to audible artifacts. The result depends on the source material, the particular stretch and pitch operations applied, and the selected audio algorithm preset.

As a rule of thumb, smaller changes in pitch or duration cause less degradation. However, there are additional issues one should be aware of when working with time stretching and pitch shifting algorithms.

#### NOTE

In rare cases, editing warped audio events may cause discontinuities at the edit points. You can then try to move the edit point to a different position or bounce the audio event prior to editing.

### Reverse Playback and Scrubbing

Most of the algorithms used for time stretching and pitch shifting only support forward playback. Reverse playback or scrubbing of warped audio events can lead to recurring artifacts in playback.

### Pitch and Stretch Factor

Some algorithms may put limitations on the maximum degree of time stretching or pitch shifting supported. However, with **élastique** there are no limitations.

# Audio Functions

Cubase offers particular functions for analyzing the audio in your project.

## RELATED LINKS

[Detect Silence Dialog](#) on page 406

[Spectrum Analyzer Window](#) on page 409

[Statistics Window](#) on page 411

## Detect Silence Dialog

The **Detect Silence** dialog allows you to search for silent sections in events. You can split events and remove the silent parts from the project, or create regions corresponding to the non-silent sections.

- To open the **Detect Silence** dialog for a selected audio event, clip, or selection range, select **Audio > Advanced > Detect Silence**.

### NOTE

If you select multiple events, you can process the selected events successively with individual settings or apply the same settings to all selected events simultaneously.

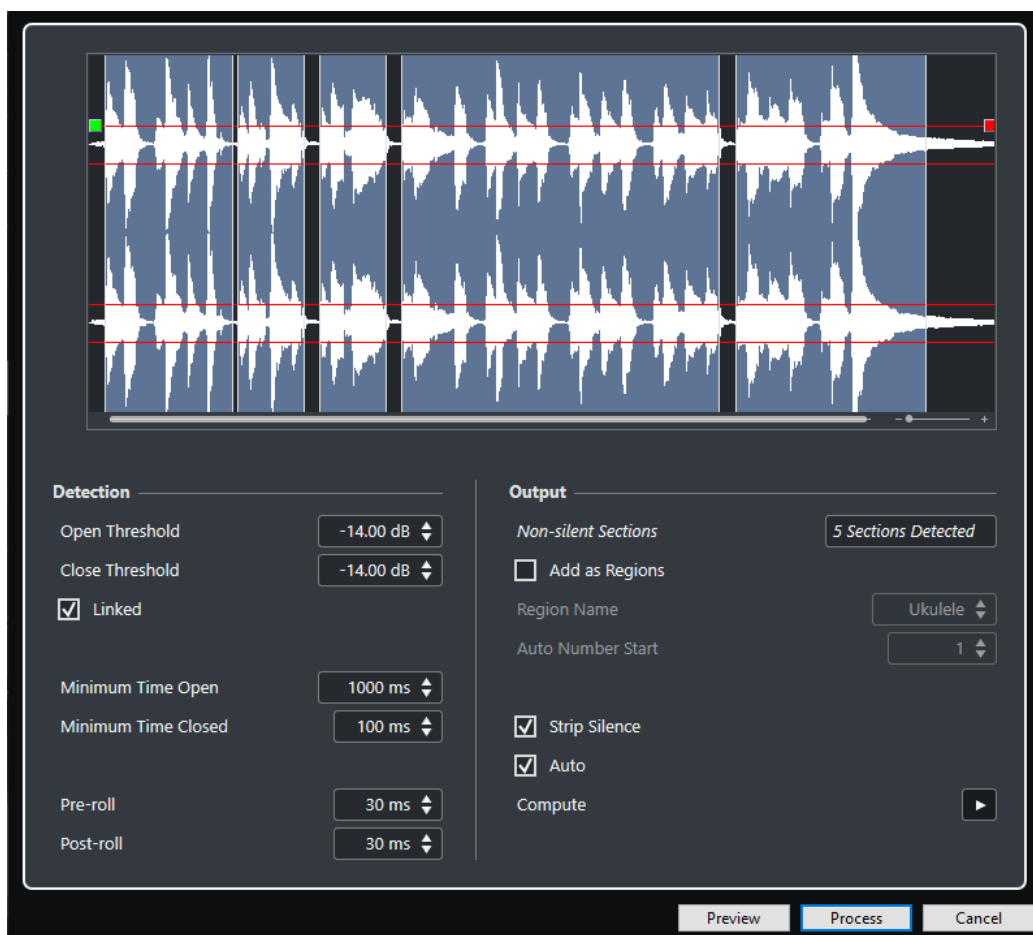

The following options are available:

### Waveform display

Allows you to zoom in on and out of the waveform by using the zoom slider to the right or by clicking in the waveform and moving the mouse up or down.

You can scroll the waveform by using the scrollbar, or by using the mouse wheel.

You can adjust the **Open Threshold** and **Close Threshold** values by moving the squares at the beginning and at the end of the audio file.

The **Detection** section features the following options:

### Open Threshold

When the audio level exceeds this value, the function opens and lets the sound pass. Audio material below the set level is detected as silence.

### Close Threshold

When the audio level drops below this value, the function closes and detects sounds below this level as silence. This value cannot be higher than the **Open Threshold** value.

### Linked

Activate this option to set the same values for **Open Threshold** and **Close Threshold**.

### Minimum Time Open

Determines the minimum time that the function remains open after the audio level has exceeded the **Open Threshold** value.

**NOTE**

If your audio contains repeated short sounds, and this results in too many short open sections, try raising this value.

---

**Minimum Time Closed**

Determines the minimum time that the function remains closed after the audio level has dropped below the **Close Threshold** value. Set this to a low value to make sure that you do not remove sounds.

**Pre-roll**

Causes the function to open slightly before the audio level exceeds the **Open Threshold** value. Use this option to avoid removing the attack of sounds.

**Post-roll**

Causes the function to close slightly after the audio level drops below the **Close Threshold** value. Use this option to avoid removing the natural decay of sounds.

The **Output** section features the following options:

**Non-silent Sections**

Shows the number of events that are created if you click **Process**.

**Add as Regions**

Creates regions of the non-silent sections.

**Region Name**

Allows you to specify a name for the non-silent sections.

**Auto Number Start**

Allows you to specify the start number for the numbers that are automatically appended to the region names.

**Strip Silence**

Splits the event at the beginning and end of each non-silent section, and removes the silent sections in between.

**Process all selected Events**

Applies the same settings to all selected events. This option is only available if you selected more than one event.

**Auto**

Activate this option to analyze the audio event and update the display automatically every time you change the settings.

**NOTE**

If you are working with very long files, consider deactivating the **Auto** option as this may slow down the process.

---

**Compute**

Analyzes the audio event and redraws the waveform display to indicate which sections are considered silent.

**Preview**

Allows you to listen to the result before it is processed.

**Process**

Processes the audio according to your settings.



RELATED LINKS

[Removing Silent Sections](#) on page 409

## Removing Silent Sections

The **Detect Silence** dialog allows you to detect and remove silent sections of your audio.

---

PROCEDURE

1. Select one or multiple audio events with silent sections in the **Project** window.
  2. Select **Audio > Advanced > Detect Silence**.
  3. In the **Detect Silence** dialog, make your changes.
  4. Click **Compute** to analyze the audio.  
The audio is analyzed and the waveform is redrawn to indicate which sections are considered silent according to your settings. The number of detected regions is displayed.
  5. Optional: Click **Preview** to listen to the result.  
The event is played back and the sections are silenced according to your settings.
  6. Optional: In the **Detection** section, readjust the settings until you are satisfied with the result.
  7. Optional: In the **Output** section, activate **Add as Regions**.
  8. In the **Output** section, activate **Strip Silence**.
  9. Click **Process**.
- 

RESULT

The event is split and the silent sections are removed.



AFTER COMPLETING THIS TASK

If you have selected more than one event and did not activate **Process all selected Events**, the **Detect Silence** dialog opens again after processing, allowing you to make separate settings for the next event.

RELATED LINKS

[Detect Silence Dialog](#) on page 406

## Spectrum Analyzer Window

The **Spectrum Analyzer** window displays the audio spectrum of an event, clip, or selection range as a two-dimensional graph, with frequency range on the x-axis and level distribution on the y-axis.

- To open the **Spectrum Analyzer** window for a selected audio event, clip, or selection range, select **Audio > Spectrum Analyzer**.

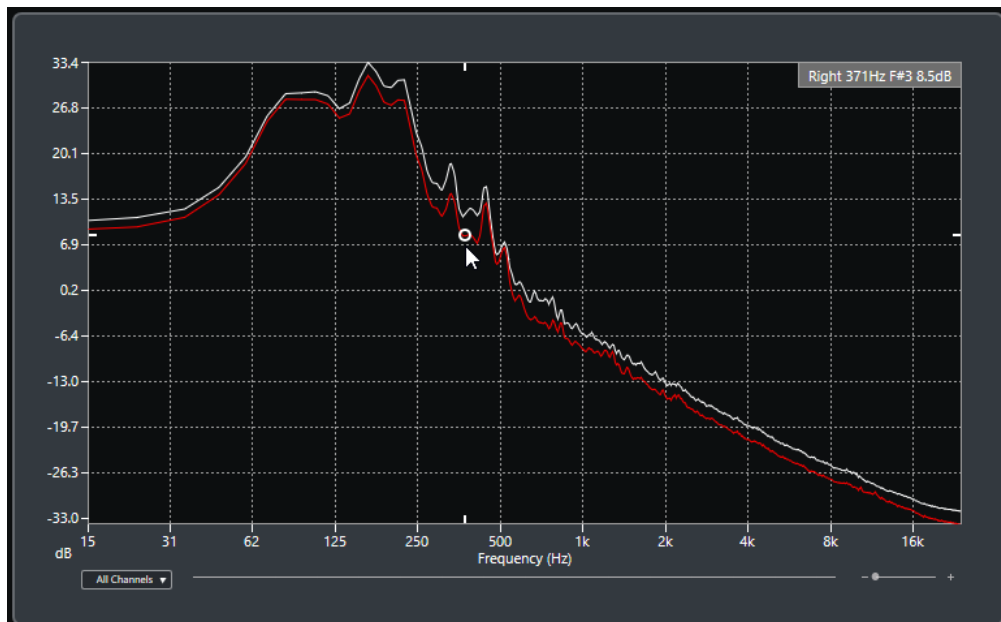

### Frequency display

Shows the frequency graphs for the analyzed audio.

If you move the mouse pointer over a certain position, the channel, frequency, note, and level at that position are shown in the value field at the top of the display.

### Channel selector

For multichannel audio, this pop-up menu allows you to select which channels are shown in the frequency display.

### Zoom slider

Allows you to zoom in and out horizontally.

### RELATED LINKS

[Analyzing the Audio Spectrum](#) on page 410

## Analyzing the Audio Spectrum

The **Spectrum Analyzer** allows you to analyze the audio of a selected event, clip, or selection range.

### PROCEDURE

1. Select an audio event, clip, or a selection range.
2. Select **Audio > Spectrum Analyzer**.

### RESULT

The audio spectrum of the selected event, clip, or selection range is displayed as a two-dimensional graph in the **Spectrum Analyzer** window.

### AFTER COMPLETING THIS TASK

You can display the difference in level between two positions on the same or different graphs.

### RELATED LINKS

[Comparing Level Values](#) on page 411

## Comparing Level Values

You can display the difference in level between two positions on the same or different graphs in the **Spectrum Analyzer** window.

### PROCEDURE

1. Move the mouse pointer to the first position and right-click to select it.
2. Move the mouse pointer to the second frequency position.

### RESULT

The difference in level between the positions is displayed as value **D** in the value field.

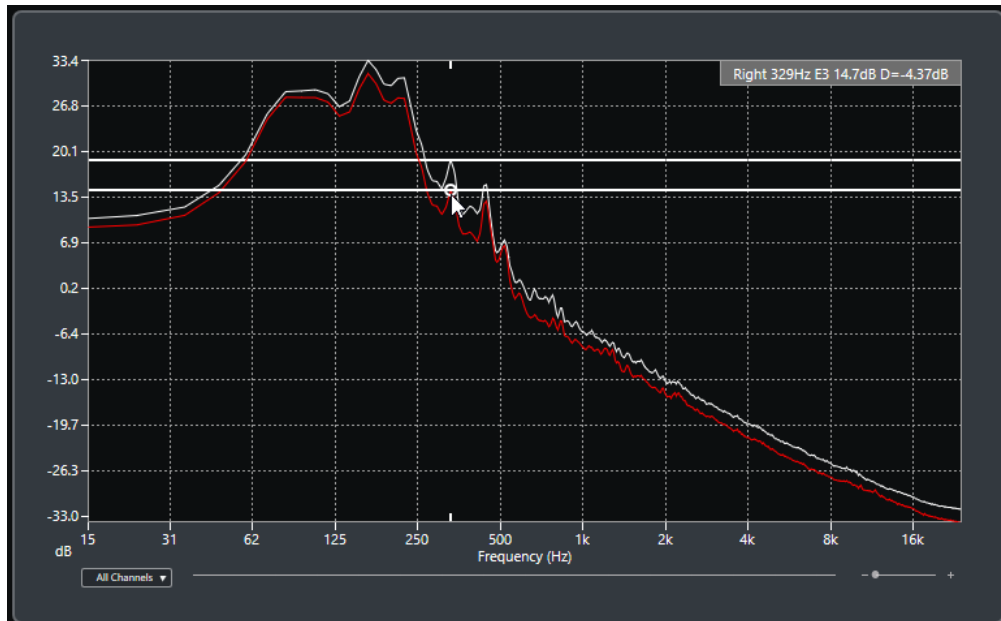

### AFTER COMPLETING THIS TASK

Click the frequency display to reset the selection of the first position.

### RELATED LINKS

[Spectrum Analyzer Window](#) on page 409

## Statistics Window

The **Statistics** function analyzes the selected audio events, clips, or selection ranges.

- To open the **Statistics** window for a selected audio event, clip, or selection range, select **Audio > Statistics**.

Channel	Left	Right
Min. Sample Value	-3.17 dB	-3.17 dB
Max. Sample Value	-3.98 dB	-3.98 dB
Peak Amplitude	-3.17 dB	-3.17 dB
True Peak	-3.17 dB	-3.17 dB
DC Offset	-23.62 %	-23.71 %
	-48.56 dB	-48.56 dB
Bit Depth	24 bit	24 bit
Estimated Pitch	10057.4Hz/D#8	10048.0Hz/D#8
Sample Rate	44.100 kHz	
Average RMS (AES-17)	-19.94 dB	-19.94 dB
Max. RMS	-15.07 dB	-15.07 dB
Max. RMS All Channels	-15.07 dB	

Copy to Clipboard      Close

The **Statistics** window shows the following information:

**Channel**

Shows the name of the analyzed channel.

**Min. Sample Value**

Shows the lowest sample value in dB.

**Max. Sample Value**

Shows the highest sample value in dB.

**Peak Amplitude**

Shows the largest amplitude in dB.

**True Peak**

Shows the maximum absolute level of the audio signal waveform in the continuous time domain.

**DC Offset**

Shows the amount of DC offset as a percentage and in dB.

**Bit Depth**

Shows the current calculated bit depth.

**Estimated Pitch**

Shows the estimated pitch.

**Sample Rate**

Shows the sample rate.

**Average RMS (AES17)**

Shows the average loudness in accordance with the AES17 standard.

**Max. RMS**

Shows the highest RMS value.

**Max. RMS All Channels**

Shows the highest RMS value of all channels.

RELATED LINKS

[Remove DC Offset Option](#) on page 398

# Sample Editor

The **Sample Editor** provides an overview of the selected audio event. It allows you to view and edit audio by cutting and pasting, removing, or drawing audio data, and by processing audio. Editing is non-destructive so that you can undo modifications at any time.

You can open the **Sample Editor** in a separate window or in the lower zone of the **Project** window. This is useful if you want to access the **Sample Editor** functions from within a fixed zone of the **Project** window.

To open an audio event in the **Sample Editor**, do one of the following:

- Double-click an event in the **Project** window.
- Select an event in the **Project** window and press **Return** or **Ctrl/Cmd-E**.
- Select an event in the **Project** window and select **Audio > Open Sample Editor**.
- In the **Key Commands** dialog in the **Editors** category, assign a key command for **Open Sample Editor**. Select an event in the **Project** window and use the key command.

## NOTE

If you select **Audio > Set up Editor Preferences**, the **Preferences** dialog opens on the **Editors** page. Make your changes to specify if you want the **Sample Editor** to open in a separate window or in the lower zone of the **Project** window.

The **Sample Editor** window:

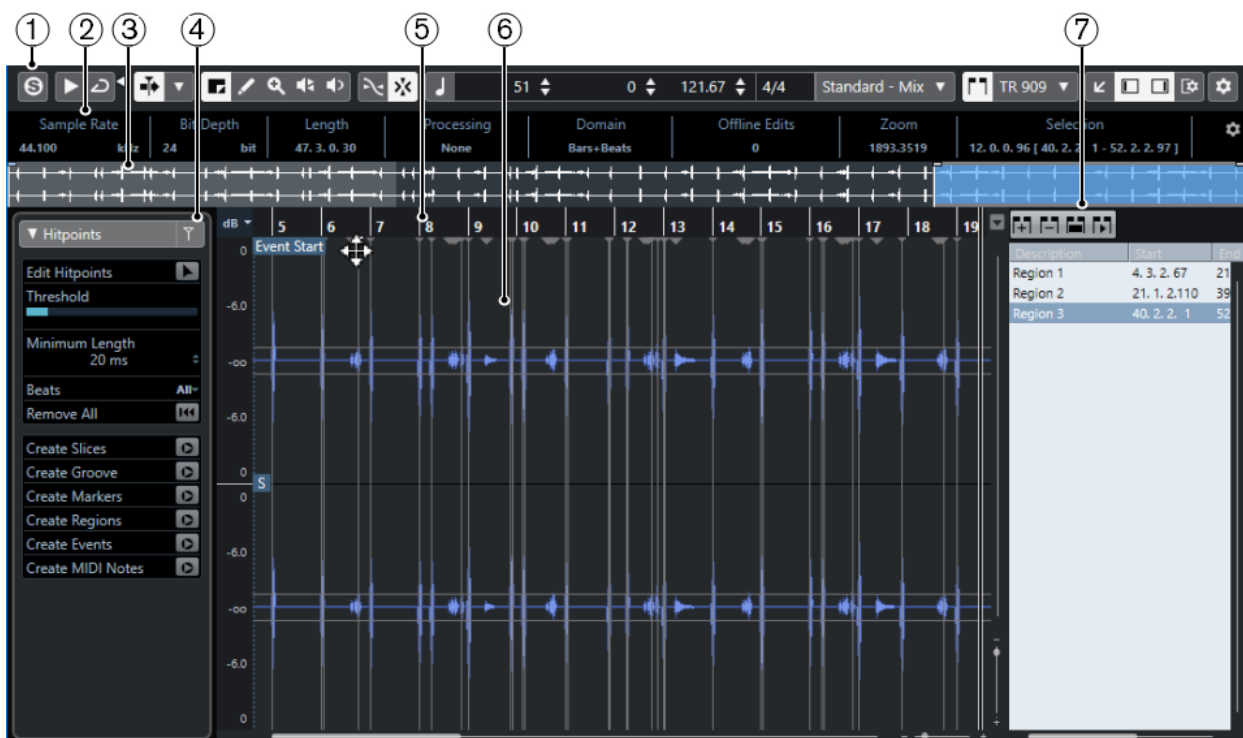

The **Sample Editor** in the lower zone of the **Project** window:

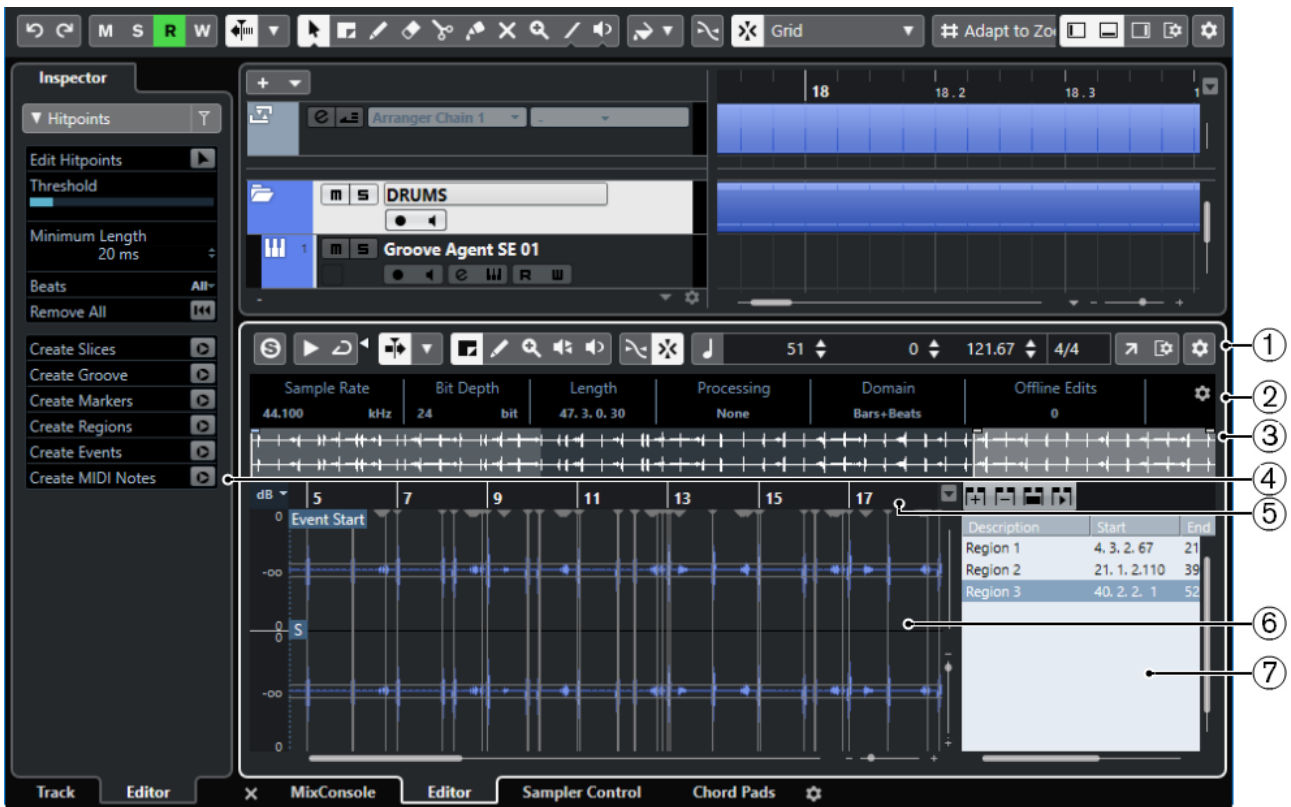

The **Sample Editor** is divided into several sections:

- 1 **Toolbar**  
Contains tools for selecting, manipulating, and playing back audio.
  - 2 **Info Line**  
Shows information about the audio.
  - 3 **Overview**  
Shows an overview of the whole audio clip and indicates which part of the clip is shown in the waveform display.
  - 4 **Inspector**  
Contains audio editing tools and functions.
- NOTE**
- The **Inspector** for the lower zone editor is shown in the left zone of the **Project** window.
- 5 **Ruler**  
Shows the timeline and the display format of the project.
  - 6 **Waveform display**  
Shows the waveform image of the edited audio clip.
  - 7 **Regions**  
Allows you to add and edit regions.

**NOTE**

The info line, the overview line, and the regions can be activated/deactivated by clicking **Set up Window Layout** on the toolbar and activating/deactivating the corresponding options.

#### RELATED LINKS

- [Opening the Editor in the Lower Zone](#) on page 55
- [Opening the Editor Inspector](#) on page 47
- [Sample Editor Toolbar](#) on page 415
- [Info Line](#) on page 419
- [Overview Line](#) on page 419
- [Sample Editor Inspector](#) on page 420
- [Ruler](#) on page 422
- [Waveform Display](#) on page 423
- [Regions List](#) on page 429

## Sample Editor Toolbar

The toolbar contains tools for selecting, editing, and playing back audio.

- To show or hide the toolbar elements, right-click the toolbar and activate or deactivate the elements.

The following options are available:

### Static Buttons

#### Solo Editor



Solos the selected audio during playback.

#### Left Divider

##### Left Divider



Tools that are placed to the left of the divider are always shown.

### View Options

#### Show Audio Event



Highlights the section corresponding to the edited event in the waveform display and the overview line.

#### NOTE

This button is not available if you opened the audio event from the **Pool**. You can adjust the start and end of the event in the clip by dragging the event handles in the waveform display.

#### Currently Edited Audio Event

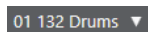

Lists all audio events that are opened in the **Sample Editor**, and allows you to activate an audio event for editing.

### Auto-Scroll

#### Auto-Scroll



Keeps the project cursor visible during playback.

### Select Auto-Scroll Settings



Allows you to activate **Page Scroll** or **Stationary Cursor** and to activate **Suspend Auto-Scroll When Editing**.

### Preview

#### Audition



Plays back the selected audio.

#### Audition Loop



Loops the playback until you deactivate **Audition**.

#### Audition Volume



Allows you to adjust the volume.

### Tool Buttons

#### Range Selection



Selects ranges.

#### Zoom



Zooms in. Hold **Alt** and click to zoom out.

#### Draw



Draws a volume curve.

#### Play



Allows you to play back the clip from the position where you click until you release the mouse button.

#### Scrub



Allows you to locate positions.

### Snap

#### Snap to Zero Crossing



Restricts editing to zero crossings, that is, positions where the amplitude is zero.

#### Snap On/Off



Restricts horizontal movement and positioning to the specific positions.



## Musical Information

### Musical Mode



Locks audio clips to the project tempo by using realtime time stretching.

### Number of Bars Defined in Audio File



Displays the estimated bars of your audio file.

### Remaining Number of Beats Defined in Audio File



Displays the remaining number of beats of your audio file.

### Defined Tempo of Audio File



Displays the estimated tempo of your audio file.

### Defined Time Signature of Audio File



Displays the estimated time signature of your audio file.

### Warping Algorithm for Audio Clip

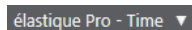

Allows you to select a warp algorithm.

## Right Divider

### Right Divider



Tools that are placed to the right of the divider are always shown.

## Window Zone Controls

### Open in Separate Window



This button is available in the lower zone editor. It opens the editor in a separate window.

### Open in Lower Zone



This button is available in the editor window. It opens the editor in the lower zone of the **Project** window.

### Set up Window Layout



Allows you to set up the window layout.

### Show/Hide Left Zone



Allows you to activate/deactivate the left zone.

### Show/Hide Regions



Allows you to activate/deactivate the regions.

### Set up Toolbar



Opens a pop-up menu where you can set up which toolbar elements are visible.

#### RELATED LINKS

[Auto-Scroll Settings Menu](#) on page 214

[Suspend Auto-Scroll When Editing](#) on page 215

## Locating Positions with the Scrub Tool

The **Scrub** tool allows you to locate positions in the audio.

---

#### PROCEDURE

1. On the toolbar, activate the **Scrub** tool.
  2. Click in the waveform display and keep the mouse button pressed.  
The project cursor moves to the position where you clicked.
  3. Drag to the left or right.
- 

#### RESULT

The audio is played back, and you can hear at which position the cursor is located.

#### NOTE

You can determine the speed and pitch of the playback by dragging faster or slower.

---

## Editing Audio Samples with the Draw Tool

You can edit the audio clip at sample level with the **Draw** tool. This way, you can remove audio clicks manually, for example.

---

#### PROCEDURE

1. On the audio waveform, locate the sample position that you want to edit and zoom in to the highest zoom level.
2. Select the **Draw** tool.

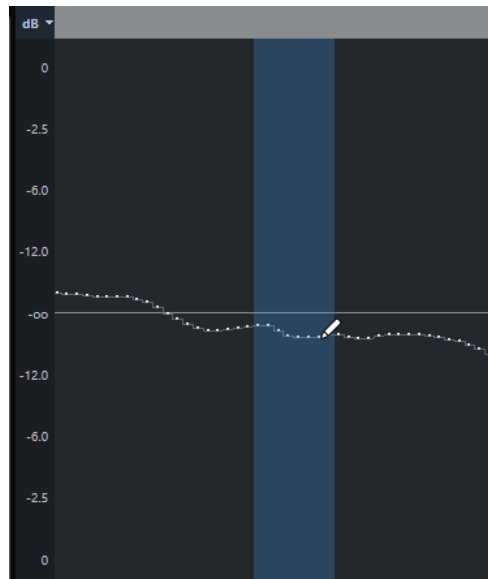

3. Click at the beginning of the section that you want to correct and draw in the new curve.

#### RESULT

A range selection covering the edited section is automatically applied.

## Info Line

The info line shows information about the audio clip, such as the audio format and the selection range.

Sample Rate	Bit Depth	Length	Processing
44.100 kHz	24 bit	47. 3. 0. 30	None
Domain	Offline Edits	Zoom	Selection
Bars+Beats	1	2204.3865	-

- To show or hide the info line, click **Set up Window Layout** on the toolbar and activate or deactivate **Info Line**.  
The on/off status of the info line in the **Sample Editor** window and in the lower zone editor are independent of each other.

#### NOTE

Initially, length and position values are displayed in the format specified in the **Project Setup** dialog.

## Overview Line

The overview line displays the whole clip, and indicates which part of the clip is shown in the waveform display.



- To show or hide the overview line, click **Set up Window Layout** on the toolbar and activate or deactivate the **Overview** option.

The on/off status of the overview line in the **Sample Editor** window and in the lower zone editor are independent of each other.

**1 Event Start**

Shows the start of the audio event if **Show Audio Event** is activated on the toolbar.

**2 Selection**

Shows which section is selected in the waveform display.

**3 Event End**

Shows the end of the audio event if **Show Audio Event** is activated on the toolbar.

**4 Waveform display**

Shows the section of the audio that is displayed in the waveform display.

- You can specify which section of the audio is shown by clicking in the lower half of this display and dragging to the left or right.
- You can zoom in or out horizontally by dragging the left or right edge of this display.
- You can show a different section of the audio by clicking in the upper half of this display and dragging a rectangle.

**5 Snap Point**

Shows the start of the audio event if **Show Audio Event** is activated on the toolbar.

## Sample Editor Inspector

The **Inspector** shows controls and parameters that allow you to edit the audio event that is opened in the **Sample Editor**.

- In the **Sample Editor** window, you can show or hide the **Inspector** by clicking **Set up Window Layout** on the toolbar and activating or deactivating **Inspector**.

NOTE

In the lower zone editor, the **Inspector** is always shown in the left zone of the **Project** window.

- To open or close the **Inspector** sections, click their names.

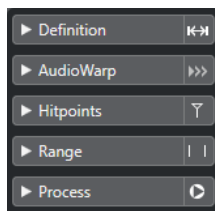

RELATED LINKS

[Opening the Editor Inspector](#) on page 47

## Definition Section

The **Definition** section allows you to adjust the audio grid and define the musical context of your audio. You can use the available functions to match an audio file or audio loop to the project tempo.

- To open the **Definition** section, click its tab in the **Inspector**.

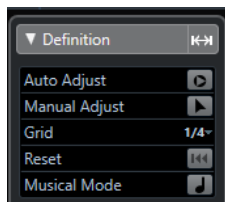

## AudioWarp Section

The **AudioWarp** section allows you to perform timing settings for your audio. This includes applying **Swing** and manually changing the rhythm of the audio by dragging beats to time positions on the grid.

- To open the **AudioWarp** section, click its tab in the **Inspector**.

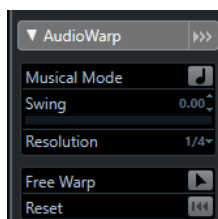

## Hitpoints Section

The **Hitpoints** section allows you to edit hitpoints to slice your audio. Here you can create groove quantize maps, markers, regions, events, and warp markers based on hitpoints.

- To open the **Hitpoints** section, click its tab in the **Inspector**.

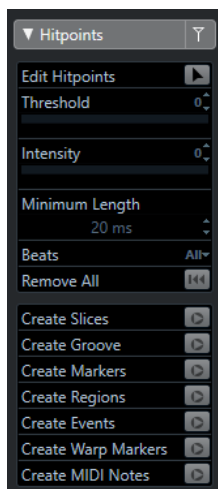

## Range Section

The **Range** section allows you to edit ranges and selections or create a sampler track from the selected range.

- To open the **Range** section, click its tab in the **Inspector**.

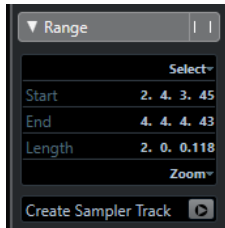

### Select

Opens a menu with functions to select ranges.

### Start

Shows the start position of the selection range.

### End

Shows the end position of the selection range.

### Length

Shows the length of the selection range.

### Zoom

Opens a menu with the zoom functions for ranges.

### Create Sampler Track

Allows you to create a sampler track from the range selection.

## Process Section

The **Process** section regroups the most important audio editing commands from the **Audio** and **Edit** menus.

- To open the **Process** section, click its tab in the **Inspector**.

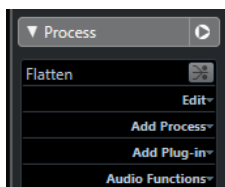

## Ruler

The ruler shows the timeline and display format of the project, the project tempo grid.

The ruler is located above the waveform display. It is always shown.

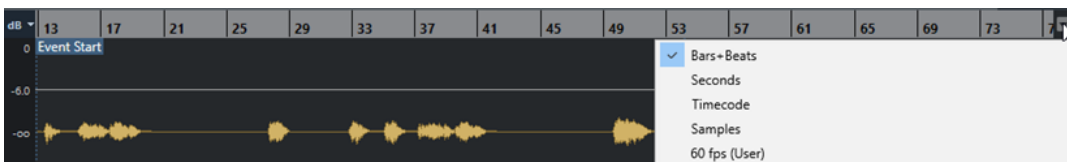

When the **Definition** section is open, an additional ruler is shown below the project tempo grid. It displays the musical structure of the audio file, the audio tempo grid.



## Waveform Display

The waveform display shows the waveform image of the edited audio clip.

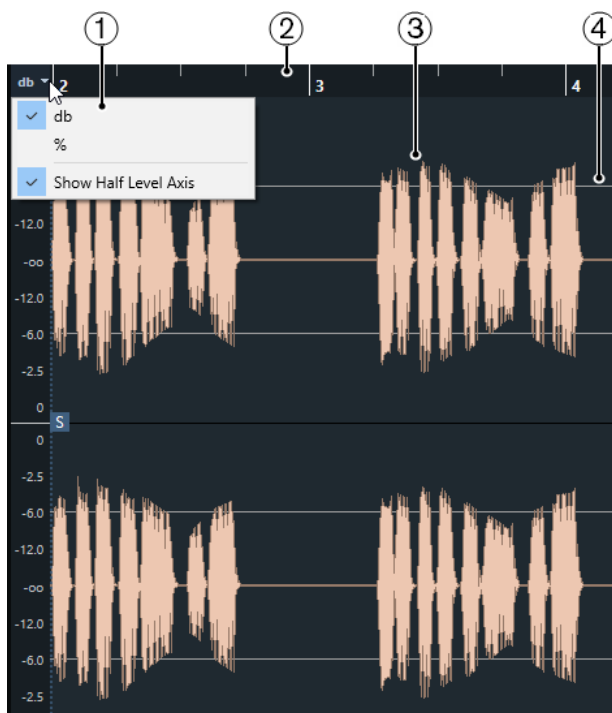

- 1 Level Scale menu**  
Allow you to show the level as a percentage or in dB. Here, you can also activate the display of the half level axis.
- 2 Ruler**  
Shows the project tempo grid.
- 3 Audio waveform**  
Shows the waveform image of the selected audio.
- 4 Half Level Axis**  
To show the half level axis, open the level scale menu and select **Show Half Level Axis**.

### NOTE

You can set up a wave image style in the **Preferences** dialog (**Event Display—Audio** page).

## Zooming Vertically

You can zoom in the waveform vertically. This allows you to see a specific detail of the waveform.

---

### PROCEDURE

- Drag the vertical zoom slider down to zoom in or up to zoom out.



---

### RESULT

The vertical scale changes relative to the height of the **Sample Editor**.

## Zooming Horizontally

You can zoom in the waveform horizontally. This allows you to zoom in or out on the time scale.

---

### PROCEDURE

- Drag the horizontal zoom slider to the right to zoom in or to the left to zoom out.



---

### RESULT

The horizontal zoom setting is shown on the info line as samples per pixel. You can zoom in horizontally to a scale of less than one sample per pixel. This is required for using the **Draw** tool.

### NOTE

- If you have zoomed in to one sample per pixel or less, the appearance of the samples depends on the **Interpolate Audio Waveforms** option in the **Preferences** dialog (**Event Display—Audio** page).

## Zoom Submenu

The **Zoom** submenu of the **Edit** menu contains options for zooming in the **Sample Editor**.

- To open the **Zoom** submenu, select **Edit > Zoom**.

The following options are available:

### Zoom In

Zooms in one step, centering on the project cursor.

### Zoom Out

Zooms out one step, centering on the project cursor.

### Zoom Full

Zooms out so that the whole clip is visible in the waveform display.

### Zoom to Selection

Zooms out so that the whole clip is visible in the waveform display.

### Zoom to Selection (Horiz.)

Zooms in horizontally so that the current selection fills the waveform display.



### Zoom to Event

Zooms in so that the waveform display shows the section of the clip corresponding to the edited audio event. This is not available if you have opened the **Sample Editor** from the **Pool**.

### Zoom In Vertically

Zooms in one step vertically.

### Zoom Out Vertically

Zooms out one step vertically.

### Undo/Redo Zoom

Allows you to undo/redo the last zoom operation.

## Range Editing

In the **Sample Editor** you can edit selection ranges. This option is useful if you want to quickly edit or process a specific section in the audio waveform, or if you want to create a new event or clip.

You can only select one range at a time. The selection is indicated in the **Selection** field on the **Info Line**.

The **Range** section in the **Inspector** contains functions for working with regions.

#### RELATED LINKS

[Range Section](#) on page 421

[Shared Copies](#) on page 185

## Selecting a Range

#### PREREQUISITE

**Snap to Zero Crossing** is activated on the toolbar. This option ensures that the start and the end of the selection are always at zero crossings.

---

#### PROCEDURE

1. On the toolbar, activate the **Range Selection** tool.
2. Click at the position in the waveform display where you want the range to start and drag to the position, where you want the range to end.
3. Optional: Perform one of the following actions to resize the selection range:
  - Drag the left or the right edge of the selection to a new position.
  - Hold down **Shift** and click at a new position.

---

#### RESULT

The selected range is highlighted in the waveform display.

#### NOTE

You can also use the functions in the **Select** menu to select ranges.

---

#### RELATED LINKS

[Select Menu](#) on page 426

## Select Menu

### Select Menu in the Range Section

On the **Select** menu in the **Range** section in the **Sample Editor Inspector**, the following functions are available:

#### Select All

Selects the whole clip.

#### Select None

Deselects everything.

#### Select in Loop

Selects the audio between the left and the right locator.

#### Select Event

Selects only the audio that is included in the edited event.

#### Set Locators to Selection Range

Sets the locators to encompass the current selection. This option is available if you have selected one or several events or made a selection range.

#### Locate Selection

Moves the project cursor to the beginning or end of the current selection. This option is available if you have selected one or several events or made a selection range.

#### Loop Selection

Activates playback from the start of the selection and keeps starting over again at the selection end.

### Select Menu on the Edit Menu

If you select **Edit > Select**, the following functions are available:

#### All

Selects the whole clip.

#### None

Deselects everything.

#### In Loop

Selects the audio between the left and right locator.

#### From Start to Cursor

Selects the audio between the clip start and the project cursor.

#### From Cursor to End

Selects the audio between the project cursor and the clip end. This option is available if the project cursor is positioned between the clip boundaries.

#### Select Event

Selects the event.

#### Left Selection Side to Cursor

Moves the left side of the selection range to the project cursor position. This option is available if the project cursor is positioned between the clip boundaries.

### Right Selection Side to Cursor

Moves the right side of the selection range to the project cursor position or the end of the clip if the project cursor is positioned to the right of the clip.

## Creating Events from Selection Ranges

You can create a new event that contains only the selected range.

---

### PROCEDURE

1. Select a range.
  2. Drag the selection range to an audio track in the **Project** window.
- 

### RELATED LINKS

[Selecting a Range](#) on page 425

## Creating Clips from Selection Ranges

You can create a new clip that contains only the selected range.

---

### PROCEDURE

1. Select a range.
  2. Click the selected range and select **Audio > Bounce Selection**.
  3. Perform one of the following actions:
    - Click **Replace** if you want to replace the original.
    - Click **No** if you want to keep the original.
- 

### RESULT

A new **Sample Editor** window opens with the new clip. It refers to the same audio file as the original clip, but it contains the audio corresponding to the selection range only.

## Creating Sampler Tracks from Selection Ranges

You can create a sampler track that contains only the selected range.

---

### PROCEDURE

1. Select a range.  
If you select no range, the event start/end is used.
  2. Open the **Range** section in the **Inspector**.
  3. Click **Create Sampler Track**.
- 

### RESULT

A new **Sampler Track** is created and added to the track list. The new sampler track contains your range selection.

## Edit Menu for Selection Ranges

You can edit selection ranges.

- To edit a selection range, open the **Process** section in the **Sample Editor Inspector**, and select one of the **Edit** menu functions.

#### NOTE

If you edit ranges of events that are shared copies, you are asked whether you want to create a new version of the clip. Select **New Version** if you want to edit the event, select **Continue** if all shared copies should be edited.

---

The following options are available:

#### Cut

Cuts the selected range from the clip and saves it in the clipboard. The section to the right of the range is moved to the left to fill the gap.

#### Copy

Copies the selected range to the clipboard.

#### Paste

Replaces the selected range with the data from the clipboard.

#### Delete

Removes the selected range from the clip. The section to the right of the range is moved to the left to fill the gap.

#### Insert Silence

Inserts a silent section with the same length as the current range selection at the selection start. The selected range is not replaced, but moved to the right.

#### Event or Range as Region

Creates a region from the selected range.

#### Make Direct Offline Processing Permanent

Allows you to apply all offline processing permanently to the audio.

#### RELATED LINKS

[Shared Copies](#) on page 185

[Applying Offline Processing Permanently](#) on page 392

## Direct Offline Processing for Ranges

You can apply audio processes to selection ranges.

- To apply an audio process to a selection range, open the **Process** section in the **Sample Editor Inspector**, and select one of the options in the **Add Process** menu.

#### NOTE

If you apply offline processing to ranges of events that are shared copies, you are asked whether you want to create a new version of the clip. Select **New Version** if you want to edit the event, select **Continue** if all shared copies should be edited.

---

#### RELATED LINKS

[Direct Offline Processing](#) on page 386

[Applying Processing](#) on page 389

[Shared Copies](#) on page 185

## Regions List

Regions are sections within an audio clip that allow you to mark important sections in the audio. You can add and edit regions for the selected audio clip in the regions zone.

- To show or hide the **Regions**, click **Set up Window Layout** on the toolbar and activate or deactivate **Regions**.



The following controls are available:

- 1 Region Start/Region End**  
Shows the start and end of the region in the audio waveform.
- 2 Add Region**  
Allows you to create a region of the current range selection.
- 3 Remove Region**  
Allows you to remove the selected region.
- 4 Select Region**  
If you select a region in the list and click this button above, the corresponding section of the audio clip is selected (as if you had selected it with the **Range Selection** tool) and zoomed. This is useful if you want to apply processing to the region only.
- 5 Play Region**  
Plays back the selected region.
- 6 Regions list**  
Allows you to select and display regions in the audio waveform.

## Creating Regions

### PREREQUISITE

You have clicked **Set up Window Layout** on the toolbar and activated **Regions**.

### PROCEDURE

1. On the **Sample Editor** toolbar, activate the **Range Selection** tool and in the waveform display, select the range that you want to convert into a region.
2. Perform one of the following actions:
  - Above the regions list, click **Add Region**.
  - Select **Audio > Advanced > Event or Range as Region**.

A region is created, corresponding to the selected range.

3. Optional: Double-click the region name in the list and enter a new name.
- 

#### RESULT

The region is added to the regions list.

#### AFTER COMPLETING THIS TASK

Click the region in the regions list to instantly display it in the **Sample Editor**.

#### RELATED LINKS

[Creating Regions](#) on page 440

## Creating Regions from Hitpoints

You can create regions from hitpoints. This is useful to isolate specific sounds.

#### PREREQUISITE

The audio event from which you want to create regions is opened in the **Sample Editor** and the hitpoints are set at the correct positions.

---

#### PROCEDURE

- In the **Hitpoints** section of the **Inspector**, click **Create Regions**.
- 

#### RESULT

Regions are created between two hitpoint positions and shown in the **Sample Editor**.

## Adjusting Start and End Positions of Regions

#### PREREQUISITE

You have clicked **Set up Window Layout** on the toolbar and activated **Regions**. You have created regions.

---

#### PROCEDURE

- Perform one of the following actions:
  - Drag the **Region Start** or **Region End** handle to a different position in the waveform display.
  - Double-click the **Start** or **End** field in the regions list and enter a new value.

#### NOTE

The positions are shown in the display format selected for the ruler and info line, but are relative to the start of the audio clip.

---

## Removing Regions

#### PREREQUISITE

You have clicked **Set up Window Layout** on the toolbar and activated **Regions**. You have created regions.

---

#### PROCEDURE

1. In the regions list, select the region that you want to remove.

2. Above the regions list, click **Remove Region**.
- 

RESULT

The region is removed from the regions list.

## Creating Audio Events from Regions

You can create new audio events from regions using drag and drop.

PREREQUISITE

You have clicked **Set up Window Layout** on the toolbar and activated **Regions**. You have created regions.

---

PROCEDURE

1. Select the region in the regions list.
  2. Drag the region to the desired position in the **Project** window.
- 

RESULT

An event is created from the region.

## Snap Point

The snap point is a marker within an audio event that can be used as a reference position.

- To show the snap point, activate **Show Audio Event** on the toolbar.

The snap point is set at the audio event start, but you can move it to another relevant position in the audio.

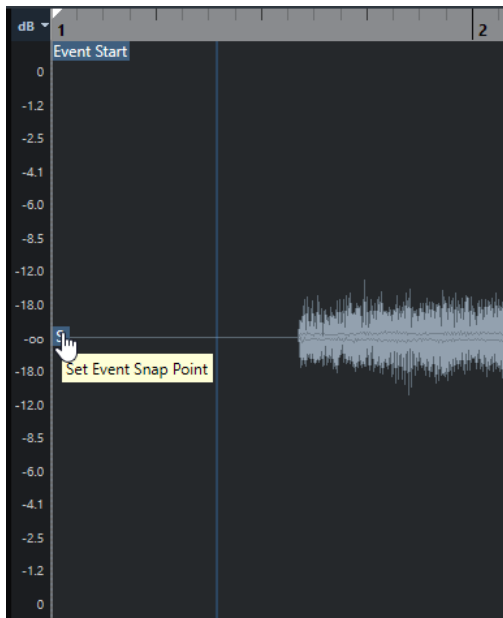

The snap point is used when **Snap** is activated and you insert a clip from the **Sample Editor** in the event display. It is also used when you move or copy events in the event display.

In the **Sample Editor**, you can edit the following snap points:

- Event Snap Point  
This is shown in the **Sample Editor** if you open a clip from within the **Project** window.

- **Clip Snap Point**  
This is shown in the **Sample Editor** if you open a clip from the **Pool**.

#### NOTE

The clip snap point serves as a template for the event snap point. However, it is the event snap point that is taken into account when snapping.

---

#### IMPORTANT

When you set the grid start in the **Definition** section, the snap point is moved to the grid start.

---

#### RELATED LINKS

[Sample Editor Toolbar](#) on page 415

## Adjusting the Snap Point

#### PREREQUISITE

The audio event is opened in the **Sample Editor** and **Show Audio Event** is activated on the toolbar.

---

#### PROCEDURE

1. Optional: On the **Sample Editor** toolbar, select the **Scrub** tool.  
This allows you to audition the audio while setting the snap point.
  2. Move the mouse pointer over the snap point, and drag it to the desired position in the audio event.  
The mouse pointer becomes a hand symbol and a tooltip indicates that you can set the snap point.
- 

#### RESULT

The event snap point is adjusted to the position where you dragged it.

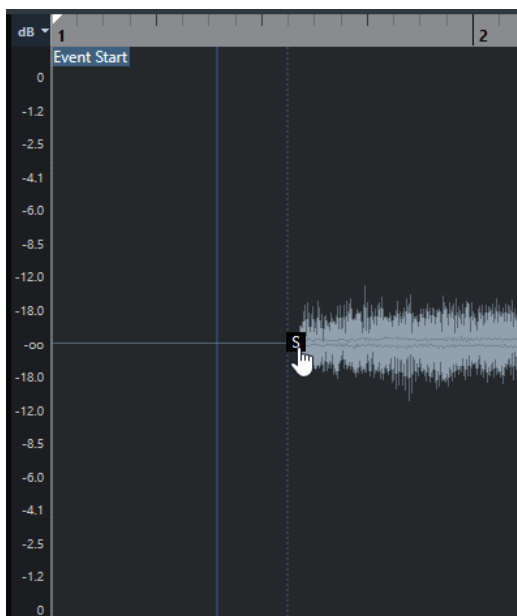



NOTE

You can also adjust the snap point by setting the project cursor at the desired position and selecting **Audio > Snap Point to Cursor**.

---

# Hitpoints

Hitpoints mark musically relevant positions in audio files. Cubase can detect these positions and create hitpoints automatically by analyzing onsets and melodic changes of the audio.

## NOTE

All hitpoint operations can be performed in the **Sample Editor** window and in the lower zone editor.

When you add an audio file to your project by recording or by importing, Cubase automatically detects hitpoints. In the **Project** window, hitpoints are shown for the selected event, provided that the zoom factor is high enough.

The hitpoint functions are available in the **Hitpoints** section of the **Sample Editor**.

You can use hitpoints for the following purposes:

- Create slices of the audio  
Slices allow you to change tempo and timing of the audio without affecting its pitch and quality, or to replace or extract individual sounds from loops.
- Quantize audio
- Extract the groove from the audio  
The timing is extracted from the audio and a groove map is created. You can use this groove map to quantize other events.
- Create markers from the audio
- Create regions from the audio
- Create events from the audio
- Create warp markers from the audio
- Create MIDI notes from the audio

## NOTE

Hitpoints work best with drums, rhythmic recordings, or loops.

## Calculating Hitpoints

When you add an audio file to your project by recording or by importing, Cubase automatically detects hitpoints.

### PROCEDURE

1. Import or record an audio file.  
Cubase automatically detects hitpoints.

**NOTE**

If your audio file is very long, this may take a while.

2. Select the audio event in the **Project** window and make sure the zoom factor is high enough.

**RESULT**

The calculated hitpoints for the selected event are shown in the **Project** window.

**NOTE**

You can disable automatic hitpoint detection by deactivating **Enable Automatic Hitpoint Detection** in the **Preferences** dialog (**Editing—Audio** page).

## Hitpoint Filters in the Hitpoint Section

Cubase automatically detects and filters hitpoints. However, if the result does not meet your expectations you can filter hitpoints manually.

- To filter hitpoints, open the audio event in the **Sample Editor** and open the **Hitpoints** section.

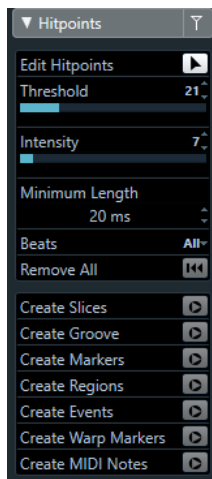

### Threshold

Filters hitpoints by their peaks. Drag the slider to the right to discard hitpoints of quieter crosstalk signals, for example.

### Intensity

Filters hitpoints by their intensity. Drag the slider to the right to discard less intense hitpoints.

### Minimum Length

Filters hitpoints by their distance between two hitpoints. This option allows you to avoid creating slices that are too short.

### Beats

Filters hitpoints by their musical position. This option allows you to discard hitpoints that do not fit within a certain range of a defined beat value.

## Editing Hitpoints Manually

It is absolutely crucial for any further editing that the hitpoints are set at the correct positions. Therefore, if the automatic hitpoint detection does not meet your expectations, you can edit hitpoints manually.

### PREREQUISITE

The audio event is opened in the **Sample Editor**, and in the **Hitpoints** section, hitpoints are filtered by their peak and/or intensity, by their distance, or by their musical position.

---

### PROCEDURE

1. In the **Hitpoints** section in the **Inspector**, activate the **Edit Hitpoints** tool.

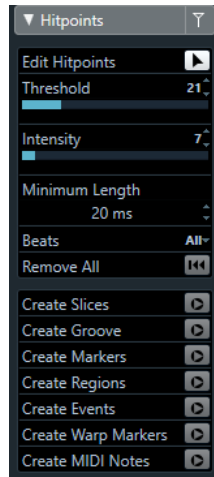

2. Move the mouse to the waveform display and click between two hitpoints. The mouse pointer changes to a speaker icon and the tooltip **Play back Slice** is shown. The slice is played back from the beginning to the end.

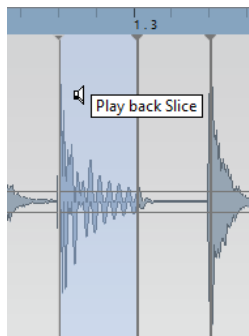

3. To disable a hitpoint that you do not need, press **Shift** and click on the line that represents the hitpoint. The mouse pointer changes to a cross icon and the tooltip **Disable Hitpoints** is shown. Disabled hitpoints are not taken into account for further operations.

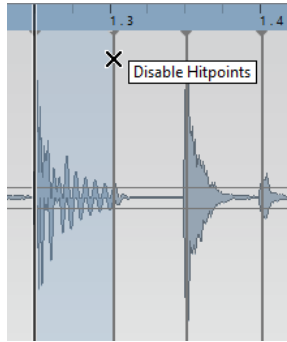

4. Press **Tab** to navigate to the next slice.  
The slice is played back automatically.
5. To insert a hitpoint, press **Alt** and click at the position where you want to insert the hitpoint.  
The mouse pointer changes to a draw icon and the tooltip **Insert Hitpoint** is shown.
6. To move a hitpoint, move the mouse pointer on the vertical line that represents the hitpoint, and drag to the left or to the right.  
The mouse pointer changes to a double arrow and the tooltip **Move Hitpoint** is shown. Moved hitpoints are locked by default.
7. To make sure that a hitpoint is not accidentally filtered out, lock it by pointing at it and clicking.  
The tooltip **Lock Hitpoint** is shown.

---

#### RESULT

The hitpoints are edited according to your settings.

#### NOTE

To reset a hitpoint to its original state, press **Ctrl/Cmd-Alt** until the tooltip **Enable/Unlock Hitpoints** is shown and click.

---

#### RELATED LINKS

[Hitpoint Filters in the Hitpoint Section](#) on page 435

## Locating to Hitpoints in the Project Window

You can navigate through the hitpoints of an audio event in the **Project** window.

#### PREREQUISITE

**Enable Automatic Hitpoint Detection** is activated in the **Preferences** dialog (**Editing—Audio** page).

---

#### PROCEDURE

1. Select the audio track that contains the audio event for which you want to locate hitpoints.
2. Perform one of the following actions:
  - Press **Alt-N** to navigate to the next hitpoint.
  - Press **Alt-B** to navigate to the previous hitpoint.

---

#### RESULT

The project cursor jumps to the respective hitpoint.

## Slices

You can create slices from hitpoints, where each slice ideally represents an individual sound or beat of the audio.

You can use these slices to change tempo and timing of the audio without affecting its pitch and quality.

### NOTE

Slices are created in the **Sample Editor** and edited in the **Audio Part Editor**.

---

Audio that meets the following characteristics is suitable:

- Individual sounds have a noticeable attack.
- The recording quality is good.
- The recording is free of crosstalk signals.
- The audio is free of smearing effects like delays, for example.

## Slicing Audio

Slicing audio is useful if you want to change tempo and timing of the audio without affecting its pitch and quality.

### PREREQUISITE

The audio event is opened in the **Sample Editor** and the hitpoints are set at the correct positions.

### NOTE

When slicing audio, all events referring to the edited clip are also replaced.

---

### PROCEDURE

- Perform one of the following actions:
    - In the **Hitpoints** section in the **Inspector**, click **Create Slices**.
    - Select **Audio > Hitpoints > Create Audio Slices from Hitpoints**.
- 

### RESULT

The areas between the hitpoints are sliced and become separate events. The original audio event is replaced by an audio part containing the slices.

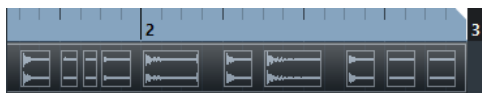

On playback, the audio plays back seamlessly at the project tempo.

### AFTER COMPLETING THIS TASK

Change the project tempo. The slices are moved accordingly, keeping their relative positions within the part.

Double-click the sliced audio part and replace or extract individual slices in the **Audio Part Editor**.

### RELATED LINKS

[Slices and the Project Tempo](#) on page 439

[Audio Part Editor](#) on page 452

## Slices and the Project Tempo

The project tempo affects how the sliced audio is played back.

### RELATED LINKS

[Closing Gaps](#) on page 439

[Deleting Overlaps](#) on page 439

[Musical Mode](#) on page 444

[Making Global Auto Fade Settings](#) on page 281

[Making Auto Fade Settings for Individual Tracks](#) on page 281

## Closing Gaps

If the project tempo is slower than the tempo of the original audio event, there may be audible gaps between the slice events in the part. You can close these gaps so that the audio plays without any breaks.

---

### PROCEDURE

- Do one of the following:
  - Select **Audio > Advanced > Close Gaps (Time Stretch)** to apply time stretch to each slice and close the gaps.  
Consider activating auto fades for the corresponding audio track, and setting the fade-out to 10 ms to eliminate clicks.
  - Select **Audio > Advanced > Close Gaps (Crossfade)** to apply crossfades to the slices and close the gaps.

---

### AFTER COMPLETING THIS TASK

#### NOTE

If you decide to change the tempo again, undo your actions and use the original, unstretched file.

---

## Deleting Overlaps

If the project tempo is higher than the tempo of the original audio event, the slice events in the part may overlap. You can delete these overlaps.

---

### PROCEDURE

1. Right-click the track in the track list and from the context menu, select **Auto Fades Settings**.
  2. In the **Auto Fades** dialog, activate **Auto Crossfades**.
  3. Click **OK**.
  4. Select the overlapping events in the part and select **Audio > Advanced > Delete Overlaps**.
- 

### RESULT

The sound is smoothed out.

## Creating a Groove Quantize Map

You can use hitpoints to create a groove quantize map.

### PREREQUISITE

The audio event from which you want to extract the timing is opened in the **Sample Editor**, and the hitpoints are set at the correct positions.

---

### PROCEDURE

- In the **Hitpoints** section in the **Inspector**, click **Create Groove**.

---

### RESULT

The groove is extracted from the audio event and automatically selected in the **Quantize Presets** pop-up menu on the **Project** window toolbar.

### AFTER COMPLETING THIS TASK

Open the **Quantize Panel** and save the groove as a preset.

## Creating Markers

You can create markers at hitpoint positions. This allows you to snap to hitpoint positions.

### PREREQUISITE

The audio event from which you want to create markers is opened in the **Sample Editor**, and the hitpoints are set at the correct positions.

---

### PROCEDURE

- In the **Hitpoints** section in the **Inspector**, click **Create Markers**.

---

### RESULT

If your project has no marker track, a marker track is added and activated automatically, and a marker is created at every hitpoint position.

### RELATED LINKS

[Markers](#) on page 300

## Creating Regions

You can create regions at hitpoint positions. This allows you to isolate recorded sounds.

### PREREQUISITE

The audio event from which you want to create regions is opened in the **Sample Editor**, and the hitpoints are set at the correct positions.

---

### PROCEDURE

- In the **Hitpoints** section in the **Inspector**, click **Create Regions**.

---

### RESULT

Regions are created between two hitpoint positions and shown in the **Sample Editor**.

### RELATED LINKS

[Creating Regions](#) on page 429



## Creating Events

You can create events at hitpoint positions.

### PREREQUISITE

The audio event from which you want to create events is opened in the **Sample Editor**, and the hitpoints are set at the correct positions.

---

### PROCEDURE

- In the **Hitpoints** section in the **Inspector**, click **Create Events**.
- 

### RESULT

Events are created between two hitpoint positions.

## Creating Warp Markers

You can create warp markers at hitpoint positions. This allows you to quantize audio based on hitpoint positions.

### PREREQUISITE

The audio event from which you want to create warp markers is opened in the **Sample Editor**, and the hitpoints are set at the correct positions.

---

### PROCEDURE

- In the **Hitpoints** section in the **Inspector**, click **Create Warp Markers**.
- 

### RESULT

Warp markers are created at every hitpoint position.

### AFTER COMPLETING THIS TASK

Open the **AudioWarp** section to show and edit the warp markers.

### RELATED LINKS

[Tempo Matching Audio](#) on page 443

## Creating MIDI Notes

You can create MIDI notes from hitpoints. This allows you to double, replace, or enrich drum hits by triggering sounds of a VST instrument.

### PREREQUISITE

The audio event from which you want to create MIDI notes is opened in the **Sample Editor**, and the hitpoints are set at the correct positions.

---

### PROCEDURE

1. In the **Hitpoints** section in the **Inspector**, click **Create MIDI Notes**.
  2. In the **Convert Hitpoints to MIDI Notes** dialog, set up the parameters.
  3. Click **OK**.
- 

### RESULT

A MIDI track is added to your project, and MIDI notes are created at every hitpoint position.

AFTER COMPLETING THIS TASK

Assign a VST instrument to the MIDI track, and select a sound to enrich the audio.

## Convert Hitpoints to MIDI Notes Dialog

The **Convert Hitpoints to MIDI Notes** dialog allows you to specify how hitpoints should be converted when you create MIDI notes from hitpoints.

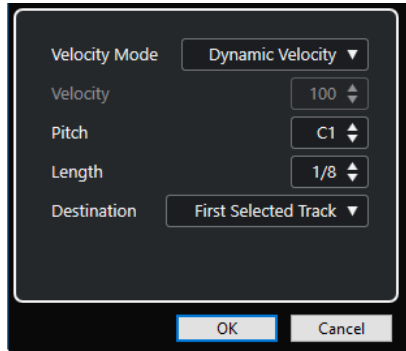

The following options are available:

### Velocity Mode

Allows you to select a velocity mode:

- If you want the velocity values of the created MIDI notes to vary according to the peak levels of the corresponding hitpoints, select **Dynamic Velocity**.
- If you want to assign the same velocity value to all created MIDI notes, select **Fixed Velocity**.

### Velocity

Sets the **Fixed Velocity**.

### Pitch

Sets a note pitch for all created MIDI notes.

### Length

Sets a note length for all created MIDI notes.

### Destination

Allows you to select a destination:

- To place the MIDI part on the first selected MIDI or instrument track, select **First Selected Track**.

#### NOTE

Any MIDI parts from previous conversions on this track will be deleted.

- To create a new MIDI track for the MIDI part, select **New MIDI Track**.
- To copy the MIDI part to the clipboard, select **Project Clipboard**.

# Tempo Matching Audio

Cubase offers several functions that allow you to match the tempo of audio in your project.

In the **Sample Editor** window and in the lower zone editor, you can perform the following tempo matching operations:

- **Stretch to Project Tempo**  
Stretches the selected event to match the project tempo.
- **Musical Mode**  
Applies realtime time stretching to audio clips, so that they match the project tempo.
- **Auto Adjust**  
Extracts a definition grid from your audio. After that, you can match the audio with the project tempo by using **Musical Mode**.
- **Manual Adjust**  
Allows you to manually modify the grid and tempo of your audio file. After that, you can match the audio with the project tempo by using **Musical Mode**.
- **Free Warp**  
Allows you to change the timing of individual positions in your audio.

## RELATED LINKS

[Stretching Audio Events to the Project Tempo](#) on page 444

[Musical Mode](#) on page 444

[Auto Adjust](#) on page 446

[Manual Adjust](#) on page 446

[Free Warp](#) on page 448

## Algorithm Presets

You can select an algorithm preset that is applied for realtime playback and time stretching.

The **Warping Algorithm for Audio Clip** pop-up menu on the **Sample Editor** toolbar contains various presets that determine the audio quality of the realtime time stretching.

These presets are sorted into the categories **élastique** and **Standard** according to the technology used.

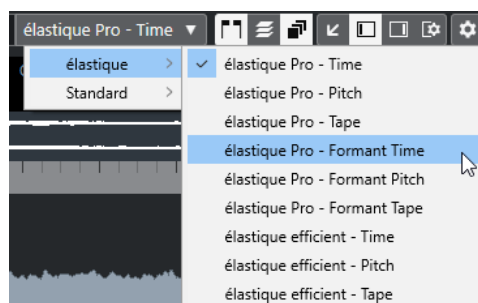

The algorithm preset affects warp changes in **Musical Mode**, **FreeWarp**, and **Swing**.

RELATED LINKS

[Algorithm Presets](#) on page 443

[Time Stretch and Pitch Shift Algorithms](#) on page 403

## Stretching Audio Events to the Project Tempo

You can stretch audio loops to the project tempo.

---

PROCEDURE

1. Select **File > Import > Audio File**, select the audio loop that you want to import, and click **OK**.
2. Select the audio loop in the project.
3. Select **Audio > Advanced > Stretch to Project Tempo**.

---

RESULT

The audio loop is stretched to match the project tempo.

## Musical Mode

The **Musical Mode** allows you to tempo-match audio loops to the project tempo.

If you activate **Musical Mode** for an audio clip, realtime time stretching is applied to the clip so that it matches the project tempo. The audio events adapt to any tempo changes in Cubase, just like MIDI events.

In the **Sample Editor**, you can activate **Musical Mode** in the **AudioWarp** section, the **Definition** section, and the toolbar.

NOTE

- You can also activate/deactivate **Musical Mode** from within the **Pool** by clicking the corresponding checkbox in the **Musical Mode** column.
- Cubase supports ACID® loops. These loops are standard audio files but with embedded tempo/length information. When ACID® files are imported into Cubase, **Musical Mode** is automatically activated and the loops will adapt to the project tempo.

## Matching Audio to the Project Tempo

You can use **Musical Mode** to adjust audio loops to the project tempo. Loops are short audio files that have a defined number of bars.

---

PROCEDURE

1. Select **File > Import > Audio File**, and select an audio loop in the file dialog.
2. In the **Project** window, double-click the imported audio loop to open it in the **Sample Editor**.
3. Open the **Definition** section and verify the rulers.  
The project tempo grid shown in the upper ruler and the grid of your audio shown in the lower ruler do not match.



4. On the toolbar, verify that the length in bars corresponds to the length of the imported audio file. If necessary, listen to your audio and enter the correct length in bars and beats.
  5. On the toolbar, open the **Algorithm** pop-up menu, and select a preset.
  6. Listen to the loop and if necessary correct the **Bars** and **Beats** values on the toolbar.
  7. Activate **Musical Mode**.
- 

#### RESULT

The loop is warped and stretched to the project tempo. The rulers reflect the change.

In the **Project** window, the audio event shows a note symbol and a warp symbol. This indicates that time stretching has been applied.

#### RELATED LINKS

[Algorithm Presets](#) on page 443

## Applying Swing

The **Swing** function allows you to add swing to audio that sounds too straight.

#### PREREQUISITE

You have opened your audio in the **Sample Editor**, and **Musical Mode** is activated.

---

#### PROCEDURE

1. On the toolbar, open the **Algorithm** pop-up menu, and select a preset.
2. Open the **AudioWarp** section, and from the **Resolution** pop-up menu select a grid resolution.

This defines the positions that the swing is applied to. If you select **1/2**, the swing is applied in steps of half notes, for example.



3. Move the **Swing** fader to the right.
-

#### RESULT

This offsets the grid positions and creates a swing or shuffle feel. If you selected **1/2**, every second position in the grid is offset.

## Auto Adjust

The **Auto Adjust** function is useful if you do not know the tempo of your audio file, or if the beat is not straight. It allows you to extract a definition grid from your audio. After that, you can tempo match the file to the project tempo with the **Musical Mode**.

The **Auto Adjust** function extracts a local definition grid that you can match with the project tempo using **Musical Mode**.

#### RELATED LINKS

[Musical Mode](#) on page 444

## Extracting a Tempo Definition Grid from Audio

If you have an audio file with an unknown tempo or a beat that is not straight, and you want to match it to the project tempo, you must first extract its tempo definition grid. This is done with the **Auto Adjust** function in the **Definition** section of the **Sample Editor**.

#### PREREQUISITE

You have defined a range in your audio clip or event that starts and ends at a barline.

---

#### PROCEDURE

1. Double-click the audio clip or event in the **Project** window to open it in the **Sample Editor**.
2. Open the **Definition** section, and select a value from the **Grid** pop-up menu. This determines the grid resolution for your audio.
3. With the **Range Selection** tool, select the section that you want to use in your project, and that covers one or several bars.

#### NOTE

If you do not select a range, the grid is calculated for the audio event. If no audio event is defined, the grid is calculated for the clip. Make sure that the event or clip starts and ends on a barline.

4. Click **Auto Adjust**.

---

#### RESULT

The definition grid is calculated for the selected section. The snap point moves to the start of the selected range. The audio tempo definition ruler changes to reflect your edits, and bars and beats positions are marked with vertical lines.

## Manual Adjust

The **Manual Adjust** function is useful if you need to manually modify the grid and tempo of your audio file. This is the case if the extraction of a definition grid with the **Auto Adjust** function did not bring satisfying results, for example.

The **Manual Adjust** function allows you to correct the local definition grid. After this, you can match it with the project tempo using **Musical Mode**.

RELATED LINKS

[Musical Mode](#) on page 444

## Correcting the Audio Definition Grid

If the extraction of a definition grid with the **Auto Adjust** function did not bring satisfying results, you can correct the grid and tempo of your audio file with the **Manual Adjust** function.

---

### PROCEDURE

1. Double-click the audio clip or event in the **Project** window to open it in the **Sample Editor**.
2. Open the **Definition** section, and activate **Manual Adjust**.
3. Move the mouse pointer to the beginning of the audio clip.  
The tooltip **Set Grid Start** is shown, and the mouse pointer turns into a double arrow.

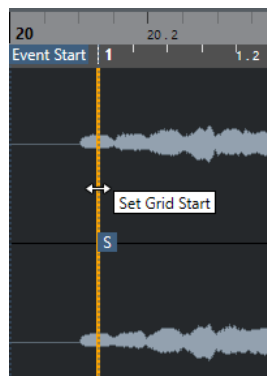

4. Click and drag to the right until the first downbeat and release the mouse button.  
This matches the grid start and the snap point with the first main beat. The audio tempo definition ruler changes to reflect your edits.
5. In the upper part of the waveform, move the mouse pointer to the vertical line nearest to the second bar.  
The tooltip **Stretch Grid** and a blue vertical line are shown.
6. Click and drag to the position of the first downbeat in the second bar and release the mouse button.  
This sets the beginning of the next bar. All following bar positions in the grid are stretched or compressed so that all bars have the same length.

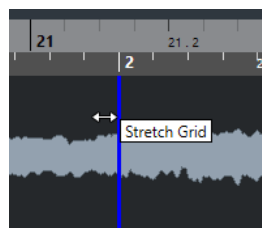

7. In the lower part of the waveform, move the mouse pointer over the grid lines.  
The tooltip **Set Bar Position (Move Following Bars)** and a green vertical line are shown.
8. For incorrect bar positions, click and drag the green vertical line to the position of the first downbeat of the following bar and release the mouse button.  
This also moves the bars to the right. The area to the left remains unaffected.

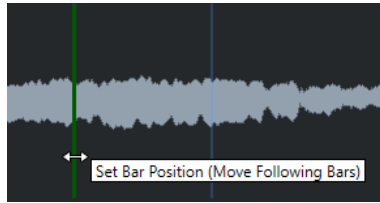

9. Move the mouse pointer over the grid lines for single beats.  
The tooltip **Set Beat Position** and a blue vertical line are shown.
10. Click and drag the grid line to align single, incorrect beat positions and release the mouse button.

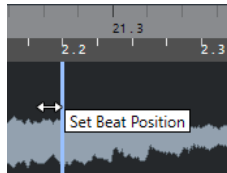

**NOTE**

You can remove misplaced beat edits by pressing any modifier key and clicking with the **Erase** tool.

---

**RESULT**

The definition grid is corrected, the audio tempo definition ruler reflects your edits.

**AFTER COMPLETING THIS TASK**

Activate **Musical Mode**.

## Free Warp

The **Free Warp** tool allows you to correct the timing of individual positions in the audio material.

You can create and edit warp markers and drag them to musically relevant time positions in an audio event. This way, the audio before and after the warp marker is stretched. The amount of stretch is shown next to the warp marker handle.



A stretch factor higher than 1.0 indicates that the audio preceding the warp marker is stretched, a stretch factor lower than 1.0 indicates that the audio is compressed.

**NOTE**

The **Free Warp** tool snaps to hitpoint positions and warp markers.

---



## Correcting the Timing with the Free Warp Tool

---

### PROCEDURE

1. Double-click the audio clip or event in the **Project** window to open it in the **Sample Editor**.
  2. On the toolbar, activate **Snap to Zero Crossing**.  
If this button is activated, warp markers snap to zero crossings.
  3. Optional: If you want to correct the timing of individual positions in the audio, define the local definition with the **Auto Adjust** or the **Manual Adjust** function, and activate **Musical Mode**.
  4. On the **Transport** panel, activate **Click**, and play back the audio to determine positions where the beat is not on time with the click.
  5. In the **AudioWarp** section, activate **Free Warp**, place the mouse pointer at the position of the beat that you want to adjust, click, and hold.  
The mouse pointer changes to a clock with arrows, and a warp marker is inserted.
  6. Drag the warp marker to the new position, and release the mouse button.
- 

### RESULT

The beat is now aligned with the corresponding position in the project.

### RELATED LINKS

[Manual Adjust](#) on page 446

[Musical Mode](#) on page 444

## Correcting Warp Marker Positions

---

### PROCEDURE

1. In the **AudioWarp** section, activate **Free Warp**.
2. In the **Sample Editor**, click the warp marker handle and drag it to a new position.

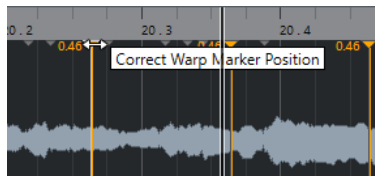

A tooltip is shown to indicate that you can drag to correct the warp marker position.

---

### RESULT

The warp marker moves to the new position and the audio is stretched or compressed accordingly.

## Deleting Warp Markers

---

### PROCEDURE

1. In the **AudioWarp** section, activate **Free Warp**.
2. Hold down **Alt** and click the warp marker you want to delete.

### NOTE

To delete several markers, draw a selection rectangle.

---

#### RESULT

The warp marker is removed from the waveform.

## Resetting Warp Markers

---

#### PROCEDURE

- In the **AudioWarp** section, click **Reset Warp Changes**.
- 

#### RESULT

The warp markers are removed from the waveform, and the warp edits of the waveform are reset.

#### NOTE

If **Musical Mode** is activated, only **Free Warp** edits are reset.

---

## Flattening Realtime Processing

You can flatten warp modifications. This is useful if you want to reduce the CPU load, optimize the sound quality of the processing, or apply any offline processing.

---

#### PROCEDURE

1. Select the audio events that you want to process.
  2. Perform one of the following actions:
    - Select **Audio > Realtime Processing > Flatten Realtime Processing**.
    - In the **Process** section of the **Sample Editor**, click **Flatten**.
  3. In the **Flatten Realtime Processing** dialog, select an algorithm preset.
  4. Click **OK**.
- 

#### RESULT

Any loop that was previously stretched in realtime plays back exactly the same, but the warp markers discarded.

#### RELATED LINKS

[MPEX](#) on page 403

## Flatten Realtime Processing Dialog

The **Flatten Realtime Processing** dialog allows you to select an algorithm.

- To open the **Flatten Realtime Processing** dialog, select one or more audio event in the **Project** window, and select **Audio > Realtime Processing > Flatten Realtime Processing**.

#### NOTE

This option is only available, if you have performed warp modifications.

---

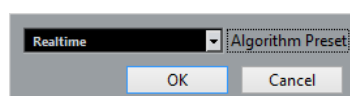

The following options are available:

### Algorithm Preset

Allows you to select an algorithm preset.

## Unstretching Audio Files

You can remove realtime time stretching from audio events.

### PREREQUISITE

You have stretched an audio event in the **Sample Editor** with the **Free Warp** tool, or in the **Project** window with the **Object Selection** tool in **Sizing Applies Time Stretch** mode.

---

### PROCEDURE

1. Select the audio event that you want to unstretch.
2. Select **Audio > Realtime Processing > Unstretch Audio**.

---

### RESULT

All realtime time stretching is removed.

# Audio Part Editor

The **Audio Part Editor** provides an overview of the selected audio parts. It allows you to view, audition and edit parts by cutting and pasting, crossfading, drawing level curves, or by processing parts. Editing is non-destructive so that you can undo modifications at any time.

You can open the **Audio Part Editor** in a separate window or in the lower zone of the **Project** window. Opening the **Audio Part Editor** in the lower zone of the **Project** window is useful if you want to access the **Audio Part Editor** functions from within a fixed zone of the **Project** window.

To open an audio part in the **Audio Part Editor**, do one of the following:

- Double-click an audio part in the **Project**.
- Select an audio part in the **Project** window and press **Return** or **Ctrl/Cmd-E**.
- Select an audio part in the **Project** window and select **Audio > Open Audio Part Editor**.
- In the **Key Commands** dialog in the **Editors** category, assign a key command for **Open Audio Part Editor**. Select an audio part in the **Project** window and use the key command.

## NOTE

If you select **Audio > Set up Editor Preferences**, the **Preferences** dialog opens on the **Editors** page. Make your changes to specify if you want the **Audio Part Editor** to open in a separate window or in the lower zone of the **Project** window.

The **Audio Part Editor** window:

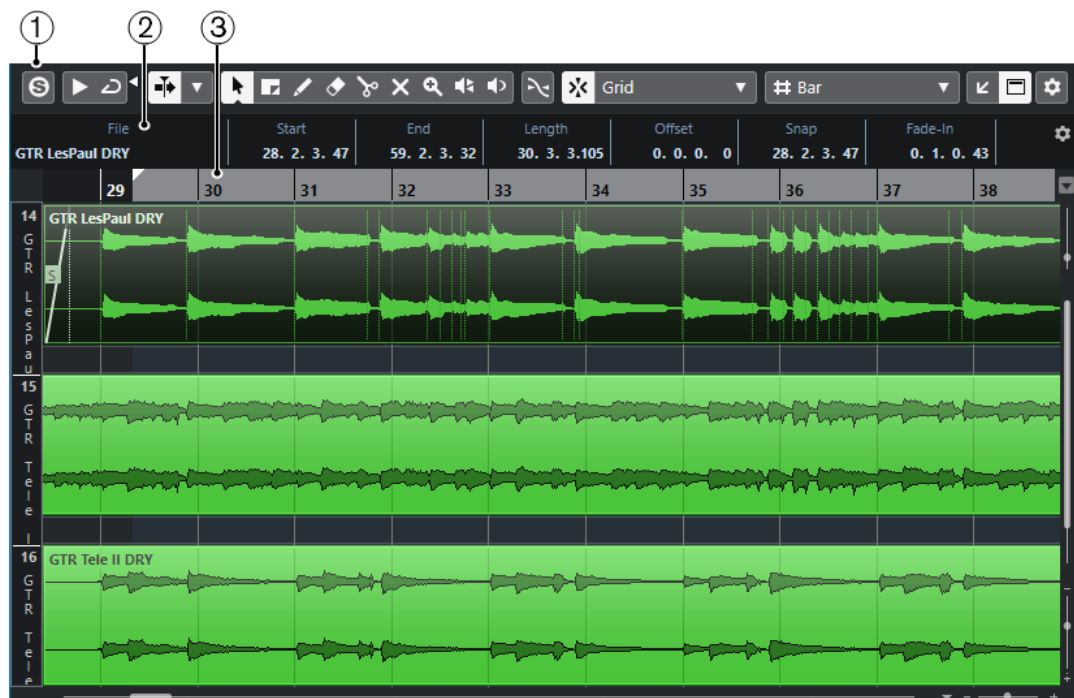

The **Audio Part Editor** in the lower zone of the **Project** window:

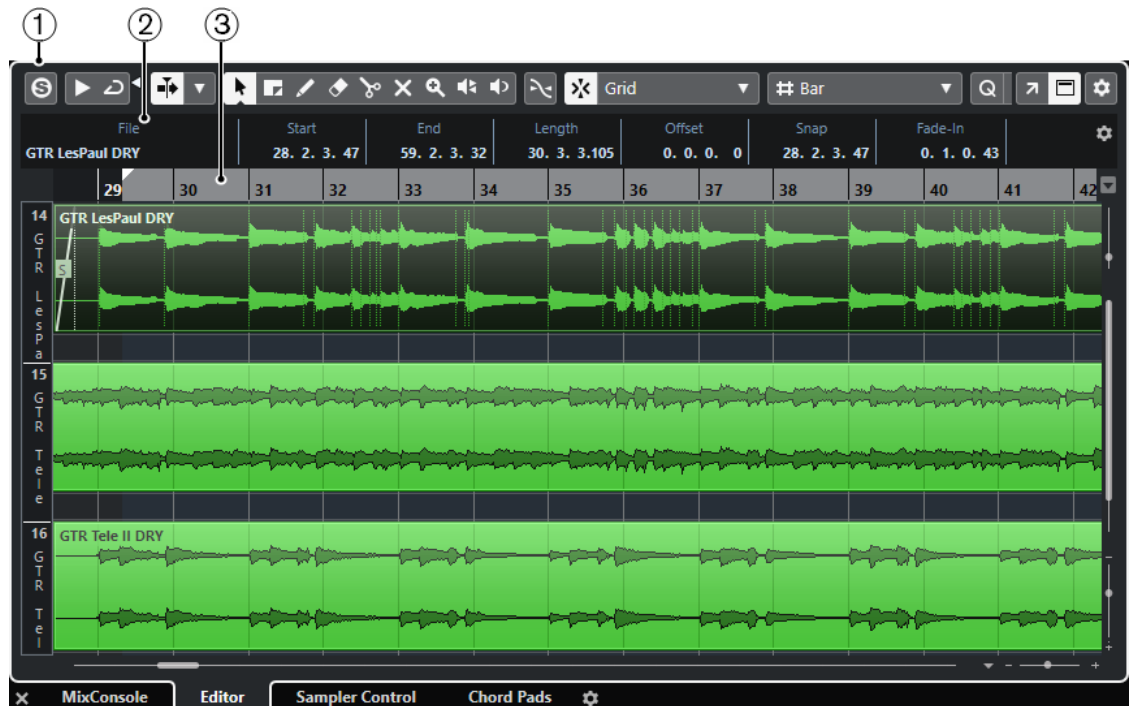

- 1 Toolbar**  
Contains tools for selecting, editing, and playing back audio parts.
- 2 Info Line**  
Displays information on the audio parts.
- 3 Ruler**  
Displays the timeline and the display format of the project.

#### RELATED LINKS

- [Opening the Editor in the Lower Zone](#) on page 55
- [Opening the Editor Inspector](#) on page 47
- [Ruler](#) on page 42
- [Info Line](#) on page 43
- [Audio Part Editor Toolbar](#) on page 453

## Audio Part Editor Toolbar

The toolbar contains tools for selecting, editing, and playing back audio parts.

- To show or hide the toolbar elements, right-click the toolbar and activate or deactivate the elements.

The following options are available:

### Info/Solo

#### Solo Editor



Solos the selected audio during playback.

## Left Divider

### Left Divider



Tools that are placed to the left of the divider are always shown.

## Auto-Scroll

### Link Project and Lower Zone Editor Cursors



Links timelines, cursors, and zoom factors of the lower zone editor and the **Project** window.

#### NOTE

You cannot activate **Link Project and Lower Zone Editor Cursors** if **Independent Track Loop** is active.

---

### Auto-Scroll



Keeps the project cursor visible during playback.

### Select Auto-Scroll Settings



Allows you to activate **Page Scroll** or **Stationary Cursor** and to activate **Suspend Auto-Scroll When Editing**.

## Preview

### Audition



Plays back the selected audio.

### Audition Loop



Loops the playback until you deactivate **Audition**.

### Audition Volume



Allows you to adjust the volume.

## Tool Buttons

### Object Selection



Selects audio parts.

### Range Selection



Selects ranges.

### Zoom



Zooms in. Hold **Alt** and click to zoom out.

### Erase



Deletes audio parts.

### Split



Splits audio parts.

### Mute



Mutes audio parts.

### Comp



Assembles takes.

### Draw



Draws a volume curve.

### Play



Allows you to play back the clip from the position where you click until you release the mouse button.

### Scrub



Allows you to locate positions.

## Multiple Part Controls

### Show Part Borders



Shows/Hides part borders for the active audio part, within the left and right locators.

### Edit Active Part Only



Restricts editing operations to the active part.

### Currently Edited Part

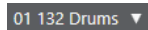

Lists all parts that were selected when you opened the editor, and allows you to activate a part.

## Nudge Palette

### Trim Start Left



Increases the length of the selected element by moving its start to the left.

### Trim Start Right



Decreases the length of the selected element by moving its start to the right.

### Move Left



Moves the selected element to the left.

### Move Right



Moves the selected element to the right.

### Trim End Left



Decreases the length of the selected element by moving its end to the left.

### Trim End Right



Increases the length of the selected element by moving its end to the right.

## Snap

### Snap to Zero Crossing



Restricts editing to zero crossings, that is, positions where the amplitude is zero.

### Snap On/Off



Restricts horizontal movement and positioning to the specific positions.

### Snap Type

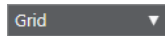

Allows you to specify to what positions you want events to snap.

## Grid Type

### Grid Type



Allows you to select a grid type. The options depend on the display format that is selected for the ruler. If you select **Seconds** as ruler format, time-based grid options are available. If you select **Bars+Beats** as ruler format, musical grid options are available.

## Quantize

### Iterative Quantize On/Off



Activates/Deactivates iterative quantize.

### AudioWarp Quantize On/Off



Activates/Deactivates **AudioWarp** quantize.

### Quantize Presets



Allows you to select a quantize preset.



### Apply Quantize



Applies the quantize settings.

### Open Quantize Panel



Opens the **Quantize Panel**.

### Event Colors

#### Select Color for Selected Tracks or Events



Allows you to define audio part colors.

### Independent Track Loop

#### Independent Track Loop



Activates/Deactivates the independent track loop for the edited part.

#### NOTE

If you activate **Independent Track Loop**, the **Link Project and Lower Zone Editor Cursors** function is automatically deactivated in the lower zone editor.

---

### Right Divider

#### Right Divider



Tools that are placed to the right of the divider are always shown.

### Window Zone Controls

#### Open in Separate Window



This button is available in the lower zone editor. It opens the editor in a separate window.

#### Open in Lower Zone



This button is available in the editor window. It opens the editor in the lower zone of the **Project** window.

#### Show/Hide Info



Allows you to activate/deactivate the info line.

#### Set up Toolbar



Opens a pop-up menu where you can set up which toolbar elements are visible.

#### RELATED LINKS

[Link Project and Lower Zone Editor Cursors](#) on page 57

[Auto-Scroll Settings Menu](#) on page 214

[Suspend Auto-Scroll When Editing](#) on page 215

## Info Line

The info line shows information about the audio part, such as the start, end, length, or the time stretch algorithm.

File	Start	End	Length	Offset	Snap
04 piano 01	1. 1. 1. 0	3. 1. 1. 0	2. 0. 0. 0	0. 0. 0. 0	1. 1. 1. 0
Fade-In	Fade-Out	Volume	Lock	Transpose	Fine-Tune
0. 0. 0. 0	0. 0. 0. 0	0.00 dB	-	0	0
Mute	Musical Mode	Algorithm			
-	-	Standard - Mix			

- To show or hide the info line, activate **Show/Hide Info** on the toolbar.  
The on/off status of the info line in the **Audio Part Editor** window and in the lower zone editor are independent of each other.

### RELATED LINKS

[Audio Part Editor Toolbar](#) on page 453

## Ruler

The ruler shows the timeline and the display format of the project.

You can select a separate display format by clicking on the arrow button on the right. Select an option from the pop-up menu.

## Lanes

Lanes can make it easier to work with several audio events in a part. Moving some of the events to another lane can make selecting and editing much easier.



If **Snap** is deactivated and you want to move an event to another lane without accidentally moving it horizontally, press **Ctrl/Cmd** while dragging it up or down.

### RELATED LINKS

[Track Handling](#) on page 140

## Operations

All operations can be performed in the **Audio Part Editor** window and in the lower zone editor. Zooming, selecting and editing in the **Audio Part Editor** is done just as in the **Project** window.

### NOTE

If a part is a shared copy, any editing you perform affects all shared copies of this part.

---

### RELATED LINKS

[Project Window](#) on page 30

[Shared Copies](#) on page 185

## Audition

When auditioning with the **Speaker** tool or **Audition** icon, audio will be routed directly to the main mix (the default output bus).

### Auditioning Using the Audition Tool

You can use the **Audition** tool to directly start a single audition of a selection or loop an audition using the **Audition Loop** function.

---

#### PROCEDURE

1. Do one of the following:
  - To play back the section between the first and last selected event, select the events with the **Object Selection** tool.
  - To play back a range, select a range with the **Range Selection** tool.
  - To start playback from the current cursor position, set the project cursor to that position.
2. On the toolbar, click **Audition**.

#### NOTE

If you activate **Audition Loop**, playback continues until you deactivate **Audition**.

---

### RELATED LINKS

[Audio Part Editor Toolbar](#) on page 453

### Auditioning Using the Play Tool

#### PROCEDURE

1. Select **Play** on the toolbar.
  2. On an audio part, click and hold at the position from which you want to begin auditioning.
- 

#### RESULT

You are auditioning the audio part. The audition will stop at the end of the part you clicked on.

### RELATED LINKS

[Audio Part Editor Toolbar](#) on page 453

## Auditioning Using Regular Playback

---

### PROCEDURE

1. Set the project cursor to the position from where you want to start playback.
  2. Optional: On the toolbar of the **Audio Part Editor**, activate **Solo Editor**.  
This way, only the events in the edited part are played back.
  3. On the **Transport** panel, activate **Start**.
- 

## Setting up the Independent Track Loop

The independent track loop is a sort of mini-cycle, affecting only the edited part. When the loop is activated, the events in the parts that are within the loop will be repeated continuously and completely independent – other events (on other tracks) are played back as usual. The only interaction between the loop and the regular playback is that the loop starts every time the cycle starts over again.

---

### PROCEDURE

1. Activate **Independent Track Loop** on the toolbar.

#### NOTE

If you activate **Independent Track Loop**, the **Link Project and Lower Zone Editor Cursors** function is automatically deactivated in the lower zone editor.

---

If it is not visible, right-click the toolbar and add the **Independent Track Loop** section.

2. **Ctrl/Cmd**-click in the ruler to set the start and **Alt**-click to set the end of the loop.

#### NOTE

You can also edit the loop start and end positions numerically in the fields next to the **Loop** button.

---

### RESULT

The loop is indicated in blue in the ruler.

#### NOTE

The events are looped as long as the **Loop** button is activated and the **Audio Part Editor** is open.

---

### RELATED LINKS

[Setup Options](#) on page 876

[Audio Part Editor Toolbar](#) on page 453

## Scrub

In the **Audio Part Editor**, the **Scrub** tool has a separate icon on the toolbar. Apart from that, scrubbing works exactly as in the **Project** window.

### RELATED LINKS

[Scrubbing](#) on page 174

## Handling Several Parts

When you open the **Audio Part Editor** with several parts selected – all on the same track or on different tracks – they might not all fit in the editor window, which can make it hard to get an overview of the different parts when editing.

Therefore, the toolbar features functions to make working with multiple parts easier and more comprehensive:

- The **Currently Edited Part** pop-up menu lists all parts that were selected when you opened the editor, and lets you select which part is active for editing.  
When you select a part from the list, it is automatically made active and centered in the display.

### NOTE

You can also activate a part by clicking on it with the **Object Selection** tool.

- **Edit Active Part Only** lets you restrict editing operations to the active part only.  
If you select **Edit > Select > All** with this option activated, all events in the active part are selected, but not the events in other parts.
- You can zoom in on an active part so that it is displayed in its entirety in the window by selecting **Edit > Zoom > Zoom to Event**.
- **Show Part Borders** can be used if you want to see clearly defined borders for the active part.  
If this option is activated, all parts except the active one are grayed out, making the borders easily discernible. There are also two markers in the ruler with the name of the active part, marking its beginning and end. These can be moved freely to change the part borders.
- It is possible to cycle between parts, making them active using key commands. In the **Key Commands** dialog, there are two functions in the **Edit** category: **Activate Next Part** and **Activate Previous Part**. If you assign key commands to these, you can use them to cycle between parts.

### RELATED LINKS

[Key Commands](#) on page 854

[Audio Part Editor Toolbar](#) on page 453

# Sampler Tracks

The sampler track features allow you to chromatically play back any audio from your audio sample library via MIDI. You can create and edit new sounds based on specific samples, and integrate them into an existing project.

The sampler track features include:

- A sampler track that allows you to control the playback of the audio sample that is loaded in **Sampler Control**.
- **Sampler Control** that allows you to load and edit audio samples.

## RELATED LINKS

[Creating Sampler Tracks](#) on page 463

[Sampler Control](#) on page 464

## Loading Audio Samples into Sampler Control

You can load audio samples into **Sampler Control** by dragging.

Cubase allows you to load mono or stereo samples in `.wav` or `.aiff` file format into **Sampler Control**.

- To load an audio sample, drag it from the **MediaBay**, the **Project** window event display, or the File Explorer/macOS Finder and drop it in **Sampler Control**.

### IMPORTANT

If **Sampler Control** already contains an audio sample, this sample and all its settings are overwritten.

### NOTE

- Audio samples that you load into **Sampler Control** are not copied to the project audio folder. If you want to archive or share your project including all audio samples that you have loaded into **Sampler Control**, you must create a self-contained project.
- In the **Pool**, all audio samples that you have loaded into **Sampler Control** are listed in a dedicated sampler track subfolder in the main audio folder.

## RELATED LINKS

[Self-Contained Projects](#) on page 92

[Pool](#) on page 476

## Loading MIDI Parts into Sampler Control

You can load MIDI parts from instrument tracks or MIDI tracks into **Sampler Control** by dragging.

### NOTE

For this to work, the instrument track or the MIDI track must be routed to a VST instrument.

- To load a MIDI part, drag it from the **MediaBay**, the **Project** window event display, or the File Explorer/macOS Finder and drop it in **Sampler Control**.

### IMPORTANT

If **Sampler Control** already contains MIDI, it is overwritten.

Cubase creates an audio file from the MIDI part. This includes the instrument sound and the channel settings from the VST instrument or the return channel. The audio file is copied to the project audio folder.

### RELATED LINKS

[VST Instruments](#) on page 547

[Instrument Track Inspector](#) on page 108

[MIDI Track Inspector](#) on page 115

## Creating Sampler Tracks

To create a sampler track, do one of the following:

- In the **Project** window, select an audio event and select **Audio > Create Sampler Track**.
- In the **MediaBay**, right-click an audio file and select **Create Sampler Track**.
- In the **Inspector** of the **Sample Editor**, open the **Range** section and click **Create Sampler Track**.

This creates a sampler track from the selected range. If no range is selected, the entire event is used.

- On the context menu of the track list, select **Add Sampler Track**.

In this case, **Sampler Control** is empty and you must load an audio sample by dragging.

## Sampler Control

If the sampler track is selected, **Sampler Control** is available in the lower zone of the **Project** window. **Sampler Control** allows you to view, edit, and play back samples or specific sections of the samples.



### 1 Toolbar

Contains tools that allow you to select and edit the audio sample, to organize track presets, and to transfer the sample with its settings to an instrument.

### 2 Waveform Display/Envelope Editor

Shows the waveform image of the sample and allows you to define the playback range for the sample and to set a loop.

If the envelope editors for the pitch, filter, or amp section are shown, you can adjust their envelope curve settings here.

### 3 Sound Parameter Section

Allows you to make settings for time stretching and formant shifting (**AudioWarp** section), tuning and pitch modulation (**Pitch** section), filtering (**Filter** section), or level and panorama (**Amp** section).

### 4 Keyboard Section

Allows you to set the key range of the sample, its root key, and the modulation range of the pitchbend wheel. These settings are used if you work with an external MIDI device.

#### RELATED LINKS

[Creating Sampler Tracks](#) on page 463

[Waveform Display](#) on page 467

[Envelope Editors](#) on page 470

[Sound Parameter Section](#) on page 468

[Keyboard Section](#) on page 472

## Sampler Control Toolbar

The **Sampler Control** toolbar contains various settings and functions.

### Read Automation



Allows you to read track automation.

### Write Automation





Allows you to write track automation.

### Switch between A/B Settings



Allows you to switch between different parameter settings.

### Event Received Indicator



This LED indicates incoming MIDI messages via the selected MIDI input. The LED lights up on receiving note-on and controller messages. This way, you can check if Cubase and your MIDI keyboard are connected to the same MIDI device input.

### Snap to Zero Crossing



Restricts sample editing to zero crossings, that is, to positions where the amplitude is zero.

### Auto-Scroll



Keeps the project cursor visible during playback.

### Preset section

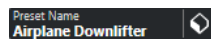

Shows the name of the track preset that is loaded for the sampler track. You can also save and load presets.

### Import Audio File



Opens the **Import Audio** dialog that allows you to load an audio file into **Sampler Control**.

#### NOTE

If **Sampler Control** already contains an audio file, the original file is replaced by the new file.

### File Name

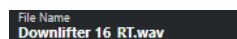

Shows the file name of the sample.

### Tempo



Shows the tempo of the sample.

### Root Key



Shows the root key that determines the pitch of the sample. You can change the root key by entering a new value in the value field or by dragging the root key handle on the **Sampler Control** keyboard.

### Loop Mode

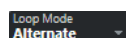

Allows you to select a loop mode for playback via MIDI.

- If this is set to **No Loop**, the sample is played once.

- If this is set to **Continuous**, the sample is played in a continuous loop.
- If this is set to **Alternate**, the sample is played back in a loop that alternates forward and backward.
- If this is set to **Once**, the sample is looped once.
- If this is set to **Until Release**, the sample is looped repeatedly until you release the key on the keyboard.
- If this is set to **Alternate Until Release**, the loop alternates forward and backward for as long as you hold the key.

### One Shot



The sample is played back once from beginning to end, regardless of any loop settings.

### MIDI Reset



Stops playback and resets all MIDI controllers to their default values.

This is useful, for example, if you want to stop playback of a long audio sample in **One Shot** mode.

### Fixed Pitch



If a sample is triggered by a MIDI note other than the one defined by the **Root Key** setting, the sample is pitched accordingly. If **Fixed Pitch** is activated, the relation between played note and root key is disregarded and all keys play the sample just as it was recorded.

### Reverse Sample



Reverses the sample. This allows you to play back the sample backwards.

### Monophonic Mode



Activates monophonic playback. For solo instruments, this usually results in a more naturally sounding performance. If monophonic playback is activated, a note that was stolen by another note is retriggered if you still hold the stolen note when you release the new one. This way, you can play trills by holding one note and quickly and repeatedly pressing and releasing another note, for example.

If this option is deactivated, you can play up to 128 notes simultaneously.

### Transfer to New Instrument



Allows you to transfer the audio sample with all its **Sampler Control** settings to an instrument that is loaded to a new instrument track.

### Open in Separate Window



Opens **Sampler Control** in a separate window.

### Open in Lower Zone



Opens **Sampler Control** in the lower zone.

RELATED LINKS

[Setting the Root Key Manually](#) on page 473

[Setting up Loops for Audio Samples](#) on page 473

[Transferring Samples from Sampler Control to VST Instruments](#) on page 475

## Waveform Display

The waveform display shows the waveform of your audio sample. It allows you to define the start and end of the audio sample, of the loop, and of the fade-in/-out.



### Set Sample Start

Defines the sample start. On playback, all audio before the sample start is ignored.

### Set Sample End

Defines the sample stop. On playback, all audio after the sample end is ignored.

### Set Sustain Loop Start

Defines where the sustain loop starts.

### Set Sustain Loop End

Defines where the sustain loop ends. When this marker is reached, playback jumps back to the sustain loop start.

### Set Fade-In Length

Defines the fade-in length.

### Set Fade-Out Length

Defines the fade-out length.

### Set Sustain Loop Crossfade Length

Loop crossfades allow for smoother loops. This marker defines the length for the loop crossfade.

## Ruler

The ruler shows the timeline in the specified display format.

- To select the format, click the arrow button to the right of the ruler and select an option from the pop-up menu.  
You can display bars and beats, seconds, or samples.

## Zooming

- To zoom in/out on the time and level axes, use the horizontal and vertical zoom sliders or the corresponding key commands.

RELATED LINKS

[Key Commands](#) on page 854

## Sound Parameter Section

In the sound parameter section you can make settings for time stretching and formant shifting (**AudioWarp** section), tuning and pitch modulation (**Pitch** section), filtering (**Filter** section), or level and panorama (**Amp** section).

### AudioWarp Section

In the **AudioWarp** section, you can apply time stretching and formant shifting to your samples.

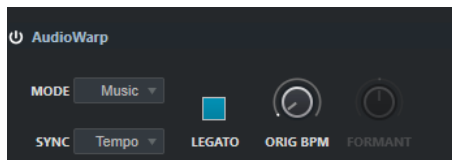

- To activate the AudioWarp settings, click **Activate/Deactivate AudioWarp**.

#### AudioWarp Mode

- **Solo** mode offers parameters for time stretching and formant shifting. This mode is suitable for loops and samples of solo instruments or vocals.
- **Music** mode offers parameters for time stretching. This mode is suitable for complex material like drum loops and samples of mixed music. It uses considerably more CPU time than **Solo** mode.

#### NOTE

The more the sample is stretched, the higher the CPU load.

#### AudioWarp Sync Mode

Allows you to match the playback speed of the sample to the project tempo.

- If **Off** is selected, the playback speed is specified manually, in percent.
- If **Tempo** is selected, the playback speed is calculated using the ratio between the original tempo of the sample and the tempo of the host.

#### Legato

If this option is deactivated, each note that is played via MIDI starts playback from the **Sampler Control** position cursor.

If this option is activated, the first note starts playback from the position cursor, and any following notes start from the current playback position for as long as the first note is held.

#### Speed

If **AudioWarp Sync Mode** is set to **Off**, you can adjust the playback speed of the sample.

In **Music** mode, the minimum playback speed adjustment is 12.5 %. Values below this limit have no effect.

#### Original BPM

If **AudioWarp Sync Mode** is set to **Tempo**, you can enter the original tempo of the sample in beats per minute. The playback speed of the sample is adjusted to match the tempo of the host application.

#### NOTE

This parameter is only available in **Solo** and in **Music** mode. In **Music** mode, the lower limit of the playback speed adjustment is 12.5 %. Values below this limit have no further effect.

#### Formant

Allows you to adjust formant shifting. Formant shifting allows you to avoid so-called Mickey Mouse effects when pitch-shifting a sample. This is especially useful with samples of human voices or acoustic instruments.

This parameter is only available in **Solo** mode.

## Pitch Section

In the **Pitch** section, you can adjust the tuning and pitch of your audio sample. The pitch envelope allows you to modulate the pitch over time.

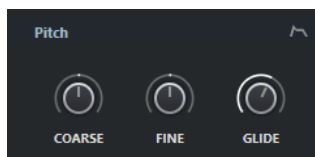

#### Coarse

Sets the pitch of the audio sample in semitone steps.

#### Fine

Fine-tunes the pitch of the audio sample in cents (hundredths of a semitone).

#### Glide

Specifies the time that is needed to bend the pitch of the audio sample from one note to the following note. If you move this control all the way to the left, **Glide** is deactivated.

#### Show/Hide Pitch Envelope

Shows the pitch envelope editor.

#### RELATED LINKS

[Envelope Editors](#) on page 470

## Filter Section

In the **Filter** section, you can adjust the tone color of the sample sound. The filter envelope allows you to control the cutoff frequency to shape the harmonic content over time.

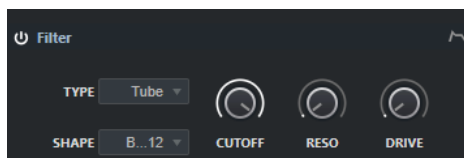

- To activate the filter settings, click **Activate/Deactivate Filter**.

#### Cutoff

Controls the cutoff frequency of the filter.

#### Resonance

Sets the filter resonance.

### Drive

Determines the level of the input signal and thus the amount of saturation.

### Show/Hide Filter Envelope

Shows the filter envelope editor.

#### RELATED LINKS

[Envelope Editors](#) on page 470

## Amp Section

In the **Amp** section, you can set the volume and the pan of the sample. The amplifier envelope allows you to shape the volume over time.

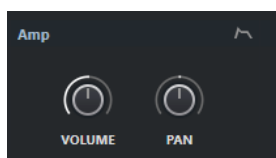

### Volume

Sets the level of the sample.

### Pan

Sets the position of the sample in the stereo panorama.

### Show/Hide Amp Envelope

Shows the amplifier envelope editor.

#### RELATED LINKS

[Envelope Editors](#) on page 470

## Envelope Editors

You can adjust the **Pitch**, **Filter**, and **Amp** envelope curves. Each of these envelopes can contain up to 128 nodes.

- Click **Show/Hide Envelope**  at the top right of a section to show the corresponding envelope editor.



Pitch Envelope

### Pitch Envelope Amount

Determines how much the selected envelope affects the audio. This parameter allows for positive and negative values. If the **Envelope Amount** is set to 0, the envelope has no effect.

#### NOTE

This parameter is only available for **Filter** and **Pitch**.

---

### Envelope display

Shows the envelope curve. You can adjust it by adding, moving, and deleting nodes. The nodes for attack (**A**), sustain (**S**), and release (**R**) are always shown and cannot be deleted. Next to the release node, the release time of the envelope is shown.

### Mode

Determines how the envelope is played back when it is triggered.

- Select **Sustain** to play the envelope from the first node to the sustain node. The sustain level is held for as long as you play the note. When you release the note, the envelope continues with the stages following the sustain. This mode is suited for looped samples.
- Select **Loop** to play back the envelope from the first node to the loop nodes. Then, the loop is repeated for as long as the key is held. When you release the note, the envelope continues playing the stages that follow the sustain. This mode is suited for adding motion to the sustain of the envelope.
- Select **One Shot** to play the envelope from the first to the last node, even if you release the key. The envelope has no sustain stage. This mode is suited for drum samples.
- Select **Sample Loop** to preserve the natural attack of the sample. The decay of the envelope does not start until the sample has reached the sample loop start.

If you set the second node to the maximum level and use the following nodes to shape the decay during the loop phase of the sample, the envelope only affects the loop phase. The attack of the envelope is still executed.

### Velocity

Determines how the velocity affects the level of the envelope.

The level of the envelope depends on the velocity setting and on how hard you hit a key. Higher values increase the level of the envelope the harder you hit a key.

#### RELATED LINKS

[Selecting Nodes](#) on page 471

[Adding and Removing Nodes](#) on page 472

[Adjusting the Envelope Curve](#) on page 472

[Zoom Functions in the Envelope Editors](#) on page 472

## Selecting Nodes

You can select single nodes or multiple nodes. Selected nodes are edited together.

- To select a node, click on it in the graphical editor.  
The **Time** field at the top of the graphical envelope editor shows the parameters of the selected node.
- To add a node to a selection, **Shift**-click the node.
- To select multiple nodes, draw a rectangle around them with the mouse.  
If multiple nodes are selected, the **Time** field shows the parameters of the node that is indicated by a white border.
- To select all envelope nodes, press **Ctrl/Cmd-A**.
- If the envelope editor has the keyboard focus, you can select the next or the previous node using **Left Arrow** and **Right Arrow**.

#### RELATED LINKS

[Keyboard Focus in the Project Window](#) on page 63

## Adding and Removing Nodes

You can add up to 128 nodes to an envelope curve.

- To add a node, double-click at the position where you want to add the node.
- To remove a node, double-click it.
- To delete several selected nodes, press **Delete** or **Backspace**.

### NOTE

- You cannot remove the attack (**A**), the sustain (**S**), or the release node (**R**).
  - All nodes added after the sustain node always affect the release phase of the envelope.
- 

## Adjusting the Envelope Curve

The envelope editor allows you to adjust the envelope curve by dragging.

- To move a node horizontally or vertically, click and drag it.
- To move the envelope curve vertically between two nodes, click and drag it.

## Zoom Functions in the Envelope Editors

The vertical axis of the envelope editor displays the level. The horizontal axis displays the time.

- To zoom in or out, click the **+** or **-** buttons to the right of the scrollbar below the envelope editor or use the corresponding key commands.
- To zoom in or out at the current position, click in the timeline and drag up or down.
- To zoom to a specific region, hold **Alt** and click and drag the mouse over the region.

### RELATED LINKS

[Key Commands](#) on page 854

## Keyboard Section

In the keyboard section of **Sampler Control** you can set the root key and the key range of the sample, and the modulation range of the pitchbend wheel on your MIDI keyboard.

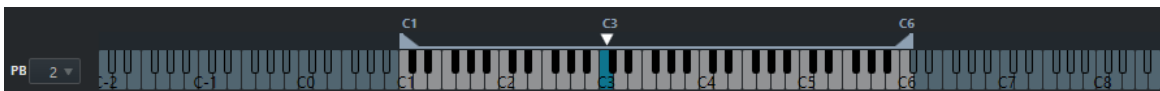

### Pitchbend

Determines the maximal modulation that is applied when you move the pitchbend wheel on your MIDI keyboard. You can set the pitchbend range in semitone steps up to 12 semitones.

### Keyboard

Determines the root key and the key range of the sample.

### RELATED LINKS

[Setting the Root Key Manually](#) on page 473

[Setting the Key Range](#) on page 474



## Sample Editing and Playback Functions

All sample editing in **Sampler Control** is non-destructive.

### Setting Sample Start and End

By setting the sample start and end, you can define what range of the sample is played back when you press a key on your MIDI keyboard.

---

#### PROCEDURE

1. Drag the **Set Sample Start** handle to the right to adjust the sample start point.
  2. Drag the **Set Sample End** handle to the left to adjust the sample end point.
- 

### Setting up Loops for Audio Samples

You can set up a loop that is played back when the sample is triggered.

---

#### PROCEDURE

1. On the toolbar, click **Loop Mode** and select a loop mode from the pop-up menu. The **Set Sustain Loop Start** and **Set Sustain Loop End** handles and the green loop range overlay are shown.
2. Drag the **Set Sustain Loop Start** and **Set Sustain Loop End** handles to adjust the loop start and end points.  
To create a smooth loop transition, try to match the shape of the green loop range overlay with the shape of the gray sample waveform.

#### NOTE

You cannot drag the loop start and end points outside the defined sample range.

---

#### RELATED LINKS

[Setting Sample Start and End](#) on page 473

### Setting the Root Key Manually

The **Root Key** shows the original pitch of the sample. Sometimes, if the sample does not contain any root key information or if you want the sample to play at a different pitch, you must set the root key manually.

#### NOTE

If you load a sample that does not contain any root key information, the root key is automatically set to C3.

---

To set the root key manually, do one of the following:

- In the keyboard section of **Sampler Control**, click and drag the root key handle.
- On the toolbar of **Sampler Control**, double-click in the **Root Key** field and enter the new root key using your computer keyboard, your mouse wheel, or your MIDI keyboard.

#### RELATED LINKS

[Keyboard Section](#) on page 472  
[Setting the Key Range](#) on page 474

## Setting the Key Range

You can determine the key range for the sample. This is useful for samples that only sound good within a certain key range.

---

### PROCEDURE

- In the keyboard section, adjust the key range by dragging the range handles above the keyboard display.

---

### RESULT

Only keys within the determined key range play a sound when triggered.

### RELATED LINKS

[Keyboard Section](#) on page 472

## Playing Back Samples

After you have loaded an audio sample into **Sampler Control**, you can play back the sample using an external MIDI keyboard or the **On-Screen Keyboard**.

### PREREQUISITE

You have loaded a sample into **Sampler Control** and made all sample editing and settings. You have installed and set up your MIDI keyboard.

---

### PROCEDURE

1. In the track list, activate **Monitor** for the sampler track.
2. Optional: On the **Sampler Control** toolbar, activate **Fixed Pitch**.  
This allows you to play back the sample in its original pitch and speed.
3. Hit some notes on your keyboard or use the **On-Screen Keyboard** to play back the sample.

---

### RESULT

If **Fixed Pitch** is deactivated, the sample is played back and the pitch is defined by the notes you play. If you hit lower keys, the sample is played back with a low pitch. If you hit higher keys, the sample is played back with a high pitch.

If **Fixed Pitch** is activated, the sample is played back in its original pitch.

### AFTER COMPLETING THIS TASK

To use the sound of the edited sample in your project, create or record a MIDI event on the sampler track.

### RELATED LINKS

[On-Screen Keyboard](#) on page 228

[Monitoring via Cubase](#) on page 235

[MIDI Events](#) on page 171

[Basic Recording Methods](#) on page 230

[MIDI Editors](#) on page 618

## Transferring Samples from Sampler Control to VST Instruments

You can transfer audio samples with all settings that you have made in **Sampler Control** to specific Steinberg VST instruments.

Transferring audio samples from **Sampler Control** to a VST instrument creates a new instrument track in the track list. This new track is added below the sampler track. The audio sample and all its settings are loaded in the VST instrument.

You can transfer audio samples from **Sampler Control** to the following Steinberg VST instruments:

- Groove Agent
- Groove Agent SE
- HALion
- Padshop

### Transferring a Sample

#### PREREQUISITE

You have installed Groove Agent, Groove Agent SE, HALion, or Padshop. You have loaded an audio sample in **Sampler Control**.

---

#### PROCEDURE

1. In the **Sampler Control** toolbar, click **Transfer to New Instrument**.
2. In the pop-up menu, select the instrument to which you want to transfer the sample.

---

#### RESULT

In the track list, a new instrument track is created below the sampler track. The instrument track has the same name as the sampler track. The audio sample and all its settings are loaded in the selected VST instrument.

#### RELATED LINKS

[Transferring a Sample](#) on page 475

# Pool

Every time that you record on an audio track, a file is created on your hard disk. A reference to this file, a clip, is added to the **Pool**.

The following rules apply to the **Pool**:

- All audio and video clips that belong to a project are listed in the **Pool**.
- Every project has a separate **Pool**.

The way the **Pool** displays folders and their contents is similar to the way the File Explorer/macOS Finder displays folders and file lists. In the **Pool**, you can perform operations that affect files on disk and operations that only affect clips.

## Operations That Affect Files

- Importing clips (audio files can automatically be copied and/or converted)
- Converting file formats
- Renaming clips (this also renames the referenced files on disk) and regions
- Deleting clips
- Preparing file archives for backup
- Minimizing files

## Operations That Affect Clips

- Copying clips
- Auditioning clips
- Organizing clips
- Applying audio processing to clips

## Pool Window

The **Pool** window allows you to manage the media files of the active project.

To open the **Pool**, do one of the following:

- On the **Project** window toolbar, click **Open Pool Window**. If this icon is not visible, you must activate the **Media & MixConsole Windows** option on the toolbar context menu.
- Select **Project > Pool**.
- Select **Media > Open Pool Window**.

Media		Used	Status	Mus	Tempo	Sign.	Key	Algorithm	Info	Type	Date	Origin Time	Image	Path
Audio	Record													
+	Bass Drum In	1			130.00	4/4	-	élastique Pro	44.100 kHz 24 bit Mono 2:26 m	Wave	11/22/2010	3.3.2.99	[Image]	[Windows] C:\Users
+	Bass-01	3			130.00	4/4	-	élastique Pro	44.100 kHz 24 bit Mono 2:11 m	Wave	11/22/2010	7.3.1.87	[Image]	[Windows] C:\Users
+	Bass Drum Out	1			130.00	4/4	-	élastique Pro	44.100 kHz 24 bit Mono 2:26 m	Wave	11/22/2010	3.3.2.99	[Image]	[Windows] C:\Users
+	Choir	3			130.00	4/4	-	élastique Pro	44.100 kHz 24 bit Stereo 1:28 m	Wave	11/22/2010	15.1.2.19	[Image]	[Windows] C:\Users
+	Close L-01	1			130.00	4/4	-	élastique Pro	44.100 kHz 24 bit Mono 2:26 m	Wave	11/22/2010	3.3.2.99	[Image]	[Windows] C:\Users
+	Close R-01	1			130.00	4/4	-	élastique Pro	44.100 kHz 24 bit Mono 2:26 m	Wave	11/22/2010	3.3.2.99	[Image]	[Windows] C:\Users
+	Doubled Voice	1			130.00	4/4	-	élastique Pro	44.100 kHz 24 bit Mono 2:08 m	Wave	11/22/2010	12.4.3.80	[Image]	[Windows] C:\Users
+	FX Voices	1			130.00	4/4	-	élastique Pro	44.100 kHz 24 bit Stereo 2:08 m	Wave	11/22/2010	12.4.2.56	[Image]	[Windows] C:\Users
+	HiHat-01	1			130.00	4/4	-	élastique Pro	44.100 kHz 24 bit Mono 2:26 m	Wave	11/22/2010	3.3.2.99	[Image]	[Windows] C:\Users
+	Lead Guitar	2			130.00	4/4	-	élastique Pro	44.100 kHz 24 bit Stereo 2:04 m	Wave	11/22/2010	4.1.2.49	[Image]	[Windows] C:\Users
+	Lead Voice	1			130.00	4/4	-	élastique Pro	44.100 kHz 24 bit Mono 2:17 m	Wave	11/22/2010	7.4.3.22	[Image]	[Windows] C:\Users
+	Mono	1			130.00	4/4	-	élastique Pro	44.100 kHz 24 bit Mono 2:26 m	Wave	11/22/2010	3.3.2.99	[Image]	[Windows] C:\Users
+	Overhead L	1			130.00	4/4	-	élastique Pro	44.100 kHz 24 bit Mono 2:26 m	Wave	11/22/2010	3.3.2.99	[Image]	[Windows] C:\Users
+	Overhead R	1			130.00	4/4	-	élastique Pro	44.100 kHz 24 bit Mono 2:26 m	Wave	11/22/2010	3.3.2.99	[Image]	[Windows] C:\Users
+	Rhythm Guitar 2	1			130.00	4/4	-	élastique Pro	44.100 kHz 24 bit Stereo 1:56 m	Wave	11/22/2010	19.3.1.67	[Image]	[Windows] C:\Users
+	Rhythm Guitar 3	1			130.00	4/4	-	élastique Pro	44.100 kHz 24 bit Stereo 2:11 m	Wave	11/22/2010	11.2.3.15	[Image]	[Windows] C:\Users
+	Rhythm Guitar1	2			130.00	4/4	-	élastique Pro	44.100 kHz 24 bit Stereo 2:22 m	Wave	11/22/2010	2.1.1.0	[Image]	[Windows] C:\Users
+	Snare Bottom	1			130.00	4/4	-	élastique Pro	44.100 kHz 24 bit Mono 2:26 m	Wave	11/22/2010	3.3.2.99	[Image]	[Windows] C:\Users
+	Snare Top	1			130.00	4/4	-	élastique Pro	44.100 kHz 24 bit Mono 2:26 m	Wave	11/22/2010	3.3.2.99	[Image]	[Windows] C:\Users
+	Solo_1	12			130.00	4/4	-	Standard - Mi	44.100 kHz 24 bit Mono 17.365 s	Wave	11/22/2010	51.3.1.80	[Image]	[Windows] C:\Users
+	Solo_2	13			130.00	4/4	-	Standard - Mi	44.100 kHz 24 bit Mono 17.166 s	Wave	11/22/2010	51.3.1.20	[Image]	[Windows] C:\Users
+	Solo_3	14			130.00	4/4	-	Standard - Mi	44.100 kHz 24 bit Mono 17.074 s	Wave	11/22/2010	51.3.1.80	[Image]	[Windows] C:\Users
+	Solo_4	13			130.00	4/4	-	Standard - Mi	44.100 kHz 24 bit Mono 16.544 s	Wave	11/22/2010	51.3.1.50	[Image]	[Windows] C:\Users
+	Tom 1-02	1			130.00	4/4	-	élastique Pro	44.100 kHz 24 bit Mono 2:26 m	Wave	11/22/2010	3.3.2.99	[Image]	[Windows] C:\Users
+	Tom 2	1			130.00	4/4	-	élastique Pro	44.100 kHz 24 bit Mono 2:26 m	Wave	11/22/2010	3.3.2.99	[Image]	[Windows] C:\Users

The content of the **Pool** is divided into the following folders:

#### Audio folder

Contains all audio clips and regions that are in the project.

If the project contains one or more sampler tracks, a dedicated **Sampler Track** subfolder is created in the **Audio** folder. This subfolder contains all clips of samples that you have loaded into **Sampler Control**.

#### Video folder

Contains all video clips that are in the project.

#### Trash folder

Contains unused clips that have been moved here for later permanent removal from the hard disk.

#### NOTE

You cannot rename or delete these folders, but you can add any number of subfolders.

## Pool Window Columns

The **Pool** window columns display information about the clips and regions.

Media	Used	Status	Mus	Temp	Sign	Key	Algorithm	Info	Type	Date	Origin Time	Image	Path
Audio		Record											
Bass Drum In	1			130.00	4/4	-	élastique Pro - 44.100 kHz	24 bit Mono 2:26 m	Wave	11/22/2010	3. 3. 2. 99		[Windows] C:\Users
Bass-01	3			130.00	4/4	-	élastique Pro - 44.100 kHz	24 bit Mono 2:11 m	Wave	11/22/2010	7. 3. 1. 67		[Windows] C:\Users
Bass Drum Out	1			130.00	4/4	-	élastique Pro - 44.100 kHz	24 bit Mono 2:26 m	Wave	11/22/2010	3. 3. 2. 99		[Windows] C:\Users
Choir	3			130.00	4/4	-	élastique Pro - 44.100 kHz	24 bit Stereo 1:28 m	Wave	11/22/2010	15. 1. 2. 19		[Windows] C:\Users
Close L-01	1			130.00	4/4	-	élastique Pro - 44.100 kHz	24 bit Mono 2:26 m	Wave	11/22/2010	3. 3. 2. 99		[Windows] C:\Users
Close R-01	1			130.00	4/4	-	élastique Pro - 44.100 kHz	24 bit Mono 2:26 m	Wave	11/22/2010	3. 3. 2. 99		[Windows] C:\Users
Doubled Voice	1			130.00	4/4	-	élastique Pro - 44.100 kHz	24 bit Mono 2:08 m	Wave	11/22/2010	12. 4. 3. 80		[Windows] C:\Users
FX Voices	1			130.00	4/4	-	élastique Pro - 44.100 kHz	24 bit Stereo 2:08 m	Wave	11/22/2010	12. 4. 2. 56		[Windows] C:\Users
HiHat-01	1			130.00	4/4	-	élastique Pro - 44.100 kHz	24 bit Mono 2:26 m	Wave	11/22/2010	3. 3. 2. 99		[Windows] C:\Users
Lead Guitar	2			130.00	4/4	-	élastique Pro - 44.100 kHz	24 bit Stereo 2:04 m	Wave	11/22/2010	4. 1. 2. 49		[Windows] C:\Users
Lead Voice	1			130.00	4/4	-	élastique Pro - 44.100 kHz	24 bit Mono 2:17 m	Wave	11/22/2010	7. 4. 3. 22		[Windows] C:\Users
Mono	1			130.00	4/4	-	élastique Pro - 44.100 kHz	24 bit Mono 2:26 m	Wave	11/22/2010	3. 3. 2. 99		[Windows] C:\Users
Overhead L	1			130.00	4/4	-	élastique Pro - 44.100 kHz	24 bit Mono 2:26 m	Wave	11/22/2010	3. 3. 2. 99		[Windows] C:\Users
Overhead R	1			130.00	4/4	-	élastique Pro - 44.100 kHz	24 bit Mono 2:26 m	Wave	11/22/2010	3. 3. 2. 99		[Windows] C:\Users
Rhythm Guitar 2	1			130.00	4/4	-	élastique Pro - 44.100 kHz	24 bit Stereo 1:56 m	Wave	11/22/2010	19. 3. 1. 67		[Windows] C:\Users
Rhythm Guitar 3	1			130.00	4/4	-	élastique Pro - 44.100 kHz	24 bit Stereo 2:11 m	Wave	11/22/2010	11. 2. 3. 15		[Windows] C:\Users
Rhythm Guitar1	2			130.00	4/4	-	élastique Pro - 44.100 kHz	24 bit Stereo 2:22 m	Wave	11/22/2010	2. 1. 1. 0		[Windows] C:\Users
Snare Bottom	1			130.00	4/4	-	élastique Pro - 44.100 kHz	24 bit Mono 2:26 m	Wave	11/22/2010	3. 3. 2. 99		[Windows] C:\Users
Snare Top	1			130.00	4/4	-	élastique Pro - 44.100 kHz	24 bit Mono 2:26 m	Wave	11/22/2010	3. 3. 2. 99		[Windows] C:\Users
Solo_1	12			130.00	4/4	-	Standard - Mi: 44.100 kHz	24 bit Mono 17.365 s	Wave	11/22/2010	51. 3. 1. 80		[Windows] C:\Users
Solo_2	13			130.00	4/4	-	Standard - Mi: 44.100 kHz	24 bit Mono 17.166 s	Wave	11/22/2010	51. 3. 1. 20		[Windows] C:\Users
Solo_3	14			130.00	4/4	-	Standard - Mi: 44.100 kHz	24 bit Mono 17.074 s	Wave	11/22/2010	51. 3. 1. 80		[Windows] C:\Users
Solo_4	13			130.00	4/4	-	Standard - Mi: 44.100 kHz	24 bit Mono 16.544 s	Wave	11/22/2010	51. 3. 1. 50		[Windows] C:\Users
Tom 1-02	1			130.00	4/4	-	élastique Pro - 44.100 kHz	24 bit Mono 2:26 m	Wave	11/22/2010	3. 3. 2. 99		[Windows] C:\Users
Tom 2	1			130.00	4/4	-	élastique Pro - 44.100 kHz	24 bit Mono 2:26 m	Wave	11/22/2010	3. 3. 2. 99		[Windows] C:\Users

The following columns are available:

### Media

Contains the **Audio**, **Video**, and **Trash** folders. If the folders are opened, the clip or region names are shown and can be edited.

### Used

Displays how many times a clip is used in the project. If there is no entry in this column, the corresponding clip is not used.

### Status

Displays various icons that relate to the current **Pool** and clip status. The following symbols can be displayed:

- **Record** **Record**  
Indicates the **Record** folder.
- **Process**   
Indicates that a clip has been processed.
- **Missing**   
Indicates that a clip is referenced in the project but missing from the **Pool**.
- **External**   
Indicates that the file the clip relates to is external, for example, located outside the current **Audio** folder for the project.
- **Recorded**   
Indicates that the clip has been recorded in the open version of the project. This is useful for finding recently recorded clips quickly.

### Musical Mode

You can use **Musical Mode** to tempo-match audio loops to the project tempo. The checkbox in this column allows you to activate or deactivate musical mode. If the **Tempo** column displays "???", you must enter the correct tempo before you can activate **Musical Mode**.

**Tempo**

Displays the tempo of audio files if available. If no tempo has been specified, the column displays "???".

**Sign.**

Displays the time signature, for example, "4/4".

**Key**

Displays the root key if one has been specified for the file.

**Algorithm**

Displays the algorithm preset that is used if the audio file is processed.

- To change the default preset, click the preset name and select another preset from the pop-up menu.

**Info**

For audio clips, this column displays the sample rate, bit depth, number of channels, and length.

For regions, it displays start and end times in frames.

For video clips, it displays the frame rate, resolution, number of frames, and length.

**Type**

Displays the file format of the clip.

**Date**

Displays the date when the audio file was last changed.

**Origin Time**

Displays the original start position where a clip was recorded in the project. As this value can be used as a basis for the **Insert into Project** option in the **Media** or context menu, you can change it if the **Origin Time** value is independent (for example, not for regions).

In the Pool, you can change the value by editing the **Origin Time**. In the **Project** window, you can change the value by moving the event to a new position and selecting **Audio > Update Origin**.

**Image**

Displays waveform images of audio clips or regions.

**Path**

Displays the path to the location of a clip on the hard disk.

**Reel Name**

Audio files may include this attribute, which is then shown in this column. It describes the reel or tape from which the media was originally captured.

**NOTE**

You can rearrange the order of the columns by clicking a header and dragging left or right.

---

## Pool Window Toolbar

The toolbar contains tools and settings for working in the **Pool**.

**Show Info**

Shows/Hides the info line.

### Audition



Plays back the selected audio.

### Audition Loop



Loops the playback until you deactivate **Audition**.

### Audition Volume



Allows you to adjust the volume.

### View/Attributes

Allows you to activate/deactivate the attributes that are displayed in the **Pool** window.

### +/- All

Opens/Closes all folders.

### Import

Allows you to import media files to the **Pool**.

### Search

Allows you to search the **Pool** and connected disks for media files.

### Project Folder

Displays the path to the folder of the active project.

### Pool Record Folder

Displays the path to the **Record** folder of the active project. By default, this is the **Audio** folder. However, you can create a new **Audio** subfolder and designate this as your **Pool** record folder.

## Info Line

The info line shows information about the event or part that you selected in the **Pool**.

- To activate the info line, click **Show Info** at the left of the toolbar.

The info line shows the following information:

### Audio Files

The number of audio files in the **Pool**.

### Used

The number of audio files in use.

### Total Size

The total size of all audio files in the **Pool**.

### External Files

The number of files in the **Pool** that do not reside in the project folder (for example, video files).



## Working with the Pool

### NOTE

Most of the **Pool**-related main menu functions are also available on the **Pool** context menu.

---

## Renaming Clips or Regions in the Pool

### IMPORTANT

Renaming clips or regions in the **Pool** also renames the referenced files on disk. It is recommended to rename clips or regions in the **Pool**. Otherwise, the reference from the clip to the file may get lost.

---

### PROCEDURE

1. In the **Pool** window, select a clip or region, and click the existing name.
  2. Enter a new name and press **Return**.
- 

### RELATED LINKS

[Missing Files](#) on page 486

## Duplicating Clips in the Pool

You can create duplicates of clips and apply different processing methods to them.

### NOTE

Duplicating a clip does not create a new file on disk, but a new edit version of the clip that refers to the same audio file.

---

### PROCEDURE

1. In the **Pool** window, select the clip that you want to duplicate.
  2. Select **Media > New Version**.
- 

### RESULT

A new version of the clip appears in the same **Pool** folder. The duplicated clip has the same name as the original but with a version number after it. Regions within a clip are also copied, but keep their name.

## Inserting Clips into a Project

To insert a clip into a project, you can either use the insert commands on the **Media** menu or use drag and drop.

## Inserting Clips into a Project via Menu Commands

---

### PROCEDURE

1. In the **Pool** window, select the clips that you want to insert into the project.
2. Select **Media > Insert into Project** and select one of the insert options.  
If several clips are selected, choose whether to insert them on one track or each on a different track.

**NOTE**

The clips are positioned so that their snap points are aligned with the selected insert position. If you want to adjust the snap point before inserting a clip, double-click a clip to open the **Sample Editor**. Here, you can adjust the snap position and then perform the insert options.

---

**RESULT**

The clip is inserted on the selected track or on a new audio track. If several tracks are selected, the clip will be inserted on the first selected track.

**RELATED LINKS**

[Adjusting the Snap Point](#) on page 432

## Inserting Clips into a Project via Drag and Drop

You can drag a clip from the **Pool** into the **Project** window.

Snap is taken into account if **Snap** is activated.

If you drag the clip into the **Project** window, the cross-hair cursor and a tooltip are shown. The tooltip indicates the timeline position where the snap point of the clip is aligned.

If you position the clip in an empty area of the track list, that is, where no track exists, a new track is created for the inserted event.

**NOTE**

If you press and hold **Shift** while dragging the clip from the **Pool** on an event, the clip in this event is replaced.

---

**RELATED LINKS**

[Adjusting the Snap Point](#) on page 432

[Replacing Clips in Events](#) on page 170

[Cross-Hair Cursor](#) on page 70

## Deleting Clips from the Pool

You can delete clips from the **Pool** with or without deleting the corresponding file from the hard disk.

## Removing Clips from the Pool

You can remove clips from the **Pool** without deleting the corresponding files from the hard disk.

---

**PROCEDURE**

1. In the **Pool** window, select the clips that you want to remove, and select **Edit > Delete**. You can also press **Backspace** or **Delete**.
  2. Depending on whether the clips are used by an event, you have the following options:
    - If the clips are used by an event, click **Remove** and then click **Remove from Pool**.
    - If the clips are not used by an event, click **Remove from Pool**.
- 

**RESULT**

The clips are no longer available in the **Pool** for this project, but the files still exist on the hard disk and can be used in other projects, etc. This operation can be undone.

## Deleting Files from the Hard Disk

You can delete clips from the **Pool** by deleting the corresponding file from the hard disk. To delete a file permanently from the hard disk, you must first move the corresponding clips to the **Trash** folder in the **Pool**.

### IMPORTANT

Make sure that the audio files that you want to delete are not used in other projects.

---

### PROCEDURE

1. In the **Pool** window, select the clips that you want to delete from the hard disk, and select **Edit > Delete**.

You can also press **Backspace** or **Delete**, or drag the clips into the **Trash** folder.

### NOTE

You can retrieve a clip or region from the **Trash** folder by dragging it back into an **Audio** or **Video** folder.

---

2. Depending on whether the clips are used by an event, you have the following options:
    - If the clips are used by an event, click **Remove** and then click **Trash**.
    - If the clips are not used by an event, click **Trash**.
  3. Select **Media > Empty Trash**.
  4. Click **Erase**.
- 

### RESULT

The files are deleted from the hard disk.

## Removing Unused Clips from the Pool

You can find all clips in the **Pool** that are not used in the project. This allows you to quickly remove all unused clips.

### PREREQUISITE

The **Pool** window is open.

---

### PROCEDURE

1. Select **Media > Remove Unused Media**.
  2. Do one of the following:
    - To move the clips to the **Trash** folder, select **Trash**.
    - To remove the clips from the **Pool**, select **Remove from Pool**.
- 

## Removing Regions from the Pool

### PROCEDURE

- In the **Pool**, select a region and select **Edit > Delete**.  
You can also press **Backspace** or **Delete**.

### IMPORTANT

You are not warned if the region is still in use.

---

## Locating Events and Clips

You can quickly display to which clips the selected events belong and to which events the selected clips belong.

### Locating Events via Clips in the Pool

You can find out which events in the project refer to a particular clip in the **Pool**.

---

#### PROCEDURE

1. In the **Pool** window, select one or more clips.
  2. Select **Media > Select in Project**.
- 

#### RESULT

All events that refer to the selected clips are now selected in the **Project** window.

### Locating Clips via Events in the Project Window

You can find out which clip belongs to a particular event in the **Project** window.

---

#### PROCEDURE

1. In the **Project** window, select one or more events.
  2. Select **Audio > Find Selected in Pool**.
- 

#### RESULT

The corresponding clips are located and highlighted in the **Pool**.

## Searching for Audio Files

The search functions help you locate audio files in the **Pool**, on your hard disk, or on other media. This works much like the regular file search, but with extra features.

---

#### PROCEDURE

1. In the **Pool** window, click **Search** on the toolbar.  
A search pane appears at the bottom of the window, displaying the search functions.

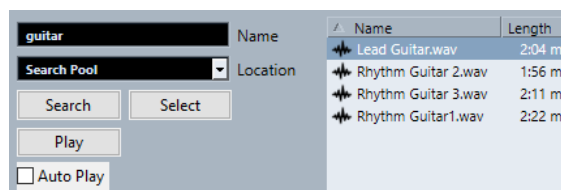

2. Specify the files that you search for in the **Name** field.  
You can use partial names or wildcards (\*).

#### NOTE

Only audio files of the supported formats will be found.

3. Use the **Location** pop-up menu to specify where to search.  
The pop-up menu lists all your local drives and removable media.
  - To limit the search to certain folders, select **Select Search Path**, and in the dialog that opens, select the folder in which you want to search.

The search includes the selected folder and all subfolders.

**NOTE**

Folders that you have recently selected using the **Select Search Path** function appear on the pop-up menu, so that you can quickly select them again.

---

4. Click **Search**.

The search is started and **Search** is labeled **Stop**.

- To cancel the search, click **Stop**.

When the search is finished, the files that are found are listed on the right.

- To audition a file, select it in the list and use the playback controls to the left (Play, Stop, Pause, and Loop). If **Auto Play** is activated, selected files are automatically played back.
- To import a file into the **Pool**, double-click the file in the list or select it and click **Import**.

5. To close the search pane, click **Search** on the toolbar again.

---

## Using the Extended Search Functionality

Apart from the search criterion **Name**, additional search filters are available. The extended search options allow for a detailed search, helping you to master even the largest sound database.

---

PROCEDURE

1. In the **Pool** window, click **Search** on the toolbar.

The search pane is displayed in the lower part of the **Pool** window.

2. Click **Name** to open the extended search pop-up menu where you can select and define a search criterion.



The menu also contains the **Add Filter** and **Presets** submenus.

The search criteria have the following parameters:

- **Name:** partial names or wildcards (\*)
- **Size:** less than, more than, equal, between (two values), in seconds, minutes, hours, and bytes
- **Bit Depth:** 8 bit, 16 bit, 24 bit, 32 bit, 32 bit float, 64 bit float
- **Channels:** mono, stereo, and from 3 to 16
- **Sample Rate:** various values, choose **Other** for free setting
- **Date:** various search ranges

3. Select one of the search criteria in the pop-up menu.

The search criterion changes to the selected criterion.

4. Optional: To display more search options, open the extended search pop-up menu, select the **Add Filter** submenu, and select an element.

5. Optional: To save your search filter settings as a preset, open the extended search pop-up menu, select **Presets > Save Preset**, and enter a name for the preset.

Saved presets are added to the **Presets** submenu.

6. Optional: To remove a search filter settings preset, open the extended search pop-up menu, select the preset, and then select **Remove Preset**.

---

## Missing Files

When you open a project and one or more files are missing, the **Resolve Missing Files** dialog opens. If you click **Close**, the project opens without the missing files.

In the **Pool**, you can check which files are considered missing. This is indicated by a question mark in the **Status** column.

A file is considered missing under one of the following conditions:

- The file has been moved or renamed outside the program since you last worked with the project, and you ignored the **Resolve Missing Files** dialog when you opened the project for the current session.
- You have moved or renamed the file outside the program during the current session.
- You have moved or renamed the folder in which the missing files are located.

## Locating Missing Files

---

### PROCEDURE

1. Select **Media > Find Missing Files**.
  2. In the **Resolve Missing Files** dialog, decide if you want the program to find the file for you (**Search**), if you want to find it yourself (**Locate**), or if you want to specify in which directory the program searches for the file (**Folder**).
    - If you select **Search**, a dialog opens to let you specify which folder or disk the program scans. Click **Search Folder**, select a directory or a disk, and click **Start**. If found, select the file from the list and click **Accept**. Afterwards, Cubase tries to map all other missing files automatically.
    - If you select **Locate**, a file dialog opens, allowing you to locate the file manually. Select the file and click **Open**.
    - If you select **Folder**, a dialog opens to let you specify the directory in which the missing file can be found. This might be the preferred method if you have renamed or moved the folder containing the missing file, but the file still has the same name. Once you select the correct folder, the program finds the file and you can close the dialog.
- 

## Reconstructing Missing Edit Files

If a missing file cannot be found, this is normally indicated with a question mark in the **Status** column in the **Pool**. However, if the missing file is an edit file (a file that is created when you process audio and that is stored in the **Edits** folder within the project folder), it may be possible for the program to reconstruct it by recreating the editing to the original audio file.

### PROCEDURE

1. In the **Pool** window, locate the clips for which files are missing.
  2. Check the **Status** column. If the status of the files is "Reconstructible", the files can be reconstructed by Cubase.
  3. Select the reconstructible clips and select **Media > Reconstruct**.
- 

### RESULT

The editing is performed and the edit files are recreated.

## Removing Missing Files from the Pool

If the **Pool** contains audio files that cannot be found or reconstructed, you may want to remove these.

---

### PROCEDURE

- In the **Pool** window, select **Media > Remove Missing Files**.
- 

### RESULT

All missing files from the **Pool** and the corresponding events from the **Project** window are removed.

## Auditioning Clips in the Pool

You can audition clips in the **Pool** using key commands, the **Audition** button, or by clicking in the waveform image for a clip.

- Use key commands.  
If you activate **Playback Toggle Triggers Local Preview** in the **Preferences** dialog (**Transport** page), you can use **Space** to audition. This is the same as activating **Audition** on the toolbar.
- Select a clip and activate **Audition**.  
The whole clip plays back. To stop playback, click **Audition** again.
- Click in the waveform image for a clip.  
The clip plays back from the selected position in the waveform until the end. To stop playback, click **Audition** or anywhere else in the **Pool** window.

The audio is routed directly to the **Main Mix** (the default output) bus, bypassing the settings of the audio channel, effects, and EQs.

### NOTE

You can adjust the auditioning level with the miniature level fader on the toolbar. This does not affect the regular playback level.

---

If you have activated **Audition Loop** before you audition, the following happens:

- When you click **Audition** to audition a clip, the clip is repeated indefinitely until you stop playback by clicking **Audition** or **Audition Loop** again.
- When you click in the waveform image to audition, the section from the selected point to the end of the clip is repeated indefinitely until you stop playback.

## Opening Clips in the Sample Editor

The **Sample Editor** allows you to perform detailed editing on the clip.

- To open a clip in the **Sample Editor**, double-click a clip waveform icon or a clip name in the **Media** column.
- To open a certain region of a clip in the **Sample Editor**, double-click a region in the **Pool**.  
You can use this to set a snap point for a clip, for example. When you later insert the clip from the **Pool** into the project, the defined snap point allows it to be properly aligned.

### RELATED LINKS

[Adjusting the Snap Point](#) on page 432  
[Sample Editor](#) on page 413

## Importing Media

The **Import Medium** dialog lets you import files directly into the **Pool**.

To open the dialog, select **Media > Import Medium**, or click **Import** on the **Pool** toolbar.

This opens a standard file dialog, where you can navigate to other folders, audition files, etc. The following audio file formats can be imported:

- Wave (Normal or Broadcast)
- AIFF and AIFC (Compressed AIFF)
- REX or REX 2
- FLAC (Free Lossless Audio Codec)
- MPEG Layer 2 and Layer 3 (MP2 and MP3 files)
- Ogg Vorbis (OGG files)
- Windows Media Audio (Windows only)
- Wave 64 (W64 files)

The following characteristics are possible:

- Stereo or mono
- Any sample rate

### NOTE

Files that have a different sample rate than the project sample rate are played back at the wrong speed and pitch.

- 8 bit, 16 bit, 24 bit, 32 bit, 32 bit float, or 64 bit float
- Various video formats

### NOTE

You can also use the commands on the **Import** submenu of the **File** menu to import audio or video files into the **Pool**.

### RELATED LINKS

[Wave Files](#) on page 807

[Importing ReCycle Files](#) on page 257

[Supported Compressed Audio File Formats](#) on page 254

[Video File Compatibility](#) on page 833

## Importing Audio CDs into the Pool

You can import tracks or sections of tracks from an audio CD directly into the **Pool**. This opens a dialog in which you can specify which tracks are copied from the CD, converted to audio files, and added to the **Pool**.

- To import an audio CD to the **Pool**, select **Media > Import Audio CD**.

### RELATED LINKS

[Importing Audio CD Tracks](#) on page 254



## Import Options Dialog

The **Import Options** dialog allows you to specify how audio files are imported into the **Pool**.

- If you select a file in the **Import Medium** dialog and click **Open**, the **Import Options** dialog opens.

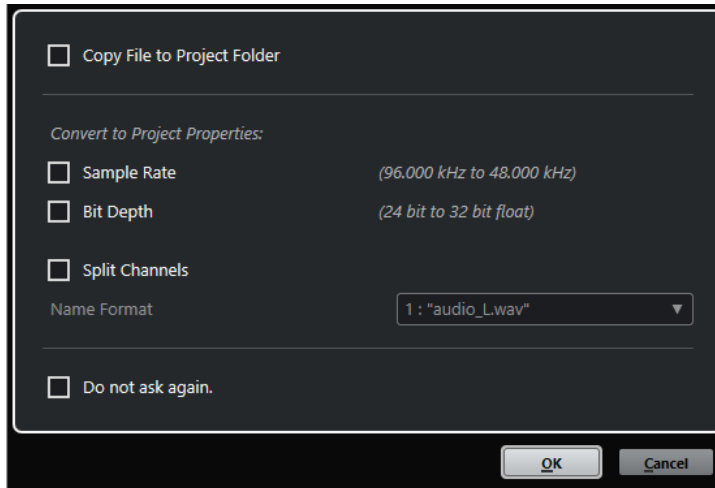

**Import Options** dialog for single file import

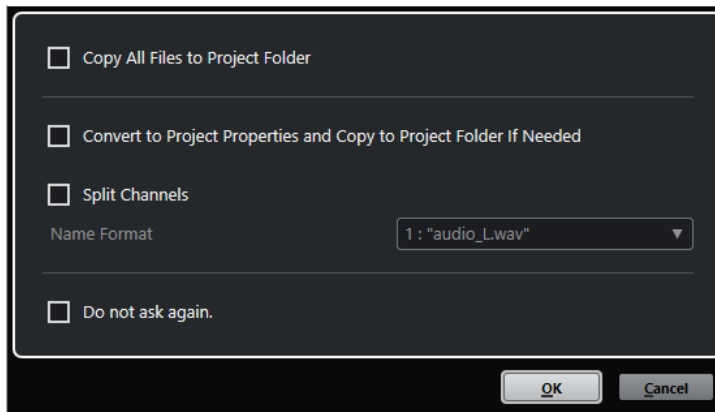

**Import Options** dialog for multiple file import

### Copy File to Project Folder/Copy All Files to Project Folder

Copies the audio file to the **Audio** folder of the project, and has the clip refer to the copy.

Deactivate this option to have the clip refer to the original file in the original location. In this case, it is marked as "external" in the **Pool**.

### Convert to Project Settings/Convert to Project Settings and Copy to Project Folder If Needed

Converts the imported file if the sample rate or the bit depth differ from the settings in the **Project Setup** dialog. For single file import, you can choose which properties are converted.

### Split Channels

Splits stereo or multichannel audio files into a corresponding number of mono files, one for each channel, and copies the imported files to the **Audio** folder of the project.

The split files are inserted into the project and into the **Pool** as separate mono tracks.

The **Name Format** pop-up menu allows you to specify how the split files are named. This allows for compatibility with other products when exchanging audio files.

**Do not ask again**

Always imports files according to the settings without opening the dialog again. You can reset this option in the **Preferences** dialog (**Editing—Audio** page).

RELATED LINKS

[Pool Window Columns](#) on page 478

[Converting Files](#) on page 492

## Exporting Regions as Audio Files

If you have created regions within an audio clip, these can be exported as separate audio files. If you have two clips that refer to the same audio file, you can create a separate audio file for each clip.

---

PROCEDURE

1. In the **Pool** window, select the region that you want to export.
2. Select **Audio > Bounce Selection**.
3. Select the folder in which you want the new file to be created and click **OK**.
4. Optional: If you are using the **Bounce Selection** option to create a separate audio file for a clip that refers to the same audio file as another clip, enter a name for the new audio file.

---

RESULT

A new audio file is created in the specified folder. The file has the name of the region and is automatically added to the **Pool**.

RELATED LINKS

[Creating Audio Events from Regions](#) on page 431

## Changing the Pool Record Folder

All audio clips that you record in the project are saved in the **Pool Record** folder. The **Pool Record** folder is indicated by the text **Record** in the **Status** column and by a dot on the folder itself.

By default, this is the main **Audio** folder. However, you can create a new **Audio** subfolder and designate this as your **Pool Record** folder.

**NOTE**

The folders that you create in the **Pool** are only for organizing your files in the **Pool**. All files are recorded to the folder that you specified as the **Pool Record** folder.

---

PROCEDURE

1. In the **Pool**, select the **Audio** folder or any audio clip.

**NOTE**

You cannot designate the **Video** folder or any of its subfolders as the **Pool Record** folder.

2. Select **Media > Create Folder**.
3. Rename the new folder.

4. Select the new folder and select **Media > Set Pool Record Folder**, or click in the **Status** column of the new folder.
- 

#### RESULT

The new folder becomes the **Pool Record** folder. Any audio recorded in the project is saved in this folder.

## Organizing Clips and Folders

If you accumulate a large number of clips in the **Pool**, it can be difficult to quickly find specific items. Organizing clips in new subfolders with names that reflect the content can be a solution. For example, you could put all sound effects in one folder, all lead vocals in another, etc.

---

#### PROCEDURE

1. In the **Pool** window, select the folder for which you want to create a subfolder.

#### NOTE

You cannot put audio clips in a video folder and vice versa.

---

2. Select **Media > Create Folder**.
  3. Rename the folder.
  4. Drag the clips to the new folder.
- 

## Applying Processing to Clips in the Pool

You can apply audio processing to clips from within the **Pool** in the same way as to events in the **Project** window.

---

#### PROCEDURE

1. In the **Pool** window, select the clips that you want to process.
  2. Select **Audio > Direct Offline Processing** and select a processing method.
- 

#### RESULT

A waveform symbol indicates that the clips have been processed.

#### RELATED LINKS

[Direct Offline Processing](#) on page 386

## Undoing Processing

You can undo processing that has been applied to clips.

---

#### PROCEDURE

1. In the **Pool** window, select the clip from which you want to remove the processing.
  2. Select **Audio > Direct Offline Processing**.
  3. Select the action that you want to remove, and click **Delete**.
-

## Minimizing Files

You can minimize the audio files according to the size of the audio clips referenced in the project. The files that are produced using this option only contain the audio file portions that are actually used in the project.

This can significantly reduce the size of the project if large portions of the audio files are unused. Therefore, the option is useful for archiving purposes after you have completed a project.

### IMPORTANT

This operation permanently changes the selected audio files in the **Pool**. This cannot be undone. If you only want to create the minimized audio files as a copy, leaving the original project untouched, you can use the **Back up Project** option.

---

### NOTE

Minimizing files clears the entire edit history.

---

### PROCEDURE

1. In the **Pool** window, select the files that you want to minimize.
  2. Select **Media > Minimize File**.
  3. Click **Minimize**.  
After the minimizing is finished, the file references in the stored project become invalid.
  4. Do one of the following:
    - To save the updated project, click **Save Now**.
    - To proceed with the unsaved project, click **Later**.
- 

### RESULT

Only the audio portions that are actually used in the project remain in the corresponding audio files in the **Pool Record** folder.

### RELATED LINKS

[Backing up Projects](#) on page 92

## Converting Files

In the **Pool**, you can convert files to another format.

---

### PROCEDURE

1. In the **Pool** window, select the files that you want to convert.
  2. Select **Media > Convert Files**.
  3. In the **Convert Options** dialog, make your changes and click **OK**.
- 

## Convert Options Dialog

In this dialog, you can convert audio files in the **Pool**.

- To open the **Convert Options** dialog, select a clip in the **Pool** window, and select **Media > Convert Files**.

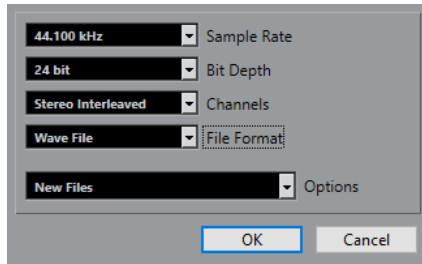

### Sample Rate

Allows you to convert to another sample rate.

### Bit Depth

Allows you to convert to 16 bit, 24 bit, 32 bit, 32 bit float, or 64 bit float.

### Channels

Allows you to convert to mono or stereo interleaved.

### File Format

Allows you to convert to Wave, AIFF, FLAC, Wave 64, or Broadcast Wave Format.

### Options

You can use the **Options** pop-up menu to set one of the following options:

- **New Files**  
Creates a copy of the file in the audio folder and converts this new file according to the chosen attributes. The new file is added to the **Pool**, but all clip references still point to the original, unconverted file.
- **Replace Files**  
Converts the original file without changing clip references. However, the references are saved with the next save action.
- **New + Replace in Pool**  
Creates a new copy with the chosen attributes, replaces the original file with the new one in the **Pool** and redirects the current clip references from the original file to the new file. Select this option if you want your audio clips to refer to the converted file, but want to keep the original file on disk, for example, if the file is used in other projects.

## Extracting Audio from Video File

You can extract audio from video files. This automatically generates a new audio clip that appears in the **Pool Record** folder.

### NOTE

This function is not available for MPEG-1 video files.

---

### PROCEDURE

1. In the **Pool** window, select **Media > Extract Audio from Video File**.
  2. Select the video file from which you want to extract audio and click **Open**.
- 

### RESULT

The audio is extracted from the video file. The audio file gets the same file format and sample rate/width as in the current project, and the same name as the video file.

# MediaBay and Media Rack

You can manage media files on your computer as well as presets from multiple sources from within the **MediaBay** or the **Media** rack.

The **MediaBay** window offers advanced functions for working with media files and managing database items. To show the media files on your computer in the **MediaBay**, you must scan the folders or volumes that contain the files so that these are added to the database.

The **Media** rack in the right zone of the **Project** window allows you to access some of the most important **MediaBay** functions from within a fixed zone of the **Project** window. For quick access to specific media files, the **Media** rack allows you to add specific folders on your computer as favorites. Media files within the favorite folders that you add in the **Media** rack are automatically scanned and added to the database.

## RELATED LINKS

[MediaBay Window](#) on page 504

[Scanning Folders](#) on page 508

[Media Rack in Right Zone](#) on page 494

[Adding Favorites Using the Favorites Page](#) on page 503

[Adding Favorites Using the File Browser Page](#) on page 503

## Media Rack in Right Zone

The **Media** rack in the right zone of the **Project** window allows you to access the **MediaBay** functions from within a fixed zone of the **Project** window.

- To open the **Media** rack in the right zone, click **Show/Hide Right Zone** on the **Project** window toolbar, and at the top of the right zone, click the **Media** tab.

The **Media** rack opens on the **Home** page that features different tiles. These tiles correspond to the available media types.

## RELATED LINKS

[Showing/Hiding Zones](#) on page 31

[Home Page](#) on page 494

[Project Window Toolbar](#) on page 32

## Home Page

The **Home** page gives you access to the tiles that correspond to the available media types, to the **Favorites**, and to the **File Browser**.

- To open the **Home** page, click the **Home** navigation control on the **Media** rack.

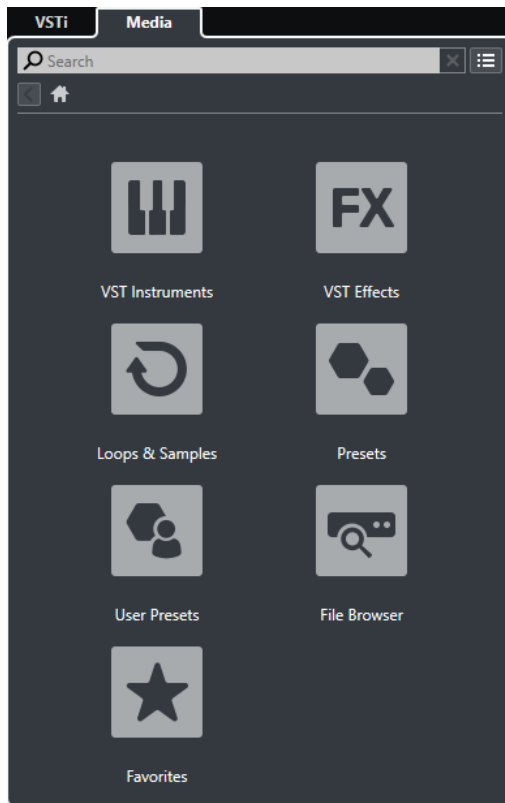

The following tiles are available:

#### **VST Instruments**

Shows VST instruments and instrument presets.

#### **VST Effects**

Shows VST effects and effect presets.

#### **Loops & Samples**

Shows audio loops, MIDI loops, or instrument sounds ordered by content set.

#### **Presets**

Shows track presets, strip presets, pattern banks, FX chain presets, and VST FX presets.

#### **User Presets**

Shows track presets, strip presets, pattern banks, FX chain presets, VST FX presets, and instrument presets that are listed in the **User Content** folder.

#### **Favorites**

Shows your favorite folders and allows you to add new favorites. The folder content is automatically added to the **MediaBay** database.

#### **File Browser**

Shows your file system and the pre-defined folders **Favorites**, **This Computer**, **VST Sound**, **Factory Content**, and **User Content** where you can search for media files and access them immediately.

#### RELATED LINKS

[Loading Instrument Presets](#) on page 529

[Loading Loops and Samples](#) on page 528

[Loading Track Presets](#) on page 529

- [Loading Effect Plug-In Presets](#) on page 530
- [Loading FX Chain Presets](#) on page 530
- [Loading Strip Presets](#) on page 531
- [Loading Pattern Banks](#) on page 531
- [Adding Favorites Using the Favorites Page](#) on page 503
- [Adding Favorites Using the File Browser Page](#) on page 503

## Favorites Page

The **Favorites** page allows you to add your own favorite folders to the **Media** rack.

### 1 Add Favorite

Opens a file dialog where you can navigate to the location of a folder and add it as a favorite folder.

### 2 Favorite folders

The folders that you added as favorites are shown as tiles on the **Favorites** page.

- To show the content of a folder, click it.
- To delete a folder from the **Favorites** page, click its close button.

#### RELATED LINKS

- [Adding Favorites Using the Favorites Page](#) on page 503

## Results Page

The **Results** page shows all media files that are found in the defined favorite folder.

- To open the **Results** page, click the **Show All Results** navigation control on the **Media** rack.

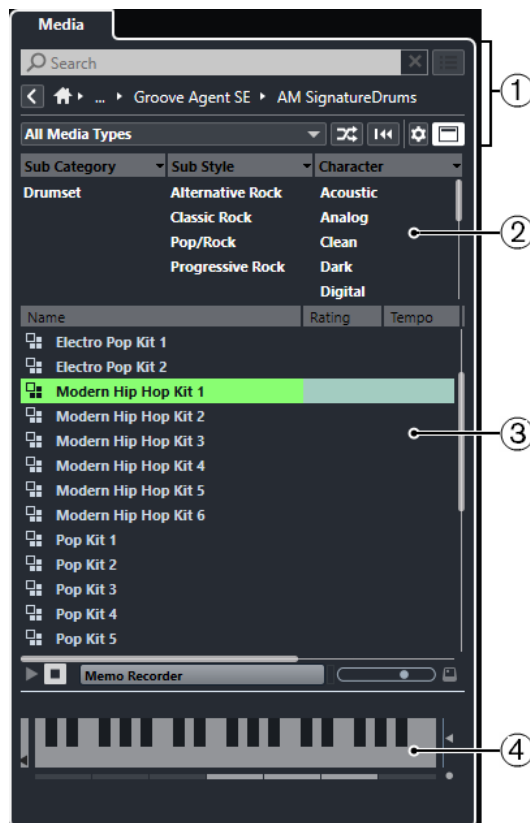

The following options are available:



- 1 Media Rack navigation controls**  
Allow you to navigate to specific folders and filter the **Results** list.
- 2 Attribute filter**  
Allows you to view and edit some of the standard file attributes found in your media files.
- 3 Results list**  
Shows all media files that are found in the selected folder and allows you to select a media file.
- 4 Previewer**  
Allows you to preview the selected media file.

RELATED LINKS

- [Media Rack Navigation Controls](#) on page 500
- [Setting up the Results List Columns](#) on page 510
- [Attribute Inspector](#) on page 524
- [Results Section](#) on page 510
- [Previewer Section](#) on page 515

## File Browser Page

The **File Browser** page shows all media files that are found in the **File Browser**.

- To open the **File Browser** page, go to the **Home** page of the **Media** rack, and click **File Browser**.

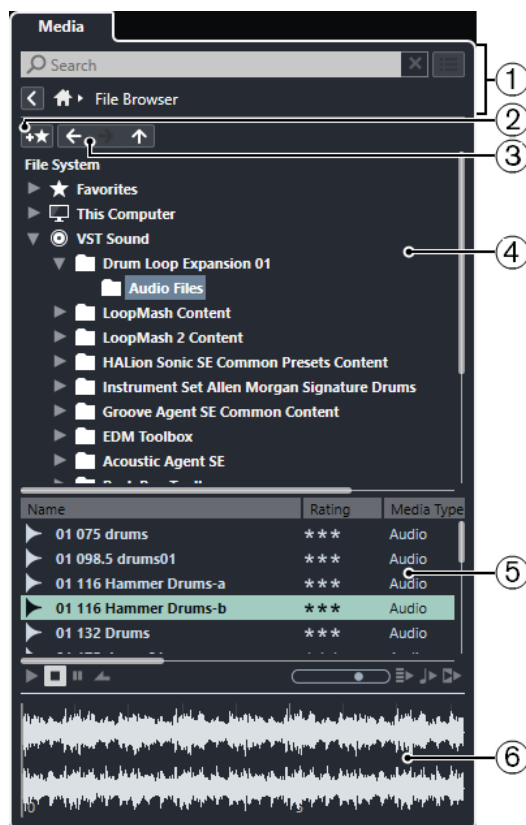

The following options are available:

- 1 Media Rack navigation controls**  
Allow you to navigate to specific folders and filter the **Results** list.
- 2 Add Favorite**

Allows you to add the selected folder as a favorite folder.

**3 Back/Forward/Up**

**Up** navigates to the parent folder. **Back** navigates to the previously used folder. **Forward** navigates to the most recent folder.

**4 File browser**

Allows you to browse selected folders.

**5 Results list**

Shows all supported media files that are found in the selected folder and allows you to select a media file.

**6 Previewer**

Allows you to preview the selected media file.

RELATED LINKS

[Media Rack Navigation Controls](#) on page 500

[File Browser Section](#) on page 508

[Results Section](#) on page 510

[Previewer Section](#) on page 515

## VST Instruments Page

The **VST Instruments** page shows all VST instruments of the selected collection.

- To open the **VST Instruments** page, go to the **Home** page of the **Media** rack, and click **VST Instruments**.

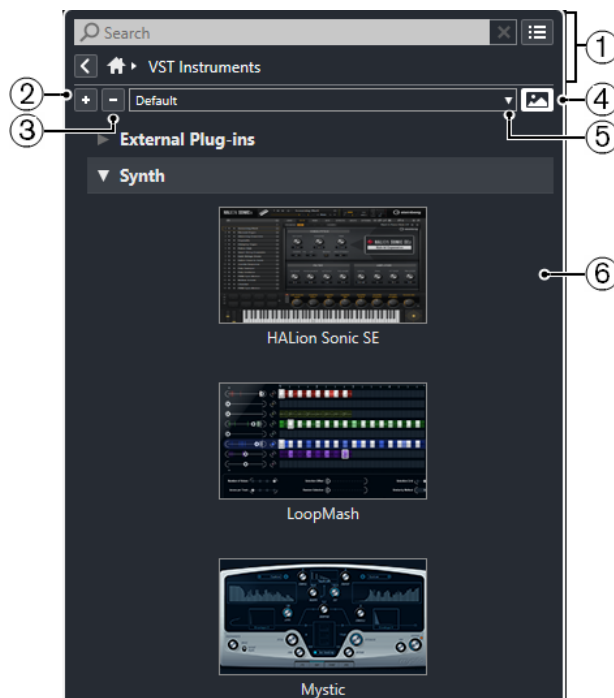

The following options are available:

**1 Media Rack navigation controls**

Allow you to navigate to specific folders and filter the **Results** list.

**2 Expand All**

Expands all results.

**3 Collapse All**

Collapses all results.

#### 4 Show/Hide VST Plug-in Pictures

Shows/Hides the pictures of the VST instrument control panels.

#### 5 Plug-in Collections and Options

- **Default** activates the default collection.
- **Sort By Category** sorts the collection by category. This is only available for the **Default** collection.
- **Sort By Vendor** sorts the collection by vendor. This is only available for the **Default** collection.
- **Plug-in Manager** opens the **Plug-in Manager** that allows you to create new plug-in collections. These will be listed in the **Plug-in Collections and Options** menu below the **Default** collection.

#### 6 Plug-in list

Shows the plug-ins of the selected collection.

#### RELATED LINKS

[VST Plug-in Manager Window](#) on page 564

[Adding Pictures of VST Instruments to the Media Rack](#) on page 503

## VST Effects Page

The **VST Effects** page shows all VST effects of the selected collection.

- To open the **VST Effects** page, go to the **Home** page of the **Media** rack, and click **VST Effects**.

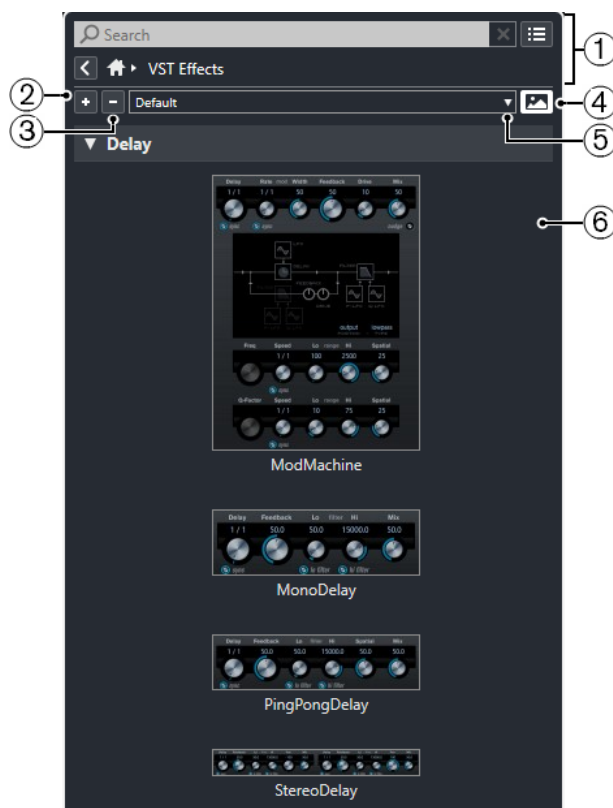

The following options are available:

#### 1 Media Rack navigation controls

Allow you to navigate to specific folders and filter the **Results** list.

**2 Expand All**

Expands all results.

**3 Collapse All**

Collapses all results.

**4 Show/Hide VST Plug-in Pictures**

Shows/Hides the pictures of the VST effect control panels.

**5 Plug-in Collections and Options**

- **Default** activates the default collection.
- **Sort By Category** sorts the collection by category. This is only available for the **Default** collection.
- **Sort By Vendor** sorts the collection by vendor. This is only available for the **Default** collection.
- **Plug-in Manager** opens the **Plug-in Manager** that allows you to create new plug-in collections. These will be listed in the **Plug-in Collections and Options** menu below the **Default** collection.

**6 Plug-in list**

Shows the plug-ins of the selected collection.

RELATED LINKS

[VST Plug-in Manager Window](#) on page 564

[Adding Pictures of VST Effects to the Media Rack](#) on page 504

## Media Rack Navigation Controls

The navigation controls allow you to navigate to files and folders in the **Media** rack.

The following controls allow you to perform a text search, and to show all results on the current page.



**1 Search**

Allows you to search media files by name or by attribute.

**2 Reset Search**

Allows you to reset the search.

**3 Show All Results**

Shows the **Results** page for a selected tile. If no tile is selected, all media files are shown.

The following controls allow you to navigate from the current page to other pages.

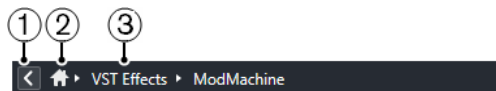

**1 Back**

Allows you to navigate back to the previous page.

**2 Home**

Allows you to navigate back to the **Home** page.

**3 Breadcrumb path**

Shows the path to the current page and allows you to navigate back to the previous page.

The following controls allow you to set up and modify the **Results** page.



- 1 Select Media Types**  
Allows you to select the media types that are displayed on the **Results** page.
- 2 Shuffle Results**  
Shuffles the **Results** page.
- 3 Reset Attribute Filter**  
Lights up if an attribute filter is set. Click this button to reset the attribute filter.
- 4 Set up Result Columns**  
Allows you to specify which attribute columns are displayed on the **Results** page.
- 5 Show/Hide Attribute Filters**  
Shows/Hides the **Attribute Filters** section.

#### RELATED LINKS

- [Home Page](#) on page 494
- [Results Page](#) on page 496
- [Media File Attributes](#) on page 522

## Working with the Media Rack

The **Media** rack in the right zone of the **Project** window allows you to search for supported media files and included VST instruments, and add them to your project.

The controls on the different pages of the **Media** rack allow you to browse, filter, select, and to preview your media files.

The **Favorites** page and the **File Browser** page allow you to add folders where your media files are located as **Favorites**. This helps you to quickly navigate to these media files.

The tiles and controls on the different pages of the **Media** rack allow you to browse, filter, select, and preview the content.

Once you have located the media file, the instrument, or the preset that you want to use, and selected it in the **Results** list, you can insert it into your project by using drag and drop, by using the context menu options, or by double-clicking.

#### RELATED LINKS

- [Media Rack in Right Zone](#) on page 494
- [Results Page](#) on page 496

## Adding VST Instruments to Projects

You can use the **Media** rack to add VST instruments to your project.

---

#### PROCEDURE

1. In the **Media** rack, click the **VST Instruments** tile.
2. Drag an instrument on the track list or on the event display.

**NOTE**

To exchange the VST instrument of an instrument track, drag the instrument from the **Media** rack, and drop it on the top section of the instrument track **Inspector**. Note that you must update the track name manually if needed.

---

RELATED LINKS

[Loading Instrument Presets](#) on page 529

## Adding VST Effects to Projects

You can use the **Media** rack to add VST effects to your project.

PROCEDURE

1. In the **Media** rack, click the **VST Effects** tile.
  2. Do one of the following:
    - Drag an effect on the track list to create an FX channel track.
    - To add the effect to an audio-related track, drag the effect from the **Media** rack, and drop it in the **Inserts** or **Sends** section of the track **Inspector**.
    - To add the effect to an audio-related channel, drag the effect from the **Media** rack, and drop it in the **Inserts** or **Sends** section of the **MixConsole** in the lower zone of the **Project** window, or the **Channel Settings** window.
- 

RELATED LINKS

[Loading Effect Plug-In Presets](#) on page 530

## Applying Track Presets

You can use the **Media** rack to add track presets to your project.

PROCEDURE

1. In the **Media** rack, click the **Presets** tile.
2. Click **Track Presets**.
3. Click **Audio**, **VST Instruments**, **MIDI**, **Multi**, or **Sampler** depending on the track type.
4. Do one of the following:
  - Drag a track preset on the **Inspector** or in the track list for the corresponding track type.
  - Drag a track preset below the track list to add a new track with the track preset loaded.

**NOTE**

To exchange the track preset of a track, drag the preset from the **Media** rack, and drop it on the track in the track list. Note that you must update the track name manually if needed.

---

RESULT

The track preset is applied.

## Adding Favorites Using the Favorites Page

You can add favorite folders to the **Favorites** page. This allows you to directly access media files in specific folders.

---

### PROCEDURE

1. In the **Media** rack, click the **Favorites** tile.
2. At the top left of the page, click **Add Favorite**.
3. Select the folder that you want to add as a **Favorite**.
4. Click **OK**.

---

### RESULT

- The favorite folder is added to the database.
- On the **Favorites** page, a new tile with the specified name is added.
- In the **File Browser**, a new folder with the specified name is added to the **Favorites** folder.

### RELATED LINKS

[Favorites Page](#) on page 496

## Adding Favorites Using the File Browser Page

You can add favorite folders using the **File Browser** page. This allows you to directly access media files in specific folders.

---

### PROCEDURE

1. In the **Media** rack, click the **File Browser** tile.
2. In the **File Browser**, navigate to the folder that you want to add as a favorite and select it.
3. Do one of the following:
  - At the top left of the page, click **Add Favorite**.
  - Right-click the folder, and from the context menu, select **Add Favorite**.
4. In the **Set Name** dialog that opens, enter a name for the folder.
5. Click **OK**.

---

### RESULT

- The favorite folder is added to the database.
- In the **File Browser**, a new folder with the specified name is added to the **Favorites** folder.
- On the **Favorites** page, a new tile with the specified name is added.

### RELATED LINKS

[File Browser Page](#) on page 497

## Adding Pictures of VST Instruments to the Media Rack

Pictures of VST instruments from other vendors are not loaded by default. However, you can add them to the **Media** rack manually.

### PREREQUISITE

You have added the VST instrument of another vendor as a rack or a track instrument.

---

PROCEDURE

1. Open the control panel of the VST instrument.
  2. On the control panel, click **Add VST Plug-in Picture to Media Rack**.
- 

RESULT

The picture of the VST instrument is shown in the **Media** rack.

RELATED LINKS

[Adding VST Instruments](#) on page 547

[VST Instrument Control Panel](#) on page 548

## Adding Pictures of VST Effects to the Media Rack

Pictures of VST effects from other vendors are not loaded by default. However, you can add them to the **Media** rack manually.

PREREQUISITE

You have added a VST effect from another vendor.

---

PROCEDURE

1. Open the control panel of the VST effect.
  2. On the control panel, click **Add VST Plug-in Picture to Media Rack**.
- 

RESULT

The picture of the VST effect is shown in the **Media** rack.

RELATED LINKS

[Adding Insert Effects](#) on page 364

[Effect Control Panel](#) on page 376

## MediaBay Window

To open the **MediaBay** in a separate window, do one of the following:

- Select **Media > MediaBay**.
- Press **F5**.





The **MediaBay** is divided into the following sections:

**1 File Browser**

Allows you to scan specific folders in your file system, and to add favorites.

**2 Toolbar**

Contains tools and shortcuts for settings and functions in the **MediaBay**, and allows you to switch between the previously defined favorite locations. Favorites in the **MediaBay** window are not automatically scanned.

**3 Filters**

Allows you to filter the **Results** list using a logical or an attribute filter.

**4 Results**

Displays all supported media files. You can filter the list and perform text searches.

**5 Previewer**

Allows you to preview the files shown in the **Results** list.

**6 Attribute Inspector**

Allows you to view, edit, and add media file attributes or tags.

RELATED LINKS

[File Browser Section](#) on page 508

[MediaBay Toolbar](#) on page 506

[Adding Favorites](#) on page 509

[Scanning Folders](#) on page 508

[Filters Section](#) on page 520

[Results Section](#) on page 510

[Previewer Section](#) on page 515

[Attribute Inspector](#) on page 524

[Setting up the MediaBay](#) on page 508

## MediaBay Toolbar

The toolbar contains tools and shortcuts for settings and functions in the **MediaBay**.

### Navigation

#### Back



Navigates to the previously used folder.

#### Forward



Navigates to the most recent folder.

#### Up



Navigates to the parent folder.

### Favorites

#### Add Favorite



Allows you to add the selected folder as a favorite folder.

#### Select Defined Favorite

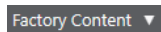

Allows you to select a **Favorite** to quickly browse to the files you are looking for.

#### Include Folders and Subfolders



Activate this to show the content of folders and subfolders.

### Left Divider

#### Left Divider

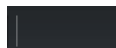

Tools that are placed to the left of the divider are always shown.

### Text Search

#### Search

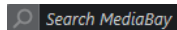

Allows you to search media files by name or by attribute.

### Media Types Filter

#### Select Media Types

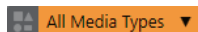

Allows you to select the media types that are displayed on the **Results** page.

### Rating Filter

#### Rating Filter

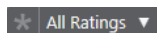

Filters files according to their rating.

## Reset Result Filters

### Reset Filters



Allows you to reset the filters.

## Results

### Update Results



Updates the results.

### Shuffle Results



Shuffles the **Results** page.

## Attribute Counter

### Attribute Counter



Shows the number of attributes that are being updated.

## Right Divider

### Right Divider



Tools that are placed to the right of the divider are always shown.

## MediaBay Settings

### MediaBay Settings



Opens the **MediaBay** settings.

## Window Zone Controls

### Show/Hide Left Zone



Shows/Hides the left zone of the window.

### Show/Hide Lower Zone



Shows/Hides the lower zone of the window.

### Show/Hide Right Zone



Shows/Hides the right zone of the window.

### Set up Window Layout



Allows you to set up the window layout.

### Set up Toolbar



Opens a pop-up menu where you can set up which toolbar elements are visible.

## Setting up the MediaBay

You can show and hide the different sections of the **MediaBay**. This saves screen space and allows you to display only the information that you need.

---

### PROCEDURE

1. Click **Set up Window Layout**.
  2. Activate/Deactivate the checkboxes for the sections that you want to show/hide.
  3. Click outside the pane to exit the setup mode.
- 

## File Browser Section

The **File Browser** section shows your file system with the pre-defined folders **Favorites**, **This Computer**, **VST Sound**, **Factory Content**, and **User Content**.

- To open the **File Browser** section in the **MediaBay**, click **Set up Window Layout** and activate **File Browser**.

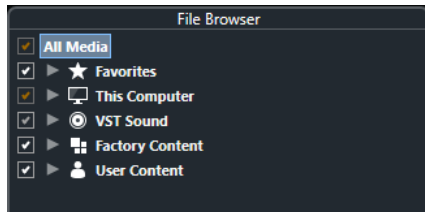

To show the supported media files in the **Results** section of the **MediaBay**, you must scan all folders that you want to include in the search.

You can also add favorite folders. All media files contained in a **Favorite** are automatically scanned.

### RELATED LINKS

[Scanning Folders](#) on page 508

[Adding Favorites](#) on page 509

## Scanning Folders

To include specific folders in the **MediaBay** search, you must scan them.

---

### PROCEDURE

1. In the **File Browser** section of the **MediaBay**, navigate to the folder that you want to include in the scan.
2. Activate the checkbox for the folder to activate the scan.

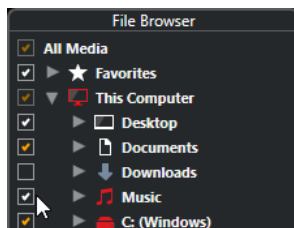

#### RESULT

All files that are found in the scanned folder are shown in the **Results** list. The scan result is saved in a database file.

The color of the checkmark helps you to identify which folders and subfolders are scanned:

- White indicates that all subfolders are included in the scan.
- Orange indicates that at least one subfolder is excluded from the scan.

The color of the folder indicates the state of the scan:

- Red indicates that a folder is currently being scanned.
- White indicates that all subfolders have been scanned.
- Yellow indicates that at least one subfolder is not yet scanned.

#### NOTE

Please wait until the **MediaBay** completes the scan to continue your work.

---

## Adding Favorites

You can add favorite folders using the **File Browser** section.

---

#### PROCEDURE

1. In the **File Browser** section, navigate to the folder that you want to add as a favorite, and select it.
  2. Right-click the folder or the volume, and from the context menu, select **Add Favorite**.
  3. In the **Set Name** dialog that opens, enter a name for the folder.
  4. Click **OK**.
- 

#### RESULT

- In the **File Browser** section, a new folder with the specified name is added to the **Favorites** folder.
- In the **Favorites** section, the added favorite is available in the **Select Defined Favorite** pop-up menu.
- In the **Media** rack in the right zone of the **Project** window, a new tile with the specified name is added on the **Favorites** page.

#### NOTE

Favorites in the **MediaBay** window are not automatically scanned.

---

#### AFTER COMPLETING THIS TASK

To remove a **Favorite**, select it in the **Favorites** tree of the **File Browser** section, open the context menu and select **Remove Favorite**.

#### RELATED LINKS

[Scanning Folders](#) on page 508

## Refresh Views

If you change already scanned folders by adding or removing files when Cubase is closed, you must rescan the corresponding media folders. This also applies if you modified attributes of your user content using another program.

If you have made changes to your content and want the changes to be displayed in the **MediaBay**, you must refresh the views of the corresponding media folders.

- To refresh a folder, in the **File Browser** section of the **MediaBay**, right-click a folder, and select **Refresh Views**.
- To display a new drive, in the **File Browser** section of the **MediaBay**, right-click the parent node, and select **Refresh Views**. You can then scan the drive for media files.
- To update the scan state of the folders after modifying the volume database with another program, right-click the volume database, and select **Refresh Views**.

## Results Section

The **Results** list shows all media files that are found in the selected folder in the **File Browser**.

- To show media files in the **Results** section, you must select a scanned folder in the **File Browser** section of the **MediaBay**.

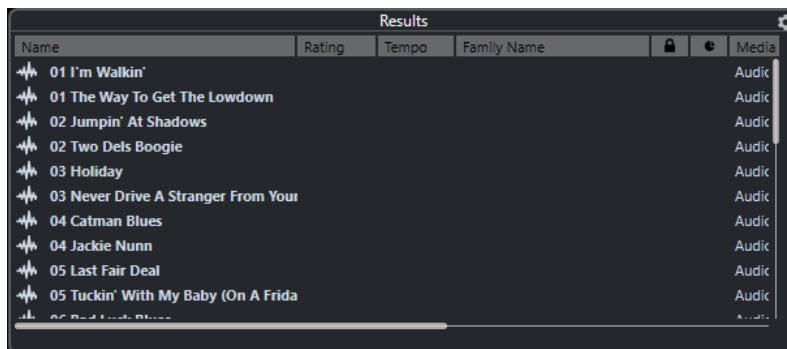

### NOTE

You can set the maximum number of files that are displayed in the **Results** list in the **MediaBay Settings**.

## Setting up the Results List Columns

For each media type, or for combinations of media types, you can specify the attribute columns that are displayed in the **Results** list.

### PROCEDURE

1. In the **Results** section, select the media types for which you want to make settings.
2. Click **Set up Result Columns** and activate or deactivate the options on the submenus.

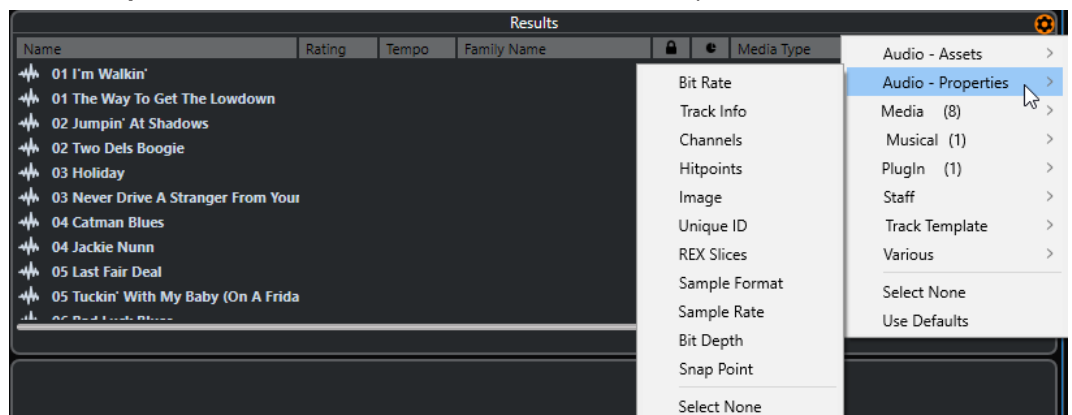

To exclude a particular category, select **Select None** on the corresponding submenu.

If **Allow Editing in Results List** is activated in the **MediaBay Settings**, you can also edit attributes in the **Results** list. Otherwise, this is only possible in the **Attribute Inspector**.

RELATED LINKS

[Setting up the MediaBay](#) on page 508  
[Attribute Inspector](#) on page 524

## Managing Media Files in the Results List

- To move or copy a file from the **Results** list to another location, drag it to another folder in the **File Browser** section.
- To change the order of the columns in the **Results** list, click a column header and drag that header to another position.
- To delete a file, right-click it in the list and select **Delete**. The file is permanently deleted from your computer.

**IMPORTANT**

If you delete a file using the File Explorer/macOS Finder, it is still displayed in the **Results** list, although it is no longer available to the program. To remedy this, rescan the corresponding folder.

---

## Shuffling the Results List

You can display the **Results** list entries in a random order.

- To shuffle the **Results** list, click **Shuffle Results** in the **MediaBay** toolbar.

## Finding the Location of a File

You can show the location of a file on your system in the File Explorer/macOS Finder.

**NOTE**

This function is not available for files which are part of a VST Sound archive.

---

PROCEDURE

- In the **Results** list, right-click a file, and select **Show in Explorer/Reveal in Finder**.
- 

RESULT

The File Explorer/macOS Finder opens and the corresponding file is highlighted.

## Filtering According to Media Type

You can set up the **Results** list to display only a particular media type or a combination of media types.

---

PROCEDURE

1. In the **MediaBay** toolbar, open the **Show Media Types** selector.

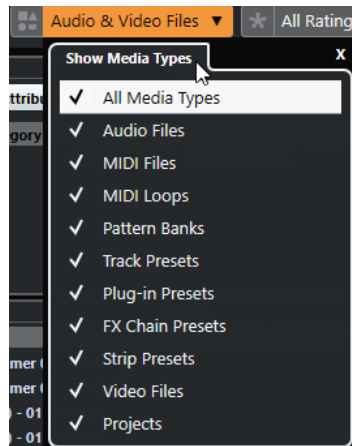

2. Activate the media types that you want to be displayed in the **Results** list.
- 

#### RESULT

The files are filtered by the selected media type.

## Show Media Types Selector

You can activate the media types that you want to be displayed in the **Results** list.

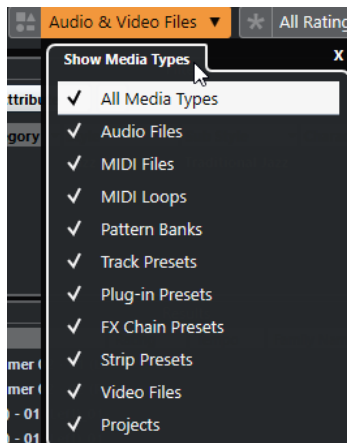

The following media types are available:

#### Audio Files

Shows all audio files. The supported formats are .wav, .w64, .aiff, .aifc, .rex, .rx2, .mp3, .mp2, .ogg, .wma (Windows only).

#### MIDI Files

Shows all MIDI files (file name extension .mid).

#### MIDI Loops

Shows all MIDI loops (file name extension .midiloop).

#### Pattern Banks

Shows all pattern banks (file name extension .patternbank). Pattern banks are generated via the MIDI plug-in **Beat Designer**. For more information, see the separate document **Plug-in Reference**.



### Track Presets

Shows all track presets for audio, MIDI, and instrument tracks (file name extension `.trackpreset`). Track presets are a combination of track settings, effects, and **MixConsole** settings that can be applied to new tracks of various types.

### Plug-in Presets

Shows all VST presets for instrument and effect plug-ins. Furthermore, EQ presets that you save in the **MixConsole** are listed. These presets contain all parameter settings for a particular plug-in. They can be used to apply sounds to instrument tracks and effects to audio tracks.

### Strip Presets

Shows all strip presets (file name extension `.strippreset`). These presets contain channel strip effect chains.

### FX Chain Presets

Shows all effect chain presets (file name extension `.fxchainpreset`). These presets contain insert effect chains.

### Video Files

Shows all video files.

### Projects

Shows all project files (from Cubase, Nuendo): `.cpr`, `.npr`.

#### RELATED LINKS

[Pattern Banks Previewer](#) on page 519

[Track Presets](#) on page 162

[Saving/Loading Strip Presets](#) on page 346

[Saving/Loading EQ Presets](#) on page 339

[Saving/Loading FX Chain Presets](#) on page 336

[Video File Compatibility](#) on page 833

## Filtering According to Rating

With the **Rating Filter**, you can filter files according to their rating.

#### NOTE

The **Rating Filter** is not available in the **Media** rack in the right zone.

---

#### PROCEDURE

- In the **Rating Filter** section of the **MediaBay** toolbar, select a value from the **Rating Filter** pop-up menu.
- 

## Performing a Text Search

You can perform a text search of the **Results** list. If you enter text in the text search field on the **MediaBay** toolbar, only media files whose attributes match the entered text are displayed.

#### NOTE

The **Search MediaBay** field has the same function as the **matches** operator of the logical filter. However, the search is applied to all file attributes.

---

- Click the field and enter the text that you want to find.

For example, if you are looking for all audio loops relating to drum sounds, enter “drum” in the search field. The search results will contain loops called “Drums 01”, “Drumloop”, “Snare Drum”, etc. In addition, all media files with the **Drum&Percussion** category attribute or any other attribute that contains “drum” are found. You can also add apostrophes to find exact matches for the entered words and use boolean operators.

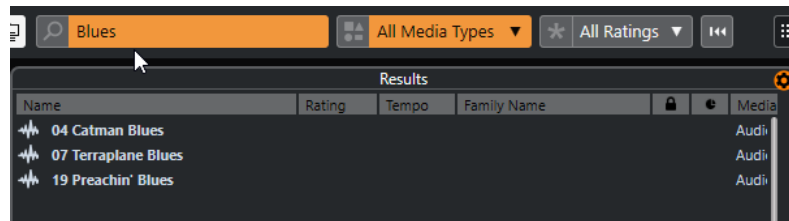

- To reset the text search, delete the text, or click **Reset Filters**.

#### RELATED LINKS

[Logical Filter](#) on page 520

## Boolean Text Search

You can perform advanced searches, using boolean operators or wildcards.

You can use the following elements:

### And [+]

[a and b]

When entering strings separated by “and” (or a plus sign), all files are found that contain both a and b.

[And] is the default setting when no boolean operator is used, for example, you can also enter [a b].

### Or [,]

[a or b]

When entering strings separated by “or” (or a comma), files are found that contain either a or b, or both.

### Not [-]

[not b]

When entering text preceded by “not” (or a minus sign), all files not containing b are found.

### Parentheses [( )]

[(a or b) + c]

Using parentheses, you can group text strings. In this example, files are found that contain c and either a or b.

### Quotation marks [“”]

["your search text"]

With quotation marks, you can define sequences of several words. Files are found if they contain the sequence of words that you entered.

## IMPORTANT

When you are searching for files whose names contain a hyphen, put the search text in quotation marks. Otherwise the program treats the hyphen as the boolean operator “not”.

#### NOTE

These operators can also be used for logical filtering.

---

#### RELATED LINKS

[Applying a Logical Filter](#) on page 521

## Resetting the Results List

You can reset all filter settings and filter results.

- In the **MediaBay** toolbar, click **Reset Filter**.

## Previewer Section

You can preview individual files in the **Previewer** section to find out which one to use in your project.

The elements visible in this section and their functions depend on the media type.

#### IMPORTANT

The **Previewer** section is not available for video files, project files, and audio track presets.

---

#### RELATED LINKS

[MediaBay Settings](#) on page 534

## Audio Files Previewer

The **Previewer** for audio files allows you to listen to audio files before you use them in your project.

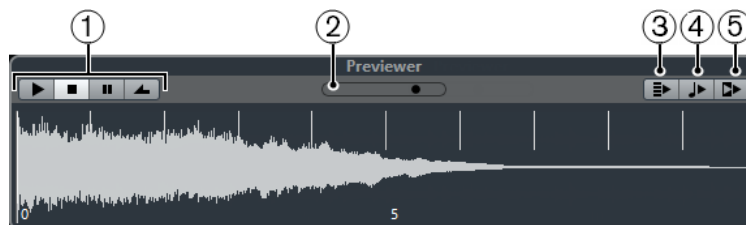

### 1 Transport controls

Start, stop, pause, and cycle the preview.

### 2 Preview Level fader

Specifies the preview level.

### 3 Auto Play New Results Selection

Automatically plays back the selected file.

### 4 Align Beats to Project

Plays back the selected file in sync with the project, starting at the project cursor position. Note that this can apply real-time time stretching to your audio file.

#### NOTE

If you import an audio file into your project for which **Align Beats to Project** is activated in the **Previewer**, **Musical Mode** is automatically activated for the corresponding event.

---

### 5 Wait for Project Play

Synchronizes the play and stop functions from the **Transport** panel with the play and stop buttons in the **Previewer** section.

To use this option to its full extent, set the left locator at the beginning of a bar, then start playing back the project using the **Transport** panel. The loops that you now select in the **Results** list start together with the project in perfect sync.

#### RELATED LINKS

[Musical Mode](#) on page 444

## Using Selection Ranges

You can specify selection ranges to preview a particular section of an audio file and insert it into the project.

#### NOTE

Selection ranges cannot be used when the **Align Beats to Project** option is activated in the **Previewer**.

- To select a range, move the mouse over the upper part of the waveform, so that it turns into a pencil, click and drag.



- To adjust the borders of the selection range, drag the handles.



- To deselect the range, drag both handles all the way to the left.

## MIDI Files Previewer

The **Previewer** for MIDI files allows you to listen to MIDI files before you use them in your project.

- To preview a MIDI file, load a VST instrument, and select it as output device from the **Select MIDI Output** pop-up menu.



- 1 Transport controls**  
Start and stop the preview.
- 2 Preview Level fader**  
Specifies the preview level.
- 3 Output**  
Allows you to select the output device.
- 4 Align Beats to Project**

Plays back the selected file in sync with the project, starting at the project cursor position. Note that this can apply real-time time stretching to your MIDI file.

#### 5 **Auto Play New Results Selection**

Automatically plays back the selected file.

#### RELATED LINKS

[VST Instruments](#) on page 547

## MIDI Loops Previewer

The **Previewer** for MIDI loops allows you to listen to MIDI loops before you use them in your project.

#### NOTE

MIDI loops are always played back in sync with the project.

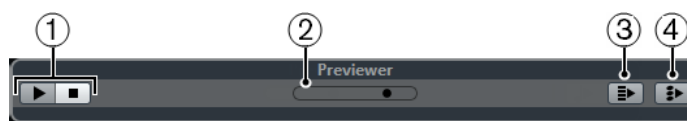

#### 1 **Transport controls**

Start and stop the preview.

#### 2 **Preview Level fader**

Specifies the preview level.

#### 3 **Auto Play New Results Selection**

Automatically plays back the selected file.

#### 4 **Link Playback to Chord Track**

Transposes the events of the MIDI loop to play back in context with the chord track. Note that you need a chord track with chord events for this.

If this option is activated, and you insert a MIDI loop into the project, **Follow Chord Track** is automatically activated for the track.

#### RELATED LINKS

[Using Follow Chord Track](#) on page 742

## VST Presets and Track Presets Previewer for MIDI and Instrument Tracks

The **Previewer** for VST presets and track presets allows you to listen to presets before you use them in your project.

- To preview track presets for MIDI or instrument tracks and VST presets, you must send some MIDI notes to the track preset via MIDI input, using a MIDI file, the **Memo Recorder** mode, or via the computer keyboard.

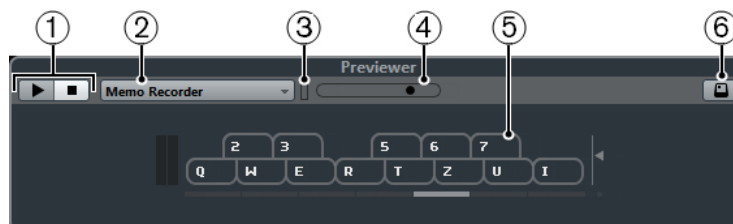

#### 1 **Transport controls**

Start and stop the preview.

## 2 **Previewer Sequence Mode**

Allows you to load a MIDI file to apply the selected preset to the MIDI file. You can also select the **Memo Recorder** mode that continually repeats a given sequence of notes as a loop.

## 3 **MIDI Activity**

Allows you to monitor incoming MIDI messages.

## 4 **Preview Level fader**

Specifies the preview level.

## 5 **Keyboard**

You can display the **Keyboard** in keyboard display mode or in piano display mode.

## 6 **Computer Keyboard Input**

Allows you to use your computer keyboard to preview the presets.

### RELATED LINKS

[Previewing Presets Using the Memo Recorder Mode](#) on page 518

[On-Screen Keyboard](#) on page 228

## Previewing Presets Via MIDI Input

MIDI input is always active. For example, when a MIDI keyboard is connected to your computer and set up properly, you can directly start playing the notes to preview the selected preset.

## Previewing Presets Using a MIDI File

---

### PROCEDURE

1. On the **Previewer Sequence Mode** pop-up menu, select **Load MIDI File**.
  2. In the file dialog that opens, select a MIDI file and click **Open**.  
The name of the MIDI file is displayed on the pop-up menu.
  3. Click **Play** to the left of the pop-up menu.
- 

### RESULT

The notes received from the MIDI file are played back with the settings of the track preset applied.

### NOTE

The recently used MIDI files are kept on the menu for quick access. To remove an entry from this list, select it on the menu and then select **Remove MIDI File**.

---

## Previewing Presets Using the Memo Recorder Mode

The **Memo Recorder** mode continually repeats a given sequence of notes as a loop.

### NOTE

You cannot use the **Memo Recorder** mode when previewing presets using a MIDI file.

---

### PROCEDURE

1. On the **Previewer Sequence Mode** pop-up menu, select **Memo Recorder**.
  2. Activate **Play**.
  3. Play some notes on the MIDI keyboard or on the computer keyboard.
-

#### RESULT

The notes are played back with the instrument preset that is selected in the **Results** section.

When you stop playing notes and wait for 2 seconds, the note sequence that you played until this moment is played back in a continuous loop.

To use another sequence, start entering notes again.

## Previewing Presets Via the Computer Keyboard

### NOTE

If you activate **Computer Keyboard Input**, the computer keyboard is used exclusively for the **Previewer** section. However, you can still use the following key commands: **Ctrl/Cmd-S** (Save), **Num \*** (Start/Stop Record), **Space** (Start/Stop Playback), **Num 1** (Jump to left locator), **Delete** or **Backspace**, **Num /** (Cycle on/off), and **F2** (Show/Hide Transport panel).

---

### PROCEDURE

1. Activate **Computer-Keyboard Input**.
  2. Play some notes on the computer keyboard.
- 

## Pattern Banks Previewer

The **Previewer** for pattern banks allows you to listen to pattern banks before you use them in your project.

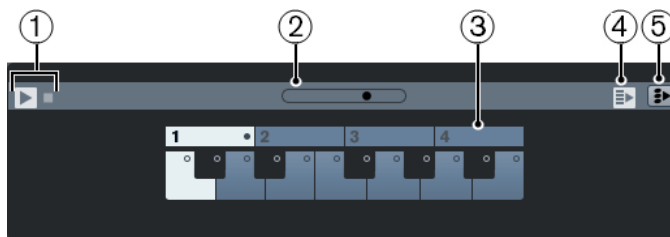

- 1 **Transport controls**  
Start and stop the preview.
- 2 **Preview Level fader**  
Specifies the preview level.
- 3 **Keyboard**  
The keyboard allows you to preview the selected pattern bank. In the **Previewer** section, choose a subbank (the number at the top) and pattern (a key), and click **Play**.  
One pattern bank contains 4 subbanks which in turn contain 12 patterns each.  
Subbanks can contain empty patterns. Selecting an empty pattern in the **Previewer** section has no effect. Patterns containing data are indicated by a circle in the upper part of the key in the display.
- 4 **Auto Play New Results Selection**  
Automatically plays back the selected file.
- 5 **Link Playback to Chord Track**  
Transposes the events of the pattern bank to play back in context with the chord track. Note that you need a chord track with chord events for this.

NOTE

You can create drum patterns with the MIDI plug-in **Beat Designer**. You can find detailed information on the **Beat Designer** and its functions in the separate document **Plug-in Reference** in the **MIDI Effects** chapter.

---

## Filters Section

The **MediaBay** allows you to refine your file searches. You have two possibilities: **Logical** or **Attribute** filtering.

### Logical Filter

The logical filter allows you to set up complex search conditions that must be met to find files.

NOTE

The **Logical Filter** is not available in the **Media** rack in the right zone.

---

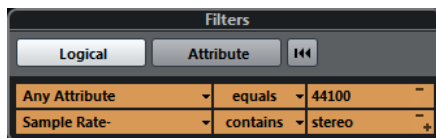

#### contains

The search result must contain the text or number specified in the text field to the right.

#### matches words

The search result must match the words specified in the text field to the right.

#### omits

The search result must not contain the text or number specified in the text field to the right.

#### equals

The search result must correspond exactly to the text or number specified in the text field to the right, including any file extension. Text searches are not case-sensitive.

#### >=

The search result must be higher than or equal to the number specified in the field to the right.

#### <=

The search result must be lower than or equal to the number specified in the field to the right.

#### is empty

Use this option to find files for which certain attributes have not been specified yet.

#### matches

The search result must include the text or number entered in the text field to the right. You can also use boolean operators. Add apostrophes to find exact matches for the entered words, for example, 'drum' AND 'funky'. This option allows for a very advanced text search.



### in range

If this option is selected, you can specify a lower and an upper limit for the search result in the fields to the right.

## Applying a Logical Filter

To quickly find certain audio files, you can search for a specific file attribute value, for example.

### PREREQUISITE

The folder in which you want to search for files is selected.

---

### PROCEDURE

1. In the **Filters** section, activate **Logical**.
2. Click **Search in these Attributes** to open the **Select Filter Attributes** dialog.
3. Select the attributes that you want to use.  
If you select more than one attribute, the files found match either one or the other attribute.
4. Click **OK**.
5. On the condition pop-up menu, select one of the search operators.

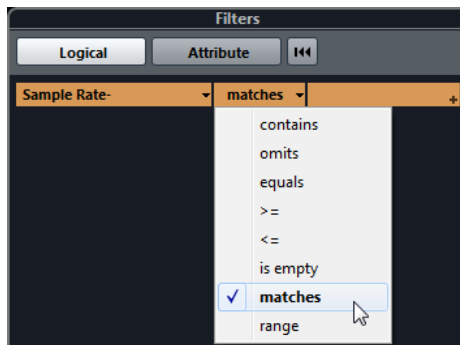

6. Enter the text or number that you want to find in the field to the right.

### NOTE

If you enter 2 or more strings or filter lines, the files that are found match all strings or filter lines.

---

- To add more than one string in the text field, enter a **Space** between them.
  - To add another filter line, click **+** to the right of the text field. You can add up to seven filter lines in which you can define further search conditions.
  - To remove a filter line, click **-**.
  - To reset all search fields to their default settings, click **Reset Filter** at the top of the **Filters** section.
- 

### RESULT

The **Results** list is automatically updated, showing only the files that correspond to your search conditions.

## Advanced Text Search

You can perform advanced text searches using boolean operators.

### PREREQUISITE

The folder in which you want to search for files is selected.

---

#### PROCEDURE

1. In the **Filters** section, activate **Logical**.
  2. Select an attribute on the **Search in these Attributes** pop-up menu or keep the **Any Attribute** setting on.
  3. Set the condition to **matches**.
  4. Specify the text that you want to search for in the field to the right using boolean operators.
- 

#### RELATED LINKS

[Performing a Text Search](#) on page 513

## Media File Attributes

Media file attributes are sets of metadata providing additional information on the file.

The different types of media files have different attributes. For example, .wav audio files have attributes, such as name, length, size, sample rate, content set, etc., while .mp3 files have additional attributes, such as artist or genre.

## Attribute Filter

Assigning attribute values to your files facilitates organizing your media files. The **Attribute** filter allows you to view and edit some of the standard file attributes that are found in your media files.

If you click **Attribute**, the **Filters** section displays all values that have been specified for the displayed attribute categories. Selecting one of these values filters the results to display only the files to which this attribute value is assigned.

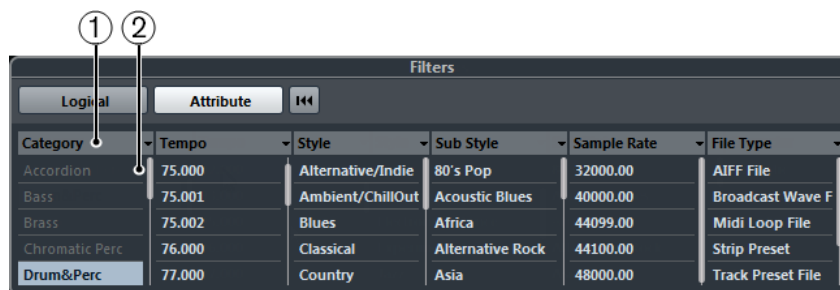

#### 1 Attribute column titles

Allow you to select different attribute categories. If the columns are wide enough, the number of files that match these criteria is displayed to the right of the value.

#### 2 Attribute values

Displays the attribute values and how often a certain attribute value is available among your media files.

#### NOTE

- Some attributes are directly linked to each other. For example, for each category value, there are certain sub-category values available. Changing the value in one of these attribute columns displays different values in the other column.
  - Each attribute column displays only the attribute values that are found.
- 

#### RELATED LINKS

[Attribute Inspector](#) on page 524

## Applying an Attribute Filter

With the **Attribute** filter, you can quickly find tagged media files with certain attributes.

- To apply an **Attribute** filter, select an attribute value.  
The **Results** list is filtered accordingly. Apply more attribute filters to narrow down the result even more.
- To find files that match either one or the other attribute, **Ctrl/Cmd**-click different attribute values in the same column.
- To change the displayed attribute values of a column, click the attribute column title and select another attribute.

### NOTE

Character attributes always form an AND condition.

## Performing a Context Menu Search

You can search for other files that have the same attribute as the selected file. This allows you to find all the files that have a value in common, for example, if you want to view all the files that were created on the same day.

- In the **Results** list or the **Attribute Inspector**, right-click a file and select the attribute value for which you want to search from the **Search for** submenu.

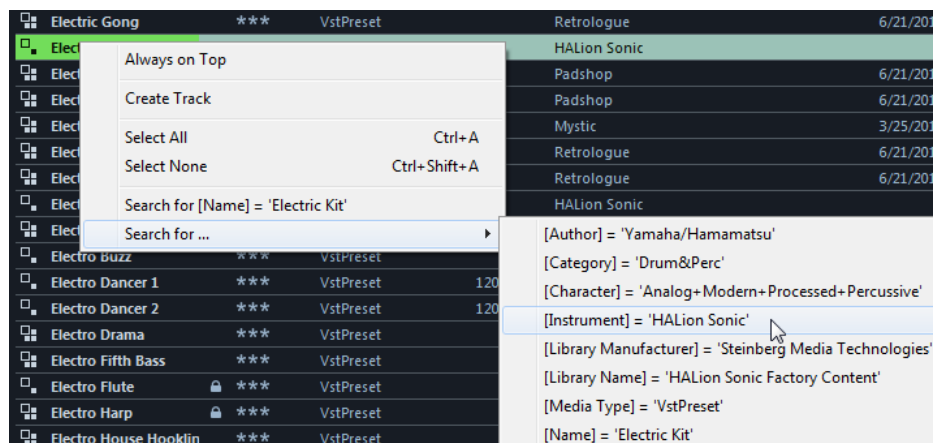

The **Filters** section automatically switches to **Logical** filtering and the corresponding filter condition line is displayed.

- To reset the filter, click **Go Back**.

## Resetting the Filter

### PROCEDURE

- To reset the filter, click **Reset Filter** at the top of the **Filters** section.

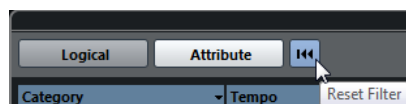

This also resets the **Results** list.

## Attribute Inspector

When you have selected one or more files in the **Results** list, the **Attribute Inspector** shows a list of attributes and their values.

### NOTE

The **Attribute Inspector** is not available in the **Media** rack in the right zone.

In the **Attribute Inspector**, you can also edit and add new attribute values.

The available attributes are divided into several groups (Media, Musical, Preset, etc.), to keep the list manageable and to facilitate finding items.

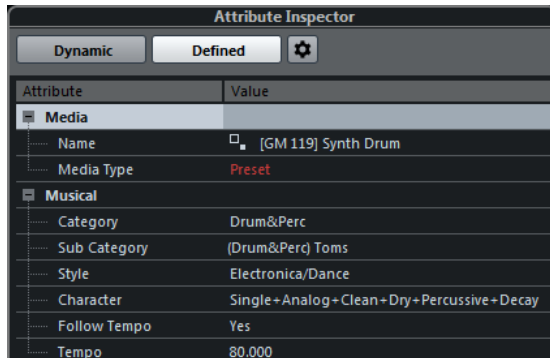

### Dynamic

Displays all available values for the selected files.

### Defined

Displays a configured set of attributes for the selected media type regardless of whether corresponding values are available for the selected files.

### Configure Defined Attributes

Activates the configuration mode, in which you can set up the attributes that are displayed in the **Attribute Inspector**.

## Configuration Mode

When you click **Configure Defined Attributes**, the configuration mode is enabled.

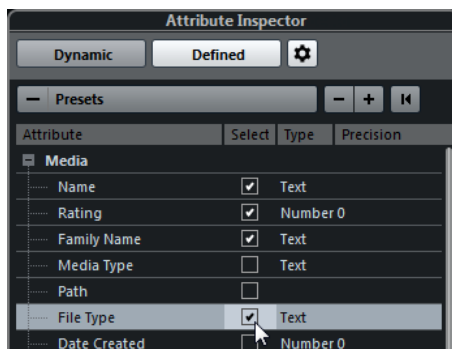

### Select Media Types

Allows you to select the media types that are displayed on the **Results** page.

### Add User Attribute

Opens the **Add User Attribute** dialog, where you can add custom user attributes. You can select the **Attribute Type** and the **Display Name**.

**Reset to Default**

Resets the attribute list to the default settings.

**Attribute**

Shows the attribute name.

**Select**

Shows whether an attribute is activated or deactivated.

**Type**

Shows whether the value for an attribute is a number, text, or a Yes/No switch.

**Precision**

Shows the number of decimals displayed for number attributes.

## RELATED LINKS

[Media File Attributes](#) on page 522

[Managing Attribute Lists](#) on page 527

## Editing Attributes

The search functions, especially the attribute filter, are a powerful media management tool when making extensive use of tagging, that is, when adding and editing attributes.

Media files are usually organized in complex folder structures to provide a logical way of guiding the user to certain files, with the folder and/or file names indicating the instrument, style, tempo, etc.

Tags help you to find a particular sound or loop in such a folder structure.

## Editing Attributes in the Attribute Inspector

In the **Attribute Inspector**, you can edit attribute values of the various media files. Attribute values can be chosen from pop-up lists, entered as text or numbers, or set to Yes or No.

## NOTE

- Changing an attribute value in the **Attribute Inspector** permanently changes the corresponding file unless the file is write-protected or part of a VST Sound archive.
- Some attributes cannot be edited. In this case, the file format does not permit changing this value, or changing a particular value makes no sense. For example, you cannot change the file size in the **MediaBay**.

## PROCEDURE

1. In the **Results** list, select the file for which you want to make settings.  
The corresponding attribute values are displayed in the **Attribute Inspector**.  
You can also select several files and make settings for them simultaneously. The only exception is the name attribute, which must be unique for every file.
2. In the **Attribute Inspector**, click in the **Value** column for an attribute.  
Depending on the selected attribute, the following happens:
  - For most of the attributes, a pop-up menu opens from which you can choose a value. Some of the pop-up menus also have a **more** entry to open a window with more attribute values.
  - For the **Rating** attribute, you can click in the **Value** column and drag left or right to modify the setting.

- For the **Character** attribute (Musical group), the **Edit Character** dialog opens. To define values, click a radio button on the left or the right side and then click **OK**.
3. Set the attribute value.  
To remove the attribute value from the selected files, right-click in the corresponding **Value** column and select **Remove Attribute** from the context menu.
- 

## Editing Attributes in the Results List

You can edit attributes directly in the **Results** list. This allows you to assign attributes to a number of loop files, for example.

### PREREQUISITE

**Allow Editing in Results List** is activated in the **MediaBay Settings**.

---

### PROCEDURE

1. In the **Results** list, select the files for which you want to make settings.  
You can make settings for several files simultaneously, except for the attribute name, which must be unique for every file.
  2. Click in the column for the value that you want to change and make the settings.
- 

### RELATED LINKS

[MediaBay Settings](#) on page 534

## Editing Attributes of Multiple Files Simultaneously

You can edit attributes for multiple files at the same time.

### NOTE

If you edit a large number of files simultaneously, the processing of your edits may take some time.

---

Editing attributes is executed in the background so that you can continue with your work as usual. The **Attribute Counter** in the **MediaBay** toolbar displays how many files are still being updated.

### RELATED LINKS

[MediaBay Toolbar](#) on page 506

## Editing Attributes of Write-Protected Files

Media files can be write-protected due to a number of reasons: the content could have been provided by someone who write-protected the files, the file format could restrict write operations by the **MediaBay**, etc.

In the **MediaBay**, the write protection status of files is shown as an attribute in the **Attribute Inspector** and in the **Write Protection** column in the **Results** list.

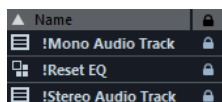

#### IMPORTANT

You can define attribute values of write-protected files in the **MediaBay**. These changes are only saved in the **MediaBay** database file, they are not saved to disk. This means that if you delete the preferences, these changes are lost.

---

#### NOTE

If the **Write Protection** and/or the **Pending Tags** columns are not visible, activate the corresponding attributes for the file type in the **Attribute Inspector**.

---

- To set or remove the write protection attribute for a file, right-click the file in the **Results** list and select **Set Write Protection/Remove Write Protection**.  
This is only possible if the file type allows write operations and if you have the necessary operating system permission.
- When you specify attribute values for a file that is write-protected, this is reflected in the **Pending Tags** column next to the **Write Protection** column in the **Results** list.  
If you rescan the **MediaBay** content and a media file on your hard disk has changed since the last scan, the pending tags for this file are lost.
- If a file has pending tags, and you want to write the corresponding attributes to the file, you must remove the write protection, then right-click the file, and select **Write Tags to File**.

#### NOTE

If you use other programs than Cubase to change the write-protection status of files, you must rescan the files in the **MediaBay** to reflect these changes.

---

#### RELATED LINKS

- [Disabling the Preferences](#) on page 880
- [Editing Attributes](#) on page 525

## Managing Attribute Lists

In the **Attribute Inspector**, you can define which attributes are displayed in the **Results** list and in the **Attribute Inspector** itself. For different media types, you can configure individual attribute sets.

---

#### PROCEDURE

1. In the **Attribute Inspector**, click **Defined**.
2. Click **Configure Defined Attributes** to enter configuration mode.

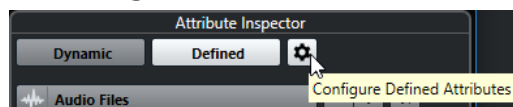

3. Open the **Select Media Types** pop-up menu, activate the media types that you want to display, and click anywhere in the **MediaBay**.  
The **Attribute Inspector** now shows a list of all attributes available for these media types.
  - If you have activated more than one media type, your settings affect all selected types. An orange checkmark indicates that the current display settings for an attribute differ for the selected media types.
  - The display settings made for the **Mixed Media Types** option are applied if you select files of different media types in the **Results** list or in the **Attribute Inspector**.
4. Activate the attributes that you want to be displayed.

You can edit several attributes simultaneously.

5. Click **Configure Defined Attributes** again to exit the configuration mode.
- 

## Defining User Attributes

You can define your own attributes and save these in the **MediaBay** database and the corresponding media files. Cubase recognizes all user attributes that are included in media files.

---

### PROCEDURE

1. In the **Attribute Inspector**, click **Defined**.
2. Click **Configure Defined Attributes** to enter configuration mode.

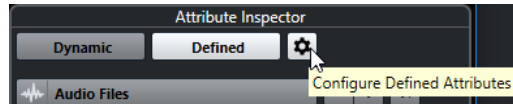

3. Click +.
  4. In the **Add User Attribute** dialog, specify the **Attribute Type** and the **Display Name**.  
The display name must be unique in the attribute list. The **Database Name** field indicates if a certain name is valid or not.
  5. Click **OK**.
- 

### RESULT

The new attribute is added to the list of available attributes and is displayed in the **Attribute Inspector** and the **Results** list.

## Working with the MediaBay

When you work with many music files, the **MediaBay** helps you to find and organize your content. After scanning your folders, all found media files of the supported formats are listed in the **Results** section.

You can set up **Favorites**, that is, folders or directories on your system that contain media files. Usually, files are organized in a specific way on your computer. You might have folders reserved for audio content, folders for special effects, folders for combinations of sounds making up the ambience noise that you need for a certain film take, etc. These can all be set as different **Favorites** in the **MediaBay**, allowing you to limit the files available in the **Results** list according to context.

By using the search and filter options, you can narrow down the results.

You can insert the files into your project by using drag and drop, by double-clicking, or by using the context menu options.

## Using Media Files

The **MediaBay** window and the **Media** rack in the right zone of the **Project** window offer you multiple possibilities to search for specific files, loops, samples, presets, and patterns that you can use in your project.

Once you have found the media files that you were looking for, you can load them into your project.

## Loading Loops and Samples

---

### PROCEDURE

1. Do one of the following:



- In the **MediaBay**, open the media types selector, click **MIDI Files**, **Audio Files**, or **MIDI Loops**, and select a media file.
  - In the **Media** rack in the right zone, click the **Loops & Samples** tile, and click the following tiles until you can select the media files in the **Results** list.
2. Do one of the following:
    - Double-click a media file to create a new instrument or an audio track with the loaded file.
    - Drag the media file to a track in the event display.
- 

#### RESULT

The media file is inserted on the new track or at the insert position.

#### RELATED LINKS

[Show Media Types Selector](#) on page 512

## Loading Track Presets

---

#### PROCEDURE

1. Do one of the following:
    - In the **MediaBay**, open the media types selector, click **Track Presets**, and select a preset.
    - In the **Media** rack in the right zone, click **Presets > Track Presets**, and click the following tiles until you can select the preset in the **Results** list.
  2. Do one of the following:
    - Double-click the track preset to create a new track with the loaded preset.
    - Drag the track preset to a track to apply the preset to the track.
- 

#### RESULT

The preset is applied to the track, and all settings of the preset are loaded.

#### RELATED LINKS

[Show Media Types Selector](#) on page 512

## Loading Instrument Presets

---

#### PROCEDURE

1. Do one of the following:
  - In the **MediaBay**, open the media types selector, click **Plug-in Presets**, and select a preset for an instrument plug-in.
  - In the **Media** rack in the right zone, click the **VST Instruments** tile, and click the following tiles until you can select the preset in the **Results** list.
2. Do one of the following:
  - Double-click the instrument preset to create a new instrument track with the loaded instrument preset.
  - Drag the instrument preset to the track list to create a new instrument track with the loaded instrument preset.
  - Drag the instrument preset to the event display to create a new instrument track with the loaded instrument preset.

- Drag the instrument preset to an instrument track to apply the preset to the track.
- 

#### RESULT

The instrument is loaded as a track instrument, and the preset is applied to the instrument track.

#### RELATED LINKS

[Adding VST Instruments to Projects](#) on page 501  
[Show Media Types Selector](#) on page 512

## Loading Effect Plug-In Presets

---

#### PROCEDURE

1. Do one of the following:
    - In the **MediaBay**, open the media types selector, click **Plug-in Presets**, and select a preset.
    - In the **Media** rack in the right zone, click **Presets > VST FX Presets**, and click the following tiles until you can select the preset in the **Results** list.
  2. Do one of the following:
    - Drag the plug-in preset to an audio track or its **Inserts** section in the **Inspector**.
    - Drag the plug-in preset to an empty area of the track list.
- 

#### RESULT

If you dragged the plug-in preset to an audio track, the first free insert slots are filled with the corresponding plug-in. If there are no more free slots available, a warning is shown.

If you dragged the plug-in preset to an empty area of the track list, a new FX channel track is created and the first insert slots of this new track are filled.

#### RELATED LINKS

[Show Media Types Selector](#) on page 512  
[Adding VST Effects to Projects](#) on page 502

## Loading FX Chain Presets

---

#### PROCEDURE

1. Do one of the following:
    - In the **MediaBay**, open the media types selector, click **FX Chain Presets**, and select a preset.
    - In the **Media** rack in the right zone, click **Presets > FX Chain Presets**, and click the following tiles until you can select the preset in the **Results** list.
  2. In the **Project** window, select an audio track.
  3. Drag the preset from the **MediaBay** or **Media** rack and drop it on the open **Inserts** section of the **Inspector**.
- 

#### RESULT

The **FX Chain Preset** is applied to the track, and all settings of the preset are loaded. Any inserts that have previously been loaded are overwritten.

#### RELATED LINKS

[Show Media Types Selector](#) on page 512

## Loading Strip Presets

---

### PROCEDURE

1. Do one of the following:
    - In the **MediaBay**, open the media types selector, click **Strip Presets**, and select a preset.
    - In the **Media** rack in the right zone, click **Presets > Strip Presets**, and click the following tiles until you can select the preset in the **Results** list.
  2. In the **Project** window, select an audio track.
  3. Drag the preset from the **MediaBay** or **Media** rack and drop it on the open **Strip** section of the **Inspector**.
- 

### RESULT

The strip preset is applied to the track, and all settings of the preset are loaded.

### RELATED LINKS

[Show Media Types Selector](#) on page 512

[Saving/Loading Strip Presets](#) on page 346

## Loading Pattern Banks

---

### PROCEDURE

1. Do one of the following:
    - In the **MediaBay**, open the media types selector, click **Pattern Banks**, and select a preset.
    - In the **Media** rack in the right zone, click **Presets > Pattern Banks**, and click the following tiles until you can select the preset in the **Results** list.
  2. Do one of the following:
    - Double-click the pattern bank to create a new instrument track with the loaded preset.
    - Drag the pattern bank and drop it on an instrument track to apply the pattern bank to the track.
    - Drag the pattern bank and drop it on the track list to create a new instrument track with the loaded pattern bank.
- 

### RESULT

**Groove Agent** is loaded as a track instrument. A drum map is loaded for the instrument track, and an instance of the **Beat Designer** is loaded as an insert effect.

### RELATED LINKS

[Show Media Types Selector](#) on page 512

## Working with Volume Databases

Cubase saves all media file information that is used in the **MediaBay**, such as paths and attributes, in a local database file on your computer. However, in some cases, it might be necessary to browse and manage this kind of metadata on an external volume.

For example, a sound editor might have to work both at home and in a studio, on two different computers. Therefore, the sound effects are stored on an external storage medium. To be able to

connect the external device and directly browse its contents in the **MediaBay** without having to scan the device, you have to create a volume database for the external device.

Volume databases can be created for your computer drives or for external storage media. They contain the same kind of information about the media files on these drives as the regular **MediaBay** database.

#### NOTE

When you launch Cubase, all available volume databases are automatically mounted. Databases that are made available while the program is running have to be mounted manually.

---

## Rescanning Volume Databases

If you have modified the data on your external volume on a different system, you must rescan the **MediaBay**.

#### RELATED LINKS

[Refresh Views](#) on page 509

## Creating Volume Databases

---

#### PROCEDURE

- In the **File Browser** section, right-click the external storage medium, drive, or partition of your computer system for which you want to create a database, and select **Create Volume Database**.

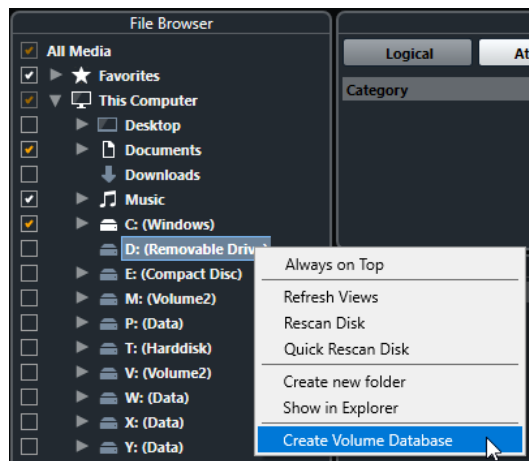

#### IMPORTANT

You must select the topmost directory level for this. You cannot create a database file for a lower-level folder.

---

#### NOTE

If you create a volume database on a network drive, multiple users can access it. However, this can lead to write conflicts as only one user can write to the database at a time.

---

#### RESULT

The file information for this drive is written into a new database file. Volume databases are indicated by the symbol  to the left of the drive name.

#### NOTE

If the drive contains a large amount of data, this process may take some time.

---

Volume databases are automatically mounted when Cubase is launched. They are shown in the **File Browser** section and their data can be viewed and edited in the **Results** list.

#### RELATED LINKS

[Locked Volume Databases on Network Drives](#) on page 533

## Locked Volume Databases on Network Drives

You can unlock volume databases on network drives. This can be necessary, if the system of another user who also used the volume database on the network drive crashed or was not properly disconnected. In this case, Cubase creates a file in a hidden folder that indicates that the database is still in use.

If this happens, you get a warning message when you launch the program. It shows the name of the user or system.

Do one of the following:

- Ask the other user to restart Cubase so that the lock is automatically released.
- If you cannot get hold of the other user, and you do not need to access the database, click **Ignore Database**.
- If you cannot get hold of the other user, and you want to use the database, click **Force unlock** to remove the lock.

## Removing Volume Databases

If you have worked on another computer using an external hard disk and return to your own computer and connect the external device again as part of your system setup, you no longer need a separate volume database for it. Any data on this drive can be included in the local database file again, by removing the extra database file.

---

#### PROCEDURE

- In the **File Browser** section, right-click the volume database and select **Remove Volume Database**.
- 

#### RESULT

The metadata is integrated in the local **MediaBay** database file, and the volume database file is deleted.

#### NOTE

If the drive contains a large amount of data, this process may take some time.

---

## Mounting and Unmounting Volume Databases

Volume databases that are made available while Cubase is running must be mounted manually.

- To mount a volume database manually, right-click the external storage medium, drive, or partition of your computer system that you want to mount and select **Mount Volume Database**.
- To unmount a volume database, right-click it and select **Unmount Volume Database**.

## MediaBay Settings

- To open a pane with settings for the **MediaBay**, click **MediaBay Settings**.

The following options are available:

### Hide Folders That Are Not Scanned

Hides all folders that are not scanned for files. This keeps the tree view in the **File Browser** less cluttered.

### Show Only Selected Folder

Shows only the selected folder and its subfolders.

### Scan Folders Only When MediaBay Is Open

Scans folders for media files when the **MediaBay** window is open.

If this option is deactivated, the folders are scanned in the background even when the **MediaBay** window is closed. However, Cubase never scans folders while playing back or recording.

### Maximum Items in Results List

Allows you to specify the maximum number of files that are displayed in the **Results** list. This avoids unmanageably long lists of files.

#### NOTE

The **MediaBay** does not warn you if the maximum number of files has been reached. There might be situations where a certain file cannot be found because the maximum number of files was reached.

### Allow Editing in Results List

Allows you to edit attributes in the **Results** list. If this option is deactivated, attributes can only be edited in the **Attribute Inspector**.

### Show File Extensions in Results List

Shows file name extensions in the **Results** list.

### Scan Unknown File Types

When scanning for media files, the **MediaBay** ignores files with an unknown file extension. If this option is activated, the **MediaBay** tries to open and scan any file in the search location and ignores those files that cannot be recognized.

# Automation

In essence, automation means recording the values for a particular **MixConsole** or effect parameter. When you create your final mix, Cubase can adjust this particular parameter control.

## Recording your Actions

If the settings in your current project are crucial, you may not want to experiment with automation until you know more about how it all fits together. If so, you can create a new project for the following example. The project does not have to contain any audio events, just a few audio tracks.

---

### PROCEDURE

1. On the **Project** window toolbar, click **W** to activate write for all tracks.
2. Start playback and adjust some volume faders and/or other parameter settings in the **MixConsole**.  
Stop playback when you are done, and return to the position where you started playback.
3. Click **W** to deactivate the write mode and click **R** to activate read for all tracks.
4. Start playback, and watch the **MixConsole**.  
All your actions that were performed during the previous playback are reproduced exactly.
5. Select **Project > Show All Used Automation** to view all recorded automation events.
6. To redo anything that was recorded, click **W** again and start playback from the same position.

### NOTE

You can have **W** and **R** activated simultaneously, if you want to watch and listen to your recorded **MixConsole** actions while you are recording fader movements for another channel, etc.

---

## Automation Curves

Within a Cubase project, the changes in a parameter value over time are reflected as curves on automation tracks.

There are different kinds of automation curves:

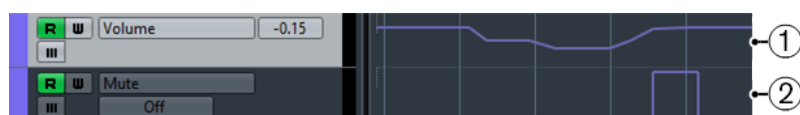

### 1 Ramp curves

Ramp curves are created for any parameter that generates continuous multiple values, such as fader or encoder movements.

## 2 Jump curves

Jump curves are created for on/off parameters, such as mute.

## Static Value Line

When you open an automation track for the first time, it does not contain any automation events. This is reflected in the event display as a dotted horizontal line, the static value line. This line represents the current parameter setting.

If you manually added any automation events or used write automation for the corresponding parameter and then disable the reading of automation data, the automation curve is grayed out in the event display and the static value line is used instead.

As soon as **Read** is enabled, the automation curve is used.

## Write/Read Automation

You can automation-enable tracks and **MixConsole** channels by activating their automation write **W** and read **R** buttons.

- If you activate **W** for a channel, virtually all **MixConsole** parameters that you adjust during playback for that specific channel are recorded as automation events.
- If **R** is activated for a channel, all your recorded **MixConsole** actions for that channel are performed during playback.

The **R** and **W** buttons for a track in the track list are the same as the **R** and **W** buttons in the **MixConsole**.

### NOTE

**R** is automatically enabled when you enable **W**. This allows Cubase to read existing automation data at any time. You can separately deactivate **W** if you only want to read existing data.

There are also global read and write indicator buttons **Activate/Deactivate Read/Write for All Tracks** on the **Project** window toolbar and the **MixConsole** toolbar. These buttons light up as soon as there is an enabled **R** or **W** button on any channel/track within your project. Furthermore, they can be clicked to activate or deactivate **R/W** of all tracks simultaneously.

## MIDI Part Data vs. Track Automation

You can enter or record MIDI controller data as automation data on an automation track or as part data in the MIDI part.

- If **Read Automation** for a track is enabled, controller data is written as automation data on an automation track in the **Project** window.
- If **Read Automation** is disabled, the controller data is written in the MIDI part and can be viewed and edited for example in the **Key Editor**.

Nevertheless, you can end up with both kinds of controller data for a MIDI part if you recorded controller part data in one pass and automation data during another. In this case, these conflicting data types are combined during playback as follows:

- Part automation only begins when the first controller event within the part is reached. At the end of the part, the last controller value is kept until an automation breakpoint is reached on the automation track.



## Writing Automation Data

You can create automation curves manually or automatically.

- Manual writing makes it easy to quickly change parameter values at specific points without having to activate playback.
- Automatic writing lets you work almost as if you were using a real mixer.

With both methods, any applied automation data is reflected in both the **MixConsole** by a moved fader, for example, and in the corresponding automation track curve.

### RELATED LINKS

[Manual Writing of Automation Data](#) on page 537

## Automatic Writing of Automation Data

Every action that you perform is automatically recorded on automation tracks which you can later open for viewing and editing.

---

### PROCEDURE

1. In the track list, click **Show/Hide Automation** for a track to open its automation track.

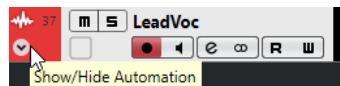

2. Click **W** to enable the writing of automation data on this track.
3. Start playback.
4. Adjust the parameters in the **MixConsole**, in the **Channel Settings** window, or on the effect control panel.  
The value settings are recorded and displayed as a curve on the automation tracks. When automation data is being written, the color of the automation track changes and the delta indicator in the automation track shows the relative amount by which the new parameter setting deviates from any previously automated value.
5. Stop playback and return to the position where you started playback.
6. Click **W** to disable the writing of automation data.
7. Start playback.

---

### RESULT

All actions that you recorded are reproduced exactly. When you drag a plug-in to a different insert slot on the same channel, any existing automation data moves with the plug-in. When you drag it to an insert slot on a different channel, any existing automation data is not transferred to the new channel.

## Manual Writing of Automation Data

You can add automation events manually by drawing automation curves on an automation track.

---

### PROCEDURE

1. In the track list, click **Show/Hide Automation** for a track to open its automation track.

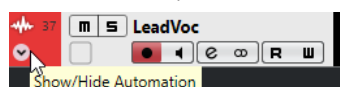

2. Click the automation parameter name and select the parameter from the pop-up menu.
3. Select the **Draw** tool.

4. Click on the static value line.  
An automation event is added, read automation mode is automatically activated, and the static value line changes to a colored automation curve.
5. Click and hold to draw a curve by adding many automation events.  
When you release the mouse button, the number of automation events is reduced.

**NOTE**

To adjust the thinning out of events, open the **Automation Panel**, open the **Settings** page, and enter a value for **Reduction Level**.

---

6. Start playback.
- 

**RESULT**

The automated parameter changes with the automation curve, and the corresponding fader in the **MixConsole** moves accordingly.

**AFTER COMPLETING THIS TASK**

Repeat the procedure if you are not happy with the result. If you draw over existing events, a new curve is created.

## Tools for Drawing Automation Data

Apart from the **Draw** tool, you can use the **Object Selection** tool and the **Line** tool to draw automation events. If you click with any of these tools on the automation track, **R** is activated automatically.

- **Object Selection**

If you click on an automation track with the **Object Selection** tool, an automation event is added. If you hold down **Alt**, you can draw several automation events.

**NOTE**

Events that are introduced between existing events and do not deviate from the existing curve are removed as soon as you release the mouse button.

---

To activate the **Line** tool in any other available mode, click the **Line** tool and click again to open a pop-up menu where you can select the **Line** tool mode.

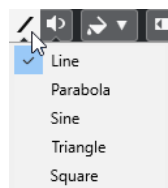

The following **Line** tool modes are available:

**Line**

If you click on the automation track and drag with the **Line** tool in **Line** mode, you can create automation events in a line. This is a quick way to create linear fades, etc.

**Parabola**

If you click and drag on the automation track with the **Line** tool in **Parabola** mode, you can create more natural curves and fades.

**NOTE**

The result depends on the direction from which you draw the parabolic curve.

---

### Sine/Triangle/Square

If you click and drag on the automation track with the **Line** tool in **Sine**, **Triangle**, or **Square** mode and the **Snap Type** is set to **Grid**, the period of the curve, that is, the length of one curve cycle, is determined by the grid setting. If you press **Shift** and drag, you can set the period length manually, in multiples of the grid value.

#### NOTE

The **Line** tool can only be used for ramp type automation curves.

---

## Editing Automation Events

Automation events can be edited much like other events.

#### NOTE

If you move an event or part on a track and you want the automation events to follow automatically, select **Edit > Automation Follows Events**. Any automation events at the new position are overwritten.

---

- You can use the tools on the **Project** window toolbar to edit automation events.
- You can use the automation event editor to edit selected automation events on ramp automation curves.

#### RELATED LINKS

[Project Window Toolbar](#) on page 32

[Automation Event Editor](#) on page 540

## Creating Smooth Transitions Between Automation Events (Bézier Automation Curves)

Cubase supports bézier automation curves that allow you to create smooth transitions between automation events. This way, you can edit linear ramp curves with much more precision, flexibility, and intuition.

#### PREREQUISITE

The **Object Selection** tool is active.

---

#### PROCEDURE

1. Move the mouse pointer on the linear ramp curve segment that you want to edit. A handle is shown on the curve segment.



#### NOTE

If the automation events are next to each other on an almost horizontal or vertical line, or if they are too close to each other, the handle is not available.

---

2. Click and drag with the mouse button pressed to modify the shape of the curve segment.



3. When you are satisfied with the result, release the mouse button.
- 

#### RESULT

A smooth transition curve according to your edits is created.

If you are not satisfied with the result and want to start over again from the original linear curve segment, double-click the handle.

#### AFTER COMPLETING THIS TASK

For even more precise editing, add new automation events to your bézier curve segment.

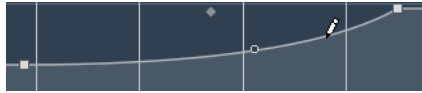

This creates new segments that you can smoothen.



## Selecting Automation Events

- To select an automation event, click it with the **Object Selection** tool.
- To select multiple events, drag a selection rectangle with the **Object Selection** tool or **Shift**-click the events.
- To select multiple events, select a range with the **Range Selection** tool or **Shift**-click the events.
- To select all automation events on an automation track, right-click the automation track and select **Select All Events** from the context menu.

Selected events are indicated by a dark color.

#### NOTE

If you select several events of a ramp automation curve, the automation event editor becomes available.

---

#### RELATED LINKS

[Automation Event Editor](#) on page 540

## Automation Event Editor

The automation event editor allows you to edit selected events on the automation track. The automation event editor is only available for automation ramp curves.

#### NOTE

All editing in the automation event editor only affects the automation events that are part of the selection.

---

To open the automation event editor, do one of the following:

- Activate the **Object Selection** tool and drag a selection rectangle on a ramp type automation track.
- Activate the **Range Selection** tool and select a range on a ramp type automation track.

NOTE

If you work with the **Range Selection** tool, the smart control for **Stretch** is not available.

The automation event editor features the following smart controls for specific editing modes:

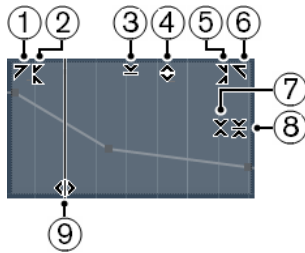

**1 Tilt Left**

If you click in the upper left corner of the editor, you can tilt the left part of the curve. This allows you to tilt the event values at the start of the curve upwards or downwards.

**2 Compress Left**

If you **Alt**-click in the upper left corner of the editor, you can compress or expand the left part of the curve. This allows you to compress or expand the event values at the start of the curve.

**3 Scale Vertically**

If you click in the middle of the upper border of the editor, you can scale the curve vertically. This allows you to raise or lower the event values of the curve in percent.

**4 Move Vertically**

If you click on the upper border of the editor, you can move the entire curve vertically. This allows you to raise or lower the values of the event values of the curve.

**5 Compress Right**

If you **Alt**-click in the upper right corner of the editor, you can compress or expand the right part of the curve. This allows you to compress or expand the event values at the end of the curve.

**6 Tilt Right**

If you click in the upper right corner of the editor, you can tilt the right part of the curve. This allows you to tilt the event values at the end of the curve upwards or downwards.

**7 Scale Around Relative Center**

If you **Alt**-click in the middle right border of the editor, you can scale the curve relative to its center. This allows you to raise or lower the event values horizontally around the center of the editor.

**8 Scale Around Absolute Center**

If you click in the middle right corner of the editor, you can scale the curve absolute to its center. This allows you to raise or lower the event values horizontally around the center of the editor.

**9 Stretch**

If you click on the lower border of the editor, you can stretch the curve horizontally. This allows you to move the event values of the curve to the left or to the right.

NOTE

To edit the automation curves on several tracks simultaneously, select the automation events using the **Object Selection** tool or the **Range Selection** tool on the corresponding automation tracks, and hold down **Ctrl/Cmd** while using the smart controls.

#### NOTE

If you select automation events using the **Range Selection** tool, additional automation events are automatically created at the start and the end of the selection. This ensures that the entire selection is edited.

---

#### RELATED LINKS

[Automation Curves](#) on page 535

## Quick Vertical Scaling of Automation Events

You can scale the curve segment between two automation events vertically without any need to select the events first.

---

#### PROCEDURE

1. Move the mouse pointer to the upper border of the automation track above the linear ramp curve segment that you want to scale.

A handle is shown.



2. Click and drag up or down with the mouse button pressed.
  3. When you are satisfied with the result, release the mouse button.
- 

#### RESULT

The curve segment between the two automation events is scaled.

## Moving Automation Events

### Moving Single Automation Events

- To move a selected automation event, click it and drag to the left or to the right.
- To restrict the direction of the movement, press **Ctrl/Cmd** and drag.

#### NOTE

**Snap** is taken into account when you move automation curves horizontally. To turn it off temporarily, hold down **Ctrl/Cmd** and any other modifier, and drag.

---

### Moving Multiple Automation Events

- To move a selection of automation events, click inside the selection rectangle and drag to the left or to the right.  
If you made a continuous selection of automation events, events at the destination range are overwritten. However, if you move the same selection range past already existing events, they appear again. If a selection range contains automation events that are deselected, dragging is restricted. You cannot move this selection past existing events.
- To copy a continuous selection of automation events, click inside the selection rectangle, hold down **Alt**, and drag to the left or to the right.

#### NOTE

If you press **Esc** while dragging the selection rectangle, the selection jumps back to its original position.

---

RELATED LINKS

[Selecting Automation Events](#) on page 540

## Removing Automation Events

- To remove an automation event, click on it with the **Erase** tool.
- To remove multiple automation events, select them and press **Backspace** or **Delete** or select **Edit > Delete**.
- To remove all automation events from the automation track and close the automation track, click the automation parameter name in the track list and select **Remove Parameter** from the pop-up menu.

NOTE

When removing automation events, the curve is redrawn to connect the remaining events.

---

## Automation Tracks

Most of the tracks in your project have automation tracks, one for each automated parameter.

To show automation tracks, you must open them.

## Showing/Hiding Automation Tracks

- Position the mouse pointer over the lower left corner of the track and click the arrow icon (**Show/Hide Automation**) that appears.
- Right-click the track in the track list and select **Show/Hide Automation** from the context menu.
- To open another automation track, position the mouse pointer over the lower left corner of an automation track and click + (**Append Automation Track**).
- To show all used automation tracks in the track list, right-click any track and select **Show All Used Automation** from the context menu.
- To open the corresponding automation track on writing automation parameters, activate **Show Automation Track in Project on Writing Parameter** in the **Preferences** dialog (**Editing** page).

## Removing Automation Tracks

- To remove an automation track together with all automation events, click the parameter name, and from the pop-up menu, select **Remove Parameter**.
- To remove all automation tracks from a track that do not contain automation events, select **Remove Unused Parameters** from any of its automation parameter name pop-up menus.

## Assigning a Parameter to an Automation Track

Parameters are already assigned to automation tracks when you open them, according to their order in the parameter list.

PROCEDURE

1. Open an automation track and click on the automation parameter name.  
A parameter list is shown. The content depends on the track type.
  2. From the pop-up menu, select the parameter or select **More** to open the **Add Parameter** dialog that lists all parameters that can be automated, and select the parameter there.
-

#### RESULT

The parameter replaces the current parameter in the automation track.

#### NOTE

The replacement of the automation parameter is non-destructive. If the automation track contains any automation data for the parameter that you just replaced, this data is there, although it is not visible. By clicking on the automation parameter name in the track list, you can switch back to the replaced parameter. On the pop-up menu, an asterisk (\*) is shown after the parameter name for hidden automation tracks.

---

## Muting Automation Tracks

By muting an automation track, you turn off automation for a single parameter.

- To mute individual automation tracks, click **Mute Automation** in the track list.

## MIDI Controller Automation

When working with Cubase, it is possible to record automation data for MIDI controllers as MIDI part data and as data on an automation track.

If you have such conflicting automation data, you can specify separately for every parameter how these are combined during playback. This is done by selecting an **Automation Merge Mode** in the track list for the automation track.

## Automation Merge Modes

**Automation Merge Modes** in the **MIDI Controller Automation Setup** dialog are only available for controllers that can be recorded both for a part and a track.

- To open the **MIDI Controller Automation Setup** dialog, select **MIDI > CC Automation Setup**.

### Use Global Settings

When this is selected, the automation track uses the global automation **Merge Mode** that is specified in the **MIDI Controller Automation Setup** dialog.

### Replace 1 - Part Range

When this option is selected, the part data has playback priority over the automation track data. At the left and right part borders, for example, the automation mode switches abruptly from part to track automation, and vice versa.

### Replace 2 - Last Value Continues

Similar to **Replace 1 - Part Range**, but part automation only begins when the first controller event within the part is reached. At the end of the part, the last controller value is kept until an automation event is reached on the automation track.

### Average

When this option is selected, the average values between part and track automation are used.

### Modulation

In this mode, the automation track curve modulates the existing part automation, with higher curve points emphasizing the automation values and lower curve points reducing the automation values even further.



NOTE

The settings that you make for a controller are applied to all MIDI tracks that use this controller.

## MIDI Controller Automation Setup Dialog

In the **MIDI Controller Automation Setup** dialog, you can specify how existing MIDI automation is handled on playback and new automation data is recorded in a MIDI part or as track automation. All settings that you make in this dialog are saved with the project.

- To open the **MIDI Controller Automation Setup** dialog, select **MIDI > CC Automation Setup**.

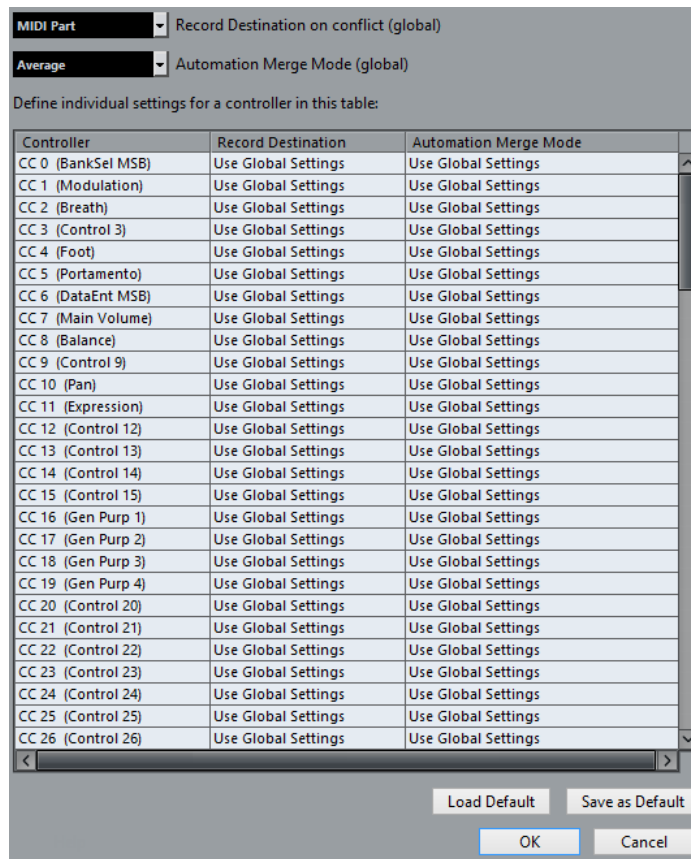

### Record Destination on Conflict (global)

Allows you to determine which destination is used if MIDI controller data is received by Cubase and both the **Record** and the **Write Automation** buttons are enabled. Select **MIDI Part** to record MIDI part automation. Select **Automation Track** to record the controller data on an automation track in the **Project** window.

### Automation Merge Mode (global)

Allows you to specify the global merge mode for automation.

### Controller list

Lists all MIDI controllers for which you can specify the record destination and the merge mode for automation separately. This gives you full control over the MIDI automation (destination as well as merge mode) in your project.

**Record Destination**

Click in the **Record Destination** column for a MIDI controller to open a pop-up menu where you can choose where you want recorded data of this particular MIDI controller to be saved.

**Automation Merge Mode**

Click in the **Automation Merge Mode** column for a MIDI controller to specify what happens with data for this specific controller on playback.

**Save As Default**

Allows you to save the current settings as default settings. When you create a new project, the default settings are used.

**Load Default**

Allows you to load the default settings.

# VST Instruments

VST instruments are software synthesizers or other sound sources that are contained within Cubase. They are played internally via MIDI. You can add effects or EQ to VST instruments.

Cubase allows you to make use of VST instruments in the following ways:

- By adding a VST instrument and assigning one or several MIDI tracks to it.
- By creating an instrument track.  
This is a combination of a VST instrument, an instrument channel, and a MIDI track. You play and record MIDI note data directly for this track.

## NOTE

Some VST instruments are included with Cubase. These are described in the separate document **Plug-in Reference**.

## RELATED LINKS

[Instrument Tracks](#) on page 106

## Adding VST Instruments

### PROCEDURE

1. On the **Studio** menu, select **VST Instruments**.
2. Right-click on an empty area of the **VST Instruments** window.
3. From the context menu, select **Add Rack Instrument**.
4. From the instrument selector, select an instrument.
5. Click **Create**.

### RESULT

The instrument control panel opens, and the following tracks are added to the track list:

- A MIDI track with the name of the instrument. The output of the MIDI track is routed to the instrument.

## NOTE

In the **Preferences** dialog (**VST—Plug-ins** page), you can specify what happens when you load a VST instrument.

- A folder with the name of the instrument that is added within a **VST Instruments** folder. The instrument folder contains two automation tracks: one for the plug-in parameters and one for the synth channel in the **MixConsole**.

## VST Instrument Control Panel

The VST instrument control panel allows you to set up the parameters of the selected instrument. The contents, design, and layout of the control panel depend on the selected instrument.

The following controls are available:



- 1 Activate Instrument**  
Activates/Deactivates the instrument.
- 2 Read Automation/Write Automation**  
Allows you to read/write automation for the instrument parameter settings.
- 3 Switch between A/B Settings**  
Switches to setting B when setting A is active, and to setting A when setting B is active.
- 4 Copy A to B**  
Copies the instrument parameters of instrument setting A to instrument setting B.
- 5 Activate Side-Chain**  
Activates the side-chain functionality.
- 6 Set Up Side-Chain Inputs**  
Allows you to set up the side-chain inputs for the selected plug-in.
- 7 Event Received Indicator**  
Lights up on receiving note-on and controller messages.
- 8 Preset browser**  
Opens the preset browser where you can select another preset.
- 9 Preset Management**

Opens a pop-up menu that allows you to save, rename, or remove a preset.

**10 Add VST Plug-in Picture to Media Rack**

Adds a picture of the VST plug-in to the **Media** rack. This is only available for plug-ins of other vendors.

**11 VST Instrument context menu**

Opens a menu with specific functions and settings.

RELATED LINKS

[Adding Pictures of VST Instruments to the Media Rack](#) on page 503

[VST Instrument Context Menu](#) on page 553

[Hiding/Showing VST Instrument Control Panels](#) on page 549

## Hiding/Showing VST Instrument Control Panels

When you add a VST instrument, the respective plug-in control panel opens automatically. You can hide the control panels from view. This is useful to get a better overview if you added a number of plug-ins to your project whose control panels clutter up the screen.

---

PROCEDURE

- Select **Window > Hide Plug-in Windows**.

**NOTE**

This also hides VST effect control panels.

---

RESULT

The plug-in windows are hidden and sent to the back of the application. To show them again, select **Show Plug-in Windows**.

RELATED LINKS

[VST Instrument Control Panel](#) on page 548

## Closing All Control Panels

When you add a VST instrument, the respective plug-in control panel opens automatically. You can close all control panels at once.

---

PROCEDURE

- Select **Window > Close All Plug-in Windows**.

**NOTE**

This also closes VST effect control panels.

---

RESULT

The control panels are closed.

RELATED LINKS

[VST Instrument Control Panel](#) on page 548

## VST Instrument Selector

The VST instrument selector allows you to select VST instruments of the active collection.

To open the VST instrument selector, do one of the following:

- Select **Studio > VST Instruments**, and click **Add Rack Instrument**.
- Select **Studio > VST Instruments**, click **Add Track Instrument**, and open the **Instrument** pop-up menu.

The following controls are available:

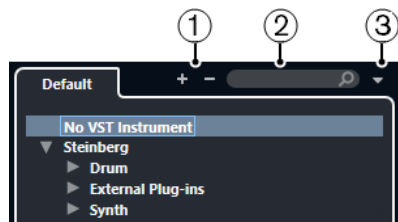

**1 Expand Tree/Collapse Tree**

Expands/Collapses the tree.

**2 Search VST Instrument**

Allows you to search for VST instruments by typing in the name or parts of the name or the category.

**3 Plug-in Collections and Options**

Allows you to select a collection.

If you select the **Default** collection, the options **Sort By Category** and **Sort by Vendor** become available. These allow you to sort the default collection.

## Creating Instrument Tracks

You can create instrument tracks that hold dedicated VST instruments.

---

### PROCEDURE

1. In the global track controls area of the track list, click **Add Track** .
2. Click **Instrument**.
3. Open the **Instrument** pop-up menu and select a VST instrument.
4. Click **Add Track**.

---

### RESULT

The selected VST instrument is loaded for the instrument track. In the **MixConsole**, an instrument channel is added.

## VST Instruments in the Right Zone

The **VST Instruments** in the right zone of the **Project** window allow you to add VST instruments for MIDI and instrument tracks.

All instruments that are used in your project are shown. You can access up to 8 quick controls for each added instrument.

To open the **VST Instruments** in the right zone, click **Show/Hide Right Zone** on the **Project** window toolbar, and at the top of the right zone, click the **VSTi** tab.



#### NOTE

The **VST Instruments** in the right zone are just another representation of the **VST Instruments** window. All features are the same.

---

#### RELATED LINKS

[Showing/Hiding Zones](#) on page 31  
[Project Window Toolbar](#) on page 32

## VST Instruments Window

The **VST Instruments** window allows you to add VST instruments for MIDI and instrument tracks.

All instruments that are used in your project are shown. You can access up to 8 quick controls for each added instrument.

To open the **VST Instruments** window, select **Studio > VST Instruments**.

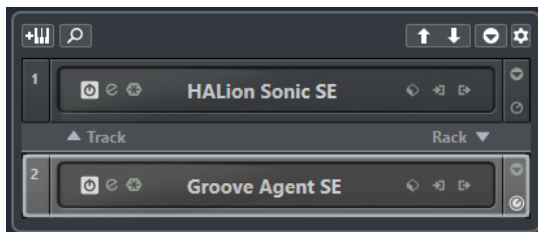

#### RELATED LINKS

[Instrument Tracks](#) on page 106

## VST Instruments Window Toolbar

The **VST Instruments** window toolbar contains controls that allow you to add and set up VST instruments and **VST Quick Controls**.

#### Add Track Instrument



Opens the **Add Track** dialog that allows you to select an instrument and add an instrument track that is associated to this instrument.

### Find Instruments



Opens a selector that allows you to find a loaded instrument.

### Set Remote-Control Focus for VST Quick Controls to Previous Instrument



Allows you to set the remote-control focus to the previous instrument.

### Set Remote-Control Focus for VST Quick Controls to Next Instrument



Allows you to set the remote-control focus to the next instrument.

### Show/Hide all VST Quick Controls



Shows/Hides the default quick controls for all loaded instruments.

### Settings



Opens the **Settings** menu where you can activate/deactivate the following modes:

- **Show VST Quick Controls for One Slot Only** shows the **VST Quick Controls** exclusively for the selected instrument.
- **MIDI Channel follows track selection** ensures that the **Channel** selector follows the MIDI track selection in the **Project** window. Use this mode if you work with multitimbral instruments.
- **Remote-Control Focus for VST Quick Controls follows track selection** ensures that the **VST Quick Controls** remote-control focus follows the track selection.

## VST Instrument Controls

The VST instrument controls allow you to make settings for a loaded VST instrument.

The following controls are available on each instrument:

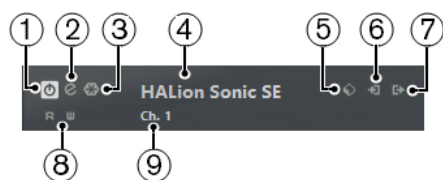

#### 1 **Activate Instrument**

Activates/Deactivates the instrument.

#### 2 **Edit Instrument**

Opens the instrument panel.

#### 3 **Freeze Instrument**

Freezes the instrument. This allows you to save CPU power.

#### 4 **Instrument selector**

Allows you to select another instrument. Double-click to rename the instrument. The name is shown in the window in the **Output Routing** pop-up menu for MIDI tracks. This is useful when you work with several instances of the same instrument.

#### 5 **Preset Browser**

Allows you to load or save an instrument preset.

#### 6 **Input Options**



This lights up when MIDI data is received by the instrument. Click this button to open a pop-up menu that allows you to select, mute/unmute, and solo/unsolo for tracks that send MIDI to the instrument (inputs).

**NOTE**

If you resize the **VST Instruments** window, you can access this option by using an **Input/Output Options** pop-up menu.

---

**7 Activate Outputs**

This control is only available if the instrument provides more than one output. It allows you to activate one or more outputs for the instrument.

**NOTE**

If you resize the **VST Instruments** window, you can access this option by using an **Input/Output Options** pop-up menu.

---

**8 Read Automation/Write Automation**

Allows you to read/write automation for the instrument parameter settings.

**9 Select Quick Control Layer**

Allows you to select a program.

RELATED LINKS

[Freezing Instruments](#) on page 556

## VST Instrument Context Menu

The following functions are available in the instruments context menu:

**Copy <VST instrument name> Setting/Paste <VST instrument name> Setting**

Allows you to copy the instrument settings and paste them to another instrument.

**Load Preset/Save Preset**

Allows you to load/save an instrument preset.

**Default Preset**

Allows you to define and save a default preset.

**Switch to A Setting/Switch to B Setting**

Activates the setting A or B.

**Copy A to B**

Copies the effect parameters of effect setting A to effect setting B.

**Activate Outputs**

Allows you to activate one or more outputs for the instrument.

**Remote Control Editor**

Opens the **Remote Control Editor**.

## Presets for Instruments

You can load and save presets for instruments. These contain all the settings that are required for the sound that you want.

The following presets for instruments are available:

- **VST Presets**  
VST presets include the parameter settings of a VST instrument. These are available from the **VST Instruments** window, from the instrument control panels, and from the **Programs** field in the **Inspector**.
- **Track Presets**  
Track presets include the instrument track settings and the settings for the corresponding VST instrument. These are available from the **Inspector** or the track list context menu.

## Loading VST Presets

You can load **VST Presets** from the **VST Instruments** window, from the control panel or from the **Inspector**.

---

### PROCEDURE

1. Do one of the following:
  - Select the track that contains the VST instrument, and in the **Inspector**, click the **Programs** field.
  - In the **VST Instruments** window, click **Preset Browser** for the instrument, and select **Load Preset**.
  - In the control panel for the VST instrument, click **Preset Browser**, and select **Load Preset**.
2. In the preset browser, select a preset from the list and double-click it to load it.

---

### RESULT

The preset is applied. To return to the previously loaded preset, open the preset browser again and click **Revert to Last Setting**.

## Saving VST Presets

You can save your settings on VST instruments as VST presets for further use.

---

### PROCEDURE

1. Do one of the following:
  - In the **VST Instruments** window, click **Preset Browser** for the instrument, and select **Save Preset**.
  - In the control panel for the VST instrument, click **Preset Browser**, and select **Save Preset**.
2. In the **Save <VST instrument name> Preset** dialog, enter a name for the preset.
3. Optional: Click **Show Attribute Inspector** and define attributes for the preset.
4. Click **OK** to save the preset and close the dialog.

---

## Loading Track Presets

You can load track presets for instrument tracks from the **Inspector**.

---

### PROCEDURE

1. Do one of the following:
  - Select the instrument track, and in the **Inspector**, click the **Load Track Preset** field.

- Right-click the instrument track, and from the context menu, select **Load Track Preset**.
2. In the preset browser, select a preset from the list and double-click it to load it.

## RESULT

The track preset is applied. To return to the previously loaded preset, open the preset browser again and click **Revert to Last Setting**.

## Instrument Presets Results Browser

The **Results** browser for instrument track presets allows you to preview VST presets and apply them to your instrument track.

- To open the **Results** browser, right-click an instrument track, and select **Load Track Preset**.

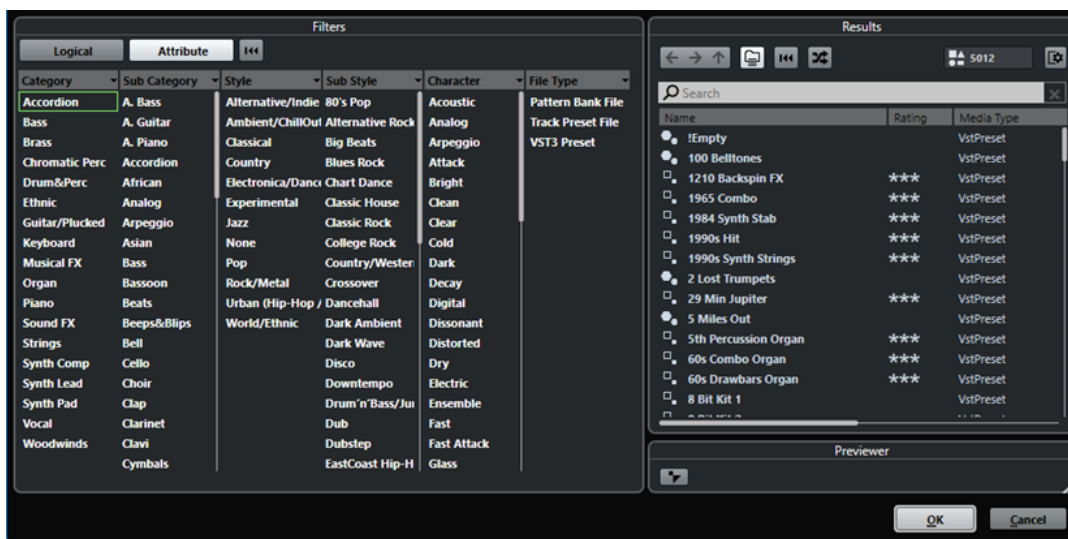

VST presets for instruments can be divided into the following groups:

### Presets

Presets contain the settings of the entire plug-in. For multitimbral instruments, this includes the settings for all sound slots as well as the global settings.

### Programs

Programs contain only the settings for one program. For multitimbral instruments, this includes only the settings for one sound slot.

## Saving Track Presets

You can save your settings on instrument tracks as track presets for further use.

## PROCEDURE

1. Right-click the instrument track, and from the context menu, select **Save Track Preset**.
2. In the **Save Track Preset** dialog, enter a name for the preset.
3. Optional: Click **Show Attribute Inspector** and define attributes for the preset.
4. Click **OK** to save the preset and close the dialog.

## Playing Back VST Instruments

After you have added a VST instrument and selected a sound, you can play back the VST instrument using the instrument or MIDI track in your project.

---

### PROCEDURE

1. In the track list, activate **Monitor** for the track that has the VST instrument loaded.
  2. Press one or more keys on your MIDI keyboard or use the **On-Screen Keyboard**. The corresponding sounds are triggered on your VST instrument.
  3. Select **Studio > MixConsole** to open the **MixConsole** and adjust the sound, add EQ or effects, assign another output routing, etc.
- 

## VST Instruments and Processor Load

VST instruments can consume a lot of CPU power. The more instruments you add, the more likely you will run out of processor power during playback.

If the CPU overload indicator in the **Audio Performance** window lights up or you get crackling sounds, you have the following options:

- Activate **Freeze Instrument Channel**.  
This renders the instrument into an audio file and unloads it.
- Activate **Suspend VST 3 plug-in processing when no audio signals are received** for VST 3 instruments.  
This ensures that your instruments do not consume CPU power on silent passages.

### RELATED LINKS

[Freezing Instruments](#) on page 556

[Suspend VST 3 plug-in processing when no audio signals are received](#) on page 908

## Freezing Instruments

If you are using a moderately powerful computer or a large number of VST instruments, your computer may not be able to play back all instruments in real time. At this point, you can freeze instruments.

---

### PROCEDURE

1. Do one of the following:
    - Select **Studio > VST Instruments**.
    - Select the instrument track and open the top **Inspector** section.
  2. Click **Freeze**.
  3. In the **Freeze Instrument Options** dialog, make your changes.
  4. Click **OK**.
- 

### RESULT

- The instrument is rendered to an audio file, and on playback you hear the same sound as before freezing.
- Less CPU load is used.
- The **Freeze** button lights up.
- The MIDI/instrument track controls are grayed out.
- The MIDI parts are locked.

#### NOTE

To edit the tracks, parameters, or synth channels again, and to delete the rendered file, unfreeze the instrument by clicking **Freeze** again.

---

## Freeze Instrument Options Dialog

The **Freeze Instrument Options** dialog opens when you click **Freeze**. It allows you to specify exactly what should happen if you freeze an instrument.

The following controls can be found in the **Freeze Instrument Options** dialog:

### Freeze Instrument Only

Activate this option if you still want to be able to edit insert effects on the synth channel after freezing the instrument.

### Freeze Instrument and Channels

Activate this option if you do not need to edit the insert effects on your synth channels.

#### NOTE

You can still adjust level, pan, sends, and EQ.

---

### Tail Size

Allows you to set a tail size time to let sounds complete their normal release cycle.

### Unload Instrument when Frozen

Activate this option to unload the instrument after freezing. This makes the RAM available again.

## Latency

The term latency stands for the time it takes for the instrument to produce a sound when you press a key on your MIDI controller. It can be an issue when using VST instruments in real time. Latency depends on your audio hardware and its ASIO driver.

In the **Studio Setup** dialog (**VST Audio System** page), the input and output latency values should ideally be a few milliseconds.

If the latency is too high to allow comfortable real time VST instrument playback from a keyboard, you can use another MIDI sound source for live playback and recording, and switch to the VST instrument for playback.

#### RELATED LINKS

[Selecting an Audio Driver](#) on page 14

## Delay Compensation

During playback, Cubase automatically compensates any delay inherent in the VST plug-ins you use.

You can specify a **Delay Compensation Threshold** in the **Preferences** dialog (**VST** page), so that only plug-ins with a delay higher than this threshold setting are affected.

## Constrain Delay Compensation

To avoid that Cubase adds latency when you play a VST instrument in real time or record live audio, you can activate **Constrain Delay Compensation**. This minimizes the latency effects of the delay compensation, while maintaining the sound of the mix as far as possible.

**Constrain Delay Compensation** is available on the **Project** window toolbar and in the **Transport** zone. You can also find it as a menu item in the **MixConsole** on the **Functions Menu**.

Activating **Constrain Delay Compensation** turns off VST plug-ins that are activated for VST instrument channels, audio track channels that are record-enabled, group channels, and output channels. VST plug-ins that are activated for FX channels are disregarded. After recording or using a VST instrument, **Constrain Delay Compensation** should be deactivated again in order to restore full delay compensation.

### RELATED LINKS

[Project Window Toolbar](#) on page 32

## Import and Export Options

### Importing MIDI Loops

You can import MIDI loops (file extension `.midiloop`) in Cubase. These files contain MIDI part information (MIDI notes, controllers, etc.) and all the settings that are saved in instrument track presets. This way, you can reuse instrument patterns in other projects or applications, for example.

---

### PROCEDURE

1. Select **Media > MediaBay**.
2. Optional: On the toolbar, open the **Select Media Types** menu, and activate **MIDI Loops** and **Plug-in Presets**.

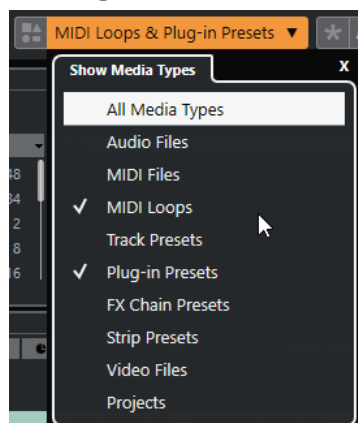

3. In the **Results** list, select a MIDI loop and drag it to an empty section in the **Project** window.

---

### RESULT

An instrument track is created and the instrument part is inserted at the position where you dragged the file. The **Inspector** reflects all settings that are saved in the MIDI loop, for example, the VST instrument that was used, applied insert effects, track parameters, etc.

#### NOTE

You can also drag MIDI loops onto existing instrument or MIDI tracks. However, this only imports the part information. This means this part only contains the MIDI data (notes, controllers) that is saved in the MIDI loop, but no **Inspector** settings or instrument parameters.

---

#### RELATED LINKS

[Presets for Instruments](#) on page 553

[Filtering According to Media Type](#) on page 511

## Exporting MIDI Loops

You can export MIDI loops to save a MIDI part together with its instrument and effect settings. This allows you to reproduce patterns that you created without having to search for the correct sound, style, or effect. MIDI loops have the file extension `.midiloop`.

---

#### PROCEDURE

1. Select an instrument part.
  2. Select **File > Export > MIDI Loop**.
  3. In the **Save MIDI Loop** dialog, enter a name for the MIDI loop.
  4. Optional: To save attributes for the MIDI loop, click the button below the **New MIDI Loop** section at the bottom left.  
The **Attribute Inspector** section opens, allowing you to define attributes for your MIDI loop.
  5. Click **OK**.
- 

#### RESULT

MIDI loop files are saved in the following folder:

Windows: \Users\\AppData\Roaming\Steinberg\MIDI Loops

macOS: /Users/<user name>/Library/Application Support/Steinberg/MIDI Loops/

The default folder cannot be changed. However, you can create subfolders within this folder to organize your MIDI loops. To create a subfolder, click **New Folder** in the **Save MIDI Loop** dialog.

## Exporting Instrument Tracks as MIDI Files

You can export instrument tracks as standard MIDI files.

---

#### PROCEDURE

1. Select an instrument track.
  2. Select **File > Export > MIDI File**.
  3. In the **Export MIDI File** dialog, select a location and enter a name for the MIDI file.
  4. Click **Save**.
  5. In the **Export Options** dialog, make your changes.  
If you activate **Export Inspector Volume/Pan**, volume and pan information of the VST instrument are converted and written into the MIDI file as controller data.
  6. Click **OK**.
- 

#### RESULT

The instrument track is exported as standard MIDI file. As there is no MIDI patch information in an instrument track, this information is missing in the resulting MIDI file.

RELATED LINKS

[Exporting MIDI Tracks as Standard MIDI Files](#) on page 141

## VST Quick Controls

**VST Quick Controls** allow you to remote-control a VST instrument from within the **VST Instruments** window.

To show the **VST Quick Controls** on the **VST Instruments** window, activate **Show/Hide all VST Quick Controls**.

The following controls are available on each rack:



- 1 Show/Hide VST Quick Controls**  
Allows you to show/hide the **VST Quick Controls** for the instrument.
- 2 VST Quick Controls**  
Allow you to remote-control the parameters of the instrument.

**NOTE**

The number of **VST Quick Controls** that are shown depends on the size of the **VST Instruments** window.

- 3 Set Remote-Control Focus for VST Quick Controls**  
Allows you to activate the **VST Quick Controls** to remote-control the instrument.

RELATED LINKS

[Remote Controlling Cubase](#) on page 576

[Connecting VST Quick Controls with Remote Controllers](#) on page 560

## Connecting VST Quick Controls with Remote Controllers

**VST Quick Controls** become powerful if you use them together with a remote controller.

PREREQUISITE

The MIDI output on your remote unit is connected to a MIDI input on your MIDI interface.

PROCEDURE

- Select **Studio > Studio Setup**.
- In the **Devices** list, select **VST Quick Controls**.
- Open the **MIDI Input** pop-up menu, and select a MIDI input.
- Optional: Open the **MIDI Output** pop-up menu, and select a MIDI output.
- Click **Apply**.
- Activate **Learn**.
- In the **Control Name** column, select **QuickControl 1**.
- On your MIDI device, move the control that you want to connect with the first quick control.



9. Select the next slot in the **Control Name** column and repeat the previous steps.
  10. Click **OK**.
- 

#### RESULT

The **VST Quick Controls** are now connected with control elements on your MIDI device. If you move a control element, the value of the parameter that is assigned to the corresponding **VST Quick Controls** changes accordingly.

#### NOTE

The remote controller setup for **VST Quick Controls** is saved globally, that is, it is independent of any projects.

---

#### RELATED LINKS

[Generic Remote Page](#) on page 580

## Side-Chain Input for VST Instruments

You can send audio into VST 3 instruments that feature a side-chain input. Side-chaining allows you to use the output of one track to control the action of an instrument on another track.

Depending on the instrument, activating its side-chain input allows you to:

- Use the instrument as an effect plug-in on audio events.
- Use the side-chain signal as a modulation source.
- Apply ducking to the instrument, that is, reduce the volume of the instrument track when a signal is present on the audio track.

You can route the audio signal to the side-chain input of an instrument in different ways:

- To process the audio signal completely through the instrument, route the output of the audio track to the side-chain input of an instrument.
- To use both the clean audio signal and the signal processed by the instrument, route a send to the instrument side-chain.

#### NOTE

To hear the audio played through the instrument, you must trigger a note, either by playing MIDI events or by playing notes on your external MIDI keyboard.

---

#### RELATED LINKS

[Using Instruments as Effects on Audio Tracks](#) on page 561

## Using Instruments as Effects on Audio Tracks

You can use instruments that support side-chaining to modify the audio on audio tracks. The following example shows you how to apply the parameters in Retrologue to a drum loop.

#### PREREQUISITE

You have a drum loop on an audio track. You have created an instrument track with Retrologue loaded.

---

#### PROCEDURE

1. On the Retrologue control panel, click **Activate Side-Chain**.
2. On the control panel, click **Set Up Side-Chain Input**.

3. Click **Add Side-Chain Input**, and select the audio track from the selector.
4. In the **Project** window, select the audio track.
5. In the **Inspector** for the audio track, open the **Output Routing** pop-up menu and select Retrologue as a side-chain input.
6. On the Retrologue panel in the **Oscillator Mix** section, adjust the **Input Level** control.
7. Optional: Deactivate oscillators **OSC 1**, **OSC 2**, and **OSC 3**.
8. Do one of the following:
  - On the instrument track, create a MIDI event, set up a cycle with the left and right locators, and activate cycle mode.
  - Play notes on your MIDI keyboard.

**NOTE**

For this to work, your MIDI keyboard must be installed and set up.

---

**RESULT**

When a note is played, the drum loop is played back through Retrologue.

**AFTER COMPLETING THIS TASK**

Use Retrologue to modify the sound of your drum loop. For example, you can do the following:

- Use the filter and distortion settings on the **Synth** page.
- Modulate the input signal. To do this, select **Modulation Matrix > Destination > Oscillator > Audio Input**.
- Set up a rhythmical modulation on the **Arp** page.
- Use the effects on the **FX** page, for example the **Resonator**.

**NOTE**

For detailed information about Retrologue and its parameters, see the separate document **Retrologue**.

---

# Installing and Managing VST Plug-ins

Cubase supports the VST 2 and VST 3 plug-in standards. You can install effects and instruments that comply with these formats.

## NOTE

Cubase only supports 64-bit plug-ins.

A plug-in is a piece of software that adds a specific functionality to Cubase. The audio effects and instruments that are used in Cubase are VST plug-ins.

VST effect or VST instrument plug-ins normally have their own installation application. Read the documentation or readme files before installing new plug-ins.

When you scan for newly installed plug-ins or relaunch Cubase, the new plug-ins are shown on the VST effect or VST instrument selectors, respectively.

Cubase comes with a number of effect plug-ins included. These effects and their parameters are described in the separate document **Plug-in Reference**.

## Plug-ins and Collections

The **VST Plug-in Manager** shows the VST effects and VST instruments that are installed on your computer.

In Cubase, plug-ins are arranged in collections. Only one collection can be active at the same time. The plug-ins contained in the active collection are shown in the selectors all over the program.

When you launch Cubase, all plug-ins that are found are automatically placed in the **Default** collection. This is the collection of plug-ins that is active by default.

The **Default** collection is created each time you start Cubase or you initiate a rescan.

You can, however, add your own VST effect or VST instrument collections. This is useful if you only want to see the specific plug-ins that are used in a specific project, for example. When you activate this collection, all VST effects and VST instruments of this collection are shown in the selectors for VST effects or VST instruments.

## NOTE

If an installed VST effect or a VST instrument could not be loaded by Cubase, it is not shown on the **VST Effects** tab or the **VST Instruments** tab, and grayed out in any collection. In this case, verify if that plug-in is copy-protected.

## RELATED LINKS

[VST Plug-in Manager Window](#) on page 564

[Adding New Plug-in Collections](#) on page 566

## VST Plug-in Manager Window

You can manage VST effects and VST instruments in the **VST Plug-in Manager** window.

- To open the **VST Plug-in Manager** window, select **Studio > VST Plug-in Manager**.

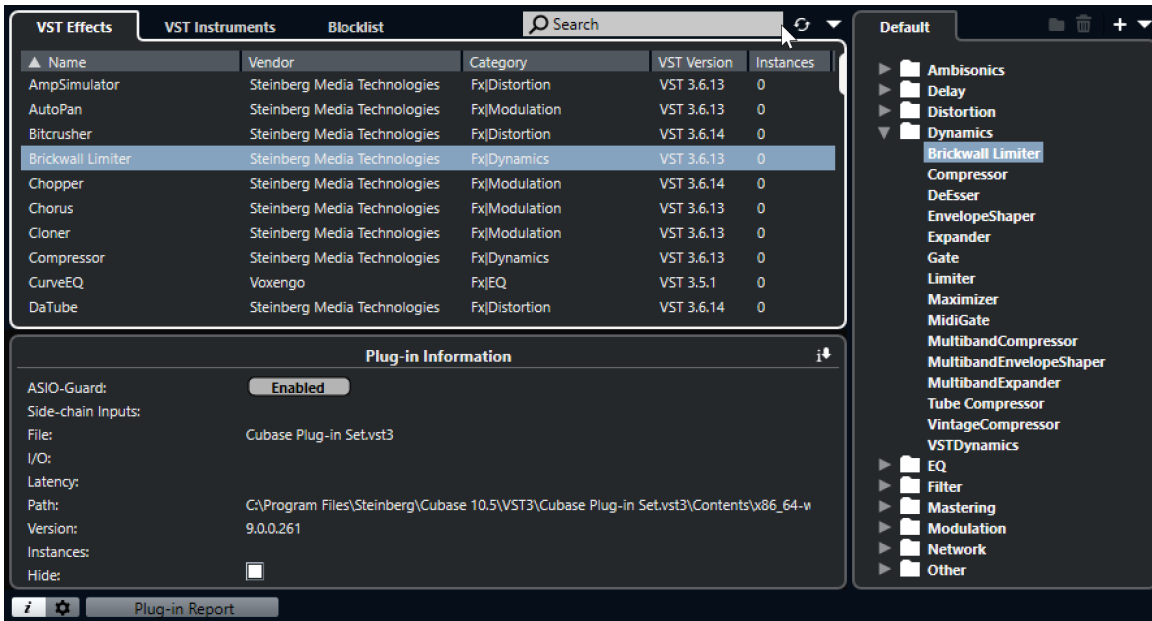

The **VST Plug-in Manager** is divided into the following sections:

### VST Effects

Lists all VST effects that are loaded in Cubase. To sort the list by a specific attribute, click the corresponding column header.

### VST Instruments

Lists all VST instruments that are loaded in Cubase. To sort the list by a specific attribute, click the corresponding column header.

### Blocklist

Lists all VST effects and VST instruments that are installed on your system but not loaded in Cubase, because they might lead to stability problems or even cause the program to crash.

### Toolbar

Shows tools and shortcuts for functions in the **VST Plug-in Manager**.

### Active collection

Shows the active collection. The plug-ins of the active collection are shown in the selectors for VST effects and VST instruments.

### Show VST Plug-in Information

Shows information about the selected plug-in.

### VST 2 Plug-in Path Settings

Shows the path of the selected VST 2 plug-in.

### Plug-in Report

Opens the File Explorer/macOS Finder that allows you to save a text file that contains information about your system as well as plug-in information. This is useful for troubleshooting, for example.

#### RELATED LINKS

- [Plug-ins and Collections](#) on page 563
- [VST Audio System Page](#) on page 15
- [VST Plug-in Manager Toolbar](#) on page 565
- [VST 2 Plug-in Path Settings](#) on page 566
- [Hiding Plug-ins](#) on page 567
- [Reactivating Plug-ins from the Blocklist](#) on page 567

## VST Plug-in Manager Toolbar

Shows tools and shortcuts for functions in the **VST Plug-in Manager**.

- To open the **VST Plug-in Manager** window, select **Studio > VST Plug-in Manager**.

#### Search field



Allows you to search for specific plug-ins on the **VST Effects** tab or on the **VST Instruments** tab by typing in their name.

#### Display Options



Allows you to choose which plug-ins are shown:

- **Show All Plug-ins** shows all loaded plug-ins.
- **Hide Plug-ins That Are in Active Collection** hides all plug-ins that are part of the active collection.
- **Show Plug-ins That Support 64-Bit Float Processing** shows all VST 3 plug-ins that support 64-bit float processing.

#### New Folder



Creates a new folder in the current collection.

#### Delete



Deletes the selected item in the current collection.

#### New Collection



Creates a new collection.

- **Empty** creates a new, empty collection.
- **Add All Plug-ins** creates a new collection that contains all VST effects or VST instruments respectively.
- **Copy Current Collection** creates a new collection that contains the current collection.

#### Plug-in Collections and Options



- **Default** activates the default collection.
- **New Collection** allows you to create a new collection.
- **Remove Unavailable Plug-ins from All Collections** removes all plug-ins that are not available from all user-created collections.
- **Sort By Category** sorts the collection by category.

**NOTE**

This option is only available for the **Default** collection.

- **Sort By Vendor** sorts the collection by vendor.

**NOTE**

This option is only available for the **Default** collection.

---

## VST 2 Plug-in Path Settings

Shows information about the selected VST 2 plug-in path.

- To open the **VST 2 Plug-in Path Settings**, select **Studio > VST Plug-in Manager**, and click **VST 2 Plug-in Path Settings**.



### VST 2 Plug-in path list

Shows all VST 2 plug-in paths.

### Add Path

Allows you to add a new VST 2 plug-in path.

### Delete Path

Deletes the selected VST 2 plug-in path.

### Reset

Resets the list to default.

### Rescan All

Rescans the plug-in list.

## Adding New Plug-in Collections

You can add new collections of VST effects or VST instruments.

### PREREQUISITE

A number of effect plug-ins is installed on your computer, and these plug-ins are listed in the **VST Plug-in Manager** on the **VST Effects** tab and the **VST Instruments** tab.

---

### PROCEDURE

1. In the **VST Plug-in Manager** toolbar, click **New Collection**, and select an option.

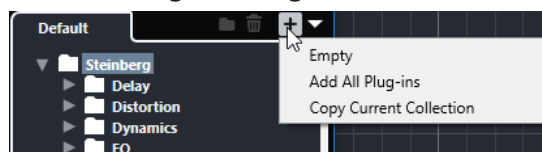

2. In the **New Collection** dialog, enter a name for the new collection and click **OK**.

3. Optional: Click **New Folder**.  
You can then move your plug-ins into these folders to organize them by categories, for example.
  4. Enter a name for the new folder and click **OK**.
  5. On the **VST Effects** tab or the **VST Instruments** tab, select the plug-ins that you want to add to the collection, and drag them in the new collection.  
If you created folders, you can drag the plug-ins directly into folders.
- 

#### RESULT

The new collection is saved. If you select it, its plug-ins are shown in the plug-in selectors.

#### AFTER COMPLETING THIS TASK

To remove a plug-in from a collection, select it and click **Remove**.

#### RELATED LINKS

[Plug-ins and Collections](#) on page 563

[VST Plug-in Manager Window](#) on page 564

## Hiding Plug-ins

You can hide plug-ins from all collections. This is useful if you have plug-ins installed on your computer that you do not want to use in Cubase.

---

#### PROCEDURE

1. Select **Studio > VST Plug-in Manager**.
2. On the **VST Effects** tab or on the **VST Instruments** tab, select the plug-ins that you want to hide from view.
3. Click **Show VST Plug-in Information** to show information about the selected plug-in.
4. Activate **Hide**.

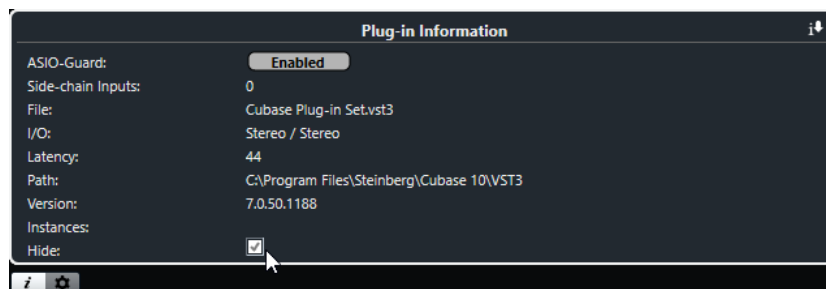

#### RESULT

The selected plug-in is hidden from view.

#### RELATED LINKS

[ASIO-Guard](#) on page 884

## Reactivating Plug-ins from the Blocklist

You can reactivate 64-bit plug-ins that are on the blocklist.

---

#### PROCEDURE

1. On the **Blocklist** tab, select the plug-ins that you want to reactivate.

**NOTE**

You cannot reactivate 32-bit plug-ins, because they are not supported.

---

2. Click **Reactivate**.
- 

**RESULT**

Cubase rescans the plug-in and removes it from the blocklist.

**AFTER COMPLETING THIS TASK**

If you want to move the plug-in back to the blocklist, click **Rescan All** in the **VST 2 Plug-in Path Settings**, and restart Cubase.

**RELATED LINKS**

[VST Plug-in Manager Window](#) on page 564



# Track Quick Controls

Cubase allows you to set up 8 different track parameters or settings as **Track Quick Controls** for quick access.

**Track Quick Controls** are available for the following track types:

- Audio
- MIDI
- Instrument
- Sampler
- FX Channel
- Group Channel

For instrument tracks and for MIDI tracks for which you assigned a VST instrument on creation, that is, that you created by loading a rack instrument, **Track Quick Controls** are automatically assigned to the **Quick Controls** of the VST instrument.

For sampler tracks, **Track Quick Controls** are automatically assigned to the sound parameters of **Sampler Control**.

## NOTE

You can change the default assignment by assigning different track parameters or by loading a preset.

Assigning parameters to **Quick Controls** is done in the **Inspector** or the **MixConsole**.

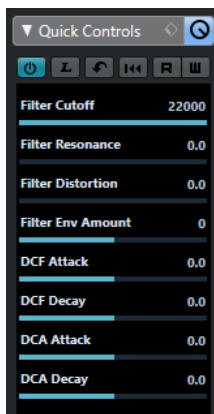

**Quick Controls** section in the **Inspector**



**Track Quick Controls** rack in the **MixConsole**

**Quick Controls** assignments are saved with the project.

You can assign **Track Quick Controls** to an external remote control device. For this to work, you must connect **Track Quick Controls** with your remote controller.

You can automate parameter settings in the **Quick Controls** section using the **Read/Write** buttons (**R** and **W**).

#### RELATED LINKS

[Track Presets](#) on page 162

[Automation](#) on page 535

[Channel Racks Selector](#) on page 322

## Parameter Assignment

You can assign track, effect, and instrument parameters to **Quick Controls**.

For the parameter assignment, you can use the **Inspector** or the **MixConsole**. You can assign parameters manually, use the **QC Learn Mode**, or load an assignment preset.

#### RELATED LINKS

[Assigning Track Parameters to Quick Controls](#) on page 570

[Assigning Effect Parameters to Quick Controls](#) on page 571

[Using QC Learn Mode](#) on page 571

[Adding Track Quick Controls in the MixConsole](#) on page 347

[Setting Instrument Parameter Assignments to Default](#) on page 572

[Removing Parameter Assignments](#) on page 572

[Loading Track Quick Control Assignments as Presets](#) on page 573

## Assigning Track Parameters to Quick Controls

You can assign track parameters manually.

#### NOTE

For instrument tracks and MIDI tracks for which you assigned a VST instrument on creation, the main parameters of the instrument are automatically assigned to the slots in the **Quick Controls** section in the **Inspector**.

---

#### PROCEDURE

1. In the **Inspector** for your track, open the **Quick Controls** section.
2. In the **Quick Controls** section, click the first slot to open a selector that lists all parameters for the track.
3. Select the parameter that you want to assign to the first **Quick Control**.

The parameter name and its value are displayed in the slot. You can change the value by dragging the slider.

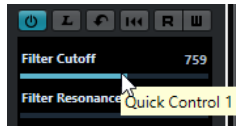

4. Repeat these steps for all slots for which you want to assign track parameters.
- 

#### RESULT

You can now control the track parameters via the **Quick Controls** section in the **Inspector** or via the **Track Quick Controls** rack in the **MixConsole**.

#### AFTER COMPLETING THIS TASK

You can rename a **Quick Control** by double-clicking on the name and entering a new one. This is useful if a parameter name is very long, for example.

## Assigning Effect Parameters to Quick Controls

You can assign effect parameters to **Quick Control** slots directly from within plug-in panels.

#### NOTE

This is only available for VST 3 plug-ins that support this function.

---

#### PROCEDURE

- In the effect plug-in panel, right-click the parameter.
    - Select **Add “x” to Quick Controls** (where x is the name of the parameter) to assign the parameter to the next empty slot.
    - Select **Add “x” to Quick Controls Slot** (where x is the name of the parameter), and select the slot from the submenu to assign the parameter to a specific slot.
- 

#### RESULT

You can now control the effect parameters via the **Quick Controls** section in the **Inspector** or via the **Track Quick Controls** rack in the **MixConsole**.

## Using QC Learn Mode

The **QC Learn Mode** allows you to assign a parameter by moving controls. This applies to all automatable controls.

---

#### PROCEDURE

1. In the **Inspector** for your track, open the **Quick Controls** section.
  2. Activate **QC Learn Mode**.
  3. Select the slot to which you want to assign a parameter.
  4. Move the control.
- 

#### RESULT

The track parameter is assigned to the corresponding control.

#### RELATED LINKS

[Controlling Automatable Parameters](#) on page 573

## Setting Instrument Parameter Assignments to Default

If you have changed the parameter assignment or if you manually routed a MIDI track to a VST instrument, you can retrieve the default assignments.

---

### PROCEDURE

1. In the **Inspector** for the instrument or MIDI track, open the **Quick Controls** section.
2. Click **Get Default QCs from Plug-in**.

---

### RESULT

The instrument parameter assignments are set to default.

## Removing Parameter Assignments

You can remove parameter assignments for individual **Quick Controls** or for all **Quick Controls** at once.

---

### PROCEDURE

- Do one of the following:
  - To remove a parameter from a slot, click in the corresponding slot and select **No parameter** from the pop-up menu.

### NOTE

You can also double-click the parameter name, press **Delete** or **Backspace**, and confirm with **Return**.

- To remove the **Quick Control** assignments for all slots, click **Remove All QC Assignments**.

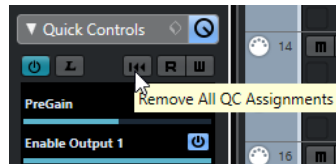

---

## Saving Track Quick Control Assignments as Presets

You can save **Quick Control** assignments as track presets.

### PREREQUISITE

You have assigned track parameters to **Quick Controls**.

---

### PROCEDURE

1. In the **Inspector** for your track, open the **Quick Controls** section.
2. In the **Quick Controls** section, click **Preset Management** .
3. Click **Save Preset**.
4. Enter a name in the **Type In Preset Name** dialog.
5. Click **OK**.

---

### RESULT

The **Quick Control** assignment is saved as a preset.

RELATED LINKS

[Assigning Track Parameters to Quick Controls](#) on page 570

## Loading Track Quick Control Assignments as Presets

You can load presets for **Quick Control** assignments.

---

PROCEDURE

1. In the **Inspector** for your track, open the **Quick Controls** section.
  2. In the **Quick Controls** section, click **Preset Management** .
  3. Select one of the presets in the upper list of the menu.
- 

RESULT

The preset is loaded and allows you to access the channel parameters.

## Controlling Automatable Parameters

You can use **Quick Controls** to control all automatable parameters. This allows you to control parameters on other tracks using **Quick Controls**.

IMPORTANT

Use this function with caution, as you might accidentally modify parameters on other tracks.

---

PROCEDURE

1. Create a new, empty audio track and open the **Quick Controls** section.
2. Hold down **Ctrl/Cmd** and click the first **Quick Control** slot.  
The selector lists all automatable parameters.
3. Open the **VST Mixer** folder.  
The selector lists all channels that are available in the **MixConsole** of your project.

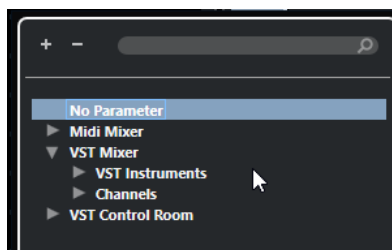

4. Assign a parameter of one particular channel to **Quick Control 1**, and another parameter of another channel to **Quick Control 2**.
- 

RESULT

The **Quick Controls** section now allows you to control automatable parameters on different tracks.

IMPORTANT

You cannot save **Quick Control** assignments for automatable parameters on different tracks as track presets.

---

## Showing Automated Quick Control Assignments

You can show all **Quick Control** assignments that have been automated for one track.

---

### PROCEDURE

1. Click the track for which you want to show automated **Quick Control** assignments.
2. In the **Inspector** for your track, open the **Quick Controls** section.
3. In the **Quick Controls** section, click **Preset Management** .
4. Select **Show Automated QC Assignments**.

---

### RESULT

The automation tracks of the automated **Quick Control** parameters open for the selected track.

### NOTE

- If **Volume** is assigned as a **Quick Control** parameter, it is always shown as automated, independent of whether it is automated or not.
- You can also show automated **Quick Control** assignments via the **Track Quick Controls** rack in the **MixConsole**.

## Connecting Track Quick Controls with Remote Controllers

**Track Quick Controls** become powerful if you use them together with a remote controller.

### PREREQUISITE

The MIDI output on your remote unit is connected to a MIDI input on your MIDI interface.

---

### PROCEDURE

1. Select **Studio > Studio Setup**.
2. In the **Devices** list, select **Track Quick Controls**.
3. Open the **MIDI Input** pop-up menu, and select a MIDI input.
4. Optional: Open the **MIDI Output** pop-up menu, and select a MIDI output.
5. Click **Apply**.
6. Activate **Learn**.
7. In the **Control Name** column, select **QuickControl 1**.
8. On your MIDI device, move the control that you want to connect with the first quick control.
9. Select the next slot in the **Control Name** column and repeat the previous steps.
10. Click **OK**.

---

### RESULT

The **Track Quick Controls** are now connected with control elements on your MIDI device. If you move a control element, the value of the parameter that is assigned to the corresponding **Track Quick Controls** changes accordingly.

### NOTE

The remote controller setup for **Track Quick Controls** is saved globally, that is, it is independent of any projects.

---

RELATED LINKS

[Generic Remote Page](#) on page 580

## Activating Pick-up Mode for Hardware Controls

**Pick-up Mode** allows you to change configured **Quick Control** parameters without accidentally modifying the previous values. This is useful if you want the control to pick up the parameter at the value to which it was last set. If you move a hardware control, the parameter only changes once the control reaches the previous value.

NOTE

This only applies to hardware controllers whose controls use specific ranges.

---

PROCEDURE

1. Select **Studio > Studio Setup**.
  2. In the **Devices** list, select **Track Quick Controls** or **VST Quick Controls**.
  3. Activate **Pick-up Mode**.
  4. Click **OK**.
-

# Remote Controlling Cubase

You can control Cubase via MIDI with a connected MIDI device.

The supported devices are described in the separate document **Remote Control Devices**. You can also use a generic MIDI controller to remote-control Cubase.

## NOTE

Most remote-control devices are able to control both MIDI and audio channels in Cubase, but the parameter setup may be different. Audio-specific controls such as EQ are disregarded when controlling MIDI channels.

## RELATED LINKS

[Generic Remote Page](#) on page 580

## Connecting Remote Devices

You can connect your remote device via USB or via MIDI.

## PROCEDURE

- Do one of the following:
  - If your remote device provides a USB MIDI port, use a USB cable to connect it to the USB port of your computer.
  - If your remote device provides a MIDI output, use a MIDI cable to connect it to a MIDI input on your MIDI interface.

## NOTE

If the remote unit features feedback devices such as indicators, motorized faders, etc., connect a MIDI Out on the interface to a MIDI In on the remote unit.

## RELATED LINKS

[MIDI Connections](#) on page 20

## Removing the Remote Input from All MIDI Inputs

To avoid that you accidentally record data from the remote unit when you record MIDI, you must remove the remote input from **All MIDI Inputs**.

## PROCEDURE

1. Select **Studio > Studio Setup**.
2. In the **Devices** list, select **MIDI Port Setup**.



3. In the table on the right, deactivate **In 'All MIDI Inputs'** for the MIDI input to which you have connected the MIDI remote unit.  
The **State** column reads **Inactive**.
4. Click **OK**.

#### RESULT

The remote unit input is removed from the **All MIDI Inputs** group.

#### RELATED LINKS

[MIDI Port Setup Page](#) on page 21

## Setting up Remote Devices

#### PROCEDURE

1. Select **Studio > Studio Setup**.
2. Click + in the top left corner and select a remote device from the pop-up menu to add it to the **Devices** list.

#### NOTE

If your device is not available in the pop-up menu, select **Generic Remote**.

3. In the **Devices** list, select the device.  
Depending on the selected device, either a list of programmable function commands or a blank panel is shown in the right half of the dialog window.

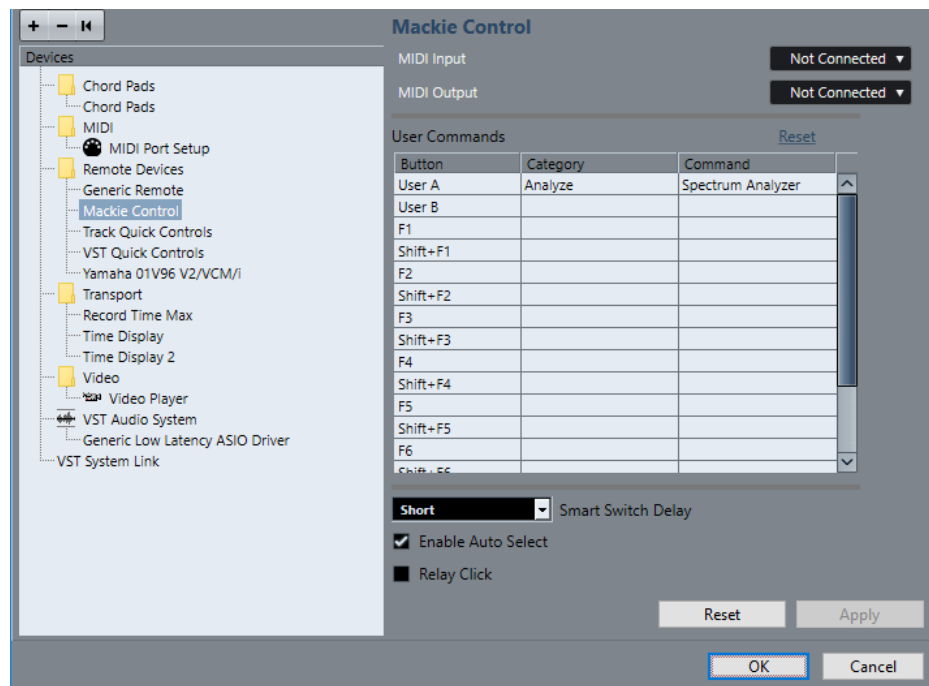

4. Open the **MIDI Input** pop-up menu and select a MIDI input.
5. Optional: Open the **MIDI Output** pop-up menu and select a MIDI output.
6. Click **OK**.

#### RESULT

You can now use the MIDI device to control Cubase functions.

A bright stripe in the **Project** window and in the **MixConsole** indicates which channels are linked to the remote-control device.



You can open a panel for the added device by selecting **Studio > More Options**.

AFTER COMPLETING THIS TASK

Depending on your external MIDI control device, you might need to configure the parameters.

## Resetting Remote Devices

Sometimes you must reset remote devices, because the communication between Cubase and a remote device was interrupted or the handshaking protocol fails to create a connection.

---

### PROCEDURE

1. Select **Studio > Studio Setup**.
2. In the **Devices** list, select the remote device.
3. Click **Reset** in the lower part of the **Studio Setup** dialog to reset the selected remote device.

### NOTE

To reset all devices in the **Devices** list, click **Send Reset Message to All Devices** in the top left of the dialog.

---

## Global Options for Remote Controllers

On the page for your remote device, global functions may be available.

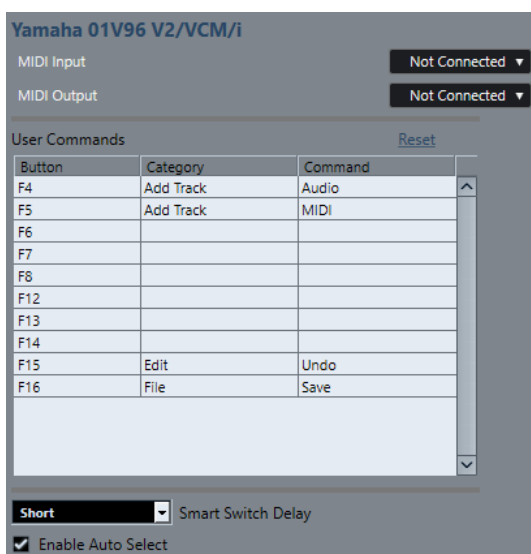

**MIDI Input**

Allows you to select a MIDI input.

**MIDI Output**

Allows you to select a MIDI output.

**User Commands**

Lists the controls or buttons of your remote device.

**Smart Switch Delay**

Allows you to specify a delay for the smart switch function. Functions that support the smart switch behavior are activated for as long as the button is pressed.

**Enable Auto Select**

On touch-sensitive remote control devices, this automatically selects a channel when you touch a fader. On devices without touch-sensitive faders, the channel gets selected as soon as you move the fader.

## Remote Devices and Automation

You can write automation using remote devices.

If your remote device does not have touch-sensitive controls and you want to replace existing automation data in **Write** mode, consider the following:

- Make sure that you move only the controller that you want to replace.
- Stop playback to deactivate **Write** mode.

This way, all data for the corresponding parameter is replaced from the position where you moved the control, up to the position where you stop playback.

## Assigning Commands to Remote Devices

You can assign any Cubase command to which a key command can be assigned to remote devices.

---

**PROCEDURE**

1. Select **Studio > Studio Setup**.
2. In the **Devices** list, select your remote device.  
In the **User Commands** section, the controls or buttons of your remote device are listed in the **Button** column.

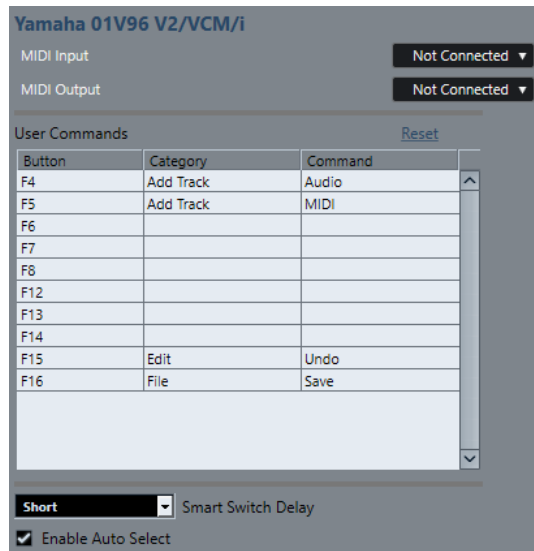

3. Click in the **Category** column for the control to which you want to assign a Cubase command, and select the category from the pop-up menu.  
The categories correspond to the categories in the **Key Commands** dialog.
  4. Click in the **Command** column, and select the Cubase command from the pop-up menu.  
The available items on the pop-up menu depend on the selected category.
  5. Click **Apply**.
- 

#### RESULT

The selected function is assigned to the button or control on the remote device.

#### RELATED LINKS

[Key Commands](#) on page 854

## Generic Remote Page

You can use a generic MIDI controller to remote-control almost any function in Cubase. After setting up the **Generic Remote** device, you can control the specified parameters from the MIDI remote device.

- To open the **Generic Remote** page, select **Studio > Studio Setup**, and from the **Devices** list, select **Generic Remote**.

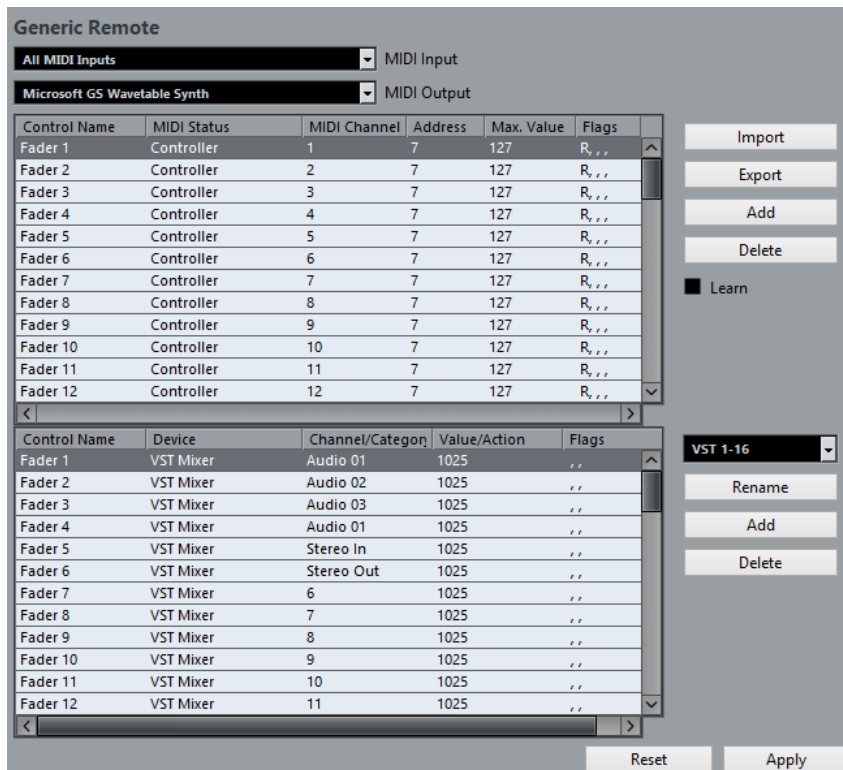

The following options are available:

#### MIDI Input

Allows you to select the MIDI input port to which your remote device is connected.

#### MIDI Output

Allows you to select the MIDI output port to which your remote device is connected.

#### MIDI Remote Control Configuration

The upper table shows the MIDI remote-control configuration of your remote device.

#### Cubase Control Assignment

The lower table allows you to assign Cubase controls to your remote device.

#### RELATED LINKS

[MIDI Remote Control Configuration Section](#) on page 581

[Cubase Control Assignment Section](#) on page 583

## MIDI Remote Control Configuration Section

The MIDI remote-control configuration section is shown in the upper table of the **Generic Remote** setup page.

- To open the **Generic Remote** settings, select **Studio > Studio Setup**, and from the **Devices** list, select **Generic Remote**.

Control Name	MIDI Status	MIDI Channel	Address	Max. Value	Flags
Fader 1	Controller	1	7	127	R, r, r
Fader 2	Controller	2	7	127	R, r, r
Fader 3	Controller	3	7	127	R, r, r
Fader 4	Controller	4	7	127	R, r, r
Fader 5	Controller	5	7	127	R, r, r
Fader 6	Controller	6	7	127	R, r, r
Fader 7	Controller	7	7	127	R, r, r
Fader 8	Controller	8	7	127	R, r, r
Fader 9	Controller	9	7	127	R, r, r
Fader 10	Controller	10	7	127	R, r, r
Fader 11	Controller	11	7	127	R, r, r
Fader 12	Controller	12	7	127	R, r, r

The following options are available in the upper table:

### Control Name

Double-click this field to change the name for the control, and enter the one written on the console, for example. This name is automatically reflected in the lower table.

### MIDI Status

Allows you to specify the type of MIDI message sent by the control.

### MIDI Channel

Allows you to select the MIDI channel on which the controller is transmitted.

### Address

Allows you to specify the continuous controller number, the pitch of a note, or the address of an NRPN/RPN continuous controller.

### Max. Value

Allows you to specify the maximum value that the control transmits. This value is used by the program to scale the value range of the MIDI controller to the value range of the program parameter.

### Flags

Allows you to select one of the following flags:

- **Receive**  
Activate this if the MIDI message should be processed on reception.
- **Transmit**  
Activate this if a MIDI message should be transmitted when the corresponding value in the program changes.
- **Relative**  
Activate this if the control is an endless rotary encoder, which reports the number of turns instead of an absolute value.
- **Pick-up**  
Activate this if you want the control to pick up the parameter at the value to which it was last set.

The buttons and options to the right of the table have the following function:

### Import

Allows you to import saved remote setup files.

### Export

Allows you to export the current setup with the file extension .xml.

### Add

Adds controls to the bottom of the table.

### Delete

Deletes the selected control from the table.

### Learn

Allows you to assign MIDI messages by learning.

## Cubase Control Assignment Section

You can specify the Cubase control assignment section in the lower table of the **Generic Remote** setup page. Each row in the table is assigned to the controller in the corresponding row in the MIDI remote-control configuration table.

- To open the **Generic Remote** settings, select **Studio > Studio Setup**, and from the **Devices** list, select **Generic Remote**.

Control Name	Device	Channel/Category	Value/Action	Flags
Fader 1	VST Mixer	Audio 01	1025	..
Fader 2	VST Mixer	Audio 02	1025	..
Fader 3	VST Mixer	Audio 03	1025	..
Fader 4	VST Mixer	Audio 01	1025	..
Fader 5	VST Mixer	Stereo In	1025	..
Fader 6	VST Mixer	Stereo Out	1025	..
Fader 7	VST Mixer	6	1025	..
Fader 8	VST Mixer	7	1025	..
Fader 9	VST Mixer	8	1025	..
Fader 10	VST Mixer	9	1025	..
Fader 11	VST Mixer	10	1025	..
Fader 12	VST Mixer	11	1025	..

The following options are available:

### Control Name

Reflects the control name selected in the upper table.

### Device

Allows you to select the Cubase device that you want to control.

### Channel/Category

Allows you to select the channel or the command category that you want to control.

### Value/Action

Allows you to select the parameter of the channel that you want to control. If the **Command** device is selected, this is where you specify the **Action** of the category.

### Flags

Allows you to select one of the following flags:

- Push Button**  
Activate this if the parameter should only be changed if the received MIDI message shows a value unequal to 0.
- Toggle**  
Activate this if the parameter value should be switched between minimum and maximum value each time a MIDI message is received.  
You can combine **Push Button** and **Toggle** for remote controls which do not latch the state of a button. This is useful if you want to control the mute status with a device on which pressing the mute button turns it on, and releasing the mute button turns it off.
- Not Automated**  
Activate this if the parameter value should not be automated.

The buttons to the right of the table have the following function:

### Bank pop-up menu

Allows you to switch banks. This is necessary if your MIDI control device has 16 volume faders, and you are using 32 **MixConsole** channels in Cubase, for example.

### Rename

Allows you to rename the selected bank.

### Add

Adds banks to the pop-up menu.

### Delete

Deletes the selected bank from the pop-up menu.

### RELATED LINKS

[Assignable Devices and Functions](#) on page 584

## Assignable Devices and Functions

The **Device** column in the Cubase control assignment section lists the Cubase devices that you can control.

### Command

Allows you to assign the Cubase commands to which a key command can be assigned. If you select **Add Track** in the **Channel/Category** column, and **Audio** in the **Value/Action** column, you can add audio tracks using your MIDI device, for example.

### VST Quick Controls Manager

Allows you to assign **VST Quick Controls**. If you select **Device** in the **Channel/Category** column, and one of the **Quick Control** options in the **Value/Action** column, you can control that **VST quick control** using your MIDI device.

### Midi Mixer

Allows you to control the functions of the **Midi Mixer** panel. If you select **Device** in the **Channel/Category** column, and one of the options in the **Value/Action** column, you can control that function using your MIDI device.

### MMC Master

Allows you to control the functions of the **MMC Master** panel. If you select **Device** in the **Channel/Category** column, and one of the options in the **Value/Action** column, you can control that function using your MIDI device.

### Mixer

Allows you to control **MixConsole** functions. If you select one of the available channels or **Selected** in the **Channel/Category** column, and one of the options in the **Value/Action** column, you can control that function of that specific channel or of the selected channel using your MIDI device.

### Transport

Allows you to control the transport functions. If you select **Device** in the **Channel/Category** column, and one of the options in the **Value/Action** column, you can control that function using your MIDI device.

### Metronome

Allows you to control metronome functions. If you select **Device** in the **Channel/Category** column, and one of the options in the **Value/Action** column, you can control that function using your MIDI device.



### VST Mixer

Allows you to control **MixConsole** functions. If you select one of the available channels or **Selected** in the **Channel/Category** column, and one of the options in the **Value/Action** column, you can control that function of that specific channel or of the selected channel using your MIDI device.

#### NOTE

You can also control all **VST Instruments** that you added in the **Project** window, and that are listed in the **Device** column.

---

## Assigning MIDI Messages in Learn Mode

You can assign MIDI messages in **Learn** mode.

#### PROCEDURE

1. Select **Studio > Studio Setup**.
  2. In the **Devices** list, select **Generic Remote**.
  3. Activate **Learn**.
  4. Select the control in the upper table, and move the corresponding control on your MIDI device.
- 

#### RESULT

The values for **MIDI Status**, **MIDI Channel**, and **Address** are automatically set to those of the moved control.

#### NOTE

If you use the **Learn** function for a control that sends a program change value, **Prog. Change Trigger** is automatically selected in the **MIDI Status** pop-up menu. This allows you to use the different values of a program change parameter to control different parameters in Cubase.

If this does not give you the result you want, try using the **Prog. Change** value instead.

---

## Remote Control Editor

The **Remote Control Editor** allows you to define your own mapping of VST plug-in parameters to the controls of the supported hardware controllers. This is useful if you think that the automatic mapping of plug-in parameters to remote control devices is not too intuitive.

- To open the **Remote Control Editor**, right-click the plug-in panel of the plug-in that you want to remote-control, and select **Remote Control Editor**.

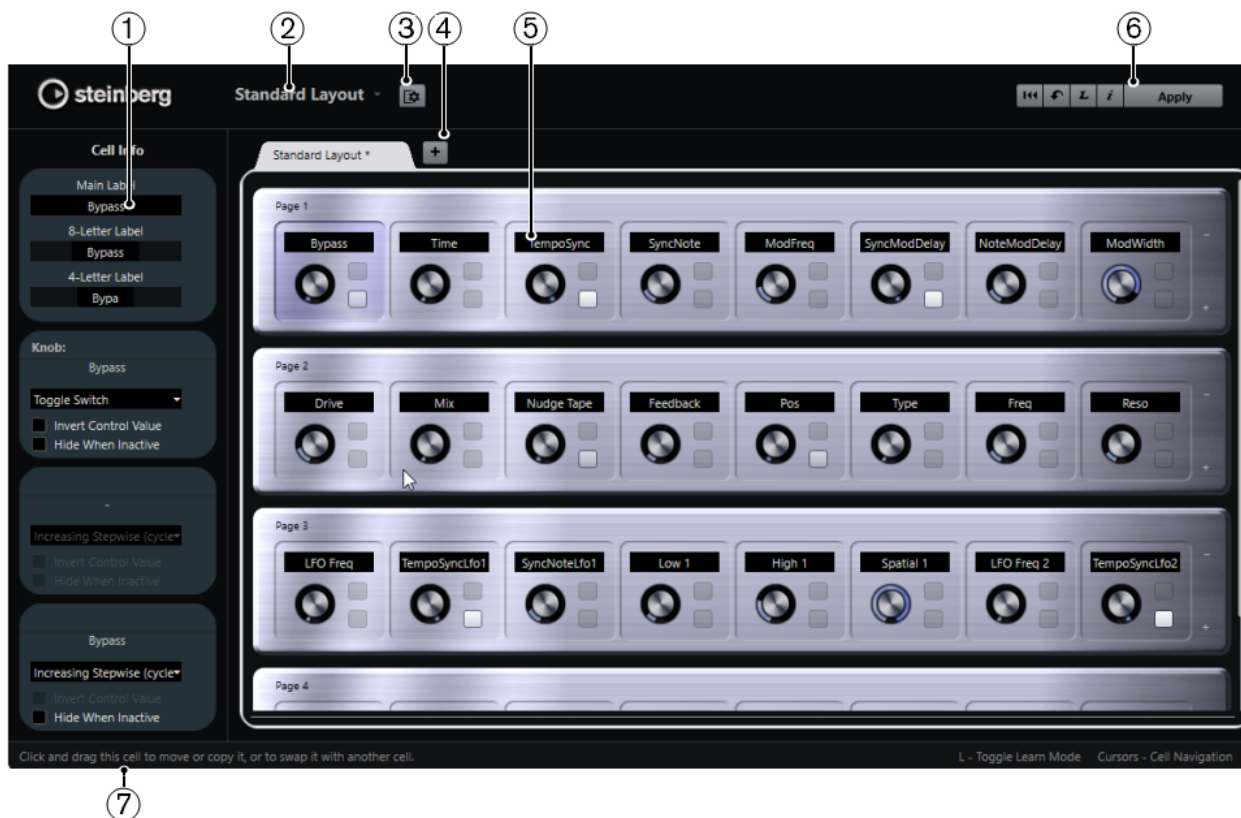

**1 Inspector**

Contains the settings and the parameter assignment for the selected cell. The upper section contains settings for the text label. The lower section contains settings for the knob and the switches.

**2 Layout Selection**

Shows the name of the layout. Click to select a different layout.

**3 Set up Cell Layout**

Opens the **Cell Layout Configuration**, where you can specify the number of cells per page, and select the switch layout that you want to use for the pages. To specify the number of switches for a cell, activate/deactivate them.

**4 Add New Hardware Layout**

Adds a new layout for a particular hardware type. To remove a hardware layout, click its **Close** button.

**5 Layout section**

Shows layouts that represent the hardware devices that are used to remote-control the plug-in parameters. Here you can change the parameter assignments, the name in the text label, the cell setup, and the order of cells and pages.

**6 Toolbar**

Shows tools for setting up the layout.

**7 Status Bar**

Shows information on an element when you position the mouse pointer over it in the editor window.

RELATED LINKS

[Remote Control Editor Toolbar](#) on page 587

## Remote Control Editor Toolbar

Shows tools for setting up the layout.

### Remove All Assignments



Removes all parameter assignments.

### Get Default Factory Layout/Copy Layout from Other Tab



Reverts to the default settings for the current layout or copies the settings of one layout page to another.

### Activate/Deactivate Learn Mode



Activates/Deactivates **Learn** mode for the **Remote Control Editor**.

### Activate/Deactivate Assignment Inspection View



Shows the current assignment of all cells in a layout.

### Apply Current Layout

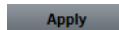

Saves the settings. If the hardware supports this function, the changes are immediately reflected on the hardware controllers.

## Control Settings

You can define the control style for switches or knobs to which you have assigned a function. This includes changing the LED ring or changing its behavior, from continuous value representation to on/off, for example.

To open the **Control Settings** panel, right-click the control.

### NOTE

Not all hardware devices support all control type settings.

## Control Type Settings for Knobs

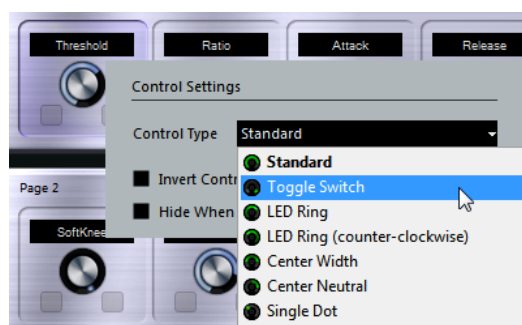

The following control types are available for knobs:

### Standard

A standard knob with undefined LED style.

### Toggle Switch

A knob with 2 states.

### LED Ring

An LED ring around the knob. The setting increases clockwise.

### LED Ring (counter-clockwise)

An LED ring around the knob. The setting increases counter-clockwise.

### Center Width

An LED ring that starts at the top center position, and when the settings increase, an LED is shown growing in both directions.

### Center Neutral

A dial that starts at the top center position and can be moved left or right, like a pan control, for example.

### Single Dot

An LED ring around the knob. The setting increases clockwise with a dot indicating the current value.

## Control Type Settings for Switches

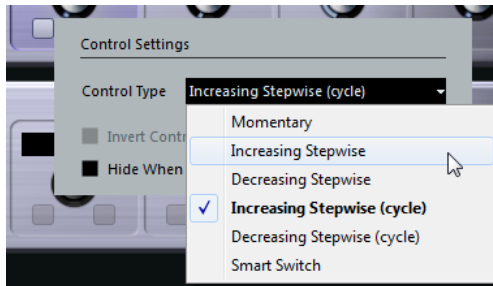

The following options are available for switches:

### Momentary

Activates the assigned function as long as you hold the switch.

### Increasing Stepwise

Steps through the available settings until the maximum is reached.

### Decreasing Stepwise

Steps through the available settings in reverse order until the minimum is reached.

### Increasing Stepwise (cycle)

Steps through the available settings, starting over with the minimum value when the maximum is reached.

### Decreasing Stepwise (cycle)

Steps through the available settings in reverse order, starting over with the maximum value when the minimum is reached.

### Smart Switch

Switches between 2 states every time you press the switch. Enters **Momentary** mode if you hold the switch.

### Invert Control Value

Inverts the control state/value.

### Hide When Inactive

Hides plug-in parameters when they are inactive or disabled.

## Assigning Parameters to Controls

---

### PROCEDURE

1. On the **Remote Control Editor** toolbar, click **Activate/Deactivate Learn Mode**.
  2. Select the control that you want to assign to a plug-in parameter.
  3. Do one of the following:
    - Click a parameter on the plug-in panel.
    - Double-click on a control in the **Remote Control Editor**, and select a parameter from the list of available plug-in parameters.
  4. Press **Esc** to end **Learn** mode.
- 

### RESULT

The parameter is assigned to the control.

### NOTE

To remove the parameter assignment for a cell, activate **Learn** mode, select the cell, and press **Delete** or **Backspace**.

---

### RELATED LINKS

[Remote Control Editor Toolbar](#) on page 587

## Editing the Layout

In the layout section, you can perform a number of editing operations and arrange the pages to your liking.

- To navigate from cell to cell, use the cursor keys.
- To step through the controls within the cells in **Learn** mode, press **Shift** and use the cursor keys.
- To step through the different layouts, use **Tab** and **Shift-Tab**.
- To copy the settings of one cell to another, select a cell, press **Alt** and drag it to another cell.
- To move a cell, drag it to an empty cell.
- To swap the contents of 2 cells, press **Ctrl/Cmd** and drag one cell to the other.

### NOTE

Drag and drop also works between different pages.

---

- To add a page to a layout, click **Add New Page**.



- To remove a page, click **Remove Current Page**.
- To specify the label for a cell, use the top 3 text fields in the **Inspector**.

The first text field shows the long name, as it is shown in the cell. In the second field, you can enter a name that can contain up to 8 characters, and up to 4 characters in the third.

NOTE

This is useful if your hardware devices have value fields that only display a limited number of characters, for example.

---

## Joysticks

You can use a joystick to remote-control panning operations in Cubase. This can be useful, for example, for creating smooth automation curves.

- To use a joystick for remote-controlling, connect it to your computer and restart Cubase. After restarting the application, the joystick is automatically activated.

## Deactivating Joysticks

If you have a joystick connected to your system, but do not want to use it with Cubase, you can deactivate it.

---

PROCEDURE

1. Select **Studio > Studio Setup**.
  2. In the **Devices** list, select the joystick device.  
The available device settings are shown to the right.
  3. Deactivate the respective option.
- 

## Track Quick Controls

If you have an external remote control device, you can set it up to control up to 8 parameters of each audio track, MIDI track or instrument track, using the **Track Quick Controls** feature in Cubase.

RELATED LINKS

[Connecting Track Quick Controls with Remote Controllers](#) on page 574

## VST Quick Controls

If you have an external remote control device, you can control up to 8 parameters of a VST instrument, using the **VST Quick Controls** feature in Cubase.

RELATED LINKS

[VST Quick Controls](#) on page 560

# MIDI Realtime Parameters and MIDI Effects

MIDI realtime means that you can change or transform MIDI events on MIDI or instrument tracks before they are sent to the MIDI outputs. This allows you to change the way MIDI data is played back.

The actual MIDI events on the track are not affected. Therefore, MIDI realtime changes are not reflected in any MIDI editor.

The following functions allow you to change MIDI events in real time:

- MIDI track parameters
- MIDI modifiers
- MIDI effects
- **Transpose** and **Velocity** on the info line

## NOTE

If you want to convert the track settings to real MIDI events, select **MIDI > Freeze MIDI Modifiers** or **MIDI > Merge MIDI in Loop**.

## RELATED LINKS

[Merging MIDI Events into a New Part](#) on page 609

## MIDI Track Parameters

The MIDI track parameters are located in the topmost **Inspector** section for MIDI and instrument tracks.

These settings either affect the basic functionality for the track (mute, solo, enable record, etc.) or send out additional MIDI data to the connected devices (program change, volume, etc.).

The following track parameters allow you to change MIDI events in real time:

- MIDI Volume
- MIDI Pan
- Track Delay
- Input Transformer

## RELATED LINKS

[MIDI Track Inspector](#) on page 115  
[Input Transformer](#) on page 591

## Input Transformer

The **Input Transformer** allows you to filter out and change MIDI data coming to a MIDI track before it is recorded.

Use the **Input Transformer** for the following purposes:

- Set up split keyboard combinations for recording left and right hands separately.
- Convert a controller, such as a foot pedal, into MIDI notes (for playing bass drum the right way).
- Filter out a specific type of MIDI data on one MIDI channel only.
- Turn aftertouch into any controller and vice versa.
- Invert velocity or pitch.

## Input Transformer Window

To open the **Input Transformer** window, do one of the following:

- Select a MIDI or instrument track, click **Input Transformer** , and select **Global**. This allows you to make settings that affect all MIDI inputs and all MIDI tracks.
- Select a MIDI or instrument track, click **Input Transformer**, and select **Local**. This allows you to make settings for the selected track only.

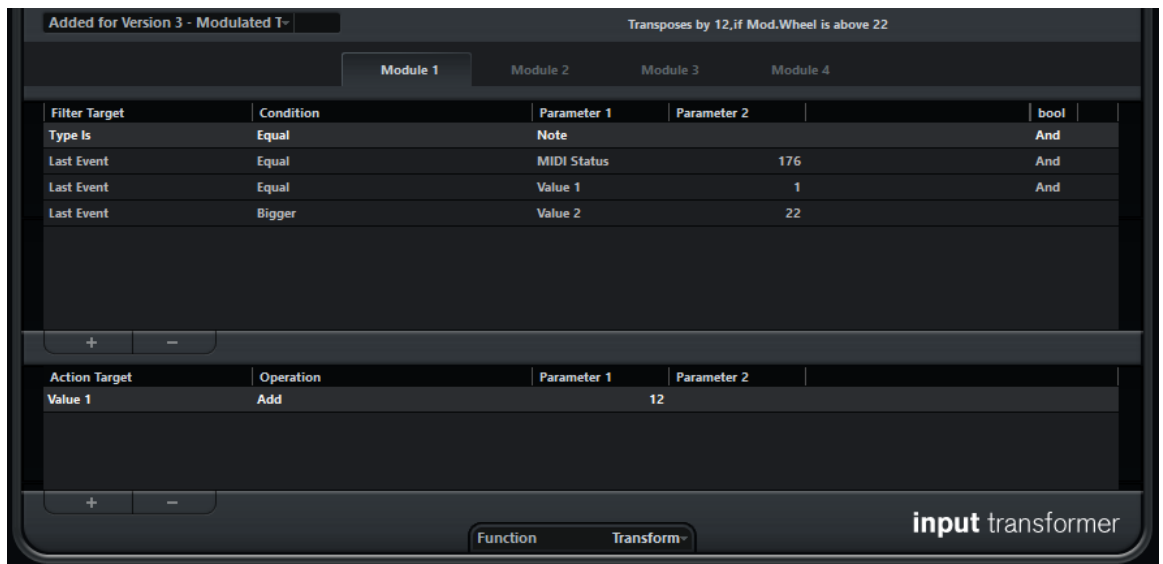

The **Input Transformer** window contains the following parameters:

### Select Preset

Allows you to select a preset for the **Input Transformer**.

### Module selector

Allows you to view and edit a module.

### Filter conditions list

Allows you to set up the filter conditions, determining which elements to find. The list can contain one or several conditions, each on a separate line.

### Action list

Allows you to specify any changes that are made to the found events.

### Function pop-up menu

Allows you to select between **Filter** and **Transform** as a basic type of editing to be performed.



## Specifying Filter Conditions

---

### PROCEDURE

1. Select a MIDI or instrument track.
2. Perform one of the following actions:
  - To make settings that affect all MIDI tracks, open the **Inspector**, click **Input Transformer**, and select **Global** from the pop-up menu.
  - To make settings that affect the selected MIDI track, open the **Inspector**, click **Input Transformer**, and select **Local** from the pop-up menu.
3. Open the **Function** pop-up menu, and perform one of the following actions:
  - Select **Filter** if you want to filter the found events.
  - Select **Transform** if you want to transform the found events.
4. Click **+** to add a line to the filter conditions list.
5. In the filter conditions list, specify the conditions to match by clicking the **Filter Target**, **Condition**, and **Parameter** columns and selecting options from the pop-up menu.
6. In the action list, specify how the found events are transformed or filtered by clicking the **Action Target**, **Operation**, and **Parameter** columns and selecting options from the pop-up menu.

### NOTE

You can also select a preset from the **Select Preset** pop-up menu to specify conditions and actions.

---

### RESULT

The settings affect all MIDI events that you record on the track.

### AFTER COMPLETING THIS TASK

In the **Inspector**, click **Input Transformer**, and select **Off**. Otherwise the **Input Transformer** is still active.

## MIDI Modifiers

MIDI modifiers allow you to modify MIDI events during playback.

You can use them for the following purposes:

- To modify already existing MIDI events on MIDI or instrument tracks.
- To modify MIDI events that you play live.

### NOTE

For live playing, select and record-enable the track, and activate **MIDI Thru Active** in the **Preferences** dialog (**MIDI** page).

---

## MIDI Modifiers Section

- To open the **MIDI Modifiers** section, select a MIDI track, and in the **Inspector**, click **MIDI Modifiers**.



#### NOTE

If you want to compare the result of your modifier settings with the unprocessed MIDI, you can use the bypass button in the MIDI modifiers section. If this button is activated, the MIDI modifiers settings are temporarily disabled.

---



#### Transpose

Allows you to transpose all notes on the track in semitones. Extreme transpositions can give rather strange and unwanted results.

#### Velocity Shift

Allows you to add a velocity value to all notes on the track. Positive values increase the velocity while negative values lower the velocity.

#### Velocity Compression

Allows you to add a multiplier to the velocity of all notes on the track. The value is set with a numerator and a denominator. This parameter also affects the velocity differences between the notes, thus compressing or expanding the velocity scale.

Values smaller than 1/1 compress the velocity range. Values greater than 1/1 together with negative **Velocity Shift** values expand the velocity range.

#### IMPORTANT

The maximum velocity is always 127, no matter how much you try to expand.

---

#### NOTE

Combine this setting with the **Velocity Shift** parameter.

---

#### Length Compression

Allows you to add a multiplier to the length of all notes on the track. The value is set with a numerator and a denominator.

#### Random

Allows you to introduce random variations to various properties of MIDI notes.

#### Range

Allows you to specify a pitch or velocity range and either force all notes to fit within this range, or exclude all notes outside this range from playback.

**HMT: Follow**

Activate this option to apply Hermode tuning to the notes played on this track.

**HMT: Use for Analysis**

Activate this option to use the notes you played on this track to calculate retuning.

## Setting up Random Variations

You can set up random variations for position, pitch, velocity, and length of MIDI events using one or two random generators.

---

PROCEDURE

1. Select a MIDI or instrument track.
2. In the **Inspector**, open the **MIDI Modifiers** section.
3. Open the **Random** pop-up menu and select the note property you want to randomize.
4. Specify the limits of the randomization in the two number fields.  
The values will vary between the minimum and maximum value. You cannot set the **min** value higher than the **max** value.
5. Optional: Repeat for other random values.
6. Play back the track to hear the randomized events.

---

RESULT

The corresponding properties are randomized.

NOTE

Depending on the track content, certain changes might not be immediately noticeable or might have no effect at all.

---

AFTER COMPLETING THIS TASK

Deactivate the random function by opening the **Random** pop-up menu and selecting **OFF**.

## Setting up Ranges

You can filter out pitches or velocities that do not match a specified range, or force them to fit a specified range.

---

PROCEDURE

1. Select a MIDI or instrument track.
2. In the **Inspector**, open the **MIDI Modifiers** section.
3. Open the **Range** pop-up menu and select a mode.
4. Set the minimum and maximum values with the two fields to the right.

NOTE

You can make independent settings for the two **Range** functions.

---

AFTER COMPLETING THIS TASK

To deactivate the function, open the **Range** pop-up menu and select **OFF**.

## Range Modes

On the **Range** pop-up menu, you can select different range modes. Values are shown as numbers, from 0 to 127, for the velocity modes and as note numbers, from C-2 to G8, for the pitch modes.

### Vel. Limit

Allows you to force all velocity values to fit within the range that you specify with the **min** and **max** values. Values below the lower limit are set to the **min** value, velocity values above the higher setting are set to the **max** value.

### Vel. Filter

Allows you to filter out notes with velocity values below the **min** value or above the **max** value.

### Note Limit

Allows you to transpose all notes below the **min** value upwards and all notes above the **max** value downwards in octave steps.

### Note Filter

Allows you to filter out notes that are lower than the **min** value or higher than the **max** value.

## Applying Hermode Tuning

Hermode tuning changes the tuning of notes that you play. It creates clear frequencies for every fifth and third interval, for example. Retuning only affects individual notes and maintains the pitch relationship between keys and notes. The retuning is a continuous process and takes the musical context into account.

---

### PROCEDURE

1. Select a MIDI or instrument track.
2. In the **Inspector**, open the **MIDI Modifiers** section.
3. Activate **HMT: Follow**.
4. Activate **HMT: Use for Analysis** to use the notes you play to calculate retuning.

### NOTE

If you use tracks with acoustic piano, activate **HMT: Use for Analysis** and deactivate **HMT: Follow**. This excludes the piano from being tuned which would sound unnatural.

5. Select **Project > Project Setup** to open the **Project Setup** dialog.
6. Open the **HMT Type** pop-up menu and select one of the options.
7. Play some notes.

It may take a moment until all notes are recalculated and you hear the results of the retuning.

### NOTE

Notes that are produced by MIDI plug-ins are not taken into account.

---

### RESULT

If you use a VST 3 instrument that supports Micro Tuning and Note Expression, notes are retuned dynamically while you play them. For VST instruments that support Note Expression, this also works in **MIDI Thru** mode.

If you use a track that has a VST 2 instrument loaded, the notes you play are retuned on every keystroke.

RELATED LINKS

[Hermodé Tuning](#) on page 597

## Hermodé Tuning

You can select different Hermodé tuning types.

- To select a Hermodé tuning type, select **Project > Project Setup** and select an option from the **HMT Type** pop-up menu.

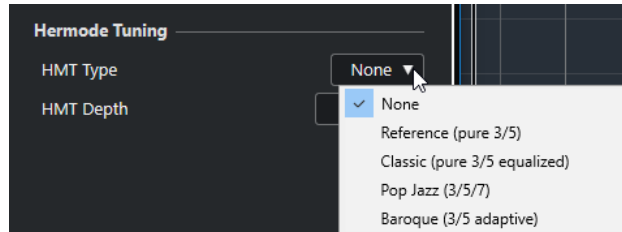

The following options are available:

### None

No tuning is applied.

### Reference (pure 3/5)

Tunes pure thirds and fifths.

### Classic (pure 3/5 equalized)

Tunes pure thirds and fifths. In conflict situations, a slight equalization is applied. This tuning type is suitable for all kinds of music.

### Pop Jazz (3/5/7)

Tunes pure thirds and fifths, and natural sevenths. This tuning type should not be applied to polyphonic music. Try this with pop or jazz.

### Baroque (3/5 adaptive)

Tunes pure thirds and fifths. The degree of purity changes according to the sequence of harmonies. This tuning type is suitable for church organ and polyphonic music.

## Freezing MIDI Modifiers

You can apply all filter settings permanently to the selected track. The settings are applied to the events on the track, and all modifiers are set to zero.

---

### PROCEDURE

1. Select the MIDI track.
2. Select **MIDI > Freeze MIDI Modifiers**.

---

### RESULT

The following settings are frozen:

- Several settings in the top section of the **Inspector**, such as **Delay**, **Program Selector**, and **Bank Selector**.
- The settings in the **MIDI Modifiers** section, such as **Transpose**, **Vel. Shift**, **Vel. Comp.**, and **Len. Comp.**.
- The settings in the **MIDI Inserts** section, such as arpeggiators.
- The info line settings **Transpose** and **Velocity**.

RELATED LINKS

[MIDI Track Inspector](#) on page 115

## MIDI Effects

MIDI effects allow you to transform the MIDI data played back from the track in real time.

You can add new events by using MIDI effects, or change MIDI event properties like pitches, for example.

NOTE

The included MIDI effect plug-ins are described in the separate document **Plug-in Reference**.

---

## MIDI Inserts

MIDI insert effects are inserted in the signal chain of MIDI channels. If you add an insert effect to a MIDI track, the MIDI events on the track are sent to the effect and processed by it. The whole signal passes through the effect.

- To open the **MIDI Inserts** section, select a MIDI track, and in the **Inspector**, click **MIDI Inserts**.

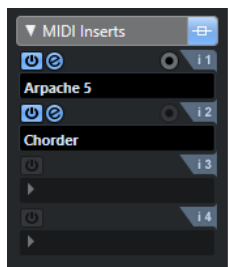

You can add up to four MIDI insert effects. The following parameters are available:

### Bypass

Allows you to bypass all insert effects for the track.

### Activate Insert

Allows you to activate/deactivate the selected effect.

### Open/Close Insert Effect Editor

Allows you to open/close the control panel for the selected effect. Depending on the effect, this may appear in a separate window or below the insert slot in the **Inspector**.

### Select Effect Type

Allows you to select and activate an effect and open its control panel. To remove an effect, select **No Effect**.

### Record Output to Track

Allows you to record the output of the MIDI insert effect on a MIDI or instrument track.

NOTE

To open a separate control panel for effects that display their controls in the **Inspector**, press **Alt** and click **Open/Close Insert Effect Editor**.

---

## Applying a MIDI Insert Effect

You can apply MIDI insert effects to a MIDI track.

---

### PROCEDURE

1. Select the MIDI track.
2. In the **Inspector**, open the **MIDI Inserts** section.
3. Click **Select Effect Type** to open the MIDI effect pop-up menu.
4. Select a MIDI effect from the pop-up menu.

---

### RESULT

The effect is automatically activated and its control panel is opened, allowing you to make settings for the effect. All MIDI from the track is routed through the effect.

### NOTE

The included MIDI effects are described in the separate document **Plug-in Reference**.

---

## Recording a MIDI Insert Effect

You can record the output of a MIDI insert effect, that is, the events are created directly on a MIDI or instrument track.

---

### PROCEDURE

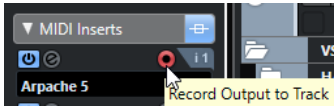
1. In the global track controls area of the track list, click **Add Track** .
2. Click **Instrument**.
3. Open the **Instrument** pop-up menu and select a VST instrument.
4. Click **Add Track**.  
The instrument track is added to the track list, and the control panel of the selected VST instrument is opened.
5. On the instrument track, activate **Record Enable**.
6. In the **Inspector**, open the **MIDI Inserts** section.
7. Click the first insert effect slot and select a MIDI insert effect.
8. Activate **Record Output to Track**.  

9. On the **Transport** panel, activate **Record** and use your MIDI keyboard or the **On-Screen Keyboard** to play some notes.

---

### RESULT

The notes that you play are modified by the MIDI insert effect and recorded directly on the track.

### AFTER COMPLETING THIS TASK

You can edit the recorded MIDI events in the **Key Editor**, for example.

---

## MIDI Sends

If you use a send effect, the MIDI events are sent both to the output of the MIDI track and to the send effect. This way, you get both the unprocessed MIDI events and the output of the MIDI

effect. Note that the effect can send its processed MIDI data to any MIDI output, not necessarily to the one used by the track.

- To open the **MIDI Sends** section, select a MIDI track, and in the **Inspector**, click **MIDI Sends**.

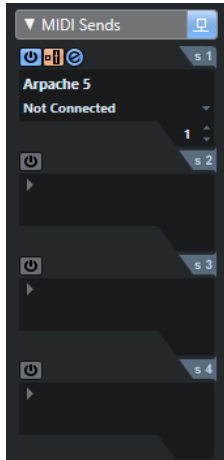

You can add up to four MIDI send effects.

#### **Bypass**

Allows you to bypass all send effects for the track.

#### **Activate Send**

Allows you to activate/deactivate the selected effect.

#### **Pre/Post**

Activate this to send the MIDI signals to the send effects before the MIDI modifiers and insert effects.

#### **Open/Close Send Effect Editor**

Allows you to open/close the control panel for the selected effect. Depending on the effect, this may appear in a separate window or below the sends slot in the **Inspector**.

#### **Select Effect Type**

Allows you to select and activate an effect and open its control panel. To remove an effect, select **No Effect**.

#### **MIDI Send Destination**

Allows you to determine to which MIDI output the processed MIDI events are sent.

#### **MIDI Send Channel**

Allows you to determine on which MIDI channel the processed MIDI events are sent.

#### **NOTE**

To open a separate control panel for effects that display their controls in the **Inspector**, press **Alt** and click **Open/Close Send Effect Editor**.

---



## Presets

Some of the MIDI effects come with a number of presets for instant use.



**1 MIDI In/MIDI Out Activity**

Indicates if the plug-in receives or transmits MIDI data.

**2 Save Preset/Remove Preset**

Allows you to save your settings as a preset or to remove saved presets. Saved presets are available in the **Select Preset** pop-up menu for all instances of that MIDI plug-in, and in all projects.

## Transpose and Velocity on the Info Line

You can edit the transposition and the velocity for selected MIDI parts on the info line. This only affects the notes in playback.

- Use the **Transpose** field to transpose the selected parts in semitone steps. The value is added to the transposition set for the whole track.
- Use the **Velocity** field to offset the velocity for the selected parts. The value is added to the velocities of the notes in the parts.

RELATED LINKS

[Transpose Functions](#) on page 292

# Using MIDI Devices

The **MIDI Device Manager** allows you to work with MIDI devices, that is, representations of external MIDI hardware.

You can install preset MIDI devices or define new ones. This is useful for global control and patch selection.

## Program Change Messages and Bank Select Messages

To select a patch, that is, a sound in your MIDI device you must send a program change message to that device.

### Program Change Messages

You can record program change messages, or enter them in a MIDI part. You can open the **Inspector** for the MIDI track and select a value in the **Program Selector** field.

Program change messages allow you to select between 128 different patches in your MIDI device.

### Bank Select Messages

Many MIDI instruments, however, contain a larger number of patch locations. To make these available from within Cubase, you must send bank select messages.

Bank select messages allow you to select between 128 different programs in your MIDI device.

If your device supports MIDI bank select, you can open the **Inspector** for the MIDI track and select a value in the **Bank Selector** field to select a bank, and then use the **Program Selector** field to select a program in this bank.

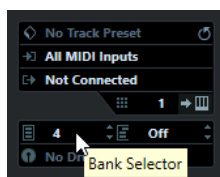

Unfortunately, different instrument manufacturers use different schemes for how bank select messages are constructed, which can lead to some confusion and make it hard to select the correct sound. Also, selecting patches by numbers seems unnecessarily cumbersome, when most instruments use names for their patches nowadays.

The **MIDI Device Manager** allows you to specify which MIDI devices you are using, and to select to which device each MIDI track is routed. This allows you to select patches by name in the track list or **Inspector**.

#### RELATED LINKS

[MIDI Device Manager](#) on page 603

## Patch Banks

The **Patch Banks** list can have two or more main banks, depending on the selected device.

This is due to the fact that different types of patches are handled differently in the instruments. Patches, for example, typically are regular programs that you play one at a time. Performances, however, may be combinations of programs, which could be split across the keyboard, layered, or used for multitimbral playback, and so on.

For devices with several banks you can select **Bank Assignment** to specify which bank a specific MIDI channel should use.

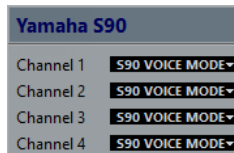

The **Bank Assignment** affects which bank is displayed when you select programs by name for the device in the track list or **Inspector**.

Many instruments use MIDI channel 10 as an exclusive drum channel, for example. If this is the case, select the **Drums** or **Rhythm Set** or **Percussion** bank for channel 10 in this list. This allows you to choose between different drum kits in the track list or **Inspector**.

## MIDI Device Manager

The **MIDI Device Manager** allows you to install preset MIDI devices or define new ones.

- To open the **MIDI Device Manager**, select **Studio > More Options > MIDI Device Manager**.

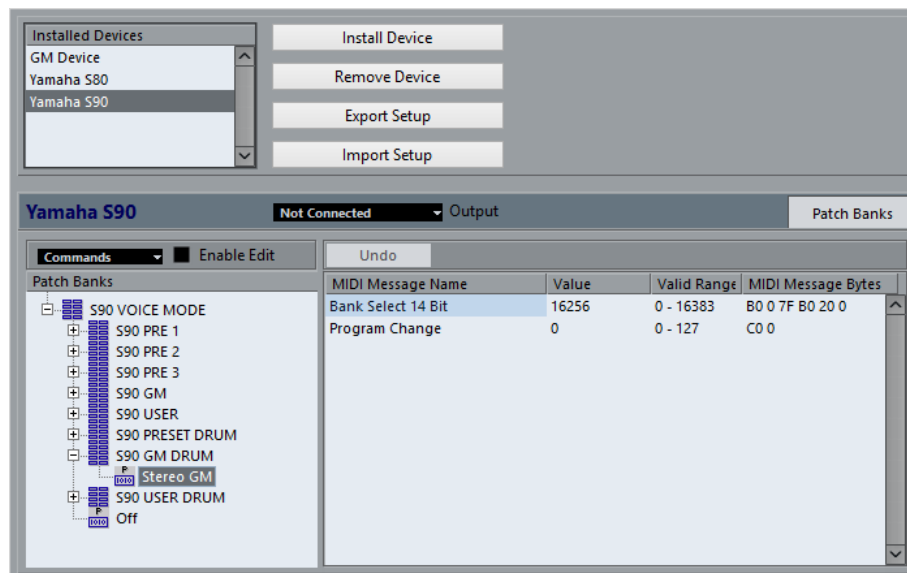

### Installed Devices list

Lists the connected MIDI devices and the imported device setups.

### Install Device

Allows you to install a preset device. These presets are simple patch name scripts that do not include any device mapping of parameters and controls and no graphic panels.

For more information about patch name scripts, see the separate document **MIDI Devices**.

### Remove Device

Removes the selected device.

### Export Setup

Exports the MIDI device setup as XML file.

### Import Setup

Allows you to import an XML file of a MIDI device setup. Device setups can include device mapping, and/or patch information. Device setups are also added to the list of installed devices when imported.

### Output

Allows you to select a MIDI output for the selected device.

### Enable Edit

Activate this to enable the editing of the selected device.

### Commands

Allows you to edit the selected device. The patch structure for the selected device is shown to the left.

### MIDI Messages

Shows which MIDI messages are sent out to select the patch that is highlighted in the list to the left.

## Commands for Patches

In the **MIDI Device Manager**, patches can be structured in banks, folders, and presets.

### NOTE

Activate **Enable Edit** to use the **Commands** pop-up menu for the selected device.

The **Commands** pop-up menu contains the following items:

### Create Bank

Creates a new bank in the **Patch Banks** list. You can rename this by clicking on it and typing a new name.

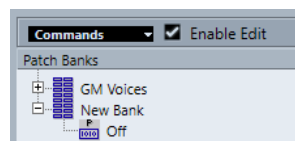

If you specify more than one bank, a **Bank Assignment** button is added next to the **Patch Banks** button.

### New Folder

Creates a new subfolder in the selected bank or folder. This could correspond to a group of patches in the MIDI device, or just be a way for you to categorize sounds.

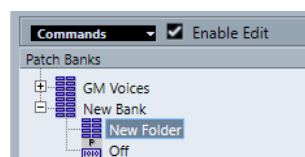

## New Preset

Adds a new preset in the selected bank or folder. If you select it, the corresponding MIDI events are shown to the right. The default program change value for a new preset is 0, but you can adjust the number in the **Value** column.

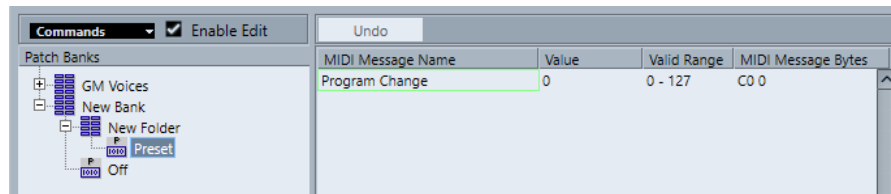

You can move presets between banks and folders via drag and drop.

## Add Multiple Presets

Allows you to set up a range of presets and add them to the selected bank or folder.

### NOTE

You can remove banks, folders, and presets by selecting them and pressing **Backspace**.

### IMPORTANT

For details on which MIDI events are used for selecting patches in the MIDI device, consult its documentation.

### RELATED LINKS

[Add Preset Functions](#) on page 605

[Patch Banks](#) on page 603

## Add Preset Functions

If you add or select a preset for the selected bank or folder, further functions become available to the right. If you add multiple presets, the **Add Multiple Presets** dialog opens with further functions.

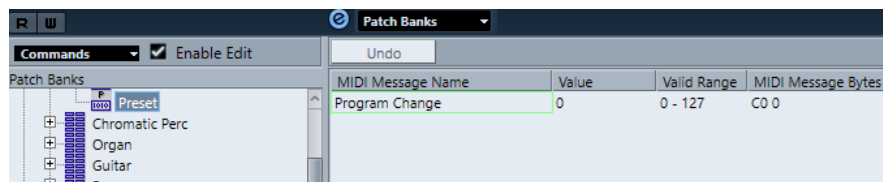

The following columns are available:

### MIDI Message Name

The name of the MIDI message.

- To change an event, click it, and select another option from the pop-up menu.
- To add another event, click below the last event, and select an option from the pop-up menu.
- To remove an event, select it and press **Delete** or **Backspace**.

### IMPORTANT

If you insert a **Bank Select** event, keep in mind that, depending on your device, you must choose **CC: BankSelect MSB**, **Bank Select 14 Bit**, **Bank Select 14 Bit MSB-LSB Swapped** or some other option.

**Value**

The value of the event.

**MIDI Message Bytes**

The message bytes of the event.

**Valid Range**

The valid range of the event.

**Default Name**

For multiple presets you can specify a default name. The added events will get this name, followed by a number.

## Installing Preset MIDI Devices

You can install preset MIDI devices, that is, patch name scripts that do not include device mapping.

---

PROCEDURE

1. Select **Studio > More Options > MIDI Device Manager**.
2. Click **Install Device**.
3. In the **Add MIDI Device** dialog, do one of the following:
  - Select the script of the device in the list.
  - Select **GM Device** or **XG Device** if your device is not listed, but compatible with these standards, and type in the name of your instrument in the next dialog.
4. Click **OK**.
5. Select the device in the **Installed Devices** list, and open the **Output** pop-up menu.
6. Select the MIDI output that the device is connected to.

---

RESULT

The structure of the patch name script is shown. It usually has one or several layers of banks or groups with patches.

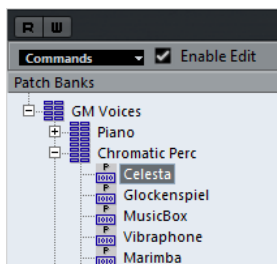

## Selecting Patches for Installed Devices

If you installed a device and you select it from the **Output Routing** pop-up menu for the MIDI track, you can select patches by name.

---

PROCEDURE

1. Select the MIDI track that you want to associate to the installed device, and open the top section of the **Inspector**.
2. Open the **Output Routing** pop-up menu, and select the installed device.  
This routes the MIDI track to the MIDI output specified for the device in the **MIDI Device Manager**. The **Bank Selector** and the **Program Selector** fields are replaced by a single **Program Selector** field that reads **Off**.

3. Open the **Program Selector**.

A program list, similar to the one in the **MIDI Device Manager**, is shown.

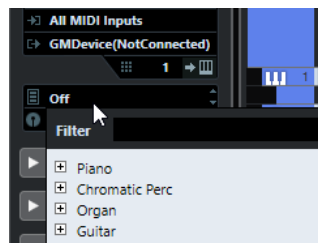

4. Select an entry in the list.
- 

#### RESULT

The corresponding MIDI message is sent to the device.

## Renaming Patches in Devices

If you have replaced some of the factory presets with your own patches, you can modify the device so that the patch name list matches the actual device.

---

#### PROCEDURE

1. Select **Studio > More Options > MIDI Device Manager**.
  2. Select the device in the **Installed Devices** list.  
Make sure that the **Patch Banks** tab is selected.
  3. Activate **Enable Edit**.
  4. In the **Patch Banks** list, locate the patch you want to rename and click the name.
  5. Type in the new name and press **Return**.
- 

#### RESULT

The patch is renamed.

#### AFTER COMPLETING THIS TASK

To avoid modifying the device by accident, deactivate **Enable Edit**.

## Defining New MIDI Devices

You can define new MIDI devices.

---

#### PROCEDURE

1. Select **Studio > More Options > MIDI Device Manager**.
  2. Click **Install Device**.
  3. In the **Add MIDI Device** dialog, select **Define New**.
  4. Click **OK**.
  5. In the **Create New MIDI Device** dialog, enter the name of the device and activate the MIDI channels that you would like to use.
  6. Click **OK**.
  7. Select the device in the **Installed Devices** list.
  8. Activate **Enable Edit** and use the **Commands** pop-up menu to organize the patch structure of the new device.
-

# MIDI Functions

MIDI functions allow you to permanently edit MIDI events or MIDI parts in the **Project** window or from within a MIDI editor.

Which events are affected when you use a MIDI function depends on the function, the active window, and the current selection:

- In the **Project** window, the MIDI functions apply to all selected parts, affecting all events of the relevant types in them.
- In the MIDI editors, MIDI functions apply to all selected events. If no events are selected, all events in the edited parts are affected.

## NOTE

Some MIDI functions only apply to MIDI events of a certain type. For example, **Delete Controllers** only applies to MIDI controller events.

## RELATED LINKS

[MIDI Realtime Parameters and MIDI Effects](#) on page 591

## Transpose Setup Dialog

The **Transpose Setup** dialog contains settings for transposing the selected events.

- To open the **Transpose Setup** dialog, select the MIDI notes that you want to transpose, and select **MIDI > Transpose Setup**.

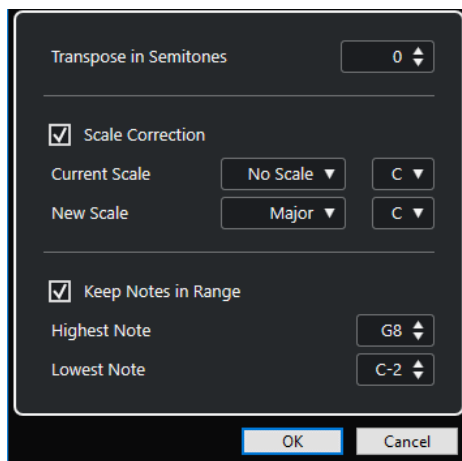

The following settings are available:

### Transpose in Semitones

Sets the amount of transposition.



### Scale Correction

Transposes the selected notes to the closest note of a specific scale type. This allows you to change the key and the tonality.

- Select a root note and a scale type for the current scale in the **Current Scale** pop-up menu.
- Select a root note and a scale type for the new scale in the **New Scale** pop-up menu.

#### NOTE

If the new root note differs from the current root note, this leads to an entirely different key.

---

### Keep Notes in Range

Limits the transposition of notes to the note values that you specify with the **Highest Note** and **Lowest Note** settings.

#### NOTE

Notes that would be outside the range after transposition are shifted to another octave, keeping the correct transposed pitch if possible. If the range between the upper and lower limit is very narrow, the note is transposed as far as possible, that is, to notes specified with the **Highest Note** and **Lowest Note** values. If you set **Highest Note** and **Lowest Note** to the same value, all notes are transposed to this pitch.

---

#### NOTE

You can also use the transpose track for transposing.

---

## Merging MIDI Events into a New Part

You can merge all MIDI events, apply MIDI modifiers and effects, and generate a new part.

---

### PROCEDURE

1. Do one of the following:
  - Mute the tracks or parts that you do not want to include in the merge.
  - Solo the track that contains the events that you want to include in the merge.
2. Set up the left and right locators to encompass the area that you want to merge.

#### NOTE

Only events starting within this area will be included.

---

3. Optional: Select a track for the new part.  
If you do not select a track, a new MIDI track is created. If several MIDI tracks are selected, the new part is inserted on the first selected track.
  4. Select **MIDI > Merge MIDI in Loop**.
  5. In the **MIDI Merge Options** dialog, make your changes.
  6. Click **OK**.
-

#### RESULT

A new part is created between the locators on the destination track, containing the processed MIDI events.

#### RELATED LINKS

[MIDI Merge Options Dialog](#) on page 610

[Freezing MIDI Modifiers](#) on page 597

## MIDI Merge Options Dialog

- To open the **MIDI Merge Options** dialog, select a MIDI part, and select **MIDI > Merge MIDI in Loop**.

The following options are available:

#### **Include Inserts**

Applies MIDI insert effects and MIDI modifiers.

#### **Include Sends**

Applies MIDI send effects.

#### **Erase Destination**

Deletes MIDI data between the left and right locators on the destination track.

#### **Include Chase**

Includes events placed outside the selected part but relating to it in the processing, for example, a program change right before the left locator.

#### **Convert VST 3**

Converts all VST 3 data within the selected area to MIDI data.

#### RELATED LINKS

[Chase](#) on page 226

## Applying Effects to a Single Part

You can apply MIDI modifiers and effects to a single part.

---

#### PROCEDURE

1. Set up your MIDI modifiers and MIDI effects the way you want them for the part.
2. Set the locators to encompass the part.
3. In the track list, select the track with the part.
4. Select **MIDI > Merge MIDI in Loop**.
5. In the **MIDI Merge Options** dialog, activate **Erase Destination**.
6. Click **OK**.

---

#### RESULT

A new part is created on the same track, containing the processed events. The original part is deleted.

#### AFTER COMPLETING THIS TASK

Turn off or reset all MIDI modifiers and effects, so that the track plays back as before.

## Dissolve Part Dialog

You can separate MIDI events in a part according to channels or pitches and dissolve the part to different tracks or lanes.

- To open the **Dissolve Part** dialog, select the MIDI part you want to dissolve and select **MIDI > Dissolve Part**.

The following settings are available:

### Separate Channels

Separates MIDI events according to their channel. This is useful for MIDI parts on MIDI channel **Any** that contain events on different MIDI channels.

### Separate Pitches

Separates MIDI events according to their pitch. This is useful for drum and percussion tracks, where different pitches usually correspond to separate drum sounds.

### Optimized Display

Automatically removes silent areas of the resulting parts.

#### NOTE

This option is not available when **Dissolve to Lanes** is activated.

---

### Dissolve to Lanes

Dissolves the part to lanes.

## Dissolving Parts into Separate Channels

You can dissolve MIDI parts that contain events on different MIDI channels, and distribute the events into new parts on new tracks, one for each MIDI channel found.

---

### PROCEDURE

1. Select the parts that contain MIDI events on different channels.
  2. Select **MIDI > Dissolve Part**.
  3. Activate **Separate Channels**.
  4. Click **OK**.
- 

### RESULT

For each MIDI channel used in the selected parts, a new MIDI track is created and set to the corresponding MIDI channel. Each event is copied into the part on the track with the corresponding MIDI channel, and the original parts are muted.

## MIDI Channel Setting

Setting a track to MIDI channel **Any** causes each MIDI event to play back on its original MIDI channel, rather than a channel set for the whole track.

There are two main situations when **Any** channel tracks are useful:

- When you record several MIDI channels at the same time.  
You may for example have a MIDI keyboard with several keyboard zones, where each zone sends MIDI on a separate channel. Setting the channel to **Any** allows you to play back the recording with different sounds for each zone (since the different MIDI notes play back on separate MIDI channels).

- When you have imported a MIDI file of Type 0.  
MIDI files of Type 0 contain only one track, with notes on up to 16 different MIDI channels. If you were to set this track to a specific MIDI channel, all notes in the MIDI file would be played back with the same sound. Setting the track to **Any** causes the imported file to play back as intended.

## Dissolving Parts into Separate Pitches

You can dissolve MIDI parts that contain events of different pitches and distribute the events into new parts on new tracks, one for each MIDI pitch found. This is useful if the different pitches are used for separating different sounds such as MIDI drum tracks or sampler sound FX tracks. By dissolving such parts, you can work with each sound individually, on a separate track.

---

### PROCEDURE

1. Select the parts that contain MIDI events of different pitches.
2. Select **MIDI > Dissolve Part**.
3. Activate **Separate Pitches**.
4. Click **OK**.

---

### RESULT

For each MIDI pitch used in the selected parts, a new MIDI track is created. Each event is copied into the part on the track for the corresponding pitch, and the original parts are muted.

## Repeating MIDI Events of Independent Track Loops

You can repeat the MIDI events inside an independent track loop to fill up a MIDI part. This is useful if you want to convert the events of an independent track loop to actual MIDI events.

### PREREQUISITE

You have set up an independent track loop and the **Key Editor** is open. The part ends after the end of the independent track loop.

---

### PROCEDURE

- Select **MIDI > Repeat Loop**.

---

### RESULT

The events of the independent track loop are repeated to the end of the part. Events that are located to the right of the independent track loop in the part are replaced.

### RELATED LINKS

[Setting up the Independent Track Loop](#) on page 460

## Extending MIDI Notes

You can extend MIDI notes so that they reach the next notes.

### PREREQUISITE

A MIDI part with some note events is open in the **Key Editor**.

---

### PROCEDURE

1. Select the note events that you want to extend to the next notes.

2. Select **MIDI > Functions > Legato**.
- 

RESULT

The selected note events are extended to the start of the next notes.

NOTE

To specify a gap or overlap for this, adjust the **Legato Overlap** setting in the **Preferences** dialog (**Editing—MIDI** page).

---

RELATED LINKS

[Key Editor Inspector](#) on page 647

## Fixing MIDI Note Lengths

You can set the length of selected MIDI notes to the **Length Quantize** value.

PREREQUISITE

A MIDI part with some note events is open in the **Key Editor**.

---

PROCEDURE

1. In the **Key Editor** toolbar, open the **Length Quantize** pop-up menu and select the desired note length.
  2. Select the note events that you want to fix.
  3. Select **MIDI > Functions > Fixed Lengths**.
- 

RESULT

The selected note events are set to the specified **Length Quantize** value.

RELATED LINKS

[Key Editor Toolbar](#) on page 640

## Fixing MIDI Note Velocities

You can set the velocity of selected MIDI notes to the **Note Insert Velocity** value.

PREREQUISITE

A MIDI part with some note events is open in the **Key Editor**.

---

PROCEDURE

1. In the **Key Editor** toolbar, open the **Set up Insert Velocities** pop-up menu and select a velocity value.
  2. Select the note events that you want to fix.
  3. Select **MIDI > Functions > Fixed Velocity**.
- 

RESULT

The selected note events are set to the specified **Note Insert Velocity** value.

RELATED LINKS

[Key Editor Toolbar](#) on page 640

## Rendering Sustain Pedal Data to Note Lengths

You can render sustain pedal data to note lengths. This is useful if you recorded MIDI data with a MIDI keyboard and a sustain pedal, and you want to extend the actual MIDI notes for as long as you held the pedal, in order to edit the notes later.

### PREREQUISITE

You recorded MIDI using a MIDI keyboard and a sustain pedal. The MIDI part is open in the **Key Editor**.

---

### PROCEDURE

1. Select the note events.
  2. Select **MIDI > Functions > Pedals to Note Length**.
- 

### RESULT

The selected notes are lengthened to match the sustain pedal off position, and the sustain controller on/off events are removed.

## Deleting Overlaps

You can delete overlaps of notes that have the same or different pitches. This is useful if your MIDI instruments cannot handle overlapping events.

---

### PROCEDURE

1. Select the note events.
  2. Do one of the following:
    - Select **MIDI > Functions > Delete Overlaps (mono)**.
    - Select **MIDI > Functions > Delete Overlaps (poly)**.
- 

### RESULT

The overlapping MIDI notes are shortened, so that no note begins before another ends.

## Editing Velocity

You can manipulate the velocity of notes.

---

### PROCEDURE

1. Select the note events.
  2. Select **MIDI > Functions > Velocity**.
  3. Open the **Type** pop-up menu and select an option.
  4. Depending on the **Type**, enter a **Ratio**, an **Amount** or an **Upper** and **Lower** value.
  5. Click **OK**.
- 

### RESULT

The note velocities are changed according to your settings.

### RELATED LINKS

[Velocity Dialog](#) on page 615

## Velocity Dialog

- To open the **Velocity** dialog, select a MIDI part, and select **MIDI > Functions > Velocity**.

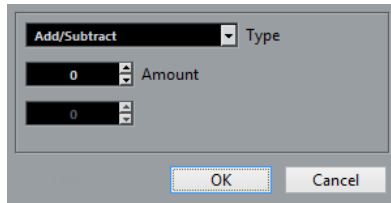

### Add/Subtract

Adds the **Amount** value to the velocity value. You can enter positive or negative values.

### Compress/Expand

Uses the **Ratio** setting (0 to 300 %) to compress or expand the dynamic range of MIDI notes. A factor higher than 1 (over 100 %) expands the differences between velocity values, while using a factor lower than 1 (under 100 %) compresses them.

- To compress the dynamic range, use ratio values below 100 %.  
After compression, you can add a velocity amount to maintain the average velocity level.
- To expand the dynamic range, use ratio values above 100 %.  
Before expansion, you can adjust the velocity to the middle of the range.

### Limit

Limits the velocity values so that they stay between the **Lower** and the **Upper** values.

## Deleting Double Notes

You can delete double notes of the same pitch on the exact same position from selected MIDI parts. Double notes can occur when recording in cycle mode, after quantizing, for example.

---

### PROCEDURE

1. Select the MIDI part that contains the double notes.
  2. Select **MIDI > Functions > Delete Doubles**.
- 

### RESULT

The double notes are automatically deleted.

## Deleting Controller Data

You can delete controller data from selected MIDI parts.

---

### PROCEDURE

1. Select the MIDI parts that contain the controller data.
  2. Select **MIDI > Functions > Delete Controllers**.
- 

### RESULT

The controller data is automatically deleted.

## Deleting Continuous Controller Data

You can delete continuous controller data from selected MIDI parts.

---

### PROCEDURE

1. Select the MIDI parts that contain the controller data.
2. Select **MIDI > Functions > Delete Continuous Controllers**.

---

### RESULT

The continuous controller data is automatically deleted. However, On/Off events, such as sustain pedal events, are kept.

## Restricting Polyphonic Voices

You can restrict polyphonic voices in selected MIDI notes or parts. This is useful if you have an instrument with limited polyphony and want to make sure all notes are played.

---

### PROCEDURE

1. Select the MIDI notes or parts that contain the voices.
2. Select **MIDI > Functions > Restrict Polyphony**.
3. Specify how many voices you want to use.
4. Click **OK**.

---

### RESULT

The notes are shortened as required, so that they end before the next note starts.

## Thinning Out Controller Data

You can thin out controller data in selected MIDI parts. Use this to ease the load on your external MIDI devices if you have recorded very dense controller curves.

---

### PROCEDURE

1. Select the MIDI parts that contain the controllers that you want to thin out.
2. Select **MIDI > Functions > Thin Out Data**.

---

### RESULT

The controller data is thinned out.

## Extracting MIDI Automation

You can convert continuous controllers of your recorded MIDI parts into MIDI track automation data, so that you can edit them in the **Project** window.

---

### PROCEDURE

1. Select the MIDI part that contains the continuous controller data.
  2. Select **MIDI > Functions > Extract MIDI Automation**.
-



#### RESULT

In the **Project** window, an automation track is created for each of the continuous controllers in the MIDI part.

In the MIDI editors, the controller data is removed from the controller lane.

#### NOTE

This only works for continuous controllers. Data such as Aftertouch, Pitchbend, or SysEx cannot be converted to MIDI track automation data.

MIDI controller automation is also affected by the Automation Merge Mode.

---

#### RELATED LINKS

[MIDI Controller Automation](#) on page 544

## Reversing the Playback Order of MIDI Events

You can invert the order of the selected events or of all events in selected part rhythmically. This causes the MIDI to play backwards. However, this is different from reversing an audio recording. The individual MIDI notes still play as usual, but the playback order changes.

---

#### PROCEDURE

1. Select the MIDI events or the MIDI part.
  2. Select **MIDI > Functions > Reverse**.
- 

#### RESULT

The playback order of the events is reversed while the individual notes still play as usual in the MIDI instrument. Technically, this function reverses the Note On message of a note within a part or selection.

## Inverting the Order of Selected MIDI Events

This function inverts the order of the selected events, or of all events in the selected parts, graphically. Technically, this function turns a Note On message into a Note Off message and vice versa, which can lead to rhythmic inaccuracies if the Note Off position of a note has not been quantized.

---

#### PROCEDURE

1. Select the MIDI events or the MIDI part.
  2. Select **MIDI > Functions > Mirror**.
- 

#### RESULT

The order of the events is inverted while the individual notes still play as usual in the MIDI instrument. Technically, this function turns a Note On message into a Note Off message and vice versa which can lead to rhythmic inaccuracies if the Note Off position of a note has not been quantized.

# MIDI Editors

There are several ways to edit MIDI in Cubase. You can use the tools and functions in the **Project** window for large-scale editing or the functions on the **MIDI** menu to process MIDI parts in various ways. To manually edit your MIDI data on a graphical interface, you can use the MIDI editors.

- The **Key Editor** presents notes graphically in a piano roll-style grid. The **Key Editor** also allows for detailed editing of non-note events such as MIDI controllers.
- The **Score Editor** shows MIDI notes as a musical score and offers basic score editing and printing.
- The **Drum Editor** is similar to the **Key Editor**, but each key corresponds to a separate drum sound.  
You can use the **Drum Editor** to edit drum or percussion parts.
- The **List Editor** shows all events in the selected MIDI parts as a list and allows you to view and edit their properties numerically. It also allows you to edit SysEx messages.
- The **In-Place Editor** allows you to edit MIDI parts directly in the **Project** window so that you can edit MIDI in context with other track types.

## RELATED LINKS

[Key Editor](#) on page 638

[Drum Editor](#) on page 670

[List Editor](#) on page 689

[Score Editor](#) on page 656

[In-Place Editor](#) on page 703

## Common MIDI Editor Functions

You can use the tools and functions within the MIDI editors to process MIDI parts in various ways.

### Changing the Ruler Display Format

You can change the display format for the ruler. By default, the ruler shows the timeline in the display format that is selected on the **Transport** panel.

---

#### PROCEDURE

- Click the arrow button to the right of the ruler and select an option from the pop-up menu.
- 

## RELATED LINKS

[Ruler Display Format Menu](#) on page 42

## Zooming in MIDI Editors

The MIDI editors provide several zooming options:

- The zoom sliders.

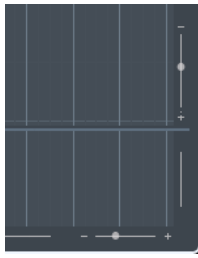

- The **Zoom** tool.
- The **Zoom** submenu in the **Edit** menu.

When you use the **Zoom** tool for zooming, you can determine if you want to zoom horizontal only or horizontal and vertical at a time.

- To activate/deactivate the corresponding option, activate/deactivate **Zoom Tool Standard Mode: Horizontal Zooming Only** in the **Preferences** dialog (**Editing—Tools** page).

## Using Cut and Paste

You can use the **Cut**, **Copy**, and **Paste** options from the **Edit** menu to move or copy material within a part or between different parts.

- To insert note events at the project cursor position without affecting existing notes, select **Edit > Paste**.
- To insert note events at the project cursor position, move, and if necessary split the existing notes to make room for the pasted notes, select **Edit > Range > Paste Time**.

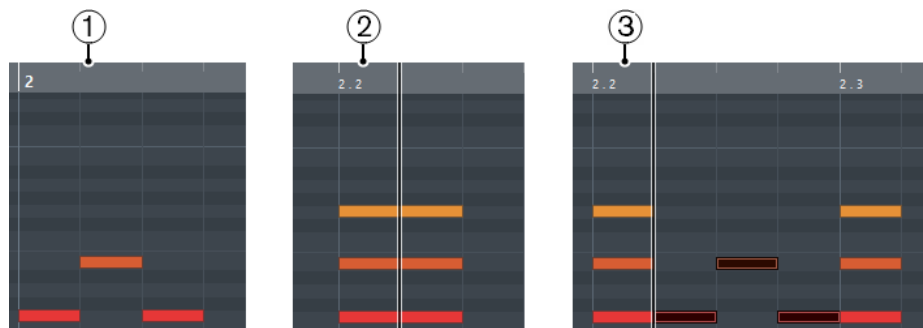

- 1 Data on clipboard
- 2 Cursor position
- 3 Pasted data at cursor position

## Handling Note Events

### Event Colors Menu

You can select different color schemes for the note events in the MIDI editor.

- To open the **Event Colors** pop-up menu, click **Event Colors** on the toolbar.

The following options are available:

### Velocity

The note events get different colors depending on their velocity values.

### Pitch

The note events get different colors depending on their pitch.

### Channel

The note events get different colors depending on their MIDI channel value.

### Part

The note events get the same color as their corresponding part in the **Project** window. Use this option if you are working with 2 or more tracks in an editor, to see which note events belong to which track.

### Grid Match

The note events get different colors depending on their time position. For example, this mode enables you to see if the notes of a chord start at the exact same beat.

### Voice

The note events get different colors depending on their voice (soprano, alto, tenor, etc.).

### Chord Track

The note events get different colors depending on whether they match the current chord, scale, or both.

For all of the options except **Part**, the pop-up menu also contains a **Setup** option. This option opens a dialog in which you can specify the colors that are associated with velocities, pitches, or channels.

## Selecting Note Events

The selected MIDI editor determines which of the following methods apply.

Do one of the following:

- Use the **Object Selection** tool to drag a selection rectangle around the note events that you want to select. You can also click individual events.
- Select **Edit > Select** and select one of the options.
- To select the previous or next note event, use the **Left Arrow/Right Arrow** key.
- To select several notes, press **Shift** and use the **Left Arrow/Right Arrow** key.
- To select all notes of a certain pitch, press **Ctrl/Cmd** and click on a key in the keyboard display to the left.
- To select all the following note events of the same pitch/staff, press **Shift** and double-click a note event.

### RELATED LINKS

[Select Submenu for Note Events](#) on page 620

[Editing](#) on page 888

## Select Submenu for Note Events

The **Select** submenu offers you several options to select note events.

- To open the **Select** submenu for a note event, select the note event, and select **Edit > Select**.

### All

Selects all note events in the edited part.

### **None**

Deselects all note events.

### **Invert**

Inverts the selection. All selected note events are deselected and all notes that were not selected are selected instead.

### **In Loop**

Selects all note events that are partially or completely inside the boundaries of the left and right locators (only visible if locators are set).

### **From Start to Cursor**

Selects all note events that begin to the left of the project cursor.

### **From Cursor to End**

Selects all note events that end to the right of the project cursor.

### **Equal Pitch - all Octaves**

Selects all note events of the highlighted part that have the same pitch (in any octave) as the selected note event.

NOTE

This function requires that a single note event is selected.

---

### **Equal Pitch - same Octave**

Selects all note events of the highlighted part that have the same pitch (same octave) as the selected note event.

NOTE

This function requires that a single note event is selected.

---

### **Select Controllers in Note Range**

Selects the MIDI controller data within the range of the selected note events.

#### RELATED LINKS

[Deleting Note Events](#) on page 622

## **Muting Note Events**

You can mute individual note events in a MIDI editor. Muting individual notes allows you to exclude note events from playback.

Do one of the following:

- Click on a note event with the **Mute** tool.
- Drag a rectangle with the **Mute** tool, enclosing all note events that you want to mute.
- Select the note events and select **Edit > Mute**.
- To unmute a note event, click it or enclose it with the **Mute** tool. You can also select a note event and select **Edit > Unmute**.

Muted notes are dimmed in the note display.

## **Toggle Selections**

- To toggle selected elements within a selection rectangle, press **Ctrl/Cmd** and enclose the same elements within a new selection rectangle.

Once you release the mouse button, the previous selection is deselected and vice versa.

## Deleting Note Events

- To delete note events, click on them with the **Erase** tool or select them and press **Backspace**.

## Delete Notes Dialog

The **Delete Notes** dialog allows you delete note events that do not match a specific length or velocity.

- To open the **Delete Notes** dialog, select a MIDI part in the **Project** window, and select **MIDI > Functions > Delete Notes**.

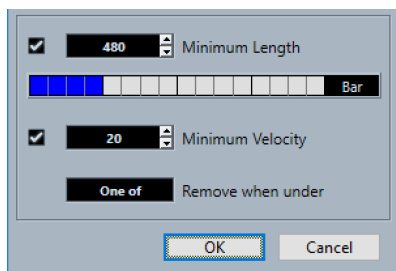

The following options are available:

### Minimum Length

Allows you to set a minimum note length in ticks. Notes that are shorter than the set value are deleted. You can use the value field or the graphical length display. If you click the field to the right of the graphical length display the scale for the display changes. You can set it to 1/4 bar, one bar, two bars or four bars.

### Minimum Velocity

Allows you to set a minimum note velocity. Notes with a lower velocity than the set value are deleted.

### Remove when under

This option is only available if **Minimum Velocity** and **Minimum Length** are both activated. It allows you to select if both or just one of the criteria must be met for notes to be deleted.

## Trimming Note Events

The **Trim** tool allows you to cut off the end or the beginning of note events.

---

### PROCEDURE

1. Select the **Trim** tool on the toolbar.
  2. Do one of the following:
    - To trim the end of a single note event, click on the note event.
    - To trim the beginning of a single note event, press **Alt** and click the note event.
    - To trim several note events, click and drag across the note events.
    - To set the same start and end time for all edited note events, press **Ctrl/Cmd** and vertically drag along the note events.
-

## Editing Note Events on the Info Line

You can move, resize, or change the velocity of note events on the info line using regular value editing.

- To apply a value change to all selected note events, press **Ctrl/Cmd** and change a value on the info line.
- To adjust the pitch or velocity of note events via your MIDI keyboard, click in the **Pitch** or **Velocity** fields on the info line, and play a note on your MIDI keyboard.  
If you have several note events selected and change a value, all selected events are changed by the set amount.

## Duplicating and Repeating Note Events

You can duplicate and repeat note events in the same way as events in the **Project** window.

- To duplicate the selected note events, hold down **Alt** and drag the note events to a new position.  
If **Snap** is activated, it determines to which positions you can copy notes.
- To copy the selected note events and place them directly behind the original, select **Edit > Functions > Duplicate**.  
If several note events are selected, all of them are copied as one unit, maintaining the relative distance between the note events.
- To create a number of copies of the selected note events, select **Edit > Functions > Repeat**, specify the number, and click **OK**.  
You can also press **Alt** and drag the right edge of the note events to the right to create copies of the note events.



## Finding Exact Positions with Snap

The **Snap** function restricts horizontal movement and positioning to certain positions. This helps you find exact positions in the note display when editing note events in a MIDI editor. Affected operations include moving, duplicating, drawing, sizing, etc.

- To activate/deactivate snap, click **Snap**.  
If you select the **Bars+Beats** display format, the snap grid is set by the quantize value on the toolbar. This makes it possible to snap to straight note values and to swing grids that have been set up in the **Quantize Panel**.
- If you select any of the other display formats, positioning is restricted to the displayed grid.

## Setting Velocity Values

When you draw note events in the MIDI editor, the note events get the velocity value that is set in the **Note Insert Velocity** field on the toolbar. There are different methods to set the velocity.

- Use the **Edit Velocity** tool modifier. The cursor changes into a speaker, and next to the note, a field with the Note Velocity slider shows the value. Move the mouse pointer up or down to change the value.

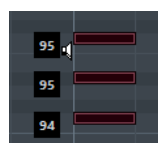

Value changes are applied to all selected notes.

For this, a tool modifier must be assigned for the **Edit Velocity** action. You can edit the tool modifier in the **Preferences** dialog (**Tool Modifiers** page).

- Open the **Note Insert Velocity** pop-up menu and select a velocity value.  
On this menu, you can also select **Setup** and specify custom velocity values for the pop-up menu.
- Double-click the **Note Insert Velocity** field on the toolbar and enter a velocity value.
- Assign key commands to **Insert Velocity 1-5** and use them.  
This allows you to quickly switch between different velocity values when you enter note events.

## Handling Several MIDI Parts

- To activate a part for editing, open the **Currently Edited Part** menu and select a part.  
When you select a part from the list, it is automatically active and centered in the note display.
- To zoom in on an active part, select **Edit > Zoom > Zoom to Event**.
- To display defined borders for the active part, activate **Show Part Borders**.  
If this option is activated, all parts, except the active part, are grayed out.
- To restrict editing operations to the active part, activate **Edit Active Part Only**.
- To change the size of the part, drag the part borders.  
The part borders display the name of the active part.

### NOTE

If the part that you open for editing is a shared copy, any editing that you perform affects all shared copies of this part. In the **Project** window, shared copies are indicated by an equal sign in the top right corner of the part.

---

## Looping MIDI Parts

The **Independent Track Loop** function allows you to loop a MIDI part independent of the project playback.

When you activate the loop, the MIDI events within the loop are repeated continuously while other events on other tracks are played back as usual. Every time the cycle restarts, the independent track loop also restarts.

### PROCEDURE

1. Activate **Independent Track Loop** on the toolbar.

### NOTE

If you activate **Independent Track Loop**, the **Link Project and Lower Zone Editor Cursors** function is automatically deactivated in the **Editor** tab in the lower zone of the **Project** window.

---

If the button is not visible, right-click the toolbar and select **Independent Track Loop** from the menu.

If you have set up a loop range in the **Project** window, it is hidden from the ruler in the MIDI editor.

2. **Ctrl/Cmd**-click in the ruler to specify the start of the independent track loop.



3. **Alt-click** in the ruler to specify the end of the independent track loop.

#### RESULT

The independent loop range is indicated in a different color.

The start and end of the loop range are displayed on the status line.

#### AFTER COMPLETING THIS TASK

To repeat the events of the loop range and fill up the active MIDI part, select **MIDI > Repeat Loop**.

## Controller Display

The area at the bottom of the **Key Editor**, the **Drum Editor** and the **In-Place Editor** is the controller display.

By default, the controller display has a single lane. You can add more controller lanes that display different controller event types.

To show the controller display, do one of the following:

- Open the **Controller Lane Setup** pop-up menu in the **Key Editor**, the **Drum Editor** or the **In-Place Editor**, and select **Show/Hide Controller Lanes**.
- On the **Key Editor** or the **Drum Editor** toolbar, click **Set up Window Layout** and activate **Controller Lanes**.

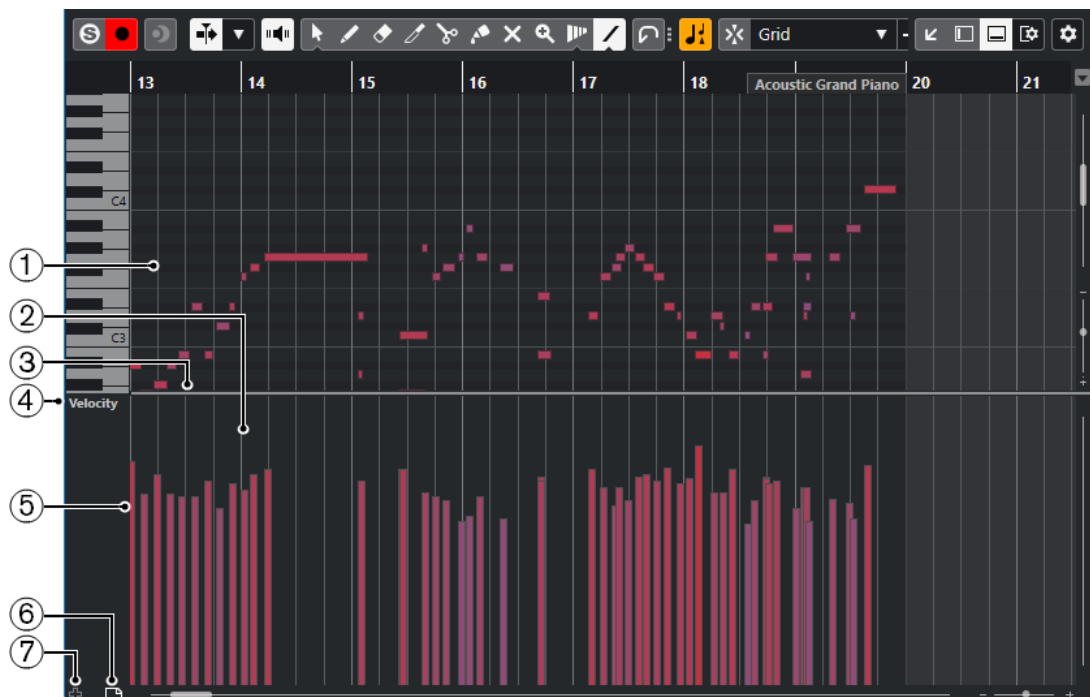

The following options are available:

- 1 **Note display**  
Contains a grid in which MIDI notes are displayed as boxes.
- 2 **Controller display**  
Shows one or multiple controller lanes.
- 3 **Divider**  
Drag the divider between the note display and the controller display to resize the display areas.

#### 4 **Controller Selection and Functions pop-up menu**

Allows you to select which controller type is displayed, and contains editing functions for controller lanes and events.

#### 5 **Controller event**

The controller display shows the added controller events of the selected controller type and their current values. Controller events have no length. Their values are valid until the start of the next event.

Velocity values are shown as vertical bars, with higher bars corresponding to higher velocity values. Each velocity bar corresponds to a note in the note display.

All other controller events are shown as blocks, with heights corresponding to the values of the events.

#### 6 **Create Controller Lane**

Allows you to add controller lanes so that you can view and edit different controllers at the same time. Each controller lane can show one of the following properties or event types:

- Velocity
- Pitchbend
- Aftertouch
- Poly Pressure
- Program Change
- System Exclusive events
- Continuous Controllers

#### 7 **Controller Lane Setup**

Contains setup functions for controller lanes, and allows you to add and organize presets.

## Controller Lane Setup Menu

The **Controller Lane Setup** menu allows you to add lanes and select which event type is displayed.

- To open the **Controller Lane Setup** dialog, click **Controller Lane Setup**  at the bottom left of the controller display.

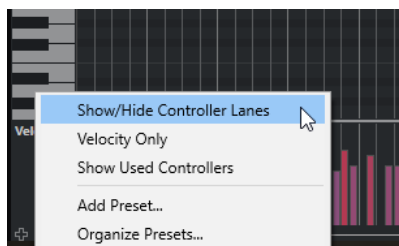

The following options are available:

#### **Show/Hide Controller Lanes**

Shows/hides controller lanes.

#### **Velocity Only**

Resets the controller display to show only the velocity lane.

#### **Show Used Controllers**

Shows all controller lanes that have controller events.

#### **Add Preset**

Opens the **Add Preset** dialog that allows you to save a preset and enter a name for it.

### Organize Presets

Opens the **Organize Presets** dialog that allows you to rename and delete presets.

#### NOTE

The controller lane setup is also used when you create a new MIDI track.

---

## Controller Selection and Functions Menu

The **Controller Selection and Functions** menu allows to select which controller type is displayed. It also contains editing functions for controller lanes and events.

- To open the **Controller Selection and Functions** dialog, click **Controller Selection and Functions** to the left of the controller display.

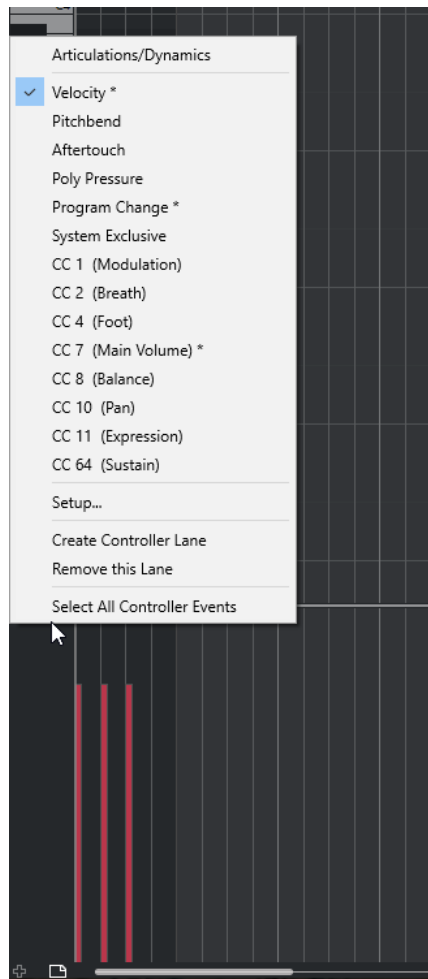

The following options are available:

### Event types

Lists the event types that you can display on the controller lanes. If automation data already exists for a controller, this is indicated by an asterisk that is displayed next to the controller name.

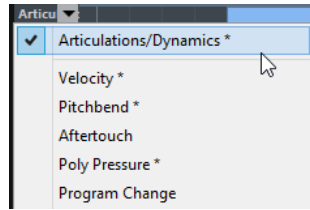

### Setup

Opens the **MIDI Controller Setup** dialog that allows you to specify which MIDI controllers are visible/hidden in the menu.

### Create Controller Lane

Adds a controller lane to the controller display.

### Remove this Lane

Removes the current controller lane.

### Select All Controller Events

Selects all controller events from the current lane.

#### RELATED LINKS

[MIDI Controller Setup Dialog](#) on page 630

## Adding Controller Lanes

You can add controller lanes to the controller display. Controller lanes allow you to select a specific controller type for display, so that you can add and edit controller events of that type.

---

#### PROCEDURE

- Do one of the following:
  - Click **Create Controller Lane** .
  - Open the **Controller Selection and Functions** menu and select **Create Controller Lane**.

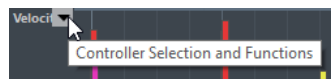

---

#### RESULT

A new controller lane is created.

#### NOTE

- To hide a controller lane from view, open the **Controller Selection and Functions** pop-up menu and select **Remove this Lane**. This does not affect the events in any way.
- If you hide all lanes, the controller display is hidden. You can bring it back by clicking **Create Controller Lane**.

---

#### RELATED LINKS

[Controller Selection and Functions Menu](#) on page 627

## Selecting Controller Event Types for Display

You can select which event type to display on a controller lane. Each controller lane shows one event type at a time.

---

### PROCEDURE

- Open the **Controller Selection and Functions** pop-up menu and select an event type.

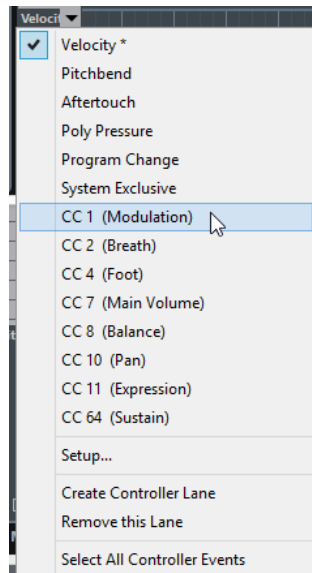

---

### RELATED LINKS

[Controller Selection and Functions Menu](#) on page 627

## Setting up Available Continuous Controllers

In the **MIDI Controller Setup** dialog, you can specify which continuous controllers are available for selection.

---

### PROCEDURE

1. Select **Controller Selection and Functions > Setup**.

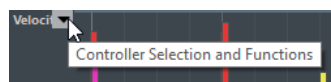

2. In the **MIDI Controller Setup** dialog, move all the controllers that you need to the list on the left and move the controllers that you do not need to the list on the right.
3. Click **OK**.

---

### RESULT

The corresponding continuous controllers are now available for selection.

### NOTE

The **MIDI Controller Setup** dialog can be opened from different areas in the program. The settings are global, that is, the setup you choose here affects all areas of the program where MIDI controllers can be selected.

---

### RELATED LINKS

[Setting up Available Continuous Controllers](#) on page 629

## MIDI Controller Setup Dialog

The **MIDI Controller Setup** dialog allows you to specify which MIDI controllers are visible/hidden.

- To open the **MIDI Controller Setup** dialog, click **Controller Selection and Functions** to the left of the controller display, and select **Setup**.

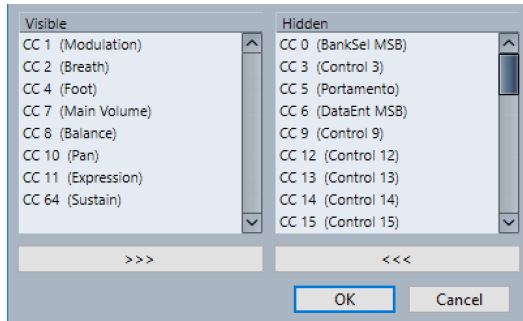

### Visible

Lists the MIDI controllers that are visible.

### Hidden

Lists the MIDI controllers that are hidden.

>>>

Select an item in the **Visible** list, and click >>> to hide it.

<<<

Select an item in the **Hidden** list, and click <<< to make it visible.

## Saving Controller Lane Presets

You can save a controller lane setup as a controller lane preset. This way, you can have a preset with one velocity lane and another preset with a combination of several controller lanes, such as velocity, pitchbend, or modulation.

### PREREQUISITE

You have added at least one controller lane and selected a controller event type for display.

---

### PROCEDURE

1. Click **Controller Lane Setup** .
2. Select **Add Preset**.
3. In the **Type In Preset Name** dialog, enter a name for the preset.
4. Click **OK**.

---

### RESULT

Your controller lane setup is now available as a controller lane preset. The number of lanes and the displayed event types are saved in the preset.

To load, remove or rename presets, use the options in the **Controller Lane Setup** pop-up menu.

### RELATED LINKS

[Controller Lane Setup Menu](#) on page 626

## Adding Velocity Events

You can add velocity events by adding note events.

### PREREQUISITE

You have added a controller lane.

---

### PROCEDURE

1. Open the **Controller Selection and Functions** pop-up menu and select **Velocity**.
  2. Select the **Draw** tool or the **Line** tool.
  3. Click in the note display to add a note event.  
This adds a note event and a velocity controller event that you can edit.
- 

### RESULT

The velocity values are shown as vertical bars in the controller display. Each velocity bar corresponds to a note event in the note display. Higher bars correspond to higher velocity values. The value is valid until the beginning of the next event.



### RELATED LINKS

[Adding Controller Lanes](#) on page 628

[Line Tool Modes](#) on page 635

[Controller Selection and Functions Menu](#) on page 627

## Editing Velocity Events

### PREREQUISITE

You have added a controller lane and set it up to display velocity events. You have added velocity events for several notes.

---

### PROCEDURE

1. Optional: On the toolbar, activate **Acoustic Feedback**.  
This plays back the notes when you adjust the velocity so that you can audition your changes.
2. Do one of the following:

- On the toolbar, select the **Object Selection** or the **Draw** tool and drag a velocity bar in the controller display.
- On the toolbar, select the **Object Selection** tool, press **Alt** and click a velocity bar in the controller display to select it. Change its value in the **Velocity** field on the info line.
- On the toolbar, select the **Line** tool and paint a curve to change the velocity values of several notes.

The velocity value at the cursor position is displayed below the **Controller Selection and Functions** pop-up menu.



#### NOTE

If there is more than one note at the same position, their velocity bars overlap. To edit the velocity of only one of these notes, select the note in the note display. If no note is selected, all velocity events get the same velocity value.

---

#### RESULT

The velocity values change according to your edits.

#### RELATED LINKS

[Adding Velocity Events](#) on page 631

[Controller Selection and Functions Menu](#) on page 627

## Adding Poly Pressure Events

You can add poly pressure events to your note events. Poly pressure events are events that belong to a specific note number, that is key. For each poly pressure event you can edit the note number and the amount of pressure.

---

#### PROCEDURE

1. Open the **Controller Selection and Functions** pop-up menu and select **Poly Pressure**. When **Poly Pressure** is selected on the **Controller Selection and Functions** pop-up menu a note number value field is shown to the left of the controller display.

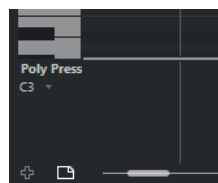

2. Do one of the following:
  - Click a key on the keyboard display to set the note number.
  - If you have selected poly pressure for several controller lanes, enter the note number in the lower value field to the left of each lane.

The selected note number is displayed in the upper value field to the left of the controller display.

3. On the toolbar, select the **Draw** tool, and add a new poly pressure event.



You can determine the amount value by moving the mouse up or down in the controller display.

---

#### AFTER COMPLETING THIS TASK

Select a different note number and add poly pressure events for this.

#### RELATED LINKS

[Controller Selection and Functions Menu](#) on page 627

## Editing Poly Pressure Events

#### PREREQUISITE

You have added a controller lane and set it up to display poly pressure events. You have added poly pressure events for several note numbers.

---

#### PROCEDURE

1. Click the arrow button next to the note number to the left of the controller lane.  
A pop-up menu with a list of all note numbers for which you inserted poly pressure events opens.
  2. Select a note number from the pop-up menu.  
The poly pressure events for the selected note number are shown in the controller lane.
  3. On the toolbar, select the **Draw** tool.
  4. Hold down **Ctrl/Cmd-Alt** and edit the events in the controller display.
- 

#### RELATED LINKS

[Adding Poly Pressure Events](#) on page 632

## Adding Continuous Controllers

You can add continuous controllers to your note events.

#### PREREQUISITE

You have added a controller lane.

---

#### PROCEDURE

1. Open the **Controller Selection and Functions** pop-up menu and select a continuous controller.
  2. Select the **Draw** tool or the **Line** tool.
  3. Do one of the following:
    - To add a single event, click in the controller display.
    - To add a multiple events, click and drag in the controller display.
    - To add a **Modulation (CC1)** event, copy note events from the **Key Editor** note display and paste them on a controller lane in the controller display.
- 

#### RESULT

The added events are shown as blocks. The block corresponds to the event values. The beginning of an event is marked by a curve point. Controller events have no length. The value of a controller event in the display is valid until the beginning of the next controller event.

RELATED LINKS

[Adding Controller Lanes](#) on page 628

[Line Tool Modes](#) on page 635

[Controller Selection and Functions Menu](#) on page 627

## Editing Continuous Controllers

PREREQUISITE

You have added a controller lane and set it up to display controller events. You have added controller events for several notes.

---

PROCEDURE

1. On the toolbar, select the **Object Selection**, the **Draw**, or the **Line** tool.
2. Do one of the following:
  - If you selected the **Draw**, or the **Line** tool, drag in the controller display.
  - If you selected the **Object Selection** tool, press **Alt** and drag in the controller display.

---

RESULT

The controller event is edited.

RELATED LINKS

[Line Tool Modes](#) on page 635

## Continuous Controllers and MIDI Automation

You can record or enter MIDI controller data either for an automation track in the **Project** window or for a MIDI part in the **Key Editor**.

If you display a continuous controller on a controller lane, MIDI controller data from the automation track is displayed on the controller lane. However, you cannot edit this data on the controller lane.

If conflicting controller data exists, you must specify what should happen on playback by selecting an option from the **Automation Merge Modes** in the **MIDI Controller Automation Setup** dialog.

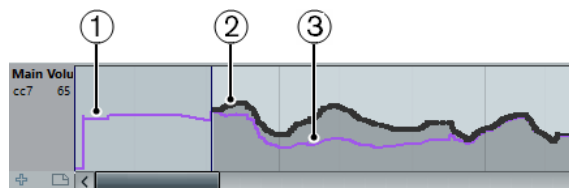

- 1 The controller curve before the part starts. This curve depends on the existing controller data and on the selected merge mode.
- 2 Controller curve entered on the controller lane.
- 3 Resulting controller curve if controller automation was also recorded on a track. These values depend on the selected automation merge mode.

On the controller lane, you can also see the controller curve that is applied before the part starts. This tells you which controller value is being used at the starting point of the part so that you can choose the start value accordingly.

The start value also depends on the automation merge mode.

RELATED LINKS

[MIDI Controller Automation](#) on page 544

[Automation Merge Modes](#) on page 544

## Line Tool Modes

You can use the different **Line** tool modes to edit controller events.

- To select a line mode, click the **Line** tool on the **Key Editor** or the **Drum Editor** toolbar, and click again to open a pop-up menu with the available modes.

The following modes are available:

### Line

In this mode you can draw events in a straight line by clicking in the controller display and dragging the cursor to where you want the ramp to end.

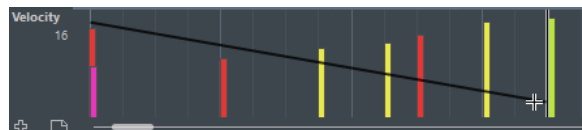

#### NOTE

If **Snap** is activated, the **Length Quantize** value determines the density of created controller curves. For very smooth curves, use a small **Length Quantize** value or deactivate **Snap**. Beware that very dense controller curves can cause MIDI playback to stutter.

### Parabola

In this mode you can draw events on a parabola curve. This gives more natural curves and fades.

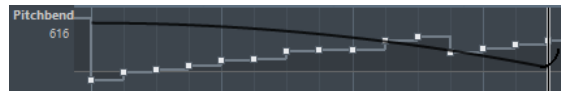

You can use modifier keys to determine the shape of the parabola curve.

- To reverse the parabola curve, press **Ctrl/Cmd**.
- To change the position of the whole curve, press **Alt**.
- To increase or decrease the exponent, press **Shift**.

#### NOTE

If **Snap** is activated, the **Length Quantize** value determines the density of created controller curves. For very smooth curves, use a small **Length Quantize** value or deactivate **Snap**. Beware that very dense controller curves can cause MIDI playback to stutter.

### Sine, Triangle, and Square

These modes create different periodic waveform curves.

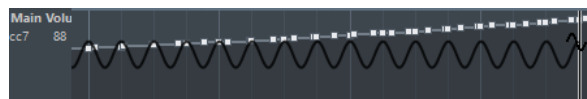

The quantize value determines the period of the curve that is the length of one curve cycle. The **Length Quantize** value determines the density of the events.

NOTE

If you set **Length Quantize** to **Quantize Link** and you enter data in **Sine**, **Triangle** or **Square** mode, the density of the events depends on the zoom factor.

You can use modifier keys to determine the shape of the curve.

- To change the phase of the beginning of the curve, press **Ctrl/Cmd**.
- To change the position of the whole curve, press **Alt-Ctrl/Cmd**.
- To change the maximum position of the triangle curve or the pulse of the square curve in **Triangle** and **Square** mode, press **Shift-Ctrl/Cmd**. This creates sawtooth curves.
- You can also set the curve period freely by holding down **Shift** when you insert events in **Sine**, **Triangle**, or **Square** mode. Activate **Snap**, **Shift**-click and drag to set the length of one period. The period length will be a multiple of the quantize value.

Paint

In this mode, you can draw in multiple notes.

NOTE

If **Snap** is activated, the **Length Quantize** value determines the density of created controller curves. For very smooth curves, use a small **Length Quantize** value or deactivate **Snap**. Beware that very dense controller curves can cause MIDI playback to stutter.

## Controller Event Editor

The controller event editor allows you to perform additional scaling operations for selection ranges on existing controller curves.

- To open the controller event editor, activate the **Object Selection** tool and drag a selection rectangle on the controller lane.
- To open the controller event editor for velocity lanes, select multiple MIDI notes in the note display or activate the **Object Selection** tool, press **Alt** and drag a selection rectangle on the controller lane or to get the **Object Selection** tool.

The controller event editor features the following smart controls for specific editing modes:

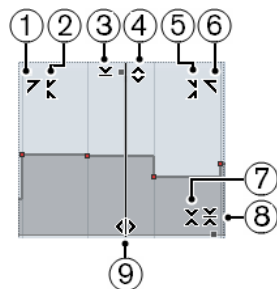

1 **Tilt Left**

If you click in the upper left corner of the editor, you can tilt the left part of the curve. This allows you to tilt the event values at the start of the curve upwards or downwards.

2 **Compress Left**

If you **Alt**-click in the upper left corner of the editor, you can compress or expand the left part of the curve. This allows you to compress or expand the event values at the start of the curve.

### 3 **Scale Vertically**

If you click in the middle of the upper border of the editor, you can scale the curve vertically. This allows you to raise or lower the event values of the curve in percent.

### 4 **Move Vertically**

If you click on the upper border of the editor, you can move the entire curve vertically. This allows you to raise or lower the values of the event values of the curve.

### 5 **Compress Right**

If you **Alt**-click in the upper right corner of the editor, you can compress or expand the right part of the curve. This allows you to compress or expand the event values at the end of the curve.

### 6 **Tilt Right**

If you click in the upper right corner of the editor, you can tilt the right part of the curve. This allows you to tilt the event values at the end of the curve upwards or downwards.

### 7 **Scale Around Relative Center**

If you **Alt**-click in the middle right border of the editor, you can scale the curve relative to its center. This allows you to raise or lower the event values horizontally around the center of the editor.

### 8 **Scale Around Absolute Center**

If you click in the middle right corner of the editor, you can scale the curve absolute to its center. This allows you to raise or lower the event values horizontally around the center of the editor.

### 9 **Stretch**

If you click on the lower border of the editor, you can stretch the curve horizontally. This allows you to move the event values of the curve to the left or to the right.

## Auto Select Controllers

**Auto Select Controllers** automatically selects controller data of the selected MIDI notes. This is useful as selected controllers for notes will be moved when you move the corresponding notes.

- To show **Auto Select Controllers**, right-click the **Key Editor** or the **Drum Editor** toolbar, and select **Auto Select Controllers**.



If you activate **Auto Select Controllers**, controllers that belong to a note event are automatically selected when you select the note event.

#### RELATED LINKS

[Key Editor Toolbar](#) on page 640

## Moving Events in the Controller Display

You can move events of a controller curve in the controller display. This only works for curve type controller events such as continuous controllers, pitchbend, aftertouch, poly pressure, and program change.

---

#### PROCEDURE

1. Do one of the following:
  - With the **Object Selection** tool, drag to create a selection rectangle that encompasses the events that you want to move.
  - On the toolbar, activate **Auto Select Controllers**. In the note display, select the notes whose controllers you want to move.

- In the note display, select the notes whose controllers you want to move, and select **Edit > Select > Select Controllers in Note Range** to select the controllers within the range of the selected notes.

2. Move the note/controller events.

#### RESULT

The controller events are moved to the new position. Snap is taken into account.

#### RELATED LINKS

[Select Controllers in Note Range: Use Extended Note Context](#) on page 891

## Key Editor

The **Key Editor** is the default MIDI editor. It displays notes graphically in a piano roll-style grid. The **Key Editor** allows for detailed editing of notes and non-note events, such as MIDI controllers.

You can open the **Key Editor** in a separate window or in a tab in the lower zone of the **Project** window. Opening the **Key Editor** in the lower zone of the **Project** window is useful if you want to access the **Key Editor** functions from within a fixed zone of the **Project** window.

To open a MIDI part in the **Key Editor**, do one of the following:

- Double-click a MIDI part in the **Project** window.
- Select a MIDI part in the **Project** window and press **Return** or **Ctrl/Cmd-E**.
- Select a MIDI part in the **Project** window and select **MIDI > Open Key Editor**.
- In the **Key Commands** dialog in the **Editors** category, assign a key command for **Open Key Editor**. Select a MIDI part in the **Project** window and use the key command.

#### NOTE

If you select **MIDI > Set up Editor Preferences**, the **Preferences** dialog opens on the **Editors** page. Make your changes to specify if you want the editors to open in a separate window or in the lower zone of the **Project** window.

The **Key Editor** window:

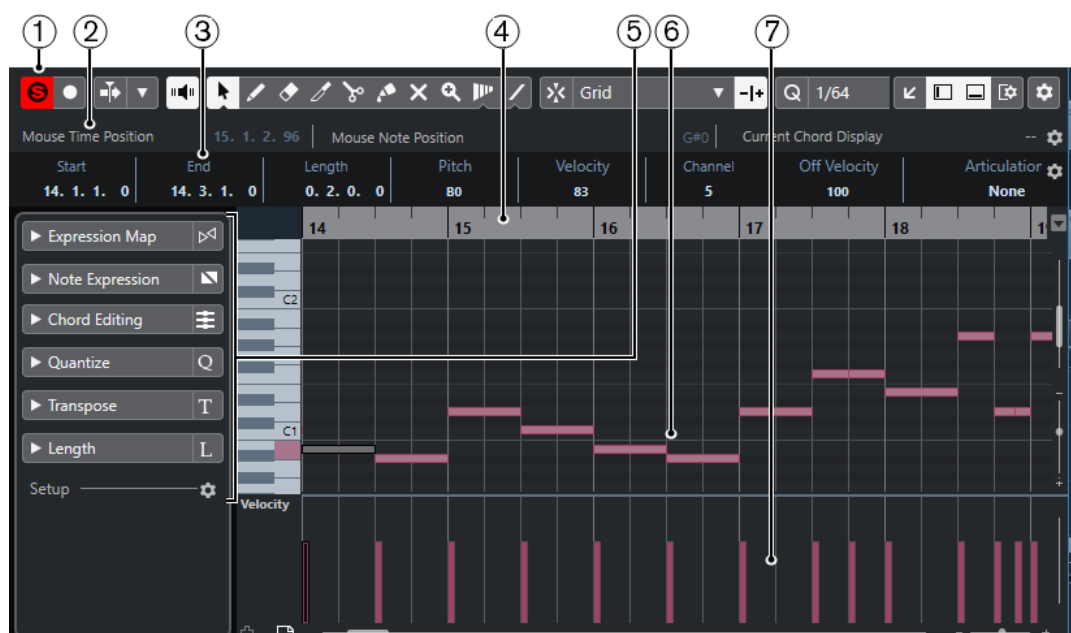

The **Key Editor** is shown in the **Editor** tab in the lower zone of the **Project** window:

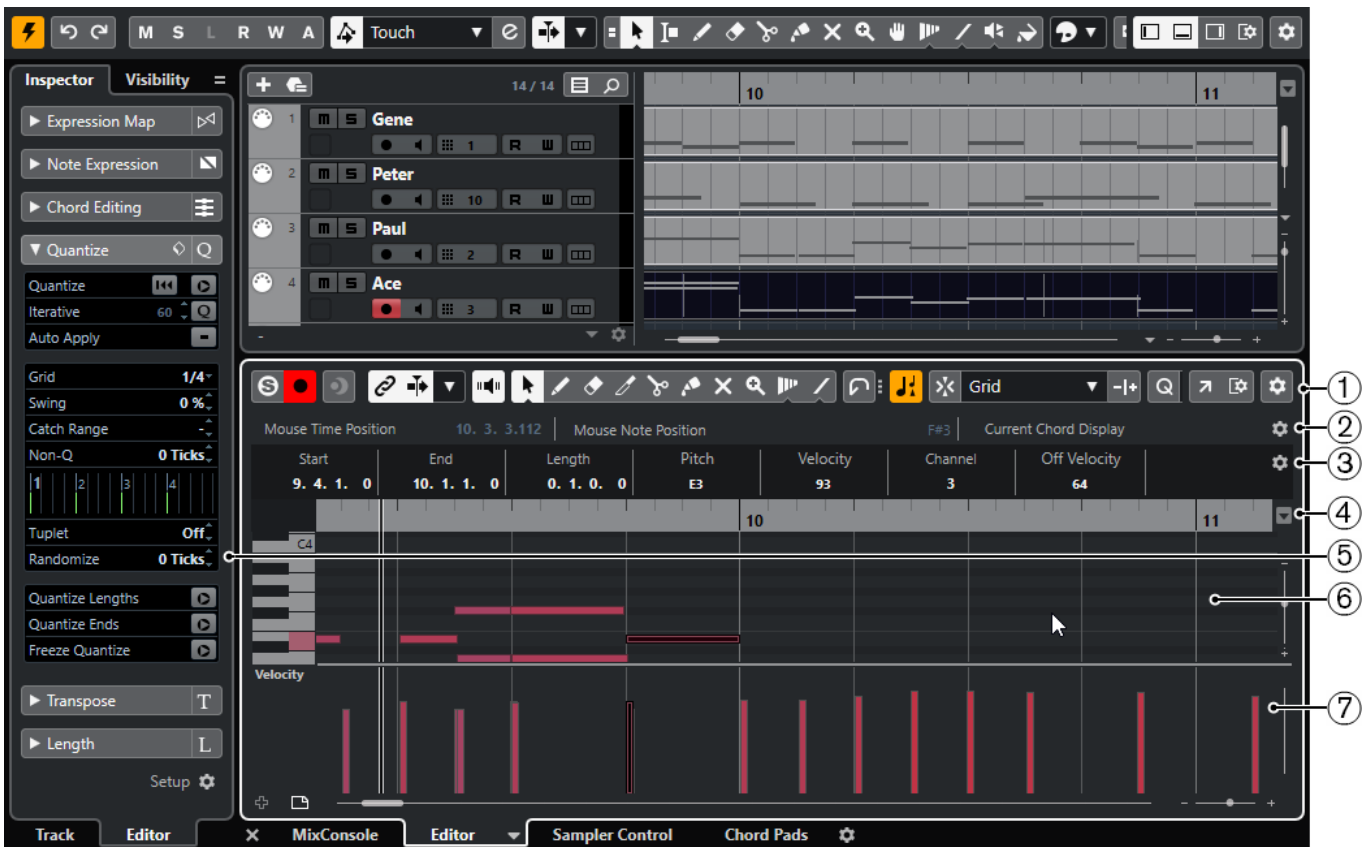

The **Key Editor** is divided into several sections:

- 1 Toolbar**  
Contains tools and settings.
- 2 Status line**  
Informs about the mouse time position, the mouse note position, and the current chord.
- 3 Info line**  
Displays note event information about a selected MIDI note.
- 4 Ruler**  
Displays the timeline.
- 5 Inspector**  
Contains tools and functions for working with MIDI data.
- 6 Note display**  
Contains a grid in which MIDI notes are displayed as boxes.
- 7 Controller display**  
The area below the note display consists of one or multiple controller lanes.

#### NOTE

You can activate/deactivate the status line, the info line, and the controller lanes by clicking **Set up Window Layout** on the toolbar and activating/deactivating the corresponding options.

#### RELATED LINKS

- [Key Editor Toolbar](#) on page 640
- [Status Line](#) on page 646

[Key Editor Inspector](#) on page 647

[Note Display](#) on page 648

[Controller Display](#) on page 625

## Key Editor Toolbar

The toolbar contains tools and settings for the **Key Editor**.

- To show or hide the toolbar elements, right-click the toolbar and activate or deactivate the elements.

### Default Items

#### Solo Editor



Solos the editor during playback if the editor has the focus.

#### Record in Editor



Enables the recording of MIDI data in the editor if the editor has the focus.

NOTE

This only works if **MIDI Record Mode** is set to **Merge** or **Replace**.

---

### Retrospective Record

#### Insert MIDI Retrospective Recording in Editor



Allows you to recover MIDI notes that you played in stop mode or during playback.

### Left Divider

#### Left Divider

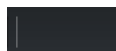

Allows you to use the left divider. Tools that are placed to the left of the divider are always shown.

### Auto-Scroll

#### Link Project and Lower Zone Editor Cursors



Links timelines, cursors, and zoom factors of the **Editor** tab in the lower zone and the **Project** window.

NOTE

You cannot activate **Link Project and Lower Zone Editor Cursors** if **Independent Track Loop** is active.

---

#### Auto-Scroll



Keeps the project cursor visible during playback.

#### Select Auto-Scroll Settings





Allows you to activate **Page Scroll** or **Stationary Cursor** and to activate **Suspend Auto-Scroll When Editing**.

## Acoustic Feedback

### Acoustic Feedback



Automatically plays back events when you move or transpose them, or when you create them by drawing.

## Tool Buttons

### Object Selection



Selects events and parts.

### Draw



Draws events.

### Erase



Deletes events.

### Trim



Trims events.

### Split



Splits events.

### Glue



Glues together events of the same pitch.

### Mute



Mutes events.

### Zoom



Zooms in. Hold **Alt** and click to zoom out.

### Line



Creates a series of contiguous events.

## Auto Select Controllers

### Auto Select Controllers



Automatically selects controller data of the selected MIDI notes.

## Independent Track Loop

### Independent Track Loop



Activates/Deactivates the independent track loop.

#### NOTE

If you activate **Independent Track Loop**, the **Link Project and Lower Zone Editor Cursors** function is automatically deactivated in the **Editor** tab in the lower zone.

---

## Show Note Expression Data

### Show Note Expression Data



Shows note expression data.

## Indicate Transpositions

### Indicate Transpositions



Allows you to display the transposed pitches of MIDI notes.

## Insert Velocity

### Note Insert Velocity



Allows you to specify a velocity value for new notes.

## Nudge Palette

### Trim Start Left



Increases the length of the selected event by moving its start to the left.

### Trim Start Right



Decreases the length of the selected event by moving its start to the right.

### Move Left



Moves the selected event to the left.

### Move Right



Moves the selected event to the right.

### Trim End Left



Decreases the length of the selected event by moving its end to the left.

### Trim End Right



Increases the length of the selected event by moving its end to the right.

## Transpose Palette

### Move Up



Transposes the selected event up by a half note.

### Move Down



Transposes the selected event down by a half note.

### Move Up More



Transposes the selected event up by an octave.

### Move Down More



Transposes the selected event down by an octave.

## Snap

### Snap On/Off



Activates/Deactivates the **Snap** function.

### Snap Type



Allows you to select one of the following snap types:

- **Grid** snaps events to the grid that is selected in the **Quantize Presets** pop-up menu.
- **Grid Relative** keeps the relative positions when snapping events to the grid.
- **Events** snaps events to the start or end of other events.
- **Shuffle** changes the order of events if you drag one event to the left or right of other events.
- **Cursor** snaps events to the cursor position.
- **Grid + Cursor** snaps events to the quantize grid that is selected in the **Quantize Presets** pop-up menu or to the cursor position.
- **Events + Cursor** snaps events to the start or end of other events, or to the cursor position.
- **Grid + Events + Cursor** snaps events to the quantize grid that is selected in the **Quantize Presets** pop-up menu, to the start or end of other events or to the cursor position.

### Grid Type



Allows you to select one of the following grid types:

- **Use Quantize** activates a grid where events snap to the value that is selected in the **Quantize Presets** pop-up menu.
- **Adapt to Zoom** activates a grid where events snap to the zoom level.

## Quantize

### Apply Quantize



Applies the quantize settings.

### Quantize Presets



Allows you to select a quantize or a groove preset.

### Iterative Quantize On/Off



Activates/Deactivates iterative quantize.

### Open Quantize Panel



Opens the **Quantize Panel**.

## Length Quantize

### Length Quantize

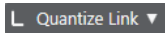

Allows you to set a value for quantizing event lengths.

## Multiple Part Controls

### Show Part Borders



Shows/Hides part borders for the active MIDI part within the left and right locators.

### Edit Active Part Only



Restricts editing operations to the active part.

### Currently Edited Part

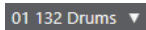

Lists all parts that were selected when you opened the editor, and allows you to activate a part.

## Step/MIDI Input

### Step Input



Activates/Deactivates MIDI step input.

### MIDI Input/Note Expression MIDI Input



Activates/Deactivates MIDI input and note expression MIDI input.

### Move Insert Mode



Moves all note events to the right of the step input position to the right to make room for the inserted event when you insert notes.

## NOTE

This only works if **Step Input** is activated.

---

### Record Pitch



Includes the pitch when you insert notes.

### Record NoteOn Velocity



Includes the NoteOn velocity when you insert notes.

### Record NoteOff Velocity



Includes the NoteOff velocity when you insert notes.

## Event Colors

### Event Colors



Allows you to select event colors.

## Edit VST Instrument

### Edit VST Instrument



Opens the VST instrument that the track is routed to.

## Right Divider

### Right Divider



Allows you to use the right divider. Tools that are placed to the right of the divider are always shown.

## Window Zone Controls

### Open in Separate Window



This button is available in the **Editor** tab in the lower zone. It opens the editor in a separate window.

### Open in Lower Zone



This button is available in the editor window. It opens the **Editor** tab in the lower zone of the **Project** window.

### Set up Window Layout



Allows you to set up the window layout.

### Set up Toolbar



Opens a pop-up menu where you can set up which toolbar elements are visible.

RELATED LINKS

[Zooming in MIDI Editors](#) on page 619

## Status Line

The status line shows information about the mouse time position, the mouse note position, and the current chord.

- To show the status line, click **Set up Window Layout** on the toolbar, and activate **Status Line**.



The on/off status of the status line in the **Key Editor** window and in the **Editor** tab in the lower zone of the **Project** window are independent of each other.

### Mouse Time Position

Displays the exact time position of the mouse pointer, depending on the selected ruler display format. This lets you edit or insert notes at exact positions.

### Mouse Note Position

Displays the exact pitch of the mouse pointer position. This facilitates finding the right pitch when entering or transposing notes.

### Current Chord Display

When the project cursor is positioned over notes that form a chord, the chord is displayed here.

RELATED LINKS

[Looping MIDI Parts](#) on page 624

## Info Line

The info line shows values and properties of the selected events. If several notes are selected, the values for the first note are displayed in color.

- To show the info line, click **Set up Window Layout** on the toolbar, and activate **Info Line**.

Start	End	Length	Pitch	Velocity	Channel	Off Velocity	Articulations	Release Length
11. 3. 4.101	13. 1. 1. 15	1. 1. 0. 34	A3	100	1	64	None	0. 0. 0. 0

Length and position values are displayed in the selected ruler display format.

The on/off status of the info line in the **Key Editor** window and in the **Editor** tab in the lower zone of the **Project** window are independent of each other.

RELATED LINKS

[Editing Note Events on the Info Line](#) on page 623

[Changing the Ruler Display Format](#) on page 618

## Key Editor Inspector

In a MIDI editor, the **Inspector** is located left of the note display. The **Inspector** contains tools and functions for working with MIDI data.

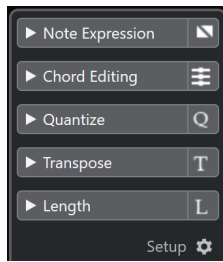

### Note Expression

Contains functions and settings related to Note Expression.

### Chord Editing

Allows you to enter chords instead of single notes.

### Quantize

Allows you to access the main quantize parameters. These are identical with the functions on the **Quantize** panel.

### Transpose

Allows you to access the main parameters for transposing MIDI events.

### Length

Contains length-related options, similar to the **Functions** submenu of the **MIDI** menu.

- To change the length of the selected MIDI events or all events of the active part if no events are selected, use the **Scale Length/Scale Legato** slider. At the maximum value, the notes reach the beginning of the next note.
- To make the new length settings permanent, click **Freeze MIDI Lengths** to the right of the **Scale Length/Scale Legato** slider.
- To fine-tune the distance between consecutive notes, use the **Overlap** slider. At **0 Ticks**, the **Scale Length/Scale Legato** slider extends each note so that it reaches the next note exactly. Positive values cause the notes to overlap and negative values allow you to define a small gap between the notes.
- To use the **Legato** function or slider to extend a note until the next selected note, activate **Between Selected**.

This is identical with activating the **Legato Mode: Between Selected Notes Only** option in the **Preferences** dialog.

### Setup

Allows you to open a dialog to edit the **Inspector** settings for the editor. Click **Setup Inspector**, and from the pop-up menu, select **Setup**.

### NOTE

If you open the **Key Editor** in the lower zone, these sections are shown in the **Editor Inspector** in the left zone.

---

### RELATED LINKS

[Note Expression Inspector Section](#) on page 712

[Quantize Panel](#) on page 264

[Transpose Functions](#) on page 292  
[Opening the Editor Inspector](#) on page 47

## Note Display

The note display is the main area in the **Key Editor**. It contains a grid in which note events are shown as boxes.

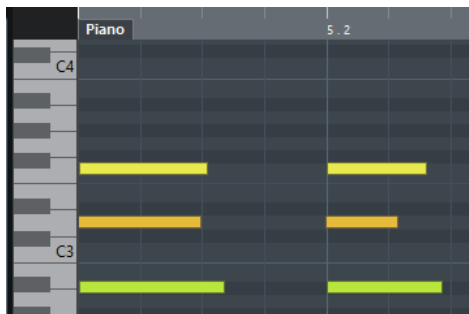

The width of a box corresponds to the note length. The vertical position of a box corresponds to the note number (pitch), with higher note events higher up in the grid. The piano keyboard helps you to find the right note number.

## Key Editor Operations

This section describes the principal editing operations within the **Key Editor**.

### Inserting Note Events with the Object Selection Tool

You can insert note events with the **Object Selection** tool.

#### PREREQUISITE

You have set up the length for the note events quantize value in the **Length Quantize** pop-up menu of the toolbar.

---

#### PROCEDURE

- In the note display, double-click with the **Object Selection** tool at the position where you want to insert a note.

---

#### RESULT

A note is inserted at the position where you double-clicked with the length that you have set up in the **Length Quantize** pop-up menu.

### Drawing Note Events with the Draw Tool

The **Draw** tool allows you to insert single note events in the note display.

When you move the cursor inside the note display, its position is indicated on the status line. Its pitch is indicated both on the status line and on the piano keyboard to the left.



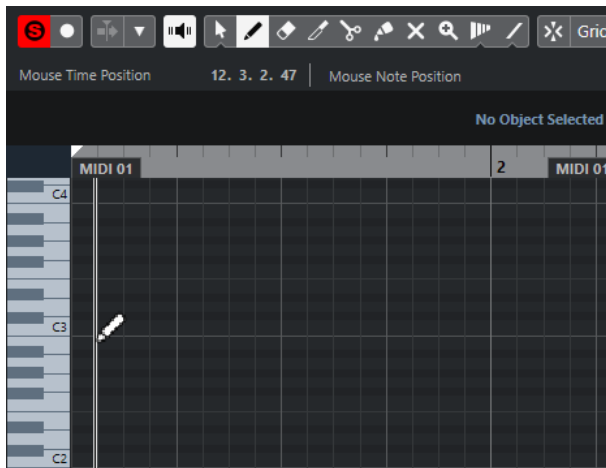

- To draw a note, click in the note display.  
The note event has the length that is set on the **Length Quantize** pop-up menu.
- To draw longer note events, click and drag in the note display.  
The length of the note event is a multiple of the Length Quantize value. If **Length Quantize** is set to **Quantize Link**, the note value is determined by the quantize grid. The **Snap** function is taken into account.

#### NOTE

To temporarily switch from the **Object Selection** tool to the **Draw** tool, hold down **Alt**.

---

## Modifying Note Values while Inserting Notes

When inserting note events, you can modify specific note values on the fly.

- To edit the note velocity, drag upwards or downwards.
- To edit the note pitch, hold down **Alt** and drag upwards or downwards.
- To edit the note length, drag to the left or to the right.
- To edit the time position, hold down **Shift** and drag to the left or to the right.

#### NOTE

You can activate/deactivate **Snap** temporarily by holding down **Ctrl/Cmd**.

---

## Drawing Note Events with the Line Tool

In the note display, the **Line** tool allows you to draw a series of contiguous note events along different line shapes.

- To create contiguous note events, click and drag in the note display.
- To restrict movement to horizontal, press **Ctrl/Cmd** and drag.  
The notes have the same pitch.

If **Snap** is activated, the note events and controller events are positioned and sized according to the **Quantize** and **Length Quantize** values.

#### RELATED LINKS

[Line Tool Modes](#) on page 650

## Line Tool Modes

The **Line** tool allows you to create a series of contiguous note events along different line shapes. You can also edit multiple controller events simultaneously.

- To open the **Line** tool modes, click **Line**.

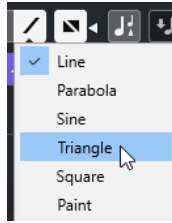

The following line modes are available:

### Line

If this option is activated, you can click and drag to insert note events in the note display along a straight line in any angle. Use this option to edit controller data along a straight line in the controller display.

### Parabola, Sine, Triangle, Square

These modes insert note events along different curve shapes.

### Paint

This mode allows you to insert note events by painting in the note display.

## Moving and Transposing Note Events

There are several options to move and transpose note events.

- To move note events in the editor, select the **Object Selection** tool and drag them to a new position.  
All selected note events are moved, maintaining their relative positions. **Snap** is taken into account.
- To allow only horizontal or only vertical movement, hold down **Ctrl/Cmd** while dragging.
- To move note events via the **Nudge Palette** buttons on the toolbar, select the note events and click a **Nudge Palette** button.  
This moves the selected note events by the **Snap** value in the drum sound list.
- To move note events to the project cursor position, select the note events and select **Edit > Move to > Cursor**.
- To move a note event via the info line, select a note event and edit the **Position** or **Pitch** on the info line.
- To transpose note events, select the note events and use the **Transpose Palette** buttons on the toolbar or the **Up Arrow/Down Arrow** keys.  
Transpose is also affected by the global transpose setting.
- To transpose note events via the **Transpose Setup** dialog, select the note events and select **MIDI > Transpose Setup**.
- To transpose note events in steps of one octave, press **Shift** and use the **Up Arrow/Down Arrow** keys.

### NOTE

- When you move selected note events to a different position, any selected controllers for these note events move accordingly.
- You can also adjust the position of note events by quantizing.

RELATED LINKS

[Transpose Setup Dialog](#) on page 608

## Resizing Note Events

Do one of the following:

- To resize the note event, position the **Object Selection** tool at the start or the end of a note event and drag the mouse cursor to the left or right.
- To apply time-stretching and note expression data to a controller that is associated with the note event that you resize, activate **Sizing Applies Time Stretch** for the **Object Selection** tool before you resize the note.
- To move the start or end positions of the selected notes in steps according to the **Length Quantize** value on the toolbar, use the **Trim Start/End** buttons on the **Nudge Palette**.
- Select the note and adjust its length on the info line.
- Select **Draw** and drag left or right within the note display to draw a note. The resulting note event length is a multiple of the **Length Quantize** value on the toolbar.
- Select **Trim** and cut off the end or the beginning of note events.

RELATED LINKS

[Setup Options](#) on page 876

[Value Editing Rules on the Info Line](#) on page 44

[Using the Trim Tool](#) on page 651

[Resizing Events with the Object Selection Tool - Sizing Applies Time Stretch](#) on page 180

## Using the Trim Tool

The **Trim** tool allows you to change the length of note events by cutting off the end or the beginning of notes. Using the **Trim** tool means moving the note-on or the note-off event for one or several notes to a position defined with the mouse.

---

PROCEDURE

1. Select **Trim** on the toolbar.  
The mouse pointer changes to a knife symbol.
2. To edit a single note, click it.  
The range between the mouse pointer and the end of the note is removed. Use the mouse note info on the status line to find the exact position for the trim operation.
3. To edit several notes, click and drag with the mouse across the notes.



By default, the **Trim** tool cuts off the end of notes. To trim the beginning of notes, press **Alt** while dragging. When dragged across several notes, a line is displayed. The notes are trimmed along this line. If you press **Ctrl/Cmd** while dragging, you get a vertical trim line, allowing you to set the same start or end time for all edited notes. You can change the **Trim** tool key commands in the **Preferences** dialog (**Editing—Tool Modifiers** page).

---

## Splitting Note Events

- To split the note at the position that you point, select **Split**, and click on a note.

If several notes are selected, they are all split at the same position. The snap setting is taken into account.

- To split all notes that are intersected by the project cursor position, select **Edit > Functions > Split at Cursor**.
- To split all notes that are intersected by the left or right locator at the locator positions, select **Edit > Functions > Split Loop**.

## Gluing Note Events

You can glue together note events of the same pitch.

- To glue note events, select **Glue** and click on a note event.  
The note event is glued together with the next note event of the same pitch. The result is a long note event that spans from the start of the first note to the end of the second note. The properties (velocity, pitch, etc.) of the first note event apply.

## Changing the Pitch of Chords

You can use the chord type buttons to change the pitch of chords.

---

### PROCEDURE

1. In the **Inspector**, open the **Chord Editing** section.
  2. In the note display, select the notes that you want to edit.  
If the chord is recognized, the root note, chord type, and tensions are indicated in the **Chord Type** field. This also works with arpeggiated notes.
  3. In the **Chord Editing** section, activate one of the **Triads** buttons or **4-Note Chords** buttons.  
The selected notes are transposed so that they fit the selected chord type.
  4. Use the **Up Arrow/Down Arrow** keys to change the pitch of the chord.
- 

## Changing the Voicing of Chords

---

### PROCEDURE

1. In the **Inspector**, open the **Chord Editing** section.
  2. In the note display, select the notes that you want to edit.
  3. In the **Chord Editing** section, use the **Inversions** buttons and the **Drop Notes** buttons to change the voicing.
- 

### RESULT

The selected notes are transposed so that they fit the selected chord type.

## Chord Editing Section

The **Chord Editing** section in the **Inspector** allows you to insert and edit chords, and change voicings.

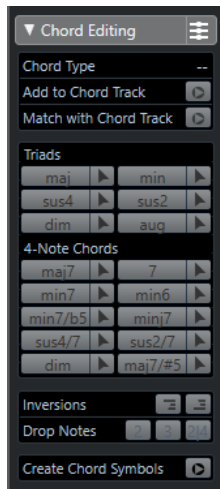

### Chord Type

Shows the chord type of the selected chords.

### Add to Chord Track

Adds the chord indicated in the **Chord Type** field to the chord track. The chord event is inserted at the position on the chord track that corresponds to the position of the MIDI notes. Any existing chord events at this position are overwritten.

### Match with Chord Track

Applies the chord events from the chord track to the selected notes in the MIDI editor. The chord event that is effective at the position of the first selected note is applied to the selected notes, which are then transposed. Only the basic chord type is applied. Tensions are not taken into account.

Only the first effective chord event is applied.

### Triads

Allows you to insert triads to the note display. You can also click one of the **Triads** buttons to transpose the selected notes so that they fit to the selected chord type.

### 4-Note Chords

Allows you to insert 4-note chords to the note display. You can also click one of the **4-Note Chords** buttons to transpose the selected notes so that they fit to the selected chord type.

### Inversions - Move highest note to bottom



Inverts the highest note of a chord. The corresponding notes are transposed by as many octaves as needed.

### Inversions - Move lowest note to top



Inverts the lowest note of a chord. The corresponding notes are transposed by as many octaves as needed.

### Drop Notes - Move the second highest note an octave lower



Moves the second highest note of a chord down by one octave.

### Drop Notes - Move the third highest note an octave lower



Moves the third highest note of a chord down by one octave.

### Drop Notes - Move the second and fourth highest notes an octave lower



Moves the second and fourth highest notes of a chord down by one octave.

### Create Chord Symbols

Performs a chord analysis of the selected notes. If nothing is selected, the whole MIDI part is analyzed.

## Inserting Chords

You can use the tools in the **Chord Editing** section of the **Inspector** to insert and edit chords.

---

### PROCEDURE

1. In the **Inspector**, open the **Chord Editing** section.
  2. Select the **Insert** tool  to the right of the chord type that you want to insert.
  3. Click in the note display and drag to the left or right to determine the length of the chord. Drag up or down to determine its pitch.  
To change the chord type while you insert chords, hold **Alt** and drag up or down.  
If **Acoustic Feedback** is activated, you hear the chord while dragging. A tooltip indicates the root note and chord type of the inserted chord. **Snap** and **Length Quantize** are taken into account.
- 

## Applying Chord Events to Note Events

You can apply chord events from the chord track to notes in the MIDI editor.

### PREREQUISITE

Create a chord track and add chord events.

---

### PROCEDURE

1. Open the MIDI editor.
  2. In the **Inspector**, open the **Chord Editing** section.
  3. Select **Match with Chord Track**.
- 

### RESULT

The first chord event of the chord track is applied to the selected notes. Only the basic chord type is applied. Tensions are not taken into account.

## Drum Map Handling

When a drum map is assigned to a MIDI or instrument track, the **Key Editor** displays the drum sound names as defined by the drum map. This allows you to use the **Key Editor** for drum editing, for example, when editing drum note lengths or when editing several parts to identify drum events.

The name of the drum sound is displayed in the following locations:

- On the info line in the **Pitch** field.
- On the status line in the **Mouse Note Position** field.

- In the note event if the zoom factor is high enough.
- When dragging a note event.

## Editing Note Events via MIDI Input

You can directly hear your editing results. Editing the properties of note events via MIDI can be a quick way to, for example, set the velocity value of a note event.

---

### PROCEDURE

1. In the **Key Editor**, select the note event that you want to edit.
  2. Click **MIDI Input** on the toolbar.  
Editing via MIDI is enabled.
  3. Use the note buttons on the toolbar to decide which properties are changed by the MIDI input.  
You can enable editing of pitch, note-on and/or note-off velocity. For example, you can get the pitch and velocity values of the notes input via MIDI, but the note-off velocities remain as they are.
  4. Play a note on your MIDI instrument.
- 

### RESULT

The selected note gets the pitch, note-on velocity and/or note-off velocity of the played note. The next note in the edited part is automatically selected to allow quick editing of a series of notes.

### AFTER COMPLETING THIS TASK

To try another setting, select the note again and play a note on your MIDI instrument.

## Step Input

Step input, or step recording, allows you to enter note events or chords one at a time without worrying about the exact timing. This is useful, for example, when you know the part that you want to record but are not able to play it exactly as you want it.

---

### PROCEDURE

1. On the toolbar, activate **Step Input**.
2. Use the note buttons to the right to determine which properties are included when you insert the note events.  
For example, you can include the note-on velocity and/or note-off velocity of the played notes. You can also deactivate the pitch property, in which case all notes get a pitch C3, no matter what you play.
3. Click anywhere in the note display to set the start position of the first note event or chord.  
The step input position is shown as a vertical line in the note display.

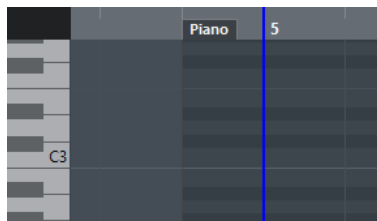

4. Specify the note event spacing and length with the **Quantize** and **Length Quantize** pop-up menus.  
The note events that you insert are positioned according to the **Quantize** value and have the length of the **Length Quantize** value.

NOTE

If **Length Quantize** is set to **Quantize Link**, the note length is also determined by the **Quantize** value.

---

5. Play the first note event or chord on your MIDI instrument.  
The note event or chord appears in the editor and the step input position advances by one quantize value step.

NOTE

If **Move Insert Mode** is activated, all note events to the right of the step input position are moved to make room for the inserted note event or chord.

---

6. Continue in the same way with the rest of the note events or chords.  
You can adjust the **Quantize** or **Length Quantize** values to change the timing or note event lengths. You can also move the step input position manually by clicking anywhere in the note display.  
To insert a rest, press the **Right Arrow** key. This advances the step input position by one step.
  7. When you are done, click **Step Input** again to deactivate step input.
- 

## Score Editor

The basic **Score Editor** shows MIDI notes as a musical score. This offers basic score editing and printing options.

You can open the **Score Editor** in a separate window or in the lower zone of the **Project** window. Opening the **Score Editor** in the lower zone of the **Project** window is useful if you want to access the **Score Editor** functions from within a fixed zone of the **Project** window.

To open a MIDI part in the **Score Editor**, do one of the following:

- Select a MIDI part in the **Project** window and select **MIDI > Scores > Open Score Editor**.
- Select a MIDI part in the **Project** window and press **Ctrl/Cmd-R**.

NOTE

If you select **MIDI > Set up Editor Preferences**, the **Preferences** dialog opens on the **Editors** page. Make your changes to specify if you want editors to open in a separate window or in the lower zone of the **Project** window.

---

The **Score Editor** window:



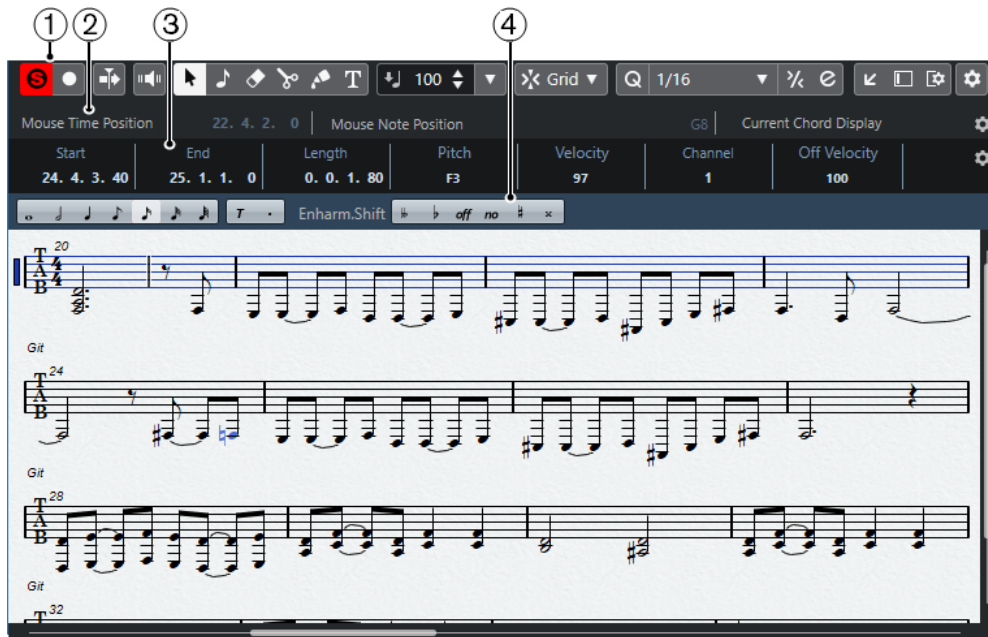

The **Score Editor** in the lower zone of the **Project** window:

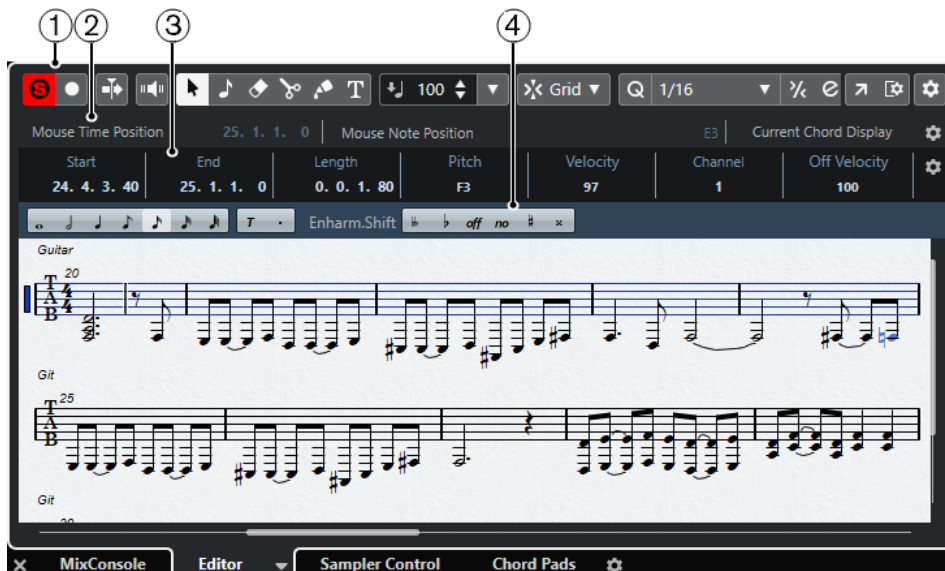

The **Score Editor** is divided into several sections:

- 1 **Toolbar**  
Contains tools and settings.
  - 2 **Status line**  
Informs about the mouse time position, the mouse note position, and the current chord.
  - 3 **Info line**  
Displays note event information about a selected MIDI note.
  - 4 **Extended toolbar**  
Contains note value buttons and enharmonic shift buttons.
- To open one or several parts in the **Score Editor**, select one or several tracks or any number of parts, and select **MIDI > Open Score Editor**.  
If you have selected parts on several tracks, you get one staff for each track. The staves are tied together by barlines and placed in the order of the tracks in the **Project** window.

- To rearrange the staves, close the editor and in the **Project** window, rearrange the tracks. Then reopen the **Score Editor**.

#### NOTE

You can activate/deactivate the status line, the info line, the tools, and the filters by clicking **Set up Window Layout** on the toolbar and activating/deactivating the corresponding options.

---

## Score Editor Toolbar

The toolbar contains tools and various settings for the **Score Editor**.

- To show or hide the toolbar elements, right-click the toolbar and activate or deactivate the elements.

### Edit Solo

#### Solo Editor



Solos the editor during playback if the editor has the focus.

#### Record in Editor



Enables the recording of MIDI data in the editor if the editor has the focus.

#### NOTE

This only works if **MIDI Record Mode** is set to **Merge** or **Replace**.

---

## Retrospective Record

### Insert MIDI Retrospective Recording in Editor



Allows you to recover MIDI notes that you played in stop mode or during playback.

## Left Divider

### Left Divider



Tools that are placed to the left of the divider are always shown.

## Auto-Scroll

### Auto-Scroll



Keeps the project cursor visible during playback.

## Acoustic Feedback

### Acoustic Feedback



Automatically plays back events when you move or transpose them, or when you create them by drawing.

## Tool Buttons

### Object Selection



Selects events and parts.

### Insert Note



Inserts notes.

### Erase



Deletes events.

### Split



Splits events.

### Glue



Glues together events of the same pitch.

### Insert Text



Inserts text.

## Insert Velocity

### Note Insert Velocity



Allows you to specify a velocity value for new notes.

## Snap

### Snap Type



Allows you to select one of the following snap types:

- **Grid** snaps events to the grid that is selected in the **Quantize Presets** pop-up menu.
- **Grid Relative** keeps the relative positions when snapping events to the grid.

## Quantize

### Apply Quantize



Applies the quantize settings.

### Quantize Presets



Allows you to select a quantize or a groove preset.

### Iterative Quantize On/Off



Activates/Deactivates iterative quantize.

### Open Quantize Panel



Opens the **Quantize Panel**.

### Length Quantize

#### Length Quantize

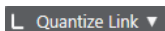

Allows you to set a value for quantizing event lengths.

### Step/MIDI Input

#### Computer Keyboard Input



Activates/Deactivates computer keyboard input.

#### Step Input



Activates/Deactivates MIDI step input.

#### MIDI Input



Activates/Deactivates MIDI input and note expression MIDI input.

#### Move Insert Mode



Moves all note events to the right of the step input position to the right to make room for the inserted event when you insert notes.

**NOTE**

This only works if **Step Input** is activated.

---

#### Record Pitch



Includes the pitch when you insert notes.

#### Record NoteOn Velocity



Includes the NoteOn velocity when you insert notes.

#### Record NoteOff Velocity



Includes the NoteOff velocity when you insert notes.

### Right Divider

#### Right Divider



Allows you to use the right divider. Tools that are placed to the right of the divider are always shown.

## Window Zone Controls

### Open in Separate Window



This button is available in the **Editor** tab in the lower zone. It opens the editor in a separate window.

### Open in Lower Zone



This button is available in the editor window. It opens the **Editor** tab in the lower zone of the **Project** window.

### Show/Hide Left Zone



Shows/Hides the left zone.

### Set up Window Layout



Allows you to set up the window layout.

### Set up Toolbar



Opens a pop-up menu where you can set up which toolbar elements are visible.

## Status Line

The status line is displayed below the toolbar. It shows important information about the mouse position and the chord display. Select the notes that form (compose) the chord to make the status line appear in the **Current Chord Display**.

- To show or hide the status line, click **Set up Window Layout** on the toolbar, and activate or deactivate **Status Line**.

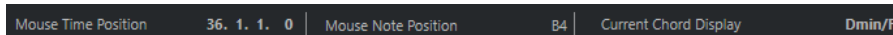

The on/off status of the status line in the **Score Editor** window and in the **Editor** tab in the lower zone of the **Project** window are independent of each other.

### Mouse Time Position

Displays the exact time position of the mouse pointer, depending on the selected ruler display format. This lets you edit or insert notes at exact positions.

### Mouse Note Position

Displays the exact pitch of the mouse pointer position. This facilitates finding the right pitch when entering or transposing notes.

### Current Chord Display

When the project cursor is positioned over notes that form a chord, this chord is displayed here.

## Info Line

The info line shows values and properties of the selected MIDI notes. If several notes are selected, the values for the first note are displayed in color.

- To show or hide the info line, click **Set up Window Layout** on the toolbar, and activate or deactivate **Info Line**.

Start	End	Length	Pitch	Velocity	Channel	Off Velocity	Release Length	Voice	Text
24. 4. 3. 40	25. 1. 1. 0	0. 0. 1. 80	F3	97	1	100	0. 0. 0. 0	--	

The on/off status of the info line in the **Score Editor** window and in the **Editor** tab in the lower zone of the **Project** window are independent of each other.

#### RELATED LINKS

[Changing the Ruler Display Format](#) on page 618

## Score Editor Extended Toolbar

The extended toolbar contains note value buttons and enharmonic shift buttons.

- To show the extended toolbar, click **Set up Window Layout** on the toolbar, and activate **Tools**.

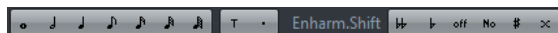

### Note Value Buttons

Allows you to select a note value for input. The and options are for triplet and dotted note values.

The selected note value is displayed in the **Length** value field on the info line.

To resize all selected notes to the same note value, press **Ctrl/Cmd** and click one of the note value buttons.

### Enharmonic Shift

Allows you to manually select whether a note is displayed with flat or sharp accidentals. The **Off** button resets the notes to original display. The other options are **double flats**, **flats**, **No** (no accidentals shown, regardless of pitch), **sharps**, and **double sharps**.

#### RELATED LINKS

[Enharmonic Shift](#) on page 668

## Score Display

The main area of the **Score Editor** window shows the notes in the edited parts on one or several staves. Parts on different tracks are shown on different staves.



- If you are editing one or several parts on the same track, as much of them as possible is shown on several staves, comparable with a score on paper.
- If you are editing parts on several tracks, they are put on a grand staff. A grand staff is composed of multiple staves that are tied together by barlines.
- The number of bars that are displayed on the screen depends on the size of the window and the number of notes in each bar.
- The end of the last part is indicated by a double barline.

All MIDI input is directed to one of the tracks, which is called the active staff. The active staff is indicated by a rectangle to the left of the clef symbol.

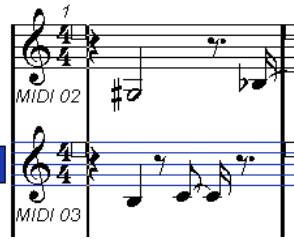

- To change the active staff, click on the staff that you want to activate.

## Score Editor Operations

This section describes the principal editing operations within the **Score Editor**.

### Improving the Score Display

When you open the **Score Editor** for a part that was recorded in real time, the score may not look as legible as you expect. The **Score Editor** can ignore the minor time variances in performance and make a neater score. To achieve this, the **Staff Settings** dialog provides settings that determine how the program displays the music.

### Staff Settings Dialog

This dialog allows you to change how Cubase displays the music.

#### IMPORTANT

The settings that you make in this dialog are independent for each staff (track), but common for a piano staff that you have created with the **Split** option.

To open the **Staff Settings** dialog, do one of the following:

- Select a staff and select **MIDI > Scores > Staff Settings**.
- Double-click in the area to the left of the staff.

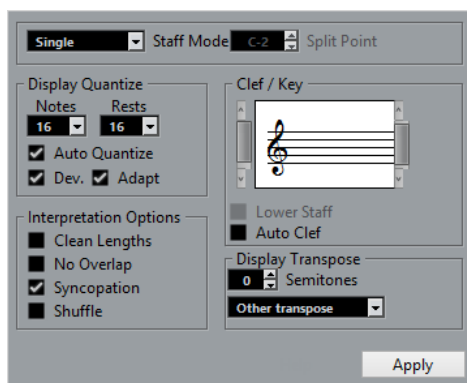

#### NOTE

The time signature follows the time signatures that are set in the **Tempo Track** editor. These settings are common to all tracks/staves in the score.

### Staff Mode

The **Staff Mode** determines how the staff is shown.

- In **Single** mode, all notes in the part are shown in the same staff.

- In **Split** mode, the part is split on the screen into a bass and treble clef, as in a piano score. The **Split Point** value determines where you want the split to occur. Notes above and including the split note appear on the upper staff, and notes below the split note appear on the lower staff.

## Display Quantize

This section allows you to change the way Cubase displays scores.

### IMPORTANT

These display values are only used for the graphical display in the **Score Editor**. They do not affect the playback.

---

#### Notes

Determines the smallest note value to be displayed and the smallest position to be recognized and properly displayed. Set this to the smallest significant note position used in your music.

For example, if you have notes on odd 16th note positions, set this value to 16. The **T** values are for triplet note values. This setting is partly overridden by **Auto Quantize**.

#### Rests

This value is used as a recommendation. Cubase does not display rests smaller than this value, except where necessary. In effect, this setting also determines how the length of notes is displayed. Set this value according to the smallest note value (length) that you want to be displayed for a single note, positioned on a beat.

#### Auto Quantize

Allows you to make your score look as legible as possible. **Auto Quantize** allows you to mix straight notes with tuplets (triplets) in a part. However, **Auto Quantize** also uses the (display) quantize value. If there is no appropriate note value for a certain note or group of notes, it uses the set quantize value is used to display it.

Generally, only activate this option if your music contains mixed triplets and straight notes. If the part is imprecisely played and/or complex, **Auto Quantize** may have a problem figuring out exactly what you mean.

#### Dev.

If this option is activated, triplets/straight notes are detected even if they are not exactly on the beat. However, if you know that your triplets/straight notes are perfectly recorded, either through quantizing or entered by hand, deactivate this option.

This option is only available if **Auto Quantize** is activated.

#### Adapt

If this option is activated, the program guesses that when one triplet is found, there are probably more triplets surrounding it. Activate this option if not all of your triplets are detected.

This option is only available if **Auto Quantize** is activated.

## Clef/Key

In this section, you can set the correct clef and key.

### Clef/Key display

Allows you to select the clef or key via the scrollbar.

### Lower Staff

Sets the clef and key to the lower staff.



### Auto Clef

If this option is activated, Cubase attempts to guess the correct clef, judging from the pitch of the music.

### Display Transpose

In this section, you can specify a separate display transpose setting for each staff (track). This transposes the notes in the score without affecting how the notes are played back. This allows you to record and play back a multi staff arrangement and still score each instrument according to its own transposition.

### Semitones

Allows you to manually set a display transpose value.

### Instrument

Allows you to select the instrument for which you are scoring.

## Interpretation Options

In this section, you can make additional settings on how the score is displayed.

### Clean Lengths

If this option is activated, notes that are considered to be chords are shown with identical lengths. Longer notes are displayed shorter than they are. Notes with very short overlaps are also cut off. This is similar to the **No Overlap** option, but with a more subtle effect.

### No Overlap

If this option is activated, one note is never shown as overlapping another, lengthwise. This allows long and short notes that start at the same point to be displayed without ties. The long notes are cut off in the display. This makes the music more legible.

A sample measure with **No Overlap** deactivated:



A sample measure with **No Overlap** activated:



### Syncopation

If this option is activated, syncopated notes are shown in a more legible way.

A dotted quarter note at the end of a bar when **Syncopation** is deactivated:

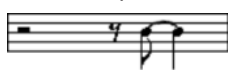

A dotted quarter note at the end of a bar when **Syncopation** is activated:

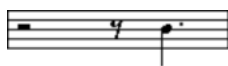

### Shuffle

If this option is activated and you have played a shuffle beat, the beat is displayed as straight notes, not as triplets. This is very common in jazz notation.

## Quantize Value

When you move the mouse pointer over the score, the **Mouse Time Position** field on the status line tracks your movement and shows the current position in bars, beats, 16th notes, and ticks.

The quantize value controls the positioning on screen. If you set the value to 1/8, you can only insert and move notes to 8th note positions, at quarter notes, at half bars, or at bar positions.

It is recommended to set the quantize value to the smallest note value in the piece. This does not stop you from inputting notes at coarser positions. However, if you set the quantize value to a too small note value, it is easier to make mistakes.



With the quantize value set to 1/8, you can only input notes at 8th note positions.

You can also use the **Quantize Panel** to create other quantize values, irregular grids, etc.

## Creating Notes

In the score display, the **Insert Note** tool allows you to create notes.

### PREREQUISITE

You have set the note value (length) and spacing.

---

### PROCEDURE

1. Set the note value in one of the following ways:
  - Click the note symbols on the extended toolbar.
  - Select an option from the **Length Quantize** pop-up menu on the toolbar.
2. Select the **Insert Note** tool.  
If you selected the note value via the extended toolbar buttons, the **Insert Note** tool is automatically selected.
3. Open the **Quantize Presets** pop-up menu on the toolbar and select a quantize value.
4. Move the mouse over the staff to find the correct position.  
The **Mouse Note Position** display on the status line shows the pitch at the pointer position. The position is displayed on the **Mouse Time Position** display on the status line.
5. Click in the staff.  
When you click and hold down the mouse button, the bars and beats positions are shown. This allows you to find the correct position.

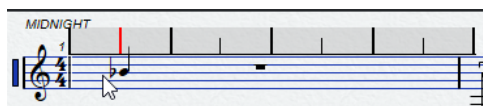

### NOTE

The position snaps to the grid that is defined by the quantize value.

---

### RESULT

The note appears in the score. The notes get the insert velocity value that is set in the **Note Insert Velocity** field on the toolbar.

#### NOTE

If the notes that you enter appear to have the wrong note value, you may have to adjust the **Display Quantize** settings. For example, if you entered a 1/32 note that is displayed as a 1/16 note.

---

#### RELATED LINKS

[Setting Velocity Values](#) on page 623

[Display Quantize](#) on page 664

## Moving and Transposing Notes

---

#### PROCEDURE

1. Open the **Quantize Presets** pop-up menu on the toolbar and select a quantize value.
  2. If you want to hear the pitch of the note while moving, activate **Acoustic Feedback** on the toolbar.
  3. Select the notes that you want to move.
  4. Click one of the selected notes and drag it to a new position and/or pitch.  
The horizontal movement of the note snaps to the current quantize value. The position boxes on the toolbar show the position and pitch for the dragged note.  
To restrict moving to one direction, press **Ctrl/Cmd** while dragging.
- 

## Duplicating Notes

---

#### PROCEDURE

1. Open the **Quantize Presets** pop-up menu on the toolbar and select a quantize value.
  2. Select the notes that you want to duplicate.
  3. Press **Alt** and drag the notes to their new position.  
To restrict moving to one direction, press **Ctrl/Cmd** while dragging.
- 

## Changing the Note Length

The displayed note length is not necessarily the actual note length. It also depends on the note values and rest values for **Display Quantize** in the **Staff Settings** dialog. This is important to remember when you change the length of a note.

You can change the length of a note in the following ways:

- Select the notes that you want to change and **Ctrl/Cmd**-click on one of the note icons on the extended toolbar.  
All the selected notes are assigned to the length of the clicked note.
- Select the notes that you want to change and edit the length values on the info line.

#### RELATED LINKS

[Improving the Score Display](#) on page 663

[Editing Note Events on the Info Line](#) on page 623

## Splitting and Gluing Note Events

- To split 2 notes that are strung together by a tie, click on the tied note head with the **Split** tool.

- The note is split into 2, with the respective length of the main and the tied note.
- To glue a note to the next note with the same pitch, click on a note with the **Glue** tool.

## Enharmonic Shift

You can perform an enharmonic shift on notes that are not displayed with the accidentals you wish.

---

### PROCEDURE

1. Select the notes that you want to shift.
  2. Click one of the enharmonic shift buttons on the extended toolbar.
- 

### RELATED LINKS

[Score Editor Extended Toolbar](#) on page 662

## Flipping Stems

The direction of the note stems is automatically selected according to the note pitches. However, you can change this manually.

---

### PROCEDURE

1. Select the notes for which you want to flip the stem direction.
  2. Select **MIDI > Scores > Flip Stems**.
- 

## Working with Text

You can use the **Text** tool to add comments, articulation, or instrumentation advice and other text strings anywhere in the score display.

### Adding Text

---

#### PROCEDURE

1. On the toolbar, select the **Text** tool.
  2. Click anywhere in the score.  
A blinking cursor indicates that you can enter text.
  3. Enter the text and press **Return**.
- 

### Editing Text

- To edit existing text, double-click it with the **Object Selection** tool.  
This opens the text for editing. Use the **Up Arrow**, **Down Arrow**, **Left Arrow**, and **Right Arrow** keys to move the cursor, delete characters with the **Delete** or **Backspace** keys, press **Return** when you are finished.
- To delete text blocks, select them with the **Object Selection** tool and press **Backspace** or **Delete**.
- To move text blocks, drag them to a new position.
- To duplicate text blocks, press **Alt** and drag them to a new position.

## Changing the Text Font, Size, and Style

You can change the font, size, and style of the text that you have added to the score display.

---

### PROCEDURE

1. Do one of the following:
    - To change the settings for a specific text block, click on the text with the **Object Selection** tool.
    - To set the default settings for all new text blocks, unselect any selected text block and change the settings.
  2. Select **MIDI > Scores > Set Font**.
  3. In the **Font Settings** dialog, make your changes.
  4. Click **Apply**.
  5. Optional: Select another text block, adjust the settings, and click **Apply**.
- 

## Set Font Dialog

In this dialog, you can change the font, size, and style of the text that you have added to the score display.

- To open the **Set Font** dialog, select **MIDI > Scores > Set Font**.

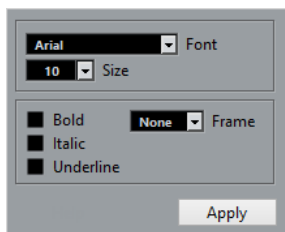

### Font

Allows you to specify the font for the text. Which fonts are available on the pop-up menu depends on the fonts that you have installed on your computer.

#### IMPORTANT

Do not use the Steinberg fonts. These are special fonts used by the program, for example, for score symbols, and not suited for common text.

---

### Size

Sets the size of the text.

### Frame

Allows you to enclose the text in a rectangular (box) or oval frame.

### Font options

Determine whether the text is formatted bold, italic, and/or underlined.

## Printing the Score

---

### PROCEDURE

1. Open the parts that you want to print in the **Score Editor**.
2. Select **File > Page Setup** and make sure that all your printer settings are correct.

**IMPORTANT**

If you change your setting for paper size, scale, and margins now, the score may change its look.

---

3. Click **OK**.
  4. Select **File > Print**.
  5. In the **Print** dialog, make your changes.
  6. Click **Print**.
- 

## Drum Editor

The **Drum Editor** is the editor to use when you are editing drum or percussion parts.

You can open the **Drum Editor** in a separate window or in the lower zone of the **Project** window. Opening the **Drum Editor** in the lower zone of the **Project** window is useful if you want to access the **Drum Editor** functions from within a fixed zone of the **Project** window.

To open a MIDI part in the **Drum Editor**, do one of the following:

- Select a MIDI part in the **Project** window and select **MIDI > Open Drum Editor**.

If the MIDI track has a drum map assigned and **Editor Content Follows Event Selection** and **Use Drum Editor when Drum Map is assigned** are activated in the **Preferences** dialog (**Editors** page), you can do the following to open a MIDI part in the **Drum Editor**:

- Double-click a MIDI part in the **Project** window.
- Select a MIDI part in the **Project** window and press **Return** or **Ctrl/Cmd-E**.
- Select a MIDI part in the **Project** window and select **MIDI > Open Drum Editor**.
- In the **Key Commands** dialog in the **Editors** category, assign a key command for **Open Drum Editor**. Select a MIDI part in the **Project** window and use the key command.

**NOTE**

If you select **MIDI > Set up Editor Preferences**, the **Preferences** dialog opens on the **Editors** page. Make your changes to specify if you want the **Drum Editor** to open in a separate window or in the lower zone of the **Project** window.

---

The **Drum Editor** window:

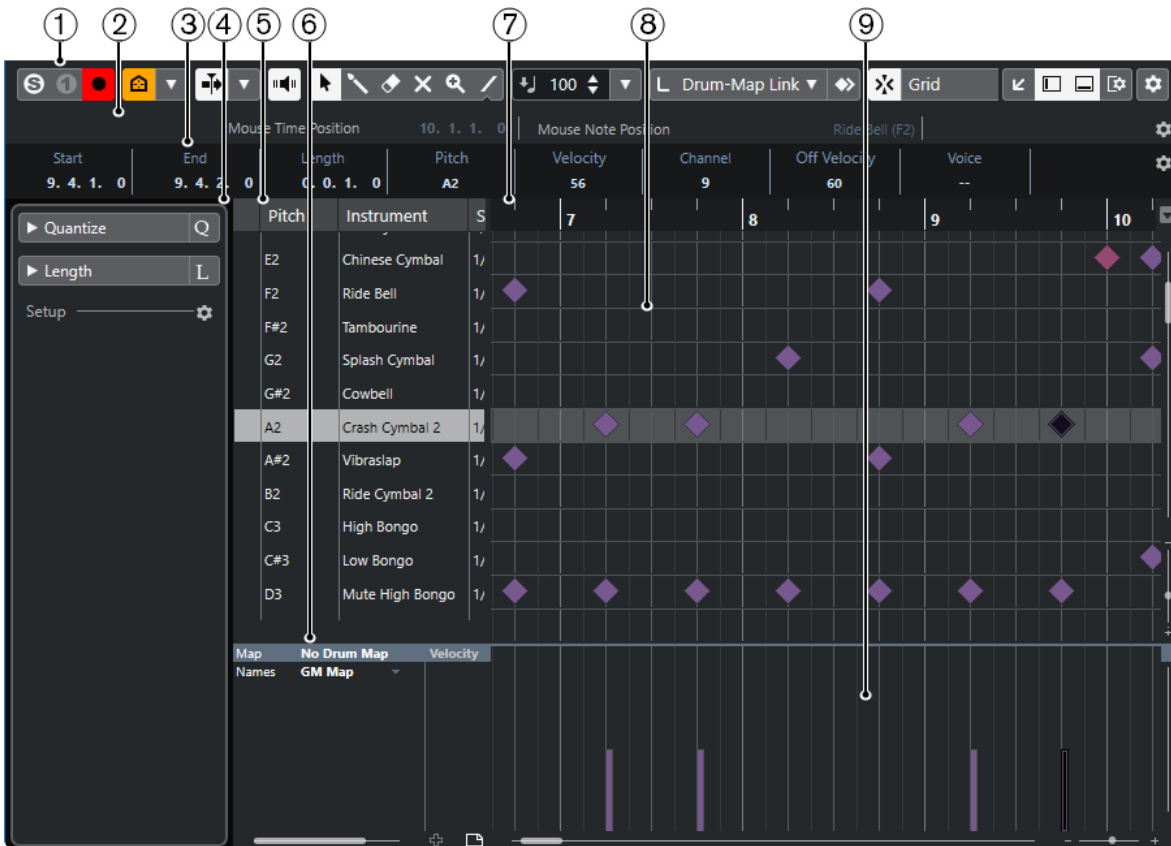

The **Drum Editor** is shown in the **Editor** tab in the lower zone of the **Project** window:

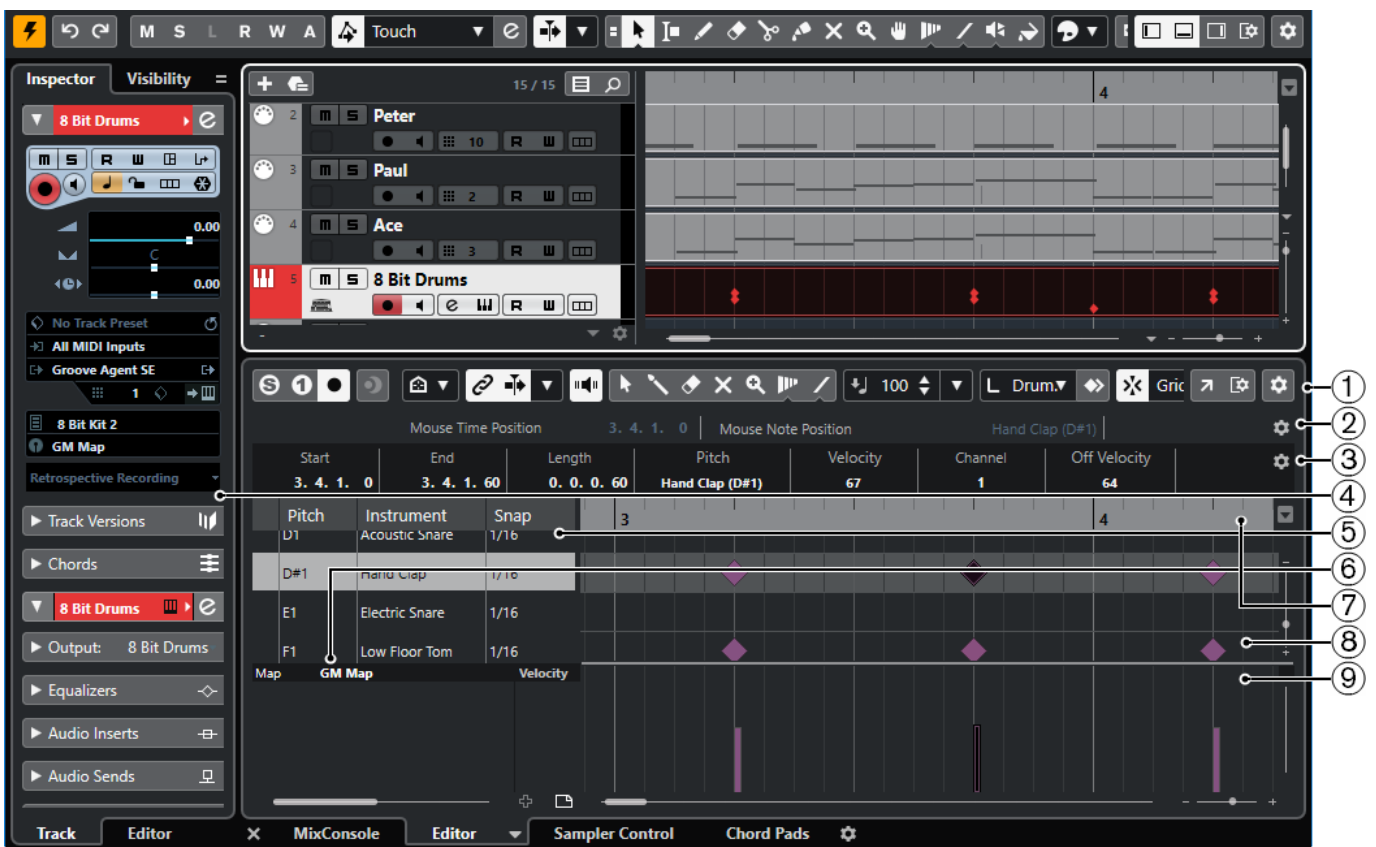

The **Drum Editor** is divided into several sections:

- 1 Toolbar**  
Contains tools and settings.
- 2 Status line**  
Informs about the mouse time position and the mouse note position.
- 3 Info line**  
Displays information about the selected event.
- 4 Inspector**  
Contains tools and functions for working with MIDI data.
- 5 Drum sound list**  
Lists all drum sounds.
- 6 Drum map**  
Lets you select the drum map for the edited track or a list of drum sound names.
- 7 Ruler**  
Displays the time line.
- 8 Note display**  
Contains a grid in which notes are displayed.
- 9 Controller display**  
The area below the note display consists of one or multiple controller lanes.

#### NOTE

You can activate/deactivate the status line, the info line, and the controller lanes by clicking **Set up Window Layout** on the toolbar and activating/deactivating the corresponding options.

---

## Drum Editor Toolbar

The toolbar contains tools and various settings for the **Drum Editor**.

- To show or hide the toolbar elements, right-click the toolbar and activate or deactivate the elements.

### Retrospective Record

#### Insert MIDI Retrospective Recording in Editor



Allows you to recover MIDI notes that you played in stop mode or during playback.

### Left Divider

#### Left Divider

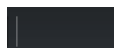

Allows you to use the left divider. Tools that are placed to the left of the divider are always shown.

### Drum Sound Visibility

#### Drum Visibility Agents



Allows you to determine which drum sounds are displayed in the drum sound list.



## Auto-Scroll

### Link Project and Lower Zone Editor Cursors



Links timelines, cursors, and zoom factors of the **Editor** tab in the lower zone and the **Project** window.

#### NOTE

You cannot activate **Link Project and Lower Zone Editor Cursors** if **Independent Track Loop** is active.

---

### Auto-Scroll



Keeps the project cursor visible during playback.

### Select Auto-Scroll Settings



Allows you to activate **Page Scroll** or **Stationary Cursor** and to activate **Suspend Auto-Scroll When Editing**.

## Acoustic Feedback

### Acoustic Feedback



Automatically plays back events when you move or transpose them, or when you create them by drawing.

## Tool Buttons

### Object Selection



Selects events and parts.

### Drumstick



Draws drum events.

### Erase



Deletes events.

### Mute



Mutes events.

### Zoom



Zooms in. Hold **Alt** and click to zoom out.

### Line



Creates a series of contiguous events.

## Auto Select Controllers

### Auto Select Controllers



Automatically selects controller data of the selected MIDI notes.

## Independent Track Loop

### Independent Track Loop



Activates/Deactivates the independent track loop.

### NOTE

If you activate **Independent Track Loop**, the **Link Project and Lower Zone Editor Cursors** function is automatically deactivated in the **Editor** tab in the lower zone.

---

## Nudge Palette

### Trim Start Left



Increases the length of the selected event by moving its start to the left.

### Trim Start Right



Decreases the length of the selected event by moving its start to the right.

### Move Left



Moves the selected event to the left.

### Move Right



Moves the selected event to the right.

### Trim End Left



Decreases the length of the selected event by moving its end to the left.

### Trim End Right



Increases the length of the selected event by moving its end to the right.

## Transpose Palette

### Move Up



Transposes the selected event up by a half note.

### Move Down



Transposes the selected event down by a half note.

### Move Up More



Transposes the selected event up by an octave.

#### Move Down More



Transposes the selected event down by an octave.

### Insert Velocity

#### Note Insert Velocity

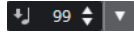

Allows you to specify a velocity value for new notes.

### Notes Length

#### Insert Length

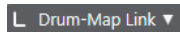

Allows you to determine a length for newly created notes.

#### Show Note Length On/Off



Shows drum notes as boxes that display the note length.

### Snap

#### Snap On/Off



Activates/Deactivates the **Snap** function.

#### Snap Type



Allows you to select one of the following snap types:

- **Grid** snaps events to the grid that is selected in the **Quantize Presets** pop-up menu.
- **Grid Relative** keeps the relative positions when snapping events to the grid.
- **Events** snaps events to the start or end of other events.
- **Shuffle** changes the order of events if you drag one event to the left or right of other events.
- **Cursor** snaps events to the cursor position.
- **Grid + Cursor** snaps events to the quantize grid that is selected in the **Quantize Presets** pop-up menu or to the cursor position.
- **Events + Cursor** snaps events to the start or end of other events, or to the cursor position.
- **Grid + Events + Cursor** snaps events to the quantize grid that is selected in the **Quantize Presets** pop-up menu, to the start or end of other events or to the cursor position.

#### Grid Type



Allows you to select one of the following grid types:

- **Use Quantize** activates a grid where events snap to the value that is selected in the **Quantize Presets** pop-up menu.
- **Adapt to Zoom** activates a grid where events snap to the zoom level.

- **Use Snap from Drum Map** activates a grid where events snap to the **Snap** value that is selected in the drum map.

## Quantize

### Apply Quantize



Applies the quantize settings.

### Quantize Presets



Allows you to select a quantize or a groove preset.

### Iterative Quantize On/Off



Activates/Deactivates iterative quantize.

### Open Quantize Panel



Opens the **Quantize Panel**.

## Multiple Part Controls

### Show Part Borders



Shows/Hides part borders for the active MIDI part within the left and right locators.

### Edit Active Part Only



Restricts editing operations to the active part.

### Currently Edited Part

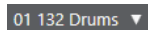

Lists all parts that were selected when you opened the editor, and allows you to activate a part.

## Event Colors

### Event Colors

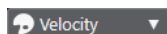

Allows you to select event colors.

## Step/MIDI Input

### Step Input



Activates/Deactivates MIDI step input.

### MIDI Input/Note Expression MIDI Input



Activates/Deactivates MIDI input and note expression MIDI input.

### Move Insert Mode



Moves all note events to the right of the step input position to the right to make room for the inserted event when you insert notes.

#### NOTE

This only works if **Step Input** is activated.

---

### Record Pitch



Includes the pitch when you insert notes.

### Record NoteOn Velocity



Includes the NoteOn velocity when you insert notes.

### Record NoteOff Velocity



Includes the NoteOff velocity when you insert notes.

## Edit VST Instrument

### Edit VST Instrument



Opens the VST instrument that the track is routed to.

## Right Divider

### Right Divider



Allows you to use the right divider. Tools that are placed to the right of the divider are always shown.

## Window Zone Controls

### Open in Separate Window



This button is available in the **Editor** tab in the lower zone. It opens the editor in a separate window.

### Open in Lower Zone



This button is available in the editor window. It opens the **Editor** tab in the lower zone of the **Project** window.

### Show/Hide Left Zone



Shows/Hides the left zone.

### Show/Hide Controller Lanes



Shows/Hides the controller lanes.

### Set up Window Layout



Allows you to set up the window layout.

## Set up Toolbar



Opens a pop-up menu where you can set up which toolbar elements are visible.

### RELATED LINKS

[Zooming in MIDI Editors](#) on page 619

## Status Line

The status line is displayed below the toolbar. It displays important mouse information.

- To show the status line, click **Set up Window Layout** on the toolbar, and activate **Status Line**.

The on/off status of the status line in the **Drum Editor** window and in the **Editor** tab in the lower zone of the **Project** window are independent of each other.

### Mouse Time Position

Displays the exact time position of the mouse pointer, depending on the selected ruler display format. This lets you edit or insert notes at exact positions.

### Mouse Note Position

Displays the exact pitch of the mouse pointer position. This facilitates finding the right pitch when entering or transposing notes.

### Track Loop Start/Track Loop End

If **Independent Track Loop** is activated on the toolbar and you set up a loop, the start/end position is displayed.

### RELATED LINKS

[Drum Editor Toolbar](#) on page 672

## Info Line

The info line shows values and properties of the selected events. If several notes are selected, the values for the first note are displayed in color.

- To show the info line, click **Set up Window Layout** on the toolbar, and activate **Info Line**.

Start	End	Length	Pitch	Velocity	Channel
6. 4. 1. 0	6. 4. 2. 0	0. 0. 1. 0	Vibraslap (Bb2)	56	10
Off Velocity	Articulations	Release Length	Voice	Text	
60	None	0. 0. 0. 0	--		

Length and position values are displayed in the selected ruler display format.

The on/off status of the info line in the **Drum Editor** window and in the **Editor** tab in the lower zone of the **Project** window are independent of each other.

### RELATED LINKS

[Editing Note Events on the Info Line](#) on page 623

## Drum Editor Inspector

The **Inspector** is located to the left of the note display. The **Inspector** contains tools and functions for working with MIDI data.

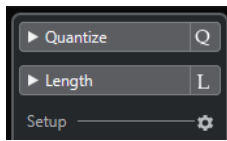

### Quantize

Allows you to access the main quantize parameters. These are identical with the functions on the **Quantize Panel**.

### Length

Contains length-related options, similar to the **Functions** submenu of the **MIDI** menu.

- To change the length of the selected MIDI events or all events of the active part if no events are selected, use the **Scale Length/Scale Legato** slider. At the maximum value the notes reach the beginning of the next note.
- To make the new length settings permanent, click **Freeze MIDI Lengths** to the right of the **Scale Length/Scale Legato** slider.
- To fine-tune the distance between consecutive notes, use the **Overlap** slider. At **0 Ticks**, the **Scale Length/Scale Legato** slider extends each note so that it reaches the next note exactly. Positive values cause the notes to overlap and negative values allow you to define a small gap between the notes.
- To use the **Legato** function or slider to extend a note until the next selected note, activate **Between Selected**. This is identical with activating the **Legato Mode: Between Selected Notes Only** option in the **Preferences** dialog.

### Setup

Allows you to open a dialog to edit the **Inspector** settings for the editor. Click **Setup Inspector**, and from the pop-up menu, select **Setup**.

### NOTE

If you open the **Drum Editor** in the lower zone, these sections are shown in the **Editor Inspector** in the left zone.

---

### RELATED LINKS

[Note Expression Inspector Section](#) on page 712

[Quantize Panel](#) on page 264

[Transpose Functions](#) on page 292

[Opening the Editor Inspector](#) on page 47

## Note Display

The note display of the **Drum Editor** contains a grid in which note events are shown.

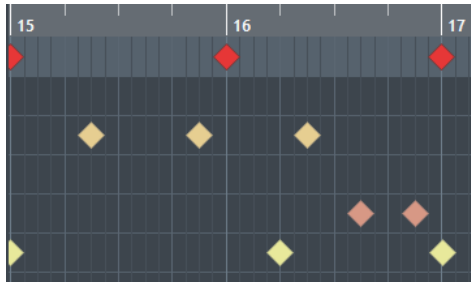

The notes are displayed as diamond symbols. If you activate **Show Note Length On/Off** on the toolbar, notes are displayed as boxes and show the note length.

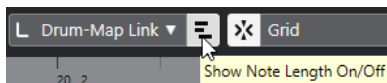

The vertical position of the notes corresponds to the drum sound list to the left, while the horizontal position corresponds to the note's position in time.

### RELATED LINKS

[Drum Editor Toolbar](#) on page 672

## Drum Sound List

The drum sound list lists all drum sounds by name and allows you to adjust and manipulate the drum sound setup in various ways.

	Pitch	Instrument	Snap	Mute	I-Note	O-Not	Chan	Output
	C1	Bass Drum	1/16		C1	C1	10	Track
	C#1	Side Stick	1/16		C#1	C#1	10	Track
	D1	Acoustic Snare	1/16	■	D1	D1	10	Track
	D#1	Hand Clap	1/16		D#1	D#1	10	Track
	E1	Electric Snare	1/16		E1	E1	10	Track
	F1	Low Floor Tom	1/16		F1	F1	10	Track
	F#1	Closed Hi-Hat	1/16		F#1	F#1	10	Track
	G1	High Floor Tom	1/16		G1	G1	10	Track
	G#1	Pedal Hi-Hat	1/16		G#1	G#1	10	Track
	A1	Low Tom	1/16		A1	A1	10	Track

### NOTE

The number of columns in the list depends on whether a drum map is selected for the track or not.

### Pitch

Note number of the drum sound.

### Instrument

Name of the drum sound.



### Snap

This is used when entering and editing notes.

### Mute

Allows you to mute drum sounds.

### I-Note

Input note for the drum sound. When you play this note, it is mapped to the corresponding drum sound and automatically transposed according to the **Pitch** setting for the sound.

### O-Note

The MIDI output note that is sent out every time the drum sound is played back.

### Channel

The MIDI channel, on which the drum sound is played back.

### Output

MIDI output on which the drum sound is played back.

#### RELATED LINKS

[Muting Notes and Drum Sounds](#) on page 684

[Drum Maps](#) on page 684

## Drum Visibility Agents Menu

The **Drum Visibility Agents** on the drum editor toolbar allow you to determine which drum sounds are shown in the drum sound list.

- To open the visibility agents, click **Drum Visibility Agents** on the toolbar.

### Show All Drum Sounds

Shows all drum sounds as defined in the selected drum map.

#### NOTE

In this mode, you can edit the order of the drum sound list manually.

---

### Show Drum Sounds with Events

Shows only the drum sounds for which events are available in the selected MIDI part.

### Show Drum Sounds in use by Instrument

Shows all drum sounds for which a pad, etc. is in use for the instrument. This option is only available if the instrument can provide this information.

### Reverse Drum Sound List

Reverses the order of the sounds displayed in the drum sound list.

## Drum Map and Names Menus

Below the drum sound list are pop-up menus that are used for selecting a drum map for the edited track or, if no drum map is selected, a list of drum sound names.

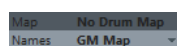

#### RELATED LINKS

[Drum Maps](#) on page 684

## Drum Editor Operations

This section describes the general editing operations within the **Drum Editor**.

### Inserting Note Events

You can insert note events with the **Object Selection** tool or the **Drumstick** tool.

#### PREREQUISITE

You have set up the **Insert Length** on the toolbar to determine the length of the inserted note. If **Insert Length** is set to **Drum-Map Link**, the note gets the length of the **Snap** value set for the sound in the drum sound list. You have activated **Snap**.

#### NOTE

If you want to snap positions according to the **Quantize Presets** setting on the toolbar, activate **Use Quantize**.

---

#### PROCEDURE

- Perform one of the following actions:
  - Select the **Object Selection** tool and double-click in the event display.
  - Select the **Drumstick** tool and click in the event display.

#### NOTE

To temporarily switch from the **Object Selection** tool to the **Drumstick** tool, hold down **Alt**.

---

#### RESULT

A note event is inserted.

### Inserting Multiple Note Events

You can insert multiple note events of the same pitch with the **Object Selection** tool or the **Drumstick** tool.

#### PREREQUISITE

You have set up the **Insert Length** on the toolbar to determine the length of the inserted note. If **Insert Length** is set to **Drum-Map Link**, the note gets the length of the **Snap** value set for the sound in the drum sound list. You have activated **Snap**.

#### NOTE

If you want to snap positions according to the **Quantize Presets** setting on the toolbar, activate **Use Quantize**.

---

#### PROCEDURE

- Perform one of the following actions:
    - On the toolbar, select the **Object Selection** tool, double-click in the event display and drag to the right.
    - On the toolbar, select the **Drumstick** tool, click in the event display and drag to the right.
-

#### RESULT

The note events are inserted.

#### RELATED LINKS

[Drum Editor Toolbar](#) on page 672

## Modifying Note Values While Inserting Notes

When inserting note events, you can modify specific note values on the fly.

- To edit the note velocity, drag upwards or downwards.
- To edit the note pitch, hold down **Alt** and drag upwards or downwards.
- To edit the note length, drag to the left or to the right.

#### NOTE

If you want to edit the note length in the **Drum Editor**, you must deactivate **Snap** and activate **Show Note Length On/Off**. Otherwise, the note is repeated.

- To edit the time position, hold down **Shift** and drag to the left or to the right.

#### NOTE

You can activate/deactivate **Snap** temporarily by holding down **Ctrl/Cmd**.

---

## Changing the Note Length

You can change the note length in the drum editor with the **Object Selection** tool or with the **Drumstick** tool.

#### PREREQUISITE

You have activated **Show Note Length On/Off** on the drum editor toolbar.

#### PROCEDURE

1. Move the mouse pointer to the beginning or the end of the note that you want to edit.  
The mouse pointer turns into a double arrow.
2. Drag to the left or to the right to adjust the length.  
An info box with the current length value is displayed.
3. Release the mouse button.

#### RESULT

The note length is changed. **Snap** is taken into account.

## Deleting Note Events

#### PROCEDURE

- Perform one of the following actions:
    - Select the **Erase** tool and click the event.
    - Select the **Object Selection** tool and double-click the event.
    - Select the **Drumstick** tool and click the event.
-

RESULT

The note event is deleted.

## Deleting Multiple Note Events

You can delete multiple note events of the same pitch with the **Object Selection** tool or the **Drumstick** tool.

PREREQUISITE

To delete multiple note events with the **Object Selection** tool, **Snap** must be activated.

---

PROCEDURE

- Do one of the following:
    - On the toolbar, select the **Object Selection** tool, double-click the first event you want to delete, and drag to the right.
    - On the toolbar, select the **Drumstick** tool, click the first event you want to delete, and drag to the right.
- 

RESULT

The note events are deleted.

## Muting Notes and Drum Sounds

IMPORTANT

The mute state for drum sounds is part of the drum map. All other tracks using this map are affected.

---

- To mute individual notes, click or enclose them with the **Mute** tool, or select **Edit > Mute**.
- To mute a drum sound in a drum map, click in the **Mute** column for the drum sound.

Pitch	Instrument	Snap	Mute	I-Note	O-Not	Chan	Output
C1	Bass Drum	1/16	■	C1	C1	10	Track
C#1	Side Stick	1/16	■	C#1	C#1	10	Track
D1	Acoustic Snare	1/16	■	D1	D1	10	Track
D#1	Hand Clap	1/16	□	D#1	D#1	10	Track

- To mute all other drum sounds, click **Solo Instrument (Requires Drum Map)** on the toolbar.

RELATED LINKS

[Selecting a Drum Map for a Track](#) on page 687

## Drum Maps

A drum kit in a MIDI instrument is most often a set of different drum sounds with each sound placed on a separate key. For example, the different sounds are assigned to different MIDI note numbers. One key plays a bass drum sound, another a snare, and so on.

Different MIDI instruments often use different key assignments. This can be troublesome if you have made a drum pattern using one MIDI device and then want to try it on another. When you switch devices, it is very likely that your snare drum becomes a ride cymbal or your hi-hat becomes a tom, etc., because the drum sounds are distributed differently in the instruments.

To solve this problem and to simplify several aspects of MIDI drum kits, such as using drum sounds from different instruments in the same drum kit, Cubase features drum maps. A drum map is a list of drum sounds with a number of settings for each sound. When you play back a MIDI track for which you have selected a drum map, the MIDI notes are filtered through the drum map before they are sent to the MIDI instrument. The map determines which MIDI note number is sent out for each drum sound and which sound is played on the receiving MIDI device.

When you want to try your drum pattern on another instrument, you simply switch to the corresponding drum map, and your snare drum sound remains a snare drum sound.

If you want to have the same drum maps included in your projects, you can load these into the template.

#### NOTE

Drum maps are saved with the project files. If you have created or modified a drum map, use the **Save** function to save it as a separate XML file to make it available for loading into other projects.

#### RELATED LINKS

[Saving a Project Template File](#) on page 85

## Drum Map Setup Dialog

This dialog allows you to load, create, modify, and save drum maps.

- To open the **Drum Map Setup** dialog, select **Drum Map Setup** from the **Map** pop-up menu or the **MIDI** menu.

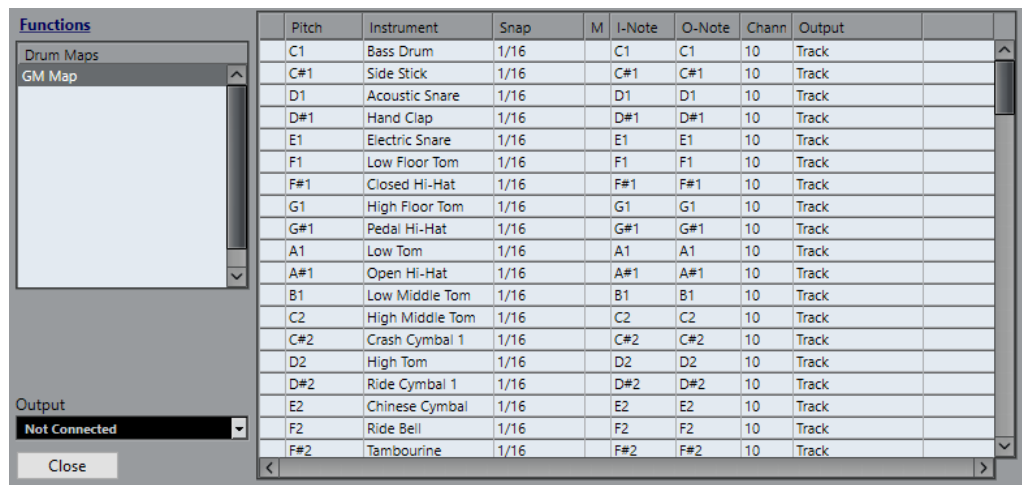

The list on the left shows the loaded drum maps. The sounds and settings of the selected drum map are displayed on the right.

#### NOTE

The settings for the drum sounds are the same as in the **Drum Editor**.

#### Output

Allows you to select the output for the drum map sounds.

#### Drum Sound list

Lists all drum sounds and their settings. To audition a drum sound, click the leftmost column.

**NOTE**

If you audition a sound in the **Drum Map Setup** dialog and the sound is set to MIDI output **Default**, the output that is selected on the **Output** pop-up menu in the lower left corner is used. When auditioning a default output sound in the **Drum Editor**, the MIDI output selected for the track is used.

The **Functions** pop-up menu contains the following options:

**New Map**

Adds a new drum map to the project. The drum sounds are named “Sound 1, Sound 2, etc.” and have all parameters set to default values. The map is named “Empty Map”.

To rename the drum map, click the name in the list and type in a new name.

**New Copy**

Adds a copy of the selected drum map to create a new drum map. You can then change the drum sound settings of the copy and rename the drum map in the list.

**Remove**

Removes the selected drum map from the project.

**Load**

Allows you to load drum maps into your project.

**Save**

Allows you to save the drum map that is selected in the list on disk. Drum map files have the extension `.drm`.

RELATED LINKS

[Drum Map Settings](#) on page 686

[Channel and Output Settings](#) on page 687

## Drum Map Settings

A drum map consists of settings for 128 drum sounds, one for each MIDI note number.

- To get an overview of the drum map settings, open the **Drum Editor** and use the **Map** pop-up menu below the drum sound list to select the **GM Map** drum map.

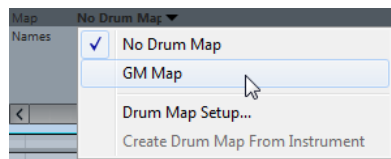

The GM map is set up according to the General MIDI standard.

You can change all drum map settings except the pitch directly in the drum sound list or in the **Drum Map Setup** dialog. These changes affect all tracks that use the drum map.

RELATED LINKS

[Drum Sound List](#) on page 680

[Drum Map Setup Dialog](#) on page 685

## Importing Drum Maps from Virtual Instruments

You can import your drum map settings to an instrument track that is routed to Groove Agent SE.

### PREREQUISITE

To import your drum map settings to an instrument track, the track has to be routed to Groove Agent SE or another drum instrument that supports drum maps.

---

### PROCEDURE

1. Load a drum kit in Groove Agent SE.
2. In the **Inspector** for the track, open the **Drum Maps** pop-up menu and select **Create Drum Map from Instrument**.  
The drum map is created for the kit that is assigned to the MIDI port and channel selected in the **Inspector**.
3. Open the **Drum Maps** pop-up menu again and select **Drum Map Setup**.
4. In the list on the left, select the kit that you have loaded in the instrument.

---

### RESULT

The sounds and settings of the instrument are displayed in the **Drum Map Setup**.

### NOTE

Instrument and pattern pads are both exported to the drum map. If they share keys, the pattern pads get priority, that is, their settings are included in the drum map.

---

## Channel and Output Settings

You can set separate MIDI channels and/or MIDI outputs for each sound in a drum map. When a drum map is selected for a track, the MIDI channel settings in the drum map override the MIDI channel setting for the track.

You can select different channels and/or outputs for different sounds. This allows you to construct drum kits with sounds from several different MIDI devices, etc.

- To make a drum sound use the channel of the track, set the channel in the drum map to **Any**.
- To make the sound use the MIDI output that is selected for the track, set the MIDI output for a sound in a drum map to **Default**.
- To send the sound to a specific MIDI output, select any other option.
- To select the same MIDI channel or MIDI device for all sounds in a drum map, click in the **Channel** column, press **Ctrl/Cmd**, and select a channel or output.
- If you make specific MIDI channel and output settings for all sounds in a drum map, you can switch between drum maps to send your drum tracks to another MIDI instrument.

## Selecting a Drum Map for a Track

- To select a drum map for a MIDI track, open the **Map** pop-up menu in the **Inspector** or in the **Drum Editor** and select a drum map.
- To deactivate the drum map functionality in the **Drum Editor**, open the **Map** pop-up menu in the **Inspector** or in the **Drum Editor** and select **No Drum Map**.  
Even if you do not use a drum map, you can still separate sounds by name using a name list.

## NOTE

Initially, the **Map** pop-up menu only contains **GM Map**.

---

## I-Notes, O-Notes, and Pitches

Going through the following theory helps you make the most out of the drum map concept – especially if you want to create your own drum maps.

A drum map is a kind of filter that transforms notes according to the settings in the map. It does this transformation twice; once when it receives an incoming note, that is when you play a note on your MIDI controller, and once when a note is sent from the program to the MIDI sound device.

The following example shows a modified drum map with a bass drum sound that has different pitch, I-note, and O-note values.

Pitch	Instrument	Snap	Mute	I-Note	O-Note	Channel	Output
C1	Bass Drum	1/16		A1	B0	10	Track
C#1	Side Stick	1/16		C#1	C#1	10	Track
D1	Acoustic Snare	1/16		D1	D1	10	Track
D#1	Hand Clap	1/16		D#1	D#1	10	Track

### I-Notes (Input Notes)

When you play a note on your MIDI instrument, the program looks for this note number among the I-notes in the drum map. If you play the note A1, the program finds that this is the I-note of the bass drum sound.

This is where the first transformation happens: the note gets a new note number according to the pitch setting for the drum sound. In our case, the note is transformed to a C1 note, because that is the pitch of the bass drum sound. If you record the note, it is recorded as a C1 note.

For example, you can place drum sounds near each other on the keyboard so that they can be easily played together, move sounds so that the most important sounds can be played from a short keyboard, play a sound from a black key instead of a white. If you never play your drum parts from a MIDI controller but draw them in the editor, you do not need the I-note setting.

### O-Notes (Output Notes)

The next step is the output. This is what happens when you play back the recorded note, or when the note you play is sent back out to a MIDI instrument in real time (MIDI Thru):

The program checks the drum map and finds the drum sound with the pitch of the note. In our case, this is a C1 note and the drum sound is the bass drum. Before the note is sent to the MIDI output, the second transformation takes place: the note number is changed to that of the O-note for the sound. In our example, the note sent to the MIDI instrument is a B0 note.

The O-note settings let you set things up so that the bass drum sound really plays a bass drum. If you are using a MIDI instrument in which the bass drum sound is on the C2 key, you set the O-note for the bass drum sound to C2. When you switch to another instrument (in which the bass drum is on C1) you want the bass drum O-note set to C1. Once you have set up drum maps for all your MIDI instruments, you can select another drum map when you want to use another MIDI instrument for drum sounds.



## Setting Pitches of Notes According to their O-Note Settings

You can set the pitch of notes according to their O-note settings. This is useful if you want to convert a track to a regular MIDI track with no drum map and still have the notes play back the correct drum sound.

It is a typical use case to export your MIDI recording as a standard MIDI file. If you first perform an O-note conversion, you make sure that your drum tracks play back as intended when they are exported.

- To perform an O-note conversion, select **MIDI > O-Note Conversion**.

### RELATED LINKS

[Exporting MIDI Tracks as Standard MIDI Files](#) on page 141

## List Editor

The **List Editor** shows all events in the selected MIDI parts as a list, allowing you to view and edit their properties numerically. It also allows you to edit SysEx messages.

- To open a MIDI part in the **List Editor**, select a MIDI part in the **Project** window and select **MIDI > Open List Editor**.

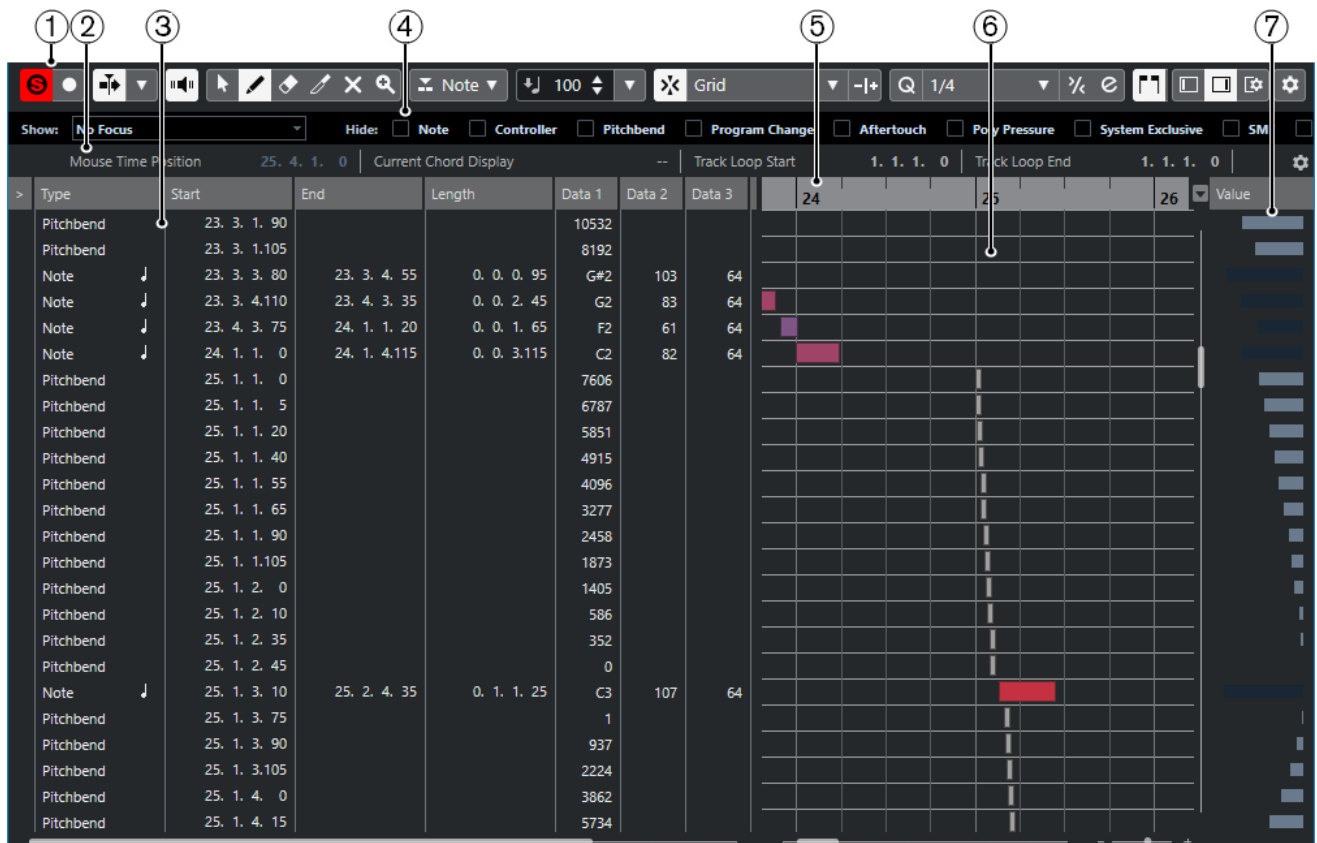

The **List Editor** is divided into several sections:

- 1 Toolbar
- 2 Status line
- 3 Event list
- 4 Filters bar
- 5 Ruler

- 6 Event display
- 7 Value display

#### NOTE

The filters, the status line, and the value display can be activated/deactivated by clicking **Set up Window Layout** on the toolbar and activating/deactivating the corresponding options.

---

## List Editor Toolbar

The toolbar contains tools and various settings for the **List Editor**.

- To show or hide the toolbar elements, right-click the toolbar and activate or deactivate the elements.

### Default Items

#### Solo Editor



Solos the editor during playback if the editor has the focus.

#### Record in Editor



Enables the recording of MIDI data in the editor if the editor has the focus.

#### NOTE

This only works if **MIDI Record Mode** is set to **Merge** or **Replace**.

---

## Retrospective Record

### Insert MIDI Retrospective Recording in Editor



Allows you to recover MIDI notes that you played in stop mode or during playback.

## Auto-Scroll

### Auto-Scroll



Keeps the project cursor visible during playback.

### Select Auto-Scroll Settings



Allows you to activate **Page Scroll** or **Stationary Cursor** and to activate **Suspend Auto-Scroll When Editing**.

## Acoustic Feedback

### Acoustic Feedback



Automatically plays back events when you move or transpose them, or when you create them by drawing.

## Tool Buttons

### Object Selection



Selects events and parts.

### Draw



Draws events.

### Erase



Deletes events.

### Trim



Trims events.

### Mute



Mutes events.

### Zoom



Zooms in. Hold **Alt** and click to zoom out.

## Independent Track Loop

### Independent Track Loop



Activates/Deactivates the independent track loop.

## Insert Type

### Insert Event Type

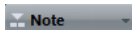

Allows you to determine an event type for newly created events.

## Insert Velocity

### Note Insert Velocity



Allows you to specify a velocity value for new notes.

## Nudge Palette

### Trim Start Left



Increases the length of the selected event by moving its start to the left.

### Trim Start Right



Decreases the length of the selected event by moving its start to the right.

### Move Left



Moves the selected event to the left.

### Move Right



Moves the selected event to the right.

### Trim End Left



Decreases the length of the selected event by moving its end to the left.

### Trim End Right



Increases the length of the selected event by moving its end to the right.

## Snap

### Snap On/Off



Activates/Deactivates the **Snap** function.

### Snap Type



Allows you to select one of the following snap types:

- **Grid** snaps events to the grid that is selected in the **Quantize Presets** pop-up menu.
- **Grid Relative** keeps the relative positions when snapping events to the grid.
- **Events** snaps events to the start or end of other events.
- **Shuffle** changes the order of events if you drag one event to the left or right of other events.
- **Cursor** snaps events to the cursor position.
- **Grid + Cursor** snaps events to the quantize grid that is selected in the **Quantize Presets** pop-up menu or to the cursor position.
- **Events + Cursor** snaps events to the start or end of other events, or to the cursor position.
- **Grid + Events + Cursor** snaps events to the quantize grid that is selected in the **Quantize Presets** pop-up menu, to the start or end of other events or to the cursor position.

## Quantize

### Apply Quantize



Applies the quantize settings.

### Quantize Presets



Allows you to select a quantize or a groove preset.

### Iterative Quantize On/Off



Activates/Deactivates iterative quantize.

### Open Quantize Panel



Opens the **Quantize Panel**.

### Length Quantize

#### Length Quantize

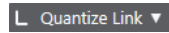

Allows you to set a value for quantizing event lengths.

### Multiple Part Controls

#### Show Part Borders



Shows/Hides part borders for the active MIDI part within the left and right locators.

#### Edit Active Part Only



Restricts editing operations to the active part.

#### Currently Edited Part

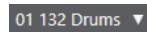

Lists all parts that were selected when you opened the editor, and allows you to activate a part.

### Step/MIDI Input

#### Step Input



Activates/Deactivates MIDI step input.

#### MIDI Input/Note Expression MIDI Input



Activates/Deactivates MIDI input and note expression MIDI input.

#### Move Insert Mode



Moves all note events to the right of the step input position to the right to make room for the inserted event when you insert notes.

NOTE

This only works if **Step Input** is activated.

---

#### Record Pitch



Includes the pitch when you insert notes.

#### Record NoteOn Velocity



Includes the NoteOn velocity when you insert notes.

### Record NoteOff Velocity



Includes the NoteOff velocity when you insert notes.

### Event Colors

#### Event Colors

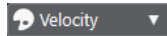

Allows you to select event colors.

### Right Divider

#### Right Divider



Allows you to use the right divider. Tools that are placed to the right of the divider are always shown.

### Edit VST Instrument

#### Edit VST Instrument



Opens the VST instrument that the track is routed to.

### Window Zone Controls

#### Show/Hide Left Zone



Shows/Hides the left zone.

#### Show/Hide Right Zone



Shows/Hides the right zone.

#### Set up Window Layout



Allows you to set up the window layout.

#### Set up Toolbar



Opens a pop-up menu where you can set up which toolbar elements are visible.

#### RELATED LINKS

[Setup Options](#) on page 876

## Status Line

The status line is displayed below the toolbar. It displays important information about the mouse position.

- To show the status line, click **Set up Window Layout** on the toolbar, and activate **Status Line**.



The on/off status of the status line in the **List Editor** window and in the **Editor** tab in the lower zone of the **Project** window are independent of each other.

#### Mouse Time Position

Displays the exact time position of the mouse pointer, depending on the selected ruler display format. This allows you to edit or insert notes at exact positions.

#### Current Chord Display

When the project cursor is positioned over notes that form a chord, this chord is displayed here.

#### Track Loop Start/End

If **Independent Track Loop** is activated on the toolbar, its start/end position are displayed.

#### RELATED LINKS

[Drum Editor Toolbar](#) on page 672

## Filters Bar

The filters bar allows you to hide events from view, based on their type and other properties.

- To show the filters bar, click **Set up Window Layout** on the toolbar, and activate **Filters**.

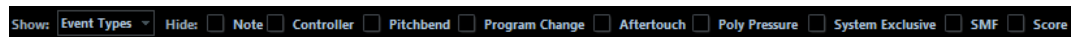

### Show Section

The **Show** section allows you to set up filters.

#### No Focus

No filter is applied.

#### Event Types

Only events of the same event type as the selected type will be shown. This is the same as activating event types in the **Hide** section.

#### Event Types and Data 1

Only events of the same event type as the selected type and with the same **Data 1** value are shown. For example, if a note event is selected, only notes with the same pitch are shown. If a controller event is selected, only controllers of the same type are shown.

#### Event Channels

Only events with the same MIDI channel value as the selected event are shown.

### Hide Section

The **Hide** section allows you to hide specific event types from view.

#### RELATED LINKS

[Filtering the Event List](#) on page 699

[Transformer](#) on page 773

## Event List

The **Event List** lists all events in the selected MIDI parts, in the order in which they are played back from top to bottom. The list allows you to perform detailed numerical editing of the event properties.

The following options are available:

>

An arrow in this column indicates the event that starts closest before the project cursor position. You can use this column for auditioning when you are editing in the list.

- To move the cursor to the start of the event, click in the auditioning column of an event.
- To move the cursor position and start/stop playback, double-click in the column for an event.

### Type

Event type. Cannot be changed.

### Start

Starting position of the event, displayed in the format selected for the ruler. Changing it has the same effect as moving the event.

#### NOTE

If you move the event past any other event in the list, the list is resorted. The list always shows the events in the order in which they are played back.

### End

Allows you to view and edit the end position of a note event. Editing resizes the note event.

### Length

Displays the length of the note event. Changing this resizes the note event and automatically changes the **End** value.

### Data 1

**Data 1** or **Value 1** property of the event. Its content depends on the event type. For notes, this is the pitch, for example. Where applicable, the values are displayed in the most relevant form. For example, the **Data 1** value for notes is displayed as a note number in the format that was selected in the **Preferences** dialog.

### Data 2

**Data 2** or **Value 2** property of the event. The content of this depends on the event type. For notes, this is the note-on velocity value, for example.

### Data 3

The **Data 3** or **Value 3** property of the event. This value is only used for note events, where it corresponds with the note-off velocity.

### Channel

MIDI channel of the event. This setting is normally overridden by the channel setting for the track. To make a MIDI event play back on its own channel, set its track to the **Any** channel in the **Project** window.

### Comment

Use this for **Text**, **Lyrics**, **SMF Event** or **SySex** that require a text entry or a hexadecimal entry.

## Event Display

The **Event Display** displays events graphically.

- The event display is always shown.



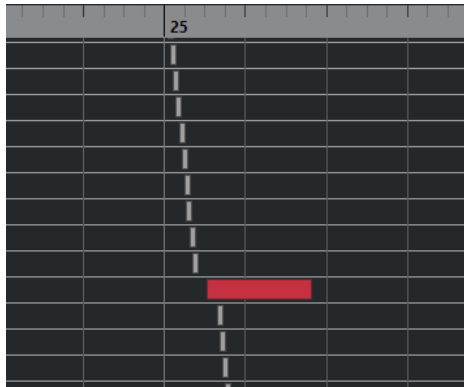

The vertical position of an event in the display corresponds to its entry in the list, that is, to the playback order. The horizontal position corresponds to the actual event position in the project. In the event display, you can add new parts or events, and drag events to another position.

## Value Display

The value display to the right of the event display is a tool for quick viewing and editing of multiple values, for example, velocities or controller amounts. The values are shown as horizontal bars, with the bar length corresponding to the value.

- To show the value display, click **Set up Window Layout** on the toolbar, and activate **Value Display**.



The value that is displayed for an event depends on the event type. The following table shows what is displayed and edited in the **Data** columns and the value display:

Event type	Data 1	Data 2	Value display
Note	Pitch (note number)	Note-on velocity	Velocity
Controller	Controller type	Controller amount	Controller amount
Program change	Program number	Not used	Program number
Aftertouch	Aftertouch amount	Not used	Aftertouch amount
Pitchbend	Bend amount	Not used	Bend amount
SysEx	Not used	Not used	Not used

NOTE

For note events, there is also a value in the **Data 3** column, which is used for note-off velocity.

NOTE

For SMF and text events, no values are displayed.

## List Editor Operations

This section describes the principal editing operations within the **List Editor**.

### Drawing Events

The **Draw** tool allows you to insert single events in the event display.

When you move the cursor inside the event display, its position is indicated on the status line. The **Snap** function is taken into account.

Type	Start	End	Length	Data 1	Data 2	Data 3	24	25
Note	23. 3. 3. 80	23. 3. 4. 55	0. 0. 0. 95	G#2	103	64		
Note	23. 3. 4.110	23. 4. 3. 35	0. 0. 2. 45	G2	83	64		
Note	23. 4. 3. 75	24. 1. 1. 20	0. 0. 1. 65	F2	61	64		
Note	24. 1. 1. 0	24. 1. 4.115	0. 0. 3.115	C2	82	64		
Note	24. 3. 1. 0	24. 4. 1. 0	0. 1. 0. 0	C3	100	64		
Note	24. 4. 1. 0	25. 1. 1. 0	0. 1. 0. 0	C3	100	64		
Pitchbend	25. 1. 1. 0			7606				
Pitchbend	25. 1. 1. 5			6787				
Pitchbend	25. 1. 1. 20			5851				
Pitchbend	25. 1. 1. 40			4915				
Pitchbend	25. 1. 1. 55			4096				

- To change the event type that you want to draw, select it from the **Insert Event Type** pop-up menu.

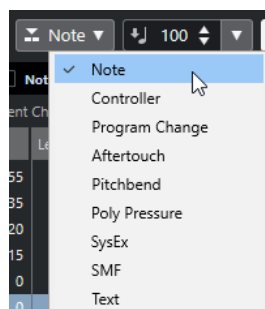

- To draw an event, click in the event display.  
The note event gets the length that is set on the **Length Quantize** pop-up menu. Notes get the insert velocity value set in the **Note Insert Velocity** field on the toolbar.
- To draw longer note events, click and drag in the event display.  
The length of the event is a multiple of the **Length Quantize** value. If **Length Quantize** is set to **Quantize Link**, the event value is determined by the quantize grid.

## Filtering the Event List

You can filter the event list with the **Filters** bar that is displayed below the toolbar in the **List Editor**.

- To filter the event list based on complex criteria, open the **Show** pop-up menu and select a filter.
- To hide an event type, activate the corresponding checkbox on the **Filters** bar.
- To hide all event types except one, press **Ctrl/Cmd** and click the checkbox of the event type that you want to view.

If you **Ctrl/Cmd**-click again, all checkboxes are cleared.

## Editing in the Event List

- To edit the values of several events, select the events and edit the value for one event. The values of the other selected events are also changed. Any initial value differences between the events are maintained.
- To set the values of all selected events to the same value, press **Ctrl/Cmd** and edit the value for one event.
- For SysEx events, you can only edit the **Start** position in the list. However, when you click the **Comment** column, the **MIDI SysEx Editor** opens, in which you can perform detailed editing of system exclusive events.

### NOTE

When you trim the beginning of a note in the **List Editor**, the note may move to a different position in the list, since other events may begin earlier than the edited event.

---

### RELATED LINKS

[SysEx Messages](#) on page 700

## Editing in the Event Display

The event display allows you to edit the events graphically using the tools on the toolbar. You can edit single events as well as several selected events simultaneously.

- To move an event, drag it to a new position.  
Moving the event past any other event in the display resorts the list. The list always shows the events in the order in which they are played back. As a result, the vertical position of the event in the display also changes.
- To make a copy of an event, press **Alt** and drag it to a new position.
- To resize a note, select it and drag its end point with the **Object Selection** tool.
- To mute or unmute an event, click on it with the **Mute** tool.  
You can mute or unmute several events simultaneously by enclosing them in a selection rectangle with the **Mute** tool.
- You can select a color scheme for the events with the **Event Colors** pop-up menu on the toolbar.
- To delete an event, select it and press **Backspace** or **Delete**, or click on it with the **Erase** tool.

### RELATED LINKS

[Event Colors Menu](#) on page 619

## Editing in the Value Display

- To edit values in the value display, click and drag.  
The mouse pointer automatically takes on the shape of the **Draw** tool when you move it over the value display.

## SysEx Messages

SysEx (System Exclusive) messages are model-specific messages for setting various parameters of a MIDI device. This makes it possible to address device parameters that would not be available via normal MIDI syntax.

Every major MIDI manufacturer has its own SysEx identity code. SysEx messages are typically used for transmitting patch data, for example, the numbers that make up the settings of one or more sounds in a MIDI instrument.

Cubase allows you to record and manipulate SysEx data in various ways.

### RELATED LINKS

[Using MIDI Devices](#) on page 602

## Bulk Dumps

In any programmable device, the settings are saved as numbers in computer memory. If you change these numbers, you will change the settings. Normally, MIDI devices allow you to dump (transmit) all or some settings in the device's memory in the form of MIDI SysEx messages.

A dump is therefore, among other things, a way of making backup copies of the settings of your instrument: sending such a dump back to the MIDI device restores the settings.

If your instrument allows the dumping of a few or all of its settings via MIDI by activating some function on the front panel, this dump will probably be recordable in Cubase.

## Recording a Bulk Dump

### IMPORTANT

If your MIDI instrument does not offer a way to initiate a dump, you have to send a Dump Request message from Cubase to start the dump. In that case, use the **MIDI SysEx Editor** to insert the specific Dump Request message (refer to the instrument's documentation) at the beginning of a MIDI track. When you activate recording, the Dump Request message is played back (sent to the instrument), the dump starts and is recorded.

---

### PROCEDURE

1. In the **Preferences** dialog, select **MIDI > MIDI Filter**.
  2. In the **Record** section, deactivate the **SysEx** checkbox to make sure that the recording of SysEx data is not filtered.  
This way, SysEx messages are recorded but not echoed back to the instrument. This can lead to unpredictable results.
  3. Activate recording on a MIDI track and initiate the dump from the front panel of the instrument.
  4. When you have finished recording, select the new part and select **MIDI > List Editor**. This allows you to check that the SysEx dump was recorded. There should be one or several SysEx events in the part/event list.
-

## Transmitting a Bulk Dump Back to a Device

### PREREQUISITE

Route the MIDI track with the System Exclusive data to the device. Check your device's documentation to find details about which MIDI channel should be used, etc.

---

### PROCEDURE

1. Solo the track.
  2. Make sure that the device is set up to receive SysEx messages.
  3. If necessary, put the device in **Standby to Receive System Exclusive** mode.
  4. Play back the data.
- 

## Recording and Transmitting Bulk Dumps

- Do not transmit more data than you need. If all you want is a single program, do not send all. Otherwise, it could get too difficult to find the recognized program. Usually, you can specify exactly which data you want to send.
- If you want the sequencer to dump the pertinent sounds to your instrument whenever you load a project, put the SysEx data in a silent count-in before the project itself starts.
- If the dump is very short, for example, a single sound, you can put the dump in the middle of the project to quickly re-program a device. However, you can achieve the same effect by using Program Change. This is preferable, since less MIDI data is sent and recorded. Some devices may be set up to dump the settings for a sound as soon as you select it on the front panel.
- If you create parts with useful SysEx dumps, you can put these on a special muted track. To make use of these parts, drag them to an empty unmuted track and play them back.
- Do not transmit several SysEx dumps to several instruments at the same time.
- Make a note of the current device ID setting of the instrument. If you change this, the instrument may later refuse to load the dump.

## Recording SysEx Parameter Changes

Often, you can use SysEx to remotely change individual settings in a device, for example, opening a filter, selecting a waveform, changing the decay of the reverb, etc. Many devices are also capable of transmitting changes that are made on the front panel as SysEx messages. These can be recorded in Cubase, and thus incorporated into a regular MIDI recording.

For example, you open up a filter while playing some notes. In that case, you record both the notes and the SysEx messages that are generated when you open the filter. When you play back the recording, the sound changes exactly as it did when you recorded it.

---

### PROCEDURE

1. In the **Preferences** dialog, select **MIDI > MIDI Filter** and make sure that **SysEx** is deactivated in the **Record** section.
  2. Make sure that the instrument is set to transmit changes of front panel controls as SysEx messages.
  3. Record.
- 

### AFTER COMPLETING THIS TASK

In the **List Editor**, check if the events were recorded properly.

## MIDI SysEx Editor

- To open the **MIDI SysEx Editor** for a SysEx event, click in the **Comments** column for the event in the **List Editor**.

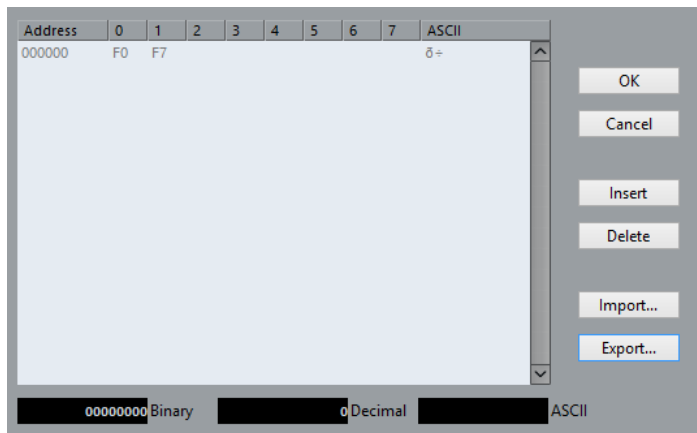

In the **MIDI SysEx Editor**, the bytes are displayed as follows:

### Address

Shows at what position in the message a value is located.

### 0-7

Shows the entire message in hexadecimal format.

SysEx messages always begin with F0 and end with F7 and a number of arbitrary bytes in between. If the message contains more bytes, so that they do not entirely fit on one line, it continues on the next line. You can edit all values except for the first (F0) and the last ones (F7).

### ASCII

Shows the selected value in ASCII format.

## Adding and Deleting Bytes

- To add a byte, open the **MIDI SysEx Editor** and click **Insert**. The byte is added before the selected byte.
- To delete a byte, open the **MIDI SysEx Editor**, select a byte, and click **Delete**.
- To delete the complete SysEx message, select it in the List Editor and press **Delete** or **Backspace**.

## Editing Byte Values

You can edit the selected byte value in the main display of the **MIDI SysEx Editor**, or in the ASCII, decimal, and binary displays.

- To edit the selected value, open the **MIDI SysEx Editor**, click on a byte, and type in the value.

## Importing and Exporting SysEx Data

You can import SysEx data from disk and export the edited data to a file.

The file has to be in MIDI SysEx (.syx) binary format. Only the first dump in a SYX file will be loaded.

- To import SysEx data, open the **MIDI SysEx Editor** and click **Import**.
- To export SysEx data, open the **MIDI SysEx Editor** and click **Export**.

NOTE

Do not confuse this format with MIDI files, which have the extension .mid.

## In-Place Editor

The **In-Place Editor** allows you to edit MIDI notes and controllers directly in the **Project** window, for quick and efficient editing in context with other tracks.

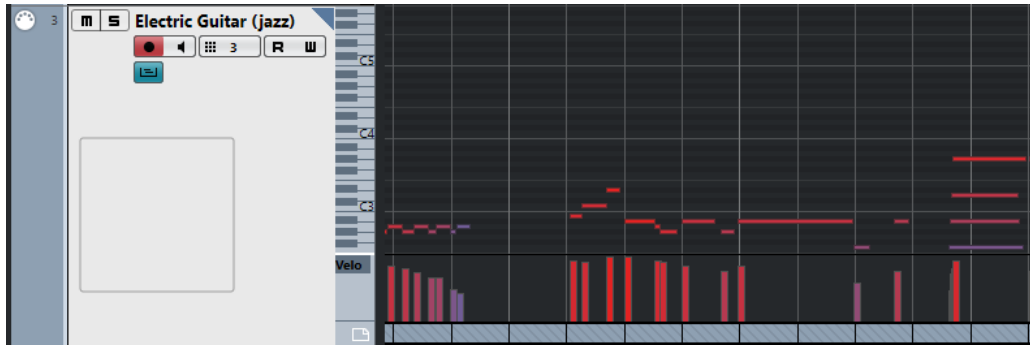

The **In-Place Editor** expands the MIDI track to show a miniature **Key Editor**. When you select a MIDI note, the **Project** window info line shows the same information about the note as the info line in the **Key Editor**. You can perform the same editing here as in the **Key Editor**.

RELATED LINKS

[Editing Note Events on the Info Line](#) on page 623

## Opening the In-Place Editor

- To open the **In-Place Editor** for the selected tracks, select **MIDI > Open In-Place Editor**.
- To open the **In-Place Editor** for a single MIDI track, click **Edit In-Place** in the track list.

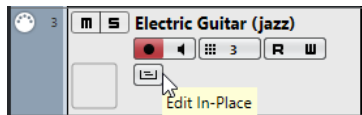

## In-Place Editor Toolbar

The toolbar contains tools and settings for the **In-Place Editor**.

- To open the toolbar, click on the triangle in the upper right corner of the track list for the edited track.

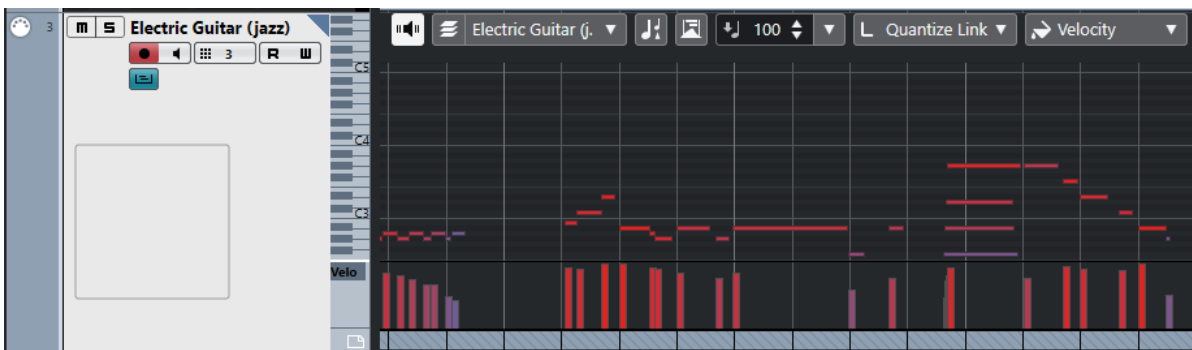

## Acoustic Feedback

### Acoustic Feedback



Automatically plays back events when you move or transpose them, or when you create them by drawing.

## Multiple Part Controls

### Edit Active Part Only



Restricts editing operations to the active part.

### List of Parts in Editor

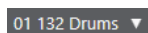

Lists all parts that were selected when you opened the editor, and allows you to activate a part.

## Indicate Transpositions

### Indicate Transpositions



Allows you to display the transposed pitches of MIDI notes.

## Auto Select Controllers

### Auto Select Controllers



Automatically selects controller data of the selected MIDI notes.

## Insert Velocity

### Note Insert Velocity



Allows you to specify a velocity value for new notes.

## Length Quantize

### Length Quantize

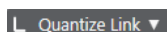

Allows you to set a value for quantizing event lengths.

## Event Colors

### Event Colors

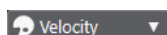

Allows you to select event colors.

## Working with the In-Place Editor

- To zoom or scroll the **In-Place Editor**, point at the left part of the piano keyboard display so that the pointer changes to a hand. Then drag to the right or left to zoom in or out vertically, and drag up or down to scroll the editor.
- To add or remove controller lanes, right-click below the controller name field and select an option from the context menu.



- To close the **In-Place Editor** for one track, click **Edit In-Place** in the track list or double-click below the controller display in the **In-Place Editor**.
- To open/close the **In-Place Editor** for one or several selected tracks, use the **Edit In-Place** key command.
- You can drag notes from one **In-Place Editor** to another.

NOTE

The **Snap** button and **Snap Type** pop-up menu on the **Project** window toolbar control snapping in the **In-Place Editor**, but the snap grid is set using the **Quantize** pop-up menu.

---

# Note Expression

Note expression allows you to edit MIDI notes and their expressions as one unit.

Note expression allows you to associate expression events with MIDI notes, so that they are treated as a unit. When you quantize, move, copy, duplicate, or delete MIDI notes, all their associated controller information follows. This allows for an intuitive and accurate editing of note-related data.

By expression events we understand the following events: MIDI control change, MIDI Pitchbend, MIDI Aftertouch, MIDI Poly Pressure, and VST Note Expression.

Expression event curves are shown as an overlay of the corresponding MIDI notes in the event display. All expression events for a MIDI note are shown simultaneously.

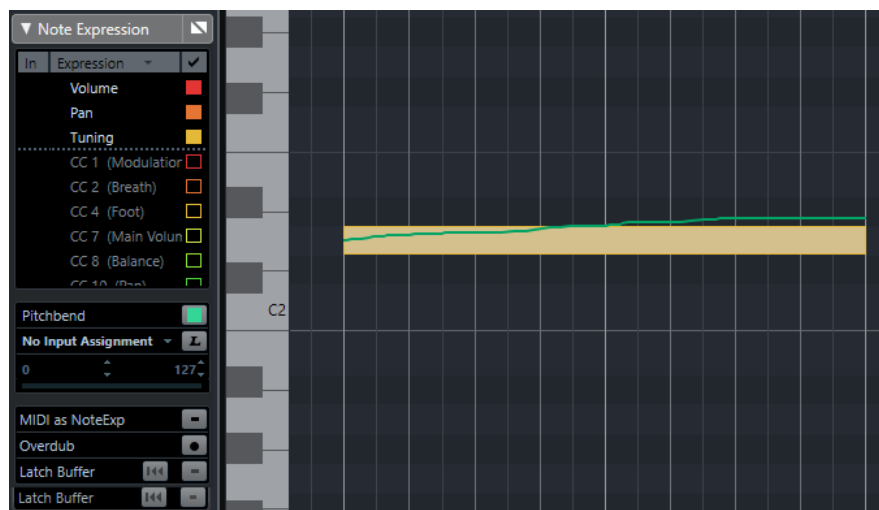

To be able to play and record expression events for MIDI notes, you must use an input controller device that supports note expression, such as MPE-compatible keyboards or MIDI guitars. If you do not have such an input controller, you can assign MIDI messages to expressions instead.

To be able to hear polyphonic performances that use expression events correctly, you must use an output controller device that supports note expression, such as MPE-compatible instruments or VST note expression-compatible VST instruments. If you do not have such a device, you must set up your MIDI instrument to play the same sound on all MIDI channels.

## RELATED LINKS

[VST Note Expressions](#) on page 707

[MIDI Controllers](#) on page 707

[MIDI Input Devices that Support MPE](#) on page 708

## VST Note Expressions

VST note expressions are note-specific. They are suitable for polyphonic contexts, as they allow you to edit the expression of each individual note in a chord.

VST note expressions are provided by VST instruments. To be able to work with VST note expressions, you need a VST instrument that supports them, such as HALion Sonic SE.

Which VST note expressions are available depends on the instrument.

VST note expressions allow for a value range that exceeds the MIDI range of 0 to 127.

You can use all MIDI channels to separate different sounds.

### NOTE

To use VST note expressions to control individual notes, you must set the MIDI channel of the track to a value between 1 and 16.

---

### RELATED LINKS

[VST 3-Compatible VST Instruments](#) on page 707

## VST 3-Compatible VST Instruments

VST 3-compatible VST instruments that support VST note expression can be used with note expression in Cubase.

Cubase comes with a number of VST 3-compatible VST instruments such as HALion Sonic SE, Retrologue, or Padshop that include several presets.

Depending on the preset, Cubase supports specific VST note expressions such as **Tuning**, **Volume** and **Pan**.

### NOTE

Retrologue and Padshop come with some sounds especially made for use with MPE. For use with note expression, you can also use the preset sounds in HALion Sonic SE.

---

For detailed information about Retrologue and Padshop and their parameters, see the separate document **Plug-in Reference**.

For detailed information about HALion Sonic SE and its parameters, see the separate document **HALion Sonic SE**.

### RELATED LINKS

[Loading MPE Instrument Presets](#) on page 712

## MIDI Controllers

MIDI controllers are channel-specific, with the exception of poly pressure messages. They affect the entire voice, regardless of whether they are inserted for a part or a note.

The fact that MIDI controllers are channel-specific limits the potential of note expression to monophonic (solo) performances. If you edit articulation data on one note, this affects all other notes of the same voice, that is, any other note playing on the same channel at the same time.

With the introduction of the MPE standard, however, you can assign each note to a different MIDI channel, and thereby control notes individually. The standard recommends to use exclusively the MIDI channel messages pitchbend, aftertouch, and CC74 to control individual

notes. In this scenario, MIDI channel 1 controls all notes whereas the other 15 MIDI channels can control individual notes.

#### NOTE

To use MIDI controllers to control individual notes, you must set the MIDI channel of the track to **Any**.

---

#### RELATED LINKS

[MIDI Input Devices that Support MPE](#) on page 708

[Controller Display](#) on page 625

[Recording MIDI Control Change Messages as Note Expression Data](#) on page 728

[Converting MIDI Control Change Messages into Note Expression Data](#) on page 728

## MIDI Input Devices that Support MPE

MPE stands for MIDI Polyphonic Expression. Some MIDI devices support MPE. These are multi-dimensional MIDI controllers that allow you to vary the pitch and timbre of individual notes while playing polyphonically.

In MPE, each note is assigned its own MIDI channel. This allows you to apply expression messages to individual notes.

To be able to work with the MPE features in Cubase, that is, polyphonically play and record expressions, you need an appropriate MPE input device. Some MPE input devices are detected and set up automatically.

## Note Expression Input Device Page

The **Note Expression Input Device** page shows the settings for your connected input device.

- To open the page for your note expression input device, select **Studio > Studio Setup**, and select it in the **Devices** list. If your device is not listed, click **Add Device**, and select **Note Expression Input Device**.

#### NOTE

Cubase automatically recognizes some supported note expression input devices and provides specific pages with preset settings in the **Studio Setup** dialog. If your device is set to the original factory settings, you do not have to change anything in this dialog. In some cases you might need to set the device to the appropriate mode. This mode is often referred to as MPE mode.

---

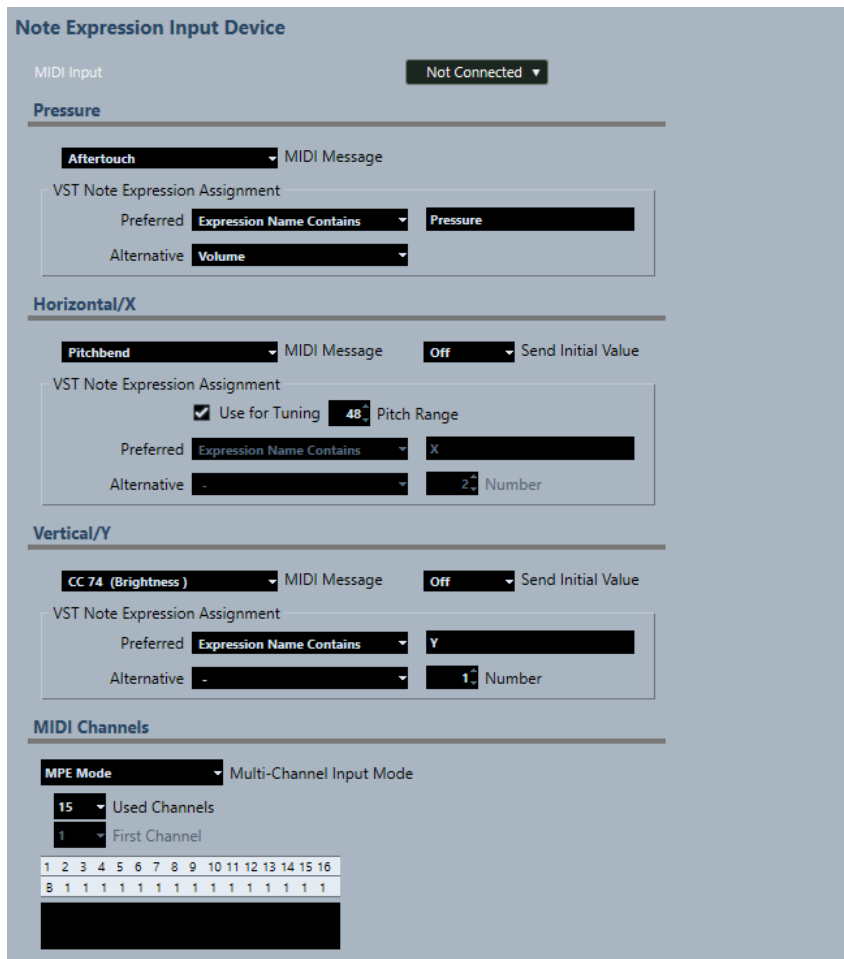

Cubase allows you to capture three dimensions of input movements polyphonically. The **Note Expression Input Device** page provides the sections **Pressure**, **Horizontal/X**, and **Vertical/Y** that allow you to view, and if needed, edit which MIDI messages are used for these three dimensions of control.

The following options are available:

### MIDI Input

Allows you to select the MIDI input port to which your input device is connected.

The following options are available in the **Pressure** section:

### MIDI Message

Allows you to assign a MIDI message to the **Pressure** input movement on your note expression input device. The default assignment is **Aftertouch**.

### VST Note Expression Assignment

Shows the assignment of MPE input movements to VST note expressions.

The following options are available in the **Horizontal/X** section:

### MIDI Message

Allows you to assign a MIDI message to the **Horizontal/X** input movement on your note expression input device. The default assignment is **Pitchbend**.

### Send Initial Value

Allows you to transmit the start position of the input movement to Cubase.

- **Off**

Transmits the absolute position. This corresponds to the following initial values: Absolute: On (Sensel Morph), Relative: Off (LinnStrument).

- **Center (64)**

Transmits the center value first. Input movements cause the value to increase or decrease. This corresponds to the following initial values: Absolute: Off (Sensel Morph), Relative: On (LinnStrument).

### Use for Tuning

Activate this for fretless note expression input devices that allow you to glide seamlessly from any pitch to any other pitch without interrupting the sound.

#### NOTE

If you activate **Use for Tuning**, the **VST Note Expression Assignment** is automatically set to **Tuning**.

Deactivate this for devices that do not support gliding, but that create new notes for every key instead.

### Pitch Range

Allows you to specify the pitch range of your input device. If you glide from one pitch to another one, release the key, and press it again on the same position and pitch, the pitch range is set correctly.

Pressing a specific note several times always plays back the same pitch.

### VST Note Expression Assignment

Shows the assignment of MPE input movements to VST note expressions.

The following options are available in the **Vertical/Y** section:

#### MIDI Message

Allows you to assign a MIDI message to the **Vertical/Y** input movement on your note expression input device. The default assignment is **CC74 (Brightness)**.

### Send Initial Value

Allows you to transmit the start position of the input movement to Cubase.

- **Off**

Transmits the absolute position. This corresponds to the following initial values: Absolute (Seaboard Block), Absolute: On (Sensel Morph), Relative: Off (LinnStrument).

- **Min (0)**

Transmits the minimum value first. Input movements cause the value to increase. This corresponds to the following initial values: Relative Unipolar (Seaboard Block).

- **Center (64)**

Transmits the center value first. Input movements cause the value to increase or decrease. This corresponds to the following initial values: Relative Bipolar (Seaboard Block), Absolute: Off (Sensel Morph), Relative: On (LinnStrument).

- **Max (127)**

Transmits the maximum value first. Input movements cause the value to decrease.

### VST Note Expression Assignment

Shows the assignment of MPE input movements to VST note expressions.

The following options are available in the **MIDI Channels** section:

### Multi-Channel Input Mode

Allows you to choose a multichannel input mode. The following options are available:

- **MPE Mode**  
Activates MPE mode, and sets channel 1 as base channel.
- **Channel Rotation**  
Activates channel rotation, and assigns individual MIDI channels to incoming MIDI notes and their controller messages. This allows a 16-voice polyphony. For this to work, your input controller must support channel rotation.

### Used Channels

Allows you to set up how many channels you want to use for notes.

### First Channel

Only available in **Channel Rotation** mode. This allows you to set the first channel for the channel rotation.

### MIDI Activity display

Allows you to monitor incoming MIDI messages.

#### RELATED LINKS

[VST Note Expression Assignments](#) on page 711

## VST Note Expression Assignments

The **VST Note Expression Assignments** section shows the assignment of input movements of your note expression input device to VST note expressions.

The assignments are predefined for all supported note expression input devices that have a specific page in the **Studio Setup** dialog. You can change these assignments manually.

#### NOTE

The assignment is renewed when you switch either the instrument, or one of its presets.

- To open the page for your note expression input device, select **Studio > Studio Setup** and select it in the **Devices** list. If your device is not listed, click **Add Device**, and select **Note Expression Input Device**.

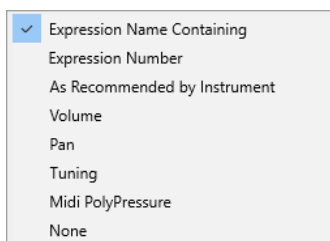

The following options are available as **Preferred** and **Alternative** assignments:

#### Expression Name Contains

Allows you to assign all note expressions to an input movement whose name contains the text that you specify in the field to the right.

#### Note Expression Number

Allows you to assign all note expressions to an input movement whose number corresponds to the one you specify in the field to the right.

### As Recommended by Instrument

Automatically assigns all note expressions to input movements according to the recommendations of the instrument, if available.

### Volume

Assigns the note expression **Volume** to an input movement.

### Pan

Assigns the note expression **Pan** to an input movement.

### Tuning

Assigns the note expression **Tuning** to an input movement.

### MIDI PolyPressure

Assigns the note expression **MIDI PolyPressure** to an input movement.

### None

Does not assign any note expression.

#### RELATED LINKS

[Note Expression Input Device Page](#) on page 708

## Loading MPE Instrument Presets

You can load preset MPE sounds for Retrologue and Padshop.

---

#### PROCEDURE

1. In the **Media** rack in the right zone, click the **VST Instruments** tile.
2. Do one of the following:
  - Click the **Padshop** tile, and click **MPE Padshop**.
  - Click the **Retrologue** tile, and click **MPE Retrologue**.

The MPE instrument presets are shown.

3. Do one of the following:
  - Drag an instrument preset to the track list to create a new instrument track with the loaded instrument preset.
  - Drag an instrument preset to the event display to create a new instrument track with the loaded instrument preset.
  - Drag an instrument preset to an instrument track to apply the preset to the track.

---

#### RESULT

The instrument is loaded, and the MPE preset is applied to the instrument track.

## Note Expression Inspector Section

The **Note Expression Inspector** section features most of the functions that you need to work with note expression.

- To open the **Note Expression** section, select a MIDI or an instrument track, and click **Note Expression** in the **Inspector**.



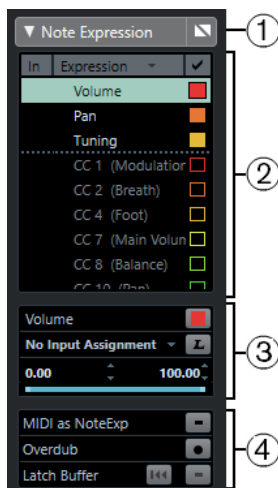

The following sections are available:

- 1 Section header/Bypass button**  
Shows the section name. The bypass button allows you to bypass all note expression data for the track.
- 2 Expression section**  
Lists the available VST note expressions, MIDI controllers, pitchbend, aftertouch and polypressure.
- 3 Expression settings section**  
Allows you to make settings for the expression that is selected in the expression section.
- 4 Global settings section**  
Allows you to make global settings.

#### RELATED LINKS

- [Expression Section](#) on page 713
- [Expression Settings Section](#) on page 715
- [Global Settings Section](#) on page 715

## Expression Section

The expression section shows VST note expressions and MIDI controllers. Which VST note expressions are available depends on the instrument that is used. Which MIDI control change messages are available depends on the settings in the **MIDI Controller Setup** dialog.

The expression section is available in the **Note Expression** section of the **Inspector**.

- To open the **Note Expression** section, select a MIDI or an instrument track, and click **Note Expression** in the **Inspector**.

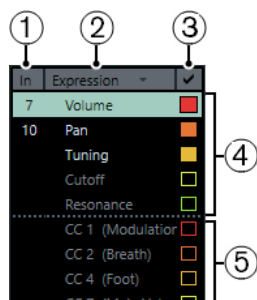

The following sections and functions are available:

- 1 In**  
Shows the abbreviation of the MIDI control change message or the input movement that is mapped to the expression for recording.
- 2 Expression filter**  
Allows you to filter the list of expressions.
- 3 Visibility**  
Shows/Hides the expression in the note expression event editor and in the event display.
- 4 VST note expressions**  
Lists the available VST note expressions.
- 5 MIDI controllers**  
Lists the available MIDI controllers.

RELATED LINKS

[MIDI Controller Setup Dialog](#) on page 630

## Expression Filter Menu

You can filter the list of the available expressions. This allows for a better overview of the list.

- To open the expression filter menu, click the column header.

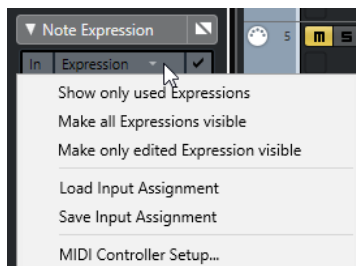

The following options are available:

### Show only used Expressions

Shows only the expressions in the list for which data exists. These are marked with an asterisk (\*) in front of the expression name.

### Make all Expressions visible

Shows all available expressions in the event display.

### Make only edited Expression visible

Shows only the selected expression in the event display.

### Load Input Assignment

Allows you to load mapping presets.

### Save Input Assignment

Allows you to save mapping presets.

### MIDI Controller Setup

Opens a dialog that allows you to add MIDI control change messages to the list.

RELATED LINKS

[Expression Section](#) on page 713

[Controller Mapping](#) on page 716

## Expression Settings Section

In this section, you can make settings for the expression that is selected in the expression section, for example, set up the input assignment.

The expression settings are available in the **Note Expression** section of the **Inspector**.

- To open the **Note Expression** section, select a MIDI or an instrument track, and click **Note Expression** in the **Inspector**.

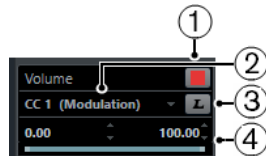

### 1 Color selector

Allows you to specify a color for the selected expression.

### 2 Input Assignment

Allows you to specify the input assignment for the selected expression.

### 3 MIDI Learn

Click this button and move the fader or knob on your external MIDI controller to assign the selected expression to it.

### 4 Range

Allows you to specify a value range that is used for the selected expression.

## Global Settings Section

The global settings apply to all expressions in the expression section.

The global settings are available in the **Note Expression** section of the **Inspector**.

- To open the **Note Expression** section, select a MIDI or an instrument track, and click **Note Expression** in the **Inspector**.

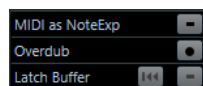

### MIDI as Note Expression

Activate this to record MIDI controller events as note expression data.

### Overdub

Activate this to overdub existing note expression data.

### Latch Buffer

Allows you to activate/deactivate the latch buffer that is used for overdub recording.

## Note Expression Tools

The note expression tools are available on the **Key Editor** toolbar.

### Show Note Expression Data



This button is available in the **Show Note Expression Data** section of the **Key Editor** toolbar. It gives you a visual feedback of your actions. Use the slider to the right to adjust the display size of the note expression data in the event display.

### Note Expression MIDI Input



This button is available in the **Step/MIDI Input** section of the **Key Editor** toolbar. It allows you to record note expression data via MIDI input.

### Acoustic Feedback



This button is available in the **Acoustic Feedback** section of the **Key Editor** toolbar. It gives you an acoustic feedback of the controller events that are present at the mouse position while you enter or change note expression data.

## Controller Mapping

Before you can record VST note expression events with external keyboards, you must map or assign specific MIDI controller messages, or pitchbend and aftertouch, or input movements to expressions.

You can map the controllers via the **Inspector**, via **MIDI Learn** or by using a mapping preset.

#### RELATED LINKS

[Mapping Controllers via the Inspector](#) on page 716

[Mapping Controllers via MIDI Learn](#) on page 717

[Using Mapping Presets](#) on page 717

## Mapping Controllers via the Inspector

You can use the **Inspector** to map the knobs and faders of your MIDI instrument to expressions.

#### PROCEDURE

1. In the expression section, select the expression that you want to map to a MIDI controller.
2. In the expression settings section, open the input assignment pop-up menu and select the controllers that you want to map to the selected note expression.

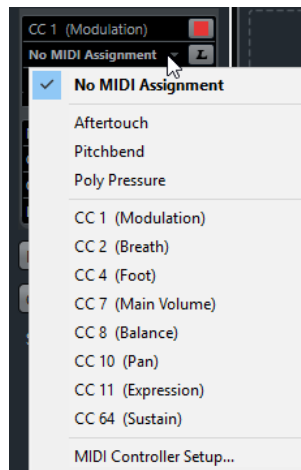

3. Optional: If the controller you are looking for is not on the list, select **MIDI Controller Setup**, and activate it in the dialog.

---

#### RESULT

You can now record note expression data using the controller messages that you just assigned.

In the **In** column in the **Inspector**, the number of the assigned MIDI controller message, or **PB** for pitchbend, or **AT** for aftertouch is shown if the mapping is active.

RELATED LINKS

[Global Settings Section](#) on page 715

## Mapping Controllers via MIDI Learn

The **MIDI Learn** function allows you to assign the knobs and faders of your MIDI device to controllers.

---

PROCEDURE

1. In the expression section, select the expression to which you want to assign a MIDI controller.
2. In the expression settings section, click **MIDI Learn**.
3. On your MIDI device, use the knob or fader that you want to assign to the selected expression.
4. Optional: Repeat this for all the expressions that you want to control with your MIDI device.

---

RESULT

You can now record note expression data using the controls on your MIDI device that you just assigned.

## Using Mapping Presets

You can save your expression mapping as a preset and load it later for use with the same MIDI device.

---

PROCEDURE

1. In the expression list, click the **Expression** column to open the pop-up menu.
2. Select **Save Input Assignment**.
3. In the file dialog that opens, specify a name and a location for the file.

---

RESULT

A file with the extension **\*.neinput** is created.

You can load the mapping presets you created by opening the pop-up menu and selecting **Load Input Assignment**.

## Recording

You can record note expression data together with MIDI notes, or you can record note expression data for existing notes.

RELATED LINKS

[Recording Notes and Note Expression Data](#) on page 718

[Recording Note Expression Data by Overdubbing](#) on page 719

[Recording Note Expression Data via MIDI Input](#) on page 720

## Recording and the Sustain Pedal

If you hold the sustain pedal (MIDI CC 64) of the connected MIDI device during recording, the following applies:

- When a note-off event is received (when the key on the connected keyboard is released), this message is not sent to the VST 3 instrument but is instead created by the program when the sustain pedal is released.  
This makes it possible for the VST 3 instrument to play back control change messages that are sent after a key was released.
- The release phase of the recorded notes ends when the sustain pedal is released.

### NOTE

This does not apply for continuous controller messages.

---

## Recording Notes and Note Expression Data

You can use an external MIDI device to record MIDI notes together with note expression data.

---

### PROCEDURE

1. In the global track controls area of the track list, click **Add Track** .
2. Click **Instrument**.
3. Open the **Instrument** pop-up menu and select **HALion Sonic SE**, for example.
4. Click **Add Track**.  
The instrument track is added to the track list, and the control panel of the selected VST instrument is opened.
5. In the **Inspector** for the instrument track, open the **Note Expression** section.
6. In the expression section, select an expression.
7. In HALion Sonic SE, select a preset.

### NOTE

In the **Presets** browser, enter `noteexp` in the search field of the **Results** section to show the presets that were created especially for use with note expression.

---

8. Map the expressions for recording.
  9. Use the mapped controls on your MIDI device to record MIDI notes together with note expression data.
- 

### RESULT

The notes are recorded together with the note expression data. If you activate **Show Note Expression Data** on the **Key Editor** toolbar, the note expression data is shown on the notes for which they were recorded.

### RELATED LINKS

[Controller Mapping](#) on page 716

[Loading MPE Instrument Presets](#) on page 712

## Recording Notes and Note Expression Data with MPE Input Devices

### PREREQUISITE

Your MPE input device is connected to your computer, and correctly set up in Cubase.

---

#### PROCEDURE

1. In the global track controls area of the track list, click **Add Track** .
2. Click **Instrument**.
3. Open the **Instrument** pop-up menu and select **HALion Sonic SE**, for example.
4. Click **Add Track**.  
The instrument track is added to the track list, and the control panel of the selected VST instrument is opened.
5. In the top section of the **Inspector** for the instrument track, open the **Input Routing** pop-up menu, and select your MPE input device from the list.

#### NOTE

Make sure that the MIDI channel is not set to **Any**.

---

6. In the **Inspector**, open the **Note Expression** section.  
The expressions should be correctly mapped to the input movements of your MPE device.
  7. Use your MPE input device to record MIDI notes together with note expression data.
- 

#### RESULT

The notes are recorded together with the note expression data. If you activate **Show Note Expression Data** on the **Key Editor** toolbar, the note expression data is shown on the notes for which they were recorded.

#### RELATED LINKS

[MIDI Input Devices that Support MPE](#) on page 708

[Loading MPE Instrument Presets](#) on page 712

## Recording Note Expression Data by Overdubbing

You can record or replace note expression data for existing notes by overdubbing.

#### PREREQUISITE

Deselect all notes in the event display before you start overdubbing. This ensures that you record control change messages for all notes touched by the position cursor.

---

#### PROCEDURE

1. In the **Inspector**, open the **Note Expression** section, and activate **Overdub**.
  2. Use the mapped controls on your MIDI device to record note expression data for the note that is playing.
- 

#### RESULT

Only note expression data is recorded.

#### AFTER COMPLETING THIS TASK

Deactivate **Overdub** when you are done.

#### RELATED LINKS

[Global Settings Section](#) on page 715

## Starting Overdub Recording at Specific Controller Values

When you record note expression data by overdubbing, you can activate a **Latch Buffer**. This is useful if you want to start recording at predefined initial knob or fader settings.

When Cubase receives controller data from an external MIDI device, the setting of the faders and knobs on the device is automatically written to the **Latch Buffer**. This data is then added to the notes during playback.

---

### PROCEDURE

1. Map each control to one of the available VST note expressions.
2. Activate **Latch Buffer** and set the knobs and faders on the MIDI controller to the corresponding values.
3. Activate **Overdub**.
4. Use the mapped controls on your MIDI device to record note expression data for the note that is playing.

---

### RESULT

The values for all controls are attached to the notes that are passed during overdub recording, and replace any existing controller data of the same type.

### AFTER COMPLETING THIS TASK

Remove all values from the **Latch Buffer** by clicking **Reset Latch Buffer**.

### NOTE

When you record in a cycle, the **Latch Buffer** is automatically reset at the end of the cycle.

---

## Recording Note Expression Data via MIDI Input

You can record note expression data for existing notes using the **Note Expression MIDI Input**.

---

### PROCEDURE

1. On the **Key Editor** toolbar, in the **Step/MIDI Input** section, activate **MIDI Input** and **Note Expression MIDI Input**.



2. Select a note and move the active control on your MIDI device to replace the controller events for that note.

---

### RESULT

The note is played in real time and incoming control change messages are recorded for it. Recording stops when the end of the note or the end of the release phase is reached, or when you deselect the note.

### RELATED LINKS

[Adding Release Phases to Notes](#) on page 725

## Note Expression Event Editor

The note expression event editor offers various modes for editing and adding note expression events.

- To open the note expression event editor, double-click a note in the event display.



**NOTE**

If you select several notes in the **Key Editor**, and you double-click any of them, the note expression event editor opens for all these notes. In this case, any editing affects all the notes that are present at the time position where you perform the editing.

- To close the editor, click in the event display.

The note expression event editor features the following controls:

- **Note Expression controls**  
These controls allow you to select parameters and add note expression events.
- **Smart controls**  
These allow you to edit the note expression events.

### Note Expression Controls

The note expression event editor features the following specific note expression controls:

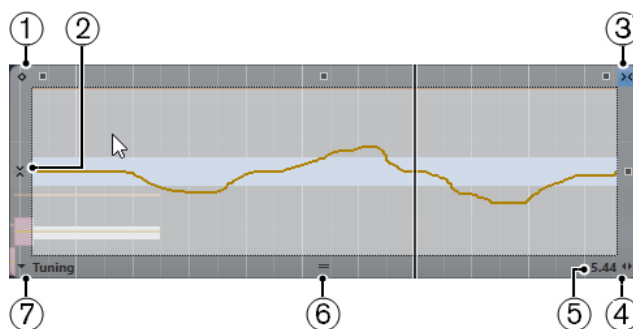

**1 One-Shot Mode**

If this is active and you click with the **Draw** tool anywhere in the editor, a fixed value is set.

**NOTE**

This mode is automatically activated for note expressions that are one-shot only.

**2 Vertical Snap**

Allows you to enter the pitch in semitone steps instead of as a continuous curve. This way, it is much easier to create fast pitch modulations. This is especially useful for the **Tuning** parameter.

**NOTE**

To temporarily switch to vertical snapping while editing, hold down **Shift**.

**3 Horizontal Snap**

This corresponds to the **Snap** button in the **Project** window.

**4 Change Release Length**

Allows you to add a release length to your note.

**5 Parameter Range**

Shows the current value at the cursor position. The value range differs depending on the parameter type.

**6 Change Editor Size**

Click this and drag up or down to change the size of the editor. This allows you to switch between 3 different window sizes.

**7 Parameter Selection**

Shows the selected parameter. Click this to open a pop-up menu with all the parameters that are used for the note. To make more parameters available, select them in the **Inspector**.

## Smart Controls

The note expression event editor features the following smart controls for specific editing modes:

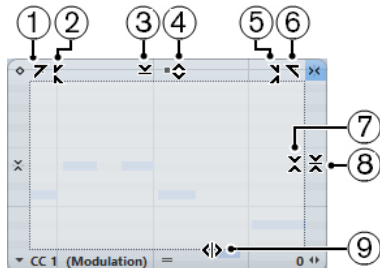

### 1 Tilt Left

If you click in the upper left corner of the editor, you can tilt the left part of the curve. This allows you to tilt the event values at the start of the curve upwards or downwards.

### 2 Compress Left

If you **Alt**-click in the upper left corner of the editor, you can compress or expand the left part of the curve. This allows you to compress or expand the event values at the start of the curve.

### 3 Scale Vertically

If you click in the middle of the upper border of the editor, you can scale the curve vertically. This allows you to raise or lower the event values of the curve in percent.

### 4 Move Vertically

If you click on the upper border of the editor, you can move the entire curve vertically. This allows you to raise or lower the values of the event values of the curve.

### 5 Compress Right

If you **Alt**-click in the upper right corner of the editor, you can compress or expand the right part of the curve. This allows you to compress or expand the event values at the end of the curve.

### 6 Tilt Right

If you click in the upper right corner of the editor, you can tilt the right part of the curve. This allows you to tilt the event values at the end of the curve upwards or downwards.

### 7 Scale Around Relative Center

If you **Alt**-click in the middle right border of the editor, you can scale the curve relative to its center. This allows you to raise or lower the event values horizontally around the center of the editor.

### 8 Scale Around Absolute Center

If you click in the middle right corner of the editor, you can scale the curve absolute to its center. This allows you to raise or lower the event values horizontally around the center of the editor.

### 9 Stretch

If you click on the lower border of the editor, you can stretch the curve horizontally. This allows you to move the event values of the curve to the left or to the right.

## Navigation in the Note Expression Event Editor

You can navigate to the next/previous note while the note expression event editor is open.

- To navigate to the next/previous note, use the **Left Arrow/Right Arrow** keys.
- To step through the notes, press **Tab** and **Shift-Tab**.

## Adding Note Expression Events

---

### PROCEDURE

1. Double-click a note in the event display to open the note expression event editor.
  2. Do one of the following to select the parameter that you want to make settings for:
    - To create events for a parameter that has not been used yet, select the parameter in the **Inspector** to make it available in the editor.
    - To edit existing events, specify which parameter you want to edit by clicking on the curve, by selecting the corresponding parameter on the **Parameter Selection** pop-up menu, or by selecting the parameter in the **Inspector** in the **Note Expression** section.
  3. Select the **Draw** or the **Line** tool, and add note expression events for the selected note.
- 

### RELATED LINKS

[Adding Velocity Events](#) on page 631

## Deleting Note Expression Events

---

### PROCEDURE

1. Double-click the note that contains the note expression events you want to delete.  
The note expression editor opens.
  2. Optional: Open the **Expression** pop-up menu, and select the corresponding note expression in the list.
  3. Drag a selection rectangle to select the range of note expression values that you want to delete.
  4. Select **Edit > Delete**.
- 

### RESULT

The selected note expression events are deleted from the note.

### RELATED LINKS

[Adding Velocity Events](#) on page 631

## Pasting Note Expression Events to Different Notes

You can copy all note expression events from one or more notes and paste them to one or more other notes.

### PREREQUISITE

You have set up a key command for **Paste Note Expression** in the **Key Commands** dialog (**Note Expression** category).

---

### PROCEDURE

1. Double-click the note that contains the note expression events.  
The note expression editor opens.
2. Select the note expression events that you want to copy.

3. Select **Edit > Copy**.
  4. Select the note to which you want to paste the note expression events.
  5. Press the key command that you assigned to the **Paste Note Expression** command.
- 

#### RESULT

All copied note expression events are pasted to the selected note.

If you copied note expression events from several source notes and pasted them to a number of destination notes, the following applies:

- If the number of the source and destination notes matches, the events of the first source note are pasted into the first destination note, the events of the second source note into the second destination note, etc.
- If the number of source notes is smaller than the number of destination notes, the source note events are pasted repeatedly into the destination notes in the order in which they appear.

When you copy the events from 2 source notes into 4 destination notes, for example, the first destination note gets the note expression events from the first source note, the second destination note the events of the second source note the third destination note, the events of the first source note, and the 4th destination note the events of the second source note.

#### RELATED LINKS

[Key Commands](#) on page 854

## Pasting Note Expression Events to Different Parameters

You can copy note expression events from one parameter and paste them to a different parameter.

---

#### PROCEDURE

1. Double-click the note that contains the note expression events to open the note expression event editor.
  2. Select the note expression events of the parameter that you want to copy.
  3. Select **Edit > Copy**.
  4. Select the parameter to which you want to paste the note expression events.
  5. Select **Edit > Paste**.
- 

#### RESULT

All copied note expression events are pasted to the selected parameter.

## Repeating Note Expression Events

#### PROCEDURE

1. Double-click the note that contains the note expression events to open the note expression event editor.
  2. Open the **Expression** pop-up menu, and select the corresponding note expression from the list.
  3. Drag a selection rectangle to select the events that you want to repeat.
  4. Click the selection, and with the mouse button pressed, press **Alt** and drag.
-

#### RESULT

The selected events are copied.

## Moving Note Expression Events

---

#### PROCEDURE

1. Double-click the note that contains the note expression events to open the note expression event editor.
2. Open the **Expression** pop-up menu, and select the corresponding note expression from the list.
3. Do one of the following:
  - Click the note expression event curve and drag to move all events.
  - Drag a selection rectangle to select events and drag to move the selected events.

#### NOTE

To restrict the direction to vertical or horizontal, you can press **Ctrl/Cmd** while dragging.

---

## Adding Release Phases to Notes

You can add a release phase to a note. This allows you to work on the tail of a note which is still sounding after the note-off message was sent, for example.

#### PROCEDURE

1. Double-click a note in the event display to open the note expression event editor.
2. Click and drag the **Change Release Length** control in the lower right corner of the editor to add a release phase.

#### RESULT

The release phase is added to the note.

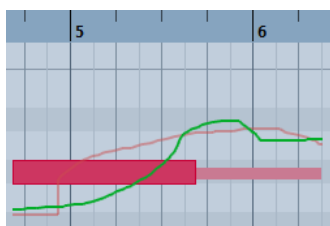

#### NOTE

You can change the release phase for several notes by opening the editor for these notes, and holding down **Alt** while setting the release length.

#### AFTER COMPLETING THIS TASK

Add controller events in the release phase by overdubbing or by manually entering note expression events in the editor. When you overdub note expression events, the length of the existing release phase is used to associate newly recorded events to the notes.

#### NOTE

If you hold the sustain pedal of your external device during recording, the notes automatically get a corresponding release phase.

---

## Trimming Note Expression Data

You can trim note expression data to automatically match the note length.

---

### PROCEDURE

1. Select the notes that contain note expression data.
2. Select **MIDI > Note Expression > Trim Note Expression to Note Length**.

---

### RESULT

The note expression data is trimmed to the note length, and any data present after the end of the release phase is deleted.

## Removing All Note Expression Data

You can delete all note expression data from the selected MIDI note or part.

---

### PROCEDURE

1. Select the MIDI note or the MIDI part that contains the note expression data that you want to delete.
2. Select **MIDI > Note Expression > Remove Note Expression**.

---

### RESULT

The note expression data is removed.

## Note Expression MIDI Setup Dialog

The **Note Expression MIDI Setup** dialog allows you to specify exactly which MIDI messages are used every time you record MIDI control change messages as note expression data or you convert them.

- To open the **Note Expression MIDI Setup** dialog, select **MIDI > Note Expression > Note Expression MIDI Setup**.

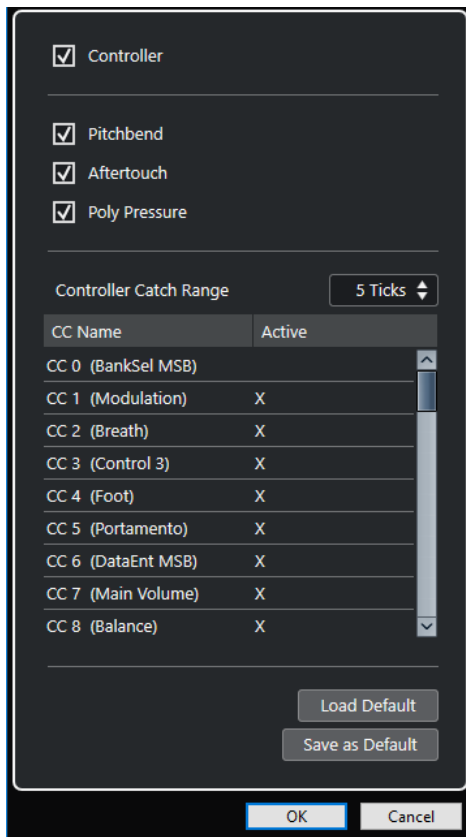

The following options are available:

### Controller

Activates MIDI control change messages. Specify the MIDI control change messages that you want to use in the list below.

#### NOTE

MIDI controller data for deactivated MIDI control change messages will end up on the controller lane.

### Pitchbend

Activates pitchbend data.

### Aftertouch

Activates aftertouch data.

### Poly Pressure

Activates poly pressure data.

### Controller Catch Range

Allows you to enter a controller catch range in ticks. This is useful to associate control change messages with a note, even if they were sent slightly before the note-on message.

### Load Default

Allows you to load the default settings.

### Save as Default

Allows you to save the current settings as default settings.

## Recording MIDI Control Change Messages as Note Expression Data

You can record MIDI control change messages as note expression data.

---

### PROCEDURE

1. In the **Inspector**, open the **Note Expression** section and activate **MIDI as Note Expression**.
  2. Optional: Set the MIDI track to **Any** channel.  
MIDI control change messages, with the exception of poly pressure, are channel-specific. By splitting polyphony to separate channels, you can avoid conflicting controller messages.
  3. Enter the notes and control change messages on your MIDI device.
- 

### RESULT

The controller data is now associated with the notes. If you copy, paste, and move the notes, the associated controller data will follow.

### NOTE

If you want to edit the MIDI notes after recording, you might need to consolidate the controller data.

---

### RELATED LINKS

[Consolidating Note Expression Overlaps](#) on page 729

## Converting MIDI Control Change Messages into Note Expression Data

You can convert the MIDI control change messages on controller lanes into note expression data.

### PREREQUISITE

The MIDI control change messages that you want to record are activated in the **Note Expression MIDI Setup** dialog. You have a MIDI part with controller data written on controller lanes.

---

### PROCEDURE

1. Open the **Key Editor** for the MIDI part.
  2. Select **MIDI > Note Expression > Convert to Note Expression**.
- 

### RESULT

The MIDI control messages contained in the controller lanes are converted to note expression data, and the data on the controller lanes is deleted.

Cubase searches for notes that sound at the same time as the control change messages. If several notes play at the same time, the same note expressions are attributed to them, with the same values. Release phases are automatically created where necessary, so that no controller data is lost during this process.

### IMPORTANT

If you want to edit the MIDI notes after the conversion, you might need to consolidate the controller data.

---

### RELATED LINKS

[Note Expression MIDI Setup Dialog](#) on page 726



[Adding Release Phases to Notes](#) on page 725

## Consolidating Note Expression Overlaps

If you move or quantize notes so that they overlap, and if these overlapping notes contain data for the same control change message, you might need to consolidate the note expression overlaps.

---

### PROCEDURE

- Select **MIDI > Note Expression > Consolidate Note Expression Overlaps**.
- 

### RESULT

If the overlapping notes contain data for the same control change message, the controller values of the second note are used from the beginning of the overlap.

If a note is positioned entirely within a longer note and if these notes contain controller data for the same control change message, the controller values of the longer note are used until the encompassed note starts.

## Distributing Notes to Different Channels

You can distribute notes to different channels. This allows you to use the note expression functions, even if you do not have a VST 3 instrument.

### PREREQUISITE

You have added a multitimbral instrument and assigned the same sound to different channels.

---

### PROCEDURE

1. In the **Inspector** for the corresponding MIDI track, open the **Channel** pop-up menu, and select **Any**.
  2. In the **Inspector**, open the **Note Expression** section.
  3. Enable **MIDI as Note Expression**.
  4. Record or enter MIDI notes with expressions as needed.
  5. Select **MIDI > Note Expression > Distribute Notes to MIDI Channels**.
- 

### RESULT

The MIDI notes are distributed to different channels, starting at channel 1. You can now edit note expression for each note independently without conflicts.

## Converting Note Expression Data to MIDI Controller Data

You can convert note expression data of MIDI controller parameters to MIDI controller data on controller lanes.

---

### PROCEDURE

- Select **MIDI > Note Expression > Dissolve Note Expression**.
- 

### RESULT

The note expression data is converted. If you open the controller display and show the controller lanes for the corresponding event type, the data is displayed.

**NOTE**

If you convert note expression data of VST note expressions to MIDI, the sound will change. Therefore, you must reassign the MIDI controller data to a new instrument destination.

---

# Chord Functions

The chord functions provide you with many possibilities for working with chords.

The chord functions allow you to:

- Build chord progressions by adding chord events to the chord track.
- Convert chord events to MIDI.
- Use the chord track to control MIDI playback.
- Use the chord track voicing to change the pitches of your MIDI.
- Extract chord events from MIDI data to get an overview of the harmonic structure of a MIDI file.
- Record chord events with a MIDI keyboard.

RELATED LINKS

[Chord Editing Section](#) on page 653

## Chord Track

The chord track allows you to add chord events and scale events.

RELATED LINKS

[Scale Events](#) on page 736

[Chord Events](#) on page 732

## Adding the Chord Track

PROCEDURE

- Select **Project > Add Track > Chord**.

RESULT

The chord track is added to your project.

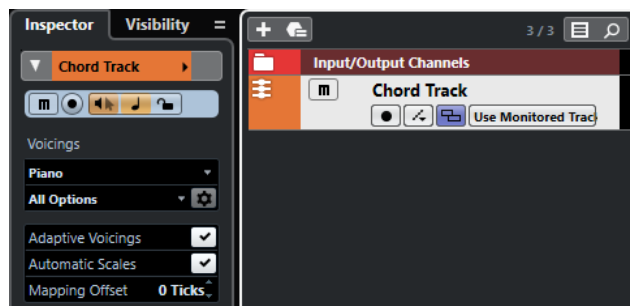

RELATED LINKS

[Chord Track](#) on page 130

## Chord Events

Chord events are representations of chords that control or transpose playback on MIDI and instrument tracks.

Chord events alter the pitches of MIDI notes if their track is set up to follow the chord track.

Chord events have a specific start position. Their end, however, is determined by the start of the next chord event. They can have a root note, a type, a tension, and a bass note.

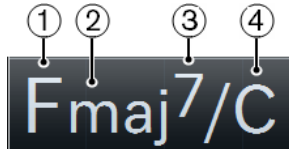

- 1 Root note
- 2 Type
- 3 Tension
- 4 Bass note

RELATED LINKS

[Controlling MIDI Playback Using the Chord Track](#) on page 740

## Chord Editor

The **Chord Editor** allows you to define or change chord events, and to add new chord events.

- To open the **Chord Editor**, double-click a chord event.

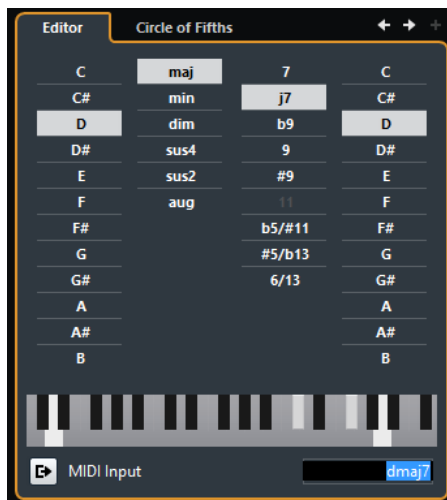

### Go to Previous Chord/Go to Next Chord

Allow you to select the previous/next chord on the chord track for editing.

### Add Chord

Adds a new undefined chord event on the chord track.

#### NOTE

This works only if the last chord event on the chord track is selected.

---

### Chord definition buttons

Activate these buttons to define a root note, a chord type, a tension, and a bass note for your chord event.

#### NOTE

If you do not select a separate bass note, the setting is linked to the root note, so that no extra bass note is heard.

---

### Keyboard display

Shows the notes of the chord event, considering the current voicing settings.

### Activate MIDI Input

Allows you to define a chord by playing a chord on your MIDI keyboard. If the chord is recognized, it is reflected by the chord buttons and the keyboard display.

### Define Chord by Text Input

Allows you to define a chord using the computer keyboard.

## Adding Chord Events

### PREREQUISITE

You have added a chord track.

---

### PROCEDURE

1. Select the **Draw** tool and click in the chord track.  
An undefined chord event named X is added.
  2. Select the **Object Selection** tool and double-click the chord event.
  3. In the **Editor**, select a root note.
  4. Optional: Select a chord type, tension, and bass note.
  5. Do one of the following:
    - To close the **Editor**, click anywhere outside the **Editor**.
    - To add a new undefined chord event, click **Add Chord**.
- 

### RELATED LINKS

[Adding the Chord Track](#) on page 731

## Defining Chords by Text Input

In the chord **Editor**, you can use the text input field to define a chord with the computer keyboard.

---

### PROCEDURE

1. Double-click a chord event to open the chord **Editor**.
2. Click in the text input field at the bottom of the **Editor**.
3. Enter a chord by performing the following actions:
  - Define a root note, for example, C, D, E.
  - Define accidentals, for example, # or b.
  - Define the chord type, for example maj, min, dim, sus, or aug.
  - Define a chord extension, for example, 7, 9, or 13.

NOTE

If you have activated **Solfège** in the **Note Name** pop-up menu in the **Preferences** dialog (**Event Display—Chords&Pitches** page), you can also enter chords in this format. You must capitalize the first letter and write “Re” instead of “re”, for example. Otherwise, the chord is not recognized.

4. Press **Tab** to add a new undefined chord and define it.

## Chord Assistant

The **Chord Assistant** allows you to use a chord as a starting point to get suggestions for the next chord.

- To open the **Chord Assistant**, in the **Chord Editor**, click **Circle of Fifths**.

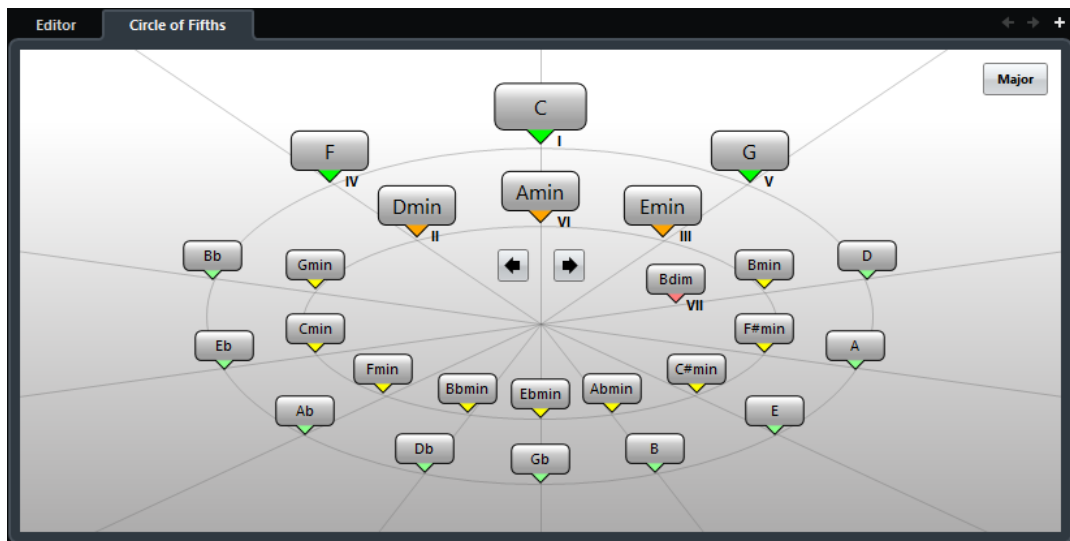

RELATED LINKS

[Chord Assistant – Circle of Fifths](#) on page 734

### Chord Assistant – Circle of Fifths

The **Circle of Fifths** mode of the **Chord Assistant** shows the chords in an interactive visualization of the circle of fifths.

The origin chord that defines the current key is shown in the center of the **Chord Assistant** and is marked as tonic (I).

The outer circle shows the twelve major chords ordered in intervals of fifths.

The inner circle displays the corresponding parallel minor chords.

The roman numerals mark the chords of the current key with their scale degree. You can use these chords to create typical chord progressions or you can use the other chords for more creative results.

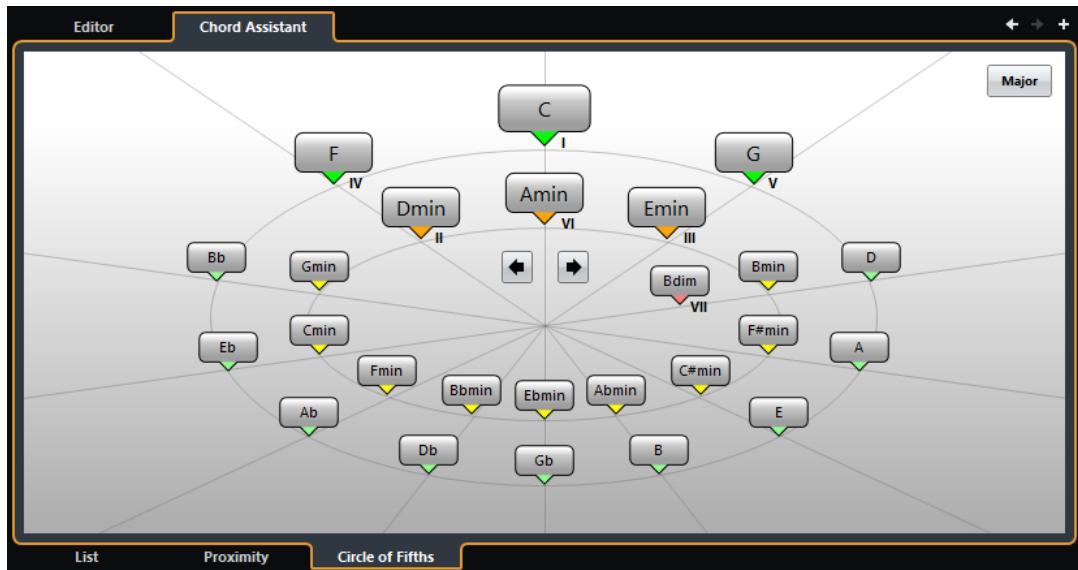

- To play a chord and assign it to the selected chord event, click it. The last 3 chords that you clicked are shown in bold.
- To define a new key, right-click the chord in the **Chord Assistant** and select **Use as Origin**, or use the **Rotate Left/Rotate Right** controls.
- To select the parallel minor chord and define it as key, click **Major/Minor**.

## Auditioning Chord Events

To hear the chord events on the chord track, you must connect the chord track to the output of an instrument or a MIDI track.

### PREREQUISITE

You have added a chord track and chord events.

### PROCEDURE

1. In the global track controls area of the track list, click **Add Track** .
2. Click **Instrument**.
3. Open the **Instrument** pop-up menu and select a VST instrument.
4. Click **Add Track**.  
The instrument track is added to the track list, and the control panel of the selected VST instrument is opened.
5. Select a sound.
6. In the chord track **Inspector**, activate **Acoustic Feedback**.
7. From the **Select Track for Auditioning** pop-up menu, select the track that you want to use for auditioning.



### RESULT

The chord events on the chord track now trigger the sound of the assigned instrument on the MIDI or instrument track.

RELATED LINKS

[Chord Track](#) on page 130

[Add Track Dialog – Instrument](#) on page 107

## Changing How Chord Events Are Displayed

You can change how chord events are displayed. This is useful if chord events overlap each other at low zoom levels or if you do not like the font type.

---

PROCEDURE

1. On the chord track, activate **Resolve Display Conflicts**.

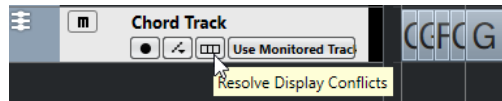

2. In the **Preferences** dialog, select **Event Display > Chords&Pitches**, and set up the chord font.

Here you can also determine the note name and naming format.

---

## Scale Events

Scale events inform you which chord events fit in a specific sequence of notes that belong to a specific root note.

Cubase automatically creates scale events for your chord events.

- To show the scale events, activate **Show Scales** on the chord track.

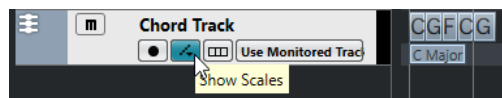

- To audition the notes that belong to a scale event, click it.

However, you can also add and edit scale events manually.

Scale events have a specific start position. Their end is determined by the start of the next scale event.

## Editing Scale Events

PREREQUISITE

You have added a chord track and chord events. You have deactivated **Automatic Scales** in the chord track **Inspector**.

---

PROCEDURE

1. On the chord track, activate **Show Scales**.  
The scale lane with scale events is displayed.
2. Select the chord event.  
A scale event is shown on the scale lane.
3. Do one of the following:
  - Click the first scale event on the chord track, and on the info line, select a **Root Key** and **Type**.

Start	Root Key	Type
1. 1. 1. 0	G	maj



- Double-click the scale event, and in the keyboard that appears, select a **Root Key** and **Type** of the scale.



The keys that correspond to the scale are highlighted.

---

## Voicings

Voicings determine how chord events are set up. They define the vertical spacing and order of the pitches in a chord, but also the instrumentation and genre of a musical piece.

For example, a C chord can be spread over a wide range of pitches, and a pianist will choose different notes than a guitarist. The pianist may also play completely different pitches for different musical genres.

- You can set up voicing for the entire chord track in the chord track **Inspector**.
- You can set up voicings for individual chord events on the **Voicing** pop-up menu on the info line.

### NOTE

If **Adaptive Voicings** is activated in the chord track **Inspector**, you can only change the voicings for the first chord event on the info line.

---

## Inspector Settings for Voicings

To set up voicings for the entire chord track, you can use the chord track **Inspector**.

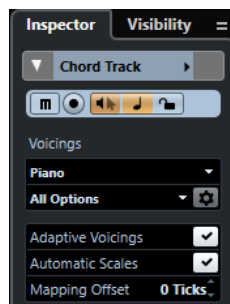

### Voicing library

Allows you to select **Guitar**, **Piano**, or **Basic** as a voicing library.

### Voicing library subset

#### NOTE

This is only available if **Guitar** or **Piano** is set as voicing library.

---

Allows you to select a preset voicing library subset.

### Configure voicing parameters

Opens the **Custom Voicing** panel that allows you to configure your own voicing parameters for a specific voicing scheme.

### Adaptive Voicings

Activate this to let Cubase set the voicings automatically. This prevents the individual voices from jumping too much.

### Automatic Scales

Activate this to let Cubase set the scales automatically.

### Mapping Offset

If you enter a negative number of ticks, the chord events will affect the MIDI notes that have been triggered too early.

#### RELATED LINKS

[Custom Voicing Panel](#) on page 738

## Custom Voicing Panel

If you click **Configure voicing parameters** in the **Voicings** section of the **Inspector**, you can configure your own voicing parameters for a specific voicing scheme.

- To open the **Custom Voicing** panel, click **Configure voicing parameters** in the **Chords** section of the **Inspector**.

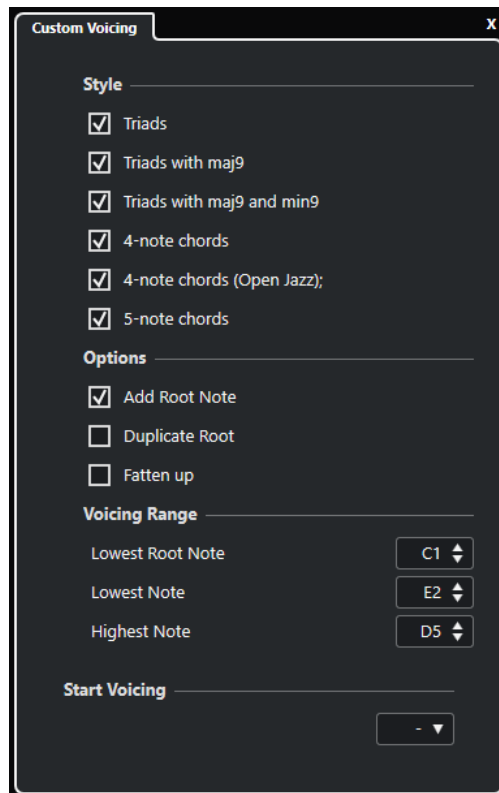

In the **Style** section for **Piano** voicings, you can set up the following parameters:

#### Triads

Sets a triad. Chords with more than 3 notes are not changed.

#### Triads with maj9

Sets a triad with a major ninth, but without root note. Chords with more than 3 notes are not changed.

### **Triads with maj9 and min9**

Sets a triad with a major and a minor ninth, but without root note. Chords with more than 3 notes are not changed.

### **4-Note Chords**

Sets a 4-note chord without root note. Chords with fewer than 3 notes are not changed.

### **4-Note Chords (Open Jazz)**

Sets a 4-note chord without root note and without fifth. Chords with fewer than 3 notes are not changed.

### **5-Note Chords**

Sets a 5-note chord with a ninth. Chords with fewer than 4 notes are not changed.

In the **Options** section for **Piano** voicings, you can set up the following parameters:

#### **Add Root Note**

Adds a root note.

#### **Duplicate Root**

Duplicates the root note.

#### **Fatten up**

Duplicates the tenor.

In the **Voicing Range** section for **Piano** voicings, you can set up the following parameters:

#### **Lowest Root Note**

Sets the limit for the lowest root note.

#### **Lowest Note**

Sets the limit for the lowest note, except the root note.

#### **Highest Note**

Sets the limit for the highest note, except the root note.

In the **Style** section for **Guitar** voicings, you can set up the following parameters:

#### **Triads**

Sets a triad with 4, 5 or 6 voices.

#### **4-Note Chords**

Sets a 4-note chord with 4, 5 or 6 voices without tensions.

#### **3-String Triads**

Sets a 3-string triad.

#### **Modern Jazz**

Sets 4-note, 5-note, and 6-note chords, partly without root note, but with tensions.

For **Basic** voicings, only **Octave Offset from C3** is available. This allows you to determine an offset value for the octave range.

In the **Start Voicing** section for **Piano**, **Guitar**, and **Basic** voicings, you can select a start voicing.

#### **NOTE**

This is only available for MIDI and instrument tracks, but not for the chord track, and only if you select **Voicings** in the **Follow Chord Track** pop-up menu.

---

## Converting Chord Events to MIDI

You can convert chord events to MIDI for further editing or for printing a lead sheet in the **Score Editor**.

---

### PROCEDURE

1. In the global track controls area of the track list, click **Add Track** .
  2. Do one of the following:
    - Click **Instrument** to add an instrument track.
    - Click **MIDI** to add a MIDI track.
  3. Click **Add Track**.
  4. Do one of the following:
    - To convert all chord events to MIDI, select **Project > Chord Track > Chords to MIDI**.
    - To convert only selected chords to MIDI, select the chord events and drag them to the MIDI or instrument track.
- 

### RESULT

A new MIDI part is created, containing the chords as MIDI events.

### RELATED LINKS

[Add Track Dialog – Instrument](#) on page 107

[Add Track Dialog – MIDI](#) on page 114

## Assigning Chord Events to HALion Sonic SE Pads

### PREREQUISITE

Create a chord progression on the chord track and add an instrument track with HALion Sonic SE as VST instrument to your project.

---

### PROCEDURE

1. On the chord track, select the chord events and drag them to the HALion Sonic SE pads. The first chord event is mapped to the pad where you dropped it and all subsequent chord events are mapped to the following pads.
  2. Click the corresponding pads on the HALion Sonic SE keyboard to trigger the chords.
- 

## Controlling MIDI Playback Using the Chord Track

You can use the chord track to control MIDI playback.

## Chords Section for MIDI Tracks

The **Chords** section in the audio track **Inspector** allows you to determine how the events on the MIDI track are mapped to the chord track.

- To open the **Chords** section for a MIDI track, select the track, and in the **Inspector**, click the **Chords** section.

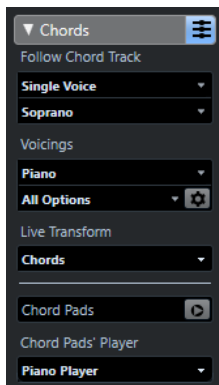

### Follow Chord Track

Select an option to determine how the events on your track are mapped to the chord track.

### Voicings

Allows you to select a voicing library or to use the voicings from the chord track. This is only available if you selected **Voicings** or **Single Voice** in the **Follow Chord Track** pop-up menu.

### Live Transform

Allows you to transpose the MIDI input live to a chord progression on the chord track.

### Chord Pads

Shows/Hides the **Chord Pads Zone**.

### Chord Pads' Player

Allows you to select a player and a voicing setting that is typical for that kind of player, and determine how the notes of a chord are played.

#### RELATED LINKS

- [Using Follow Chord Track](#) on page 742
- [Follow Chord Track Modes](#) on page 742
- [Using Live Transform](#) on page 741
- [Chord Pads Zone](#) on page 747
- [Player Setup](#) on page 758

## Using Live Transform

**Live Transform** allows you to transpose the MIDI input live to a chord progression on the chord track. This way, you do not have to worry about what key you hit on your MIDI keyboard as the MIDI input is transposed to match chords or scales on your chord track in real time.

---

#### PROCEDURE

1. Create a MIDI or an instrument track and activate **Record Enable**.
  2. In the **Inspector**, open the **Chords** section.
  3. Open the **Live Transform** pop-up menu and do one of the following:
    - To map the MIDI input to chord events, select **Chords**.
    - To map the MIDI input to scale events, select **Scales**.
  4. Hit some keys on your MIDI keyboard or on the **On-Screen Keyboard**.
-

#### RESULT

Any key that you hit is mapped in real time to the chord or scale events on the chord track.

## Using Follow Chord Track

This allows you to match an existing recording to a chord progression on the chord track.

---

#### PROCEDURE

1. Select the track that you want to match to the chord track.
2. In the **Inspector**, click **Chords**.
3. Open the **Follow Chord Track** pop-up menu and select a mode.

#### NOTE

If this is the first time that you open this pop-up menu for the track, the **Follow Chord Track** dialog opens.

---

4. In the **Follow Chord Track** dialog, make your changes.
  5. Click **OK**.
- 

#### RESULT

The events on your track now match the chord progression on the chord track.

#### NOTE

If you matched your MIDI track to the chord track, some of the original MIDI notes may be muted. To hide these notes in the editors, activate **Hide Muted Notes in Editors** in the **Preferences** dialog (**Editing—Chords** page).

---

#### RELATED LINKS

[Follow Chord Track Dialog](#) on page 743

[Follow Chord Track Modes](#) on page 742

## Follow Chord Track Modes

This section of the **Inspector** allows you to determine how your track follows the chord track.

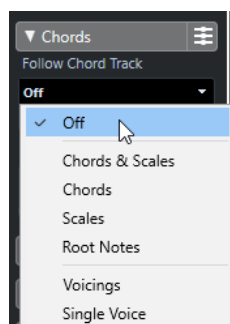

The following options are available on the **Follow Chord Track** pop-up menu:

#### Off

**Follow Chord Track** is deactivated.

#### Chords & Scales

This maintains the intervals of the original chord or scale as far as possible.

### Chords

This transposes MIDI notes to match the key note and maps them to the current chord.

### Scales

This transposes MIDI notes to match the current scale. This allows a bigger variety of notes and a more natural performance.

### Root Notes

This transposes MIDI notes to match the root note of the chord event. The effect corresponds to using the transpose track. This option is suitable for bass tracks.

### Voicings

This transposes MIDI notes to match the voices of the selected voicing library.

### Single Voice

Maps MIDI notes to the notes of a single voice (soprano, tenor, bass, etc.) of the voicing. Use the pop-up menu below to select the desired voice.

#### NOTE

If you apply this mode to a selection of tracks that contain separate voices, you can set up one track as master and the others as voicing slaves. This way, you can change the voicing of the master, and the slaves will follow automatically.

---

#### RELATED LINKS

[Assigning Voices to Notes](#) on page 744

## Follow Chord Track Dialog

This dialog opens the first time that you select an option from the **Follow Chord Track** pop-up menu on the **Chords** section of the **Inspector**.

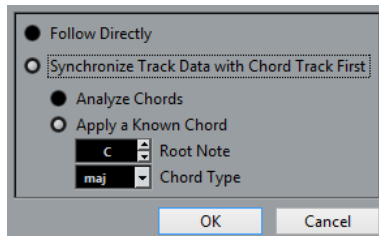

### Follow Directly

Activate this if your MIDI notes are already in accordance with the chord track. This is the case if you extracted your chords from the MIDI events on the track by selecting **Project > Chord Track > Create Chord Symbols**, for example.

### Synchronize Track Data with Chord Track First

Activate **Analyze Chords** if the track data has nothing in common with the chord events. This analyzes the MIDI events and matches the found chords to the chord track. This is only available for MIDI.

Activate **Apply a Known Chord** if the track data has nothing in common with the chord events and if there are no chord changes. Specify **Root Note** and **Chord Type** of your events.

## Using Map to Chord Track

This allows you to match individual parts or events to a chord progression on the chord track.

---

### PROCEDURE

1. In the **Project** window, select the events or parts that you want to map to the chord track.
2. Select **Project > Chord Track > Map to Chord Track**.
3. From the **Mapping Mode** pop-up menu, select a mapping mode.

### NOTE

If you select **Voicings** and no voices are found, **Auto** mode is used instead.

---

4. Click **OK**.
- 

### RESULT

The chords and scales of each event or part are analyzed and used for mapping. If no chords are found, Cubase assumes that the performance is in "C". The available mapping modes and voicings correspond to the **Follow Chord Track** parameters in the **Chords** section of the **Inspector**.

### RELATED LINKS

[Follow Chord Track Modes](#) on page 742

## Assigning Voices to Notes

You can transpose MIDI notes to match the voices of a selected voicing library.

---

### PROCEDURE

- Select **Project > Chord Track > Assign Voices to Notes**.
- 

### RESULT

The note pitches now match the voicing of the chord track and you can still edit the MIDI notes. If you now select a note in the **Key Editor**, you see that **Voice** on the info line is assigned.

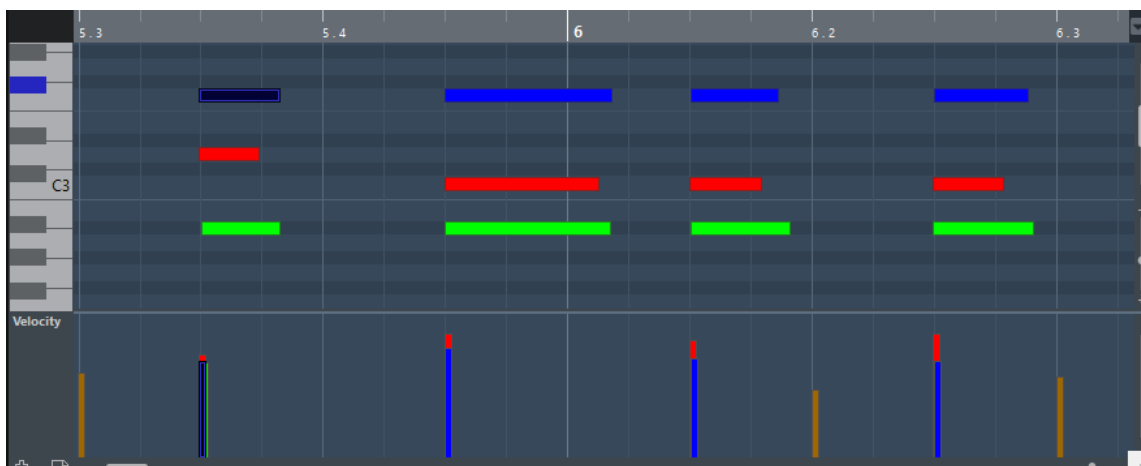



## Extracting Chord Events from MIDI

You can extract chords from MIDI notes, parts, or tracks. This is useful if you have a MIDI file and want to show its harmonic structure, and use this file as starting point for further experimenting.

### PREREQUISITE

Add the chord track and create MIDI notes that can be interpreted as chords. Drums, monophonic bass, or lead tracks are not suitable.

---

### PROCEDURE

1. In the **Project** window, select a part or one or several MIDI tracks.  
You can also select the MIDI tracks, parts, or notes that you want to extract in the **Key Editor**, **Score Editor**, or **In-Place Editor**.
2. Select **Project > Chord Track > Create Chord Symbols**.
3. Make your changes and click **OK**.

---

### RESULT

The chord events are added on the chord track.

### RELATED LINKS

[Create Chord Symbols Dialog](#) on page 745

## Create Chord Symbols Dialog

This dialog allows you to determine, which MIDI data should be taken into account when extracting chord events from MIDI.

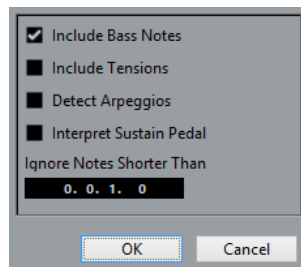

### Include Bass Notes

Activate this if you want your chord events to contain a bass note.

### Include Tensions

Activate this if you want your chord events to contain tensions.

### Detect Arpeggios

Activate this if you want your chord events to contain arpeggiated chords, that is, chords whose notes are played one after another instead of all at once.

### Interpret Sustain Pedal

Activate this if you want your chord events to contain sustain pedal chords, that is, notes that are played while the sustain pedal is held.

### Ignore Notes Shorter Than

Allows you to determine the minimum length of the MIDI events that are taken into account.

## Recording Chord Events with a MIDI Keyboard

You can use a MIDI keyboard to record chord events on the chord track.

### PREREQUISITE

Your project contains an instrument track with **Record Enable** or **Monitor** activated.

---

### PROCEDURE

1. On the chord track, activate **Record Enable**.
  2. On the **Transport** panel, activate **Record**.
  3. Play some chords on your MIDI keyboard.
- 

### RESULT

All recognized chords are recorded as chord events on the chord track.

### NOTE

The chord track uses its own voicing settings. The recorded chord events may therefore sound different.

---

### RELATED LINKS

[Adding Chord Events](#) on page 733

# Chord Pads

Chord pads allow you to play with chords, and to change their voicings and tensions. In terms of harmonies and rhythms, they allow for a more playful and spontaneous approach to composition than the chord track functions.

You can:

- Perform with chords in real time via a MIDI keyboard.
- Record your performance as MIDI events on a MIDI or instrument track or even on the chord track.

## NOTE

We assume that you have a MIDI keyboard connected and set up.

---

## RELATED LINKS

[Voicings](#) on page 737

## Chord Pads Zone

The chord pads in the lower zone of the **Project** window hold all functions that you need to work with chord pads.

To open the **Chord Pads**, select **Project > Chord Pads > Show/Hide Chord Pads**.

## NOTE

You can also select a MIDI or instrument track, and in the **Inspector**, open the **Chords** section and activate **Show/Hide Chord Pads Zone**.

---

The chord pads hold the following controls:

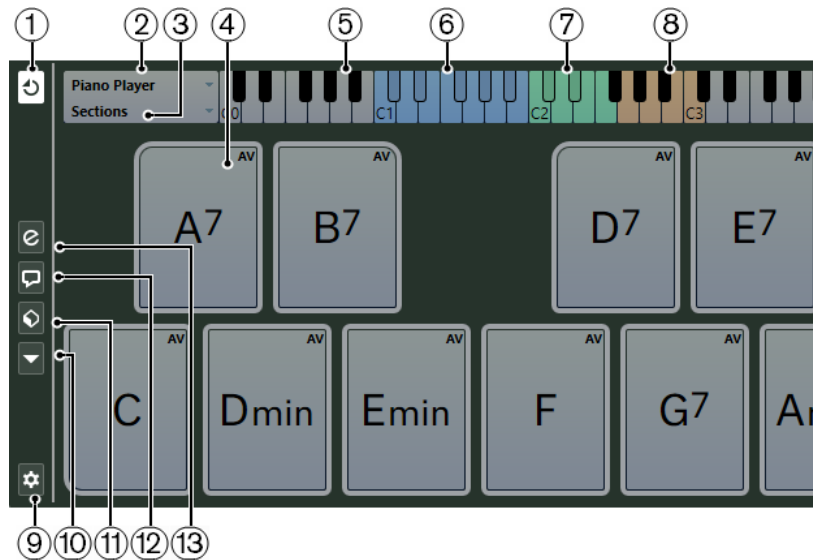

### 1 Chord Pad Output Mode

Activate this to send chord data to all tracks that are monitored or record-enabled. Deactivate this to send chord data exclusively to tracks that are monitored or record-enabled and where **Input Routing** is set to **Chord Pads**.

#### NOTE

If **Record-Enable allows MIDI Thru** is deactivated in the **Preferences** dialog (**Record—MIDI** page), you must activate **Monitor** to use the chord pads.

### 2 Current Player

Shows the selected player and opens a menu where you can select another player.

### 3 Current Mode

Shows the selected player mode and opens a menu where you can select another player mode.

### 4 Chord Pad

Each chord pad can contain a chord symbol. Right-click a chord pad to open a context menu for that chord pad. To change the chord that is assigned to the chord pad, click **Open Editor** on the left edge of the chord pad.

### 5 Keyboard

Shows which keys are played when you trigger a chord pad. To zoom the keyboard, click a key and drag up or down. To scroll the keyboard, click and drag to the left or to the right.

### 6 Pads Remote Range

The keys highlighted in blue on the keyboard correspond to the keys on your MIDI keyboard that trigger the chord pads. You can define the remote range on the **Pad Remote Control** page of the **Chord Pads Setup** dialog.

### 7 Remote Range for Voicings/Tensions/Transpose

The keys highlighted in green on the keyboard display correspond to the keys on your MIDI keyboard that change the voicings, tensions, and transpose settings of the pads. You can activate and define these remote keys on the **Pad Remote Control** page of the **Chord Pads Setup** dialog.

### 8 Section Remote Range

The keys highlighted in brown on the keyboard correspond to the keys on your MIDI keyboard that trigger the sections.

NOTE

The section remote range is only shown if **Player Modes** is set to **Sections**.

- 9 Set up Chord Pads**  
Opens the **Chord Pads Setup** dialog.
- 10 Functions Menu**  
Opens a menu with specific functions and settings for the chord pads.
- 11 Chord Pads Presets**  
Allows you to save and load presets for chord pads and players.
- 12 Show/Hide Chord Assistant**  
Shows/Hides the **Chord Assistant** window that shows suggestions of chords that match the chord that you specified as the origin chord.
- 13 Show/Hide Player Setup**  
Shows/Hides the player setup options.

RELATED LINKS

- [Chord Pads Setup Dialog](#) on page 765
- [Playing Back and Recording Chords](#) on page 755
- [Players and Voicings](#) on page 759
- [Opening Chord Pads](#) on page 53
- [Player Modes—Sections](#) on page 762

## Chord Pad Controls

The chord pad controls allow you to edit the chord pads.

- To show the chord pad controls, move the mouse over a chord pad.

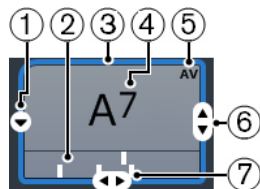

- 1 Open Editor**  
Opens the **Chord Editor** that allows you to select a chord for the chord pad.
- 2 Voicing indicators**  
Shows the voicing used for the chord. Voicing indicators can only be displayed if the horizontal zoom level for the chord pads is high enough.
- 3 Adaptive Voicing Reference/Use X as Origin for Chord Assistant**  
When the active chord pad is set as adaptive voicing reference, its borders are shown in yellow. All other chord pads follow its voicing and are set in a way that they do not get too far away from the reference.  
If the chord pad is set as origin for the **Chord Assistant** window, its borders are shown in blue. This chord pad is used as a basis for the suggestions in the **Chord Assistant** window.
- 4 Assigned Chord**  
Shows the chord symbol that is assigned to the chord pad. Each chord pad can contain one chord symbol. If the name of the assigned chord is too long to display it on the chord pad, it is underlined, and the full chord name is shown in a tooltip.
- 5 AV (Adaptive Voicing)/L (Lock)**

All chord pads follow the adaptive voicing. This is indicated by **AV**. If you change the voicing for a pad manually, however, adaptive voicing is deactivated.

An **L** indicates that the chord pad is locked for editing.

**6 Voicing**

Allows you to set another voicing for the chord pad.

**7 Tensions**

Allows you to add/remove tensions for the chord.

## Chord Pad Context Menu

- To open the chord pad context menu, right-click a chord pad.

**Use X as Origin for Chord Assistant**

Sets the chord of the current pad as an origin chord for the chord assistant.

**Assign Pad from MIDI Input**

Allows you to assign a chord by pressing keys on your MIDI keyboard.

**Lock**

Allows you to lock a chord pad for editing.

**Adaptive Voicing**

All chord pads follow the adaptive voicing. This is indicated by a check mark. If you change the voicing for a pad manually, adaptive voicing is deactivated.

**Adaptive Voicings Reference**

Sets the current pad as adaptive voicing reference. If set, the automatic voicings for the following pads are set in a way that they do not get too far away from the reference voicing. Only one pad can be set as adaptive voicing reference.

**Unassign Pad**

Removes the chord assignment from the current pad.

## Functions Menu

- To open the functions menu, click **Functions Menu**.

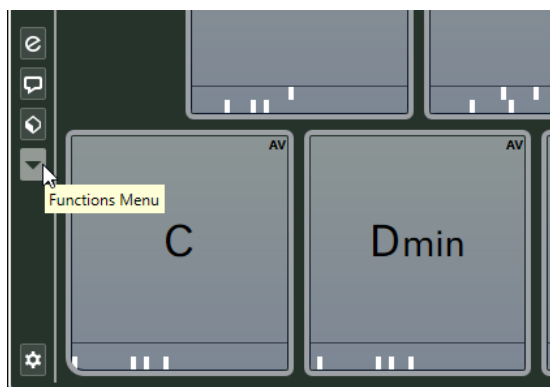

**Show Voicing Indicators**

Allows you to activate/deactivate the voicing indicators that can be displayed at the bottom of each chord pad.

### Assign Pads from Chord Track

Assigns the chord events from the chord track to the chord pads in the same order as they appear on the chord track. Chord events that have more than one occurrence are only assigned once.

### Snap Playback to Musical Grid

Allows you to delay the playback of a triggered chord pad to the next defined musical position. This is useful if you work with an arpeggiator or if you set the **Player Modes** to **Pattern**.

### Transpose All Pads

Transposes all chord pads by a defined transpose value.

### Lock All Pads

Locks all chord pads for editing.

### Unlock All Pads

Unlocks all chord pads.

### Unassign All Pads

Removes the chord assignment from all pads.

## Chord Assistant

The **Chord Assistant** allows you to use a chord as a starting point for suggestions for the next chord. It assists you in finding the right chords for creating a chord progression for your song.

- Click **Show/Hide Chord Assistant** on the left side of the chord pads area to open the **Chord Assistant**.

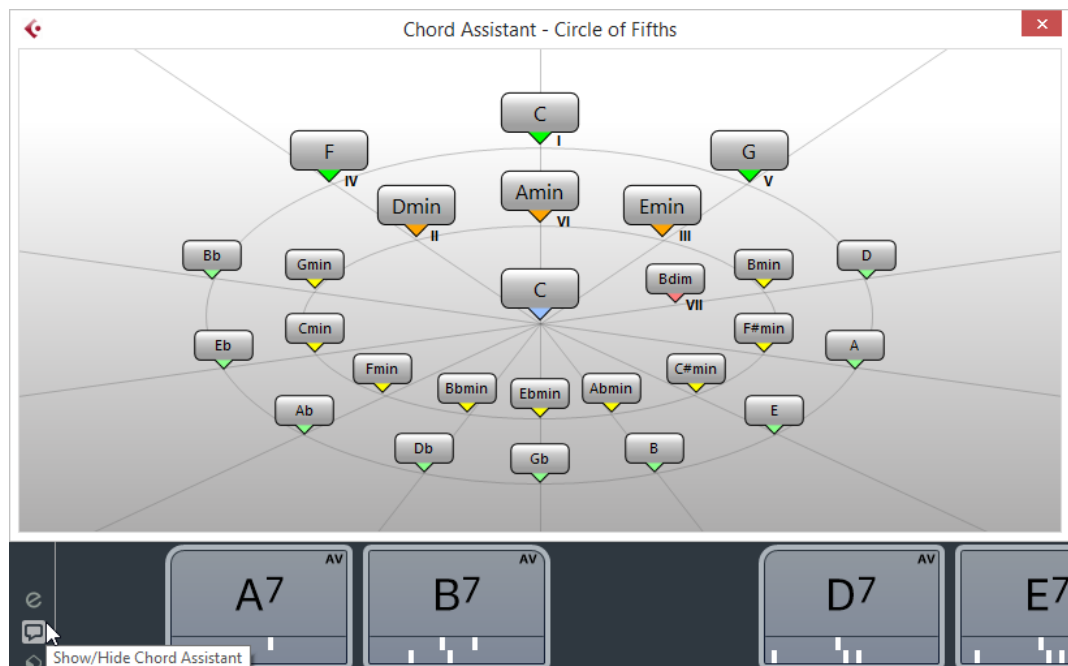

You must define an origin chord as follows:

- Right-click the chord pad with the chord you want to use as origin and select **Use X as Origin for Chord Assistant**.

The **Chord Assistant** window shows suggestions for follow-on chords that you can assign to the chord pads.

## Chord Assistant – Circle of Fifths Mode

The **Chord Assistant** window shows the chords in an interactive visualization of the circle of fifths.

The origin chord that defines the current key is shown in the center of the **Chord Assistant** window. The tonic (I) of that key is displayed above the center. The outer circle shows the twelve major chords ordered in intervals of fifths.

The inner circle displays the corresponding parallel minor chords.

The roman numerals mark the chords of the current key with their scale degree. You can use these chords to create typical chord progressions. However, you can also use the other chords for more creative results.

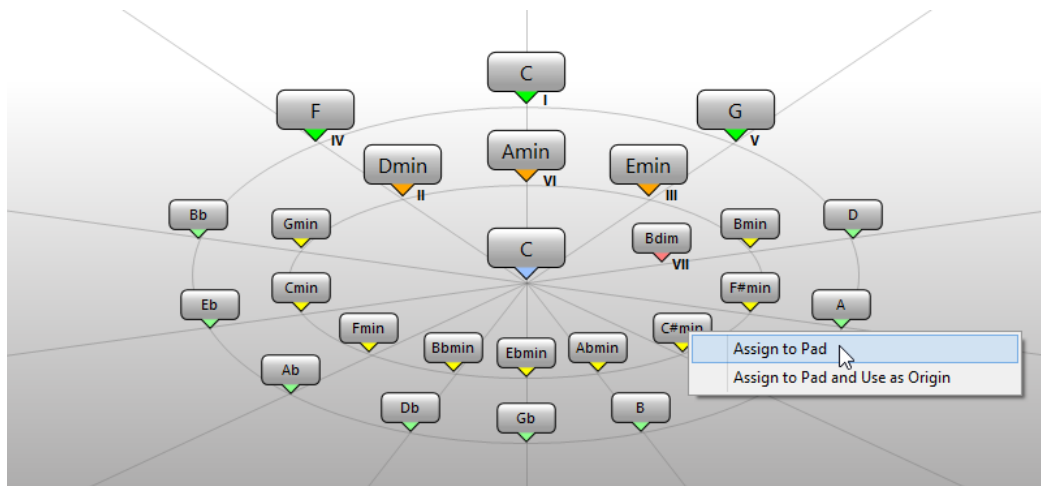

- To play a chord, click it.  
The last 3 chords that you clicked are shown in bold.
- To assign a chord to the next unassigned chord pad, right-click the suggested chord and select **Assign to Pad**.  
You can also drag the suggested chord and drop it on a chord pad.
- To assign a suggestion to the next unassigned chord pad and use this chord as origin, right-click the chord and select **Assign to Pad and Use as Origin**.

### NOTE

The **Circle of Fifths** is also available in the **Chord Assistant** window for the chord track.

## Chord Assignment

Some chords are preassigned to the chord pads. But you can also assign your own chords.

To assign chords to chord pads, you can use:

- The chord **Editor** window
- The **Chord Assistant – Circle of Fifths** window
- Your MIDI keyboard
- The chord events from the chord track



## Unassigning Chord Pads

You can clear all chord assignments from the chord pads to start from scratch.

---

### PROCEDURE

- To the left of the chord pads, open the **Functions Menu** and select **Unassign All Pads**.
- 

## Assigning Chords with the Chord Editor

If you know exactly which chord you want to assign to a specific chord pad, you can use the **Chord Editor**.

---

### PROCEDURE

1. Move the mouse pointer to the left edge of the chord pad, and click **Open Editor**.
  2. In the **Chord Editor** window, use the chord definition buttons to define a root note, a chord type, a tension, and a bass note.  
The new chord is triggered automatically to give an acoustic feedback.
- 

## Assigning Chords with the Chord Assistant – Circle of Fifths Mode

If you have a chord that you want to use as a starting point for a chord progression, but you do not know how to create such a progression, you can use the **Chord Assistant – Circle of Fifths** window.

---

### PROCEDURE

1. Right-click the chord pad that you want to use as a starting point and activate **Use X as Origin for Chord Assistant**.

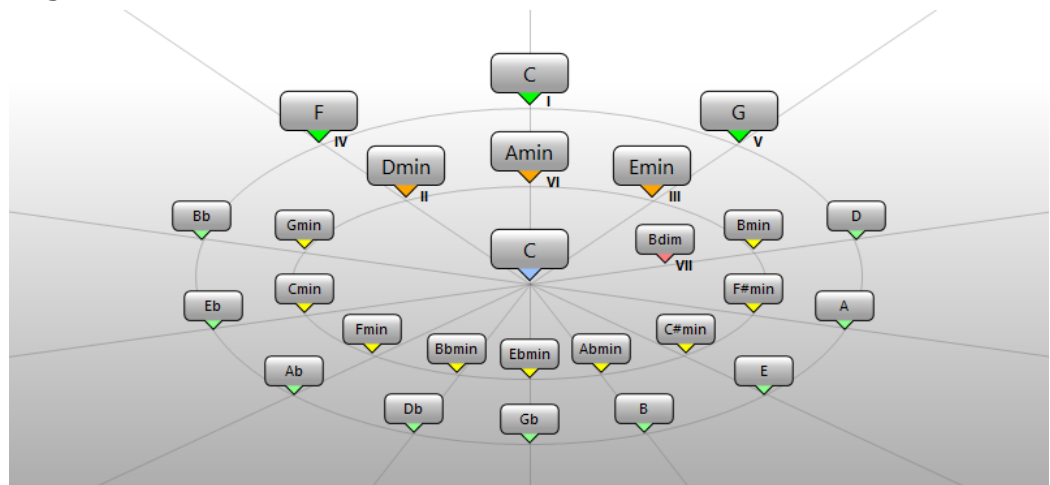

The **Chord Assistant** window opens, and the borders of the chord pad change their color to indicate that the assigned chord is now used as origin.

The origin chord is displayed in the center, and the chords that belong to the scale are shown above it. The numerals indicate the scale degree of the chords. These help you to create chord progressions.

2. In the **Chord Assistant** window, click the chord symbols to trigger the corresponding chords.
3. To assign a chord, drag it from the **Chord Assistant** window and drop it on the chord pad.

**NOTE**

If one of the next chord pads is free, you can also right-click the chord in the **Chord Assistant** window and select **Assign to Pad**. This assigns the chord to the next free pad.

---

## Assigning Chords with the MIDI Keyboard

If you know which chord you want to assign to a specific chord pad, you can use a MIDI keyboard or the **On-Screen Keyboard**.

**PREREQUISITE**

You have selected a MIDI track or an instrument track.

---

**PROCEDURE**

1. Right-click the chord pad that you want to use for the new chord, and select **Assign Pad from MIDI Input**.  
The borders of the chord pad change their color to indicate that it is now ready for recording.
2. On your MIDI keyboard or on the **On-Screen Keyboard**, press the keys for the chord that you want to assign.  
The chord and its voicing are assigned to the chord pad, and you hear an acoustic feedback of the chord.

**NOTE**

The assigned voicing can be changed by the **Adaptive Voicing** setting. Therefore, if you want to keep the voicing for that specific pad, right-click the chord pad and select **Lock** from the context menu.

---

**RELATED LINKS**

[Adaptive Voicing](#) on page 759

## Assigning Chords from the Chord Track

You can assign the chord events from the chord track to the chord pads.

**PREREQUISITE**

You have added a chord track with chord events to your project.

---

**PROCEDURE**

- To the left of the chord pads, click the **Functions Menu** button, and select **Assign Pads from Chord Track**.  
If chords are already assigned to the chord pads, a warning message informs you that all previous assignments will be overwritten.
- 

**RESULT**

The chord events are assigned to the chord pads in the same order as they appear on the chord track.

**NOTE**

Chord events that have more than one occurrence on the chord track are only assigned once.

---

RELATED LINKS

[Adding the Chord Track](#) on page 731

[Adding Chord Events](#) on page 733

## Swapping Chord Assignments

You can swap the chord assignments of 2 pads.

---

PROCEDURE

- Click a chord pad and drag it to another chord pad.  
While you drag, the border of the destination chord pad changes its color.

---

RESULT

When you drop the pad on another, the chord assignments are swapped together with their settings, except for the **Adaptive Voicing Reference**.

## Copying Chord Assignments

You can copy the chord assignment of one pad and paste it on another pad.

---

PROCEDURE

- **Alt**-click a chord pad and drag it to another chord pad.  
While you drag, the border of the destination chord pad changes its color.

---

RESULT

When you drop the pad on another, the first pad's assignment is copied to the destination chord pad together with its settings, except for the **Adaptive Voicing Reference**.

## Playing Back and Recording Chords

You can play back and record chords that are assigned to chord pads using MIDI or instrument tracks.

There are two different **Chord Pad Output Modes** that determine if chords that are assigned to chord pads can be played back and recorded using any or using exclusive MIDI or instrument tracks:

- **Chord Pad Output Mode: On**  
Allows you to play back and record chord pads using any MIDI or instrument track where **Record Enable** or **Monitor** is activated.
- **Chord Pad Output Mode: Off**  
Allows you to play back and record chord pads using exclusive MIDI or instrument tracks where **Record Enable** or **Monitor** is activated, and where **Chord Pads** is selected as a MIDI input in the **Input Routing** pop-up menu.

---

NOTE

If **Record-Enable allows MIDI Thru** is deactivated in the **Preferences** dialog (**Record—MIDI** page), you must activate **Monitor** to use the chord pads.

---

RELATED LINKS

[Chord Pads Zone](#) on page 747

[Recording Chords on the Chord Track](#) on page 758

[Recording Chords on Instrument Tracks](#) on page 757

[Playing Back Chord Pads Using Any Instrument Track](#) on page 756

[Playing Back Chord Pads Using Exclusive Instrument Tracks](#) on page 756

## Playing Back Chord Pads Using Any Instrument Track

You can play back chord pads using any MIDI or instrument track where **Record Enable** or **Monitor** is activated.

### PREREQUISITE

You have connected and set up a MIDI keyboard.

---

### PROCEDURE

1. In the global track controls area of the track list, click **Add Track** .
2. Click **Instrument**.
3. Open the **Instrument** pop-up menu and select a VST instrument.
4. Click **Add Track**.  
The instrument track is added to the track list, and the control panel of the selected VST instrument is opened.
5. On the instrument track, click **Record Enable** or **Monitor**.

### NOTE

If **Record-Enable allows MIDI Thru** is deactivated in the **Preferences** dialog (**Record—MIDI** page), you must activate **Monitor** to use the chord pads.

6. Select **Project > Chord Pads > Show/Hide Chord Pads** to open the **Chord Pads**.
7. Activate **Chord Pad Output Mode**.
8. Press some keys on your MIDI keyboard to trigger the chords that are assigned to the chord pads.

---

### RELATED LINKS

[Add Track Dialog – Instrument](#) on page 107

[Chord Pads Setup Dialog](#) on page 765

[Changing the Pads Remote Range](#) on page 769

## Playing Back Chord Pads Using Exclusive Instrument Tracks

You can play back chord pads using exclusive MIDI or instrument tracks where **Record Enable** or **Monitor** is activated, and where **Chord Pads** is selected as a MIDI input in the **Input Routing** pop-up menu.

### PREREQUISITE

You have set up a MIDI keyboard.

---

### PROCEDURE

1. In the global track controls area of the track list, click **Add Track** .
2. Click **Instrument**.
3. Open the **Instrument** pop-up menu and select a VST instrument.
4. Click **Add Track**.  
The instrument track is added to the track list, and the control panel of the selected VST instrument is opened.

5. On the instrument track, click **Record Enable** or **Monitor**.

**NOTE**

If **Record-Enable allows MIDI Thru** is deactivated in the **Preferences** dialog (**Record—MIDI** page), you must activate **Monitor** to use the chord pads.

---

6. In the **Inspector** for the instrument track, open the **Input Routing** pop-up menu, and select **Chord Pads**.
  7. Select **Project > Chord Pads > Show/Hide Chord Pads** to open the **Chord Pads**.
  8. Deactivate **Chord Pad Output Mode**.
  9. Press some keys on your MIDI keyboard to trigger the chords that are assigned to the chord pads.
- 

**RESULT**

The instrument track now receives MIDI data exclusively from the chord pad device. You can use a connected MIDI keyboard to trigger the chord pads. This still works if you hide the **Chord Pads** from view.

**NOTE**

On the **Chord Pads** page of the **Studio Setup** dialog, you can select your connected MIDI keyboard from the **MIDI Input** pop-up menu. This is useful if you want to use a specific MIDI keyboard exclusively for triggering the chord pads.

---

## Recording Chords on Instrument Tracks

You can record chords that are triggered by chord pads on MIDI or instrument tracks.

**PREREQUISITE**

You have connected and set up a MIDI keyboard, you have opened and set up the chord pads, and you have added an instrument or a MIDI track for which a VST instrument is loaded.

---

**PROCEDURE**

1. On the instrument track, click **Record Enable** or **Monitor**.

**NOTE**

If **Record-Enable allows MIDI Thru** is deactivated in the **Preferences** dialog (**Record—MIDI** page), you must activate **Monitor** to use the chord pads.

---

2. On the **Transport** panel, activate **Record**.
  3. On your MIDI keyboard, press the keys that trigger the chord pads.
- 

**RESULT**

The triggered chords are recorded on the track. The note events are automatically assigned to different MIDI channels according to their pitches. Note events that correspond to the soprano voice are assigned to MIDI channel 1, alto is assigned to MIDI channel 2, and so on.

**AFTER COMPLETING THIS TASK**

Open the **Key Editor** and fine-tune your recorded MIDI parts using the chord editing functions, for example. You can also use **MIDI > Dissolve Part** to dissolve the recorded chords by pitches/channels.

## Recording Chords on the Chord Track

You can record chords that are triggered by chord pads on the chord track. This way, you can easily create chord events for a lead sheet, for example.

### PREREQUISITE

You have connected and set up a MIDI keyboard, you have opened and set up the chord pads, and you have added an instrument or a MIDI track for which a VST instrument is loaded.

---

### PROCEDURE

1. On the instrument track, click **Record Enable** or **Monitor**.

#### NOTE

If **Record-Enable allows MIDI Thru** is deactivated in the **Preferences** dialog (**Record—MIDI** page), you must activate **Monitor** to use the chord pads.

2. Select **Project > Add Track > Chord**.  
The chord track is added to the track list.
3. In the **Inspector** for the chord track, click **Record Enable**.
4. On the **Transport** panel, activate **Record**.
5. On your MIDI keyboard, press the keys that trigger the chord pads.

---

### RESULT

The chord events are recorded on the chord track.

#### NOTE

The recorded chord events may sound different from the chord pad playback. This is because the voicing settings for the chord track differ from the chord pad voicings.

---

### RELATED LINKS

[Chord Track](#) on page 130

[Chord Functions](#) on page 731

[Voicings](#) on page 737

## Player Setup

The **Player Setup** allows you to select a player and a voicing setting that is typical for that kind of player, and determine if the notes of a chord are played as plain chords, as a pattern, or as sections.

- To open the **Player Setup**, click **Show/Hide Player Setup**.

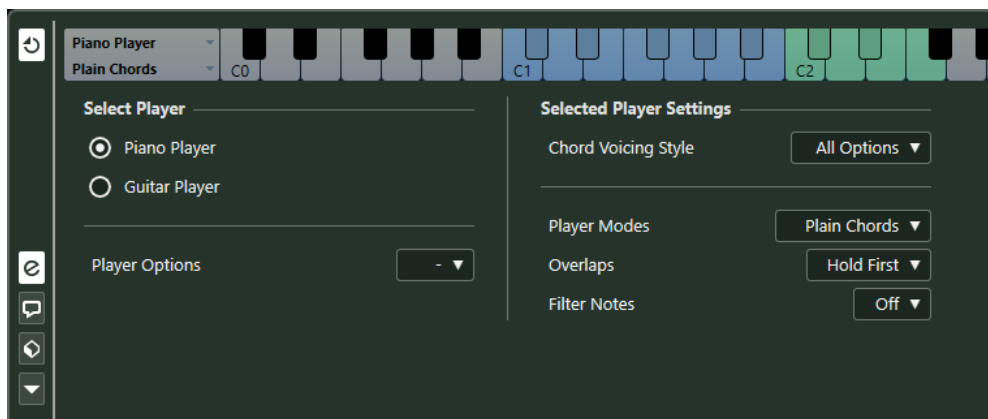

In the **Select Player** section, the following options are available:

#### List of Added Players

Shows the added players, and allows you to activate a player and use its voicing style and play mode for the chord pads.

#### Player Options

Allows you to add a player and to rename or remove the current player.

In the **Selected Player Settings** section, the following options are available:

#### Chord Voicing Style

Allows you to select a chord voicing style for the selected player. This determines how chords are played back, and what pitches are used.

#### Player Modes

- **Plain Chords** triggers all notes of a chord simultaneously.
- **Pattern** plays an arpeggio that is based on the notes of the pattern.
- **Sections** controls the playback of single notes or groups of notes of a chord.

#### RELATED LINKS

[Players and Voicings](#) on page 759

[Voicings](#) on page 737

[Player Setup](#) on page 758

## Players and Voicings

Different types of instruments and styles have different voicing libraries. These determine how the chords are played back, and which pitches are played. These voicings are referred to as players.

#### RELATED LINKS

[Voicings](#) on page 737

## Adaptive Voicing

In Cubase, the adaptive voicing setting ensures that pitches in chord progressions do not change abruptly.

Adaptive voicing is activated and the voicings of the chord pads are determined automatically according to specific voice leading rules.

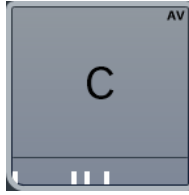

If you want to set the voicing of a specific chord pad manually, and do not want it changed automatically, you can use the voicing control to the right of a chord pad. When you assign your own voicing, adaptive voicing is deactivated for that chord pad, so that the pad does no longer follows the voice leading rules of the voicing reference. To activate adaptive voicing again, right-click the chord pad and activate **Adaptive Voicing**.

To lock the voicing for a chord pad, you can right-click the pad and activate **Lock**. This locks this pad for editing and remote control changes, and deactivates **Adaptive Voicing**. To unlock the chord pad again, right-click the pad and deactivate **Lock**.

## Player Modes—Plain Chords

You can control the playback of plain chords.

- Click **Show/Hide Player Setup** to open the **Player Setup**, and in the **Player Modes** pop-up menu, select **Plain Chords**.



The following options are available:

### Overlaps

Allows you to select what happens with the notes of the first chord when you play a chord without releasing the previous chord.

- **Hold First** holds the notes of the first chord. No note-off message is sent. If the chords have common notes, these are not triggered again.
- **Legato** releases the notes of the first chord, except for the common notes. These are held and not triggered again.
- **Stop First** releases the notes of the first chord including the common notes.

### Filter Notes

Allows you to select which keys are filtered.

- **Off** filters nothing.
- **From MIDI Thru** filters unassigned keys, and keys that are assigned as remote keys for voicings, tensions, and transpose.

### RELATED LINKS

[Chord Pads Setup Dialog](#) on page 765

## Player Modes—Pattern

If you select **Pattern** in the **Player Modes** pop-up menu, this allows you to play the notes that make up the chord one after another as an arpeggio based on the notes of the pattern.

- Click **Show/Hide Player Setup** to open the **Player Setup**, and in the **Player Modes** pop-up menu, select **Pattern**.



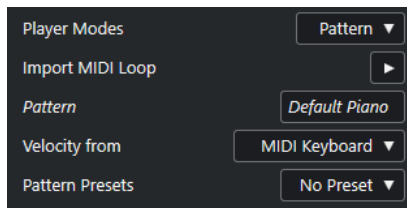

The following options are available:

In the **Selected Player Settings** section, the following options are available:

### Import MIDI Loop

Allows you to select a MIDI loop that is used as a pattern.

### Pattern

Allows you to drop a MIDI part from the event display that is used as a pattern. The name of the selected loop or part is shown.

### Velocity from

- **Pattern** uses the velocity values from the MIDI loop or the MIDI part that is selected as a pattern.
- **MIDI Keyboard** allows you to determine the velocity values by pressing the keys on your MIDI keyboard harder or softer.

### Pattern Presets

Allows you to save pattern presets.

## Using the Pattern Player

You can play back the pattern of a MIDI loop or a MIDI part with chord pads. This plays back the pattern with the notes that make up the chord.

---

### PROCEDURE

1. To the left of the chord pads, activate **Show/Hide Player Setup**.
2. In the **Selected Player Settings** section, open the **Player Modes** pop-up menu, and select **Pattern**.

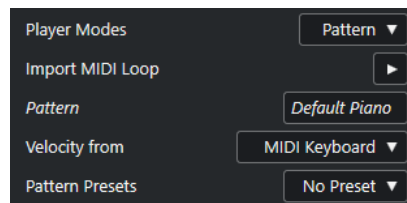

3. Perform one of the following actions:
  - Click **Import MIDI Loop** to select a MIDI loop that you want to use as a pattern.
  - Drag a MIDI part from the event display and drop it on the **Pattern** field.

### NOTE

The loop or part must have between 3 and 5 voices. In the **MediaBay**, the number of voices is indicated in the **Voices** column of the **Result** list.

---

The loop or part is taken as a reference and defines how the chord is played.

4. In the **Velocity from** field, select a velocity source for the notes.
-

RELATED LINKS

[Assigning Voices to Notes](#) on page 744

[Setting up the Results List Columns](#) on page 510

## Using Different Players on Multiple Tracks

You can set up different players with different sounds on different tracks. If you record-enable these tracks and play the chord pads, each track uses a dedicated player.

---

PROCEDURE

1. In the global track controls area of the track list, click **Add Track** .
2. Click **Instrument**.
3. In the **Count** value field, select the number of tracks that you want to add.
4. Open the **Instrument** pop-up menu and select a VST instrument.
5. Click **Add Track**.  
The instrument tracks are added to the track list, and the control panels of the selected VST instrument are opened.
6. Select **Project > Chord Pads > Show/Hide Chord Pads** to open the **Chord Pads**.
7. Activate **Chord Pad Output Mode**.
8. Click **Show/Hide Player Setup**.
9. Select the first instrument track, select a sound for the VST instrument, and set up a player. For example, select a piano sound and activate **Piano Player**.

NOTE

When setting up the player for a track, make sure that **Record Enable** or **Monitor** is only active for this particular track.

- 
10. Select the second instrument track, select a sound for the VST instrument, and set up another player.  
For example, select a guitar sound and activate **Guitar Player**.
  11. Select the next instrument track, and proceed as for the other 2 tracks.  
For example, select a string sound, click **Player Options**, and select **Add Basic Player**.
  12. Select all instrument tracks, and click **Record Enable**.

---

RESULT

You can now play the chord pads and use the remote control parameters for tensions and transpose to change all chord symbols for each player simultaneously. However, if you change the **Voicing**, only the selected player is affected.

RELATED LINKS

[Add Track Dialog – Instrument](#) on page 107

## Player Modes—Sections

You can control the playback of single notes or groups of notes, so called sections, of a chord that is assigned to a chord pad. Sections hold the chord notes, starting from bottom to top: the first section represents the lowest note or voicing of a chord, usually the bass. The second section represents the tenor, and so on.

- Click **Show/Hide Player Setup** to open the **Player Setup**, and in the **Player Modes** pop-up menu, select **Sections**.

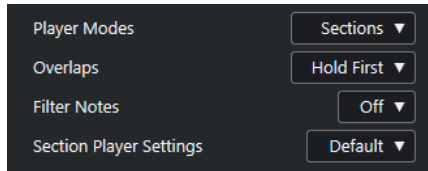

The following options are available:

### Overlaps

Allows you to select what happens with the notes of the first chord when you play a chord without releasing the previous chord.

- **Hold First** holds the notes of the first chord. No note-off message is sent. If the chords have common notes, these are not triggered again.
- **Legato** releases the notes of the first chord, except for the common notes. These are held and not triggered again.
- **Stop First** releases the notes of the first chord including the common notes.

### Filter Notes

Allows you to select which keys are filtered.

- **Off** filters nothing.
- **From MIDI Thru** filters unassigned keys, and keys that are assigned as remote keys for voicings, tensions, and transpose.

### Section Player Settings

Opens the **Custom Section Player Settings** dialog.

#### RELATED LINKS

[Chord Pads Setup Dialog](#) on page 765

[Custom Section Player Settings Dialog](#) on page 763

## Custom Section Player Settings Dialog

The custom settings for the section player allow you to determine how the sections are triggered, how they are distributed, or if they are played at all. Only sections with remote keys assigned are available.

- In the **Player Setup**, open the **Player Modes** pop-up menu and select **Sections**, then open the **Section Player Settings** menu and select **Custom**.

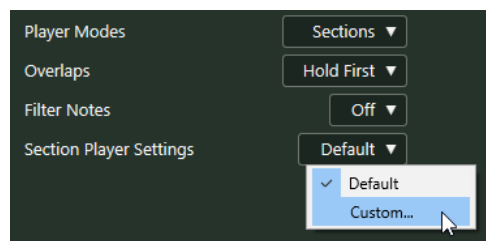

The following settings are available:

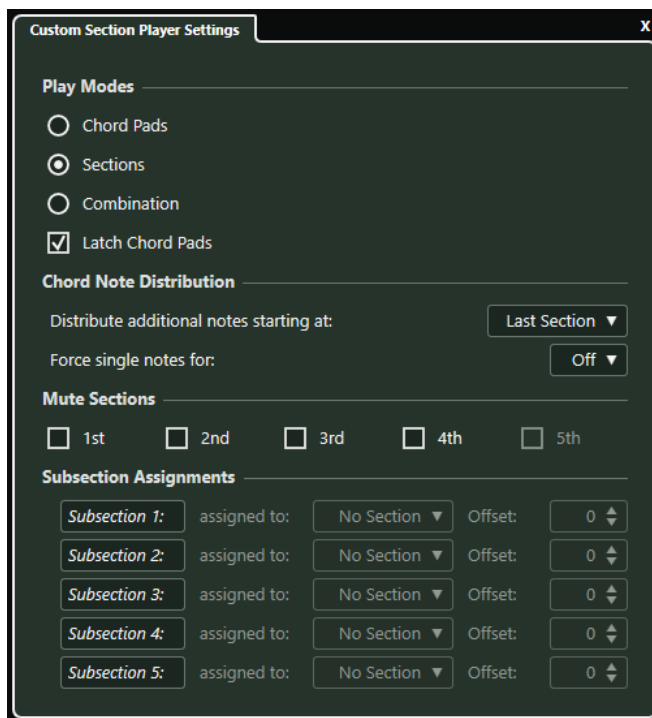

### Play Modes

- **Chord Pads**  
Allows you to hear the chord notes that correspond to the section if you press the remote key for a specific section on your MIDI keyboard.
- **Sections**  
On your MIDI keyboard, first press a key that is assigned to a chord pad, then press the remote key for a specific section to hear the chord notes that correspond to the section.
- **Combination**  
Combines sections and chord pads so that it does not matter whether you first press the remote key for the chord pad or for the section.
- **Latch Chord Pads**  
Activate this for sections and combination modes. This way, if you release the remote key for the chord pad, you will still hear the sections if you keep the section remote keys pressed.

### Chord Note Distribution

Allows you to determine how chord notes are distributed among the sections if the chord that is assigned to the chord pad has more notes than sections.

### Mute Sections

Excludes a section from being played. This is useful if you want to exclude specific voicings from playback.

### Subsection Assignments

These are available if you have set up remote keys for subsections on the **Player Remote Control** tab.

- Open the **assigned to** pop-up menu to assign a subsection to a section.
- Use the **Offset** controls to specify an offset from the section. This way, when you press the remote key for the subsection, you will hear the chord notes that correspond to the section, transposed by the specified offset.

## Playing Back Chord Sections

You can play back chord sections of a chord pad. You can play the sections and their corresponding chord notes by using the remote keys that are assigned to them together with the remote keys that are assigned to a chord pad. To view and edit the remote key assignment for the sections, you can open the **Player Remote Control** tab.

### PREREQUISITE

You have added an instrument track with an instrument assigned to your project. You have record-enabled the instrument track. You have a MIDI keyboard connected and set up. In the chord pads zone, you have activated **Chord Pad Output Mode**.

---

### PROCEDURE

1. Click **Show/Hide Player Setup**, and in the **Player Modes** pop-up menu activate **Sections**. On the keyboard, the section remote range is highlighted in brown.



2. On your MIDI keyboard, press any key that corresponds to the pads remote range. This normally triggers the chord pad, however, in **Sections** mode, you do not hear anything until you press a section remote key.
3. On your MIDI keyboard, press any key that corresponds to the section remote range.

---

### RESULT

The chord section of the chord whose chord pad you triggered is played back. You can press any other key in the section remote range to play different sections of the same chord, or press them all at once. You can use the remote keys for voicing, tension, and transpose to add variety.

## Chord Pads Setup Dialog

The **Chord Pads Setup** dialog allows you to change the remote key assignments and the layout of the chord pads.

- To open the **Chord Pads Setup** dialog, click **Set up Chord Pads**.

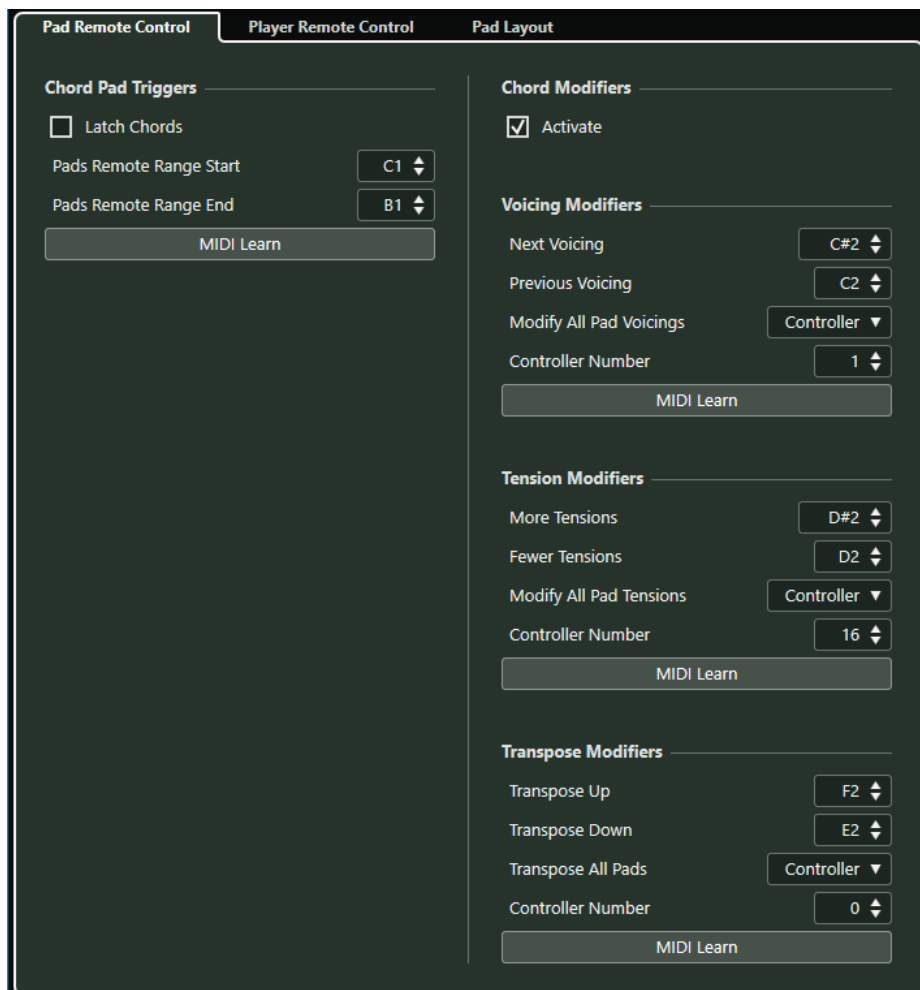

### Pad Remote Control

Allows you to specify a range of remote keys that trigger the chords that are assigned to the chord pads. Here, you can also set up chord modifiers that allow you to specify how the chords are played back.

### Player Remote Control

Allows you to specify a range of remote keys that trigger the chord notes, and that select or mute players.

### Pad Layout

Allows you to change the layout that is used for the chord pads.

#### RELATED LINKS

[Pad Remote Control Tab](#) on page 766

[Player Remote Control Tab](#) on page 769

[Pad Layout Tab](#) on page 771

## Pad Remote Control Tab

The **Pad Remote Control** tab in the **Chord Pads Setup** dialog allows you to specify a range of remote keys that trigger the chords that are assigned to the chord pads.

- To open the **Pad Remote Control** tab, click **Set up Chord Pads**, and in the **Chord Pads Setup** dialog, click **Pad Remote Control**.

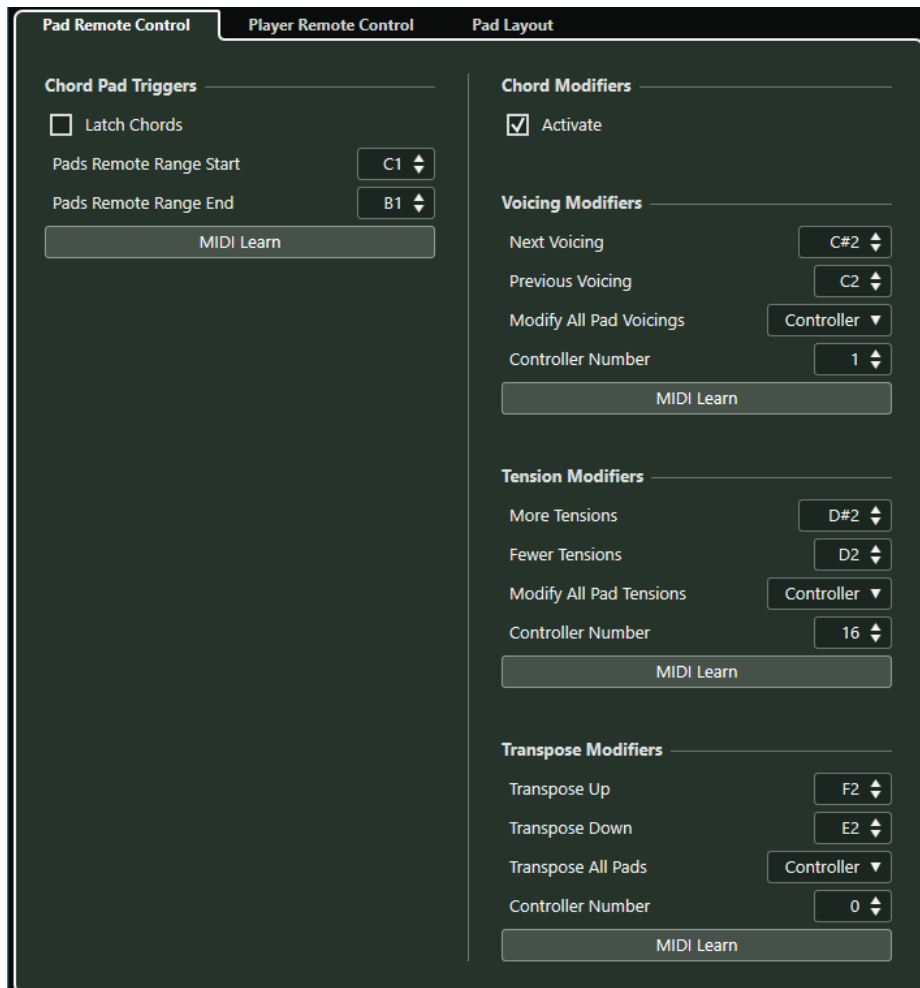

In the **Chord Pad Triggers** section, the following options are available:

#### Latch Chords

Activate this if you want the chord pad to play back until it is triggered again.

#### Pads Remote Range Start

Allows you to set the start note for the remote range. By default, this is set to C1.

#### Pads Remote Range End

Allows you to set the end note for the remote range. By default, this is set to B1.

#### MIDI Learn

Activates/Deactivates the **MIDI Learn** function to assign MIDI input to the pads remote range.

In the **Chord Modifiers** section, the following options are available:

#### Activate

Activates/Deactivates the remote key assignment for the parameters voicings, tensions, and transpose. If this option is deactivated, only the remote key assignment for the pads remote range is active.

#### NOTE

If you use the remote keys for voicings, tensions, or transposition after releasing the remote key for the chord pad, the chord pad that you last played is affected.

**NOTE**

If you use MIDI controllers that are already assigned to other remote control features, for example, the **Track Quick Controls** or the **VST Quick Controls**, all previous assignments are lost.

---

In the **Voicing Modifiers** section, the following options are available:

**Next Voicing**

Plays back the next voicing of the last played chord.

**Previous Voicing**

Plays back the previous voicing of the last played chord.

**Modify All Pad Voicings**

Allows you to set the voicings for all chord pads using one of the following modifiers:

- **No Modifier**
- **Aftertouch**
- **Pitchbend**
- **Controller**

If you select **Controller**, you can set the controller number in the **Controller Number** field.

**MIDI Learn**

Activates/Deactivates the **MIDI Learn** function to assign MIDI input to the parameters for changing voicings.

In the **Tension Modifiers** section, the following options are available:

**More Tensions**

Plays back the last played chord with more tensions.

**Fewer Tensions**

Plays back the last played chord with fewer tensions.

**Modify All Pad Tensions**

Allows you to set the tensions for all chord pads using one of the following modifiers:

- **No Modifier**
- **Aftertouch**
- **Pitchbend**
- **Controller**

If you select **Controller**, you can set the controller number in the **Controller Number** field.

**MIDI Learn**

Activates/Deactivates the **MIDI Learn** function to assign MIDI input to the parameters for changing tensions.

In the **Transpose Modifiers** section, the following options are available:

**Transpose Up**

Plays back the last played chord and transposes it upwards.

**Transpose Down**

Plays back the last played chord and transposes it downwards.



### Transpose All Pads

Allows you to transpose all chord pads using one of the following modifiers:

- **No Modifier**
- **Aftertouch**
- **Pitchbend**
- **Controller**

If you select **Controller**, you can set the controller number in the **Controller Number** field.

### MIDI Learn

Activates/Deactivates the **MIDI Learn** function to assign MIDI input to the parameters for changing transpose.

## Changing the Pads Remote Range

You can widen the pads remote range to access more chord pads. If you want to use a wider key range on your MIDI keyboard for regular playing, you can narrow the pads remote range.

---

### PROCEDURE

1. Click **Set up Chord Pads**.
2. Open the **Pad Remote Control** tab to open the remote control assignments.
3. Do one of the following:
  - Click **MIDI Learn** so that the button lights up, and on your MIDI keyboard, press the 2 keys that you want to assign as range start and range end.
  - Enter a new value in the **Pads Remote Range Start** and **Pads Remote Range End** fields.

---

### RESULT

On the keyboard, the indication for pads remote range is changed.

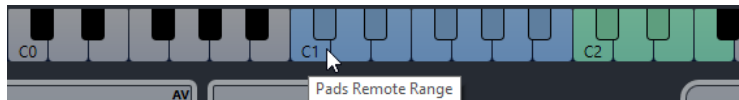

## Player Remote Control Tab

The **Player Remote Control** tab in the **Chord Pads Setup** dialog allows you to specify a range of remote keys that trigger the chords that are assigned to the sections.

- To open the **Player Remote Control** tab, click **Set up Chord Pads**, and in the **Chord Pads Setup** dialog, click **Player Remote Control**.

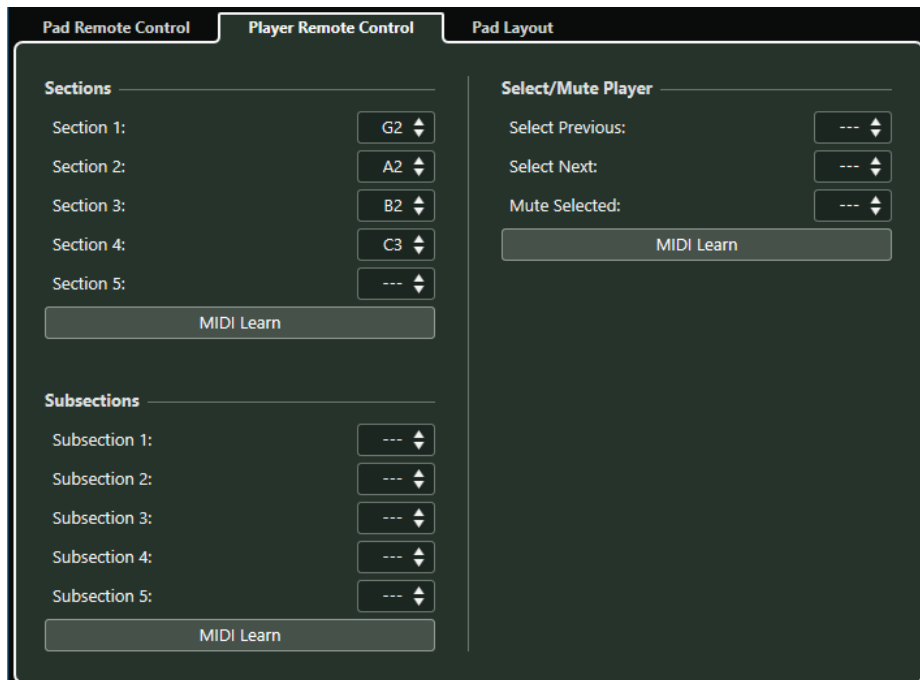

### Sections

Allows you to assign remote keys for up to 5 sections. You can use the section remote keys together with a pad remote key to trigger the chord notes that correspond to the sections.

By default, **Section 1** is set to G2, **Section 2** is set to A2, **Section 3** is set to B2, and **Section 4** is set to C3.

### MIDI Learn

Activates/Deactivates the **MIDI Learn** function to assign MIDI input to the sections.

### Select/Mute Player

Allows you to assign remote keys for player navigation and muting if you use different players on multiple tracks.

### MIDI Learn

Activates/Deactivates the **MIDI Learn** function to assign MIDI input to the parameters for selecting and muting players.

### Subsections

Allows you to assign remote keys for up to 5 subsections. You can use the subsection remote keys together with a pad remote key to trigger the chord notes that correspond to the section transposed by the offset that is specified by its subsection.

### MIDI Learn

Activates/Deactivates the **MIDI Learn** function to assign MIDI input to subsections.

### RELATED LINKS

[Player Modes—Sections](#) on page 762

## Pad Layout Tab

The **Pad Layout** tab in the **Chord Pads Setup** dialog allows you to change the layout that is used for the chord pads.

### NOTE

By default, the keyboard layout is active, but you can change to a grid layout if you prefer. After changing the pad layout, you may need to adjust the remote setup.

- To open the **Pad Layout** tab, click **Set up Chord Pads**, and in the **Chord Pads Setup** dialog, click **Pad Layout**.

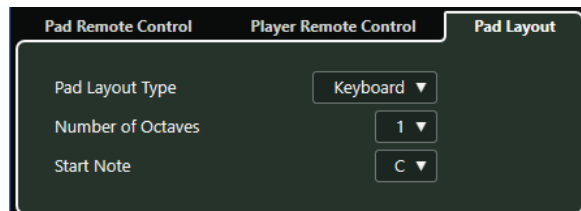

### Pad Layout Type

Activate **Keyboard** to show the chord pads in a keyboard layout.

Activate **Grid** to show the chord pads in a grid layout.

### Number of Octaves/Number of Rows

In **Keyboard** mode, you can select the number of octaves that you want to display.

In **Grid** mode, you can select the number of rows that you want to display.

### Start Note

In **Keyboard** mode, you can select the start note for the first chord pad.

### Number of Columns

In **Grid** mode, you can select the number of columns that you want to display.

## Chord Pads Presets

**Chord Pads Presets** are templates that can be applied to newly created or to existing chord pads.

**Chord Pads Presets** contain the chords that are assigned to the chord pads, as well as the player configurations including any pattern data that you have imported via the **MediaBay** or by using drag and drop. **Chord Pads Presets** allow you to quickly load chords, or reuse player settings. The **Chord Pads Presets** menu is located to the left of the chord pads. **Chord Pads Presets** are organized in the **MediaBay**, and you can categorize them with attributes.

- To save/load a chord pads preset, click **Chord Pads Presets** and select **Save Chord Pads Preset/Load Chord Pads Preset**.

You can also load only the assigned chords from a preset, without loading the player configurations. This is useful if you want to use specific chords that you have saved as a preset, but do not want to alter your current player setting.

- To load only the chords of **Chord Pads Presets**, click **Chord Pads Presets** and select **Load Chords from Preset**.

In the same way, you can also load only the player configurations of **Chord Pads Presets**. This is useful if you have saved very complex player settings and want to reuse them on other chord pads without changing the assigned chords.

- To load only the player settings of **Chord Pads Presets**, click **Chord Pads Presets** and select **Load Players from Preset**.

## Saving Chord Pads Presets

If you have set up the chord pads, you can save them as **Chord Pads Presets**.

---

### PROCEDURE

1. To the left of the chord pads, click **Chord Pads Presets** and select **Save Chord Pads Preset**.
2. In the **New Preset** section, enter a name for the new preset.

### NOTE

You can also define attributes for the preset.

3. Click **OK** to save the preset and exit the dialog.
- 

## Creating Chord Events from Chord Pads

You can use the chords assigned to the chord pads to create chord events in the **Project** window.

---

### PROCEDURE

- Click a chord pad, and drag it on the chord track.
- 

### RESULT

A chord event is created.

### RELATED LINKS

[Recording Chord Events with a MIDI Keyboard](#) on page 746

## Creating MIDI Parts from Chord Pads

You can use the chords assigned to the chord pads to create MIDI parts in the **Project** window.

---

### PROCEDURE

- Click a chord pad, and drag it on a MIDI or instrument track.
- 

### RESULT

A MIDI part is created. It contains the MIDI events that build up the chord and has a length of one bar.

# Transformer

The **Transformer** is a powerful tool for search and replace functions on MIDI data.

You can use the **Transformer** as follows:

- You set up filter conditions to find certain elements.  
This can be elements of a certain type, with certain attributes or values, or on certain positions, in any combination. You can combine any number of filter conditions and make composite conditions using **And/Or** operators.
- You select the basic function to be performed.  
The options include **Transform**, for changing properties of the found elements, **Delete**, for removing the elements, **Insert**, for adding new elements based on the found positions of other elements, and more.
- You set up a list of actions, which specify exactly what is done.  
This is not necessary for all functions.

By combining filter conditions, functions, and the specific actions, you can perform very powerful processing.

To master the **Transformer**, you need some knowledge about how MIDI messages are structured. However, there is also a rich selection of presets, allowing you to access its processing powers without delving into its more complicated aspects.

## RELATED LINKS

[Presets](#) on page 781

## Window Overview

The **Transformer** allows you to combine filter conditions, functions, and actions to perform very powerful MIDI processing.

- To open the **Transformer**, select a MIDI track, open the **MIDI Inserts** section, open the **Select Effect Type** pop-up menu, and select **Transformer**.

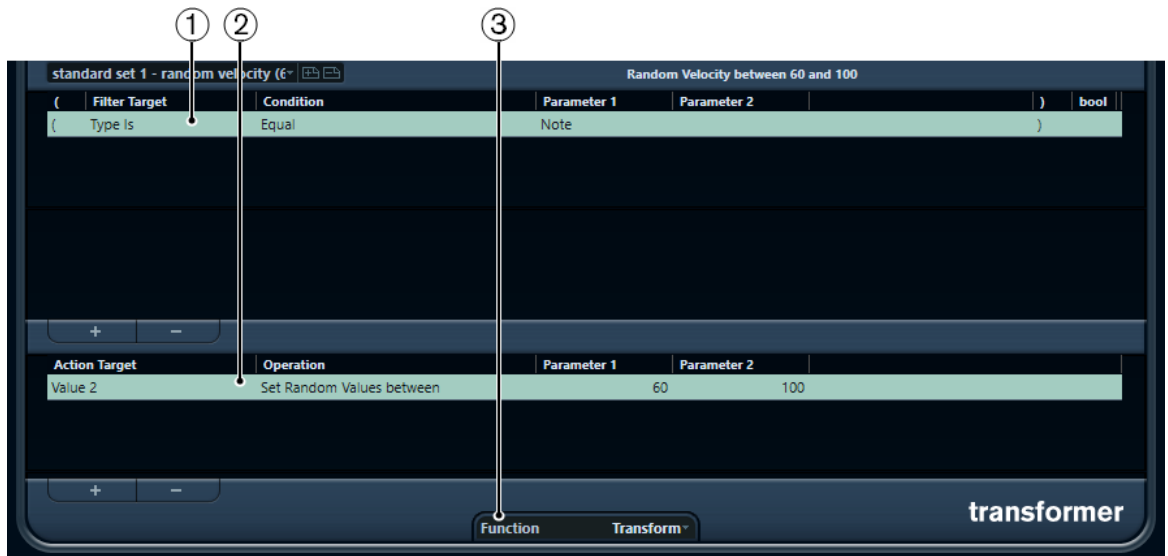

- 1 Filter Conditions**  
Allows you to specify the conditions such as type, attribute, value, or position that a specific element must meet to be found. You can combine any number of filter conditions using AND/OR operators.
- 2 Action list**  
Allows you to set up a list of actions that specifies exactly what is done. This is not necessary for all functions.
- 3 Function pop-up menu**  
Allows you to select a function.

## Filter Conditions

The upper list is where you set up the filter conditions, determining which elements to find. The list can contain one or several conditions, each on a separate line.

To set up a filter condition, make the following settings:

### Left bracket

Together with the right bracket, this allows you to combine multiple filter conditions, that is, multiple lines with the boolean operators And/Or.

### Filter Target

Sets the property of the element. This setting affects the available options in the other columns.

### Condition

Determines how the **Transformer** compares the property in the **Filter Target** column to the values in the **Parameter** columns. The available options depend on the **Filter Target** setting.

### Parameter 1

Sets which value the element properties are compared to. This depends on the **Filter Target**.

### Parameter 2

Only available if one of the **Range** options is set in the **Condition** column. Allows you to find all elements with values inside or outside the range between **Parameter 1** and **Parameter 2**.

### Right bracket

Together with the left bracket, this allows you to combine several filter conditions.

### bool

Allows you to insert the boolean operators And/Or, when creating conditions with multiple lines.

#### NOTE

If you make a mistake when combining multiple conditions with brackets, this is displayed in the status line.

---

#### NOTE

If you have already defined filter conditions and/or applied a preset, but want to start again from scratch, you can initialize the settings by selecting the **Init** option from the **Presets** pop-up menu.

---

#### NOTE

You can also set up filter conditions by dragging MIDI events directly into the upper list.

If the list contains no entries, a MIDI event dragged into this section will form conditions including the state and type of the event. If it contains entries, the dragged event will initialize the matching parameters. For example, if a length condition is used, the length will be set according to the length of the event.

---

Depending on the **Filter Target** setting, the following options can be selected in the **Condition** column:

### Equal

Has the exact same value as set up in the **Parameter 1** column.

### Unequal

Has any value other than the one set up in the **Parameter 1** column.

### Bigger

Has a value higher than the one set up in the **Parameter 1** column.

### Bigger or Equal

Has a value that is the same as or higher than the one set up in the **Parameter 1** column.

### Less

Has a value lower than the one set up in the **Parameter 1** column.

### Less or Equal

Has a value that is the same as or lower than the one set up in the **Parameter 1** column.

### Inside Range

Has a value that is between the values set up in the **Parameter 1** and **Parameter 2** columns. Note that **Parameter 1** should be the lower value and **Parameter 2** the higher.

### Outside Range

Has a value that is not between the values set up in the **Parameter 1** and **Parameter 2** columns.

### Note is equal to

Is the note specified in the **Parameter 1** column only, regardless of octave. For example, lets you find all C notes, in all octaves. This is only used if the **Filter Target** is set to **Pitch**.

#### NOTE

The conditions for the **Property** filter target are different.

---

## Value 1 and Value 2

MIDI events can be composed of value 1 and value 2.

Value 1 and value 2 have different meanings for different event types:

Event type	Value 1	Value 2
Notes	The Note Number/Pitch.	The velocity of the note.
Poly Pressure	The key that was pressed.	The amount of pressure for the key.
Controller	The type of Controller, displayed as a number.	The amount of Control Change.
Program Change	The Program Change number.	Not used.
Aftertouch	The amount of pressure.	Not used.
Pitchbend	The "fine-tune" of the bend. Not always used.	The coarse amount of bend.
VST 3 Event	Not used.	The value of the VST 3 Event parameter. The value range of the VST 3 event (0.0 to 1.0) is transformed into the MIDI value range (0-127), that is, the VST 3 event value 0.5 corresponds to 64. For some operations that require a higher resolution, you can make use of the "VST 3 Value Operation" parameter.

#### NOTE

System Exclusive events do not use value 1 and 2.

---

## Searching for Note Pitches or Velocities

### PROCEDURE

1. Open the **Filter Target** pop-up menu and select **Value 1** for pitches, or **Value 2** for velocities.



- Optional for pitches: In the **Parameter 1** column, enter a pitch either as note name such as C3, D#4, etc. or as a MIDI note number from 0 to 127.

#### NOTE

To find all notes of a certain key, in all octaves, open the **Condition** pop-up menu and select **Note is equal to**.

---

- Click  below the list to add another condition line.  
**Parameter 1** is automatically set to **Note**. Also, **Value 1** and **Value 2** will be displayed as **Pitch** and **Velocity** respectively.
- 

## Searching for Controllers

---

### PROCEDURE

- Open the **Filter Target** pop-up menu and select **Value 1**.
  - Click  below the list to add another condition line.
  - Open the **Parameter 1** pop-up menu and select **Controller**.  
**Filter Target** is automatically set to **MIDI Controller No.** and the **Parameter 1** column will show the names of the MIDI controllers.
- 

## Searching for MIDI Channels

Searching for MIDI channels is useful if you have recorded MIDI from an instrument sending on several different channels, or if you have imported a MIDI file of type 0 with a single track, containing MIDI events with different channel settings.

---

### PROCEDURE

- Open the **Filter Target** pop-up menu and select **Channel**.
  - In the **Parameter 1** field, enter a MIDI channel from 1 to 16.
  - Open the **Condition** pop-up menu and select an option.
- 

## Searching for Element Types

---

### PROCEDURE

- Open the **Filter Target** pop-up menu and select **Type**.
  - Open the **Parameter 1** pop-up menu and select a type such as note, poly pressure, controller, etc.
  - Open the **Condition** pop-up menu and select an option.
- 

## Searching for Event Contexts

You can perform context-dependent searches. This is especially useful in the **Input Transformer**.

The **Filter Target Last Event** indicates the state of an event which has already passed the **Input Transformer**. The condition must be combined with **Parameter 1** and **Parameter 2**.

---

### EXAMPLE

You can set up the **Input Transformer** or the **Transformer** to perform actions only when the note C1 is pressed.

Filter Target	Condition	Parameter 1	Parameter 2	bool
Type Is	Equal	Note		And
Last Event	Equal	Note is playing	36/C1	

In this example, the action is performed after playing the C1.

Filter Target	Condition	Parameter 1	Parameter 2	bool
Last Event	Equal	Value 1	36/C1	

## Combining Multiple Condition Lines

You can add condition lines and combine them by using boolean And and Or operators and brackets.

- To add a new condition, click **+** below the list.  
The new line is added at the bottom of the list.
- To remove a condition, select it and click **-** below the list.

## Bool Column

In the **bool** column to the right in the list, you can select a boolean operator: And or Or.

A boolean operator combines 2 condition lines and determines the result in the following way:

- And determines that both conditions must be fulfilled for an element to be found.
- Or determines that at least one of the conditions must be fulfilled for an element to be found.

### IMPORTANT

When you add a new condition line, its boolean setting default is And.

### EXAMPLE

You can find elements that are notes and start at the beginning of the third bar.

(	Filter Target	Condition	Parameter 1	Parameter 2	Bar Range/Time Base	)	bool
(	Type Is	Equal	Note			)	And
	Position	Equal	3.01.01.000		PPQ	)	

You can find all events that are notes (regardless of their position) and all events starting at the beginning of the third bar (regardless of their type).

(	Filter Target	Condition	Parameter 1	Parameter 2	Bar Range/Time Base	)	bool
(	Type Is	Equal	Note			)	Or
	Position	Equal	3.01.01.000		PPQ	)	

## Using Brackets

The bracket columns let you enclose 2 or more condition lines, dividing the conditional expression into smaller units. This is only relevant when you have 3 or more condition lines and want to use the boolean Or operator.

You add brackets by clicking in the bracket columns and selecting an option. Up to triple brackets can be selected.

If you add several layers of brackets, these are evaluated from the inside out, starting with the innermost brackets.

Expressions within brackets are evaluated first.

### EXAMPLE

You can find all MIDI notes with the pitch C3, as well as all events (regardless of their type) set to MIDI channel 1.

(	Filter Target	Condition	Parameter 1	Parameter 2	Bar Range/Time Base	)	bool
(	Type Is	Equal	Note			)	And
(	Pitch	Equal		C3		)	Or
	Channel	Equal		1		)	

You can find all notes that either have the pitch C3 or the MIDI channel 1 (but no non-note events).

(	Filter Target	Condition	Parameter 1	Parameter 2	Bar Range/Time Base	)	bool
(	Type Is	Equal	Note			)	And
(	Pitch	Equal		C3		)	Or
	Channel	Equal		1		)	

## Selecting a Function

The pop-up menu at the bottom of the **Transformer** is where you select the function, that is, the basic type of editing to be performed.

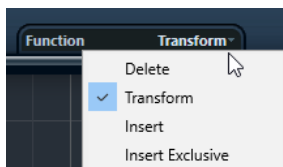

### Delete

Removes or mutes all found elements from the output stream. The actual elements on the track are not affected.

### Transform

Changes one or several aspects of the found elements. You set up exactly what is changed in the action list.

### Insert

Creates new elements and inserts these into the output stream. The new elements will be based on the elements found by the filter conditions, but with any changes you have set up in the action list applied.

Another way of expressing this is that the **Insert** function copies the found elements, transforms them according to the action list and inserts the transformed copies among the existing elements.

### Insert Exclusive

Transforms the found elements according to the action list. All elements that do not meet the filter conditions are removed from the output stream.

#### RELATED LINKS

[Specifying Actions](#) on page 779

## Specifying Actions

You can specify actions, that is, changes that are made to the found elements, in the lower list of the **Transformer**. Actions are relevant for all function types except **Delete**.

Action Target	Operation	Parameter 1	Parameter 2
Value 1	Set to fixed value		2

You can add action lines by clicking **+**, and remove them by selecting it and clicking **-**.

## Action Target

The **Action Target** allows you to select the property that is changed in the events.

### Value 1

Adjusts value 1 in the events. What is displayed for value 1 depends on the event type. For notes, value 1 is the pitch.

### Value 2

Adjusts value 2 in the events. What is displayed for value 2 depends on the event type. For notes, value 2 is the velocity value.

### Channel

Allows you to change the MIDI channel setting.

### Type

Allows you to change the event type, that is, transform aftertouch events to modulation events, or pitchbend events to VST 3 Tuning events.

### Value 3

Adjusts value 3 in the events, which is used for handling of Note-off velocity when searching for properties.

### RELATED LINKS

[Value 1 and Value 2](#) on page 776

## Operation

The **Operation** column allows you to determine what to do with the **Action Target**.

The options on this pop-up menu are different depending on the selected **Action Target**.

### Add

Adds the value specified in the **Parameter 1** column to the **Action Target**.

### Subtract

Subtracts the value specified in the **Parameter 1** column from the **Action Target**.

### Multiply by

Multiplies the **Action Target** with the value specified in the **Parameter 1** column.

### Divide by

Divides the **Action Target** by the value specified in the **Parameter 1** column.

### Round by

Rounds the **Action Target** value using the value specified in the **Parameter 1** column.

### Set Random Values between

Sets the **Action Target** value to a random value within the range specified with **Parameter 1** and **Parameter 2**.

### Set to fixed value

Sets the **Action Target** to the value specified in the **Parameter 1** column.

### Set Relative Random Values between

Adds a random value to the current **Action Target** value. The added random value will be within the range specified with **Parameter 1** and **Parameter 2**. Note that these can be set to negative values.

### Transpose to Scale

This is only available if you set **Action Target** to **Value 1**, and if the filter conditions are specifically set up to find notes (a **Type = Note** filter condition line has been added). When **Transpose to Scale** is selected, you can specify a musical scale using the **Parameter 1** and **Parameter 2** columns. **Parameter 1** is the key (C, C#, D, etc.) while **Parameter 2** is the type of scale (major, melodic or harmonic minor, etc.).

Each note will be transposed to the closest note in the selected scale.

### Use Value 2

This is only available if you set **Action Target** to **Value 1**. If this option is selected, the **Value 2** setting in each event will be copied to the **Value 1** setting.

### Use Value 1

This is only available if you set **Action Target** to **Value 2**. If this option is selected, the **Value 1** setting in each event will be copied to the **Value 2** setting.

### Mirror

This is only available if you set **Action Target** to **Value 1** or **Value 2**. When this option is selected, the values are mirrored around the value set in the **Parameter 1** column.

In the case of notes, this inverts the scale, with the key set in the **Parameter 1** column as center point.

#### RELATED LINKS

[Value 1 and Value 2](#) on page 776

## Presets

You can load **Logical Presets**.

To load a preset, do one of the following:

- Select **MIDI > Logical Presets**, and select an option.
- Open the **List Editor**, and in the filters bar, select a preset from the **Show** section.

#### NOTE

If you set up a key command for a preset, you can conveniently apply the same operation to several selected events in one go.

---

#### RELATED LINKS

[Key Commands](#) on page 854

# Editing Tempo and Time Signature

## Project Tempo Modes

For every project you can set a tempo mode, depending on whether your music has a fixed tempo or if it changes throughout the project.

On the **Transport** panel, you can set the following tempo modes:

- **Fixed Tempo Mode**

If you want to work with one fixed tempo that does not change throughout the project, deactivate **Activate Tempo Track** on the **Transport** panel. You can change the tempo value to set a fixed rehearsal tempo.

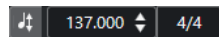

- **Tempo Track Mode**

If the tempo of your music contains tempo changes, activate **Activate Tempo Track** on the **Transport** panel. You can change the tempo value to change the tempo at the cursor. If your project does not contain any tempo changes, the tempo is changed at the project start.

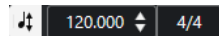

### RELATED LINKS

[Setting up Projects for Tempo Changes](#) on page 787

## Track Time Base

The time base of a track determines if a track can follow the tempo changes of a project that is set to tempo track mode.

In the **Inspector** for MIDI tracks, instrument tracks, and audio-related tracks, you can activate/deactivate **Toggle Time Base** to switch the track time base.

The following time base modes are available:

- **Musical**

Use this mode for material with a musical, that is, tempo-related time base. All tracks that are set to musical time base follow any tempo changes that you add on the tempo track.

### NOTE

For audio events on audio tracks that are set to musical time base, the tempo changes on the tempo track affect only the start position and not the actual audio.

- **Linear**

Use this mode for material with a linear, time-related time base.

RELATED LINKS

[Instrument Track Inspector](#) on page 108

[MIDI Track Inspector](#) on page 115

[Audio Track Inspector](#) on page 105

## Tempo Track Editor

The **Tempo Track Editor** provides an overview of the project tempo settings. It allows you to add and edit tempo events.

To open the **Tempo Track Editor**, do one of the following:

- Select **Project > Tempo Track**.
- Press **Ctrl/Cmd-T**.

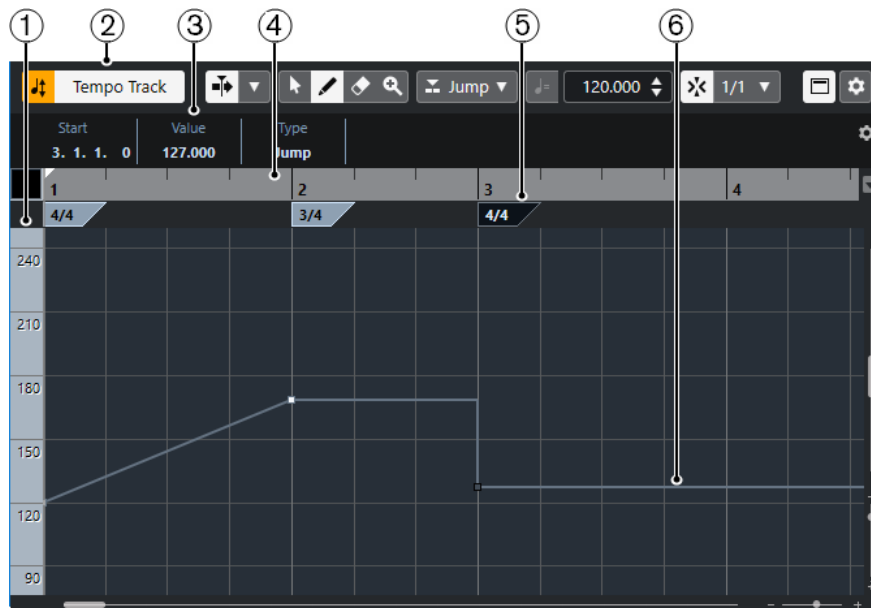

The **Tempo Track Editor** is divided into several sections:

- 1 Tempo scale**  
Shows the tempo scale in BPM.
- 2 Toolbar**  
Contains tools for selecting, adding, and changing tempo and time signature events.
- 3 Info line**  
Shows information about the selected tempo or time signature event.
- 4 Ruler**  
Shows the timeline and the display format of the project.
- 5 Time signature display**  
Shows the time signature events in the project.
- 6 Tempo curve display**  
If your project is set to a fixed tempo, only one tempo event and a fixed tempo is shown.  
If your project is set to tempo track mode, the curve display shows the tempo curve with the tempo events in the project.

## Tempo Track Editor Toolbar

The toolbar contains tools for selecting, adding, and changing tempo and time signature events.

The following tools are available:

### Activate Tempo Track

#### Activate Tempo Track



Switches the project tempo between fixed tempo mode and tempo track mode.

### Left Divider

#### Left Divider



Tools that are placed to the left of the divider are always shown.

### Auto-Scroll

#### Auto-Scroll



Keeps the project cursor visible during playback.

#### Select Auto-Scroll Settings



Allows you to activate **Page Scroll** or **Stationary Cursor** and to activate **Suspend Auto-Scroll When Editing**.

### Tool Buttons

#### Object Selection



Selects events.

#### Draw



Draws events.

#### Erase



Deletes events.

#### Zoom



Zoom in. Hold **Alt** and click to zoom out.

### New Tempo Type

#### Type of New Tempo Points

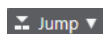

Allows you to select the type of new tempo points. Select **Ramp** if you want new tempo points to change gradually from the previous curve point to the new one. Select **Jump** if you want new tempo points to change instantly. Select **Automatic** if new tempo points should have the same type as the previous curve point.



## Current Tempo

### Current Tempo

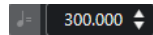

In fixed tempo mode, this allows you to change the current tempo.

## Snap

### Snap On/Off



Restricts horizontal movement and positioning to the positions specified by the **Snap Type**. Time signature events always snap to the beginning of bars.

### Snap Type



Allows you to specify to what positions you want events to snap.

## Right Divider

### Right Divider



Tools that are placed to the right of the divider are always shown.

## Show Info Line

### Show/Hide Info



Opens/Closes the info line.

## Set up Toolbar

### Set up Toolbar



Opens a pop-up menu where you can set up which toolbar elements are visible.

# Tempo Track

You can use the tempo track to create tempo changes within a project.

- To add a tempo track to your project, select **Project > Add Track > Tempo**.
- You can use the tools on the **Project** window toolbar to add and edit tempo events.
- You can use the tempo event editor to edit selected tempo events.
- To select a tempo event, click it with the **Object Selection** tool.
- To select multiple events, drag a selection rectangle with the **Object Selection** tool or **Shift**-click the events.
- To select all tempo events on the tempo track, right-click the tempo track and select **Select All Events** from the context menu.

#### RELATED LINKS

[Tempo Track Inspector](#) on page 136

[Tempo Track Controls](#) on page 136

## Tempo Event Editor

The tempo event editor allows you to edit selected events on the tempo track.

- To open the tempo event editor, activate the **Object Selection** tool and drag a selection rectangle on the tempo track.

The tempo event editor features the following smart controls for specific editing modes:

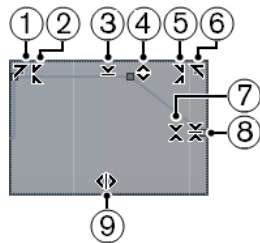

**1 Tilt Left**

If you click in the upper left corner of the editor, you can tilt the left part of the curve. This allows you to tilt the event values at the start of the curve upwards or downwards.

**2 Compress Left**

If you **Alt**-click in the upper left corner of the editor, you can compress or expand the left part of the curve. This allows you to compress or expand the event values at the start of the curve.

**3 Scale Vertically**

If you click in the middle of the upper border of the editor, you can scale the curve vertically. This allows you to raise or lower the event values of the curve in percent.

**4 Move Vertically**

If you click on the upper border of the editor, you can move the entire curve vertically. This allows you to raise or lower the values of the event values of the curve.

**5 Compress Right**

If you **Alt**-click in the upper right corner of the editor, you can compress or expand the right part of the curve. This allows you to compress or expand the event values at the end of the curve.

**6 Tilt Right**

If you click in the upper right corner of the editor, you can tilt the right part of the curve. This allows you to tilt the event values at the end of the curve upwards or downwards.

**7 Scale Around Relative Center**

If you **Alt**-click in the middle right border of the editor, you can scale the curve relative to its center. This allows you to raise or lower the event values horizontally around the center of the editor.

**8 Scale Around Absolute Center**

If you click in the middle right corner of the editor, you can scale the curve absolute to its center. This allows you to raise or lower the event values horizontally around the center of the editor.

**9 Stretch**

If you click on the lower border of the editor, you can stretch the curve horizontally. This allows you to move the event values of the curve to the left or to the right.

## Tempo Changes for Projects

If the tempo track is activated, you can set up tempo changes for your project.

### IMPORTANT

If your project is set to tempo track mode and you set up tempo changes, only tracks that are set to musical time base follow the tempo changes.

---

### NOTE

If you work in tempo track mode, make sure that the display format in the **Project** window ruler is set to **Bars+Beats**. Otherwise, you may get confusing results.

---

If you activate **Activate Tempo Track** on the **Transport** panel, the tempo track curve is displayed in the tempo curve display.

If you know the tempo of your music, you can adjust the tempo value as follows:

- By adding tempo events in the **Tempo Track Editor**.
- By adding tempo events on the tempo track.

### RELATED LINKS

[Setting up Projects for Tempo Changes](#) on page 787

## Setting up Projects for Tempo Changes

When you create a new project, the project tempo is automatically set to fixed tempo mode. If your music contains tempo changes, you must set your project to tempo track mode.

---

### PROCEDURE

- To set your project to tempo track mode, do one of the following:
    - On the **Transport** panel, activate **Activate Tempo Track**.
    - Select **Project > Tempo Track** and activate **Activate Tempo Track**.
- 

### RESULT

The project tempo is now set up to follow the tempo track.

All tracks that are set to musical (tempo-related) time base follow any tempo changes that you add on the tempo track.

### RELATED LINKS

[Track Time Base](#) on page 782

[Tempo Track Controls](#) on page 136

[Tempo Track Editor](#) on page 783

## Setting up a Tempo Track by Adding Tempo Changes

---

### PROCEDURE

1. Select **Project > Add Track > Tempo**.  
The tempo track is added to the track list.
2. On the tempo track, open the **Type of New Tempo Points** pop-up menu and select an option.
3. Do one of the following:

- On the toolbar, select the **Object Selection** tool and click the tempo curve.
- On the toolbar, select the **Draw** tool, and click and draw in the tempo curve display.

**NOTE**

If **Snap** is activated, this determines at which time positions you can insert tempo curve points.

---

**RESULT**

The tempo event is added to the tempo curve.

## Editing Tempo Events

In the **Tempo Track Editor**, you can edit selected tempo events.

Use the following methods:

- With the **Object Selection** tool, click and drag horizontally and/or vertically.
- On the **Info Line**, adjust the tempo value in the **Value** field.

**NOTE**

When editing tempo events on tempo curves, make sure that the display format in the **Project** window ruler is set to **Bars+Beats**. Otherwise, you may get confusing results.

---

Use the following methods to remove tempo events:

- With the **Erase** tool, click the tempo event.
- Select the tempo event and press **Backspace**.

**NOTE**

You cannot remove the first tempo event.

---

Use the following method to change the tempo curve type:

- On the **Info Line**, adjust the tempo curve type in the **Type** field.

## Setting up a Fixed Project Tempo

If your music does not contain tempo changes, and the tempo track is deactivated, you can set up a fixed tempo for your project.

When the tempo track is deactivated, the tempo track curve is grayed out. The fixed tempo is displayed as a horizontal line in the tempo curve display.

If you know the tempo of your music, you can adjust the tempo value in the following areas:

- **Tempo** field on the **Transport** panel
- **Current Tempo** field on the **Tempo Track Editor** toolbar
- **Current Tempo** field on the tempo track

If you do not know the tempo of your music, use one of the following tools to calculate and set it:

- **Beat Calculator**
- **Set Project Tempo from Loop**

RELATED LINKS

[Setting the Project Tempo from a Recording](#) on page 789

[Setting the Project Tempo from an Audio Loop](#) on page 790

## Setting the Project Tempo from a Recording

You can calculate the tempo of freely recorded audio or MIDI material with the **Beat Calculator** and set it as the project tempo.

PREREQUISITE

The **Tempo Track** is deactivated, that is, the tempo mode is set to **Fixed**.

---

PROCEDURE

1. On the **Project** window toolbar, select the **Range Selection** tool.
  2. In the event display, make a selection that covers an exact number of beats of the recording.
  3. Select **Project > Beat Calculator**.
  4. In the **Beats** value field, enter the number of beats that the selection encompasses. The calculated tempo is shown in the **BPM** field.
  5. In the **Insert Tempo into Tempo Track** section, click **At Tempo Track Start**.
- 

RESULT

The project tempo is set to the tempo calculated from your recording.

RELATED LINKS

[Beat Calculator](#) on page 790

## Setting the Project Tempo by Tapping

You can set the tempo of freely recorded audio or MIDI material by tapping.

PREREQUISITE

The tempo track is deactivated, that is, tempo mode is set to **Fixed**.

---

PROCEDURE

1. Activate playback.
2. Select **Project > Beat Calculator**.
3. Click **Tap Tempo**.  
The **Tap Tempo** window opens.

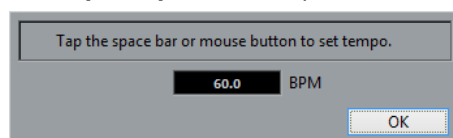

4. Use **Space** to tap the tempo of the recording that is played back. In the **BPM** field, the calculated tempo is updated each time you tap.
  5. Click **OK** to close the window. The tapped tempo is shown in the **BPM** field of the **Beat Calculator**.
  6. Click one of the buttons in the **Insert Tempo into Tempo Track** section to insert the calculated tempo into the tempo track.
-

#### RESULT

The project tempo is set to the tapped tempo.

#### RELATED LINKS

[Setting up a Fixed Project Tempo](#) on page 788

## Setting the Project Tempo from an Audio Loop

You can set the project tempo from the tempo of an audio loop.

#### PREREQUISITE

Your project contains an audio loop that is not in **Musical Mode**.

---

#### PROCEDURE

1. In the **Project** window ruler, set the left locator to the beginning of the audio loop.
2. Set the right locator to the end of the last bar.  
This does not need to match the end of the audio loop, but its number of bars.
3. Select the audio loop.
4. Select **Audio > Advanced > Set Tempo from Event**.  
You are asked if you want to set the global project tempo.
5. Perform one of the following actions:
  - Click **Yes** to adjust the project tempo globally.
  - Click **No** to adjust the project tempo only in the section of the audio event.

---

#### RESULT

The project tempo is set to the tempo calculated for the audio loop.

## Beat Calculator

The **Beat Calculator** is a tool for calculating the tempo of freely recorded audio or MIDI material. It also allows you to set the tempo by tapping.

- To open the **Beat Calculator** for an audio or MIDI recording, select **Project > Beat Calculator**.

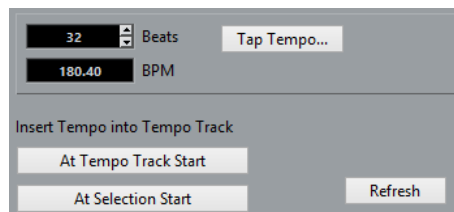

#### Beats

Allows you to enter the number of beats for the selected section of your recording.

#### BPM

Shows the tempo calculated for the selection.

#### Tap Tempo

Opens a window where you can specify a tempo by tapping.

### At Tempo Track Start

If your project is in tempo track mode, the calculated tempo is set as the first tempo curve point. If your project is in fixed tempo mode, the calculated tempo is set for the entire project.

### At Selection Start

If your project is in tempo track mode, the calculated tempo is set as a new tempo event at the start of the selection.

### Refresh

Allows you to recalculate the tempo. This is useful if you adjust the selection, for example.

## Set Definition from Tempo Dialog

The **Set Definition from Tempo** dialog allows you to set up freely recorded audio material to follow a specific tempo.

- To open the **Set Definition from Tempo** dialog for an audio recording, select **Audio > Advanced > Set Definition from Tempo**.

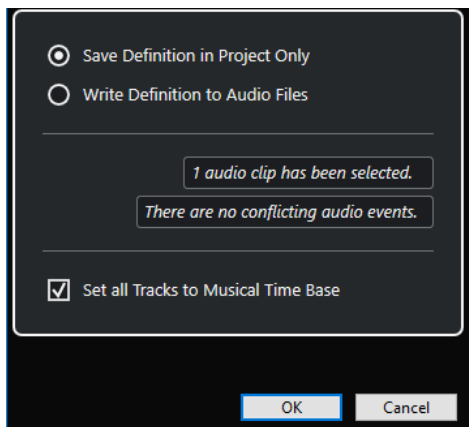

### Save Definition in Project Only

Saves the tempo information in the project file only.

### Write Definition to Audio Files

Writes the tempo information to the selected audio files. This is useful if you want to use them in other projects together with the tempo information.

### Set all Tracks to Musical Time Base

Sets all tracks to musical time base. If this is deactivated, only the tracks with the selected events are set to musical time base.

## Adjusting the Audio Tempo to the Project Tempo

You can adjust the tempo of freely recorded audio material to the project tempo.

---

### PROCEDURE

1. Select the audio events that you want to adjust to the project tempo.
  2. Select **Audio > Advanced > Set Definition from Tempo**.
  3. Optional: Adjust the settings.
  4. Click **OK**.
-

#### RESULT

The tempo information is copied to the audio and the tracks are set to musical time base. This is achieved by applying warping to the events. **Musical Mode** is activated for the audio events. The audio tracks now follow any tempo changes in the project.

## Time Signature Events

You can set up one or more time signatures for a project.

You can set up the first time signature event of your project on the **Transport** panel. You can add further time signature events in the **Tempo Track Editor**.

Time signature events can have click patterns assigned. These allow you to create different grooves and feels for the metronome click. You can create a triplet click pattern for a 4/4 time signature, for example.

#### RELATED LINKS

[Project Window Toolbar](#) on page 32

[Transport Bar](#) on page 44

[Signature Track](#) on page 134

[Adding Time Signature Events in the Tempo Track Editor](#) on page 792

[Setting up a Click Pattern for a Time Signature Event](#) on page 793

## Adding Time Signature Events in the Tempo Track Editor

---

#### PROCEDURE

1. Select **Project > Tempo Track** to open the **Tempo Track Editor**.
2. Select **Draw** on the toolbar, and in the time signature display, click at the time position where you want to insert the time signature event.
3. Edit the numerator and the denominator to change the value of the time signature event.

#### NOTE

You can also select the time signature event and edit the time signature value on the info line.

---

#### RESULT

The time signature event is added at the specified time position. The timeline and the event displays for the **Project** window and the editors reflect the changes.

## Adding Time Signature Events on the Signature Track

You can add multiple time signature events for a project. This is useful if you want to change the time signature at a specific bar, for example.

---

#### PROCEDURE

1. Select **Project > Add Track > Signature**.  
The time signature track is added to the track list.
  2. Select **Draw** on the **Project** window toolbar and on the signature track, click at the time position where you want to insert the time signature event.
  3. Edit the numerator and the denominator to change the value of the time signature event.
-



#### RESULT

The time signature event is added at the specified time position. The timeline and the event displays for the **Project** window and the editors reflect the changes.

#### RELATED LINKS

[Signature Track](#) on page 134

## Setting up a Click Pattern for a Time Signature Event

For each signature event in your project, you can set up a metronome click pattern.

---

#### PROCEDURE

1. Double-click the plus sign to open the **Click Pattern Editor**.
  2. Do one of the following:
    - Open the **Pattern** pop-up menu and select one of the presets.
    - Use the **Clicks** setting to define the number of clicks that you want to hear, and click in the event display to set up a new click pattern.
  3. When you are done, click outside the **Click Pattern Editor** to close it.
  4. Repeat this for each signature event for which you want to set up a click pattern.
- 

#### RESULT

If you play back the project and activate the metronome click, the different project parts use the defined click patterns. The **Click Pattern Editor** in the **Transport Bar** shows the pattern at the project cursor position.

#### RELATED LINKS

[Click Pattern Editor](#) on page 219

# Rendering Audio and MIDI

You can render existing material to new audio material.

You can render the following:

- Audio tracks
- Instrument tracks
- Audio events or parts on audio tracks
- MIDI parts on instrument tracks
- Range selections on audio or instrument tracks
- Range selections on multiple audio or instrument tracks

## IMPORTANT

The rendering function does not support side-chain routing.

---

## Render Tracks Dialog

The **Render Tracks** dialog allows you to customize the track render settings.

- To open the **Render Tracks** dialog, deselect all events in the **Project** window, and select one or more audio tracks, instrument tracks, or MIDI tracks, and select **Edit > Render in Place > Render Settings**.

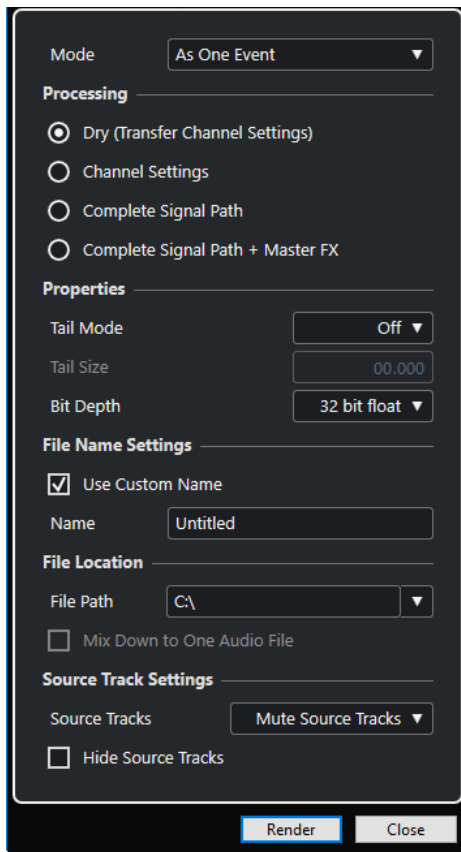

The following settings are available in the **Mode** section:

#### As Separate Events

Creates one or more tracks that contain separate events or parts that are saved as separate audio files.

#### As Block Events

Creates one or more tracks that contain adjacent events/parts that are combined to blocks. Every block is saved as a separate audio file.

#### As One Event

Creates one or more tracks that contain the events/parts and combines them to one event/part. Every combination is saved as a separate audio file.

The following settings are available in the **Processing** section:

#### Dry

Copies all effects and panner settings to new audio tracks. The resulting audio tracks keep the formats of their source tracks. A mono track results in a mono track, for example.

#### Channel Settings

Renders all effects into the resulting audio files. This includes insert effects, channel strip settings, group channel settings, and FX send channel settings. Panner settings are transferred to the new audio tracks. The resulting audio tracks keep the formats of their source tracks. A mono track results in a mono track, for example.

#### Complete Signal Path

Renders the complete signal path into the new audio files, including all channel settings, group channel settings, FX send channel settings, and panner settings. The new audio track is created without effects. Stereo balance panner settings are

activated. The resulting audio file format is determined by the output channel of the source track. A mono track that is routed to a stereo bus results in a stereo audio file.

### **Complete Signal Path + Master FX**

Renders the complete signal path and the master bus settings into the resulting audio files. This includes all channel settings, group channel settings, FX send channel settings, and panner settings. The resulting audio file format is determined by the output channel of the source track. A mono track that is routed to a stereo bus results in a stereo audio file.

The following settings are available in the **Properties** section:

#### **Tail Mode**

Allows you to set the tail mode to **Bars & Beats**, **Seconds** or **Off**.

#### **Tail Size**

Allows you to set a tail length for the rendered files. This adds time at the end of the rendered file to allow reverb and delay tails to fully fade out.

#### **Bit Depth**

Allows you to set the bit depth for the resulting file.

The following settings are available in the **File Name Settings** section:

#### **Use Custom Name**

Activates the use of custom names for the rendered files.

#### **Name**

Allows you to enter a custom name for the rendered files.

The following settings are available in the **File Location** section:

#### **File Path**

Allows you to select a custom folder to which the resulting .wav files are rendered.

#### **Mix down to One Audio File**

Creates one audio file from all your source material. This option is only available if several tracks are selected and **Dry (Transfer Channel Settings)** is deactivated.

The following settings are available in the **Source Track Settings** section:

#### **Source Tracks**

- **Keep Source Tracks Unchanged**  
Keeps the source tracks unchanged.
- **Mute Source Tracks**  
Automatically mutes the source tracks.
- **Disable Source Tracks**  
Disables the source tracks. This option releases CPU and RAM resources and is therefore similar to the **Freeze** function. To reenabte the tracks, right-click the disabled track to open the context menu and select **Enable Track**.
- **Remove Source Tracks**  
Removes the source tracks from the track list.

#### **Hide Source Tracks**

Hides the source tracks after rendering. To show the source tracks again, select the **Visibility** tab in the **Project** window and select the track that you want to show.

#### RELATED LINKS

[Pan Control](#) on page 327

## Rendering Tracks

You can render selected tracks either via the **Render Tracks** dialog or by directly using the **Render (with Current Settings)** command.

---

### PROCEDURE

1. Deselect all events.
2. Select one or more audio, MIDI, or instrument tracks.
3. Select **Edit > Render in Place > Render Settings**.
4. Specify the render options.
5. Click **Render**.

---

### RESULT

All selected source material is processed according to your render settings. Your render options are saved and used for all further render operations.

### NOTE

You can also start the rendering operation directly by selecting **Edit > Render in Place > Render (with Current Settings)**.

---

## Render Selection Dialog

You can render selections of audio events and/or MIDI parts with default settings or with customized settings. The **Render Selection** dialog allows you to customize the selection render settings.

- To open the **Render Selection** dialog, select a range, and select **Edit > Render in Place > Render Settings**.

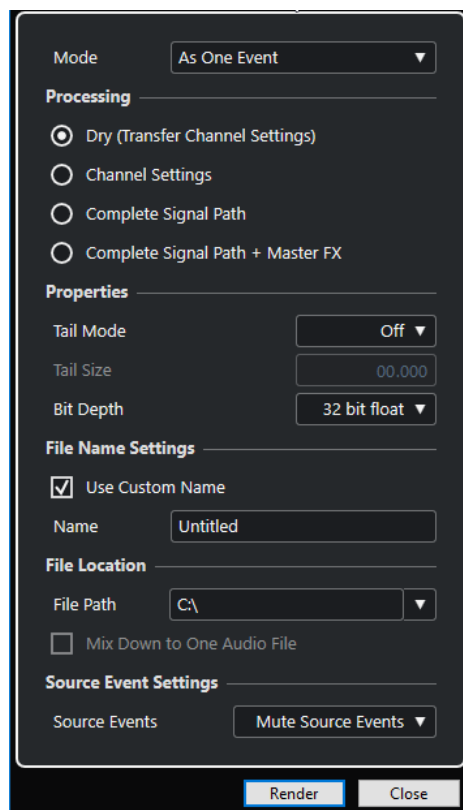

The following settings are available in the **Mode** section:

**As Separate Events**

Creates one or more tracks that contain separate events or parts that are saved as separate audio files.

**As Block Events**

Creates one or more tracks that contain adjacent events/parts that are combined to blocks. Every block is saved as a separate audio file.

**As One Event**

Creates one or more tracks that contain the events/parts and combines them to one event/part. Every combination is saved as a separate audio file.

The following settings are available in the **Processing** section:

**Dry**

Copies all effects and panner settings to new audio tracks. The resulting audio tracks keep the formats of their source tracks. A mono track results in a mono track, for example.

**Channel Settings**

Renders all effects into the resulting audio files. This includes insert effects, channel strip settings, group channel settings, and FX send channel settings. Panner settings are transferred to the new audio tracks. The resulting audio tracks keep the formats of their source tracks. A mono track results in a mono track, for example.

**Complete Signal Path**

Renders the complete signal path into the new audio files, including all channel settings, group channel settings, FX send channel settings, and panner settings. The new audio track is created without effects. Stereo balance panner settings are activated. The resulting audio file format is determined by the output channel of the source track. A mono track that is routed to a stereo bus results in a stereo audio file.

**Complete Signal Path + Master FX**

Renders the complete signal path and the master bus settings into the resulting audio files. This includes all channel settings, group channel settings, FX send channel settings, and panner settings. The resulting audio file format is determined by the output channel of the source track. A mono track that is routed to a stereo bus results in a stereo audio file.

The following settings are available in the **Properties** section:

**Tail Mode**

Allows you to set the tail mode to **Bars & Beats**, **Seconds** or **Off**.

**Tail Size**

Allows you to set a tail length for the rendered files. This adds time at the end of the rendered file to allow reverb and delay tails to fully fade out.

**Bit Depth**

Allows you to set the bit depth for the resulting file.

The following settings are available in the **File Name Settings** section:

**Use Custom Name**

Activates the use of custom names for the rendered files.

**Name**

Allows you to enter a custom name for the rendered files.

The following settings are available in the **File Location** section:

### File Path

Allows you to select a custom folder to which the resulting .wav files are rendered.

### Mix down to One Audio File

Creates one audio file from all your source material. This option is only available if several tracks are selected and **Dry (Transfer Channel Settings)** is deactivated.

The following settings are available in the **Source Event Settings** section:

### Source Events

- **Keep Source Events Unchanged**  
Keeps the source events unchanged.
- **Mute Source Events**  
Automatically mutes the source events.

## Rendering Selections

You can render selections or range selections of audio events and/or MIDI parts via the **Render Selection** dialog.

---

### PROCEDURE

1. Select one or more audio events and/or MIDI parts or make a range selection.
2. Select **Edit > Render in Place > Render Settings**.
3. In the **Render Selection** dialog, specify the render options.
4. Click **Render**.

---

### RESULT

All selected source material is processed according to your render settings. Your render options are saved and used for all further render operations.

### NOTE

You can also start the rendering operation directly by selecting **Edit > Render in Place > Render (with Current Settings)**.

---

# Export Audio Mixdown

The **Export Audio Mixdown** function allows you to mix down and export all audio that is contained between the left and right locators of a project.

- To open the **Export Audio Mixdown** dialog, select **File > Export > Audio Mixdown**.

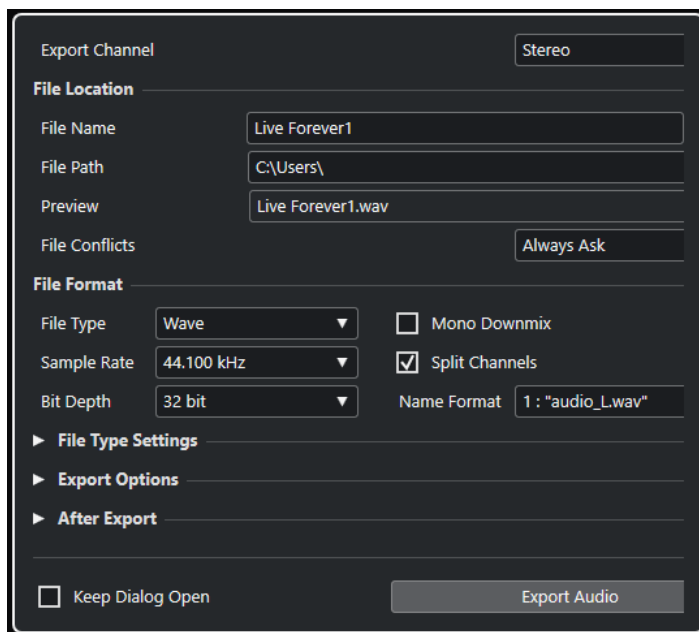

## Export Audio Mixdown Dialog

The **Export Audio Mixdown** dialog allows you to set up how audio is mixed down and exported.

- To open the **Export Audio Mixdown** dialog, select **File > Export > Audio Mixdown**.

The **Export Audio Mixdown** dialog is divided into several sections.



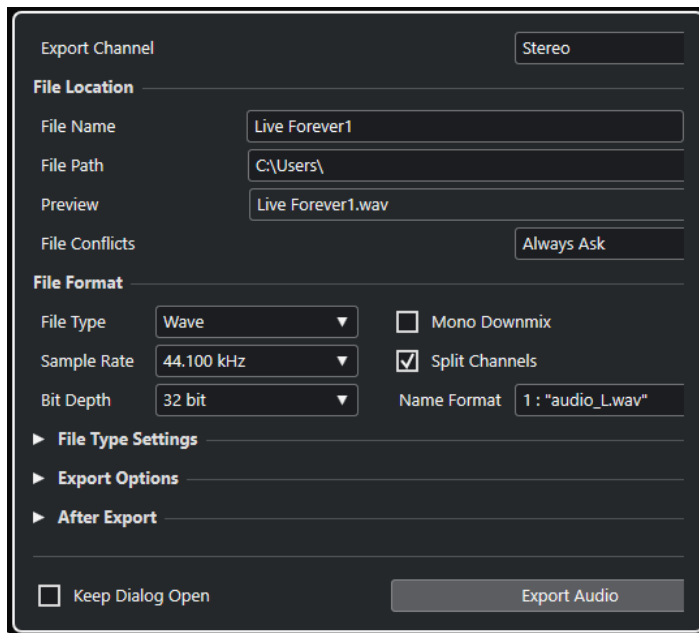

## Export Channel

In the **Export Channel** pop-up menu, you can select a channel for export.

## File Location

In the **File Location** section, the following options are available:

### File Name

Allows you to specify the name of the mixdown file.

Click **File Name Options** to open a pop-up menu with naming options:

- **Set to Project Name** inserts the project name into the **File Name** field.
- **Auto Update Name** adds a number to the file name and increments the number every time you export a file.

Click **Set up Naming Scheme** to open a dialog where you can specify a naming scheme.

### File Path

Allows you to specify the file path of the mixdown file.

Click **Path Options** to open a pop-up menu with file path options:

- **Choose** opens a dialog that allows you to browse for a file location.
- **Use Project Audio Folder** sets the path to the **Audio** folder of your project.
- **Recent Paths** allows you to select recently selected file locations.
- **Clear Recent Paths** allows you to delete all recently selected file locations.

### Preview

Shows the file name with the naming scheme applied.

### File Conflicts

Exporting audio can cause name conflicts with existing files that have the same name. You can define how file name conflicts are resolved:

- **Always Ask** opens a warning that allows you to choose if an existing file should be overwritten or if a new unique file name should be created by adding an incremental number.

- **Create Unique File Name** creates a unique file name by adding an incremental number.
- **Always Overwrite** always overwrites the existing file.

## File Format

In the **File Format** section, the following options are available:

### File Type

Allows you to select a file type for the mixdown file.

### Sample Rate

Allows you to select a sample rate for the mixdown file.

#### NOTE

- This parameter is only available for uncompressed audio file formats and FLAC files.
- If you set the value lower than the project sample rate, the audio quality degrades and the high-frequency content is reduced. If you set the value higher than the project sample rate, the file size increases without increasing the audio quality. For CD burning, select 44.100 kHz, because this is the sample rate used on audio CDs.

### Bit Depth

Allows you to select a bit depth for the mixdown file.

#### NOTE

This parameter is only available for uncompressed audio file formats and FLAC files.

Allows you to select 8-bit, 16-bit, 24-bit, 32-bit (float), or 64-bit (float) files. If you plan to re-import the mixdown file into Cubase, select 32-bit (float). This is the resolution used for audio processing in Cubase. 32-bit (float) files are twice the size of 16-bit files. For CD burning, use the 16-bit option, as CD audio is always 16 bit. In this case, we recommend dithering.

Activating the **UV-22HR** dithering plug-in reduces the effects of quantization noise and artifacts when converting the audio to 16 bit. 8-bit resolution results in limited audio quality and should only be used if required.

### Mono Downmix

Allows you to downmix the 2 channels of a stereo bus to a single mono file.

For stereo, the **Stereo Pan Law** as defined in the **Project Setup** dialog is applied to avoid clipping.

### Split Channels

Allows you to export the 2 channels of a stereo bus as separate mono files.

### Name

Allows you to specify the naming scheme for the split channel files.

## File Type Settings

In the **File Type Settings** section, the settings for the selected file type are available.

## Export Options

In the **Export Options** section, the following options are available:

### Realtime Export

Allows you to export the audio mixdown in real time. Realtime export takes at least the same time as regular playback. Activate this if you use external effects or instruments, or if you use VST plug-ins that require time to update correctly during the mixdown. For further information, refer to the documentation of the respective plug-ins.

#### NOTE

- If you export external effects or instruments in real time, you must also activate **Monitor** for the respective audio channels.
- If the CPU and disk speed of your computer do not allow to export all channels simultaneously in real time, the program stops the process, reduces the number of channels, and starts again. Afterwards, the next batch of files is exported. This is repeated as often as needed to export all selected channels.

### Update Display

Updates the meters during the export process. This allows you to check for clipping, for example.

### Deactivate External MIDI Inputs

Deactivates MIDI inputs that are performed on external devices during the export process.

### After Export

In the **After Export** section, the following options are available:

#### Create New Project

##### NOTE

This option is only available for uncompressed file formats, and if **Use Project Audio Folder** is deactivated.

Creates a new project that contains an audio track for each of the exported channels, as well as the signature and tempo track of the original project.

The tracks will have the corresponding mixdown file as audio event. The track names will be identical with the export channel names. Note that the new project will be the active project.

Activating this option disables the **Insert to Pool** and **Create Audio Track** options.

#### Create Audio Track

Creates an audio event that plays the clip on a new audio track, starting at the left locator. Activating this option also activates the **Pool** option.

#### Insert to Pool

Imports the resulting audio file automatically back into the **Pool** as a clip. Deactivating this option also deactivates the **Create Audio Track** option.

#### Post Process

- **Do Nothing** does nothing after export.
- **Open in WaveLab** opens your mixdown file in WaveLab after export. This requires that WaveLab is installed on your computer.

#### Pool Folder

Allows you to specify a **Pool** folder for the clip.

## General Options

In the bottom section, the following options are available:

### Keep Dialog Open

Activate this to keep the dialog open after clicking **Export Audio**.

### Export Audio

Allows you to export your audio as specified.

#### RELATED LINKS

[File Formats](#) on page 806

## Naming Scheme Dialog

The **Naming Scheme** dialog allows you to define naming schemes for the audio material that you want to export.

The naming attributes that are available in this dialog depend on the channel that you selected for export.

- To open the **Naming Scheme** dialog, open the **Export Audio Mixdown** dialog, and click **Set up Naming Scheme**.

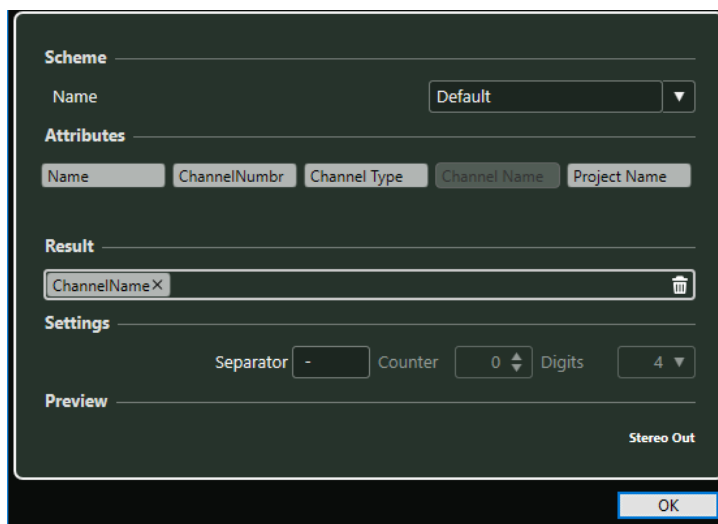

### Scheme

Allows you to save and delete naming schemes.

### Attributes

Holds the following naming scheme attributes:

- **Name**  
Adds the name to the resulting file name.
- **Channel Number**  
Adds the channel number to the resulting file name.
- **Channel Type**  
Adds the channel type to the resulting file name.
- **Channel Name**  
Adds the channel name to the resulting file name.
- **Project Name**  
Adds the project name to the resulting file name.

### Result

Allows you to drop attributes and rearrange them by dragging.

### Settings

Allows you to select separator and counter settings.

- **Separator**  
Divides attributes from each other.
- **Counter**  
The value from which the counter starts counting.
- **Digits**  
The number of number of digits prior to the counter value.

#### Preview

Car\_Engine--Ferrari F340 Spider--003

### Preview

Displays a preview of your current settings.

## Defining Naming Schemes

You can define a naming scheme by combining attributes that determine the structure of the file names for the exported audio files.

---

### PROCEDURE

1. In the **Naming Scheme** dialog, drag up to 5 attributes into the **Result** section.  
You can also double-click an attribute to add it to the **Result** section.
2. In the **Settings** section, double-click the **Separator** text field and enter a separator.  
The **Preview** section displays the file name scheme according to your settings.
3. Click the up or down arrows to set the **Counter**.  
The counter will start counting from this value. You can also double-click the **Counter** value field and enter a value.
4. Click the **Digits** field and select the number of digits from the pop-up menu.  
The **Digits** setting determines how many digits the counters will contain.
5. Optional: Click the **Name** value field in the **Scheme** section and enter a preset name. Press **Return** to save your settings as a preset.

### NOTE

The preset is only available for the channels that are selected in the **Channel Selection** section.

6. Click **OK**.
- 

## Mixing Down to Audio Files

---

### PROCEDURE

1. Set up the left and right locators to encompass the section that you want to mix down.
2. Set up your tracks so that they play back the way you want.  
This includes muting unwanted tracks or parts, making manual **MixConsole** settings, and/or activating the **R** (Read) automation buttons for **MixConsole** channels.

#### IMPORTANT

The setting of the **Output Routing** in the corresponding track **Inspector** determines the channel width of the **Export Audio Mixdown** export. This means if no main output bus is selected, the exported audio file only contains silence.

---

3. Select **File > Export > Audio Mixdown**.
  4. In the **Export Audio Mixdown** dialog, make your changes.
  5. Click **Export Audio**.
- 

#### RESULT

The audio file is exported.

#### IMPORTANT

- If you set the export range in such a way that the effects that are applied to a preceding event, for example reverb, reach into the next, these are heard in the mixdown even though the event itself is not included. To avoid this, mute the first event.
- 

## File Formats

The **File Type** pop-up menu in the **Export** section allows you to select a format and make additional settings for the mixdown file.

### Wave File

This is the most common file format on the PC platform. Wave files have the extension **.wav**.

### AIFC File

This is an audio file format standard defined by Apple Inc. AIFC files are used on most computer platforms. They support compression ratios as high as 6:1 and contain tags in the header. AIFC files have the extension **.aifc**.

### AIFF File

This is an audio file format standard defined by Apple Inc. AIFF files are used on most computer platforms. The files can contain embedded text strings. AIFF files have the extension **.aif**.

### MPEG 1 Layer 3 File

This is a family of standards used for encoding audio-visual information such as movies, video, and music in a digital compressed format. Cubase can read MPEG Layer 2 and MPEG Layer 3. MP3 files are highly compressed files that still provide good audio quality. The files have the extension **.mp3**.

### Windows Media Audio File (Windows only)

This is an audio file format defined by Microsoft Inc. WMA files can be decreased in size with no loss of audio quality. WMA Pro features the possibility of mixing down to 5.1 surround sound. The files have the extension **.wma**.

### FLAC File

This is an open source format that reduces the size of audio files by 50 % to 60 % compared to regular Wave files. The files have the extension **.flac**.

### Ogg Vorbis File

This is an open source, patent-free audio encoding and streaming technology. The Ogg Vorbis encoder uses variable bit rate encoding. It offers compressed audio files of small size, but with comparatively high audio quality. The files have the extension **.ogg**.

### Wave 64 File

This is a proprietary format developed by Sonic Foundry Inc. Wave 64 files offer the same quality as Wave files, but they can be considerably larger than standard Wave files. They are especially suited for long recordings with file sizes over 2 GB. The files have the extension .w64.

#### RELATED LINKS

[File Format](#) on page 802

[File Type Settings](#) on page 802

## Wave Files

Wave files have the extension .wav and are the most common file format on the PC platform.

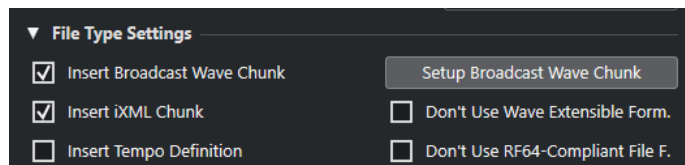

If you select the **Wave File** format for the exported file, you can make the following settings in the **Select Attributes** section:

### Insert Broadcast Wave Chunk

Activates the embedding of additional file information in Broadcast Wave format.

#### NOTE

By activating this option, you create a Broadcast Wave file. Some applications may not be able to handle these files. If you get problems using the file in another application, deactivate **Insert Broadcast Wave Chunk** and export the file again.

### Insert iXML Chunk

Includes additional project-related metadata, such as project name, author, and project frame rate.

### Insert Tempo Definition

This option is only available if **Insert iXML Chunk** is activated. It allows you to include tempo information from the tempo track or from the **Definition** section of the **Sample Editor** in the iXML chunk of the exported files.

### Set up Broadcast Wave Chunk

Opens the **Broadcast Wave Chunk** dialog where you can enter information.

### Don't Use Wave Extensible Format

Deactivates the Wave Extensible format that contains additional metadata, such as the speaker configuration.

### Don't Use RF64-Compliant File Format

Deactivates the RF64-compliant format that allows file sizes to exceed 4 GB.

#### RELATED LINKS

[Attribute Inspector](#) on page 524

## AIFC Files

AIFC files support compression ratios as high as 6:1 and contain tags in the header. AIFC files have the extension `.aifc` and are used on most computer platforms.

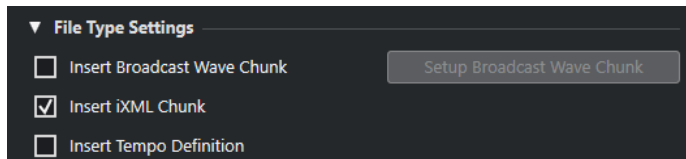

If you select the **AIFC File** format for the exported file, you can make the following settings in the **Select Attributes** section:

### Insert Broadcast Wave Chunk

Activates the embedding of additional file information in Broadcast Wave format.

#### NOTE

By activating this option, you create a Broadcast Wave file. Some applications may not be able to handle these files. If you get problems using the file in another application, deactivate **Insert Broadcast Wave Chunk** and export the file again.

### Insert iXML Chunk

Includes additional project-related metadata, such as project name, author, and project frame rate.

### Insert Tempo Definition

This option is only available if **Insert iXML Chunk** is activated. It allows you to include tempo information from the tempo track or from the **Definition** section of the **Sample Editor** in the iXML chunk of the exported files.

### Set up Broadcast Wave Chunk

Opens the **Broadcast Wave Chunk** dialog where you can enter information.

## AIFF Files

AIFF stands for Audio Interchange File Format, a standard defined by Apple Inc. AIFF files have the extension `.aif` and are used on most computer platforms.

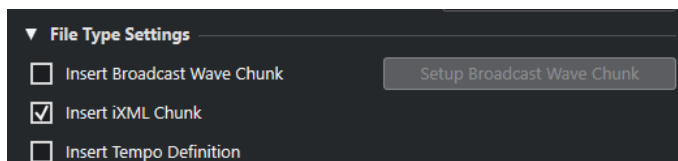

If you select the **AIFF File** format for the exported file, you can make the following settings in the **Select Attributes** section:

### Insert Broadcast Wave Chunk

Activates the embedding of additional file information in Broadcast Wave format.

#### NOTE

By activating this option, you create a Broadcast Wave file. Some applications may not be able to handle these files. If you get problems using the file in another application, deactivate **Insert Broadcast Wave Chunk** and export the file again.



### Insert iXML Chunk

Includes additional project-related metadata, such as project name, author, and project frame rate.

### Insert Tempo Definition

This option is only available if **Insert iXML Chunk** is activated. It allows you to include tempo information from the tempo track or from the **Definition** section of the **Sample Editor** in the iXML chunk of the exported files.

### Set up Broadcast Wave Chunk

Opens the **Broadcast Wave Chunk** dialog where you can enter information.

## MP3 (MPEG 1 Layer 3) files

MP3 files are highly compressed files that still provide good audio quality. They have the extension .mp3.

- To open the **MPEG 1 Layer 3 File Settings**, click **Codec Settings** in the **Select Attributes** section.

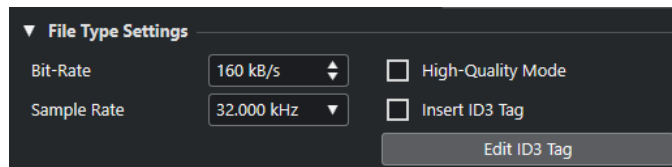

### Bit Rate

Sets the bit rate for the MP3 file. The higher the bit rate, the better the audio quality and the larger the file. For stereo audio, 128 kBit/s is considered to be providing good audio quality results.

### Sample Rate

Sets the sample rate for the MP3 file.

### High Quality Mode

Sets the encoder to a different resampling mode. This may give better results depending on your settings. However, it does not allow you to select the **Sample Rate**.

### Insert ID3 Tag

Includes ID3 Tag information in the exported file.

### Edit ID3 Tag

Opens the **ID3 Tag** dialog that allows you to enter information about the file. This information is embedded in the file and can be displayed by most MP3 playback applications.

## Windows Media Audio Files (Windows only)

The Windows Media Audio format by Microsoft Inc. uses advanced audio codecs and lossless compression. WMA files can be decreased in size with no loss of audio quality. Furthermore, WMA features the possibility of mixing down to 5.1 surround sound. The files have the extension .wma.

- To open the **Windows Media Audio File Settings**, click **Codec Settings** in the **Select Attributes** section.

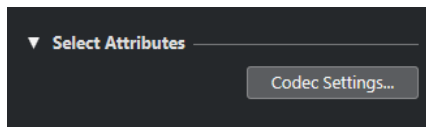

### Codec Settings

Opens the **Windows Media Audio File Settings** dialog.

## Windows Media Audio File Settings Dialog - General Tab

The **General** tab in the **Windows Media Audio File Settings** dialog allows you to specify sample rate, bit depth, and channels for the encoded file.

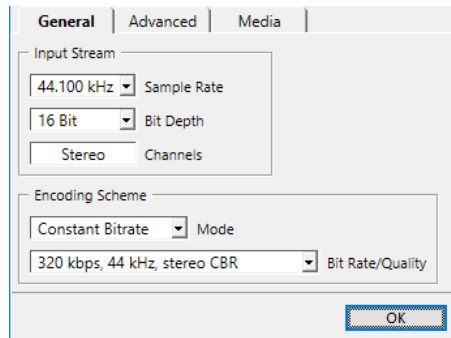

### Sample Rate

Allows you to set the sample rate to 44.100, 48.000, or 96.000 kHz. Set this to match the sample rate of the source material or use the closest available value that is higher than the actual value.

### Bit Depth

Allows you to set the bit depth to 16 bit or 24 bit. Set this parameter to match the bit depth of the source material or use the closest available value that is higher than the actual value.

#### NOTE

Always keep in mind the intended use of the file. For publication on the Internet, you might not want too high bit rates, for example.

### Channels

This setting depends on the chosen output. You cannot change it manually.

### Mode

- Select **Constant Bit Rate** if you want to limit the file size. To calculate the size of a file that is encoded with a constant bit rate, multiply the bit rate by the duration of the file.
- Select **Variable Bit Rate** if you want the bit rate to fluctuate depending on the character and intricacy of the material being encoded. The more complex passages in the source material, the higher the bit rate – and the larger the final file.
- Select **Lossless** to encode the file with lossless compression.

### Bit Rate/Quality

- Allows you to set the bit rate settings depending on the selected mode and/or output channels. The higher the bit rate or quality you select, the larger the final file.

## Windows Media Audio File Settings Dialog - Advanced Tab

The **Advanced** tab in the **Windows Media Audio File Settings** dialog allows you to specify the dynamic range control, that is, the difference in dB between the average loudness and the peak audio level (the loudest sounds) of the audio for the encoded file.

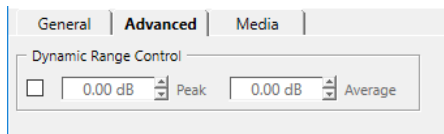

### Dynamic Range Control

The dynamic range is automatically calculated during the encoding process. If you activate this option, you can specify the dynamic range manually.

- If **Dynamic Range Control** is activated and the Quiet Mode of the Windows Media Player is set to Medium Difference, the peak level is limited to the peak value that you specified. If **Dynamic Range Control** is deactivated, the peak level is limited to 12 dB above the average level during playback.
- If **Dynamic Range Control** is activated and the Quiet Mode of the Windows Media Player is set to Little Difference, the peak level is limited to the average value between the peak and average values that you specified. If **Dynamic Range Control** is deactivated, the peak level is limited to 6 dB above the average level during playback.

### Peak

Allows you to set a peak value between 0 and -90 dB.

### Average

Allows you to set a peak value between 0 and -90 dB. However, this affects the overall volume level and can have a negative effect on the audio quality.

## Windows Media Audio File Settings Dialog - Media Tab

The **Media** tab in the **Windows Media Audio File Settings** dialog allows you to enter information about the file.

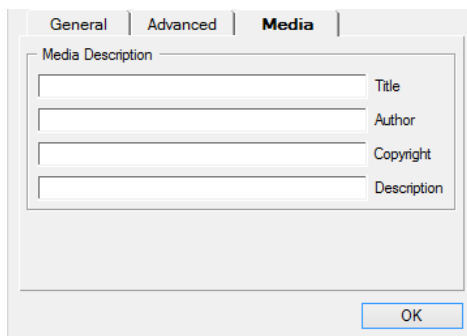

Use the **Title**, **Author**, **Copyright**, and **Description** fields to enter a file description of its content that is embedded in the file header. This can be displayed by some Windows Media Audio playback applications.

## FLAC Files

Free Lossless Audio Codec files are audio files that are typically 50 % to 60 % smaller than regular Wave files.

- To open the **FLAC File Settings**, click **Codec Settings** in the **Select Attributes** section.



### Compression Level

Sets the compression level for the FLAC file. Since FLAC is a lossless format, the level has more influence on the encoding speed than on the file size.

## Ogg Vorbis Files

Ogg Vorbis is an open source, patent-free audio encoding and streaming technology, offering compressed audio files of small size, but with comparatively high audio quality. Ogg Vorbis files have the extension .ogg.

- To open the **OggVorbis File Settings**, click **Codec Settings** in the **Select Attributes** section.



### Quality

Sets the quality for the variable bit rate encoding. This setting determines between which limits the bit rate will vary. The higher the value, the higher the sound quality but also the larger the files.

## Wave 64 Files

Wave 64 is a proprietary format developed by Sonic Foundry Inc. Wave 64 files have the extension .w64.

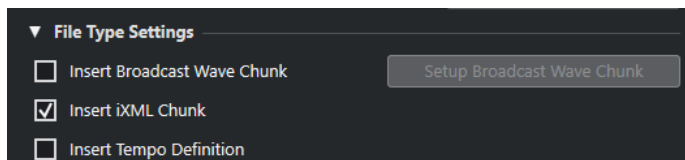

### NOTE

Wave 64 files are a good choice for long recordings where the file sizes exceeds 2 GB. The quality of Wave 64 files is identical to standard Wave files.

---

### Insert Broadcast Wave Chunk

Activates the embedding of additional file information in Broadcast Wave format.

### NOTE

By activating this option, you create a Broadcast Wave file. Some applications may not be able to handle these files. If you get problems using the file in another application, deactivate **Insert Broadcast Wave Chunk** and export the file again.

---

### Insert iXML Chunk

Includes additional project-related metadata, such as project name, author, and project frame rate.

### Insert Tempo Definition

This option is only available if **Insert iXML Chunk** is activated. It allows you to include tempo information from the tempo track or from the **Definition** section of the **Sample Editor** in the iXML chunk of the exported files.

**Set up Broadcast Wave Chunk**

Opens the **Broadcast Wave Chunk** dialog where you can enter information.

# Synchronization

Synchronization is the process of getting 2 or more devices to play back together at the same speed, position, and phase. These devices can range from audio and video tape machines to digital audio workstations, MIDI sequencers, synchronization controllers, and digital video devices.

If you know the position and speed for the master device, you can resolve the speed and position of the slave device to it, so that the 2 devices play in perfect sync with one another.

## Position (Time)

The following clock signals are used to specify time positions:

- Audio word clock  
Specifies time positions in samples.
- Timecode  
Specifies time positions in video frames.
- MIDI clock  
Specifies time positions in musical bars and beats.

## Speed (Clock)

The following clock signals measure the speed of a device:

- Audio word clock  
Measures the sample rate.
- Timecode  
Measures the frame rate.
- MIDI clock  
Measures the tempo.

## Phase

Phase is the alignment of the position and speed components to each other. Each pulse of the speed component should be aligned with each measurement of the position for the most accuracy. Each frame of timecode should be perfectly lined up with the correct sample of audio. Put simply, phase is the very precise position of a synchronized device relative to the master (sample accuracy).

## Master and Slave

Calling one device the master and another one the slave can lead to confusion. Therefore, the timecode relationship and the machine control relationship must be differentiated in this regard.

- **Timecode Master**  
The device generating position information or timecode.

- **Timecode Slave**  
Any device receiving the timecode and synchronizing or locking to it.
- **Machine Control Master**  
The device that issues transport commands to the system.
- **Machine Control Slave**  
The device receiving timecode commands and responding to them.

Cubase can be the machine control master, sending transport commands to an external device which in turn sends timecode and audio clock information back to Cubase. In that case, Cubase would also be the timecode slave.

#### NOTE

In most scenarios, the machine control slave is also the timecode master. Once it receives a play command, that device starts generating timecode for all the timecode slaves to synchronize to.

---

## Timecode Formats

The position of any device is most often described using timecode. Timecode represents time using hours, minutes, seconds, and frames to provide a location for each device. Each frame represents a visual film or video frame.

The following timecode formats are supported:

- **LTC**  
Longitudinal timecode or LTC is an analog signal that can be recorded on tape. It should be used for positional information primarily. It can also be used for speed and phase information as a last resort if no other clock source is available.
- **VITC**  
Vertical interval timecode or VITC is contained within a composite video signal. It is recorded onto video tape and is physically tied to each video frame.
- **MTC**  
MIDI timecode or MTC is identical to LTC except that it is a digital signal transmitted via MIDI.

## Timecode Standards

Timecode has several standards. The subject of the various timecode formats can be very confusing due to the use and misuse of the shorthand names for specific timecode standards and frame rates. The timecode format can be divided into 2 variables: frame count and frame rate.

### Frame count (frames per second)

The frame count of timecode defines the standard with which it is labeled. There are 4 timecode standards:

#### 24 fps Film (F)

This frame count is the traditional count for film. It is also used for HD video formats and commonly referred to as 24 p. However, with HD video, the actual frame rate or speed of the video sync reference is slower, 23.976 frames per second, so timecode does not reflect the actual real time on the clock for 24 p HD video.

#### 25 fps PAL (P)

This is the broadcast video standard frame count for European (and other PAL countries) television broadcast.

### **30 fps non-drop SMPTE (N)**

This is the frame count of NTSC broadcast video. However, the actual frame rate or speed of the video format runs at 29.97 fps. This timecode clock does not run in real time. It is slightly slower by 0.1 %.

### **30 fps drop-frame SMPTE (D)**

The 30 fps drop-frame count is an adaptation that allows a timecode display running at 29.97 fps to actually show the clock-on-the-wall-time of the timeline by dropping or skipping specific frame numbers in order to catch the clock up to real time.

#### **NOTE**

Remember to keep the timecode standard (or frame count) and frame rate (or speed) separate.

---

## **Frame rate (speed)**

Regardless of the frame counting system, the actual speed at which frames of video go by in real time is the true frame rate.

Cubase supports the following frame rates:

### **24 fps**

This is the true speed of standard film cameras.

### **25 fps**

This is the frame rate of PAL video.

### **29.97 fps/29.97 dfps**

This is the frame rate of NTSC video. The count can be either non-drop or drop-frame.

### **30 fps/30 dfps**

This frame rate is not a video standard anymore but has been commonly used in music recording. Many years ago, it was the black and white NTSC broadcast standard. It is equal to NTSC video being pulled up to film speed after a 2-3 telecine transfer. The count can be either non-drop or drop-frame.

#### **IMPORTANT**

Video formats with a variable frame rate (VFR) are not supported.

---

## **Frame count vs. frame rate**

Part of the confusion in timecode stems from the use of frames per second in both the timecode standard and the actual frame rate. When used to describe a timecode standard, frames per second defines how many frames of timecode are counted before one second on the counter increments. When describing frame rates, frames per second define how many frames are played back during the span of one second of real time. In other words: Regardless of how many frames of video there are per second of timecode (frame count), those frames can be moving at different rates depending on the speed (frame rate) of the video format. For example, NTSC timecode (SMPTE) has a frame count of 30 fps. However, NTSC video runs at a rate of 29.97 fps. So the NTSC timecode standard known as SMPTE is a 30 fps standard that runs at 29.97 fps real time.

## **Clock Sources**

Once the position is established, the next essential factor for synchronization is the playback speed. Once 2 devices start playing from the same position, they must run at exactly the same speed in order to remain in sync. Therefore, a single speed reference must be used and all



devices in the system must follow that reference. With digital audio, the speed is determined by the audio clock rate. With video, the speed is determined by the video sync signal.

### Audio clock

Audio clock signals run at the speed of the sample rate used by a digital audio device and are transmitted in several ways:

#### Word clock

Word clock is a dedicated signal running at the current sample rate that is fed over BNC coaxial cables between devices. It is the most reliable form of audio clock and is relatively easy to connect and use.

#### AES/SPDIF Digital Audio

An audio clock source is embedded within AES and SPDIF digital audio signals. This clock source can be used as a speed reference. Preferably, the signal itself does not contain any actual audio (digital black), but any digital audio source can be used if necessary.

#### ADAT Lightpipe

ADAT Lightpipe, the 8-channel digital audio protocol developed by Alesis, also contains audio clock and can be used as a speed reference. It is transmitted via optical cables between devices.

#### NOTE

Do not confuse the audio clock embedded in the Lightpipe protocol with ADAT Sync, which has timecode and machine control running over a proprietary DIN plug connection.

---

### MIDI clock

MIDI clock is a signal that uses position and timing data based on musical bars and beats to determine location and speed (tempo). It can perform the same function as a positional reference and a speed reference for other MIDI devices. Cubase supports sending MIDI clock to external devices but cannot slave to incoming MIDI clock.

#### IMPORTANT

MIDI clock cannot be used to synchronize digital audio. It is only used for MIDI devices to play in musical sync with one another. Cubase does not support being a MIDI clock slave.

---

## Project Synchronization Setup Dialog

The **Project Synchronization Setup** dialog provides a central place to configure a complex synchronized system. In addition to settings for timecode sources and machine control settings, basic transport controls are available for testing the system.

To open the **Project Synchronization Setup** dialog, do one of the following:

- Select **Transport > Project Synchronization Setup**.
- In the **Transport Bar**, **Ctrl/Cmd-click Sync**.

#### NOTE

If you activate **Steinberg SyncStation** as the input source, there are several options for how these commands are routed within the **SyncStation** itself. For details refer to the documentation that comes with the **SyncStation**.

---

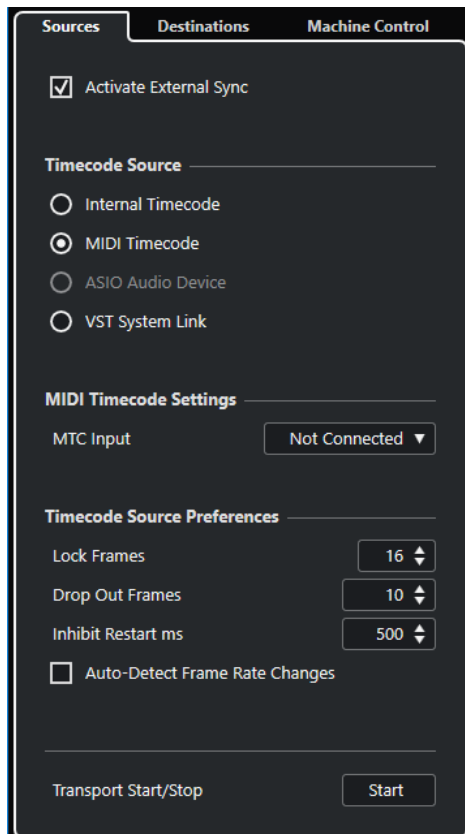

#### RELATED LINKS

[Sources Page](#) on page 818

[Destinations Page](#) on page 821

[Machine Control Page](#)

## Sources Page

The **Sources** page allows you to set up the synchronization inputs, and to determine which external signals enter the application.

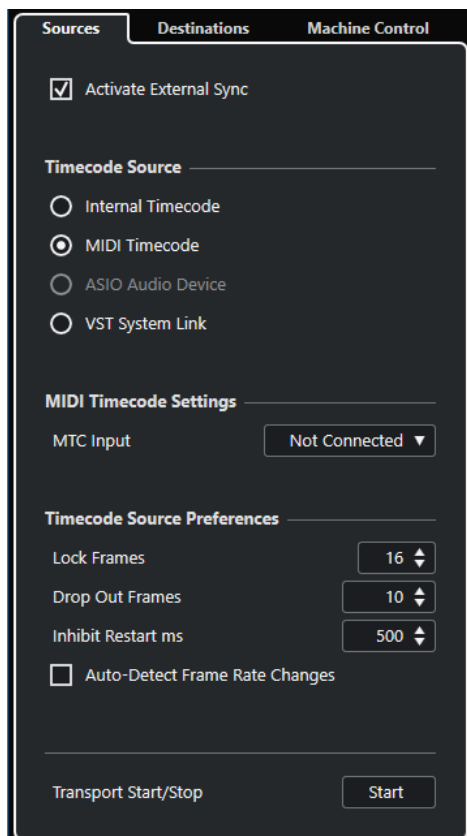

In the topmost section, the following options are available:

#### **Activate External Sync**

Activates/Deactivates the external synchronization.

#### **Timecode Source**

The **Timecode Source** section allows you to determine whether Cubase is acting as timecode master or slave. The following options are available:

##### **Internal Timecode**

Sets Cubase as timecode master that generates all position references for any other device in the system based on the project timeline and the **Project Setup** settings.

##### **MIDI Timecode**

If **Activate External Sync** is activated, this sets Cubase as timecode slave to any incoming MIDI timecode. You can select the **MTC Input** ports in the **MIDI Timecode Settings** section.

##### **ASIO Audio Device (Windows only)**

Only available for audio cards that support the ASIO positioning protocol. These cards have an integrated LTC reader or ADAT sync port and can perform a phase alignment of timecode and audio clock.

##### **VST System Link**

Sets **VST System Link** as timecode source. This allows for all aspects of sample-accurate synchronization between different computers that are connected via **VST System Link**.

#### NOTE

Discrepancies between the **Project Frame Rate** and the incoming timecode can cause problems during postproduction, even if Cubase is able to lock to that timecode.

---

## MIDI Timecode Settings

The **MIDI Timecode Settings** become available if you activate **MIDI Timecode** as a **Timecode Source**.

### MTC Input

Allows you to select the MIDI input ports. To allow Cubase to synchronize to MIDI timecode from any MIDI connection, select **All MIDI Inputs**.

## Timecode Source Preferences

If you activate **MIDI Timecode** as a **Timecode Source**, you can set up **Timecode Source Preferences** for working with external timecode. The following options are available:

### Lock Frames

Determines how many full frames of timecode it takes for Cubase to lock, that is, establish synchronization.

#### NOTE

If you have an external tape transport with a very short start-up time, set **Lock Frames** to a low value to make lock-up even faster.

---

### Drop Out Frames

Sets the number of timecode frames that must be missed until Cubase stops. Using LTC on an analog tape machine can increase the number of drop outs.

### Inhibit Restart ms

Some synchronizers still transmit MTC for a short period after an external tapemachine has been stopped. These extra frames of timecode sometimes cause Cubase to restart suddenly. **Inhibit Restart ms** allows you to control the amount of time in milliseconds that Cubase waits before restart (ignoring incoming MTC) once it has stopped.

### Auto-Detect Frame Rate Changes

Notifies you about frame rate or timecode changes and interrupts playback or recording. Activate this if you want to diagnose problems with timecode and external devices.

### Transport Start/Stop

Starts/Stops playback in Cubase.

#### RELATED LINKS

[Activating VST System Link](#) on page 827

[Project Setup Dialog](#) on page 86

## Destinations Page

The **Destinations** page allows you to set up the synchronization outputs, and to determine which external signals leave the application.

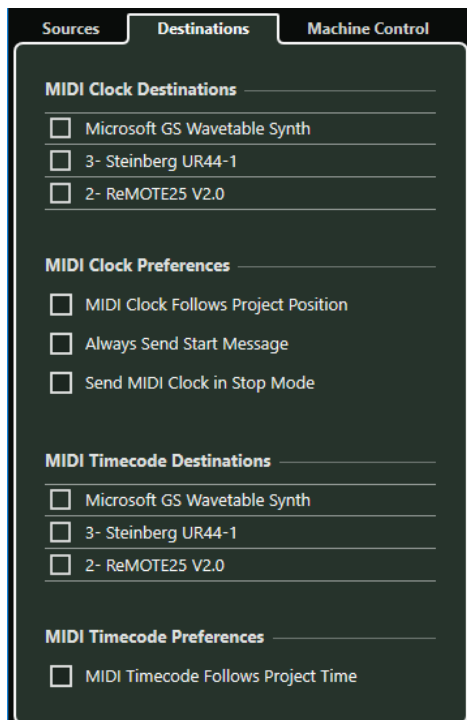

### MIDI Clock Destinations

In the **MIDI Clock Destinations** section, you can select any MIDI ports that you want to output MIDI clock. Some MIDI devices, such as drum machines, can match their tempo and location to incoming MIDI clock.

### MIDI Clock Preferences

In the **MIDI Clock Preferences** section, the following options are available:

#### MIDI Clock Follows Project Position

Ensures that the MIDI clock follows Cubase.

#### Always Send Start Message

MIDI clock transport commands include start, stop, and continue. Activate this if a MIDI device does not recognize the continue command.

#### Send MIDI Clock in Stop Mode

Activate this if a MIDI device needs MIDI clock to run continuously in order to operate arpeggiators and loop generators.

### MIDI Timecode Destinations

In the **MIDI Timecode Destinations** section, you can specify the MIDI ports to which MTC is routed.

#### NOTE

Some MIDI interfaces send MTC over all ports by default. If this is the case, only select one port of the interface for the MTC.

---

## MIDI Timecode Preferences

In the **MIDI Timecode Preferences** section, the following options are available:

### MIDI Timecode Follows Project Time

Ensures that the MTC output always follows the time position of Cubase.

## External Synchronization

To activate external synchronization, do one of the following:

- Select **Transport > Activate External Sync**.
- Select **Transport > Project Synchronization Setup**, and on the **Sources** page, activate **Activate External Sync**.
- Cubase awaits incoming timecode from the chosen timecode source defined in the **Project Synchronization Setup** dialog in order to play.  
Cubase will detect incoming timecode, locate to its current position, and start playback in sync with the incoming timecode.

# VST System Link

**VST System Link** is a digital audio network system that allows you to link several computers using digital audio hardware and cables.

Linking up 2 or more computers allows you to split different tasks and different tracks between different computers. You can run CPU-intensive processes, such as send effect plug-ins or VST instruments on one computer, and record audio tracks on another one.

**VST System Link** supplies transport and sync control, as well as up to 16 MIDI ports, with 16 channels each.

With **VST System Link** the signal is passed from one machine to the next, and eventually returns to the first machine.

For this to work, you need 2 or more computers that use the same or different operating systems, and for each computer in the network, the following:

- Audio hardware with digital inputs and outputs and a specific ASIO driver.  
The same digital formats and connection types.
- At least one digital audio cable, such as S/PDIF, ADAT, TDIF, or AES.
- A **VST System Link** host application.

## NOTE

You might want to invest in a KVM (Keyboard, Video, Mouse) switchbox. This allows you to use the same keyboard, monitor, and mouse to control each computer in the system, and to switch between computers very rapidly.

## Setting up VST System Link

To be able to work with **VST System Link**, you must first set up the network, configure the audio hardware, and set up the digital audio connections.

## VST System Link Section

The **VST System Link** section allows you to set up **VST System Link**.

- To open the **VST System Link** section, select **Studio > Studio Setup** and select **VST System Link** in the **Devices** list.

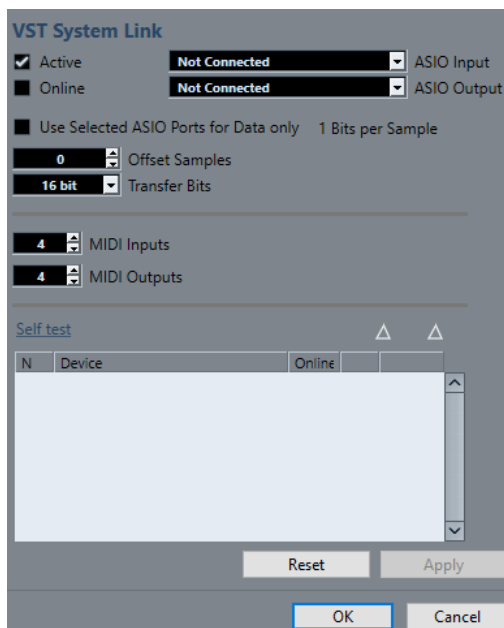

**Active**

Activates **VST System Link**.

**Online**

Puts the computer online.

**ASIO Input**

Allows you to define the networking input channel.

**ASIO Output**

Allows you to define the networking output channel.

**Use Selected ASIO Ports for Data only**

Activate this if you want to devote more bandwidth to MIDI, and send **VST System Link** information on the entire channel. This channel is then no longer available for audio transfer.

**Offset Samples**

Allows you to set an offset for the computer, so that it plays slightly ahead or behind the rest.

**Transfer Bits**

Allows you to specify whether you want to transfer 24 or 16 bits. This allows you to use older audio cards which do not support transfer of 24 bits.

**MIDI Inputs**

Allows you to set the number of MIDI input ports.

**MIDI Outputs**

Allows you to set the number of MIDI output ports.

**Self test**

Allows you to test the network.

**Receiving**

Lights up if the computer is active.

**Sending**

Lights up if the computer is active.



### List

Shows the name of each computer.

## Setting up a Network

You can set up a network by connecting computers.

---

### PROCEDURE

1. Use a digital audio cable to connect the digital output of computer 1 to the digital input of computer 2.  
If you have more than 2 computers, add the others one by one.
2. Use a cable to connect the digital output of computer 2 to the digital input of computer 1.  
**VST System Link** is a daisy chain system, that means, that the output of computer 1 goes to the input of computer 2, the output of computer 2 goes to the input of computer 3, and so on around the chain. The output of the last computer in the chain must always go back into the input of computer 1, to complete the ring.

### NOTE

If a card has more than one set of inputs and outputs, choose whichever one that suits you – for simplicity usually the first set is best.

---

## Configuring the Audio Clock

To be able to use **VST System Link**, the clock signals on your ASIO cards must be synchronized correctly.

### PREREQUISITE

For each computer in the network, the following must apply:

- The correct audio driver is selected in the **Studio Setup** dialog.
  - The clock mode or sync mode is set up in the ASIO control panel of the audio hardware.
- 

### PROCEDURE

1. Select **Studio > Studio Setup**.
2. In the **Devices** list, select the your audio hardware.
3. Click **Control Panel**.
4. Set one audio hardware to be the clock master and all other cards to be clock slaves. Consult the documentation if required.

### IMPORTANT

If you set up more than one card as clock master, the network cannot function correctly.

However, if you use an external clock from a digital mixing desk or a special word clock synchronizer, for example, you must leave all your ASIO cards in clock slave or **AutoSync** mode and make sure that each of them is listening for the signal coming from the synchronizer. This signal is usually passed through your ADAT cables or word clock connectors in a daisy chain fashion.

---

### RESULT

Typically, the ASIO control panel for an audio card contains some indication of whether or not the card receives a proper sync signal, including the sample rate of that signal. This is a good

indication that you have connected the cards and set up clock sync properly. Check the documentation of your audio hardware for details.

#### RELATED LINKS

[Selecting an Audio Driver](#) on page 14

[ASIO Driver Setup Page](#) on page 17

## Adjusting the Buffer Size

In a **VST System Link** network, adjusting the buffer size to minimize latency is extra important. This is due to the fact that the latency of a **VST System Link** network is the total latency of all the ASIO cards in the system added together.

---

#### PROCEDURE

1. Select **Studio > Studio Setup**.
2. In the **Devices** list, select your audio hardware.
3. Click **Control Panel**.
4. Lower the size of the buffers.  
The lower the buffer size, the lower the latency. It is best to keep to fairly low buffer sizes if your system can handle it. About 12 ms or less is usually a good idea.

#### IMPORTANT

Latency does not affect the synchronization, but it can affect the time it takes to send and receive MIDI and audio signals, or make the system seem sluggish.

---

## Audio Hardware Settings that Affect VST System Link

Specific audio hardware settings might change the digital information in a way that the correct functioning of **VST System Link** is affected.

You can find these settings in the control panel or additional application for your audio hardware. Make sure that the following conditions are met:

- Any additional format settings for digital ports that you use for **VST System Link** data must be turned off.  
If you use an S/PDIF connection for **VST System Link**, for example, turn off **Professional format**, **Emphasis**, and **Dithering**.
- Any mixer application of your audio hardware that allows for level adjustments of digital inputs and outputs must be disabled.  
Alternatively, you can set the levels for the **VST System Link** channels to  $\pm 0$  dB.
- Digital signal processing, such as pan or effects, must be turned off for the **VST System Link** signal.
- For RME Audio Hammerfall DSP audio hardware, select the default or plain preset for the **Totalmix** function.  
Otherwise signal loops might occur and **VST System Link** cannot work.

## Setting up Sample Rates

All projects on all computer must be set up to the same sample rate.

---

#### PROCEDURE

1. Select **Project > Project Setup**.

2. In the **Project Time Displays** section, open the **Sample Rate** pop-up menu and select a sample rate.
- 

## Setting up Digital Audio Connections

---

### PROCEDURE

1. Select **Studio > Audio Connections**.
  2. Click the **Inputs** tab, and click **Add Bus**.
  3. In the **Add Input Bus** dialog, configure the bus.
  4. Click **Add Bus**.
  5. Click the **Outputs** tab, and click **Add Bus**.
  6. In the **Add Output Bus** dialog, configure the bus.
  7. Click **Add Bus**.
  8. Repeat these steps for all applications.  
Set up the same configuration in all applications. If you have 4 stereo output busses on computer 1, you want 4 stereo input busses on computer 2, etc.
  9. Route the applications to the digital inputs and outputs.
- 

### RELATED LINKS

- [Audio Bus Setup](#) on page 19
- [Audio Connections Window](#) on page 24

## Verifying the Digital Connection

---

### PROCEDURE

1. Connect an audio source to your audio interface.
  2. Start recording, playing back, and mixing.
  3. On computer 1, play back some audio.
  4. Select **Studio > MixConsole**, and route the channel that contains the audio material to one of the digital output busses.
  5. On computer 2, select **Studio > MixConsole**, and locate the corresponding digital input bus.  
The audio that is played back should now appear in the application running on computer 2, and the input bus level meters should move.
- 

### RESULT

You have now verified that the digital connection works as it should. You can reverse this procedure so that computer 2 plays back and computer 1 listens.

---

## Activating VST System Link

You must activate **VST System Link** on all network computers to be able to work with **VST System Link**.

---

### PROCEDURE

1. Select **Transport > Project Synchronization Setup**, and on the **Sources** tab, activate **VST System Link** as the timecode source.
2. Select **Studio > Studio Setup**.

3. In the **Devices** list, select **VST System Link**.

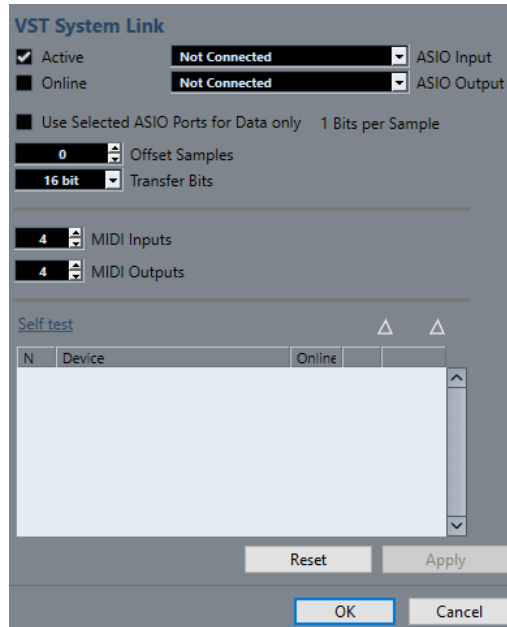

4. Use the **ASIO Input** and **ASIO Output** pop-up menus to define which channel is the networking channel that carries the **VST System Link** information.

#### NOTE

The networking signal is carried on only one bit of one channel. For an ADAT-based system 7 channels of 24-bit audio and 1 channel of 23-bit audio will be used for networking. You will still have around 138 dB headroom on this channel.

5. Activate **Active** at the top left of the **VST System Link** setup.
6. Repeat the steps for each computer in the network.

---

#### RESULT

The sending and receiving indicators on each active computer flash, and the name of each computer appears in the list in the **Self test** section of the dialog. Each computer is assigned a random number.

The name will be shown in the **VST System Link** window of every computer on the network. You can double-click the name of the computer and enter another name.

#### NOTE

If you do not see the name of each computer, go through the procedure above again and make sure that all ASIO cards are listening to the digital clock signals correctly, and that each computer has the correct inputs and outputs assigned to the **VST System Link** network.

---

#### RELATED LINKS

[Sources Page](#) on page 818

## Putting Network Computers Online

You must put the network computers online so that they can send and receive transport and timecode signals, and that their sequencer applications can be started and stopped.

#### PREREQUISITE

All computers have their tempos set to the same value.

PROCEDURE

1. Select **Studio > Studio Setup**.
  2. In the **Devices** list, select **VST System Link**.
  3. Activate **Online**.
  4. Repeat this for each computer in the network.
- 

RESULT

The computers are online now.

AFTER COMPLETING THIS TASK

Start playback on one computer to check if the system is working, and if all computers start and play perfectly in time.

**VST System Link** sends and understands all transport commands. This allows you to control the entire network from one computer. However, any computer can control any and all of the others. This is due to the fact that **VST System Link** is a peer-to-peer network, and that there is no absolute master computer.

## Activating MIDI Ports for VST System Link

You can activate MIDI input and output ports for **VST System Link**. This allows you to route MIDI tracks to VST instruments running on another computer.

---

PROCEDURE

1. Select **Studio > Studio Setup**.
  2. In the **Devices** list, select **VST System Link**.
  3. Specify the number of MIDI ports you need using the **MIDI Inputs** and **MIDI Outputs** value fields.
  4. Create a MIDI track.
- 

RESULT

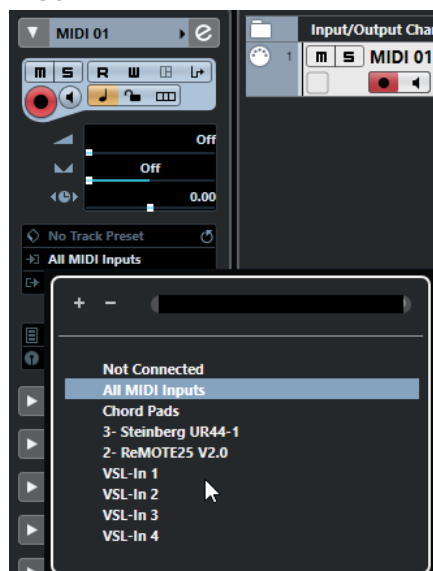

In the top section of the MIDI track **Inspector**, the **Input Routing** and **Output Routing** pop-up menu now show the specified **VST System Link** ports.

This allows you to route MIDI tracks to VST instruments running on another computer.

## Application Examples

**VST System Link** allows you to split different tasks between 2 or more computers. The following application examples should give you an idea of what is possible.

### Configuring a Main Mix Computer

Configuring one computer as a main mix computer that receives the audio from your other computers allows you to mix internally in the computer.

In the following example, we assume you are using 2 computers: computer 1 as your main mix computer and computer 2 for 2 additional stereo audio tracks, an FX channel track with a reverb plug-in and a VST instrument plug-in with stereo outputs.

---

#### PROCEDURE

1. On computer 1, use an unused set of outputs, such as an analog stereo output, connected to your monitoring equipment to listen to the audio playback.
2. On computer 2, route each of the 2 audio tracks to a separate output bus connected to the digital outputs, bus 1 and 2, for example.
3. Route the FX channel track to another **VST System Link** bus, bus 3, for example.
4. Route the VST instrument channel to yet another bus, bus 4, for example.
5. On computer 1, check the corresponding 4 **VST System Link** input busses.  
If you start playback on computer 2, the audio should appear on the input busses on computer 1. However, to mix these audio sources you need actual mixer channels.
6. Add 4 new stereo audio tracks on computer 1 and route these to the output bus you use for listening, such as the analog stereo outputs.
7. For each of the audio tracks, select one of the 4 input busses.  
Now, each computer 2 bus is routed to a separate audio channel on computer 1.
8. Activate monitoring for the 4 tracks.

---

#### RESULT

If you now start playback, the audio from computer 2 will be sent live to the new tracks on computer 1, allowing you to hear them together with any tracks you play back on computer 1.

#### AFTER COMPLETING THIS TASK

If you notice a processing delay while you listen to signals coming from your other computers while monitoring, try the following to compensate for latency issues:

- If your audio hardware supports this, activate **ASIO Direct Monitoring** on the **VST Audio System** device panel for your hardware.
- Alternatively, open the **Studio Setup** dialog, and on the **VST System Link** page, change the **Offset Samples** value.

### Configuring a Computer as Submixer

If you have more audio tracks than you have **VST System Link** busses, you can use a computer mixer as a submixer.

---

#### PROCEDURE

- Route several audio channels to the same output bus and adjust the output bus level if needed.

**NOTE**

If your audio cards have multiple sets of input and output connections, you can link up multiple ADAT cables and send audio via any of the busses on any of the cables.

---

## Routing MIDI Tracks to VSTis on Other Computers

You can route MIDI tracks from one computer to VST instruments on another computer. This allows you to use one computer for playback and recording and the other one as a VSTi rack.

---

**PROCEDURE**

1. Record a MIDI track into computer 1.
  2. Once you have finished recording, route the MIDI output of that track to **VST System Link** MIDI port 1.
  3. On computer 2, open the **VST Instruments** window and assign an instrument to the first slot in the rack.
  4. Route the VST instrument channel to the desired output bus.  
If you are using computer 1 as your main mixing computer, this would be one of the **VST System Link** output busses, connected to computer 1.
  5. Create a new MIDI track in the **Project** window of computer 2 and assign the MIDI output of the track to the VST instrument you created.
  6. Assign the MIDI input of the track to be **VST System Link** port 1.  
Now, the MIDI track on computer 1 is routed to the MIDI track on computer 2, which in turn is routed to the VST instrument.
  7. Now activate monitoring for the MIDI track on computer 2, so that it will listen and respond to any MIDI commands coming in.  
In Cubase, click the **Monitor** button in the track list or **Inspector**.
  8. Start playback on computer 1.  
It will now send the MIDI information on the track to the VST instrument loaded on computer 2.
- 

**RESULT**

Even with a slow computer you should be able to stack a whole bunch of extra VST instruments this way, expanding your sound palette considerably. Do not forget that **VST System Link** MIDI is also sample-accurate, and thus has much tighter timing than any hardware MIDI interface ever invented!

## Routing Audio Sends to Other Computers

The effect sends for an audio channel in Cubase can either be routed to an FX channel track or to any activated group or output bus. This allows you to use a separate computer as a virtual effect rack.

---

**PROCEDURE**

1. On computer 2, the machine you will use as effect rack, add a new stereo audio track.
2. Add the desired effect as an insert effect for the track.
3. In the **Inspector**, select one of the **VST System Link** busses as input for the audio track.
4. Route the channel to one of the **VST System Link** output busses connected to computer 1.
5. Activate monitoring for the track.
6. Go back to computer 1 and select a track to which you want to add some reverb.

7. Open the **Sends** rack for the track in the **Inspector** or the **MixConsole**.
  8. Open the **Send Routing** pop-up menu for one of the sends and select the **VST System Link** bus assigned to the effect.
  9. Use the **Send** slider to adjust the amount of effect as usual.
- 

#### RESULT

The signal will be sent to the track on computer 2 and processed through its insert effect, without using any processor power on computer 1.

You can repeat the steps above to add more effects to the virtual effect rack. The number of effects available this way is only limited by the number of ports used in the **VST System Link** connection, and by the performance of computer 2.

## Recording Tracks on Other Computers

You can record tracks on another computer. This is useful if the hard drive on one computer is not fast enough to run as many audio tracks as you need.

---

#### PROCEDURE

- Add tracks on another computer and record on them.
- 

#### RESULT

This creates a virtual RAID system, with several disks all operating together. All tracks will remain locked together just as tightly as if they were all running on the same machine.

## Playing Back Video on Other Computers

You can play back video on another computer to free up resources for audio and MIDI processing on your main CPU. This is useful as playback of high-resolution video can be quite demanding on the CPU.

---

#### PROCEDURE

- Move video tracks to another computer.
- 

#### RESULT

Since all transport commands respond on the **VST System Link** computers, scrubbing video is possible even when it is coming from another computer.

When scrubbing, the playback on the linked systems may not be perfectly in sync. Also, there are some further restrictions when scrubbing via **VST System Link**:

- Always use the system where you started scrubbing to control the scrubbing. Changing the scrub speed on a remote system will only change the speed on the local system.
- You can start playback on all systems. This stops scrubbing and enters playback on all systems in sync.



# Video

Cubase allows you to work with video content.

You can play back video files in various formats and via different output devices from within Cubase, extract the audio material from a video file, and edit your music to the video.

The video export function allows you to share your videos with clients or other users.

## IMPORTANT

Videos are exported with a resolution of 1920 x 1080 px (Full HD). Video files with a lower or higher resolution than Full HD are upscaled or downscaled on export.

## RELATED LINKS

[Video File Compatibility](#) on page 833

[Importing Video Files](#) on page 835

[Preparations for Video Playback](#) on page 837

[Export Video](#) on page 840

[Extracting Audio from Video](#) on page 843

## Video File Compatibility

When working on a project involving a video file, you must make sure that the video file type works on your Cubase system.

## NOTE

If you are not able to play back a specific video file, use an external application to convert the file into a compatible format.

To find out which video files are supported, refer to the support area at [steinberg.net](http://steinberg.net).

## RELATED LINKS

[Codecs](#) on page 834

## Video Container Formats

Video and other multimedia files come in a container format.

This container holds various streams of information including video and audio, but also metadata such as synchronization information required to play back audio and video together. Data regarding creation dates, authors, chapter markings, and more can also be held within the container format.

The following container formats are supported by Cubase:

### MOV

This is a QuickTime movie.

### **MPEG-4**

This format can contain various metadata for streaming, editing, local playback, and interchange of content. Its file extension is .mp4.

### **AVI**

This is a multimedia container format introduced by Microsoft.

## **Codecs**

Codecs are methods of data compression used to make video and audio files smaller and more manageable for computers.

For further details, refer to the support area at [steinberg.net](http://steinberg.net).

## **Frame Rates**

Cubase supports different video and film frame rates.

### **Frame rate (speed)**

Regardless of the frame counting system, the actual speed at which frames of video go by in real time is the true frame rate.

Cubase supports the following frame rates:

#### **24 fps**

This is the true speed of standard film cameras.

#### **25 fps**

This is the frame rate of PAL video.

#### **29.97 fps/29.97 dfps**

This is the frame rate of NTSC video. The count can be either non-drop or drop-frame.

#### **30 fps/30 dfps**

This frame rate is not a video standard anymore but has been commonly used in music recording. Many years ago, it was the black and white NTSC broadcast standard. It is equal to NTSC video being pulled up to film speed after a 2-3 telecine transfer. The count can be either non-drop or drop-frame.

### **IMPORTANT**

Video formats with a variable frame rate (VFR) are not supported.

---

## **Video Output Devices**

Cubase supports several video output devices.

Viewing video files onscreen in the **Video Player** window may work just fine for many applications, but often it is necessary to display video in a large format for viewing small details and so others involved in the session can also see the video. Cubase provides the ability to use several types of video output devices to accomplish this.

## **Dedicated Video Cards**

You can use a dedicated video card. Video is sent directly to the output of this video device.

The following video cards are supported:

- Blackmagic Design video output devices

#### IMPORTANT

- You must install the appropriate driver for the video device and set the video card output to the video file resolution used in your project.
  - Video output via FireWire is not supported.
- 

#### RELATED LINKS

[Video Player Page](#) on page 837

## Preparations for Creating Video Projects

Before you can start working with video in Cubase, some basic preparations must be made.

In Cubase, you may work with multiple video files of different formats on the same video track.

#### NOTE

For proper synchronization of audio and video events, make sure that the project frame rate matches the frame rate of the video file.

---

#### RELATED LINKS

[Project Setup Dialog](#) on page 86

## Importing Video Files

If you have a compatible video file, you can import it into your project.

---

#### PROCEDURE

1. Select **File > Import > Video File**.
  2. In the **Import Video** dialog, select the video file that you want to import.
  3. Optional: Activate **Extract Audio from Video** to import any embedded audio streams.
  4. Click **Open**.
- 

#### RESULT

Cubase creates a video track with a video event. If **Extract Audio from Video** was activated, an audio track with an audio event is positioned below the video track. The corresponding audio clip is saved in the **Pool Record** folder.

#### NOTE

You can also import video files by dragging them from the **MediaBay**, the File Explorer/macOS Finder and dropping them in your project. If you want Cubase to automatically extract the audio, activate **Extract Audio on Import Video File** in the **Preferences** dialog (**Video** page).

---

#### RELATED LINKS

[Pool](#) on page 476

[Extracting Audio from Video](#) on page 843

## Adopting the Project Frame Rate

To ensure that the time display of Cubase corresponds to the actual frames in the video, you must set the project frame rate to the frame rate of the imported video file.

### PREREQUISITE

The frame rate of the imported video file differs from the project frame rate.

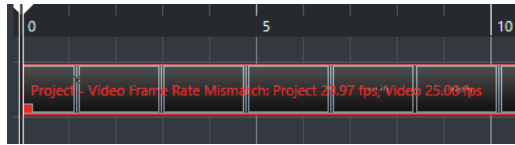

---

### PROCEDURE

1. Select **Project > Project Setup**.
2. In the **Project Setup** dialog, click **Get Frame Rate from Video**.
3. Click **OK**.

---

### RESULT

- If Cubase supports the frame rate of the video, the project frame rate is adopted to it. If needed, the project start time is automatically adjusted to reflect the change in frame rate. For example, if the project frame rate is switched from 30 fps to 29.97 fps, the project start time is adopted so that all the events in the project remain at the same positions in relation to real time.

### NOTE

If you want the project start time to remain the same, you must manually change it back. In this case, you must snap the video event to the timeline to ensure proper positioning and synchronization within the project.

---

## Thumbnail Cache Files

For every imported video file, Cubase automatically creates a thumbnail cache file.

### RELATED LINKS

[Manually Generating Thumbnail Cache Files](#) on page 836

## Manually Generating Thumbnail Cache Files

You can manually generate thumbnail cache files. This is necessary if a thumbnail cache file could not be generated during import because the folder is write-protected, or because you have edited the file with an external video editing application.

---

### PROCEDURE

- Do one of the following:
  - In the **Pool**, right-click the video file and select **Generate Thumbnail Cache**.
  - In the **Project** window, select the video event and select **Media > Generate Thumbnail Cache**.

### NOTE

You can only refresh already existing thumbnail cache files from within the **Pool**.

---

#### RESULT

The thumbnail cache file is generated in the background so that you can continue working with Cubase.

## Preparations for Video Playback

You can play back imported video files from within Cubase by using the transport controls.

For this to work, you must activate and set up a video output device.

#### IMPORTANT

Your graphics card must support OpenGL 2.0 or higher.

---

## Video Player Page

The **Video Player** setup page in the **Studio Setup** dialog allows you to set up your video player, and to check if your video equipment allows for video playback from within Cubase.

- To open the **Video Player** page, select **Studio > Studio Setup** and activate **Video Player** in the **Devices** list.

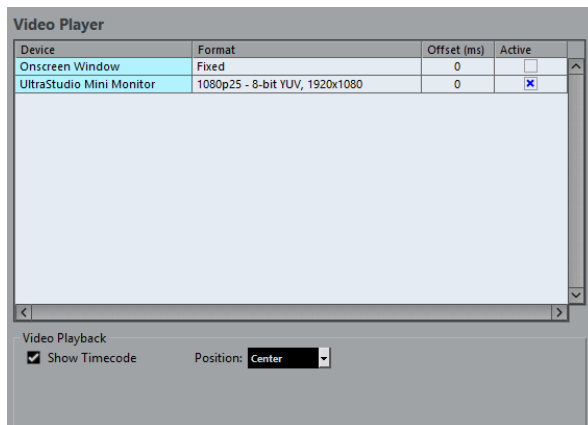

The following options are displayed:

#### Device

Lists the video output devices that are available on your system.

#### Format

Allows you to select an output format.

#### NOTE

The **Onscreen Window** device only supports a fixed format.

---

#### Offset

If the video image does not match the audio, you can enter an offset value in milliseconds to specify how much earlier the video should be delivered. This compensates for the display delay. The offset is only used during playback. It is saved globally for each output device and is independent of the project.

#### Active

Allows you to activate the device that you want to use for playing back video.

### Show Timecode

Allows you to show the timecode.

### Position

Allows you to determine the position for the timecode display.

## Activating a Video Output Device

---

### PROCEDURE

1. Select **Studio > Studio Setup**.
2. In the **Devices** list, activate **Video Player**.  
The available video output devices are listed in the **Device** column.
3. In the **Active** column, activate the checkbox for the device that you want to use for playing back video.

### NOTE

If you have no external device connected, you can use the **Onscreen Window** device that allows you to play back the video file on your computer monitor.

---

### RELATED LINKS

[Video Output Devices](#) on page 834

## Video Player Window

The **Video Player** window provides different size options for video playback on your computer screen. However, the larger the size of the window and the higher the resolution of your video, the more processor load is needed.

- To open the **Video Player** window, select **Studio > Video Player**.



### Fullscreen Mode

Sets the window to full screen mode. To exit full screen mode, open the context menu and select **Exit Fullscreen Mode** or press **Esc**.

### Quarter Size

Reduces the window to a quarter of the actual size.

### Half Size

Reduces the window to half the actual size.

### Actual Size

Sets the window to the size of the video.

### Double Size

Enlarges the window to twice the actual size.

### Aspect Ratio

You can also drag the borders of the **Video Player** window to resize it. However, this might lead to a distorted image. To prevent this, you can set an option from the **Aspect Ratio** pop-up menu.

- If you select **None**, the aspect ratio of the video is not kept when you resize the window. The image is enlarged/reduced to occupy the whole Video Player window.
- **Internal** allows you to resize the window freely while keeping the aspect ratio of the video. Borders might be displayed around the video image to fill the window.
- **External** allows you to resize the window within some limits so that the video image always fills the full window and its aspect ratio is kept.

- **NOTE**

In full screen mode, the aspect ratio of the video is always kept.

---

## Scrubbing Video

You can scrub video events, that is, play them back forwards or backwards.

---

### PROCEDURE

1. Select **Studio > Video Player**.
  2. Do one of the following:
    - Click in the **Video Player** window and move the mouse to the left or to the right.
    - Use a jog wheel on a remote controller.
- 

## Editing Video

Video events are created automatically when you import a video file.

When working with video events, the following applies:

- You can view and edit video events in the **Project** window. A video event triggers the playback of the corresponding video clip.
- You can copy and trim video events.
- You cannot draw, glue, and mute video events, or apply fades or crossfades.

## Export Video

You can export a video file from your project. This allows you, for example, to share sections of intermediate results or finished videos with clients or other users.

The **Export Video** function exports the video and a stereo audio signal that are enclosed between the left and right locators. This allows you to export a specific range or your whole project by setting the locators accordingly.

Videos are exported in the following format:

- Container format: MP4
- Video compression codec: H.264 without long group of pictures (Long GOP) sequences
- Resolution: 1920 x 1080 px (Full HD)

### IMPORTANT

Video with a lower or higher resolution than Full HD is upscaled or downscaled on export.

---

- Frame rate: Same as the project frame rate
- Audio compression codec: AAC
- Sample rate: Same as the project sample rate

### IMPORTANT

Video export supports sample rates of 44.1 kHz and 48 kHz only.

---

- Bit depth: 16 bit

You can only add a stereo output channel to the exported video file. We recommend that you route all mono, stereo, or multi-channel channels that you want to export to a stereo output channel via send, and select this output channel in the **Export Video** dialog.

### RELATED LINKS

- [Export Video Dialog](#) on page 840
- [Exporting Video Files](#) on page 842

## Export Video Dialog

The **Export Video** dialog provides settings for exporting a video file from your project.

- To open the **Export Video** dialog, select **File > Export > Video**.

The **Export Video** dialog is divided into several sections.



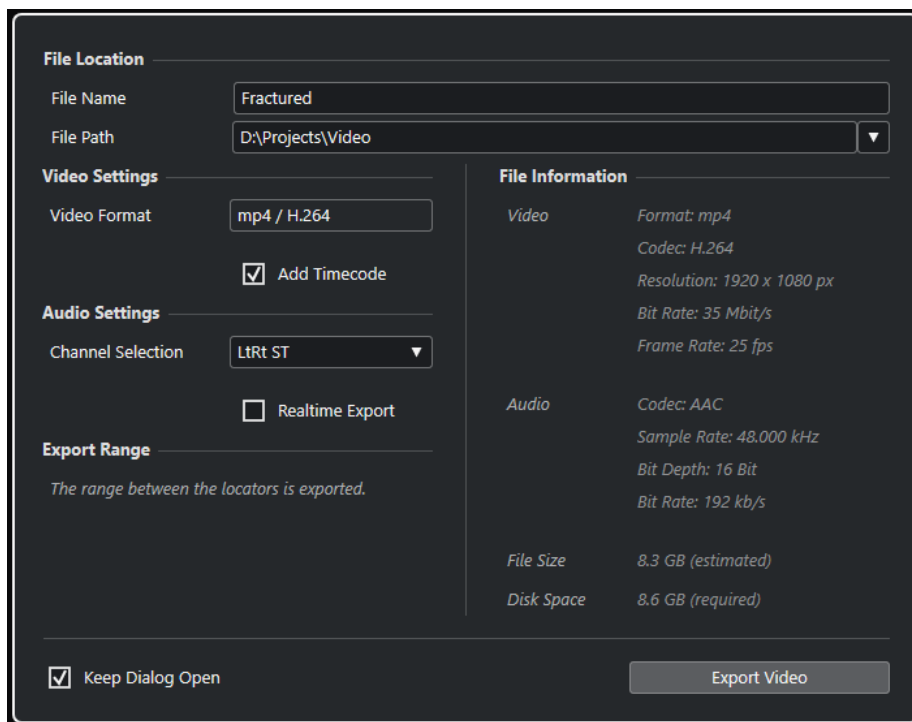

## File Location

### File Name

Allows you to specify the name of the exported video file.

### File Path

Allows you to specify the file path of the exported video file.

Click **Path Options** to open a pop-up menu with file path options:

- **Choose** opens the File Explorer/macOS Finder allowing you to browse for a file location.
- **Recent Paths** allows you to select a recently selected file locations.
- **Clear Recent Paths** allows you to delete all recently selected file locations.

## Video Settings

### Video Format

Shows the format of the exported video file.

### Add Timecode

Adds the project timecode to the exported video file.

## Audio Settings

### Channel Selection

Allows you to select a stereo output channel for export. **MixConsole** settings and insert effects are taken into account.

### Realtime Export

Allows you to export the audio mixdown in real time. Realtime export takes at least the same time as regular playback. Activate this if you use external effects or instruments, or if you use VST plug-ins that require time to update correctly during the mixdown. For further information, refer to the documentation of the respective plug-ins.

NOTE

- If you export external effects or instruments in real time, you must also activate **Monitor** for the respective audio channels.
  - **Realtime Export** affects only the audio export. Video is processed as usual.
- 

### Export Range

This section provides information about the exported locator range.

### File Information

This section provides detailed information about the exported video file.

### General Options

In the bottom section, the following options are available:

#### Keep Dialog Open

Activate this to keep the dialog open after clicking **Export Video**.

#### Export Video

Allows you to export your video as specified.

#### RELATED LINKS

[Export Video](#) on page 840

## Exporting Video Files

You can export a video including a stereo audio signal of your whole project or of a specific range as an MP4 video file.

#### PREREQUISITE

- Your project sample rate is set to 44.1 kHz or 48 kHz.
- If you want to export external audio signals, you have activated **Monitor** for the corresponding channel.

---

#### PROCEDURE

1. Set up the left and right locators to encompass the section that you want to export.
2. Set up the audio in your project so that it plays back the way you want.

NOTE

You can only add a stereo output channel to the exported video file. We recommend that you route all mono, stereo, or multi-channel channels that you want to export to a stereo output channel via send.

---

3. Select **File > Export > Video**.
4. In the **Export Video** dialog, select the stereo output channel that you want to export.

NOTE

Make sure that the selected output channel contains all audio that you want to use for the exported file. For example, solo the channels that you want to export, or mute the channels that you do not want to export.

---

5. Make any further export settings.

6. Click **Export Video**.

---

RESULT

The video file is exported.

RELATED LINKS

[Export Video Dialog](#) on page 840

## Extracting Audio from Video

You can extract the audio stream of a video file on import.

---

PROCEDURE

1. Do one of the following:
    - Select **File > Import > Audio from Video File**.  
This creates an audio clip in the **Pool**, but does not add any events to the **Project** window.
    - Select **Media > Extract Audio from Video File**.
  2. In the dialog, select the video file, and click **Open**.
  3. In the **Import Options** dialog, select the desired import options.
- 

RESULT

The extracted audio stream is added to the project on a new audio track and can be edited like all other audio material.

RELATED LINKS

[Pool](#) on page 476

[On Import Audio Files Settings](#) on page 253

[Importing Video Files](#) on page 835

# Exchanging Files with Other Applications

## AAF Files

The Advanced Authoring Format (AAF) is a multimedia file format that allows you to exchange digital media and metadata between different systems and applications across multiple platforms. Metadata include fades, automation, and processing information.

### RELATED LINKS

[Importing AAF Files](#) on page 844

[Exporting AAF Files](#) on page 846

## Importing AAF Files

---

### PROCEDURE

1. Select **File > Import > AAF**.
2. In the File Explorer/macOS Finder, choose the AAF file and click **Open**.
3. If a project is already open in Cubase, a dialog opens that allows you to choose a destination for the imported AAF file.
  - To import the AAF file to a new project, click **Yes**.
  - To import the AAF file to your active project, click **No** and proceed with step 5.
4. In the File Explorer/macOS Finder, specify a project folder and click **Select Folder**.
5. In the **Import Options** dialog, choose the tracks you want to import and make your changes.
6. Click **OK**.

### NOTE

Depending on the size of the imported project and whether the files are embedded or referenced, the import process may take a while.

---

### RESULT

The audio tracks and events of the imported AAF file are added. If you have imported the file to a new project, the events are placed at their original timecode position. If you have imported the file to your active project, the events are placed at the position you have specified in the **Import Options** dialog.

### RELATED LINKS

[AAF Import Options Dialog](#) on page 845

## AAF Import Options Dialog

The **AAF Import Options** dialog allows you to activate tracks for import and to specify the destination in the active project.

- To open the **AAF Import Options** dialog, select **File > Import > AAF**.

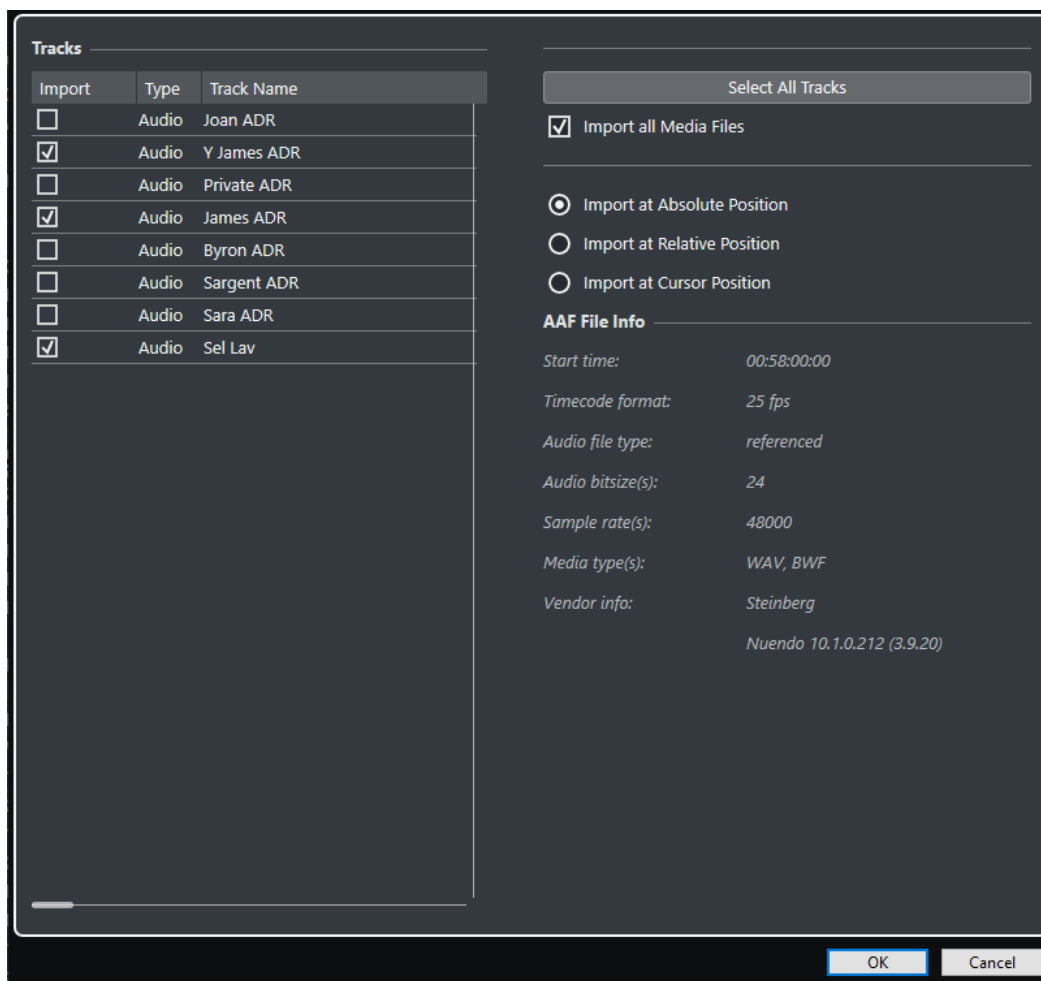

### Import

Allows you to select a track for import.

### Type

Shows the media type of the track.

### Track Name

Shows the track name.

### Select All Tracks

Selects all tracks for import.

### Import All Media Files

Imports media files that are not referenced by events.

### Import at Absolute Position

Places imported track data at its original timecode position in your active project.

### Import at Relative Position

Places imported track data relative to the start time of your active project, taking the source project start time into account. For example, if the source project starts at

timecode 01:00:00:00 with an event located at 02:00:00:00, and if the active project starts at 02:00:00:00, the imported event is placed at timecode 03:00:00:00.

#### **Import at Cursor Position**

Places imported track data relative to the cursor position in your active project, taking the source project start time into account. For example, if the source project starts at timecode 01:00:00:00 with an event located at 02:00:00:00, and if the cursor in your active project is located at 02:00:00:00, the imported event is placed at timecode 03:00:00:00.

#### **NOTE**

- If the original timecode position of the imported data is outside of your project range, the start/end time of your project is modified.
  - The import position options are only available if you import the AAF file to your active project.
- 

#### **AAF File Info**

Shows information about the file.

## **Exporting AAF Files**

---

#### **PROCEDURE**

1. Select **File > Export > AAF**.
  2. In the **Export Options** dialog, select the tracks that you want to include in the exported file and make your changes.
  3. Click **OK**.
  4. In the file dialog, specify a name and location.
  5. Click **Save**.
- 

#### **RESULT**

The AAF file is exported.

#### **RELATED LINKS**

[AAF Export Options Dialog](#) on page 846

## **AAF Export Options Dialog**

The **AAF Export Options** dialog allows you to activate tracks for export and to specify what data is included in the exported files.

- To open the **AAF Export Options** dialog, select **File > Export > AAF**.

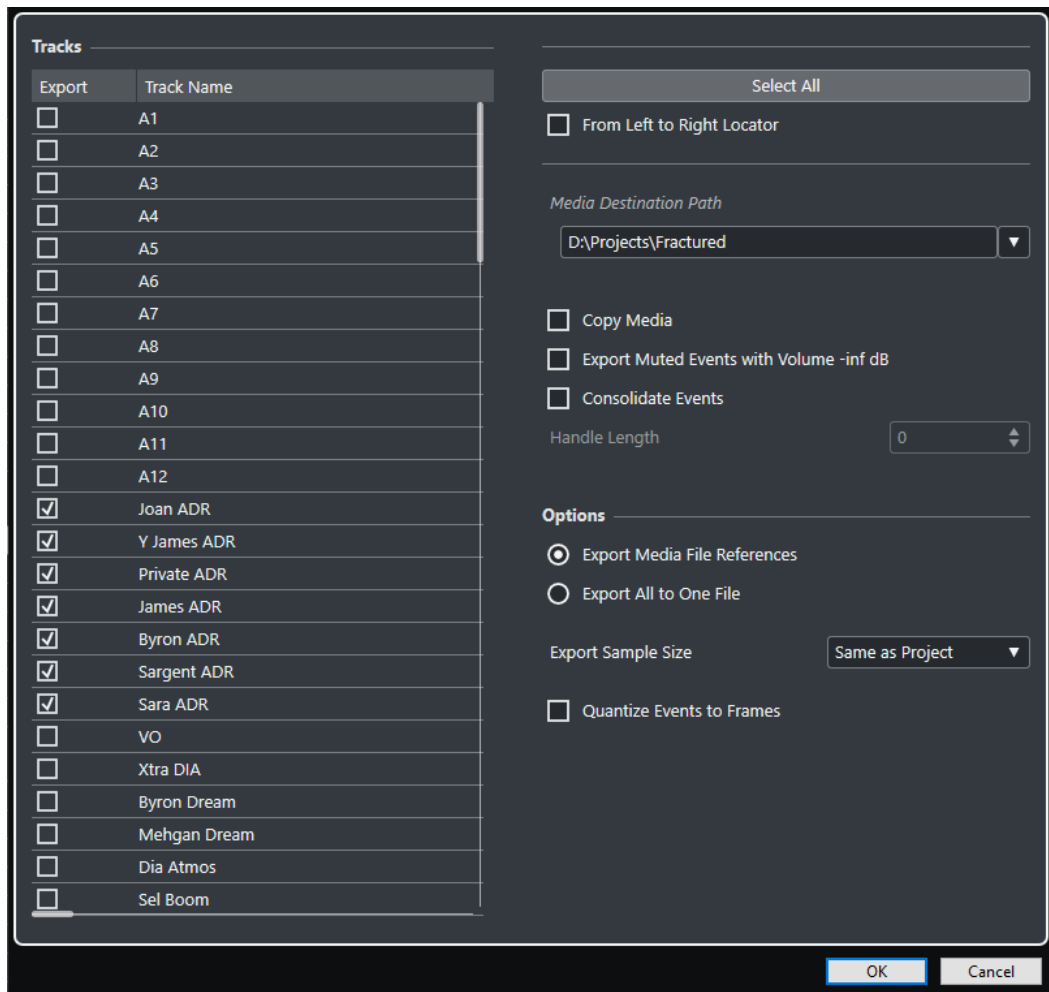

### Export

Allows you to select a track for export.

### Track Name

Shows the track name.

### Select All

Selects all tracks in the project for export.

### From Left to Right Locator

Allows you to export the range between the locators only.

### Media Destination Path

Allows you to specify a location for the exported files. You can also click **Browse**.

#### NOTE

You can create references to media destinations that do not exist on the system you are working with. This allows you to prepare files for use in projects on another system or in a network environment, for example.

### Copy Media

Allows you to create copies of all the media files. By default, the copied audio files are placed in a subdirectory in the export destination folder. To specify a different location for the copied files, use the **Media Destination Path** field.

**Export Muted Events with Volume -inf dB**

Sets muted events to a volume -inf dB on export.

**Consolidate Events**

Allows you to copy only the portions of audio files that are used in the project.

The **Handle Length** value allows you to define a length in milliseconds to include audio outside each event boundary for later fine-tuning. Handles allow you to adjust fades or edit points when the project is imported into another application.

**Export Media File References**

Exports only media file references. This keeps the exported file small. However, the referenced audio files must be available for the receiving application.

**Export All to One File**

Exports all data to one self-contained file. This could result in a large file size.

**Export Sample Size**

Allows you to set a sample size for the exported files.

**Quantize Events to Frames**

Moves the event positions in the exported file to exact frames. This is sometimes necessary when exporting projects to video workstations that limit the accuracy of edits to the frame.



# ReWire

## Introduction

ReWire is a special protocol for streaming audio between two computer applications.

Developed by Propellerhead Software and Steinberg, ReWire provides the following possibilities and features:

- Realtime streaming of up to 128 separate audio channels, at full bandwidth, from the synthesizer application into the mixer application.  
In this case, the mixer application is Cubase. An example of a synthesizer application is Propellerhead Software's Reason.
- Automatic, sample-accurate synchronization between the audio in the two programs.
- The possibility to have the two programs share one audio card and take advantage of multiple outputs on that card.
- Linked transport controls that allow you to play, rewind, etc., either from Cubase or from the synthesizer application (provided it has some kind of transport functionality).
- Automatic audio mixing functions of separate channels as required.  
In the case of Reason, for example, this allows you to have separate channels for the different devices.
- Additionally, ReWire offers the possibility to route MIDI tracks in Cubase to the other application for full MIDI control.  
For each ReWire-compatible device, a number of extra MIDI outputs is made available in Cubase. In the case of Reason, this allows you to route different MIDI tracks in Cubase to different devices in Reason, with Cubase serving as the main MIDI sequencer.
- The overall load on your system is reduced significantly, compared to when using the programs together in the conventional way.

## Enabling ReWire Applications

To use the available ReWire applications on your computer in your project, you must enable them in the **ReWire Setup** dialog.

### IMPORTANT

- Enabling ReWire applications may have an impact on performance and stability of Cubase, even if the ReWire connection is not used. We therefore recommend to enable only ReWire applications that you want to use in your project.
  - Disabling a ReWire application removes the corresponding ReWire channels from your project. All associated automation or parameter settings are lost.
-

---

PROCEDURE

1. Select **Studio > ReWire > ReWire Setup**.
  2. Activate the ReWire applications that you want to use.
  3. Click **Apply**.
- 

RESULT

The enabled ReWire applications become available in the **ReWire** submenu.

AFTER COMPLETING THIS TASK

You can activate ReWire channels in the ReWire panel of the application.

RELATED LINKS

[Activating ReWire channels](#) on page 851

## Launching and quitting

When using ReWire, the order in which you launch and quit the two programs is very important.

### Launching for normal use with ReWire

When you use Cubase with ReWire, the order in which you launch the two programs is very important.

---

PROCEDURE

1. First launch Cubase.
  2. Enable one or several ReWire channels in the ReWire Device dialog for the other application.
  3. Launch the other application.  
It may take slightly longer for the application to start when you are using ReWire.
- 

RELATED LINKS

[Activating ReWire channels](#) on page 851

### Quitting a ReWire session

When you are finished using ReWire, you must quit the applications in a specific order.

---

PROCEDURE

1. First quit the synthesizer application.
  2. Then quit Cubase.
- 

### Launching both programs without using ReWire

It is possible to run Cubase and the synthesizer application simultaneously on the same computer, without using ReWire, even though use cases for this might be rare.

---

PROCEDURE

1. First launch the synthesizer application.
2. Then launch Cubase.

**NOTE**

Please note that the two programs now compete for system resources such as audio cards, just as when running with other, non-ReWire audio applications.

---

## Activating ReWire channels

ReWire supports streaming of up to 128 separate audio channels. The exact number of available ReWire channels depends on the synthesizer application. The ReWire device panels in Cubase allow you to activate the channels that you want to use.

**PREREQUISITE**

You have enabled the ReWire application that you want to use in the **ReWire Setup** dialog.

---

**PROCEDURE**

1. Select **Studio > ReWire**, and select the ReWire application that you want to use. The corresponding **ReWire** panel appears. This consists of a number of rows, one for each available ReWire channel.
  2. Click the power buttons to the left to activate/deactivate channels. The buttons light up to indicate activated channels.
  3. Optional: Double-click the labels in the right column, and type in another name. These labels are used in your project to identify the ReWire channels.
- 

**RESULT**

The activated ReWire channels are added to the project.

**NOTE**

- The more ReWire channels you activate, the more processing power is required.
  - For information about exactly what signal is carried on each channel, refer to the documentation of the synthesizer application.
- 

**IMPORTANT**

Deactivating ReWire channels in the **ReWire** panel removes the channels from your project. All associated automation or parameter settings are lost.

---

**RELATED LINKS**

[Enabling ReWire Applications](#) on page 849

## Using the transport and tempo controls

**IMPORTANT**

This is only relevant if the synthesizer application has a built-in sequencer or similar application.

---

## Basic transport controls

When you run ReWire, the transports in the two programs are completely linked. It does not matter in which program you play, stop, fast forward or rewind. However, recording (if applicable) is still completely separate in the two applications.

## Loop settings

If there is a loop or cycle facility in the synthesizer application, that loop will be completely linked to the cycle in Cubase. This means that you can move the start and end point for the loop or turn the loop on or off in either program, and this will be reflected in the other.

## Tempo settings

As far as tempo goes, Cubase is always the master. This means that both programs will run in the tempo set in Cubase.

However, if you are not using the tempo track in Cubase, you can adjust the tempo in either program, and this will immediately be reflected in the other.

### IMPORTANT

If you are using the tempo track in Cubase and the **Activate Tempo Track** button is activated on the **Transport** panel, you should not adjust the tempo in the synthesizer application, since a tempo request from ReWire automatically deactivates the tempo track in Cubase.

---

## How the ReWire channels are handled

When you activate ReWire channels in the ReWire device panels, they will become available as channels in the **MixConsole**.

The ReWire channels have the following properties:

- ReWire channels may be any combination of mono and stereo, depending on the synthesizer application.
- ReWire channels have the same functionality as regular audio channels. This means you can set volume and pan, add EQ, insert effects and sends, and route the channel outputs to groups or busses. However, ReWire channels have no monitor buttons.
- All channel settings can be automated using the **Read/Write** buttons. When you write automation, channel automation tracks will automatically appear in the **Project** window. This allows you to view and edit the automation graphically, just as with VST instrument channels, etc.
- You can mix down the audio from ReWire channels to a file on your hard disk with the **Export Audio Mixdown** function.

### RELATED LINKS

[Mixing Down to Audio Files](#) on page 805

## Routing MIDI via ReWire

When using Cubase with a ReWire-compatible application, additional MIDI outputs will automatically appear on the **Output Routing** pop-up menus for MIDI tracks. This allows you to play the synthesizer application via MIDI from Cubase, using it as one or several separate MIDI sound sources.



- The number and configuration of MIDI outputs depends on the synthesizer application.

## Considerations and limitations

### Sample rates

Synthesizer applications may be limited to audio playback in certain sample rates. If Cubase is set to a sample rate other than those, the synthesizer application will play back at the wrong pitch. Consult the documentation of the synthesizer application for details.

### ASIO drivers

ReWire works well with ASIO drivers. By using the Cubase bus system, you can route sounds from the synthesizer application to various outputs on an ASIO compatible audio card.

# Key Commands

Key commands are assigned to most main menus and functions in Cubase. They are stored as **Preferences** that are used for all your projects.

You can view and add key commands in the **Key Commands** dialog. Key command assignments are also shown in the tooltips.

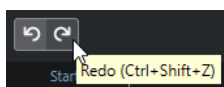

Tooltips that show an exclamation mark at the end have no key command assigned yet.

You can save key commands settings as a key commands file, which is stored separately and can be imported into any project. This way you can quickly and easily recall customized settings when moving projects between different computers, for example. The settings are saved in an XML file on the hard disk.

## RELATED LINKS

[Saving Key Commands Presets](#) on page 859

## Key Commands Dialog

The **Key Commands** dialog allows you to view and edit key commands for the main menus and functions in Cubase.

- To open the **Key Commands** dialog, select **Edit > Key Commands**.

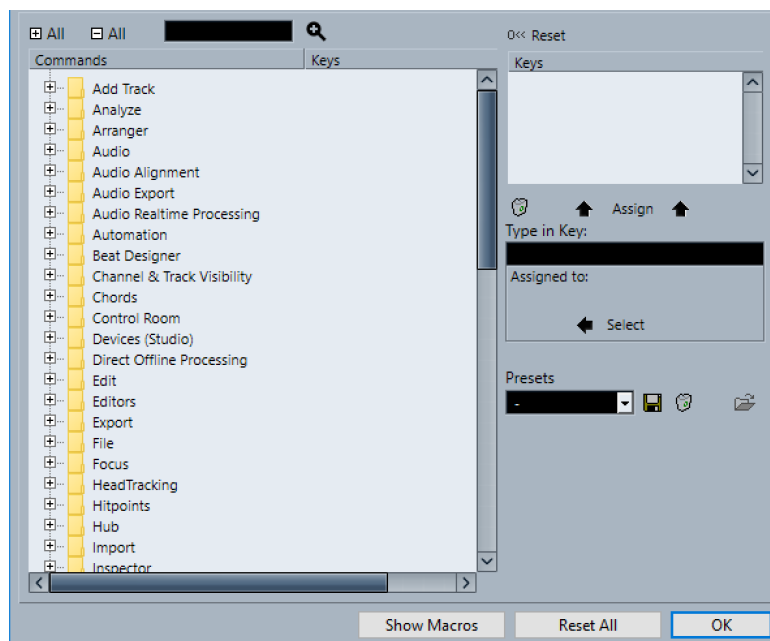

The following options are available:

**+ All**

Expands all folders.

**- All**

Reduces all folders.

**Search**

Allows you to search for Cubase functions. This is useful if you want to know which key command is assigned to a specific function.

**Reset Current Key Command**

Allows you to reset the selected key command back to the default setting.

**Commands list**

Shows the Cubase functions for that you can assign key commands arranged in category folders.

**Keys**

This is where the assigned key command is shown for the function that is selected in the **Commands list**.

**Delete Selected Key Command**

Removes the key command assignment from the function that is selected in the **Commands list**.

**Assign Key**

Assigns the key from the **Type in Key** value field to the function that is selected in the **Commands list**.

**Type in Key**

This is where you can enter a key that is assigned to a function that is selected in the **Commands list**.

**Assigned to:**

Shows the function that the key in the **Type in Key** value field is assigned to. Click the **Select** button, to select this function in the **Commands list**.

**Select Preset**

Opens a menu with the stored key commands presets.

**Store**

Opens a dialog that allows you to store a key commands preset.

**Delete**

Deletes the selected key commands preset.

**Import Key Command File**

Allows you to import key commands settings that you saved with an earlier program version or on another computer.

**Show Macros**

Opens the **Macros** section that allows you to set up a combination of several functions or commands to be performed in one go as a macro.

**Reset All**

Resets all key commands to their default settings.

#### RELATED LINKS

- [Macros Section](#) on page 856
- [Assigning Key Commands](#) on page 857
- [Searching for Key Commands](#) on page 857
- [Resetting Key Commands](#) on page 859
- [Removing Key Commands](#) on page 858
- [Importing Key Command Settings](#) on page 859
- [Loading Key Command Presets](#) on page 859
- [Saving Key Commands Presets](#) on page 859
- [Setting up Macros](#) on page 858

## Macros Section

The **Macros** section allows you to set up a combination of several functions or commands that you want to be performed in one go.

- To open the **Macros** section, select **Edit > Key Commands**, and click **Show Macros**.

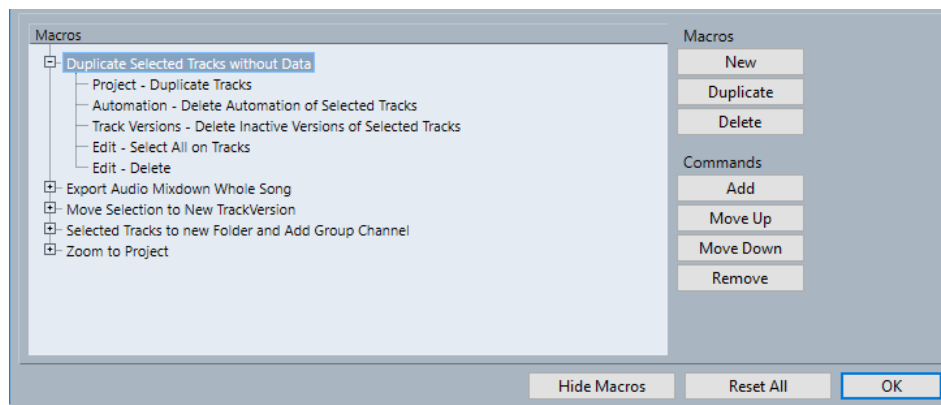

### Macros list

Shows all added macros.

### New

Allows you to add a new macro.

### Duplicate

Allows you to duplicate the selected macro.

### Delete

Deletes the selected item from the **Macros** list.

### Add

Allows you to add the function that is selected in the **Commands** list to the macro.

### Move Up

Allows you to change the position of the selected command by moving it up the list.

### Move Down

Allows you to change the position of the selected command by moving it down the list.

### Remove

Allows you to remove the command that is selected in the **Commands** list in the upper part of the dialog.



### Hide Macros

Hides the **Macros** section.

### Reset All

Resets all key commands to their default settings.

#### RELATED LINKS

[Key Commands Dialog](#) on page 854

[Setting up Macros](#) on page 858

## Assigning Key Commands

You can add key commands in the **Key Commands** dialog.

---

#### PROCEDURE

1. Select **Edit > Key Commands**.
2. Do one of the following:
  - In the **Commands** list, click the plus sign to open a category folder, and select the function to which you want to assign a key command.
  - In the search field, enter the name of the function to which you want to assign a key command.

Assigned key commands are shown in the **Keys** column as well as in the **Keys** list to the right.

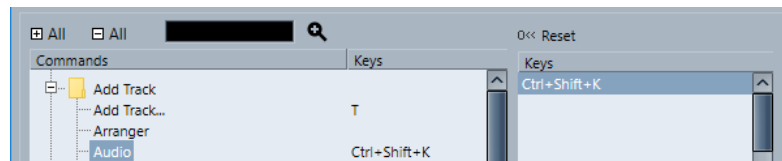

3. Click the **Type in Key** field and press the keys you want to use as a key command. You can press individual keys or a combination of one or several modifier keys (**Alt**, **Ctrl/Cmd**, **Shift**) plus any key.
4. Click **Assign**. The key command is shown in the **Keys** section.
5. Click **OK**.

#### NOTE

You can set up several different key commands for the same function. Adding a key command to a function that already has another key command does not replace the key command previously defined for the function.

---

## Searching for Key Commands

You can search for Cubase functions in the **Key Commands** dialog. This is useful if you want to know which key command is assigned to a specific function.

---

#### PROCEDURE

1. Select **Edit > Key Commands**.
2. In the search field, enter the name of the function for which you want to know the key command.

3. Click **Start/Continue Search**.
- 

RESULT

The first matching command is selected and displayed in the **Commands** list. The **Keys** column and the **Keys** list show the assigned key commands, if any.

## Removing Key Commands

---

PROCEDURE

1. Select **Edit > Key Commands**.
  2. In the **Commands** list, click the plus sign to open a category folder, and select the function for which you want to remove a key command.
  3. Select the key command in the **Keys** list and click **Delete selected key command**.
  4. Click **Remove** to remove the selected key command.
  5. Click **OK**.
- 

## Setting up Macros

You can set up a combination of several functions or commands to be performed in one go as a macro.

PROCEDURE

1. Select **Edit > Key Commands**.
2. Click **Show Macros**.
3. Click **New**.
4. Enter a name for the macro and press **Return** to confirm it.
5. In the **Commands** list, select the first command you want to include in the macro.
6. Click **Add**.
7. Select the next command and click **Add**.

NOTE

Commands are added after the selected command in the **Macros** list. This allows you to specify the order of commands of a macro.

---

8. Click **OK**.
- 

RESULT

All macros are available in the **Macros** submenu of the **Edit** menu.

AFTER COMPLETING THIS TASK

You can also assign key commands to a macro. Macros are shown in the **Commands** list in the **Macro** category folder.

RELATED LINKS

[Macros Section](#) on page 856

## Saving Key Commands Presets

You can save key commands settings as presets.

### PREREQUISITE

You have set up the key commands to your liking.

---

### PROCEDURE

1. In the **Presets** section, click **Save**.
2. Enter a name for the preset and click **OK**.

---

### RESULT

Your key commands settings are now available as a preset on the **Presets** pop-up menu.

## Loading Key Command Presets

You can load key commands presets.

---

### PROCEDURE

- In the **Presets** section, open the pop-up menu and select the preset.

---

### RESULT

The key command preset replaces the current key command settings and macros.

## Importing Key Command Settings

You can import key commands settings that you saved with an earlier program version.

---

### PROCEDURE

1. Select **Edit > Key Commands**.
2. In the **Presets** section, click **Import Key Command File**.

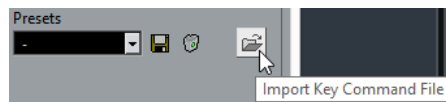

3. In the file dialog, select the file that you want to import.  
You can import key commands files with the file extension `.key` or macro commands files with the file extension `.mac`.
4. Click **Open**.

---

### RESULT

The file is imported.

### AFTER COMPLETING THIS TASK

You can save the imported file as a preset.

## Resetting Key Commands

---

### PROCEDURE

1. Select **Edit > Key Commands**.

2. Do one of the following:

- In the **Commands** list, select the key command that you want to restore and click **Reset**.

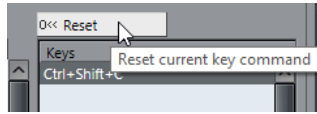

- Click **Reset All**.

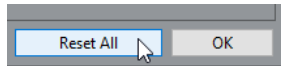

---

#### RESULT

The key commands are reset.

#### IMPORTANT

Any changes made to the default key commands are lost. If you want to be able to revert to these settings again, make sure to save them first.

---

## Default Key Commands

The default key commands are arranged in categories.

#### NOTE

When the **On-Screen Keyboard** is displayed, the usual key commands are blocked because they are reserved for the **On-Screen Keyboard**. The only exceptions are: **Ctrl/Cmd-S** (Save), **Num \*** (Start/Stop Record), **Space** (Start/Stop Playback), **Num 1** (Jump to Left Locator), **Delete** or **Backspace** (Delete), **Num /** (Cycle on/off), **F2** (Show/Hide Transport panel), and **Alt-K** (Show/Hide On-Screen Keyboard).

---

## Add Track Category

Option	Key command
Add Track	T

## Audio Category

Option	Key command
Adjust Fades to Range	A
Auto-Grid	Shift-Q
Crossfade	X

## Automation Category

Option	Key command
Read Automation for All Tracks On/Off	Alt-R
Write Automation for All Tracks On/Off	Alt-W

## Chords Category

Option	Key command
Show/Hide Chord Pads	Ctrl/Cmd-Shift-C

## Devices (Studio) Category

Option	Key command
Audio Connections	F4
Audio Performance	F12
MixConsole	F3
MixConsole in Project Window	Alt-F3
On-Screen Keyboard	Alt-K
Video Player	F8
VST Instruments	F11

## Direct Offline Processing Category

Option	Key command
Direct Offline Processing	F7

## Edit Category

Option	Key command
Activate/Deactivate Focused Object	Alt-A
Auto-Scroll On/Off	F
Copy	Ctrl/Cmd-C

<b>Option</b>	<b>Key command</b>
Cut	Ctrl/Cmd-X
Cut Time	Ctrl/Cmd-Shift-X
Delete	Delete or Backspace
Delete Time	Shift-Backspace
Duplicate	Ctrl/Cmd-D
Expand/Reduce	Alt-E
Find Track/Channel	Ctrl/Cmd-F
Group	Ctrl/Cmd-G
Insert Silence	Ctrl/Cmd-Shift-E
Invert	Alt-F
Invert Selection	Ctrl/Cmd-Alt-I
Left Selection Side to Cursor	E
Lock	Ctrl/Cmd-Shift-L
Move to Cursor	Ctrl/Cmd-L
Move to Front (Uncover)	U
Mute	M
Mute Events	Shift-M
Mute/Unmute Objects	Alt-M
Open	Ctrl/Cmd-E
Paste	Ctrl/Cmd-V
Paste at Origin	Alt-V
Paste Relative to Cursor	Shift-V
Paste Time	Ctrl/Cmd-Shift-V
Primary Parameter: Decrease	Ctrl/Cmd-Shift-Down Arrow

<b>Option</b>	<b>Key command</b>
Primary Parameter: Increase	Ctrl/Cmd-Shift-Up Arrow
Record Enable	R
Redo	Ctrl/Cmd-Shift-Z
Repeat	Ctrl/Cmd-K
Right Selection Side to Cursor	D
Secondary Parameter: Decrease	Ctrl/Cmd-Shift-Left Arrow
Secondary Parameter: Increase	Ctrl/Cmd-Shift-Right Arrow
Select All	Ctrl/Cmd-A
Select None	Ctrl/Cmd-Shift-A
Snap On/Off	J
Solo	S
Split At Cursor	Alt-X
Split Range	Shift-X
Stationary Cursor	Alt-C
Undo	Ctrl/Cmd-Z
Ungroup	Ctrl/Cmd-U
Unlock	Ctrl/Cmd-Shift-U
Unmute Events	Shift-U
Write	W

## Editors Category

<b>Option</b>	<b>Key command</b>
Edit In-Place	Ctrl/Cmd-Shift-I
Open Score Editor	Ctrl/Cmd-R
Open/Close Editor	Return

## File Category

Option	Key command
Close	Ctrl/Cmd-W
New	Ctrl/Cmd-N
Open	Ctrl/Cmd-O
Quit	Ctrl/Cmd-Q
Save	Ctrl/Cmd-S
Save As	Ctrl/Cmd-Shift-S
Save New Version	Ctrl/Cmd-Alt-S

## Media Category

Option	Key command
Open MediaBay	F5
Open/Close Attribute Inspector	Ctrl-Alt-Num 6
Open/Close Favorites	Ctrl-Alt-Num 8
Open/Close File Browser	Ctrl-Alt-Num 4
Open/Close Filters	Ctrl-Alt-Num 5
Open/Close Previewer	Ctrl-Alt-Num 2
Preview Cycle On/Off	Shift-Num /
Preview Start	Shift-Enter
Preview Stop	Shift-Num 0
Search MediaBay	Shift-F5

## MIDI Category

Option	Key command
Show/Hide Controller Lanes	Alt-L



## MixConsole History Category

Option	Key command
Undo MixConsole Step	Alt-Z
Redo MixConsole Step	Alt-Shift-Z

## Navigate Category

Option	Key command
Add Down: Expand/Undo selection in the Project window to the bottom/Move selected event in the Key Editor down 1 octave	Shift-Down Arrow
Add Left: Expand/Undo selection in the Project window/Key Editor to the left	Shift-Left Arrow
Add Right: Expand/Undo selection in the Project window/Key Editor to the right	Shift-Right Arrow
Add Up: Expand/Undo selection in the Project window to the top/Move selected event in the Key Editor up one octave	Shift-Up Arrow
Bottom: Select bottom track in the track list	End
Down: Select next in the Project window/Move selected event in the Key Editor one semitone down	Down Arrow
Left: Select previous in the Project window/Key Editor	Left Arrow
Right: Select next in the Project window/Key Editor	Right Arrow
Toggle Selection	Ctrl/Cmd-Space

<b>Option</b>	<b>Key command</b>
Top: Select top track in the track list	<b>Home</b>
Up: Select next in the Project window/ Move selected event in the Key Editor one semitone up	<b>Up Arrow</b>

## **Nudge Category**

<b>Option</b>	<b>Key command</b>
End Left	<b>Alt-Shift-Left Arrow</b>
End Right	<b>Alt-Shift-Right Arrow</b>
Left	<b>Ctrl/Cmd-Left Arrow</b>
Right	<b>Ctrl/Cmd-Right Arrow</b>
Start Left	<b>Alt-Left Arrow</b>
Start Right	<b>Alt-Right Arrow</b>

## **Project Category**

<b>Option</b>	<b>Key command</b>
Colors	<b>Alt-Shift-S</b>
Open Markers	<b>Ctrl/Cmd-M</b>
Open Pool	<b>Ctrl/Cmd-P</b>
Open Tempo Track	<b>Ctrl/Cmd-T</b>
Remove Selected Tracks	<b>Shift-Delete</b>
Set Track/Event Color	<b>Alt-Shift-C</b>
Setup	<b>Shift-S</b>

## Quantize Category

Option	Key command
Quantize	Q

## Set Insert Length Category

Option	Key command
1/1	Alt-1
1/2	Alt-2
1/4	Alt-3
1/8	Alt-4
1/16	Alt-5
1/32	Alt-6
1/64	Alt-7
1/128	Alt-8
Toggle Dotted	Alt-.
Toggle Triplet	Alt-,

## Tool Category

Option	Key command
Combine Selection Tools On/Off	Alt-Shift-1
Draw Tool	8
Drumstick Tool	0
Erase Tool	5
Glue Tool	4
Mute Tool	7
Next Tool	F10

<b>Option</b>	<b>Key command</b>
Object Selection Tool	<b>1</b>
Play Tool	<b>9</b>
Previous Tool	<b>F9</b>
Range Selection Tool	<b>2</b>
Split Tool	<b>3</b>
Zoom Tool	<b>6</b>

## Track Versions Category

<b>Option</b>	<b>Key command</b>
Duplicate Version	<b>Ctrl/Cmd-Shift-D</b>
New Version	<b>Ctrl/Cmd-Shift-N</b>
Next Version	<b>Ctrl/Cmd-Shift-H</b>
Previous Version	<b>Ctrl/Cmd-Shift-G</b>

## Transport Category

<b>Option</b>	<b>Key command</b>
Activate External Sync	<b>Alt-Shift-T</b>
Activate Metronome	<b>C</b>
Activate Punch In	<b>I</b>
Activate Punch Out	<b>O</b>
Cycle	<b>Num /</b>
Enter Left Locator	<b>Shift-L</b>
Enter Locator Range Duration	<b>Shift-D</b>
Enter Project Cursor Position	<b>Shift-P</b>
Enter Punch In Position	<b>Shift-I</b>

<b>Option</b>	<b>Key command</b>
Enter Punch Out Position	<b>Shift-O</b>
Enter Right Locator	<b>Shift-R</b>
Enter Tempo	<b>Shift-T</b>
Enter Time Signature	<b>Shift-C</b>
Exchange Time Formats	.
Fast Forward	<b>Shift-Num +</b>
Fast Rewind	<b>Shift-Num -</b>
Forward	<b>Num +</b>
Go to Left Locator	<b>Num 1</b>
Go to Project Start	<b>Num . or Num , or Num ;</b>
Go to Right Locator	<b>Num 2</b>
Insert Marker (Windows only)	<b>Insert</b>
Locate Next Event	<b>N</b>
Locate Next Hitpoint	<b>Alt-N</b>
Locate Next Marker	<b>Shift-N</b>
Locate Previous Event	<b>B</b>
Locate Previous Hitpoint	<b>Alt-B</b>
Locate Previous Marker	<b>Shift-B</b>
Locate Selection Start	<b>L</b>
Locators to Selection	<b>P</b>
Loop Selection	<b>Alt-P</b>
MIDI Retrospective Record: Insert from All MIDI Inputs	<b>Shift- Num --*</b>
Nudge Cursor Left	<b>Ctrl/Cmd- Num -</b>
Nudge Cursor Right	<b>Ctrl/Cmd- Num +</b>

<b>Option</b>	<b>Key command</b>
Panel (Transport panel)	F2
Play Selection Range	Alt-Space
Recall Cycle Marker 1 to 9	Shift-Num 1 to Num 9
Record	Num *
Rewind	Num -
Set Left Locator to Project Cursor Position	Ctrl/Cmd-Num 1
Set Marker 1	Ctrl/Cmd-1
Set Marker 2	Ctrl/Cmd-2
Set Marker 3 to 9	Ctrl/Cmd-Num 3 to Num 9 or Ctrl/Cmd-3 to 9
Set Right Locator to Project Cursor Position	Ctrl/Cmd-Num 2
Start	Enter
Start/Stop	Space
Stop	Num 0
To Marker 1	Shift-1
To Marker 2	Shift-2
To Marker 3 to 9	Num 3 to Num 9 or Shift-3 to 9

## Window Zones Category

<b>Option</b>	<b>Key command</b>
Show/Hide Left Zone	Ctrl/Cmd-Alt-L; Alt-I
Show/Hide Right Zone	Ctrl/Cmd-Alt-R
Show/Hide Upper Zone	Ctrl/Cmd-Alt-U
Show/Hide Lower Zone	Ctrl/Cmd-Alt-E or Ctrl/Cmd-Alt-B
Show/Hide Transport Bar	Ctrl/Cmd-Alt-T
Show Previous Tab	Ctrl/Cmd-Alt-Left Arrow

Option	Key command
Show Next Tab	Ctrl/Cmd-Alt-Right Arrow
Show Previous Page	Ctrl/Cmd-Alt-Up Arrow or Page Up
Show Next Page	Ctrl/Cmd-Alt-Down Arrow or Page Down
Show/Hide Info Line	Ctrl/Cmd-I
Show/Hide Overview	Alt-O

## Windows Category

Option	Key command
Inline: Key Commands	Shift-F4
Inline: Settings	Shift-F3
Inline: View Layout	Shift-F2

## Workspaces Category

Option	Key command
New	Ctrl/Cmd-Num 0
No Workspace	Alt-Num 0
Update Workspace	Alt-U
Workspace 1-9	Alt-Num 1-Num 9
Workspace X	Ctrl/Cmd-Alt-Num 0

## Zoom Category

Option	Key command
Zoom Full	Shift-F
Zoom In	H
Zoom In On Waveform Vertically	Alt-H
Zoom In Tracks	Ctrl/Cmd-Down Arrow

Option	Key command
Zoom In Vertically	Shift-H
Zoom Out	G
Zoom Out Of Waveform Vertically	Alt-G
Zoom Out Tracks	Ctrl/Cmd-Up Arrow
Zoom Out Vertically	Shift-G
Zoom to Event	Shift-E
Zoom to Selection	Alt-S
Zoom Tracks Exclusive	Z

## Setting up Tool Modifier Keys

You can set up tool modifier keys that allow you to get an alternative function when using a tool.

---

### PROCEDURE

1. In the **Preferences** dialog, select **Editing > Tool Modifiers**.

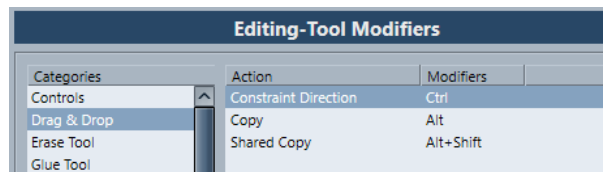

2. Select an option in the **Categories** list, and locate the action for which you want to edit the modifier key.
3. In the **Action** list, select the action.
4. Hold down the desired modifier keys and click **Assign**.

### NOTE

If the modifier keys you pressed are already assigned to another tool, you will be asked whether you want to overwrite them. If you do, this leaves the other tool without any modifier keys assigned.

5. Click **OK**.
- 

### RESULT

The modifier keys for the action are replaced.



# Customizing

In Cubase you can organize windows and dialogs in workspaces, and set up the appearance of specific elements.

## RELATED LINKS

[Workspaces](#) on page 873

[Setup Options](#) on page 876

## Workspaces

Workspaces in Cubase allow you to organize windows and specific dialogs for your common work routines.

A workspace saves the size, position, and layout or setting of important windows and dialogs, such as the **Project** window, **MixConsole**, or **Transport** panel. You can define several workspaces. This allows you to quickly switch between different working modes, either through the **Workspaces** menu or by using key commands.

You can define different workspace types that are either available for all projects on your computer or specific for one project. However, when you open a project, its last saved view is opened by default. A view is the window layout and setting that you defined for your project. The last saved view can either be a workspace view or a view that you saved without having any workspace selected. When you open an external project, the last used view on your computer is used by default.

The **Workspaces Organizer** and the **Workspaces** menu allow you to create and modify workspaces.

### NOTE

- You can also work without workspaces. In this case, the last used view of the former project will be used when you create a new project.
- In the **Preferences** dialog (**General** page), you can select which view is used when you open a project.

## RELATED LINKS

[Open Projects in Last Used View](#) on page 897

## Workspace Types

You can create global workspaces or project workspaces.

### Global Workspaces

Allows you to save a specific layout of dialogs and windows for all projects on your computer. Global workspaces are indicated by the letter G on your **Workspaces** menu.

### Project Workspaces

Allows you to save a specific layout of dialogs and windows that is saved with your current project. This allows you to open your project layout on other computers. Project workspaces are indicated by the letter P on your **Workspaces** menu.

## Workspaces for External Projects

You can determine the view of external projects when you open them in Cubase.

When you open external projects, which are projects that have been created on other computers, the window and dialog settings that you last used on your computer are applied by default. This can either be the last used view that was saved on your computer or one of your specified global workspaces.

If you want to open the original layout setting of a project, you have the following options:

- Select the project's original layout from the project workspaces on the **Workspaces** menu or in the **Workspace Organizer**.
- In the **Preferences** dialog (**General** page), select **Never** from the **Open Projects in Last Used View** menu. This opens all external projects using their original layout. However, this may lead to a modification of your custom layout.

To return to the view that you last saved without any workspace assigned, select **No Workspace** on the **Workspaces** menu.

#### RELATED LINKS

[Workspaces Organizer](#) on page 875

[Open Projects in Last Used View](#) on page 897

## Creating Workspaces

To save your current dialog and window setting for future use, you can create a new workspace.

---

#### PROCEDURE

1. Select **Workspaces > Add Workspace**.
2. In the **Name** field of the **New Workspace** dialog, enter a workspace name.
3. Select the type of workspace that you want to create.
  - **Global Workspace**
  - **Project Workspace**
4. Click **OK**.

---

#### RESULT

The workspace is saved and added to the **Workspaces** menu.

## Editing Workspaces

You can modify your created workspaces.

#### NOTE

To change a global workspace to a project workspace and vice versa, you must save it as a different workspace type.

---

#### PROCEDURE

1. On the **Workspaces** menu, select the workspace that you want to modify.
  2. Make your changes as required.
  3. On the **Workspaces** menu, select one of the following:
    - To update your current workspace, click **Update Workspace**.
    - To save your workspace as a different workspace or workspace type, click **Add Workspace**.
- 

#### RELATED LINKS

[Creating Workspaces](#) on page 874

## Workspaces Organizer

The **Workspaces Organizer** allows you to manage the existing workspaces.

- To open the **Workspaces Organizer**, click **Workspaces > Organize**.

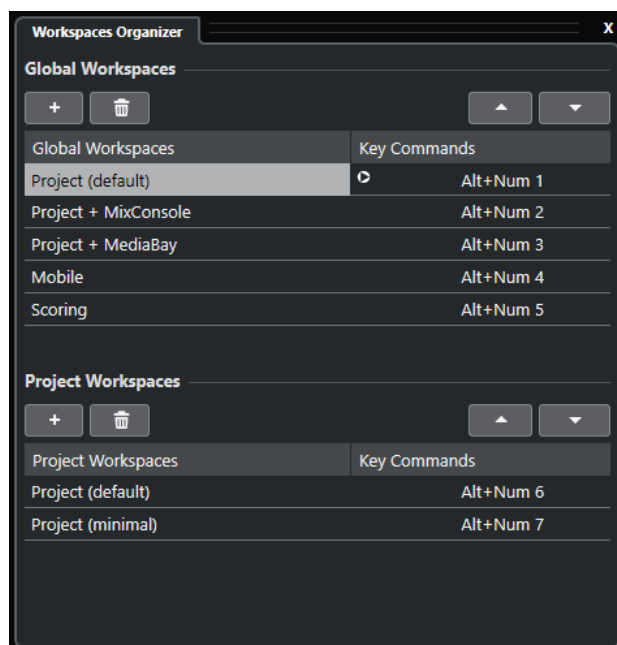

The **Workspaces Organizer** displays the global workspaces and the project workspaces in separate lists. Every workspace has an assigned key command that lets you switch views quickly. Moving or deleting workspaces within the lists changes the key command assignments. When you change the position of a workspace, the key command assignments remain in their original list position. You can click a key command of a selected workspace to open the respective key command assignment in the **Workspace** category of the **Key Commands** dialog.

To organize your workspace, you have the following options:

#### Add

Allows you to create a new workspace using the **New Workspace** dialog.

#### Delete

Deletes a selected workspace.

#### Move Up

Moves up a workspace by one position.

### Move Down

Moves down a workspace by one position.

#### NOTE

- You can also click and drag a workspace to another position within a list.
  - You can move workspaces only within a list. For a global workspace to become a project workspace and vice versa, you must save it as a different type of workspace.
  - To rename a workspace, you can double-click the workspace name.
- 

#### RELATED LINKS

[Workspaces Category](#) on page 871

## Setup Options

You can customize the appearance of the following elements:

- **Transport** panel
- Status line
- Info line
- Toolbars
- **Inspector**

## Setup Context Menus

Setup context menus are available for the **Transport** panel, the toolbars, the info lines, or the **Inspector**.

- To open the setup context menus, right-click the corresponding element.

#### NOTE

You can also click the corresponding setup buttons to open the context menu.

---

The following general options are available on the setup context menus:

- **Show All** makes all items visible.
- **Reset All** resets the interface to the default setting.
- **Setup** opens the setup dialog.

If presets are available, they can be selected on the lower half of the menu.

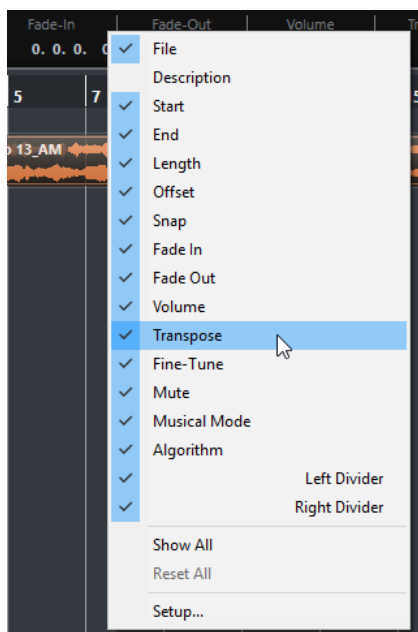

The info line setup context menu

## Setup Dialog

The setup dialog allows you to specify which elements are visible/hidden and in what order they are shown. You can save and recall setup presets.

- To open a setup dialog, right-click the element that you want to set up, and select **Setup**.

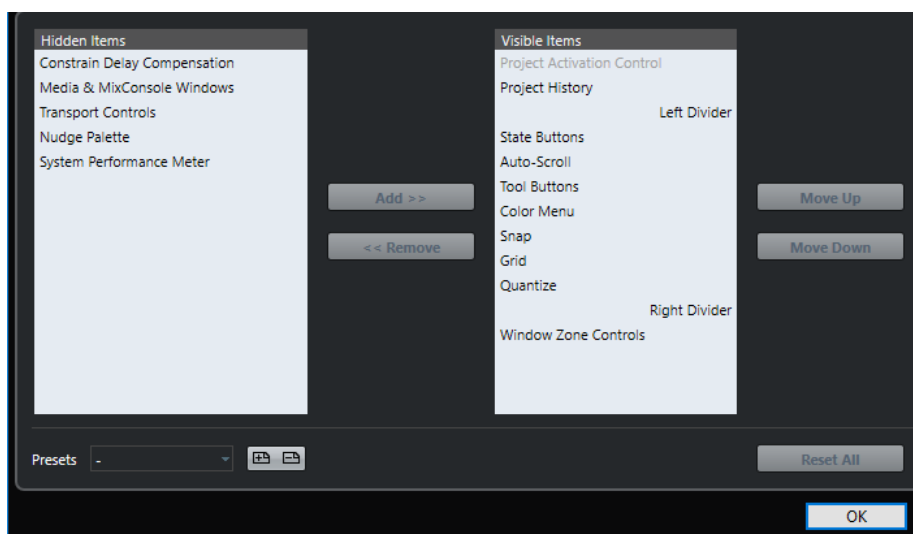

### Hidden Items

Lists the elements that are hidden.

### Visible Items

Lists the elements that are visible.

### Add

Select an item in the list of **Hidden Items**, and click **Add** to make it visible.

### Remove

Select an item in the list of **Visible Items**, and click **Remove** to hide it.

### Move Up

Select an item in the list of **Visible Items**, and click **Move Up** to reorder the items.

### Move Down

Select an item in the list of **Visible Items**, and click **Move Down** to reorder the items.

### Store

Allows you to name the current configuration and save it as a preset.

### Delete

Remove a selected preset.

### Reset All

Reverts to the default configuration.

## Windows Dialog

The **Windows** dialog allows you to manage open windows in Cubase.

- To open the **Windows** dialog, select **Window > Windows**.

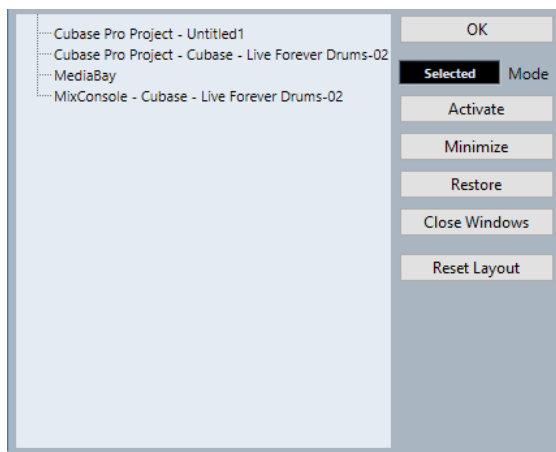

The dialog lists all open dialogs, windows, and editors. The following options are available:

### OK

Closes the dialog.

### Mode

Allows you to select a mode that affects the function.

- **Selected**  
Affects the selected window only.
- **Cascaded**  
Affects also the associated windows, such as the editors of a project window, for example.
- **All**  
Affects all windows.

### Activate

Activates the selected window.

### Minimize

Minimizes the selected or all windows.

### Restore

Restores the selected or all windows.

### Close Windows

Closes the selected or all windows.

### Reset Layout

Resets the layout of the selected window.

## Where are the Settings Stored?

There is a large number of ways in which you can customize Cubase. While some of the settings you make are stored with each project, others are stored in separate preference files.

If you need to transfer your projects to another computer in another studio, for example, you can bring all your settings along by copying the desired preference files and installing them on the other computer.

### NOTE

It is a good idea to make a backup copy of your preference files once you have set things up the way you want! This way, if another Cubase user wants to use his or her personal settings when working on your computer, you can restore your own preferences afterwards.

- On Windows, preference files are stored in the following location: “\Users\\AppData\Roaming\Steinberg\\”.
- On macOS, preference files are stored in the following location: “/Library/Preferences/<program name>/” under your home directory.
- On the Start menu, you will find a shortcut to this folder for easy access.
- The full path is: “/Users/<user name>/Library/Preferences/<program name>/”.

### NOTE

The RAMpresets.xml file, which contains various presets settings, is saved when exiting the program.

### NOTE

Program functions, such as crossfade, or configurations, such as panels, not used in the project will not be stored.

## Updating from a Previous Version of Cubase

When you are updating from Cubase 6 or higher, most of the customized settings of your previous installation are used for the new Cubase version.

When your previous Cubase version is older than Cubase 6, its settings are discarded, and the default settings of the new version of Cubase are used.

## Safe Mode Dialog

The **Safe Mode** dialog contains troubleshooting options.

- To open the **Safe Mode** dialog, launch Cubase, and hold down **Ctrl/Cmd-Shift-Alt**.

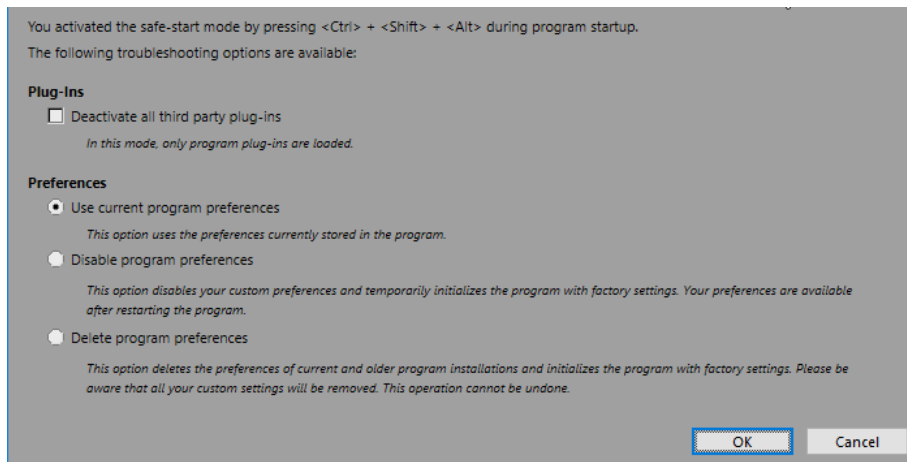

The following options are available in the **Plug-Ins** section:

#### **Deactivate all third party plug-ins**

Temporarily disables all third party plug-ins. After startup, only Steinberg plug-ins are available.

The following options are available in the **Preferences** section:

#### **Use current program preferences**

Opens the program with the current preference settings.

#### **Disable program preferences**

Disables the current preferences and opens the program with the factory default settings instead.

#### **Delete program preferences**

Deletes the preferences and opens the program with the factory default settings instead. This process cannot be undone. This affects all versions of Cubase installed on your computer.

#### RELATED LINKS

[Disabling Third Party Plug-ins](#) on page 881

[Disabling the Preferences](#) on page 880

## Disabling the Preferences

Sometimes you might experience odd program behavior that can be due to inconsistent preferences settings. In such a case, you should save your project and relaunch Cubase. You can disable or delete the current preferences settings, and load the factory defaults instead.

---

#### PROCEDURE

1. Quit Cubase.
2. Launch Cubase, and hold down **Ctrl/Cmd-Shift-Alt**.
3. In the **Preferences** section of the **Safe Start Mode** dialog, activate one of the troubleshooting options.
  - **Use current program preferences**  
Opens the program with the current preference settings.
  - **Disable program preferences**  
Disables the current preferences, and opens the program with the factory default settings instead.



- **Delete program preferences**  
Deletes the preferences and opens the program with the factory default settings instead. This process cannot be undone. Note that this affects all versions of Cubase installed on your computer.

4. Click **OK**.

---

#### AFTER COMPLETING THIS TASK

If the program works fine with disabled preferences, consider deleting and re-initializing the preferences.

#### RELATED LINKS

[Safe Mode Dialog](#) on page 879

[Preferences](#) on page 886

## Disabling Third Party Plug-ins

If Cubase does not start or if a project does not load, chances are, that this is due to a third party plug-in. In such a case, you can disable third party plug-ins on startup to identify, if the plug-in is the reason.

---

#### PROCEDURE

1. Quit Cubase.
  2. Launch Cubase, and hold down **Ctrl/Cmd-Alt-Shift**.
  3. In the **Plug-Ins** section of the **Safe Start Mode** dialog, activate **Deactivate all third party plug-ins**.
  4. Click **OK**.
- 

#### RESULT

Only Steinberg plug-ins are available after startup, and third party plug-ins are temporarily disabled.

#### RELATED LINKS

[Safe Mode Dialog](#) on page 879

# Optimizing

## Optimizing Audio Performance

This section gives you some hints and tips on how to get the most out of your Cubase system, performance-wise.

### NOTE

For details and current information on system requirements and hardware properties, refer to [steinberg.net](http://steinberg.net).

## Performance Aspects

### Tracks and Effects

The faster your computer, the more tracks, effects, and EQs you are able to play. Exactly what constitutes a fast computer is almost a science in itself, but some hints are given below.

### Short Response Times (Latency)

One aspect of performance is response time. The term “latency” refers to the buffering, that is, the temporary storing of small chunks of audio data during various steps of the recording and playback process on a computer. The larger those chunks, and the more there are, the higher the latency.

High latency is most irritating when playing VST instruments and when monitoring through the computer, that is, when listening to a live audio source via the Cubase **MixConsole** and effects. However, very long latency times (several hundred milliseconds) can also affect other processes like mixing, for example, when the effect of a fader movement is heard only after a noticeable delay.

While Direct Monitoring and other techniques reduce the problems associated with very long latency times, a system that responds fast will always be more convenient to work with.

- Depending on your audio hardware, it may be possible to trim your latency times, usually by lowering the size and the number of buffers.
- For details, refer to the audio hardware documentation.

### Audio Hardware and Driver

The hardware and its driver can have some effect on regular performance. A badly written driver can reduce the performance of your computer. But where the hardware driver design makes the most difference is with latency.

### NOTE

We recommend that you use audio hardware for which there is a specific ASIO driver.

This is especially true when using Cubase for Windows:

- Under Windows, ASIO drivers written specifically for the hardware are more efficient than the Generic Low Latency ASIO Driver and produce shorter latency times.
- Under macOS, audio hardware with properly written macOS (Core Audio) drivers can be very efficient and produce very low latency times.

However, there are additional features only available with ASIO drivers, such as the ASIO Positioning Protocol.

## Settings That Affect Performance

### Audio Buffer Settings

Audio buffers affect how audio is sent to and from the audio hardware. The size of the audio buffers affects both the latency and the audio performance.

Generally, the smaller the buffer size, the lower the latency. On the other hand, working with small buffers can be demanding for the computer. If the audio buffers are too small, you may get clicks, pops or other audio playback problems.

### Adjusting the Buffer Size

To lower the latency, you can reduce the buffer size.

---

#### PROCEDURE

1. Select **Studio > Studio Setup**.
  2. In the **Devices** list, select your audio hardware driver.
  3. Click **Control Panel**.
  4. Do one of the following:
    - Windows: Adjust the buffer size in the dialog that opens.
    - macOS: Adjust the buffer size in the **CoreAudio Device Settings** dialog.
- 

### Multi Processing

Multi processing distributes the processing load evenly to all available CPUs, allowing Cubase to make full use of the combined power of the multiple processors.

Multi processing is activated by default. You can find the setting in the **Studio Setup** dialog (**VST Audio System** page).

### Audio Performance Window

This window shows the audio processing load and the hard disk transfer rate. This allows you to verify that you do not run into performance problems when adding effects or plug-ins, for example.

- To open the **Audio Performance** window, select **Studio > Audio Performance**.

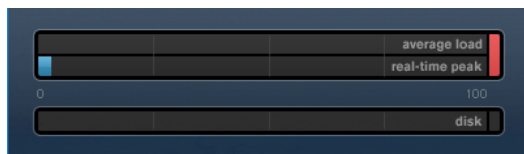

### Average load

Shows how much of the available CPU power is used for audio processing.

### Real-time peak

Shows the processing load in the real time path of the audio engine. The higher this value, the higher the risk that dropouts occur.

### Overload indicator

The overload indicator to the right of the **real-time peak** indicator and the **average load** indicator displays overloads of the average or real-time indicator.

If it lights up, decrease the number of EQ modules, active effects, and audio channels that play back simultaneously. You can also activate the ASIO-Guard.

### Disk

Shows the hard disk transfer load.

### Disk overload indicator

The overload indicator to the right of the disk indicator lights up if the hard disk does not supply data fast enough.

If it lights up, use **Disable Track** to reduce the number of tracks playing back. If this does not help, you need a faster hard disk.

### NOTE

You can show a simple view of the performance meter on the **Transport** panel and on the **Project** window toolbar. These meters only feature the average and the disk indicator.

---

## ASIO-Guard

The ASIO-Guard allows you to shift as much processing as possible from the ASIO real time path to the ASIO-Guard processing path. This results in a more stable system.

The ASIO-Guard allows you to preprocess all channels as well as VST instruments that do not need to be calculated in real time. This leads to fewer dropouts, the ability to process more tracks or plug-ins, and the ability to use smaller buffer sizes.

### ASIO-Guard Latency

High ASIO-Guard levels lead to an increased ASIO-Guard latency. When you adjust a volume fader, for example, you will hear the parameter changes with a slight delay. The ASIO-Guard latency, in contrast to the latency of the audio hardware, is independent from live input.

### Restrictions

The ASIO-Guard cannot be used for:

- Real time-dependent signals
- External effects and instruments

### NOTE

If you select **Studio > VST Plug-in Manager** and click **Show VST Plug-in Information**, you can deactivate the ASIO-Guard option for selected plug-ins.

---

If you activate the monitoring for an input channel, a MIDI instrument, or a VST instrument channel, the audio channel and all dependent channels are automatically switched from ASIO-Guard to real time processing and vice versa. This results in a gentle fade out and fade in of the audio channel.

RELATED LINKS

[VST 2 Plug-in Path Settings](#) on page 566

## Activating the ASIO-Guard

---

PROCEDURE

1. Select **Studio > Studio Setup**.
2. In the **Devices** list, select **VST Audio System**.
3. Activate the **Activate ASIO-Guard** option.

NOTE

This option is only available if you activate **Activate Multi Processing**.

---

4. Select an **ASIO-Guard Level**.  
The higher the level, the higher the processing stability and audio processing performance. However, higher levels also lead to an increased ASIO-Guard latency and memory usage.
-

# Preferences

The **Preferences** dialog provides options and settings that control the global behavior of the program.

## Preferences Dialog

The **Preferences** dialog is divided into a navigation list and a settings page. Clicking one of the entries in the navigation list opens a settings page.

- To open the **Preferences** dialog, select **Edit > Preferences**.

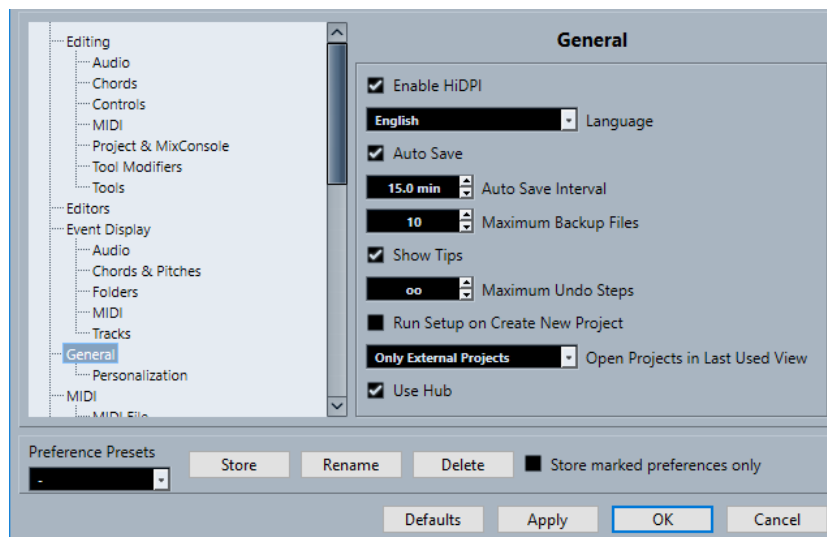

In addition to the settings, the dialog provides the following options:

### Preference Presets

Allows you to select a saved preference preset.

### Store

Allows you to save the current preferences as a preset.

### Rename

Allows you to rename a preset.

### Delete

Allows you to delete a preset.

### Store marked preferences only

Allows you to select which pages are included in the preset.

### Defaults

Resets the options on the active page to their default settings.

**Apply**

Applies any changes that you have made without closing the dialog.

**OK**

Applies any changes that you have made and closes the dialog.

**Cancel**

Closes the dialog without saving any changes.

## Saving Preference Presets

You can save complete or partial preference settings as presets.

---

PROCEDURE

1. In the **Preferences** dialog, make your changes.
2. Click **Store** in the lower left section of the dialog.
3. Enter a preset name and click **OK**.

---

RESULT

Your settings are now available on the **Preference Presets** pop-up menu.

## Saving Partial Preference Settings

You can save partial preference settings. This is useful when you have made settings that only relate to a certain project or situation, for example. When you apply a saved partial preference preset, you only change the saved settings. All other preferences are left unchanged.

---

PROCEDURE

1. In the **Preferences** dialog, make your changes.
2. Activate **Store marked preferences only**.  
In the preferences list, the **Store** column is shown.

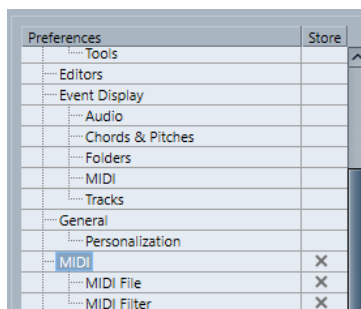

3. Click in the **Store** column of the preference pages that you want to save.
4. Click **Store** in the lower left section of the dialog.
5. Enter a preset name and click **OK**.

---

RESULT

Your settings are now available from the **Preference Presets** pop-up menu.

## Editing

### 'Edit Solo'/'Record in MIDI Editors' Follow Focus

Suspends **Record in Editor** and **Solo Editor** in the MIDI editor if the **Project** window gets the focus.

### Default Track Time Type

Allows you to select the default track time type for new tracks.

- **Musical**  
Sets new tracks to musical time base.
- **Time Linear**  
Sets new tracks to linear time base.
- **Follow Transport Main Display**  
Sets new tracks to follow the primary time format: **Bars+Beats** format sets new tracks to musical time base. **Seconds**, **Timecode**, **Samples**, etc. sets new tracks to linear time base.

### Display Warning before Deleting Non-Empty Tracks

Shows a warning if you delete tracks that are not empty.

### Select Track on Background Click

Allows you to select a track by clicking in the event display background.

### Auto Select Events under Cursor

Automatically selects all events in the **Project** window or in an editor that are under the project cursor.

### Cycle Follows Range Selection

Sets the left locator to the range start position and the right locator to the range end position of a range selection.

### Delete Overlaps

Deletes overlapped, that is, hidden, sections of overlapping events. Hold **Shift** while moving events to override this setting.

### Parts Get Track Names

Automatically changes event names to the name of the track they are moved to.

### Lock Event Attributes

Determines which properties are affected when you lock an event. You can use any combination of the following:

- **Position**  
Locks the position so that the event cannot be moved.
- **Size**  
Locks the size so that the event cannot be resized.
- **Other**  
Locks all other editing of the event. This includes adjusting the fades and event volume, processing, etc.

### Quick Zoom

Only redraws the contents of parts and events once you have stopped changing the zoom. This is useful if screen redraws are slow on your system.



### **Use Up/Down Navigation Commands for Selecting Tracks only**

Uses the **Up Arrow/Down Arrow** keys for track selection, not for event/part selection.

### **Track Selection Follows Event Selection**

Automatically selects the corresponding track if you select an event in the **Project** window.

### **Automation Reduction Level**

Allows you to remove all superfluous automation events. A reduction level value of 0% removes repeated automation points only. A reduction level value between 1 to 100 % smoothens the automation curve. The default value of 50 % should reduce the automation data amount significantly without touching the sound result of the existing automation.

### **Show Automation Track in Project on Writing Parameter**

Reveals the automation track on writing automation parameters. This is useful if you want to have a visual control of all parameters changed on writing.

### **Automation Follows Events**

Lets automation events automatically follow when you move, duplicate, copy, or paste an event or part on the track. This facilitates setting up automation that is related to a specific event or part, instead of a specific position in the project.

### **Drag Delay**

Allows you to set up a delay in ms that is used when you move events. This is useful to avoid accidentally moving events when you click on them in the **Project** window.

## **Editing - Audio**

### **Treat Muted Audio Events like Deleted**

Allows you to play the hidden event of 2 overlapping audio events when you mute the top event.

### **Use Mouse Wheel for Event Volume and Fades**

Allows you to use the mouse wheel to move event volume and fades.

- Moving the mouse wheel moves the event volume curve up or down.
- Holding down **Shift** while moving the mouse wheel moves the fade curves.
- Positioning the mouse in the left half of the event moves the end point of the fade in.
- Positioning the mouse in the right half of the event moves the start point of the fade out.

### **On Import Audio Files**

Determines what happens when you import an audio file.

- **Open Options Dialog**  
Opens a dialog where you can select whether you want to copy the file to the audio folder and/or convert it to the project settings.
- **Use Settings**  
Uses the default settings for importing audio.

### **Enable Automatic Hitpoint Detection**

Enables the automatic hitpoint detection for imported or newly recorded audio files.

### **Remove Regions/Hitpoints on all Offline Processes**

Removes regions/hitpoints of audio ranges when you perform offline processing.

### On Processing Shared Clips

Determines what happens when you apply processing to a shared clip that is used by more than one event in the project.

- **Open Options Dialog**  
Opens the **Options** dialog that allows you to select whether you want to create a new version of the clip or apply the processing to the existing clip.
- **Create New Version**  
Creates a new editing version of the clip, and applies the processing to that version leaving the original clip unaffected.
- **Process Existing Clip**  
Applies the processing to the existing clip. All events playing that clip are affected.

### Time Stretch Tool Algorithm

Sets the default algorithm that is applied when you use the **Object Selection** tool in **Sizing Applies Time Stretch** mode.

### Default Warping Algorithm

Sets the warp algorithm for new audio clips in the project.

## Editing - Chords

### 'X' Chords Mute Notes on Tracks That are in Follow Chord Track Mode

Mutes playback when you play back a track that follows the chord track and the cursor reaches an undefined chord event (X chord).

### Disable 'Acoustic Feedback' during Playback

Disables **Acoustic Feedback** during playback. This ensures that chord events are not triggered twice.

### Hide Muted Notes in Editors

Hides notes that get muted due to their MIDI track following the chord track.

## Editing - Controls

### Value Box/Time Control Mode

Allows you to select your preferred way of controlling value fields.

- **Text Input on Left-Click**  
Clicking opens a value box for editing.
- **Increment/Decrement on Left/Right-Click**  
Clicking decreases the value, right-clicking increases the value. Double-clicking allows you to enter values manually.
- **Increment/Decrement on Left-Click and Drag**  
Clicking and dragging up or down adjusts the value. Double-clicking allows you to enter values manually.

### Knob Mode

Allows you to select your preferred way of controlling knobs.

- **Circular**  
Clicking and dragging in a circular motion changes the setting. Clicking anywhere along the encoder's edge immediately changes the setting.
- **Relative Circular**

Clicking anywhere on an encoder and dragging changes the current setting. There is no need to click on the exact current position.

- **Linear**

Clicking on an encoder and dragging up or down, or left or right changes the setting.

#### Slider Mode

Allows you to select your preferred way of controlling value sliders.

- **Jump**

Clicking anywhere on a slider instantly moves the slider handle to that position.

- **Touch**

Clicking and dragging the actual slider handle adjusts the setting.

- **Ramp**

Clicking and dragging a slider causes the handle to move smoothly to the new position.

- **Relative**

Clicking and dragging up or down changes the setting according to how far you drag, not according to where you click.

## Editing - MIDI

### Select Controllers in Note Range: Use Extended Note Context

Takes into account the extended note context when you move notes together with their controllers. This means that controllers between the last selected note and the following note or the end of the part are also moved.

### Legato Overlap

Allows you to set an overlap for the **Legato** function. **Legato** allows you to extend MIDI notes so that they reach the next notes.

An overlap setting of 0 ticks causes each selected note to extend so that it reaches the next note exactly. A positive value causes the notes to overlap by the specified number of ticks. A negative value causes a slight gap between the notes.

### Legato Mode: Between Selected Notes Only

Adjusts the length of selected notes so that they reach the next selected note.

### Split MIDI Events

Splits MIDI events when you split a MIDI part in the **Project** window, and the split position intersects the MIDI events. This also creates new notes at the beginning of the second part.

### Split MIDI Controllers

Splits MIDI controllers when you split a MIDI part in the **Project** window, and the part contains a controller. If the controller value at the split position is not zero, a new controller event of the same type and value is inserted at the split position at the start of the second part.

#### NOTE

If you just split a part and play back the result, it will sound the same regardless of this setting. However, if you split a part and delete the first half or move the second half to a different position in the project, you may want to activate **Split MIDI Controllers** to make sure all controllers have the correct value at the beginning of the second part.

## Editing - Project & MixConsole

### Select Channel/Track on Solo

Selects channels/tracks when you click their **Solo** button.

### Select Channel/Track on Edit Settings

Selects channels/tracks when you click their **Edit Channel Settings** button.

### Scroll to Selected Track

Scrolls the track list when you select a **MixConsole** channel and the respective track is out of view.

### Sync Selection in Project Window and MixConsole

Synchronizes the selection in the **Project** window and the **MixConsole**.

### Enable Record on Selected MIDI Track

Record-enables MIDI tracks when you select them.

### Enable Record on Selected Audio Track

Record-enables audio tracks when you select them.

### Enable Solo on Selected Track

Solos tracks when you select them.

### Deep Track Folding

Applies the **Track Folding** functions to all subelements of the tracks.

### Enlarge Selected Track

Enlarges a track when you select it. If you select a different track, this track is enlarged, and the previously selected track is displayed in its original size.

## Editing - Tool Modifiers

On this page, you can specify which modifier keys are used for additional functionality when using tools.

---

### PROCEDURE

1. Select an option in the **Categories** list.
  2. Select the action for which you want to edit the modifier keys in the **Action** list.
  3. On your computer keyboard, hold down the modifier keys and click **Assign**.
- 

### RESULT

The current modifier keys for the action are replaced. If this tool already has assigned modifier keys, you are prompted to replace them.

## Editing - Tools

### Show Toolbox on Right Click

Opens a toolbox when you right-click in the event display and editors. To open the context menu instead of the toolbox, press any modifier key when right-clicking.

### Cross-Hair Cursor

Allows you to set up the colors for the line and the mask of the cross-hair cursor, as well as its width.

### **Zoom Tool Standard Mode: Horizontal Zooming Only**

Zooms the window horizontally without changing the track height when you zoom with the **Zoom** tool.

### **Select Tool: Show Extra Info**

Displays the current pointer position and the name of the track and event at which you are pointing when you use the **Object Selection** tool in the **Project** window event display.

### **Show Notification when Switching Tool Mode with Key Command**

Shows a notification when you switch the tool mode by using a key command.

## Editors

### **Use Drum Editor when Drum Map is assigned**

Shows drum note symbols in parts on MIDI tracks to which drum maps are assigned. The parts automatically open in the **Drum Editor** on double-click. This overwrites the **Default MIDI Editor** setting.

### **Default MIDI Editor**

Determines which editor is opened when you double-click a MIDI part or when you select it and press **Ctrl/Cmd-E**. This setting is overwritten for tracks with drum maps if **Use Drum Editor when Drum Map is assigned** is activated.

### **Editor Content Follows Event Selection**

Open editors show the events that are selected in the **Project** window.

### **Double-click opens Editor in a Window/in Lower Zone**

Determines where an editor is opened when you double-click an audio event or a MIDI part, or when you use the key command assigned to **Open/Close Editor**.

### **Open Editor Commands open Editors in a Window/in Lower Zone**

Determines where an editor is opened when you use an open command from the **Audio** or **MIDI** menu or the corresponding key commands.

## Event Display

The **Event Display** section contains several settings for customizing the display in the **Project** window.

### **Show Event Names**

Shows the names on parts and events.

### **Hide Truncated Event Names**

Hides event names if they are too long.

### **Show Overlaps**

Determines how overlapping events are displayed.

### **Grid Overlay Intensity**

Sets the overlay intensity of the displayed grid lines.

### **Event Handling Opacity**

Sets the opacity of overlying events when you move them.

### **Event Opacity**

Sets the opacity of the event background.

NOTE

- If you reduce the event opacity, it might be helpful to increase the **Waveform Brightness** for audio events or the **Note Brightness** for MIDI events.
- Reducing the opacity may result in a less responsive user interface.

**Smallest Track Height to Show Data**

Determines from which track height the track contents are displayed.

**Smallest Track Height to Show Name**

Determines from which track height the track names are displayed.

RELATED LINKS

[Waveform Brightness](#) on page 894

[Note Brightness](#) on page 896

## Event Display - Audio

**Interpolate Audio Waveforms**

Interpolates sample values to form curves when you zoom in to one sample per pixel or less.

**Show Event Volume Curves Always**

Shows event volume curves, regardless of whether the event is selected.

**Show Waveforms**

Shows waveforms for audio events.

**Show Hitpoints on Selected Events**

Shows hitpoints for selected audio events.

**Waveform Brightness**

Sets the brightness of the waveform.

**Waveform Outline Intensity**

Sets the intensity of the waveform outline.

**Fade Handle Brightness**

Sets the brightness of the fade lines for audio events.

**Background Color Modulation**

Reflects the waveform dynamics in the background of audio waveforms.

## Event Display - Chords & Pitches

**Pitch Notation**

- **Note Name**  
Allows you to select how chord symbols are displayed. You can choose **English**, **German**, or **Solfège**.
- **Naming Format**  
Allows you to determine how MIDI note names are displayed in editors, etc.
- **Display 'Bb' as 'B'**  
Displays 'B' as a pitch name. This is only available if you selected **English** in the **Note Name** pop-up menu.
- **Display 'B' as 'H'**

Displays 'H' as a pitch name. This is only available if you selected **English** in the **Note Name** pop-up menu.

- **Enharmonics from Chord Track**  
Uses the chord events on the chord track to determine if enharmonically equivalent notes in the **Key Editor** and in the **List Editor** are displayed as sharp or flat.

### Chord Font

Allows you to specify a font for all chord symbols.

### Chord Symbols

Allows you to select your preferred display method for major 7th chords, minor chords, half-diminished chords, diminished chords, and augmented chords.

### Custom Chord Symbols

Allows you to modify the default chord symbols that are used on the chord track, for the chord pads, and in the **Score Editor**.

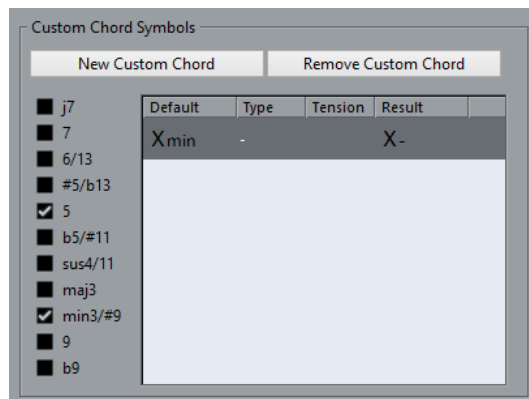

- **New Custom Chord** allows you to add a new custom chord symbol.
- The options to the left allow you to specify the chord for which you want to change the chord symbol.
- Click the **Type** and **Tension** column and enter your custom symbol.

#### NOTE

You must define custom symbols for each set of tensions.

- The **Result** column shows how the chord will be displayed.
- The **Remove Custom Chord** button allows you to remove the custom chord symbol that is selected in the list.

---

#### EXAMPLE

To change the appearance of all minor chords from Xmin to X-, click **New Custom Chord**, activate **5** and **min3/#9** to define the chord type, and change the symbol in the **Type** column from min to -.

---

## Event Display - Folders

### Show Event Details

Displays event details instead of data blocks.

This setting depends on the **Show Data on Folder Tracks** setting.

### Show Data on Folder Tracks

Determines in which case data blocks or event details are displayed on folder tracks.

- **Always Show Data**  
Displays data blocks or event details always.
- **Never Show Data**  
Displays nothing.
- **Hide Data When Expanded**  
Hides the display of events when you open folder tracks.

## Event Display - MIDI

### Part Data Mode

Determines if and how events in MIDI parts are shown. This setting is overwritten for tracks with drum maps if **Use Drum Editor when Drum Map is assigned** is activated.

### Show Controllers

Shows non-note events such as controllers, etc. in MIDI parts.

### Note Brightness

Sets the brightness of note events.

### Controller Brightness

Sets the brightness of controller events.

### RELATED LINKS

[Use Drum Editor when Drum Map is assigned](#) on page 893

## Event Display - Tracks

### Default Track Name Width

Sets the default name width for all track types.

## General

The **General** page contains general settings that affect the program user interface. Set these according to your preferred work methods.

### Enable HiDPI (Windows only)

Enables the appropriate resolution to render Cubase GUI elements sharp and precise on high resolution displays, and support scaling factors of 100 % and 200 %.

#### NOTE

On macOS, you can disable HiDPI support in the Cubase application folder by invoking **Get Info** and checking **Open in Low Resolution**.

---

### Language

Allows you to select which language is used in the program. After switching the language, you must restart the program for the change to take effect.

### Auto Save

Automatically saves backup copies of all open projects with unsaved changes. These are named Name.bak, where name is the name of the project, and are saved in the project folder. Backup copies of unsaved projects are named #UntitledX.bak, where X is an incremental number, to allow multiple backup copies in the same project folder.



### Auto Save Interval

Allows you to specify how often a backup copy is created.

### Maximum Backup Files

Allows you to specify how many backup files are created. When the maximum number of backup files is reached, the existing files is overwritten starting with the oldest file.

### Show Tips

Displays an explanatory tooltip when you position the mouse pointer over an icon or button in Cubase.

### Maximum Undo Steps

Allows you to specify the number of undo steps.

### Run Setup on Create New Project

Opens the **Project Setup** dialog every time you create a new project.

### Open Projects in Last Used View

Allows you to determine what window layout is used when you open a project.

- **Never**  
Uses the original window layout and settings.
- **Only External Projects**  
Projects that have been created on a different computer use the view that you last used on your computer. Projects that have been created on this computer use the original window layout and settings.
- **Always**  
Uses the view that you last used on your computer.

### Use Hub

Opens the **Hub** when you start Cubase or create a new project using the **File** menu.

## General - Personalization

### Default Author Name

Allows you to specify an author name that is used by default for new projects. This is included as metadata when exporting audio files with an iXML chunk.

### Default Company Name

Allows you to specify a company name that is used by default for new projects. This is included as metadata when exporting audio files with an iXML chunk.

## MIDI

This page contains settings that affect MIDI recording and playback.

### MIDI Thru Active

Sets all MIDI tracks that are record-enabled or have monitoring activated to echo incoming MIDI data, sending it back out on their respective MIDI outputs and channels. This allows you to hear the correct sound from your MIDI instrument during recording.

#### NOTE

If you use MIDI Thru, select **Local Off** mode on your MIDI instrument to prevent each note from sounding twice.

---

### **Reset on Stop**

Sets Cubase to send out MIDI reset messages, including note-off and controller resets, on stop.

### **Never Reset Chased Controllers**

Never resets controllers to 0 when you stop playback or move to a new position in the project.

### **Length Adjustment**

Allows you to enter a length adjustment value in ticks by which the notes that have the same pitch and MIDI channel are adjusted. This ensures that there is always a short time between the end of one note and the start of another. By default, there are 120 ticks per 1/16 note, but you can adjust this with the **MIDI Display Resolution** setting.

### **Chase Events**

Chases event types for which one of the chase options is activated when you locate to a new position and start playback. This makes your MIDI instruments sound as they should when you locate to a new position and start playback.

If **Chase not limited to Part Boundaries** is activated, MIDI controllers are also chased outside the part boundaries, and the chase is performed on the part under the cursor as well as on all the parts to the left of it. Deactivate this for very large projects, as it slows down processes such as positioning and soloing.

### **MIDI Display Resolution**

Allows you to set the display resolution for viewing and editing MIDI data.

### **Extend Playback Range of Notes that start before the Part**

Extends the playback range of MIDI notes that start before the part in ticks. This is useful if MIDI events start shortly before the start of the MIDI part. If you do not extend the playback range, these events are not played. This setting is also taken into account during cycle playback.

### **Insert Reset Events after Record**

Inserts a reset event at the end of each recorded part. This resets controller data, such as **Sustain**, **Aftertouch**, **Pitchbend**, **Modulation**, or **Breath Control**. This is useful if you stop recording before the note off command is sent, for example.

### **Audition through MIDI Inserts/Sends**

Activates the layering of MIDI instruments (by MIDI sends) also within the MIDI editors. This way, the acoustic feedback of the editors sends the MIDI data not only to the output selected for the track, but additionally through any MIDI inserts and MIDI sends assigned to it. However, this also means that MIDI events will be sent through any MIDI plug-ins assigned to this track.

### **MIDI Latency Mode**

Allows you to specify the latency of the MIDI playback engine.

**Low** lowers the latency and increases the responsiveness of the MIDI playback engine. However, this setting might also decrease your computer performance if your project contains lots of MIDI data.

**Normal** is the default mode and the recommended setting for most workflows.

**High** increases the latency and the playback buffer. Use this if you work with complex VST instrument libraries or with projects that have a very high performance level.

### **MIDI Max. Feedback in ms**

Allows you to set the maximum length of the notes when using **Acoustic Feedback** in MIDI editors.

## MIDI - MIDI File

### Export Options

These options allow you to specify what data is included in exported MIDI files.

#### **Export Inspector Patch**

Includes MIDI patch settings in the **Inspector** as MIDI bank select and program change events in the MIDI file.

#### **Export Inspector Volume/Pan**

Includes volume and pan settings in the **Inspector** as MIDI volume and pan events in the MIDI file.

#### **Export Automation**

Includes automation as MIDI controller events in the MIDI file. This also includes automation recorded with the **MIDI Control** plug-in.

If you record a continuous controller (CC7, for example) and deactivate **Read Automation** for the automation track, only the part data for this controller is exported.

#### **Export Inserts**

Includes MIDI modifiers and MIDI inserts in the MIDI file.

#### **Export Sends**

Includes MIDI sends in the MIDI file.

#### **Export Markers**

Includes markers as standard MIDI file marker events in the MIDI file.

#### **Export as Type 0**

Exports a type 0 MIDI file with all data on a single track, but on different MIDI channels. If you deactivate this option, a type 1 MIDI file with data on separate tracks is exported.

#### **Export Resolution**

Allows you to set a MIDI resolution between 24 and 960 for the MIDI file. The resolution is the number of pulses, or ticks, per quarter note (PPQ) and determines the precision with which you will be able to view and edit the MIDI data. The higher the resolution, the higher the precision. The resolution should be chosen depending on the application or sequencer with which the MIDI file will be used, because certain applications and sequencers may not be able to handle certain resolutions.

#### **Export Locator Range**

Exports only the range between the left and right locator.

#### **Export includes Delay**

Includes delay settings you have made in the **Inspector** in the MIDI file.

## Import Options

The **Import Options** for MIDI files allow you to specify what data is included in imported MIDI files.

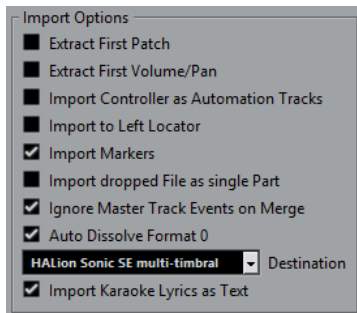

### Extract First Patch

Converts the first **Program Change** and **Bank Select** events for each track to **Inspector** settings for the track.

### Extract First Volume/Pan

Converts the first **MIDI Volume** and **Pan** events for each track to **Inspector** settings for the track.

### Import Controller as Automation Tracks

Converts **MIDI Controller** events in the MIDI file to automation data for the MIDI tracks.

### Import to Left Locator

Aligns the imported MIDI file at the position of the left locator.

### Import Markers

Imports Standard MIDI File Markers in the file and converts them to Cubase markers.

### Import Dropped File as Single Part

Places the file on one track if you drag a MIDI file into the project.

### Ignore Master Track Events on Merge

Ignores tempo track data if you import a MIDI file into the current project. The imported MIDI file will play according to the current tempo track in the project.

### Auto Dissolve Format 0

Automatically dissolves imported MIDI files of type 0. Each embedded MIDI channel in the file is placed on a separate track in the **Project** window.

### Destination

Allows you to specify what happens when you drag a MIDI file into the project.

- **MIDI Tracks** creates MIDI tracks for the imported file.
- **Instrument Tracks** creates instrument tracks for each MIDI channel in the MIDI file and lets the program automatically load appropriate presets.
- **HALion Sonic SE multi-timbral** creates several MIDI tracks, each routed to a separate instance of HALion Sonic SE in the **VST Instruments** window, and loads the appropriate presets.

### Import Karaoke Lyrics as Text

Converts karaoke lyrics in the MIDI file to text that can be displayed in the **Score Editor**. If this option is deactivated, lyrics are only shown in the **List Editor**.

## MIDI - MIDI Filter

This page allows you to prevent certain MIDI messages from being recorded and/or echoed by the MIDI thru function (thruput).

The page is divided into 4 sections:

### Record

Prevents the corresponding type of MIDI message from being recorded. It will, however, be thruput, and if already recorded, play back normally.

### Thru

Prevents the corresponding type of MIDI message from being thruput. It will, however, be recorded and played back normally.

### Channels

Prevents MIDI messages on that MIDI channel from being recorded or thruput. Already recorded messages are, however, played back normally.

### Controller

Prevents certain MIDI controller types from being recorded or thruput.

To filter out a controller type, select it from the list at the top of the section and click **Add**. It is shown in the list below.

To remove a controller type from the list (allow it to be recorded and thruput), select it in the lower list and click **Remove**.

## MediaBay

### Maximum Items in Results List

Sets the maximum number of files that are displayed in the **Results** list.

### Allow Editing in Results List

Enables editing of attributes in the **Results** list.

### Show File Extensions in Results List

Displays file name extensions in the **Results** list.

### Scan Folders Only When MediaBay Is Open

Scans for media files when the **MediaBay** window is open.

#### NOTE

During playback or recording no folder scans are performed.

---

### Scan Unknown File Types

Scans all file types.

## Metering

### Map Input Bus Metering to Audio Track (in Direct Monitoring)

Maps the input bus metering to monitor-enabled audio tracks, giving you the opportunity to watch the input levels of your audio tracks when working in the **Project** window. For this to work, activate **Direct Monitoring** in the **Studio Setup** dialog.

Note that the tracks are mirroring the input bus signal, that is, you will see the same signal in both places. When using mapped metering, any functions, such as trimming, that you apply to the audio track are not reflected in its meters.

### Meters' Peak Hold Time

Allows you to specify for how long the peak levels are held in the meters. For this to work, deactivate **Meters - Hold Forever** in the **MixConsole**.

### Meters' Fallback

Allows you to specify how quickly the meters in the **MixConsole** return to lower values after signal peaks.

## Metering - Appearance

This page allows you to assign colors to level meter values to quickly identify what levels are reached.

### Add

Adds a color handle to the top of the meter.

### Remove

Removes the selected color handle.

### RELATED LINKS

[Setting up Meter Colors](#) on page 328

## Record

This page contains settings related to audio and MIDI recording.

### Deactivate Punch In on Stop

Deactivates **Punch In** on the **Transport** panel whenever you enter stop mode.

### Stop after Automatic Punch Out

Stops playback after automatic **Punch Out**. If the post-roll value on the **Transport** panel is set to a value other than zero, playback will continue for the set time before stopping.

## Record - Audio

### Audio Pre-Record Seconds

Sets for how many seconds any incoming audio you play is captured in buffer memory during playback or in stop mode.

### When Recording Wave Files Larger than 4 GB

Determines what happens if you record wave files that are larger than 4 GB.

- To split the wave file, select **Split Files**.  
Use this if you work on a FAT32 file system that supports only file sizes up to 4 GB.
- To save the wave file as an RF64 file, select **Use RF64 Format**.  
RF64 files use the .wav extension. However, they can only be opened with an application that supports the RF64 standard.

### Create Audio Images during Record

Creates and displays a waveform image during the recording process.

#### NOTE

This real-time calculation uses some extra processing power.

---

## Record - Audio - Broadcast Wave

This page allows you to specify the **Description**, **Author**, and **Reference Value** text strings that are embedded in recorded Broadcast Wave files. The settings you make here also appear as default strings in the **Broadcast Wave Chunk** dialog when you export files to certain formats. Not only Broadcast Wave files can contain embedded information, but also Wave, Wave 64, and AIFF files.

## Record - MIDI

### Record-Enable allows MIDI Thru

Prevents record-enabled MIDI or instrument tracks from echoing incoming MIDI data. This way record-enabled tracks to which a VST instrument is assigned do not play doubled notes.

### Snap MIDI Parts to Bars

Lengthens recorded MIDI parts so that they start and end at whole bar positions. If you are working in a context that is based on bars and beats, this can make editing, such as moving, duplicating, and repeating, easier.

### MIDI Record Catch Range in ms

Ensures that the very start of a recording that starts at the left locator is included.

### Retrospective Record Buffer Size

You can capture MIDI data that you played in **Stop** mode or during playback and turn them into a MIDI part. **Retrospective Record Buffer Size** determines how much MIDI data can be captured in the buffer.

### ASIO Latency Compensation Active by Default

Determines the initial state of the **ASIO Latency Compensation** button in the track list for MIDI or instrument tracks.

If you record live on a VST instrument, you usually compensate the latency of your audio card by playing too early. In consequence, the timestamps are recorded too early. By activating this option, all recorded events are moved by the current latency, and playback sounds like during the recording situation.

### Add Latency to MIDI-Thru Processing

If you set the audio buffer size to a high value, and you play an arpeggiator in real time, for example, the MIDI notes are output with an increased latency.

If you consequently adapt your playing to the output latency, the notes are recorded even later. To minimize this effect, you can activate **Add Latency to MIDI-Thru Processing**. This adds a regular latency to each note that is played in real time.

### Replace Recording in Editors

Affects the result of recording in a MIDI editor when **Replace** mode is selected as a record mode:

- **None**  
Nothing is replaced.
- **Controller**  
Only controller data is replaced, not notes.
- **All**  
**Replace** mode works as usual. Notes and controllers are replaced when recording.

## Transport

This page contains options related to playback, recording, and positioning.

### Playback Toggle Triggers Local Preview

Allows you to use **Space** on your keyboard to start/stop local playback of the selected file in the **Sample Editor** or the **Pool**.

When the **Sample Editor** is not open or when there is no audio file selected in the **Pool**, **Space** still toggles the global project playback.

### Show Timecode Subframes

Shows subframes for all frame-based display formats.

### User-definable Frame Rate

Allows you to set the frame rate for the ruler display format **User**.

### Return to Start Position on Stop

Automatically sets the project cursor to the position where recording or playback last started when you stop playback.

### Stop Playback while Winding

Stops playback when you click **Rewind** or **Fast Forward** on the **Transport** panel.

### Wind Speed Options

These options affect the fast forward/rewind speed.

- **Adjust to Zoom** adapts the wind speed to the horizontal zoom factor.  
If you zoom in very close for detailed editing, you probably do not want to have a high fast forward/rewind speed. Because of this, the **Speed Factor** does not have any effect in this mode. The **Fast Wind Factor** still applies.
- **Fixed** keeps a fixed wind speed regardless of the horizontal zoom factor.
- **Speed Factor** allows you to set the wind speed. You can set a value between 2 and 50. The higher the value, the faster the wind speed will be.  
If **Adjust to Zoom** is activated, this has no effect.
- **Fast Wind Factor** allows you to set the winding speed to a multiple for fast winding.  
If you press **Shift** while fast forwarding or rewinding, the wind speed will increase. The increase in speed is a multiple of the **Speed Factor**. Meaning that if you set the **Fast Wind Factor** to 2, the wind speed will be twice as fast. If you set it to 4, the wind speed will be 4 times as fast, etc. You can set a value between 2 and 50.

### Cursor Width

Adjusts the width of the project cursor line.

### Zoom while Locating in Time Scale

Allows you to zoom in or out by clicking in the ruler and dragging down or up.

### Clicking Locator Range in Upper Part of the Ruler Activates Cycle

Allows you to activate/deactivate cycle mode when you click the locator range in the upper part of the ruler.

### Locate when Clicked in Empty Space

Allows you to move the project cursor by clicking in an empty area of the **Project** window.



## Transport - Scrub

### Scrub Volume

Sets the playback volume for the **Scrub** tool in the **Project** window and audio editors.

#### NOTE

This does not affect the scrub volume controlled by any connected hardware.

---

### Use High Quality Scrub Mode

Enables effects for scrubbing and uses a higher resampling quality. However, scrubbing will be more demanding on the processor.

### Use Inserts While Scrubbing

Allows you to activate insert effects for scrubbing with the shuttle speed control. By default, insert effects are bypassed.

## User Interface

This page contains options that allow you to adjust the default user interface colors.

### Color Schemes

Allows you to adjust the color scheme for the application and the desktop cover.

- Click one of the colors in the **Choose Color Scheme** section to apply a pre-defined color.
- Click the field in the **Choose Custom Color** section to open the **Color Picker** and select a custom color.

### Custom Colors

Allows you to set the colors for the **Project** window and the editors, and their specific elements.

### Track & MixConsole Channel Colors

Allows you to set the **Auto Track/Channel Color Mode**, to colorize track controls and **MixConsole** channel controls, and to determine the brightness of selected channels.

### Track Type Default Colors

Allows you to set the colors for the different track types.

### MixConsole Fader Colors

Allows you to set the colors for the level faders of the channel types in the **MixConsole**.

### MixConsole Rack Colors

Allows you to set the colors for the racks in the **MixConsole**.

### MixConsole Channel Strip Colors

Allows you to set the colors for the channel strips in the **MixConsole**.

## Customizing the User Interface Colors

You can change the color of the Cubase desktop, the track types, the **Project** window, the editor elements, and **MixConsole** elements.

---

### PROCEDURE

1. In the **Preferences** dialog, select **User Interface > Color Schemes**.

2. Do one of the following:
    - Activate a default color scheme by clicking on it.
    - Click **Choose Custom Color** and in the **Color Picker**, select a new color.
- 

#### RESULT

The color scheme is instantly applied.

## User Interface - Track & MixConsole Channel Colors

Allows you to set the **Auto Track/Channel Color Mode** to colorize track controls and channel faders, and to determine the brightness of selected channels.

### Auto Track/Channel Color Mode

Allows you to set an automatic color assignment mode for new tracks or new channels.

#### Use Track's Default Color

New tracks get the default event color.

#### Use Previous Track Color

New tracks get the same color as the track above them in the track list.

#### Use Previous Track Color +1

This is similar to **Use Previous Track Color**, except that new tracks get the next color in the color palette.

#### Use Last Applied Color

New tracks get the color that you last applied to an event/part.

#### Use Random Track Color

New tracks get random track colors.

## Colorize Tracks and MixConsole Channels

Applies the track/channel color to track/channel controls.

### Tracks

Enables the application of the track color to the track controls.

### Folder Tracks

Enables the application of the folder track color to the track controls.

### MixConsole Channels

Enables the application of the **MixConsole** channel color to the channel controls.

### Color Strength

Allows you to adjust the intensity of the color.

### Selected Channel Brightness

Allows you to adjust the brightness of the selected **MixConsole** channel.

### Show Color for Selected Channel

Colorizes the selected channel and gives it more color strength instead of displaying it in gray.

## VST

This page contains settings for the VST audio engine.

### Connect Sends Automatically for Each Newly Created Channel

Automatically connects the send routing for existing FX channels when you create a new audio or group channel.

### Instruments use Automation Read All and Write All

If you activate this, the **Read** and **Write** automation status in control panels for VST instruments is affected by **Activate/Deactivate Read for All Tracks** and **Activate/Deactivate Write for All Tracks**.

### Mute Pre-Send when Mute

Mutes pre-fader sends when you mute their channels.

### Default Send Level

Allows you to specify a default level for your send effects.

### Group Channels: Mute Sources as well

Mutes channels that are directly routed to a group channel when you mute the group channel. Channels that were muted prior to the group channel being muted will not remember their mute status and will be unmuted when the group channel is unmuted.

#### NOTE

This does not affect how mute automation is written.

---

### Delay Compensation Threshold (for Recording)

Minimizes the latency effects of the delay compensation while maintaining the sound of the mix as far as possible. Only plug-ins with a delay higher than this threshold setting are affected by the **Constrain Delay Compensation** function. By default, this is set to 0.0 ms, which means that all plug-ins will be affected. If you feel that a little latency is acceptable, you can raise this threshold value.

#### NOTE

Cubase features full delay compensation—any delay inherent in the VST plug-ins you use will automatically be compensated for during playback. However, when you play a VST instrument in real time or record live audio (with monitoring through Cubase activated), this delay compensation may result in added latency.

---

### Do Not Connect Input/Output Busses When Loading External Projects

Prevents connecting input and output busses to the ASIO ports of your system when loading external projects.

### Auto Monitoring

Determines how Cubase handles monitoring. The following options are available:

- **Manual**  
Turns input monitoring on or off when you click **Monitor**.
- **While Record-Enabled**  
Connects the audio source to the channel input when you click **Record Enable**.
- **While Record Running**  
Switches to input monitoring only during recording.
- **Tapemachine Style**

Activates input monitoring in stop mode and during recording, but not during playback.

**NOTE**

The automatic monitoring options apply when you monitor through Cubase, or when you use ASIO Direct Monitoring. If you monitor externally (listen to the input signal from an external mixer, for example), select **Manual** mode and keep all audio **Monitor** buttons turned off in Cubase.

---

**Warn on Processing Overloads**

Shows a warning if the CPU overload indicator on the **Transport** panel lights up during recording.

## VST - Plug-ins

**Warn before Removing Modified Effects**

Shows a warning if you remove an effect plug-in for which you have made parameter changes.

**Open Effect Editor after Loading It**

Opens the effect control panel when you load VST effects or VST instruments.

**Create MIDI Track when Loading VSTi**

Allows you to determine if a MIDI track is created when you add a rack instrument.

- **Always**  
A MIDI track is always created.
- **Do not**  
No MIDI track is created.
- **Always ask to**  
You are asked whether a corresponding MIDI track should be created.

**Synchronize Plug-in Program Selection to Track Selection**

Synchronizes track and plug-in program selection if you route multiple MIDI tracks to multitimbral instruments.

**Suspend VST 3 plug-in processing when no audio signals are received**

Suspends VST plug-in processing in passages where no audio is passing through the plug-in. This can improve system performance noticeably.

**NOTE**

We recommend to leave this option deactivated.

---

**Plug-in Editors “Always on Top”**

Always shows the control panels for effect plug-ins and VST instruments on top of other windows.

## Video

**Extract Audio on Import Video File**

Extracts and saves the audio data of imported video files as a separate audio clip.

**Thumbnail Memory Cache Size**

Allows you to set the size of the thumbnail cache.

# Index

## A

- AAF files [844](#)
- ACID® loops [444](#)
- Activate Project [89](#)
- Activate tempo track [784](#)
- Active Track Version [157](#)
- Adapt to Zoom [64](#)
  - Grid type [69](#)
- ADAT Lightpipe
  - Synchronization [816](#)
- Add Cycle Marker
  - Track Control [98](#)
- Add Latency to MIDI-Thru Processing [903](#)
- Add Marker
  - Track Control [98](#)
- Add Track dialog [102](#)
- Audio tracks [103](#)
  - Folder tracks [125](#)
  - FX channel tracks [120](#)
  - Group channel tracks [117](#)
  - Instrument tracks [107](#)
  - MIDI tracks [114](#)
  - Ruler tracks [123](#)
  - Sampler tracks [111](#)
- Adding chords [733](#)
- Adding group channel tracks to Selected Channels [365](#)
- AES/SPDIF Digital Audio
  - Synchronization [816](#)
- AIFC files
  - Exporting [808](#)
- AIFF files
  - Exporting [808](#)
- Algorithms
  - Limitations [405](#)
  - Time-stretching [403](#)
- All MIDI Inputs [21](#)
- Appearance
  - Colors [905](#)
  - Metering [902](#)
- Archive
  - Prepare [92](#)
- Arranger track
  - Flattening [286](#), [289](#)
  - Inspector [128](#)
  - Track controls [130](#)
- ASIO Direct Monitoring [20](#), [236](#)
- ASIO Latency Compensation
  - Track Control [98](#)
- ASIO Latency Compensation Active by Default [903](#)
- ASIO-Guard [884](#)
- Aspect ratio
  - Video Player window [838](#)
- Assigning chords to Chord Pads [752](#)
- Assigning chords with the Chord Editor [753](#)
- Attribute Filter
  - Applying in the MediaBay [523](#)
  - Context menu search [523](#)
  - MediaBay [522](#)
- Attribute Inspector
  - MediaBay [525](#)
- Attributes [524](#)
  - Defining [528](#)
  - Editing in the MediaBay [525](#)
  - Managing lists [527](#)
  - MediaBay [522](#)
- Audio
  - Handling [169](#)
  - Overlapping [149](#)
  - Rendering [794](#)
  - Zooming [65](#)
- Audio Click
  - Render [226](#)
- Audio clock
  - Synchronization [816](#)
- Audio Connections [24](#)
  - Editing [28](#)
  - Presets [27](#)
- Audio events [168](#)
  - Auditioning [173](#)
- Audio Events
  - Inverting phase [187](#)
- Audio files
  - Previewing in MediaBay [515](#)
- Audio Files
  - Inverting phase [187](#)
- Audio Functions [406](#)
  - Detect Silence [406](#)
  - Spectrum Analyzer [409](#)
  - Statistics [411](#)
- Audio hardware
  - Connections [13](#)
  - Externally clocked [18](#)
- Audio Part Editor
  - Lower zone [55](#)
- Audio parts
  - Auditioning [173](#)
  - Creating [172](#)
- Audio performance
  - Optimizing [882](#)
- Audio Pre-Record Seconds [902](#)

- Audio processing
  - Pool [491](#)
- Audio Processing
  - Direct Offline Processing [386](#)
- Audio Recording [239](#)
  - Downmix [240](#)
  - Pre-Record Time [241](#)
  - Preparations [238](#)
  - RAM Requirements [238](#)
  - Record File Format [237](#)
  - Record Folder [237](#)
  - Record Modes [239](#)
  - Recovering [241](#)
  - Recovering recordings [240](#)
  - Undo [240](#)
  - With Effects [239](#)
- Audio regions [170](#)
- Audio tracks [103](#)
  - Add Track dialog [103](#)
  - Inspector [105](#)
- Audition chords [735](#)
- Audition through MIDI Inserts/Sends [897](#)
- Auditioning
  - Audio events [173](#)
  - Audio parts [173](#)
  - Using key commands [487](#)
- Auto fades
  - Global settings [281](#)
  - Track settings [281](#)
- Auto Monitoring
  - Manual [907](#)
  - Tapemachine Style [907](#)
- Auto Save [91](#), [896](#)
- Auto Save Internal [896](#)
- Auto Select Controllers [637](#)
- Auto Select Events under Cursor [888](#)
- Auto Track/Channel Color Mode [906](#)
- Auto-Scroll [214](#), [215](#)
  - Crossfades [277](#)
  - Suspend [215](#)
- Automatable parameters
  - Controlling with Quick Controls [573](#)
- Automatic Hitpoint Detection
  - Enabling [889](#)
- Automatic scales [736](#)
- Automatic voicings [737](#)
- Automatically generating new audio clips
  - Pool [493](#)
- Automation [535](#)
  - Bézier curves [539](#)
  - Data [536](#)
  - Jump curves [535](#)
  - Merge Modes [544](#)
  - Quick scaling [542](#)
  - Ramp curves [535](#)
  - Read [536](#)
  - Recording actions [535](#)
  - Smooth transitions [539](#)
  - Static value line [536](#)
  - Write [535](#), [536](#)

- Automation data
  - Editing [539](#)
  - Removing [543](#)
  - Selecting [540](#)
- Automation Event Editor
  - Compress Left [540](#)
  - Compress Right [540](#)
  - Move Vertically [540](#)
  - Scale Around Absolute Center [540](#)
  - Scale Around Relative Center [540](#)
  - Scale Vertically [540](#)
  - Stretch [540](#)
  - Tilt Left [540](#)
  - Tilt Right [540](#)
- Automation Follows Events [888](#)
- Automation parameter
  - Track Control [98](#)
- Automation Reduction Level [888](#)
- Automation tracks [543](#)
  - Assigning parameters [543](#)
  - Hiding [543](#)
  - Muting [544](#)
  - Removing [543](#)
  - Showing [543](#)

## B

- Back up Project [92](#)
- Background Color Modulation [894](#)
- Bank assignments [603](#)
- Basic chord types
  - Applying to selected notes [654](#)
- Beat Calculator [789](#), [790](#)
- Bézier curves
  - Automation [539](#)
- Bounce Selection [169](#)
- Broadcast Wave files
  - Exporting [807](#)
- Broadcast Wave Files
  - Embedded information [903](#)
- Buffer
  - Settings [883](#)
- Bulk Dumps [700](#)
- Busses
  - Adding [26](#)
  - Removing [28](#)
- Bypass EQs
  - Track Control [98](#)
- Bypass Inserts
  - Track Control [98](#)
- Bypass Sends
  - Track Control [98](#)

## C

- Change Release Length
  - Note Expression Event Editor [720](#)
- Channel
  - Track Control [98](#)
- Channel Configuration
  - Track Control [98](#)
- Channel latencies
  - MixConsole [348](#)

- Channel names
  - Searching 319
- Channel racks 322, 331
  - EQ 336
  - Filters 334
  - Gain 334
  - Inserts 335
  - Phase 334
  - Pre 333
  - Routing 332
  - Sends 346
  - Strips 339
- Channel settings 349
  - Channel Faders 359
  - Channel Inserts 353
  - Channel Sends 359
  - Channel Strip 354–356
    - Copying 331
    - Equalizer 357
- Channel Settings
  - Toolbar 351
- Channel strip rack 339
  - Compressor 339
  - EQ position 339
  - Gate 339
  - Limiter 339
  - Presets 346
  - Saturation 339
  - Transformer 339
- Channel types
  - MixConsole 320
- Channels
  - Linking 324
- Chase Events 226, 897
- Chord Assistant 734, 751
  - Assigning chords 753
  - Circle of Fifths 751, 752
- Chord Editor 732
  - Assigning chords 753
  - MIDI Input 734
- Chord events 732
  - Adding 733
  - Adding chords 733
  - Auditioning 735
  - Chord type 732
  - Converting to MIDI 740
  - Editing 733
  - Extracting from MIDI 745
  - Mapping offset 737
  - Resolving Display Conflicts 736
  - Tension 732
  - Voicings 737
- Chord Font 894
- Chord Pad Controls 749
- Chord Pads 747, 749–751
  - Adaptive voicing 759
  - Assigning chords 752–754
  - Context menu 750
  - Controls 751
  - Copying Assignments 755
  - Creating chord events 772
  - Creating MIDI parts 772
  - Custom Section Player 763
- Chord Pads (*continued*)
  - Functions menu 750
  - Multiple tracks 762
  - Pad Remote Control 766
  - Pads remote range 769
  - Pattern player 761
  - Player Articulations 763
  - Player Modes 758, 760, 762
  - Player Remote Control 769
  - Player Setup 758
  - Players 759
  - Playing back 756
  - Playing back sections 765
  - Presets 771
  - Recording chords 757, 758
  - Saving presets 772
  - Setting up 751
  - Swapping Assignments 755
  - Voicings 759
  - Zone 751
- Chord Pads Setup
  - Pad layout 771
  - Remote Control 765
- Chord Pads Zone 747
- Chord symbols 894
- Chord track 130, 731
  - Assign Pads 754
  - Controlling MIDI or audio playback 742
  - Inspector 131
  - Live transform 741
  - Track controls 132
- Chord voicing
  - Changing 652
- Chords
  - Changing pitch 652
  - Changing voicing 652
  - Editing 653
  - Inserting 654
- Click Pattern 218
  - Setting up 219
  - Signature events 220
- Click Pattern Editor 219
- Click Sounds
  - Custom Sounds 224
- Click Track
  - Render 226
- Clip editing
  - Pool 487
- Clips
  - Renaming 481
- Color
  - Auto Track/Channel Color Mode 144
- Color Picker 78
- Color Set 76
- Colorize Track Controls 906
- Colorizing
  - Events 73
  - Note events 619
  - Select Color for Selected Tracks or Events 72, 73
  - Single Tracks 73
  - Tracks 72

- Colors
    - MixConsole Channels [348](#)
    - Preferences [905](#)
    - Tracks [73](#), [75](#)
    - User Interface [905](#)
  - Combine Selection Tools [174](#)
    - Object Selection [174](#)
    - Range Selection [174](#)
  - Compress Left
    - Automation Event Editor [540](#)
    - Controller Event Editor [636](#)
    - Tempo Event Editor [786](#)
  - Compress Right
    - Automation Event Editor [540](#)
    - Controller Event Editor [636](#)
    - Tempo Event Editor [786](#)
  - Compressor
    - Strip module [339](#)
  - Connect Sends automatically for each newly created Channel [907](#)
  - Connecting
    - Audio [13](#)
    - MIDI [20](#)
  - Constrain Delay Compensation [558](#)
  - Continuous controllers
    - Adding in controller display [633](#)
    - Controller display [629](#)
    - Controller lane [634](#)
  - Control link [324](#)
  - Controller Brightness [896](#)
  - Controller curves
    - Smart controls for scaling [636](#)
  - Controller Data
    - Thinning Out [616](#)
  - Controller display [625](#)
    - Adding events [631](#), [633](#)
    - Continuous controllers [629](#)
    - Editing events with Line tool [635](#)
    - Moving events [637](#)
  - Controller Event Editor
    - Compress Left [636](#)
    - Compress Right [636](#)
    - Move Vertically [636](#)
    - Scale Around Absolute Center [636](#)
    - Scale Around Relative Center [636](#)
    - Scale Vertically [636](#)
    - Stretch [636](#)
    - Tilt Left [636](#)
    - Tilt Right [636](#)
  - Controller events [706](#)
  - Controller lane
    - Continuous controllers [634](#)
    - Presets [630](#)
    - Selecting event types [629](#)
    - Setting up as preset [630](#)
  - Controller lane setup [626](#)
  - Controller lanes
    - Adding [628](#)
    - Removing [628](#)
  - Controller selection and functions [627](#)
  - Controllers
    - Selecting [637](#)
    - Showing [896](#)
  - Convert to Real Copy [185](#)
  - Converting chord events to MIDI [740](#)
  - Create Audio Images during Record [902](#)
  - Create Chord Symbols [745](#)
  - Create MIDI track when loading VSTi [908](#)
  - Cross-hair cursor [70](#), [892](#)
  - Crossfades
    - Auto Zoom [277](#)
    - Auto-Scroll [277](#)
    - Creating [276](#)
    - Editing in dialog [277](#)
    - Equal Gain [277](#)
    - Equal Power [277](#)
    - Presets [277](#)
    - Simple Crossfade Editor [277](#)
    - Symmetric Fades [277](#)
  - Cursor Width [904](#)
  - Custom Chord Symbols [894](#)
  - Customizing
    - Colors [78](#)
    - Info line [876](#)
    - Inspector [876](#)
    - Meter Colors [328](#)
    - Toolbars [876](#)
    - Transport panel [876](#)
    - User Interface Colors [905](#)
  - Cut Head [182](#)
  - Cut Tail [182](#)
  - Cycle
    - Track Control [98](#)
  - Cycle Follows Range Selection [888](#)
  - Cycle markers [300](#)
    - Editing with tools [301](#)
    - Using [300](#)
    - Zooming [66](#), [301](#)
  - Cycle recording [233](#)
- ## D
- Data on Folder Tracks
    - Showing [895](#)
  - DC Offset
    - Removing [398](#)
  - Default MIDI Editor [893](#)
  - Delay compensation
    - Constraining [558](#)
    - Threshold for Recording [907](#)
  - Delete Notes
    - Dialog [622](#)
  - Delete Overlaps [888](#)
  - Deleting
    - Continuous Controllers [616](#)
    - Controllers [615](#)
    - Doubles [615](#)
    - MIDI controllers [615](#)
  - Deleting Overlaps
    - Poly (MIDI) [614](#)
    - Poly (Mono) [614](#)
  - Deselect
    - Tracks [148](#)
  - Designating a new pool record folder
    - Pool [490](#)



- Detect Silence
  - Audio Functions 406
- Device ports
  - Selecting for busses 26
- Direct Offline Processing 386
  - Applying 389
  - Applying permanently 392
  - Applying to multiple events 390
  - Bypassing 391
  - Copying 392
  - Deleting 390
  - Envelope 393
  - Extend Process Range 390
  - Fade In 393
  - Fade Out 393
  - Gain 394
  - Invert Phase 394
  - Key Commands 401
  - Modifying 390
  - Normalize 395
  - Pitch Shift 395
  - Pool 491
  - Remove DC Offset 398
  - Resample 398
  - Resetting 390
  - Reverse 399
  - Silence 399
  - Stereo Flip 399
  - Time Stretch 399
  - Toolbar 388
  - Window 387
  - Workflow 387
- Disable Acoustic Feedback during Playback 890
- Disable Track 148
- Display format
  - Ruler 42
- Dithering
  - Applying 376
  - Effects 376
- Divider
  - Project window toolbar 38
- Drag Delay 888
- Draw tool
  - Drawing note events 648
- Drum Editor 670
  - Info line 678
  - Lower zone 55
  - Note display 680
  - Status line 678
  - Toolbar 672
- Drum Map
  - Track Control 98
- Drum maps 684, 687
  - Key Editor 654
  - Selecting 681
  - Setting up 685, 686
- Drum sounds 680
  - Changing the Note Length 683
  - Setup 680
  - Visibility 681
- Drum Sounds
  - Settings 686
- Drum Visibility Agents 672, 681
- Dump request messages
  - MIDI SysEx Editor 700
- Duplicating
  - Events 183
  - Tracks 148
- E**
- Edit Channel Settings
  - Track Control 98
- Edit History dialog 71
- Edit In-Place
  - Track Control 98
- Edit Instrument
  - Track Control 98
- Editing
  - Project window info line 44
- Editor Content Follows Event Selection 893
- Effect parameters
  - Track Quick Controls 571
- Effect Plug-in Presets
  - Loading in MediaBay 530
- Effects 361
  - Comparing settings 378
  - Control panel 376
  - Copying presets 381
  - Direct Offline Processing 386
  - Dithering 376
  - Exporting system component information files 385
  - Extracting insert effect settings from track presets 383
  - Insert effects 361, 363
  - Managing system components 384
  - Pasting presets 381
  - Plug-in delay compensation 363
  - Pre/Post fader sends 372
  - Presets 379
  - Presets browser 379
  - Routing 371
  - Saving insert presets 382
  - Saving presets 380
  - Selecting presets 380
  - Send effects 361, 369
  - Side-chain inputs 373, 375
  - System Component Information window 383
  - Tempo sync 363
  - VST 3 362
- élastique algorithm 403
- Enable Record on Selected Audio Track 892
- Enable Record on Selected MIDI Track 892
- Enable Solo on Selected Track 892
- Enable Track 148
- Enharmonic shift 668
- Enlarge Selected Track 146, 892
- Envelope
  - Direct Offline Processing 393
  - Realtime processing 281
- Envelope editor
  - Sampler Control 470
- EQ
  - Channel racks 336
  - Presets 339

- EQ position
    - Strip module 339
  - Equal Gain
    - Crossfades 277
  - Equal Power
    - Crossfades 277
  - Equalizer settings 358
  - Event Details
    - Showing 895
  - Event display 40
    - Editing events 699
    - Folder tracks 150
    - Modifying on folder tracks 150
  - Event Handling Opacity 893
  - Event lengths
    - Changing with Trim tool 651
  - Event list
    - Editing events 699
    - Filtering events 699
  - Event name
    - Showing 893
  - Event Opacity 893
  - Event Volume Curves
    - Showing 894
  - Events 168
    - Arranging at a Specific Distance 178
    - Combine Selection Tools 174
    - Copying and Pasting 183
    - Creating new files from events 169
    - Displaying on folder tracks 150
    - Duplicating 183
    - Editing 173
    - Envelopes 281
    - Gluing 182
    - Grouping 186
    - Locking 186, 187
    - Move to 177
    - Moving 176, 178
    - Moving via Info Line 178
    - Moving with Nudge 177
    - Moving with Object Selection 177
    - Muting 187
    - Normal resizing 174, 179
    - Pasting 183
    - Removing 176
    - Renaming 178
    - Repeating 184
    - Resizing 179
    - Resizing with Object Selection 174, 179, 180
    - Resizing with Scrub 181
    - Resizing with Trim 180
    - Setting a spacer between events 178
    - Sizing Applies Time Stretch 180
    - Sizing Moves Contents 179
    - Sliding the contents 185
    - Splitting 181
    - Splitting repeatedly 182
  - Export Audio Mixdown 800, 805
    - AIFC files 808
    - AIFF files 808
    - Broadcast Wave files 807
    - Defining Naming Schemes 805
    - File Formats 806
    - Export Audio Mixdown (*continued*)
      - Flac files 811
      - MP3 files 809
      - Naming Scheme dialog 804
      - Ogg Vorbis files 812
      - Wave 64 files 812
      - Wave files 807
      - Windows Media Audio files 809
  - Export Video 840
  - Export Video dialog 840
  - Exporting
    - AAF 844
    - MIDI files 141
    - Video files 842
  - External monitoring 235
  - Extract Audio on Import Video File 908
  - Extracting
    - Audio from video 257, 843
    - MIDI Automation 616
  - Extracting chord events from MIDI 745
- ## F
- Fade Handle Brightness 894
  - Fade In
    - Direct Offline Processing 393
  - Fade In dialog 274
  - Fade Out
    - Direct Offline Processing 393
  - Fade Out dialog 274
  - Fader section (MixConsole) 326
  - Fades
    - Auto fades 279
    - Editing in dialog 274
    - Presets 274
    - With Range Selection tool 273
  - Favorites
    - Adding 503, 509
    - Media rack 501
  - File Browser
    - Media rack 501
  - File Extensions
    - Showing in Results list 901
  - Fill Loop 185
  - Find Tracks 41
  - Fixed lengths 613
  - Fixed tempo
    - Mode 782
  - Fixed Tempo
    - Mode 788
    - Setting up 788
  - Fixed velocity 613
  - Flac files
    - Exporting 811
  - FLAC files
    - Importing 254
  - Flattening
    - Arranger track 286, 289
    - Realtime Processing 450
  - Folder parts 172
  - Folder tracks 125
    - Add Track dialog 125
    - Displaying events 150

- Folder tracks (*continued*)
    - Inspector [127](#)
    - Modifying event display [150](#)
    - Track controls [127](#)
  - Follow Chord Track [742](#)
    - Auto [742](#)
    - Chords [742](#)
    - Directly [743](#)
    - Scale events [743](#)
    - Single Voice [742](#)
    - Synchronizing Track Data [743](#)
    - Using [742](#)
  - Frame count [815](#)
  - Frame rates
    - Mismatch [836](#)
    - Synchronization [815](#)
    - Video [836](#)
  - Freeze
    - VST instruments [556](#)
  - Freeze Channel
    - Track Control [98](#)
  - Freeze MIDI Modifiers [597](#)
  - FX chain presets [336](#)
  - FX Chain Presets
    - Loading in MediaBay [530](#)
  - FX channel tracks [120](#)
    - Add Track dialog [120](#)
    - Adding [370](#)
    - Inspector [122](#)
  - FX Plug-in Presets
    - Loading in MediaBay [530](#)
- ## G
- Gain
    - Direct Offline Processing [394](#)
  - Gate
    - Strip module [339](#)
  - Generate Harmony Voices [450](#)
  - Generic Remote [580](#)
  - Global track controls [40](#)
    - Find Tracks [41](#)
    - Track Type Filter [41](#)
  - Global workspaces [873](#)
  - Gluing
    - Events [182](#)
  - Grid Overlay Intensity [893](#)
  - Grid type
    - Project window [69](#)
  - Groove quantizing [266](#)
  - Group channel tracks [117](#)
    - Add Track dialog [117](#)
    - Inspector [119](#)
  - Group channels
    - Adding insert effects [365](#)
    - Routing [333](#)
  - Group Channels - Mute Sources as well [907](#)
  - Grouping events [186](#)
- ## H
- Hardware controls
    - Activating pick-up mode [575](#)
  - Hardware setup
    - Control panel [14](#)
  - Hermod tuning [596](#)
  - Hide muted Notes in Editors [890](#)
  - Hide Truncated Event Names [893](#)
  - High Quality Scrub Mode [905](#)
  - History
    - Edit History [71](#)
    - MixConsole [314](#), [319](#)
    - Project window [32](#)
  - Hitpoints [434](#)
    - Showing [894](#)
  - HMT Type
    - Hermod tuning [597](#)
  - Horizontal Snap
    - Note Expression Event Editor [720](#)
  - Horizontal zoom
    - Sample Editor [424](#)
  - Hub [80](#)
    - Deactivating [82](#)
    - Using [896](#)
- ## I
- I-notes (Input notes) [688](#)
  - Importing
    - AAF [844](#)
    - Audio files [253](#)
    - Audio from video files [257](#)
    - Compressed audio files [253](#)
    - FLAC files [254](#)
    - MIDI files [141](#), [258](#)
    - MP3 files [254](#)
    - MPEG files [254](#)
    - Ogg Vorbis files [254](#)
    - REX files [257](#)
    - Video files [835](#)
    - WMA files [254](#)
  - In-Place Editor
    - Editing controllers [703](#)
    - Editing MIDI notes [703](#)
    - Toolbar [703](#)
  - Independent track loop
    - Audio Part Editor [460](#)
  - Independent Track Loop
    - MIDI [624](#)
  - Indicate Transpositions
    - Key Editor [297](#)
  - Info line
    - Project window [43](#)
    - Score Editor [661](#)
    - Transpose [298](#)
  - Input busses
    - Adding [26](#)
    - Removing [28](#)
    - Renaming [25](#)
    - Routing [332](#)
  - Input gain
    - MixConsole [334](#)
  - Input levels [13](#)
  - Input ports [19](#)
  - Inputs
    - Meter position options [328](#)

- Insert effects [361](#), [363](#)
  - Adding to busses [364](#)
  - Adding to Group channels [365](#)
  - Routing [364](#)
- Insert MIDI Retrospective Recording in Editor [249](#)
- Insert Reset Events after Record [897](#)
- Inserts
  - FX chain presets [336](#)
  - MIDI [598](#)
  - MixConsole [335](#)
  - Using while scrubbing [905](#)
- Inspector [45](#)
  - Editor [47](#)
  - Sections [95](#)
  - Synchronizing track and channel visibility [51](#)
  - Track Inspector [46](#)
  - Visibility [49](#), [50](#)
  - Zones [51](#)
- Inspector Sections
  - Showing/Hiding [48](#)
- Instrument
  - Track Control [98](#)
- Instrument Freeze [556](#)
- Instrument parameters
  - Track Quick Controls [572](#)
- Instrument Presets
  - Applying [163](#)
  - Loading in MediaBay [529](#)
  - Results [555](#)
- Instrument tracks [106](#)
  - Add Track dialog [107](#)
  - Inspector [108](#)
- Instruments use Automation Read All and Write All [907](#)
- Interpolate Audio Waveforms [894](#)
- Invert Phase
  - Direct Offline Processing [394](#)
  - Info Line [187](#)
  - MixConsole [334](#)
- K**
- Key commands [854](#)
  - Default [860](#)
  - Dialog [854](#)
  - Importing [859](#)
  - Loading [859](#)
  - Macros [856](#)
  - Modifying [857](#)
  - Removing [858](#)
  - Resetting [859](#)
  - Saving [859](#)
  - Searching for [857](#)
- Key Editor [638](#)
  - Info line [646](#)
  - Inspector [647](#)
  - Lower zone [55](#)
  - Note display [648](#)
  - Status line [646](#)
  - Toolbar [640](#)
- Keyboard focus
  - Activating for a zone [63](#)
  - Zones [63](#)
- Keyboard navigation
  - MixConsole [360](#)
- Knob Mode [890](#)
- L**
- Lanes [151](#)
  - Assembling a perfect take [152](#)
  - Assembling operations [152](#)
  - Audio Part Editor [458](#)
- Language (Preferences) [896](#)
- Latch Buffer
  - Note expression [720](#)
- Latency
  - MixConsole [348](#)
  - Optimizing [882](#)
  - VST System Link [826](#)
- Left locator
  - Setting [213](#)
- Left Locator [211](#)
- Left zone [45](#)
  - Inspector [45](#)
  - MixConsole [312](#)
  - Visibility [49](#), [50](#)
  - Zones [51](#)
- Legato [612](#)
- Legato Mode - Between Selected Notes Only [891](#)
- Legato Overlap [891](#)
- Length Adjustment [897](#)
- Level meters (MixConsole) [329](#)
- Limiter
  - Strip module [339](#)
- Line tool [650](#)
  - Drawing note events [649](#)
  - Editing controller display events [635](#)
- Linear Time Base [782](#)
- Link groups [324](#)
  - Q-Link [324](#)
- Link Project and Lower Zone Cursors [57](#)
- List Editor [689](#)
  - Editing events [699](#)
  - Editing operations [698](#)
  - Event display [696](#)
  - Event list [695](#)
  - Filters bar [695](#)
  - Inserting events [698](#)
  - Showing/Hiding events [695](#)
  - Status line [694](#)
  - Toolbar [690](#)
  - Value display [697](#)
- Live transform
  - Chord track [741](#)
- Loading Multi-Track Presets [165](#)
- Locate
  - Track Control [98](#)
- Locate When Clicked in Empty Space [904](#)
- Locator Range Duration [213](#)
- Locators [211](#)
  - Setting ranges [213](#)
- Lock
  - Track Control [98](#)
  - Transpose track [296](#)

- Lock Automation
    - Track Control [98](#)
  - Lock Event Attributes [187](#)
  - Lock Punch Points to Locators [217](#)
  - Lock Record [250](#)
  - Logical Editor [773](#)
    - Actions [779](#)
    - Functions [779](#)
  - Logical Filter
    - Advanced Text Search [521](#)
    - Applying [521](#)
    - MediaBay [520](#)
  - Logical Presets [781](#)
  - Looping
    - Audio Part Editor [460](#)
  - Loops and Samples
    - Loading in MediaBay [528](#)
  - Loudness
    - Statistics [411](#)
  - Lower zone [52](#)
    - Chord Pads [53](#)
    - Editor [55](#)
    - Link Project and Lower Zone Cursors [57](#)
    - MixConsole [54](#)
    - Sampler Control [55](#)
    - Selecting a MIDI editor [56](#)
    - Setting up [53](#)
- ## M
- macOS
    - Port activation [26](#)
    - Port selection [26](#)
  - Macros [858](#)
    - Key commands [856](#)
  - Main mix
    - Setting up [26](#)
  - Managing media files
    - Pool [476](#)
  - Map Input Bus Metering to Audio Track [901](#)
  - Mapping offset [737](#)
  - Marker track [133](#), [304](#)
    - Inspector [133](#)
    - Track controls [133](#)
  - Marker window [301](#)
    - Functions [302](#)
    - Marker list [302](#)
  - Markers [300](#)
    - Attributes [303](#)
    - Cycle markers [300](#)
    - Exporting [306](#)
    - Exporting via MIDI [306](#)
    - IDs [304](#)
    - Importing [306](#)
    - Importing via MIDI [306](#)
    - Position markers [300](#)
    - Settings [302](#)
  - Max. Record Time Display [250](#)
  - Maximum Backup Files [896](#)
  - Maximum Items in Results List [901](#)
  - Maximum Undo Steps [896](#)
  - Media rack
    - Adding Favorites [503](#)
    - Adding VST plug-in pictures [503](#), [504](#)
    - Favorites [496](#), [501](#)
    - File Browser [497](#), [501](#)
    - Home [494](#)
    - Results [496](#)
    - Right zone [61](#), [62](#)
    - Right Zone [494](#), [496](#)
    - Track Presets [502](#)
    - VST Effects [499](#), [502](#)
    - VST Instruments [498](#), [501](#)
  - MediaBay [494](#)
    - Adding Favorites [509](#)
    - Allow Editing in Results List [526](#)
    - Attribute Filter [522](#), [523](#)
    - Attribute Inspector [524](#), [525](#)
    - Attributes [522](#)
    - Defining user attributes [528](#)
    - Editing attributes [525](#)
    - Editing attributes of multiple files [526](#)
    - File Browser [508](#)
    - Filters [520](#), [522](#)
    - Finding file locations [511](#)
    - Hiding sections [508](#)
    - Instrument Presets [555](#)
    - Logical Filter [520](#), [521](#)
    - Media Type Filter [511](#)
    - Media Types [512](#)
    - Previewer [515](#)
    - Rating filter [513](#)
    - Refresh Views [509](#)
    - Reset Filter [523](#)
    - Results [510](#), [511](#), [515](#)
    - Scanning [508](#)
    - Select Media Type [511](#)
    - Settings [534](#)
    - Show in Explorer/Reveal in Finder [511](#)
    - Showing sections [508](#)
    - Shuffle Results [511](#)
    - Tagging [525](#)
    - Text search [513](#), [514](#)
    - Toolbar [506](#)
    - Using Media Files [528](#)
    - Volume databases [531](#)–[533](#)
    - Window [504](#)
    - Write-protected files [526](#)
  - MediaBay results
    - Managing media files [511](#)
    - Resetting [515](#)
    - Setting up [510](#)
    - Shuffling [511](#)
  - Merge MIDI in Loop [609](#), [610](#)
  - Metadata
    - Author Name [897](#)
    - Company Name [897](#)
  - Meter Colors [328](#)
  - Meter peak options [328](#)
    - Hold forever [328](#)
    - Hold peaks [328](#)

- Meter position options 328
  - Input 328
  - Post-Fader 328
  - Post-Panner 328
- Meters
  - Settings 328
- Meters' Fallback 901
- Meters' Peak Hold Time 901
- Metronome 217, 222, 223, 225
  - Click Pattern Editor 219, 220
  - Setup window 220
- Metronome Click
  - Setting up 219
- Metronome Setup 220
  - Click Pattern 218
  - Click Patterns 225
  - Click Sounds 223
  - General 222
- MIDI
  - Delete notes 622
- MIDI channels
  - Send effects 599
  - Separating for drum map sounds 687
- MIDI Click
  - Render 226
- MIDI clock
  - Synchronization 816
- MIDI Controller Automation 544
  - Setting up 545
- MIDI controllers
  - Note Expression 707
- MIDI devices
  - Defining new for patch selection 607
  - Device Manager 603
  - Editing patches 607
  - Installing 606
  - Selecting patches 606
- MIDI Display Resolution 897
- MIDI editors
  - Cutting and pasting 619
- MIDI effects 598
  - Inserts 598
  - Presets 601
  - Sends 599
- MIDI events 171
- MIDI Export Options 899
- MIDI files 141, 258
  - Previewing in MediaBay 516
- MIDI Filter 901
- MIDI Import Options 899, 900
- MIDI Input
  - Chord Editor 734
- MIDI Inputs
  - Setting up 242
- MIDI insert effects
  - Recording 599
- MIDI interface
  - Connecting 20
- MIDI Latency Mode 897
- MIDI Loops
  - Previewing in MediaBay 517
- MIDI Max. Feedback in ms 897
- MIDI Merge Options 610
- MIDI modifiers 593
  - Hermod tuning 596, 597
  - Random variations 595
  - Range 595
- MIDI note numbers 686
- MIDI notes
  - Transpose (function) 608
- MIDI outputs
  - Send effects 599
- MIDI pan
  - MIDI track parameters 591
- MIDI part data
  - Automation 536
- MIDI parts
  - Creating 172
  - Handling several 624
  - Independent Track Loop 624
  - Processing 618
- MIDI Polyphonic Expression 708
- MIDI Port Setup 242
- MIDI ports
  - Setting up 20
- MIDI Record Catch Range in ms 903
- MIDI Record Mode 246
- MIDI Recording
  - Channel and Output 243
  - Continuous messages 245
  - Different types of messages 244
  - Instruments and channels 242
  - MIDI Input setting 242
  - Naming MIDI ports 242
  - Notes 245
  - Preparations 242
  - Program Change Messages 245
  - Record mode 246
  - Recovering 248
  - Recovering in Editor 249
  - Recovering recordings 247
  - Reset 245
  - Sound selection 243
  - System Exclusive Messages 245
- MIDI recordings
  - Exporting to MIDI file 689
- MIDI Retrospective Recording 247
- MIDI SysEx Editor
  - Dump request messages 700
- MIDI Thru Active 897
  - Monitoring 236
- MIDI track delay
  - MIDI track parameters 591
- MIDI track parameters 591
- MIDI tracks 113
  - Add Track dialog 114
  - Freezing MIDI Modifiers 597
  - Inspector 115
  - Routing to device 701
- MIDI Velocity
  - Editing 614
- MIDI volume
  - MIDI track parameters 591
- Mirror
  - MIDI 617

- Missing ports
    - Re-routing [90](#)
  - MixConsole [307](#)
    - Channel linking [324](#)
    - Channel racks [322](#)
    - Channel types [320](#)
    - EQ presets [339](#)
    - Fader section [326](#)
    - FX chain presets [336](#)
    - History [314](#)
    - Left zone [312](#)
    - Left Zone [313](#), [314](#)
    - Level meters [329](#)
    - Lower zone [54](#)
    - Mute [327](#)
    - Notepads [348](#)
    - Opening [307](#)
    - Panning [327](#)
    - Pre rack [333](#)
    - Racks [331](#)
    - Setting volume [328](#)
    - Solo [327](#)
    - Solo Defeat [327](#)
    - Strip presets [346](#)
    - Toolbar [314](#)
    - Undoing parameter changes [314](#), [319](#)
    - Visibility [313](#)
    - Visibility agents [321](#)
    - Zones [314](#)
  - MixConsole in Project Window [54](#)
  - Mixing down to audio files [805](#)
  - Modifier keys [872](#)
  - Monitor
    - Track Control [98](#)
  - Monitoring [20](#), [235](#)
    - ASIO Direct Monitoring [236](#)
    - External [235](#)
    - MIDI [236](#)
    - Via Cubase [235](#)
  - Mouse Wheel for Event Volume and Fades [889](#)
  - Move Vertically
    - Automation Event Editor [540](#)
    - Controller Event Editor [636](#)
    - Tempo Event Editor [786](#)
  - Moving
    - Events [176](#)
  - Moving tracks [143](#)
  - MP3 files
    - Exporting [809](#)
    - Importing [254](#)
  - MPE [708](#)
  - MPEG files
    - Importing [254](#)
  - MPEX algorithm [403](#)
    - Pitch Shift [395](#)
  - Multi processing [883](#)
  - Musical Mode [444](#)
  - Musical Time Base [782](#)
  - Musical track time base [154](#)
  - Mute
    - MixConsole [327](#)
    - Track Control [98](#)
    - Transpose track [296](#)
  - Mute Automation
    - Track Control [98](#)
  - Mute Pre-Send when Mute [907](#)
  - Muting events [187](#)
- ## N
- Name
    - Track Control [98](#)
  - Navigating
    - MixConsole [360](#)
  - Never Reset Chased Controllers [897](#)
  - Normalize
    - Direct Offline Processing [395](#)
    - Maximum peak level [395](#)
  - Note Brightness [896](#)
  - Note display
    - Drum Editor [680](#)
    - Enharmonic Shift [668](#)
    - Key Editor [648](#)
  - Note events
    - Colorizing [619](#)
    - Creating in Score Editor [666](#)
    - Deleting [622](#)
    - Drawing with Draw tool [648](#)
    - Drawing with Line tool [649](#)
    - Duplicating [623](#), [667](#)
    - Editing [623](#)
    - Editing via MIDI [655](#)
    - Excluding from playback [621](#)
    - Gluing [652](#), [667](#)
    - Moving [650](#)
    - Muting [621](#)
    - Repeating [623](#)
    - Resizing [651](#)
    - Selecting [620](#)
    - Setting values [666](#)
    - Setting velocity values [623](#)
    - Setting with Snap [623](#)
    - Splitting [651](#), [667](#)
    - Transposing [650](#)
    - Trimming [622](#)
  - Note Expression [706](#)
    - Adding events [723](#)
    - Adding release phases [725](#)
    - Converting events [728](#)
    - Deleting events [723](#)
    - Expression filter [714](#)
    - Expression section [713](#)
    - Expression settings [715](#)
    - Global settings [715](#)
    - HALion Sonic SE [707](#)
    - Inspector section [712](#)
    - Latch Buffer [720](#)
    - Mapping [716](#), [717](#)
    - Mapping controllers [716](#)
    - Mapping presets [717](#)
    - MIDI controllers [707](#)
    - MIDI learn [717](#)
    - Moving events [725](#)
    - Overdubbing [719](#), [720](#)
    - Overlaps [729](#)
    - Pasting events [723](#)

- Note Expression (*continued*)
  - Pasting events to different parameters 724
  - Recording 717, 718
  - Recording by overdubbing 719
  - Recording via MIDI Input 720
  - Removing events 726
  - Repeating events 724
  - Sustain pedal 718
  - Tools 715
  - Trimming events 728
  - Trimming to note length 726
  - VST note expressions 707
- Note Expression Event Editor
  - Change Editor Size 720
  - Change Release Length 720
  - Compress Left 720
  - Compress Right 720
  - Horizontal Snap 720
  - Move Vertically 720
  - One-Shot Mode 720
  - Parameter Range 720
  - Parameter Selection 720
  - Scale Around Absolute Center 720
  - Scale Around Relative Center 720
  - Scale Vertically 720
  - Stretch 720
  - Tilt Left 720
  - Tilt Right 720
  - Vertical Snap 720
- Note Expression MIDI Input 715
- Note Expression MIDI Setup 726
- Note lengths
  - Changing 667
- Note stems
  - Flipping the direction 668
- Note values
  - Setting 666
- Notepads
  - MixConsole 348
- O**
- O-notes (Output notes) 688
- Object Selection
  - Combine Selection Tools 174
- Offline Processing
  - Applying permanently 392
- Ogg Vorbis files
  - Exporting 812
  - Importing 254
- On Import Audio Files 889
- On Processing Shared Clips 889
- On-Screen Keyboard 228
  - Computer keyboard 229
  - Modulation 229
  - Note velocity level 229
  - Octave offset 229
  - Options 229
  - Piano keyboard 229
  - Pitchbend 229
  - Recording MIDI 228
- One-Shot Mode
  - Note Expression Event Editor 720
- Open Effect Editor after Loading it 908
- Open External Projects in Last Used View 896
- Open/Close Sampler
  - Track Control 98
- Organizing files in subfolders
  - Pool 491
- Output
  - Track Control 98
- Output busses
  - Adding 26
  - Default 26
  - Removing 28
  - Renaming 25
  - Routing 333
- Output ports 19
- Overlapping Audio 149
- Overlaps
  - Showing 893
- Overview line
  - Project window 44
- P**
- Panning
  - Bypass 327
  - MixConsole 327
  - Using a joystick 590
- Parameter Range
  - Note Expression Event Editor 720
- Parameter Selection
  - Note Expression Event Editor 720
- Part Data Mode 896
- Parts 168, 172
  - Editing 173
  - Folder 172
  - Sliding the contents 185
- Parts Get Track Names 888
- Paste at Origin 183
- Paste Relative to Cursor 183
- Patch Banks 603
- Pattern
  - Chord Pads 758
- Pattern Banks
  - Loading in MediaBay 531
  - Previewing in MediaBay 519
- Pedals
  - To note length 614
- Performance
  - Aspects 882
  - Audio performance 883
  - Optimizing 882
- Phase
  - MixConsole 334
- Piano voicings 737
- Pick-up Mode 575
- Pitch
  - Changing for chords 652
- Pitch Notation 894
- Pitch Shift
  - Algorithm 403
  - Direct Offline Processing 395
  - Limitations 405



- Plain Chords
  - Chord Pads [758](#)
- Playback
  - Disable Acoustic Feedback [890](#)
  - Excluding note events [621](#)
- Playback Toggle triggers Local Preview [401, 904](#)
- Player Modes
  - Pattern [760](#)
  - Plain Chords [760](#)
  - Sections [762](#)
- Plug-in delay compensation [363](#)
- Plug-in Editors Always on Top [908](#)
- Plug-in latency
  - MixConsole [348](#)
- Plug-in processing
  - Suspending [362](#)
- Poly Pressure events
  - Adding [632](#)
  - Editing [633](#)
- Polyphony
  - Restricting [616](#)
- Pool
  - Applying different processing methods [481](#)
  - Audio processing [491](#)
  - Automatically generating new audio clips [493](#)
  - Clip editing [487](#)
  - Designating a new pool record folder [490](#)
  - Key commands [487](#)
  - Managing large sound databases [485](#)
  - Managing media files [476](#)
  - Organizing files in subfolders [491](#)
  - Reducing the project size [492](#)
  - Reference file [476](#)
  - Renaming clips and regions [481](#)
  - Resolve missing files dialog [486](#)
  - Sampler tracks [476](#)
  - Toolbar [479](#)
- Position markers [300](#)
- Post fader sends [372](#)
- Post-roll
  - Recording [233](#)
  - Transport panel [216](#)
- Pre fader sends [372](#)
- Pre-Record time
  - Audio recording [241](#)
- Pre-roll
  - Recording [233](#)
  - Transport panel [216](#)
- Preferences
  - Colors [905](#)
  - Dialog [886](#)
  - Disabling [880, 881](#)
  - Saving presets [887](#)
  - Store marked preferences only [887](#)
- Presets
  - Previewing in MediaBay [518, 519](#)
  - Previewing using a MIDI file [518](#)
  - Previewing using the Memo Recorder [518](#)
  - Previewing via MIDI Input [518](#)
  - Previewing via the Computer Keyboard [519](#)
- Presets browser
  - Effects [379](#)
- Primary Time Format
  - Selecting [215](#)
- Programs
  - Track Control [98](#)
- Project Assistant [82](#)
- Project Colors Setup
  - Color Set [76](#)
  - Options [77](#)
  - Presets [77](#)
- Project Colors Setup Dialog [75–77](#)
- Project Root Key [292](#)
  - Assigning to a Project [293](#)
  - Assigning to Parts or Events [293](#)
  - Changing [294, 295](#)
  - Recording with [294](#)
- Project Setup Dialog [86](#)
- Project Synchronization Setup [817](#)
  - Destinations [821](#)
  - Sources [818](#)
- Project window
  - Event display [40](#)
  - Global track controls [40](#)
  - History [32](#)
  - Info line [43](#)
  - Inspector [45](#)
  - Keyboard focus [63](#)
  - Left zone [45](#)
  - Lower zone [52–55](#)
  - Overview [30](#)
  - Overview line [44](#)
  - Project zone [31](#)
  - Right zone [58](#)
  - Ruler [42](#)
  - Showing/Hiding Zones [31](#)
  - Snap [67](#)
  - Snap to zero crossing [68](#)
  - Status line [43](#)
  - Toolbar [32](#)
  - Toolbox [38](#)
  - Track list [39](#)
  - Transport Bar [44, 204](#)
  - Transport pop-up window [209](#)
  - Visibility [49, 50](#)
  - Zones [51](#)
  - Zoom presets [66](#)
  - Zoom submenu [65](#)
  - Zooming [64](#)
- Project workspaces [873](#)
- Project zone [31](#)
  - Event display [40](#)
  - Global track controls [40](#)
  - Ruler [42](#)
  - Toolbar [32](#)
  - Track list [39](#)
- Projects
  - Activating [89](#)
  - Back up [92](#)
  - Creating new [80, 82](#)
  - Hub [80](#)
  - Location [91](#)
  - Missing ports [90](#)
  - Opening [89](#)
  - Opening recent [90](#)

- Projects (*continued*)
    - Prepare archive 92
    - Project Assistant 82
    - Project files 83
    - Revert 91
    - Saving 90
    - Saving templates 85
    - Setting up 86
    - Template files 83
    - Templates 83
  - Punch In 217, 233
    - On Stop 902
  - Punch In/Out
    - Common Record Modes 234
  - Punch Out 217, 232, 233
    - Stop after automatic 902
  - Punch Points 217
- ## Q
- Q-Link 324
  - QC Learn Mode
    - Track Quick Controls 571
  - Quantize Panel 264
    - Quantizing to a grid 266
    - Quantizing to a groove 268
  - Quantize value 666
  - Quantizing 261
    - Catch Range 266
    - MIDI event starts 362
    - Original position 268
    - Pre-Quantize 268
    - Swing 266
    - Tuplets 266
    - Using groove presets 266
  - Quick Zoom 888
- ## R
- Rack settings 323
    - Copying 331
  - Racks
    - MixConsole 331
  - RAM
    - Recording 238
  - Range Editing 189
  - Range Selection
    - Combine Selection Tools 174
  - Range Selection tool 189
    - Creating fades 273
  - Re-Record
    - Activating 234
    - Common Record Modes 234
  - Read automation 536
  - Read Automation
    - Track Control 98
  - Recent projects 90
  - Record Enable
    - Track Control 98
  - Record File Format
    - Audio 237
  - Record Folder
    - Audio 237
  - Record-Enable allows MIDI Thru 903
  - Recording 230
    - Common Record Modes 234
    - Cycle 233
    - Levels 13
    - Lock Record 250
    - Notes and Note Expression 718
    - Pre-roll and post-roll 233
    - Remaining Record Time 250
    - Stopping 232, 233
    - Stopping automatically 232
    - With Effects 239
  - Recovering recordings
    - Audio 240
    - MIDI 247
  - ReCycle files 257
  - Reducing the project size
    - Pool 492
  - Reference file
    - Pool 476
  - Refresh Views
    - MediaBay 509
  - Regions
    - Creating with Detect Silence 409
    - Event or Range as Region 170
    - Events from Regions 171
    - Renaming 481
  - Remote control 576
    - Assigning commands 579
    - Automation 579
    - Connections 576
    - Control Assignment 583
    - Generic Remote 580
    - Global Options 578
    - Joysticks 590
    - MIDI Port Setup 576
    - MIDI remote control configuration 581
    - Remote Control Editor 585
    - Resetting 578
    - Setting up 577
  - Remote Control Editor 585
    - Control settings 587
    - Layout 589
    - Parameter assignment 589
    - Toolbar 587
  - Remote Controllers
    - Connecting Track Quick Controls 574
    - Connecting VST Quick Controls 560
  - Remove DC Offset
    - Direct Offline Processing 398
  - Remove Empty Tracks 143
  - Remove Regions/Hitpoints on all Offline Processes 889
  - Remove Selected Tracks 143
  - Removing
    - Events 176
    - Silence 409
  - Renaming
    - Clips 481
    - Events 178
    - Regions 481
    - Tracks 144
  - Render Audio Click between Locators 226
  - Render MIDI Click between Locators 226

- Rendering Audio [794](#)
- Rendering Selections [797](#)
- Rendering Tracks [794](#), [797](#)
- Repeat Events [184](#)
- Repeat Loop [612](#)
- Replace Recording in Editors [903](#)
- Resample
  - Direct Offline Processing [398](#)
- Reset on Stop [897](#)
- Resizing events [179](#)
- Resolve Display Conflicts
  - Track Control [98](#)
- Retrospective MIDI Recording [248](#), [249](#)
  - Empty Buffer [250](#)
  - Insert from All MIDI Inputs [248](#)
- Retrospective Record [903](#)
- Retrospective Record Buffer [247](#)
- Retrospective Recording
  - Buffer [247](#)
  - MIDI [247](#)
- Return to Start Position on Stop [904](#)
- Reverse
  - Audio [399](#)
  - Direct Offline Processing [399](#)
  - MIDI [617](#)
- ReWire [849](#)
  - Activating channels [851](#)
  - Channels [852](#)
  - Enabling applications [849](#)
  - Routing MIDI [852](#)
  - Setup [849](#)
- REX files [257](#)
- Right locator
  - Setting [213](#)
- Right Locator [211](#)
- Right zone [58](#)
  - Media rack [61](#), [62](#), [494](#), [497–499](#)
  - VSTi rack [59](#), [60](#)
- Root Key
  - Sampler Control [473](#)
- Routing
  - Group channels [333](#)
  - Input busses [332](#)
  - MixConsole [332](#)
  - Output busses [333](#)
  - Through insert effects [364](#)
- Ruler
  - Display format [42](#)
  - Project window [42](#)
  - Timeline [618](#)
- Ruler track [123](#)
  - Track controls [124](#)
- Ruler tracks
  - Add Track dialog [123](#)
- Run Setup on Create New Project [896](#)
- S**
- Safe Mode
  - Dialog [879](#)
- Sample editing
  - Sampler Control [473](#)
- Sample Editor [413](#), [423](#), [424](#)
  - Generate Harmony Voices [450](#)
  - Info Line [419](#)
  - Inspector [420](#)
  - Lower zone [55](#)
  - Overview Line [419](#)
  - Regions [429](#)
  - Ruler [422](#)
  - Showing multiple waveforms [423](#)
  - Snap [431](#)
  - Toolbar [415](#)
  - Undo zoom operations [424](#)
- Sample rate
  - Externally clocked [18](#)
- Sampler Control [464](#)
  - Amp section [470](#)
  - AudioWarp section [468](#)
  - Envelope editor [470](#)
  - Filter section [469](#)
  - Keyboard section [472](#)
  - Lower zone [55](#)
  - Pitch section [469](#)
  - Playing back samples [474](#)
  - Root Key [473](#)
  - Sample editing [473](#)
  - Sound parameter section [468](#)
  - Toolbar [464](#)
  - Transferring samples to VST instruments [475](#)
  - Waveform display [467](#)
- Sampler tracks [110](#)
  - Add Track dialog [111](#)
  - Creating [463](#)
  - Inspector [112](#)
  - Loading Audio Samples [462](#)
  - Loading MIDI Parts [463](#)
  - Pool [476](#)
  - Sampler Control [462](#)
  - Transferring Samples to Instruments [475](#)
- Saturation
  - Strip module [339](#)
- Save as Template [85](#)
- Save partial preferences settings [887](#)
- Save Track Preset [163](#), [166](#)
- Scale Around Absolute Center
  - Automation Event Editor [540](#)
  - Controller Event Editor [636](#)
  - Tempo Event Editor [786](#)
- Scale Around Relative Center
  - Automation Event Editor [540](#)
  - Controller Event Editor [636](#)
  - Tempo Event Editor [786](#)
- Scale events [736](#)
  - Adding [736](#)
  - Auditioning [736](#)
  - Automatic scales [736](#)
  - Changing [736](#)
  - Follow Chord Track [743](#)
  - Showing [736](#)
- Scale Vertically
  - Automation Event Editor [540](#)
  - Controller Event Editor [636](#)
  - Tempo Event Editor [786](#)
- Scan Folders only when MediaBay is open [901](#)

- Scan unknown File Types [901](#)
- Scanning
  - MediaBay [508](#)
- Score display [663](#)
- Score Editor [656](#)
  - Display [662](#)
  - Info line [661](#)
  - Lower zone [55](#)
  - Staff settings [663](#)
  - Status line [661](#)
  - Toolbar [658](#)
- Score font
  - Setting [669](#)
- Score text
  - Adding [668](#)
  - Editing [668](#)
- Scores
  - Printing [669](#)
- Scroll to selected Track [892](#)
- Scrub Tool [174](#)
- Scrub Volume [905](#)
- Scrubbing
  - Scrub tool [174](#)
- Secondary Time Format
  - Selecting [215](#)
- Sections
  - Chord Pads [758](#)
- Select Channel/Track on Edit Settings [892](#)
- Select Channel/Track on Solo [892](#)
- Select Controllers in Note Range [637](#)
- Select Controllers in Note Range - Use Extended Note Context [891](#)
- Select Media Type
  - MediaBay [511](#)
- Select Tool - Show Extra Info [892](#)
- Select Track for Auditioning [735](#)
  - Track Control [98](#)
- Select Track on Background Click [888](#)
- Selecting
  - Tracks [147](#)
- Selection Ranges
  - Creating [189](#)
  - Editing [191](#)
- Selections
  - Rendering [797](#)
- Send effects [361](#), [369](#)
  - Adding FX channel tracks [370](#)
  - Adding FX channel tracks to Selected Channels [370](#)
  - Setting level [372](#)
- Send Level [907](#)
- Sends
  - MixConsole [346](#)
- Set Spacer between Selected Events [178](#)
- Set Track Type Filter [41](#)
- Setting Event Colors to Track Colors [75](#)
- Shared Copies
  - Convert to Real Copy [185](#)
  - Creating [185](#)
- Show Frame Numbers
  - Track Control [98](#)
- Show Lanes
  - Track Control [98](#)
- Show Note Expression Data [715](#)
- Show Scales [736](#)
  - Track Control [98](#)
- Show Thumbnails
  - Track Control [98](#)
- Side-chain [373](#), [375](#)
  - Ducking delay [374](#)
  - Effect inputs [362](#)
  - Inserts rack [336](#)
  - Trigger signals [375](#)
- Side-chain inputs [362](#)
- Signature track [134](#)
  - Inspector [134](#)
  - Track controls [135](#)
- Silence
  - Detecting [406](#)
  - Direct Offline Processing [399](#)
  - Inserting [193](#)
  - Removing [409](#)
- Simple Crossfade Editor [277](#)
- Single Voice
  - Follow Chord Track [742](#)
- Slices [434](#)
  - Close gaps [439](#)
  - Delete overlaps [439](#)
- Slider Mode [890](#)
- Smallest Track Height To Show Data [893](#)
- Smallest Track Height To Show Name [893](#)
- Snap [67](#)
  - Sample Editor [431](#)
- Snap MIDI Parts to Bars [903](#)
- Snap point
  - Setting [67](#)
- Snap Point To Cursor [67](#)
- Snap to zero crossing [68](#)
- Snap type
  - Project window [68](#)
- Solo
  - MixConsole [327](#)
  - Track Control [98](#)
- Solo Defeat
  - MixConsole [327](#)
- Solo Record in MIDI Editors [903](#)
- Spectrum Analyzer [410](#)
  - Audio Functions [409](#)
  - Comparing level values [411](#)
- Split MIDI Controllers [891](#)
- Split MIDI Events [891](#)
- Splitting
  - By ranges [193](#)
  - Events [181](#)
  - Into equal events [182](#)
- Standard algorithm [404](#)
- Standard Compressor
  - Details view [355](#)
  - Edit Module [355](#)
- Start Recording at Cursor
  - Common Record Modes [234](#)
- Start Recording at Left Locator
  - Common Record Modes [234](#)
- Static value line
  - Automation [536](#)
- Stationary Cursors [904](#)

- Statistics
    - Audio Functions 411
  - Status line
    - Project window 43
    - Score Editor 661
  - Step recording 655
  - Stereo Flip
    - Direct Offline Processing 399
  - Stop playback while winding 904
  - Stretch
    - Automation Event Editor 540
    - Controller Event Editor 636
    - Tempo Event Editor 786
  - Strip presets 346
  - Strip Presets
    - Loading in MediaBay 531
  - Studio Setup
    - Dialog 12
    - Note Expression Input Device 708
  - Suspend Auto-Scroll when Editing 215
  - Suspend VST 3 plug-in processing when no audio signals are received 908
  - Swing
    - Quantizing 266
  - Synchronization 814
    - Audio clock 816
    - External Sync 822
    - Machine Control Master 814
    - Machine Control Slave 814
    - MIDI clock 816
    - Setup dialog 817
    - Speed references 816
    - Timecode 815
    - Timecode Master 814
    - Timecode Slave 814
  - Synchronize Plug-in Program Selection to Track Selection 908
  - Synchronizing Track Data
    - Follow Chord Track 743
  - SysEx
    - Changing settings 701
    - Editing values 702
    - Messages 700
  - System component information
    - Exporting 385
    - Managing system components 384
  - System Component Information 383
- ## T
- Tap Tempo 789
  - Tapemachine Style
    - Monitoring 907
  - Template projects 83
  - Templates 83
    - Renaming 85
  - Tempo
    - Set Definition from Tempo 791
  - Tempo Editor
    - Toolbar 784
  - Tempo Event Editor 786
    - Compress Left 786
    - Compress Right 786
  - Tempo Event Editor (*continued*)
    - Move Vertically 786
    - Scale Around Absolute Center 786
    - Scale Around Relative Center 786
    - Scale Vertically 786
    - Stretch 786
    - Tilt Left 786
    - Tilt Right 786
  - Tempo Events
    - Editing 788
  - Tempo modes
    - Fixed Tempo 782
    - Tempo track 782
  - Tempo track 135, 782, 785
    - Activate 784
    - Editor 783
    - Inspector 136
    - Mode 782
    - Tempo changes 787
    - Track controls 136
  - Tempo-related tracks 782
  - Thumbnail Memory Cache Size 908
  - Thumbnails 836
    - Thumbnail cache files 836
  - Tilt Left
    - Automation Event Editor 540
    - Controller Event Editor 636
    - Tempo Event Editor 786
  - Tilt Right
    - Automation Event Editor 540
    - Controller Event Editor 636
    - Tempo Event Editor 786
  - Time Base
    - Linear 782
    - Musical 782
    - Tracks 154
  - Time display 215
  - Time Display Window 210
  - Time Format 215
  - Time linear track time base 154
  - Time Signature Events
    - Adding 792
    - Adding on the Signature Track 792
    - Setting up 792
    - Setting up Click Patterns 793
  - Time Stretch
    - Algorithms 403
    - Direct Offline Processing 399
    - Limitations 405
  - Time Stretch Tool Algorithm 889
  - Time-related tracks 782
  - Timecode
    - Standards 815
    - Synchronization 815
  - Timecode Subframes
    - Showing 904
  - Timeline
    - Ruler 618
  - Tips
    - Showing 896
  - Toggle Time Base 782
  - Tool modifier keys 872, 892

- Toolbar
  - Pool [479](#)
  - Project window [32](#)
  - Score Editor [658](#)
- Toolbar Divider
  - Project window [38](#)
- Toolbox
  - Project window [38](#)
- Toolbox on Right-Click [892](#)
- Track automation data
  - Automation [536](#)
- Track Color
  - Resetting [73](#)
- Track Controls [98](#)
- Track Controls Settings [97](#)
- Track Folding [149](#)
- Track Height [146](#)
- Track Inspector
  - Opening [46](#)
- Track list [39](#)
  - Dividing [39](#)
- Track parameters
  - Track Quick Controls [570](#)
- Track Pictures [144](#)
  - Browser [145](#)
  - Showing [144](#)
- Track presets
  - Quick Control assignment [572](#)
- Track Presets [162](#)
  - Applying [162](#), [163](#)
  - Audio [162](#)
  - creating [166](#)
  - Creating [163](#)
  - Extracting Sounds [164](#)
  - Instrument [164](#)
  - Loading [166](#)
  - Loading in MediaBay [529](#)
  - Loading Inserts and EQ [167](#)
  - MIDI [162](#)
  - Multi-Track [165](#)
  - Pattern Banks [166](#)
  - Previewing in MediaBay [517](#)
  - Saving Track Quick Control Assignment Presets [167](#)
  - Track Quick Controls [167](#)
  - VST Presets [164](#)
- Track Quick Controls [569](#), [590](#)
  - Assigning effect parameters [571](#)
  - Assigning instrument parameters [572](#)
  - Assigning parameters [570](#)
  - Automatable Parameters [573](#)
  - Connecting with Remote Controllers [574](#)
  - Inspector [570](#)
  - Loading presets [573](#)
  - Parameter assignment [570](#)
  - Presets [167](#)
  - QC Learn Mode [571](#)
  - Removing assignments [572](#)
  - Saving assignments as presets [167](#), [572](#)
  - Showing automated assignments [574](#)
- Track Selection follows Event Selection [888](#)
- Track Time Base [154](#), [782](#)
- Track Version IDs [157](#)
- Track Versions [155](#)
  - Activating [157](#)
  - Copying and Pasting [159](#)
  - Creating [156](#)
  - Creating from lanes [161](#)
  - Creating lanes from track versions [161](#)
  - Deleting [159](#)
  - Duplicating [158](#)
  - Inspector Section [95](#)
  - Names [160](#)
  - Renaming [160](#)
  - Renaming on multiple tracks [160](#)
- Track Zoom [146](#)
- Tracks [94](#)
  - Add Track dialog [140](#)
  - Adding [140](#), [141](#)
  - Audio [103](#)
  - Chord [130](#)
  - Colorizing [73](#), [144](#)
  - Customizing track controls [97](#)
  - Deselecting [148](#)
  - Disabling audio tracks [148](#)
  - Duplicating [148](#)
  - Folder [125](#)
  - FX channel [120](#)
  - Group Channel [117](#)
  - Inspector [95](#)
  - Instrument [106](#)
  - Marker [133](#)
  - MIDI [113](#)
  - Moving [143](#)
  - Removing [143](#)
  - Renaming [144](#)
  - Rendering [794](#), [797](#)
  - Ruler [123](#)
  - Sampler [110](#)
  - Selecting [147](#)
  - Signature [134](#)
  - Tempo [135](#)
  - Transpose [137](#)
  - Using Track Presets [140](#)
  - Video [137](#)
- Transformer
  - Strip module [339](#)
- Transport
  - Overview [204](#)
  - Sections [204](#)
- Transport Bar [204](#)
- Transport menu
  - Functions [199](#)
- Transport panel [194](#)
  - Display format [215](#)
  - Overview [194](#)
  - Post-roll [216](#)
  - Pre-roll [216](#)
  - Sections [194](#)
- Transport pop-up window [209](#)
- Transport Zone
  - Project window [44](#)
- Transpose
  - Exclude Parts or Events [299](#)
  - Global [299](#)
  - Independent [299](#)

- Transpose (*continued*)
    - Indicate Transpositions 297
    - Info line 298
    - Lock 296
    - MIDI function 608
    - Mute 296
    - Project Root Key 292
  - Transpose functions 292
  - Transpose track 137, 295
    - Inspector 137
    - Lock 296
    - Mute 296
    - Recording 298
    - Track controls 137
    - Transposing 296
  - Treat Muted Audio Events like Deleted 889
  - Trim tool
    - Changing event lengths 651
  - Tube Compressor
    - Details view 355
    - Edit Module 355
  - Tuplets
    - Quantizing 266
  - Type of New Tempo Points 784
- ## U
- Undoing
    - Edit History 71
    - Maximum undo steps 71
    - Maximum Undo Steps 896
    - MixConsole parameter changes 314, 319
    - Offline processing 390, 491
    - Project window 32
    - Recording audio 240
    - Zoom operations 424
  - Use Drum Editor when Drum Map is assigned 893
  - Use Up/Down Navigation Commands for Selecting Tracks only 888
- ## V
- Value Box/Time Control Mode 890
  - Value display
    - Editing in List Editor 700
  - Velocity
    - MIDI function 615
  - Velocity events
    - Adding in controller display 631
    - Editing 631
  - Vertical Snap
    - Note Expression Event Editor 720
  - Vertical zoom
    - Sample Editor 424
  - Video
    - Codecs 834
    - Editing 839
    - Exporting 842
    - Extracting audio from 843
    - Formats 833
    - Importing 835
    - Output devices 834
    - Playback 837
    - Video (*continued*)
      - Scrubbing 839
      - Studio Setup 837
      - Thumbnails 836
  - Video Player window 838
    - Aspect ratio 838
    - Setting window size 838
  - Video track 137
    - Inspector 138
    - Track controls 138
  - Vintage Compressor
    - Details view 356
    - Edit Module 356
  - Visibility
    - Inspector 49, 50
    - MixConsole 313
    - Synchronizing track and channel visibility 51
  - Voicings 737
    - Automatic voicings 737
    - Configuring parameters 737
    - Library 737
    - Library subset 737
    - Octave offset 737
    - Piano 737
    - Range 737
  - Volume
    - MixConsole 328
  - Volume curve 281
  - Volume databases
    - Creating in the MediaBay 532
    - Mounting in the MediaBay 533
    - Removing from the MediaBay 533
    - Unmounting in the MediaBay 533
  - VST
    - Input ports 19
    - Output ports 19
    - VST 2 362
    - VST 3 362
  - VST 3
    - Suspend plug-in processing 556
  - VST Audio System 14
  - VST effect selector 368
  - VST instrument selector 550
  - VST instruments
    - Freezing 556
    - Presets 553
    - Saving presets 554
    - Setting up 547
  - VST Note Expression 707
  - VST Plug-in collection
    - Adding 566
  - VST Plug-in control panels
    - Closing 378, 549
    - Hiding 378, 549
    - Showing 378, 549
  - VST Plug-in Manager 563
    - Collections 564
    - Window 564
  - VST plug-in pictures
    - Adding 503, 504
  - VST Plug-ins
    - Adding collections 566
    - Blocklist 567

VST Plug-ins (*continued*)

- Hiding [567](#)
- Installing [563](#)
- Managing [563](#)
- Reactivating [567](#)
- Showing [567](#)

## VST Presets

- Loading [166](#)
- Previewing in MediaBay [517](#)

## VST Quick Controls

- Connecting with Remote Controllers [560](#)

VST System Link [823](#)

- Activating [827](#)
- Connections [825](#)
- Latency [826](#)
- Putting computers online [828](#)
- Setting up sync [825](#)

## VSTi rack

- Right zone [59](#), [60](#)

**W**

Warn before removing modified effects [908](#)

Warn on Processing Overloads [907](#)

Warping Algorithm [889](#)

Wave 64 files

- Exporting [812](#)

Wave files

- Exporting [807](#)

Waveform Brightness [894](#)

Waveform display [423](#)

- Sample Editor [423](#)

Waveform Outline Intensity [894](#)

Waveforms

- Showing [894](#)

When Recording Wave Files larger than 4 GB [902](#)

Wind Speed Options [904](#)

Windows

- Dialog [878](#)

Windows Media Audio files

- Exporting [809](#)
- Importing [254](#)

Word clock

- Synchronization [816](#)

Working with MIDI data

- Tools and functions for [679](#)

Workspaces

- Adding [874](#)
- Creating [874](#)
- Editing [874](#)
- External projects [874](#)
- Modifying [874](#)
- Organizing [875](#)
- Saving [874](#)
- Types [873](#)
- Updating [874](#)

Workspaces Organizer [875](#)

Write Automation

- Track Control [98](#)

Writing automation [536](#)

- Automatically [537](#)
- Manually [537](#)
- Tools [538](#)

**Z**

Zones

- Inspector [51](#)
- Keyboard focus [63](#)
- Left zone [45](#)
- Lower zone [52](#)
- MixConsole [312](#), [314](#)
- Project zone [31](#)
- Right zone [58](#)

Zoom

- Adapt Grid to Zoom [64](#)
- Audio Contents [65](#)
- Cycle Markers [66](#)
- Project window [64](#)
- Track Control [98](#)

Zoom history

- Project window [67](#)

Zoom presets

- Project window [66](#)

Zoom Tool Standard Mode - Horizontal Zooming Only [892](#)

Zoom while Locating in Time Scale [904](#)

Zooming

- To cycle markers [301](#)

Zooming horizontally [424](#)

Zooming tracks [146](#)

Zooming vertically [424](#)