

Operation Manual



CUBASE ELEMENTS₁₂

Personal Music Production System

The Steinberg Documentation Team: Cristina Bachmann, Martina Becker, Heiko Bischoff, Lillie Harris, Christina Kaboth, Insa Mingers, Matthias Obrecht, Sabine Pfeifer, Benjamin Schütte

Translation: Ability InterBusiness Solutions (AIBS), Moon Chen, Jérémie Dal Santo, Rosa Freitag, GiEmme Solutions, Josep Llodra Grimalt, Vadim Kupriianov, Roland Münchow, Boris Rogowski, Sergey Tamarovsky

This document provides improved access for people who are blind or have low vision. Please note that due to the complexity and number of images in this document, it is not possible to include text descriptions of images.

The information in this document is subject to change without notice and does not represent a commitment on the part of Steinberg Media Technologies GmbH. The software described by this document is subject to a License Agreement and may not be copied to other media except as specifically allowed in the License Agreement.

No part of this publication may be copied, reproduced, or otherwise transmitted or recorded, for any purpose, without prior written permission by Steinberg Media Technologies GmbH. Registered licensees of the product described herein may print one copy of this document for their personal use.

All product and company names are ™ or ® trademarks of their respective owners. For more information, please visit www.steinberg.net/trademarks.

© Steinberg Media Technologies GmbH, 2022.

All rights reserved.

Cubase Elements_12.0.20_en-US_2022-04-27

Table of Contents

7	New Features		
9	Introduction		
9	Platform-Independent Documentation		
9	PDF Documents and Online Documentation		
10	Documentation Structure		
10	Conventions		
11	Key Commands		
12	Setting up Your System		
12	Studio Setup Dialog		
13	Setting up Audio		
22	Setting up MIDI		
27	Synchronizers		
28	Audio Connections		
28	Audio Connections Window		
29	Renaming the Hardware Inputs and Outputs		
30	Adding Input and Output Busses		
31	Presets for Input and Output Busses		
32	Monitoring Bus		
32	Bus Configurations		
34	Project Window		
35	Showing/Hiding Zones		
35	Project Zone		
47	Left Zone		
52	Lower Zone		
58	Right Zone		
63	Keyboard Focus in the Project Window		
64	Zooming in the Project Window		
68	Snap Function		
71	Snap Grid		
72	Cross-Hair Cursor		
73	Edit History Dialog		
74	Color Handling		
82	Project Handling		
82	Creating New Projects		
82	Hub		
83	Project Assistant Dialog		
84	Project Files		
85	Template Files		
88	Project Setup Dialog		
91	Opening Project Files		
92	Saving Project Files		
93	Reverting to the Last Saved Version		
93	Choosing a Project Location		
94	Self-Contained Projects		
97	Tracks		
97	Track Inspector Settings Dialog		
99	Track Controls Settings Dialog		
104	Add Track Dialog		
105	Audio Tracks		
108	Instrument Tracks		
112	Sampler Tracks		
115	MIDI Tracks		
118	Group Channel Tracks		
		121	FX Channel Tracks
		124	Ruler Track
		126	Folder Tracks
		129	Arranger Track
		131	Chord Track
		133	Video Tracks
		134	Marker Track
		136	Track Handling
		136	Adding Tracks via the Add Track Dialog
		136	Adding Tracks Using Track Presets
		137	Adding Tracks by Dragging Files from the MediaBay
		137	Exporting MIDI Tracks as Standard MIDI Files
		139	Removing Selected Tracks
		139	Removing Empty Tracks
		139	Moving Tracks in the Track List
		140	Renaming Tracks
		140	Automatically Assigning Colors to New Tracks/Channels
		140	Showing Track Pictures
		142	Setting the Track Height
		143	Selecting Tracks
		144	Deselecting Tracks
		144	Duplicating Tracks
		144	Disabling Tracks
		145	Freezing Multiple Tracks
		146	Organizing Tracks in Folder Tracks
		146	Handling Overlapping Audio
		147	Events Display on Folder Tracks
		147	Modifying Event Display on Folder Tracks
		148	Track Presets
		153	Parts and Events
		153	Events
		157	Parts
		158	Editing Techniques for Parts and Events
		175	Range Editing
		175	Creating a Selection Range
		176	Editing Selection Ranges
		181	Playback and Transport
		181	Transport Panel
		185	Transport Menu
		190	Transport Bar
		195	Transport Pop-Up Window
		196	Time Display Window
		197	Left and Right Locators
		200	Setting the Project Cursor
		200	Auto-Scroll Settings Menu
		201	Time Formats
		202	Pre-Roll and Post-Roll
		203	Punch In and Punch Out
		203	Metronome Click
		208	Chase
		209	On-Screen Keyboard
		209	Recording MIDI With the On-Screen Keyboard

210	On-Screen Keyboard Options	376	Spectrum Analyzer Window
211	Recording	378	Statistics Window
211	Basic Recording Methods	380	Sample Editor
215	Monitoring	381	Sample Editor Toolbar
217	Audio Recording Specifics	386	Info Line
222	MIDI Recording Specifics	387	Overview Line
230	Remaining Record Time	387	Sample Editor Inspector
230	Lock Record	389	Ruler
231	Importing Audio and MIDI Files	389	Waveform Display
231	Audio File Import	391	Range Editing
238	MIDI File Import	393	Regions List
240	Quantizing MIDI and Audio	396	Snap Point
240	Quantize Functions	398	Hitpoints
241	Quantizing MIDI Event Starts	399	Calculating Hitpoints
242	Quantizing MIDI Event Lengths	403	Locating to Hitpoints in the Project Window
242	Quantizing MIDI Event Ends	403	Slices
242	Quantizing Audio Event Starts	405	Creating a Groove Quantize Preset
243	Quantize Panel	405	Creating Markers
250	Fades and Crossfades	406	Creating Regions
250	Event-Based Fades	406	Creating Events
254	Creating Clip-Based Fades	407	Creating MIDI Notes
255	Crossfades	409	Tempo Matching Audio
258	Auto Fades and Crossfades	409	Algorithm Presets
261	Arranger Track	409	Stretching Audio Events to the Project Tempo
261	Adding Arranger Events on the Arranger Track	410	Musical Mode
262	Arranger Editor	411	Audio Part Editor
265	Setting up an Arranger Chain and Adding Events	412	Audio Part Editor Toolbar
267	Jump Mode	416	Info Line
269	Arranging Music to Video	416	Ruler
270	Markers	417	Lanes
270	Position Markers	417	Operations
270	Cycle Markers	421	Sampler Tracks
271	Markers Window	421	Loading Audio Samples into Sampler Control
275	Marker Track	422	Loading MIDI Parts into Sampler Control
277	Importing and Exporting Markers	422	Creating Sampler Tracks
279	MixConsole	423	Sampler Control
279	MixConsole in Lower Zone	438	Sample Editing and Playback Functions
280	MixConsole Window	444	Transferring Samples from Sampler Control to VST Instruments
329	Audio Effects	446	Pool
329	Insert Effects and Send Effects	446	Pool Window
331	Insert Effects	451	Working with the Pool
336	VST Effect Selector	466	MediaBay and Media Rack
337	Send Effects	466	Media Rack in Right Zone
342	Side-Chaining	477	MediaBay Window
346	Dither Effects	496	Working with Volume Databases
347	Effect Control Panel	498	MediaBay Settings
350	Effect Presets	500	Automation
355	System Component Information Window	500	Recording your Actions
358	Direct Offline Processing	500	Automation Curves
359	Direct Offline Processing Workflow	501	Static Value Line
359	Direct Offline Processing Window	501	Write/Read Automation
363	Built-In Audio Processes	501	Writing Automation Data
368	Key Commands for Direct Offline Processing	504	Editing Automation Events
370	Time Stretch Algorithms	508	Automation Tracks
370	Standard	510	VST Instruments
371	Limitations	510	Adding VST Instruments
372	Audio Functions	511	VST Instrument Control Panel
372	Detect Silence Dialog	513	VST Instrument Selector
		514	Creating Instrument Tracks

514	VSTi Rack in the Right Zone	611	Deleting Controller Data
515	VST Instruments Window	611	Deleting Continuous Controller Data
515	VST Instruments Window Toolbar	611	Restricting Polyphonic Voices
516	VST Instrument Controls	612	Thinning Out Controller Data
518	Presets for Instruments	612	Extracting MIDI Automation
520	Playing Back VST Instruments	612	Reversing the Playback Order of MIDI Events
523	Latency	613	Inverting the Order of Selected MIDI Events
524	Import and Export Options		
525	Side-Chaining for VST Instruments		
528	Installing and Managing VST Plug-ins	614	MIDI Editors
528	Plug-ins and Collections	614	Common MIDI Editor Functions
531	Adding New Plug-in Collections	623	Controller Display
532	Hiding Plug-ins	643	Key Editor
533	Reactivating Plug-ins from the Blocklist	659	Key Editor Operations
534	Track Quick Controls	672	Score Editor
535	Parameter Assignment	678	Score Editor Operations
538	Controlling Automatable Parameters	685	Drum Editor
		696	Drum Editor Operations
		699	Drum Maps
540	MIDI Remote	705	Chord Functions
540	MIDI Remote Tab	705	Chord Track
545	Using Supported MIDI Controllers with MIDI Remote	706	Chord Events
		712	Scale Events
545	Other MIDI Controllers and MIDI Remote	714	Voicings
550	Add MIDI Controller Surface Dialog	717	Converting Chord Events to MIDI
556	MIDI Controller Settings Pane	718	Controlling MIDI Playback Using the Chord Track
556	MIDI Remote Mapping Assistant		
564	MIDI Remote Manager Window	722	Assigning Voices to Notes
570	MIDI Remote Script Console	722	Creating Chord Events from MIDI
571	MIDI Remote API	724	Creating Chord Events from Audio Events
		725	Recording Chord Events with a MIDI Keyboard
572	Remote-Controlling Cubase	726	Chord Pads
572	Connecting Remote Devices	726	Chord Pads Zone
572	Removing the Remote Input from All MIDI Inputs	729	Functions Menu
573	Setting up Remote Devices	729	Chord Assistant
575	Remote Devices and Automation	731	Chord Assignment
576	Assigning Commands to Remote Devices	733	Swapping Chord Assignments
577	Remote Control Editor	733	Copying Chord Assignments
581	Track Quick Controls	734	Playing Back and Recording Chords
583	VST Quick Controls	737	Player Setup
583	Generic Remote Page (Legacy)	741	Chord Pads Setup Dialog
		746	Chord Pads Presets
589	MIDI Realtime Parameters	747	Creating Chord Events from Chord Pads
589	MIDI Track Parameters	747	Creating MIDI Parts from Chord Pads
589	MIDI Modifiers		
594	Transpose and Velocity on the Info Line	748	Editing Tempo and Time Signature
595	Using MIDI Devices	748	Project Tempo Modes
595	Program Change Messages and Bank Select Messages	748	Tempo Track Editor
596	Patch Banks	751	Tempo Changes for Projects
596	MIDI Device Manager	752	Setting up a Fixed Project Tempo
		754	Beat Calculator
602	MIDI Functions	755	Set Definition from Tempo Dialog
602	Transpose Setup Dialog	756	Time Signature Events
603	Merging MIDI Events into a New Part	757	Export Audio Mixdown
604	Dissolve Part Dialog	757	Export Audio Mixdown Dialog
606	Repeating MIDI Events of Independent Track Loops	764	Mixing Down to Audio Files
		764	File Formats
607	Extending MIDI Notes	770	Synchronization
607	Fixing MIDI Note Lengths	770	Master and Slave
607	Fixing MIDI Note Velocities	771	Timecode Formats
608	Rendering Sustain Pedal Data to Note Lengths	772	Clock Sources
609	Deleting Overlaps	773	Project Synchronization Setup Dialog
609	Editing Velocity	778	External Synchronization
610	Deleting Double Notes		

779	VST System Link
779	Setting up VST System Link
784	Activating VST System Link
786	Application Examples
790	Video
790	Video File Compatibility
791	Frame Rates
791	Video Output Devices
792	Preparations for Creating Video Projects
794	Preparations for Video Playback
797	Editing Video
797	Export Video
800	Extracting Audio from Video
801	Key Commands
801	Key Commands Dialog
803	Assigning Key Commands
803	Searching for Key Commands
804	Removing Key Commands
804	Saving Key Commands Presets
804	Loading Key Command Presets
804	Resetting Key Commands
805	Default Key Commands
816	Setting up Tool Modifier Keys
817	Customizing
817	Setup Options
819	Windows Dialog
820	Where are the Settings Stored?
820	Safe Mode Dialog
823	Optimizing Audio Performance
823	Performance Aspects
824	Settings That Affect Performance
824	Audio Performance Window
825	ASIO-Guard
827	Preferences
827	Preferences Dialog
828	Editing
834	Editors
834	Event Display
838	General
839	MIDI
842	MediaBay
843	Metering
843	Record
845	Transport
846	User Interface
848	VST
850	Video
851	Index

New Features

The following list informs you about the most important improvements in Cubase and provides links to the corresponding descriptions.

New Features in Version 12

Highlights

Sample Accurate Volume Automation

- The new **Volume Automation Precision** function allows for volume automation that is 100% sample accurate, regardless of the buffer size. You can set the number of samples after which a new volume automation event is processed. The automation curve between the processed events is interpolated. This smoothens transitions between automation events and prevents sudden jumps which may lead to crackles. See [Audio System Page](#).

Editing Workflow Improvements

- You can now freeze/unfreeze several tracks at once. See [Freezing Multiple Tracks](#).
- The new nudge grid options let you edit independently from the project grid. This allows you to work with a musical **Bars+Beats** grid for all mouse operations while fine-tuning positions and lengths of events and parts using **Nudge** key commands. See [Setting up a Snap Grid for Nudge Operations](#).
- You can now move event ends to the project cursor position. See [Move Submenu](#).
- When resizing events with the **Object Selection** tool, you can now automatically adapt the size of existing fades by using a tool modifier. See [Resizing Events with the Object Selection Tool - Normal Sizing](#).
- You can now assign key commands to slip event content operations. See [Moving the Contents of Events](#).
- We have extended key-command-based operations for creating and adjusting range selections. It is now possible to also increase/decrease the vertical direction to span range selections across multiple tracks. This way, you can entirely rely on key command support to adjust and move a range selection in all four directions. See [Adjusting the Size of Selection Ranges](#).
- All fade-related commands are now gathered in a dedicated **Fades** submenu in the **Audio** menu. See [Creating and Editing Fades with the Range Selection Tool](#).

Sampler Track Improvements

- You can now use your **AudioWarp** and **Quality** settings for slice playback. See [Playback Section](#).

MIDI Remote Integration

- MIDI controllers are essential to every music production setup and, in Cubase, integrating them has reached a new level. Built around the new concept of MIDI remote scripts, Cubase will automatically detect your device and map the controls. If there is no script for your device yet, you can easily create your own with the **MIDI Controller Surface Editor**. You can then conveniently connect controls and parameters with the **Mapping Assistant**. See [MIDI Remote](#).

Creating Chord Events from Audio Events

- You can now drop your audio recording on the chord track and Cubase will lay out the chord progression for you. And if the detection does not match your scale, the **Chord Assistant** can suggest the nearest alternatives based on the following chords. See [Creating Chord Events from Audio Events](#).

New Performance Meter

- The **Audio Performance** window now offers realtime, ASIO-Guard, and peak indicators. See [Audio Performance Window](#).

More New Features

Lin One Dither Plug-in

- **Lin One Dither** is a dithering plug-in that uses advanced algorithms and offers additional noise shaping to increase the apparent signal-to-noise ratio by altering the spectrum of the low-level audio signal. The plug-in is described in the separate document **Plug-in Reference**. See [Lin One Dither](#).

Markers

- The new **Markers** window gives you a better overview of the markers used in your project and facilitates editing. See [Markers Window](#).

Sample Editor Editing Improvements

- The **Sample Editor** toolbar now comes with several improvements for displaying, zooming, and editing clips and events. See [Sample Editor Toolbar](#).

Last but Not Least

StepFilter Plug-in with New Randomize Parameters

- **StepFilter** now allows you to apply a certain deviation of the base cutoff and base resonance parameters with each new cycle of the pattern. The plug-in is described in the separate document **Plug-in Reference**. See [StepFilter](#).

WinRT MIDI Support

- Cubase now supports the Windows **Runtime MIDI API, WinRT MIDI**, that allows for native support of bluetooth MIDI in Windows, better plug and play, and better handling of multiple identical devices. See [MIDI Port Setup Page](#).

Move the Project Cursor in Fixed Steps via Key Commands

- You can now assign additional key commands that allow you to move the project cursor in fixed steps of 5 s, 10 s, and 20 s, forward or backward. See [Setting the Project Cursor](#).

Improved Silence Detection

- The new audition function allows you to directly preview any position in the analyzed audio event. Furthermore, you can apply fade ins and fade outs to the resulting audio events. See [Detect Silence Dialog](#).

Event Display Improvements

- You can now decide whether to append the clip name to the event name. See [Event Display - Audio](#).

New Application Scaling Menu for Native Windows Scaling for HiDPI

- You can now scale the Cubase user interface relative to the Windows system scaling setting. See [General](#).

Introduction

This is the **Operation Manual** for Steinberg's Cubase. Here you will find detailed information about all the features and functions in the program.

Platform-Independent Documentation

The documentation applies to the operating systems Windows and macOS.

Features and settings that are specific to one of these platforms are clearly indicated. In all other cases, the descriptions and procedures in the documentation are valid for Windows and macOS.

Some points to consider:

- The screenshots are taken from Windows.
- Some functions that are available on the **File** menu on Windows can be found in the program name menu on macOS.

PDF Documents and Online Documentation

The documentation consists of several documents. You can read them online or download them from steinberg.help.

You can reach steinberg.help from the program by selecting **Help > Cubase Help**.

Operation Manual

The main Cubase reference documentation, with detailed descriptions of operations, parameters, functions, and techniques.

Plug-in Reference

Describes the features and parameters of the included VST plug-ins and VST instruments.

Remote Control Devices

Lists the supported MIDI remote control devices.

Groove Agent SE

Describes the features and parameters of the included VST instrument Groove Agent SE.

HALion Sonic SE

Describes the features and parameters of the included VST instrument HALion Sonic SE.

Steinberg Library Manager

Describes how you can register and manage your VST Sound libraries.

Documentation Structure

In our documentation, we divide information into three different types of topics, according to their content.

Descriptions of the User Interface

Topics that describe the functionality of user interface items and list the options and settings of dialogs, panels, or other items.

Descriptions of Basic Concepts

Topics that describe concepts and explain the functionality of a specific software feature.

Descriptions of Procedures

Topics that provide step-by-step instructions for how to perform a specific task. These topics often provide an example for why you might want to follow the steps and a brief summary of the result, including consequences to be aware of.

Because of this division of information, our documentation structure functions as a reference you can consult for specific information or instructions as required, rather than a guide you must read from start to finish.

TIP

Descriptive topics do not describe how to perform a task, and procedural topics do not explain what something is. To find general information about items or concepts, we recommend searching for them by name, such as “events”. To find instructions for performing particular actions, we recommend including a relevant verb in your search, such as “recording”.

Links at the bottom of topics guide you to further relevant content. You can also check the sidebar for nearby, related topics in the documentation structure.

Conventions

In our documentation, we use typographical and markup elements to structure information.

Typographical Elements

The following typographical elements mark the following purposes.

Prerequisite

Requires you to complete an action or to fulfill a condition before starting a procedure.

Procedure

Lists the steps that you must take to achieve a specific result.

Important

Informs you about issues that might affect the system, the connected hardware, or that might bring a risk of data loss.

Note

Informs you about issues that you should consider.

Tip

Adds further information or useful suggestions.

Example

Provides you with an example.

Result

Shows the result of the procedure.

After Completing This Task

Informs you about actions or tasks that you can perform after completing the procedure.

Related Links

Lists related topics that you can find in this documentation.

Markup

Bold text indicates the name of a menu, option, function, dialog, window, etc.

EXAMPLE

To open the **Functions** menu, click **Functions Menu** in the top right corner of the **MixConsole**.

If bold text is separated by a greater-than symbol, this indicates a sequence of different menus to open.

EXAMPLE

Select **Project > Add Track**.

Key Commands

Many of the default key commands, also known as keyboard shortcuts, use modifier keys, some of which are different depending on the operating system.

When key commands with modifier keys are described in this manual, they are indicated with the Windows modifier key first, followed by the macOS modifier key and the key.

EXAMPLE

Ctrl/Cmd-Z means: press **Ctrl** on Windows or **Cmd** on macOS, then press **Z**.

Setting up Your System

To use Cubase, you must set up your audio, and if required, your MIDI system.

Studio Setup Dialog

The **Studio Setup** dialog allows you to set up your connected audio, MIDI, and remote control devices.

- To open the **Studio Setup** dialog, select **Studio > Studio Setup**.

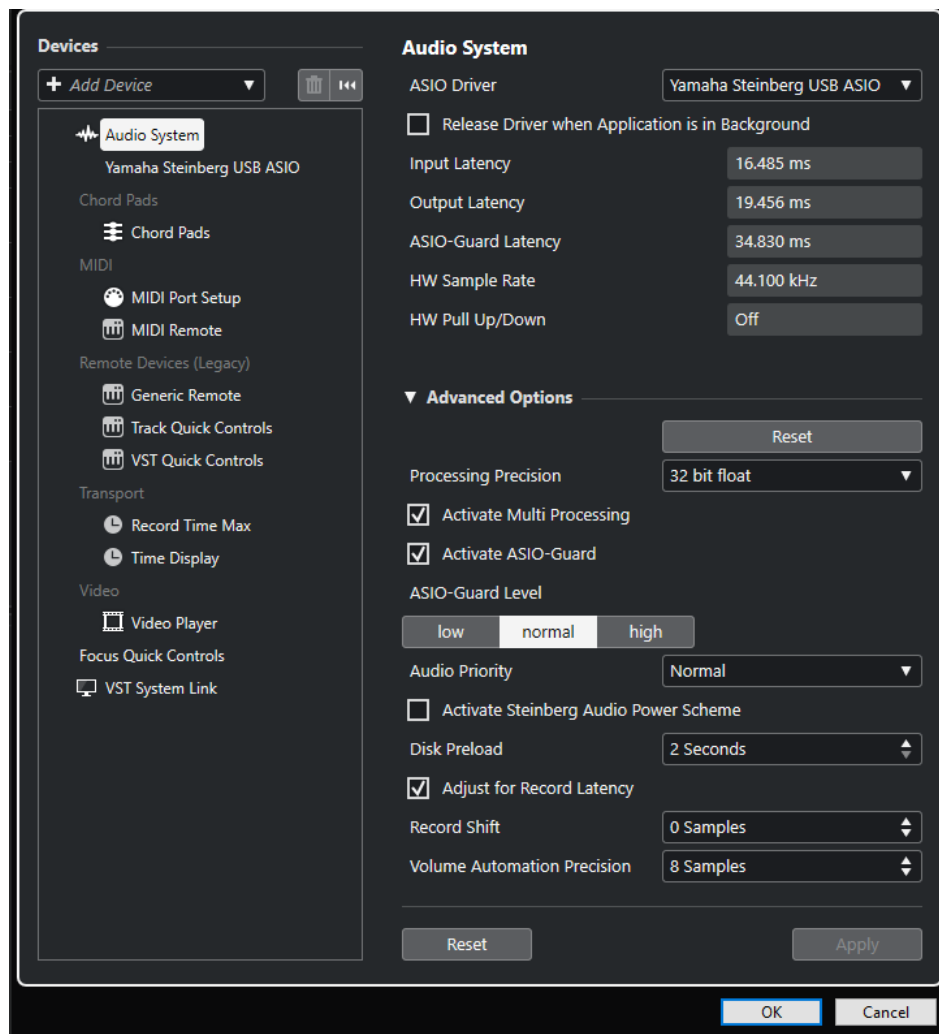

The following options are available in the **Devices** section to the left:

Add Device

Allows you to manually add devices such as a **Note Expression Input Device**, an additional **Time Display** device, or specific remote control devices.

Remove

Allows you to remove manually added devices.

Reset All Devices



Resets all devices in the devices list.

Devices list

Select a device in the **Devices** list to show its settings in the right section.

The following options are available at the bottom of the page for each device:

Reset

Sends a reset signal to the active ASIO device and restarts the audio processing. This can solve problems with audio playback.

NOTE

This leads to a short interruption of the playback.

Apply

Applies your settings on this page.

RELATED LINKS

[Audio System Page](#) on page 16

[ASIO Driver Setup Page](#) on page 18

[MIDI Port Setup Page](#) on page 24

Setting up Audio

You must set up your audio equipment before you can use it in Cubase.

IMPORTANT

Make sure that all equipment is turned off before making any connections.

Simple Stereo Input and Output Setup

If you only use a stereo input and output from Cubase, you can connect your audio hardware, for example, the inputs of your audio card or your audio interface, directly to the input source and the outputs to a power amplifier and speaker.

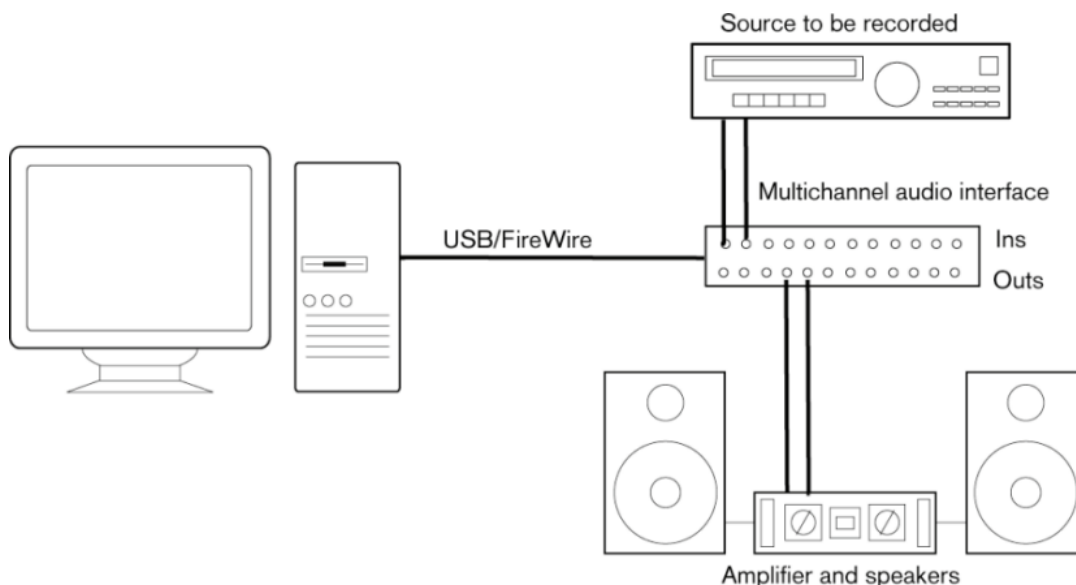

Audio Connections

Your system setup depends on many different factors, for example, on the kind of project that you want to create, on the external equipment that you want to use, or on the computer hardware that is available to you. Therefore, the following sections can only serve as examples.

How to connect your equipment, that is, whether to use digital or analog connections also depends on your setup.

Recording Levels and Inputs

When you connect your equipment, make sure that the impedance and levels of the audio sources and inputs are matched. Using the correct type of input is important to avoid distortion or noisy recordings. For example, different inputs can be used, such as consumer line level (-10 dBV) or professional line level (+4 dBu).

Sometimes, you can adjust input characteristics on the audio interface or on its control panel. For details, refer to the documentation that came with the audio hardware.

IMPORTANT

Cubase does not provide any input level adjustments for the signals that are coming into your audio hardware, since these are handled differently for each card. Adjusting input levels is either done in a special application that is included with the hardware or via its control panel.

Word Clock Connections

If you are using a digital audio connection, you may also need a word clock connection between the audio hardware and external devices. For details, refer to the documentation that came with the audio hardware.

IMPORTANT

Set up word clock synchronization correctly, or you may experience clicks and crackles in your recordings.

Selecting an Audio Driver

By selecting an audio driver, you allow Cubase to communicate with the audio hardware. Normally, when you start Cubase, a dialog opens that prompts you to select a driver, but you can also select your audio hardware driver as described below.

NOTE

On Windows operating systems, we recommend that you access your hardware via an ASIO driver developed specifically for the hardware. If no ASIO driver is installed, contact the manufacturer of your audio hardware for information on available ASIO drivers. If no specific ASIO driver is available, you can use the Generic Low Latency ASIO driver.

PROCEDURE

1. Select **Studio > Studio Setup**.
 2. In the **Devices** list, select **Audio System**.
 3. Open the **ASIO Driver** pop-up menu and select your audio hardware driver.
 4. Click **OK**.
-

Setting up Audio Hardware

You must select and set up your audio hardware in the **Studio Setup** dialog before you can use it.

PREREQUISITE

You have selected a driver for your audio hardware.

PROCEDURE

1. Select **Studio > Studio Setup**.
2. In the **Devices** list, select your audio hardware driver.
3. Do one of the following to open the control panel for your audio hardware:
 - On Windows, click **Control Panel**.
 - On macOS, click **Open Config App**.
This button is available only for particular hardware products. If it is not available in your setup, refer to the documentation of your audio hardware.

NOTE

The control panel is provided by the manufacturer of your audio hardware, and it is different for each audio interface brand and model. However, control panels for the Generic Low Latency ASIO Driver (Windows only) are provided by Steinberg.

4. Set up your audio hardware as recommended by the manufacturer.

Audio System Page

On the **Audio System** page, you can select an ASIO driver for your audio hardware.

- To open the **Audio System** page, select **Studio > Studio Setup** and select **Audio System** in the **Devices** list.

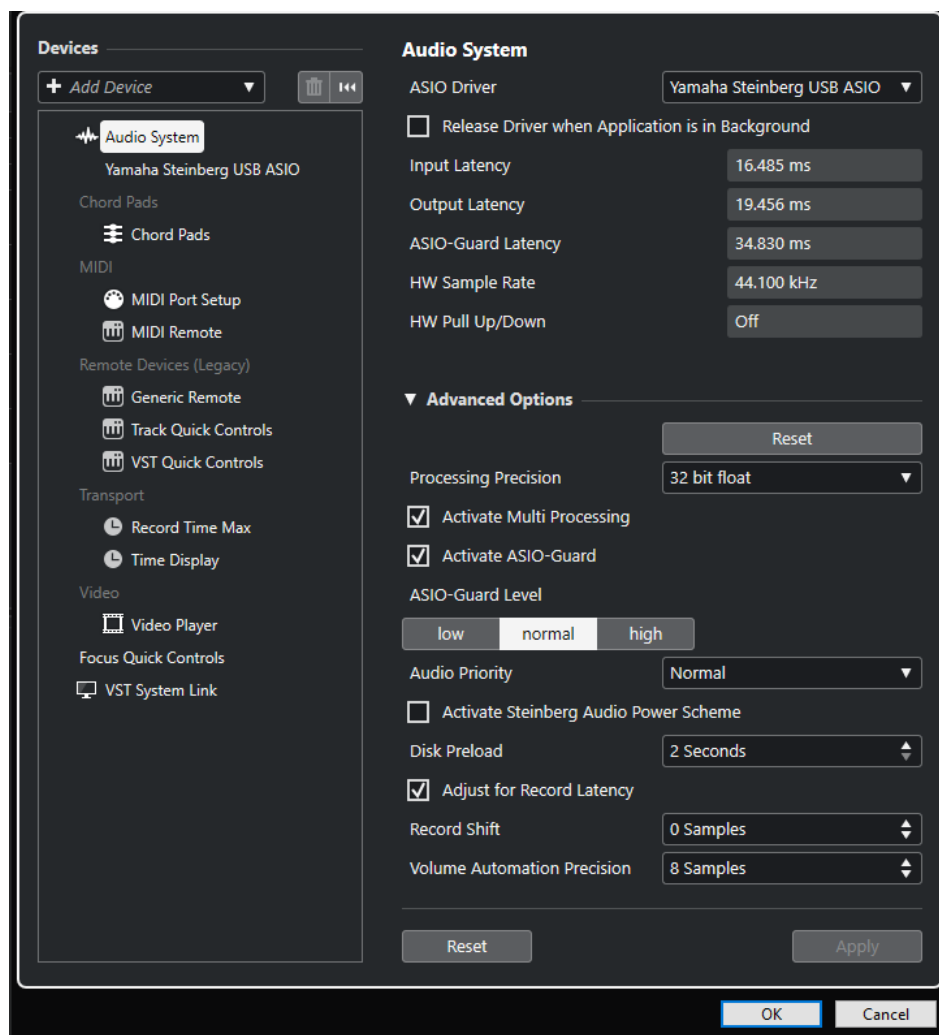

The following options are available:

ASIO Driver

Allows you to select a driver.

Release Driver when Application is in Background

Releases the driver and allows other applications to play back via your audio hardware even if Cubase is running.

Input Latency

Shows the input latency of the audio hardware.

Output Latency

Shows the output latency of the audio hardware.

ASIO-Guard Latency

Shows the ASIO-Guard latency.

HW Sample Rate

Shows the sample rate of your audio hardware.

HW Pull Up/Down

Shows the pull up/down status of the audio hardware.

In the **Advanced Options** section, the following options are available:

Reset

Allows you to reset the options in this section to their defaults.

Processing Precision

Allows you to set the audio processing precision to 32 bit float or 64 bit float. Depending on this setting, all channels are processed and mixed in 32-bit floating-point or 64-bit floating-point format.

NOTE

A processing precision of 64 bit float can increase CPU load and memory consumption.

To show all plug-ins that support 64-bit float processing, open the **VST Plug-in Manager** from the **Studio** menu, and activate **Show Plug-ins That Support 64-Bit Float Processing** in the **Display Options** pop-up menu.

NOTE

VST 2 plug-ins and instruments are always processed with 32-bit precision.

Activate Multi Processing

Allows you to distribute the processing load evenly to all available CPUs. This way, Cubase can make full use of the combined power of multiple processors.

Activate ASIO-Guard

Activates the ASIO-Guard. This is only available if **Activate Multi Processing** is activated.

ASIO-Guard Level

Allows you to set the ASIO-Guard level. The higher the level, the higher the processing stability and the audio processing performance. However, higher levels also lead to increased ASIO-Guard latency and memory usage.

Audio Priority (Windows only)

This setting should be set to **Normal** if you work with audio and MIDI. If you do not use MIDI at all, you can set this to **Boost**.

Activate Steinberg Audio Power Scheme

If this option is activated, all power safe modes that have an impact on real time processing are deactivated. Note that this is only effective for very low latencies, and that it increases the power consumption.

Disk Preload

Allows you to specify how many seconds of audio are preloaded into RAM prior to starting playback. This allows for smooth playback.

Adjust for Record Latency

If this option is activated, the plug-in latencies are taken into account during recording.

Record Shift

Allows you to shift the recordings by the specified value.

Volume Automation Precision

Allows you to set the number of samples after which a new volume automation event is processed. The automation curve between the processed events is interpolated. This smoothens transitions between automation events and prevents sudden jumps which may lead to crackles.

At the bottom of the page, the following options are available:

Reset

Sends a reset signal to the active ASIO device and restarts the audio processing. This can solve problems with audio playback.

NOTE

This leads to a short interruption of the playback.

Apply

Applies your settings on this page.

RELATED LINKS

[VST Plug-in Manager Window](#) on page 529

ASIO Driver Setup Page

This page allows you to set up your ASIO driver.

- To open the page where you can set up the ASIO driver, select **Studio > Studio Setup** and select the audio driver in the **Devices** list.

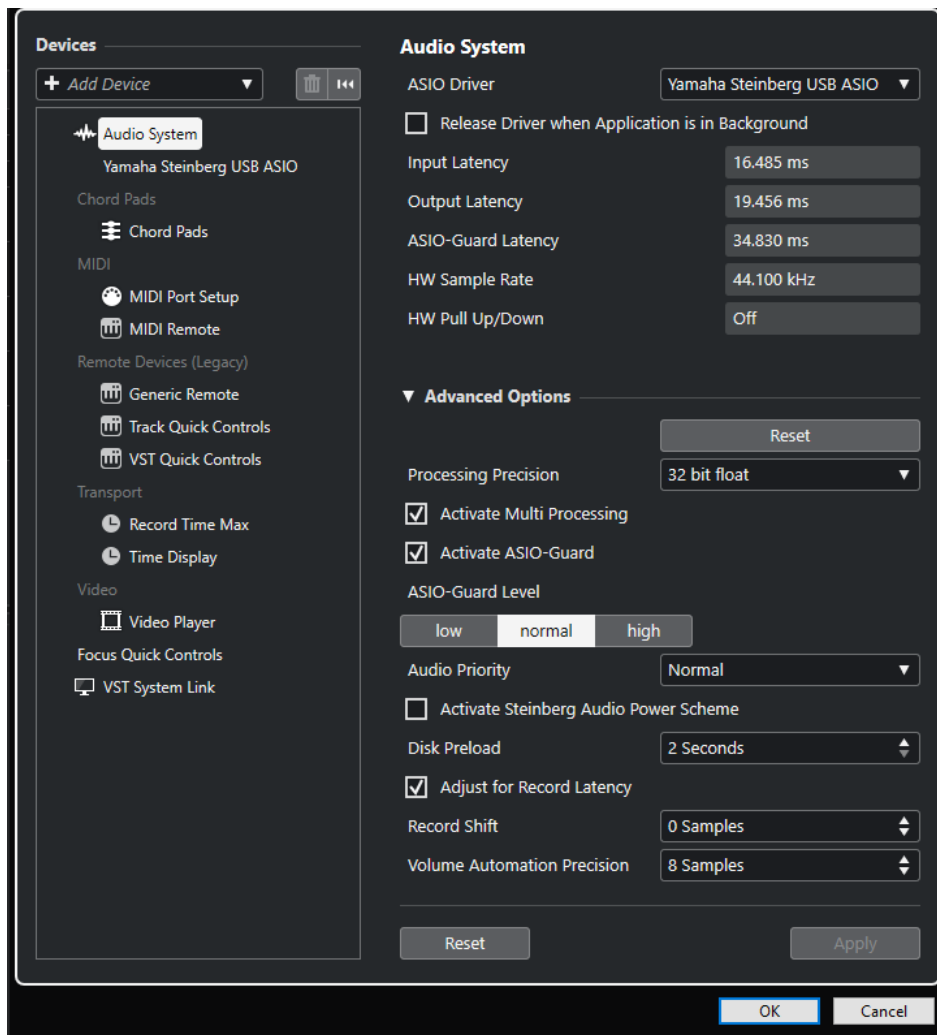

The following options are available:

Control Panel

Opens the control panel for the audio hardware.

Input Latency

Shows the input latency of the audio driver.

Output Latency

Shows the output latency of the audio driver.

Clock Source

Allows you to select a clock source.

Externally Clocked

Activate this option if you use an external clock source.

Direct Monitoring

Activate this option to monitor via your audio hardware and to control it from Cubase.

In the **Ports** section, the following options are available:

Reset

Allows you to restore the default port names and to enable the visibility for all ports.

I/O

The port input/output status.

Port System Name

The system name of the port.

Show As

Allows you to rename the port. This name is used in the **Input Routing** and **Output Routing** pop-up menus.

Visible

Allows you to activate/deactivate audio ports.

State

The state of the audio port.

At the bottom of the page, the following options are available:

Reset

Sends a reset signal to the active ASIO device and restarts the audio processing. This can solve problems with audio playback.

NOTE

This leads to a short interruption of the playback.

Apply

Applies your settings on this page.

Using External Clock Sources

If you use an external clock source, Cubase must be notified that it receives external clock signals and derives its speed from that source.

PROCEDURE

1. Select **Studio > Studio Setup**.
 2. In the **Devices** list, select your audio hardware driver.
 3. Activate **Externally Clocked**.
-

RESULT

Cubase now derives its speed from the external source.

NOTE

For proper audio playback and recording, you must set the sample rate of the project to the sample rate of the incoming clock signals.

When a sample rate mismatch occurs, the **Record Format** field on the **Project** window status line is highlighted in a different color. Cubase accepts a sample rate mismatch, and playback is therefore faster or slower.

Using Several Audio Applications Simultaneously

You can allow other applications to play back via your audio hardware even if Cubase is running.

PREREQUISITE

You have set other audio applications that access the audio hardware to release the audio driver.

PROCEDURE

1. Select **Studio > Studio Setup**.
 2. In the **Devices** list, select **Audio System**.
 3. Activate **Release Driver when Application is in Background**.
-

RESULT

The application that has the focus can access the audio hardware.

Audio Hardware Configuration

Most audio cards provide one or more small applications that allow you to customize your hardware.

The settings are normally gathered on a control panel that can be opened from within Cubase or separately, when Cubase is not running. For details, refer to the audio hardware documentation.

Settings include:

- Selecting which inputs/outputs are active.
- Setting up word clock synchronization.
- Turning on/off monitoring via the hardware.
- Setting levels for each input.
- Setting levels for the outputs so that they match the equipment that you use for monitoring.
- Selecting digital input and output formats.
- Making settings for the audio buffers.

Setting up Input and Output Ports

Once you have selected the driver for your audio hardware and have set it up, you must specify which inputs and outputs to use.

PREREQUISITE

You have selected a driver for your audio hardware.

PROCEDURE

1. Select **Studio > Studio Setup**.
 2. In the **Devices** list, select your audio hardware driver.
 3. Make your changes.
 4. Click **OK**.
-

RELATED LINKS

[ASIO Driver Setup Page](#) on page 18

Audio Bus Setup

Cubase uses a system of input and output busses to transfer audio between the program and the audio hardware.

- Input busses let you route audio from the inputs of your audio hardware into Cubase. This means that audio is always recorded through one or several input busses.
- Output busses let you route audio from Cubase to the outputs of your audio hardware. This means that audio is always played back through one or several output busses.

Once you have set up the internal input and output busses, you can connect your audio source, for example, a microphone, to your audio interface and start recording, playing back, and mixing.

RELATED LINKS

[Audio Connections](#) on page 28

Monitoring

In Cubase, monitoring means listening to the input signal while recording.

The following ways of monitoring are available:

- Externally by listening to the signal before it reaches Cubase.
- Via Cubase.
- By using ASIO Direct Monitoring.

This is a combination of the other methods.

RELATED LINKS

[External Monitoring](#) on page 215

[Monitoring via Cubase](#) on page 215

[ASIO Direct Monitoring](#) on page 216

Setting up MIDI

You must set up your MIDI equipment before you can use it in Cubase.

IMPORTANT

Turn off all equipment before making any connections.

PROCEDURE

1. Connect your MIDI equipment (keyboard, MIDI interface, etc.) to your computer.
 2. Install the drivers for your MIDI equipment.
-

RESULT

You can use your MIDI equipment in Cubase.

MIDI Connections

To play back and record MIDI data from your MIDI device, for example, a MIDI keyboard, you need to connect the MIDI ports.

Connect the MIDI output port of your MIDI device to the MIDI input port of your audio hardware. This way, the MIDI device sends MIDI data to be played back or recorded inside your computer.

Connect the MIDI input port of your MIDI device to the MIDI output port of your audio hardware. This way, you can send MIDI data from Cubase to the MIDI device. For example, you can record your own playing, edit the MIDI data in Cubase, and then play it back on the keyboard and record the audio that is coming out of the keyboard.

Showing or Hiding MIDI Ports

You can show the MIDI ports that you want to use and hide those that you do not use on the MIDI pop-up menus in the program.

PROCEDURE

1. Select **Studio > Studio Setup**.
 2. In the **Devices** list, select **MIDI Port Setup**.
 3. To hide a MIDI port, deactivate its **Visible** column.
 4. Click **OK**.
-

Setting up All MIDI Inputs

When you record MIDI, you can specify which MIDI input each recording MIDI track should use. However, you can also record any MIDI data from any MIDI input. For this to work, you must first set up which inputs are included when you select **All MIDI Inputs** for a MIDI track.

PROCEDURE

1. Select **Studio > Studio Setup**.
2. In the **Devices** list, select **MIDI Port Setup**.
3. Activate **In 'All MIDI Inputs'** for a port.

NOTE

If you have connected a MIDI remote control unit, make sure to deactivate the **In 'All MIDI Inputs'** option for that MIDI input. This avoids accidental recording of data from the remote control when **All MIDI Inputs** is selected as input for a MIDI track.

4. Click **OK**.
-

RESULT

When you select **All MIDI Inputs** on the **Input Routing** pop-up menu of a MIDI track in the **Inspector**, the MIDI track uses all MIDI inputs that you specified in the **MIDI Port Setup**.

MIDI Port Setup Page

The **MIDI Port Setup** page in the **Studio Setup** dialog displays the connected MIDI devices and allows you to set up their ports.

- To open the **MIDI Port Setup** page, select **Studio > Studio Setup** and activate **MIDI Port Setup** in the **Devices** list.

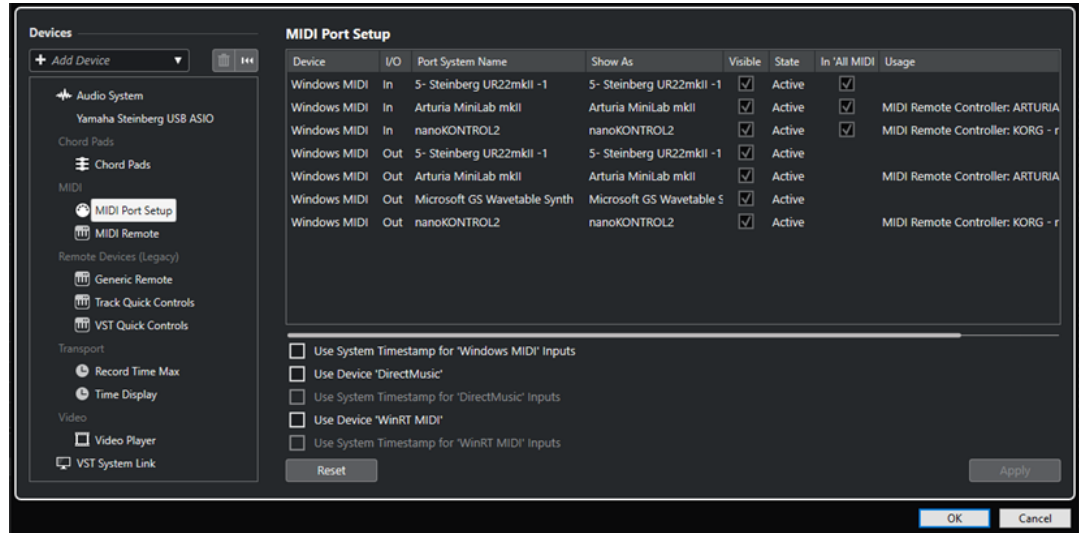

The following columns are displayed:

Device

The connected MIDI devices.

I/O

The port input/output status.

Port System Name

The system name of the port.

Show As

Allows you to rename the port. This name is used in the **Input Routing** and **Output Routing** pop-up menus.

Visible

Allows you to activate/deactivate MIDI ports.

State

The state of the MIDI port.

In 'All MIDI Inputs'

Allows you to record MIDI data from all MIDI inputs.

NOTE

Deactivate this option if you use remote control devices.

Usage

If you connect a MIDI controller and use it on the **MIDI Remote** tab in the lower zone of the **Project** window, the corresponding port **Usage** columns change to display the name of the connected controller. These ports are used for remote control only.

The following options are available:

Use System Timestamp for 'Windows MIDI' Inputs

Activate this option if you have persistent timing problems, such as shifted notes. If this is activated, the system timestamp is used as a time reference.

Use Device 'DirectMusic'

If you do not use a device with a DirectMusic device driver, you can leave this option deactivated. This enhances the system performance.

Use System Timestamp for 'DirectMusic' Inputs

Activate this option if you have persistent timing problems, such as shifted notes. If this is activated, the system timestamp is used as a time reference.

Use Device 'WinRT MIDI'

Activates the Windows **Runtime MIDI API, WinRT MIDI**, that allows for native support of bluetooth MIDI in Windows, better plug and play, and better handling of multiple identical devices.

If you have problems with bluetooth MIDI and plug and play, deactivate **Use Device 'WinRT MIDI'**, reconnect your bluetooth MIDI device, and activate **Use Device 'WinRT MIDI'** again.

Use System Timestamp for 'WinRT MIDI' Inputs

Activate this option if you have persistent timing problems, such as shifted notes. If this is activated, the system timestamp is used as a time reference.

At the bottom of the page, the following options are available:

Reset

Allows you to restore the default port names and to enable the visibility for all ports.

Apply

Applies your settings on this page.

Plug and Play Support for MIDI Devices

Cubase supports plug and play of USB MIDI devices. These devices can be plugged in and switched on while the application is running.

MIDI Remote Page

The **MIDI Remote** page in the **Studio Setup** dialog displays the connected MIDI controllers.

- To open the **MIDI Remote** page, select **Studio > Studio Setup** and activate **MIDI Remote** in the **Devices** list.

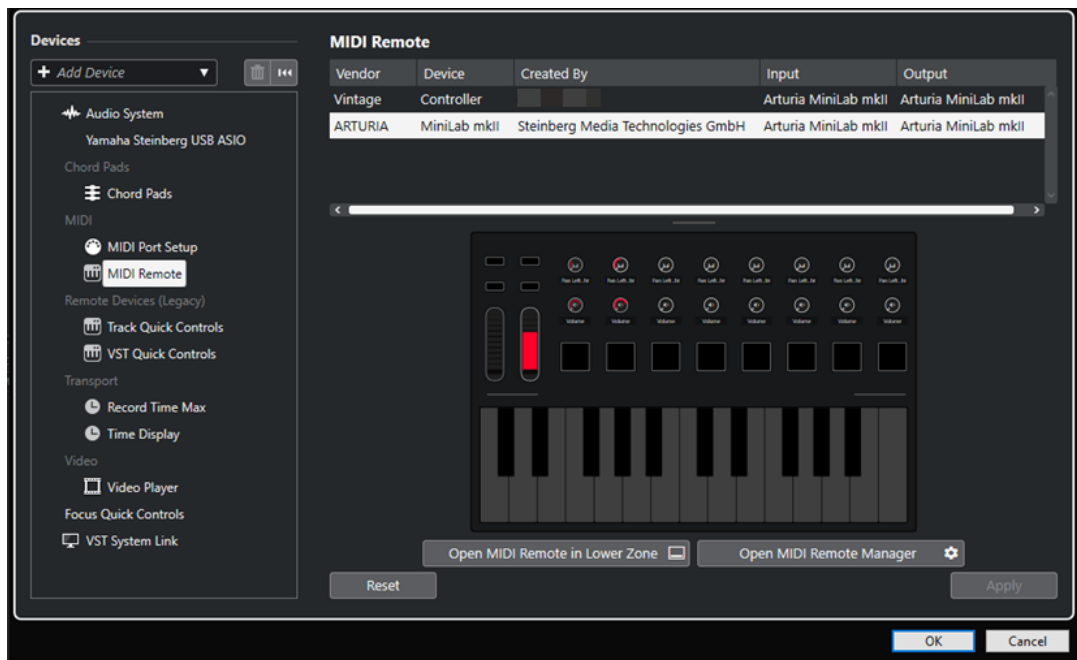

The following columns are displayed:

Vendor

Shows information about the vendor of the connected MIDI controller.

Device

The connected MIDI controller.

Created By

Shows information about the script creator for the connected MIDI controller.

Input

Shows the input port of your MIDI controller.

Output

Shows the output port of your MIDI controller.

Open MIDI Remote in Lower Zone

Opens the **MIDI Remote** tab in the lower zone of the **Project** window.

Open MIDI Remote Manager

Opens the **MIDI Remote Manager** that shows information about the connected MIDI controllers and the installed scripts.

At the bottom of the page, the following options are available:

Reset

Allows you to restore the default port names and to enable the visibility for all ports.

Apply

Applies your settings on this page.

RELATED LINKS

[MIDI Remote](#) on page 540

Synchronizers

When using Cubase with external tape transports, you must probably add a synchronizer to your system.

IMPORTANT

Make sure that all equipment is turned off before making any connections.

For information on how to connect and set up your synchronizer, refer to the documentation of your synchronizer.

RELATED LINKS

[Synchronization](#) on page 770

Audio Connections

To play back and record in Cubase, you must set up input and output busses in the **Audio Connections** window.

The bus types that you need depend on your audio hardware, on your general audio setup, and on the projects that you use.

Audio Connections Window

The **Audio Connections** window allows you to set up input and output busses.

- To open the **Audio Connections** window, select **Studio > Audio Connections**.

Inputs/Outputs Tab

The **Inputs** and **Outputs** tabs allow you to set up and configure input and output busses.

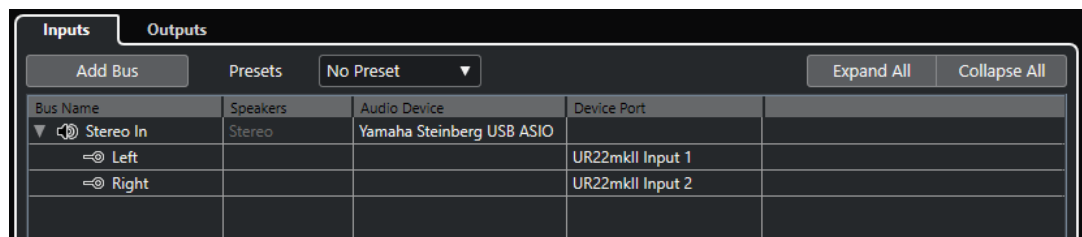

The following options are available above the bus list:

Add Bus

Opens the **Add Input Bus** dialog, where you can create a new bus configuration.

Presets

Opens the **Presets** pop-up menu, where you can select bus configuration presets. **Save Preset** allows you to save a bus configuration as preset. **Remove Preset** deletes the selected preset.

Expand All/Collapse

Expands/Collapses all busses in the bus list.

The following columns are available for the bus list:

Bus Name

Lists the busses. Click the name of a bus to select or rename it.

Speakers

Indicates the speaker configuration (mono, stereo) of each bus.

Audio Device

Shows the selected ASIO driver.

Device Port

Shows which physical inputs/outputs on your audio hardware are used by the bus. Expand the bus entry to show all speaker channels. If the bus entry is collapsed, only the first port that is used by this bus is visible.

The **Device Port** pop-up menu displays how many busses are connected to a given port. The busses are shown in square brackets next to the port name.

Up to three bus assignments can be displayed in this way. If more connections have been made, this is indicated by a number at the end of the port name.

For example, "Adat 1 [Stereo1] [Stereo2] [Stereo3] (+2)" means that the Adat1 port is already assigned to three stereo busses plus two additional busses.

Renaming the Hardware Inputs and Outputs

Before you set up busses, you should rename the default inputs and outputs of your audio hardware. This allows you to transfer projects between different computers and setups.

For example, if you move your project to another studio, the audio hardware may be of a different model. But if you and the other studio have agreed on identical names for your inputs and outputs, Cubase corrects inputs and outputs for your busses.

NOTE

If you open a project that was created on another computer and the port names do not match or the port configuration is not the same, the **Missing Ports** dialog appears. This allows you to manually re-route ports that are used in the project to ports on your computer.

PROCEDURE

1. Select **Studio > Studio Setup**.
 2. In the **Devices** list, select **Audio System**.
 3. Open the **ASIO Driver** pop-up menu and select your audio hardware driver.
 4. In the **Devices** list, select your audio hardware driver.
 5. In the **Show As** column, click on a port name and enter a new name.
 6. Repeat the previous step until you have renamed all required ports.
 7. Click **OK**.
-

RELATED LINKS

[Re-Routing Missing Ports](#) on page 92

Hiding Ports

You can hide ports that you are not using. Hidden ports are not displayed in the **Audio Connections** window.

PROCEDURE

1. Select **Studio > Studio Setup**.
 2. In the **Devices** list, select your audio hardware driver.
 3. In the **Visible** column, deactivate the ports that you want to hide.
 4. Click **OK**.
-

Activating and Deactivating Ports (macOS only)

On macOS, you can specify which input and output ports are active. This allows you to use the microphone input instead of the line input or to deactivate the audio card input or output.

NOTE

This function is only available for built-in audio, standard USB audio devices, and some other audio cards.

PROCEDURE

1. Select **Studio > Studio Setup**.
 2. In the **Devices** list, select your audio hardware driver.
 3. Click **Control Panel**.
 4. Activate/Deactivate ports.
 5. Click **OK**.
-

Adding Input and Output Busses

You must add input and output busses to establish the connection between your audio hardware and Cubase.

PROCEDURE

1. In the **Audio Connections** dialog, click the **Inputs** or **Outputs** tab.
 2. Click **Add Bus**.
 3. In the **Add Input Bus** dialog, configure the bus.
 4. Optional: Enter a name for the bus.
If you do not specify a name, the bus is named according to the channel configuration.
 5. Click **Add Bus**.
The new bus is added to the bus list.
 6. For each of the speaker channels in the bus, click in the **Device Port** column and select a port for your audio hardware.
-

Setting the Default Output Bus (Main Mix)

Main Mix is the default output bus to which each new audio, group, or FX channel is automatically routed. If only one bus is available, this bus is automatically used as the default output bus.

PREREQUISITE

Add an output bus.

PROCEDURE

1. In the **Audio Connections** dialog, right-click the output bus that you want to use as default output bus.
 2. Select **Set <bus name> as Main Mix**.
-

RESULT

The selected bus is used as the default bus. **Main Mix** is indicated by a speaker icon next to its name.

RELATED LINKS

[Inputs/Outputs Tab](#) on page 28

Presets for Input and Output Busses

For input and output bus configurations, you can use different kinds of presets.

- Standard bus configurations.
- Automatically created presets tailored to your specific hardware configuration.
On startup, Cubase analyzes the physical inputs and outputs that are provided by your audio hardware and creates a number of hardware-dependent presets.
- Your own presets.

NOTE

You can create default presets for input and output bus configurations. If you create a new empty project, these default presets are applied. To create default presets, save your preferred input and output bus configurations under the name **Default**. If you have not defined default presets, the last used input and output bus configuration is applied when you create a new empty project.

Saving a Bus Configuration Preset

You can save your own input and output bus configuration as presets.

PROCEDURE

1. Select **Studio > Audio Connections**.
 2. Click the **Inputs** or **Outputs** tab, and set up your bus configuration.
 3. Click **Store**.
 4. In the **Type in Preset Name** dialog, enter a name.
 5. Click **OK**.
-

RESULT

The preset is available in the **Presets** menu.

Deleting a Bus Configuration Preset

You can delete bus configuration presets that you no longer need.

PROCEDURE

1. Select **Studio > Audio Connections**.
 2. Click the **Inputs** or **Outputs** tab.
 3. From the **Presets** menu, select the preset that you want to delete.
 4. Click **Delete**.
-

RESULT

The preset is deleted.

Monitoring Bus

The default output bus (**Main Mix**) is used for monitoring. You can adjust the monitoring level in the **MixConsole**.

RELATED LINKS

[Setting the Default Output Bus \(Main Mix\)](#) on page 30

[MixConsole](#) on page 279

Bus Configurations

After you have set up all the required busses for a project, you can edit the names and change port assignments. The bus configuration is saved with the project.

Removing Busses

You can remove busses that you no longer need.

PROCEDURE

- In the **Audio Connections** window, do one of the following:
 - To remove a single bus, right-click the bus in the list and select **Remove Bus**.
Alternatively, you can select the bus and press **Backspace**.
 - To remove multiple input or output busses at the same time, use **Shift** or **Ctrl/Cmd** to select them in the list, right-click them, and select **Remove Selected Busses**.
-

Changing Port Assignments

You can change the port assignment of busses.

PROCEDURE

1. Select **Studio > Audio Connections**.
 2. Do one of the following:
 - To change the assignment of a single bus, open the **Device Port** pop-up menu, and select a new port.
 - To assign subsequent busses to several selected busses, open the **Device Port** pop-up menu for the first selected entry, press **Shift**, and select a device port.
 - To assign the same port to several selected busses, open the **Device Port** pop-up menu for the first selected entry, press **Shift - Alt/Opt**, and select a device port.
-

Renaming Multiple Busses

You can rename all the selected busses at once using incrementing numbers or letters.

PROCEDURE

1. Select **Studio > Audio Connections**.
2. Select the busses that you want to rename.
3. Do one of the following:
 - Enter a new name for one of the busses, followed by a number.
 - Enter a new name for one of the busses, followed by a space and a capital letter.
4. Press **Return**.

RESULT

The busses are renamed automatically, using either incrementing numbers or letters.

NOTE

The renaming starts from the bus where you edit the name and runs to the bottom. Then it continues from the top until all selected busses have been renamed.

Exclusive Port Assignments

For specific channel types, the port assignment is exclusive.

Once a port has been assigned to such a bus or channel, it must not be assigned to another bus. Otherwise, the connection to the first bus is broken.

The corresponding ports are marked in the **Audio Connections** window on the **Device Port** pop-up menu.

Project Window

The **Project** window provides an overview of the project, and allows you to navigate and perform large scale editing.

Each project has one **Project** window. The **Project** window is displayed whenever you open or create a new project.

- To open a project, select **File > Open**.
- To create a new project, select **File > New Project**.

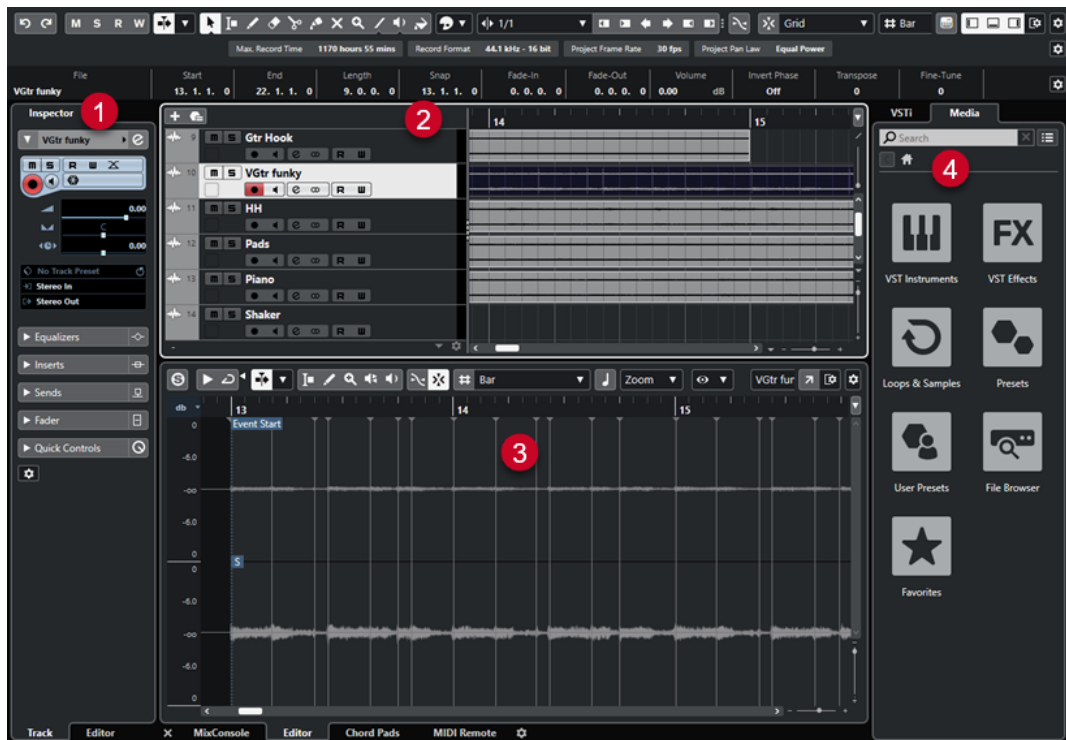

The **Project** window is divided into several zones:

1 Left Zone

The left zone shows the **Inspector** that features two tabs:

- The **Track** tab shows the settings for the track that is selected in the track list.

NOTE

In this documentation, we use **Inspector** to refer to the **Track** tab of the **Inspector**.

- The **Editor** tab shows the settings for the editor that is open in the lower zone.

2 Project Zone

The project zone shows the toolbar, the track list with the tracks, the event display with the parts and events of the project, and the **Project** window ruler.

On the toolbar, you can activate/deactivate the status line, the info line, the overview line, and the **Transport Bar**.

3 Lower Zone

The lower zone shows the **Chord Pads**, the **Editor**, the **Sampler Control**, the **MixConsole**, and **MIDI Remote**.

4 Right Zone

The right zone shows the **VSTi** rack, and the **Media** rack.

RELATED LINKS

[Project Zone](#) on page 35

[Left Zone](#) on page 47

[Lower Zone](#) on page 52

[Right Zone](#) on page 58

[Project Window Toolbar](#) on page 36

Showing/Hiding Zones

You can show/hide the zones in the **Project** window according to your needs.

PROCEDURE

- Do one of the following:
 - To show/hide the left zone, click **Show/Hide Left Zone** on the **Project** window toolbar.
 - To show/hide the lower zone, click **Show/Hide Lower Zone** on the **Project** window toolbar.
 - To show/hide the right zone, click **Show/Hide Right Zone** on the **Project** window toolbar.

NOTE

The project zone is always shown.

RELATED LINKS

[Project Window Toolbar](#) on page 36

Project Zone

The project zone is the heart of the **Project** window and cannot be hidden.

The project zone features the track list and the event display with the ruler. Furthermore, you can activate/deactivate the status line, the info line, the overview line, and the **Transport Bar** for the project zone.

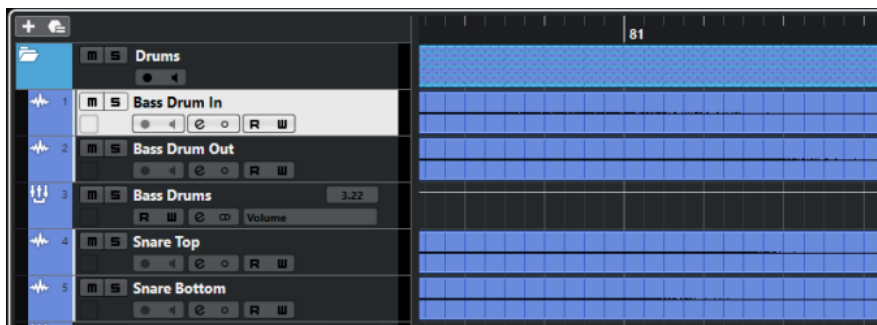

RELATED LINKS

- [Track List](#) on page 42
- [Event Display](#) on page 43
- [Global Track Controls](#) on page 43
- [Ruler](#) on page 44
- [Status Line](#) on page 46
- [Info Line](#) on page 46
- [Overview Line](#) on page 47
- [Transport Bar](#) on page 47

Project Window Toolbar

The toolbar contains tools and shortcuts for opening other windows and various project settings and functions.

- To show/hide tools, open the toolbar context menu by right-clicking in an empty area of the toolbar and activate the tools that you want to display. To show all tools, select **Show All**.

NOTE

The number of elements that are shown also depends on the size of the **Project** window and the screen resolution.

The following options are available:

Activate Project



NOTE

Only available if more than one project is open.

Activates a project.

Project History

Undo/Redo



Undoes/Redoes actions in the **Project** window.

Constrain Delay Compensation

Constrain Delay Compensation



Minimizes the latency effects of the delay compensation.

Left Divider

Left Divider

Tools that are placed to the left of the divider are always shown.

Media & MixConsole Windows

Open MediaBay



Opens/Closes the **MediaBay**.

Open Pool Window



Opens/Closes the **Pool** window.

Open MixConsole



Opens/Closes the **MixConsole**.

State Buttons

Deactivate All Mute States



Deactivates all mute states.

Deactivate All Solo States



Deactivates all solo states.

Activate/Deactivate Read for All Tracks



Activates/Deactivates read automation for all tracks.

Activate/Deactivate Write for All Tracks



Activates/Deactivates write automation for all tracks.

Auto-Scroll

Auto-Scroll



Keeps the project cursor visible during playback.

Select Auto-Scroll Settings



Allows you to activate **Page Scroll** or **Stationary Cursor** and to activate **Suspend Auto-Scroll When Editing**.

Locators

Go to Left Locator Position



Allows you to go to the left locator position.

Left Locator Position

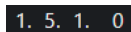

Shows the left locator position.

Go to Right Locator Position



Allows you to go to the right locator position.

Right Locator Position

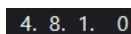

Shows the right locator position.

Transport Controls

Go to Previous Marker/Zero



Moves the project cursor to the previous marker/zero position on the timeline.

Go to Next Marker/Project End



Moves the project cursor to the next marker/project end.

Rewind



Moves backward.

Forward



Moves forward.

Activate Cycle



Activates/Deactivates cycle mode.

Stop



Stops playback.

Start



Starts playback.

Transport Record



Activates/Deactivates record mode.

Tool Buttons

Object Selection



Selects events and parts.

Range Selection



Selects ranges.

Draw



Draws events.

Erase



Erases events.

Split



Splits events.

Glue



Glues events together.

Mute



Mutes events.

Zoom



Zooms in. Hold **Alt/Opt** and click to zoom out.

Line



Creates a series of contiguous events.

Play



Allows you to play back events.

Color



Allows you to colorize events.

Color Menu

Select Color for Selected Tracks or Events



Opens the **Colorize** pane that allows you to colorize the selected tracks or events.

Nudge

Nudge Start Left



Increases the length of the selected event by moving its start to the left.

Nudge Start Right



Decreases the length of the selected event by moving its start to the right.

Move Left



Moves the selected event to the left.

Move Right



Moves the selected event to the right.

Nudge End Left



Decreases the length of the selected event by moving its end to the left.

Nudge End Right



Increases the length of the selected event by moving its end to the right.

Snap

Snap to Zero Crossing



Restricts editing to zero crossings, that is, positions where the amplitude is zero.

Snap On/Off



Restricts horizontal movement and positioning to the positions specified by the **Snap Type**.

Snap Type



Allows you to specify to what positions you want events to snap.

Grid Type

Grid Type



Allows you to specify a grid type for the **Snap** function. This setting only has effect if **Snap Type** is set to one of the grid options.

Quantize

Apply Quantize



Applies the quantize settings.

Quantize Presets



Allows you to select a quantize preset.

Soft Quantize On/Off



Activates/Deactivates soft quantize.

Open Quantize Panel



Opens the **Quantize Panel**.

Audio Performance Meter

Audio Performance Meter

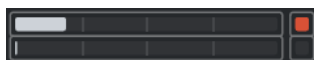

The upper bar displays either the current realtime peak or the ASIO-Guard load, depending on which of the two has the higher value. The lower bar shows the hard disk transfer load of the disk engine.

For a more detailed display of realtime peak and ASIO-Guard load, click to open the **Audio Performance** window.

MIDI Remote Mapping Assistant

Open MIDI Remote Mapping Assistant



Opens the **MIDI Remote Mapping Assistant**.

Right Divider

Right Divider

Tools that are placed to the right of the divider are always shown.

Window Zone Controls

Show/Hide Left Zone



Shows/Hides the left zone of the window.

Show/Hide Lower Zone



Shows/Hides the lower zone of the window.

Show/Hide Right Zone



Shows/Hides the right zone of the window.

Set up Window Layout



Allows you to set up the window layout.

Set up Toolbar

Set up Toolbar



Opens a pop-up menu where you can set up which toolbar elements are visible.

RELATED LINKS

[Left/Right Toolbar Divider](#) on page 42

[Snap Types Menu](#) on page 68

[Markers](#) on page 270

[Automation](#) on page 500

[Synchronization](#) on page 770

Left/Right Toolbar Divider

The left and right toolbar dividers allow you to lock the position of specific tools at the left or at the right side of the toolbar, so that they are always shown.

All other items are shown in the center of the toolbar. When you reduce the width of the **Project** window, these toolbar items are hidden successively. When you increase the width, they are shown again.

Toolbox

The toolbox makes the editing tools from the toolbar available at the mouse pointer position. It can be opened instead of the standard context menus in the event display and editors.



- To activate the toolbox function, activate **Show Toolbox on Right-Click** in the **Preferences** dialog (**Editing—Tools** page).
- To open the toolbox, right-click in the event display or editor.
If **Show Toolbox on Right-Click** is deactivated, the context menu opens.
- To open the context menu instead of the toolbox, press any modifier key and right-click in the event display or editor.
If **Show Toolbox on Right-Click** is deactivated, press any modifier key to open the toolbox instead of the context menu.

Track List

The track list shows the tracks that are used in the project. When a track is added and selected, it contains name fields and settings for this track.

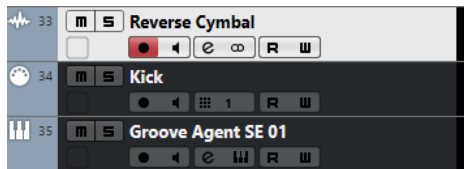

- To decide which controls are visible for each track type, right-click the track list and open the **Track Controls Settings** dialog.

RELATED LINKS

[Track Controls Settings Dialog](#) on page 99

Dividing the Track List

You can divide the track list into an upper track list and a lower track list. These track lists can have independent zoom and scroll controls. Dividing the track list is useful if you are working with a video track and multi-track audio, for example. It allows you to place the video track in the upper track list and to scroll the audio tracks separately in the lower track list, so that they can be arranged with the video.

PROCEDURE

- Do one of the following:
 - Select **Project > Divide Track List**.
 - Click **Divide Track List** in the top right corner of the **Project** window below the ruler.

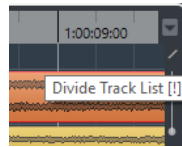

RESULT

The track list is divided, and video, marker, or arranger tracks are automatically moved to the upper track list. All other track types are moved to the lower track list.

NOTE

The area of the project zone that has the focus is indicated by a highlighted and solid focus frame, whereas the non-active area is shown with a dashed frame.

AFTER COMPLETING THIS TASK

- To move any type of track from the lower track list to the upper track list and vice versa, right-click it in the track list and select **Toggle Track List** from the context menu.
- To resize the upper part of the track list, click and drag the divider between the track list sections.
- To revert to a single track list, click **Divide Track List** again.

RELATED LINKS

[Keyboard Focus in the Project Window](#) on page 63

Event Display

The event display shows the parts and events that are used in the project. They are positioned along the timeline.

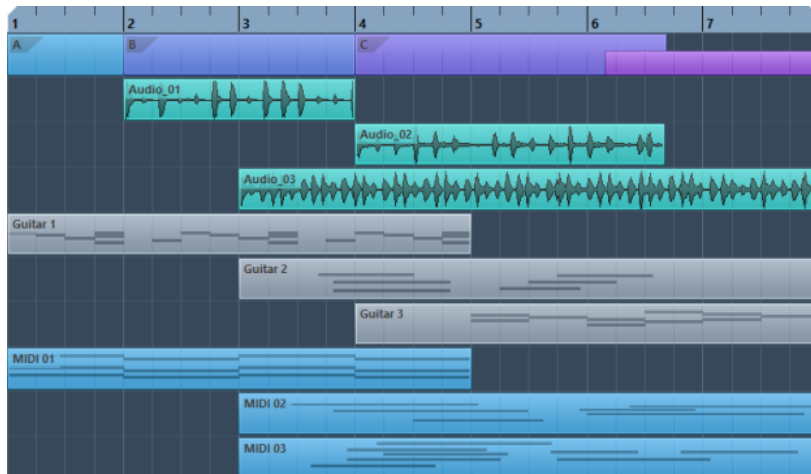

Global Track Controls

The global track controls allow you to manage the tracks in the track list.

- The global track controls are shown above the track list.



- 1 Add Track**
Opens the **Add Track** dialog.
- 2 Use Track Preset**
Allows you to add a track using a track preset.

Ruler

By default, the ruler shows the timeline and the display format of the project.



Initially, the **Project** window ruler uses the display format that is specified in the **Project Setup** dialog.

However, you can select an independent display format for the ruler.

- To select an independent display format for the ruler, click the arrow button to the right of the ruler and select an option from the pop-up menu, or right-click anywhere in the ruler.

The ruler settings affect the ruler, the info line, and the tooltip position values.

You can also select independent formats for other rulers and position displays.

NOTE

To set the display format globally for all windows, use the **Display Format** pop-up menu in the **Project Setup** dialog or the **Select Primary Time Format** pop-up menu on the **Transport** panel, or hold down **Ctrl/Cmd** and select a format in any ruler.

RELATED LINKS

[Project Setup Dialog](#) on page 88

[Ruler Modes](#) on page 45

[Selecting the Primary Time Format](#) on page 201

Ruler Display Format Menu

You can select a display format for the ruler.

- To show the ruler display formats, click the arrow button to the right of the ruler.

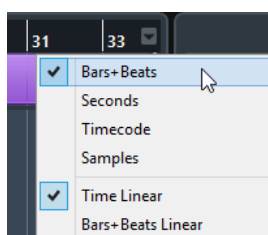

The selection that you make affects the time display formats in the following areas:

- Ruler
- Info line
- Tooltip position values

The following options are available:

Bars+Beats

Sets the ruler to display bars, beats, sixteenth notes, and ticks. By default, there are 120 ticks per sixteenth note. To change this, adjust the **MIDI Display Resolution** setting in the **Preferences** dialog (**MIDI** page).

Seconds

Sets the ruler to display hours, minutes, seconds, and milliseconds.

Timecode

Sets the ruler to display hours, minutes, seconds, and frames. You can set the number of frames per second (fps) via the **Project Frame Rate** pop-up menu in the **Project Setup** dialog. To display subframes, activate **Show Timecode Subframes** in the **Preferences** dialog (**Transport** page).

Samples

Sets the ruler to display samples.

RELATED LINKS

[Ruler Modes](#) on page 45

Ruler Modes

By default, the ruler follows the primary time format, that is, the display format that you set up in the **Project Setup** dialog or on the **Transport**. The ruler modes, however, allow you to set up a display format for the ruler that differs from the display format in the main time display.

- To show the ruler modes, click the arrow button to the right of the ruler.

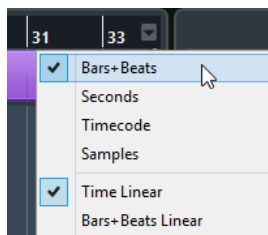

Time Linear

Sets the ruler relative to the time. If there are tempo changes on the **Tempo** track, the distance between the bars varies in **Bars+Beats** mode.

Bars+Beats Linear

Sets the ruler relative to the meter position, that is, bars and beats. If there are tempo changes on the **Tempo** track, the distance between the bars remains the same in **Bars+Beats** mode. If the ruler is set to a time-based mode, the distance between seconds varies depending on the tempo changes.

RELATED LINKS

[Editing Tempo and Time Signature](#) on page 748

[Ruler Display Format Menu](#) on page 44

[Project Setup Dialog](#) on page 88

[Selecting the Primary Time Format](#) on page 201

Status Line

The status line shows the most important project settings.

- To activate the status line, click **Set up Window Layout** on the toolbar and activate **Status Line**.

The following information is shown on the status line:

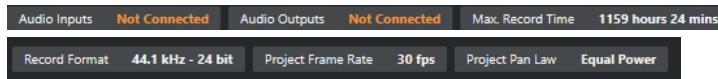

Audio Inputs/Audio Outputs

These fields are shown if the audio device ports are not connected. Click to open the **Audio Connections** dialog and connect the ports.

Max. Record Time

Displays the remaining time for recording, depending on your project settings and the available hard disk space. Click to display the remaining record time in a separate window.

Record Format

Displays the sample rate and the bit depth used for recording. Click to open the **Project Setup** dialog.

Project Frame Rate

Displays the frame rate used in the project. Click to open the **Project Setup** dialog.

Project Pan Law

Displays the current pan law setting. Click in this field to open the **Project Setup** dialog.

RELATED LINKS

[Project Window Toolbar](#) on page 36

Info Line

The info line shows information about the event or part that you selected in the project zone.

Name	Start	End	Length	Offset	Mute	Transpose	Velocity
Groove Agent ONE 01	9. 1. 1. 0	11. 1. 1. 0	2. 0. 0. 0	-1. 1. 2. 69	-	0	0

To activate the info line, click **Set up Window Layout** on the toolbar and activate **Info Line**.

RELATED LINKS

[Project Window Toolbar](#) on page 36

Value Editing Rules on the Info Line

On the info line you can edit almost all event or part data using regular value editing.

If you select several events or parts, the information on the info line is shown in another color and only. In this case, only information about the first item in the selection is displayed. The following rules apply:

- Value changes are applied to all selected elements, relative to the current values.

Example: You have selected two audio events. The first event has a length of 1 bar, the second event has a length of 2 bars. If you change the info line value to 3, the first event is resized to 3 bars and the second event is resized to 4 bars.

- Value changes are applied absolute to the current values if you press **Ctrl/Cmd** while modifying the value on the info line.

In the example above, both events are resized to 3 bars.

NOTE

To change the modifier, select a new modifier in the **Info Line** category of the **Preferences** dialog (**Editing—Tool Modifiers** page).

Overview Line

The overview line allows you to zoom and to navigate to other sections in the project.

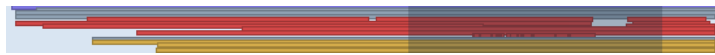

To activate the overview line, click **Set up Window Layout** on the toolbar and activate **Overview**.

On the overview line, events and parts are displayed as boxes. A rectangle indicates the section of the project that is displayed in the event display.

- To zoom the event display in or out horizontally, resize the rectangle by dragging the edges.
- To navigate to another section of the event display, drag the rectangle to the left or to the right, or click in the upper part of the overview.

RELATED LINKS

[Project Window Toolbar](#) on page 36

Transport Bar

The **Transport Bar** displays the transport functions in an integrated and fixed zone of the **Project** window.

- To activate the **Transport Bar**, click **Set up Window Layout** on the **Project** window toolbar and activate **Transport Bar**.
- To show/hide tools, open the **Transport Bar** context menu by right-clicking in an empty area of the **Transport Bar**, and activate the tools that you want to display. To show all tools, select **Show All**.

RELATED LINKS

[Common Record Modes Menu](#) on page 214

[Audio Record Modes](#) on page 219

[MIDI Record Modes](#) on page 226

[Left/Right Toolbar Divider](#) on page 42

[Project Window Toolbar](#) on page 36

Left Zone

The left zone of the **Project** window allows you to display the **Inspector**.

To show/hide the left zone, click **Show/Hide Left Zone** on the **Project** window toolbar.

- **Inspector**

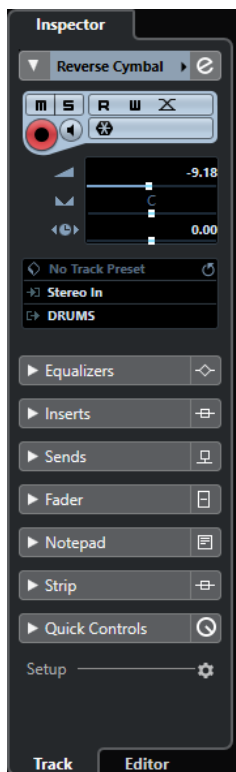

RELATED LINKS

[Inspector](#) on page 48

[Project Window Toolbar](#) on page 36

Inspector

The **Inspector** displays controls and parameters for either the selected track in the track list or the event or part that is displayed in the editor in the lower zone.

- To show/hide the **Inspector**, click **Show/Hide Left Zone** in the **Project** window toolbar.

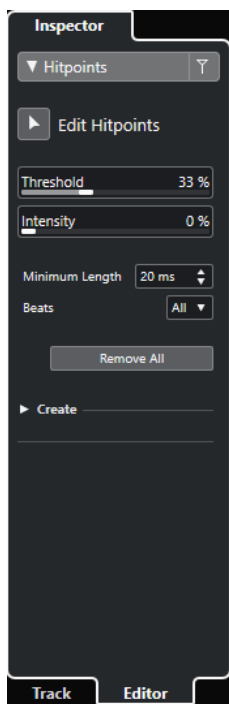

The following tabs are available:

Track

Opens the **Track Inspector** for the selected track.

Editor

Opens the **Editor Inspector** for the event or part that is shown in the editor in the lower zone.

RELATED LINKS

[Opening the Track Inspector](#) on page 49

[Opening the Editor Inspector](#) on page 50

[Opening the Editor in the Lower Zone](#) on page 55

Opening the Track Inspector

The **Track Inspector** shows controls and parameters for the selected track in the track list.

PROCEDURE

1. If the **Left Zone** is not visible, click **Show/Hide Left Zone** on the **Project** window toolbar to activate it.
2. At the bottom of the left zone, click the **Track** tab.

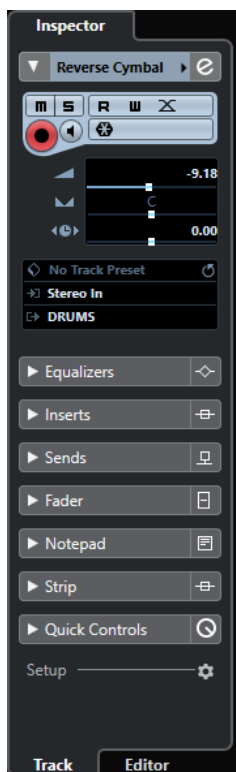

RESULT

The **Track Inspector** for the selected track opens. If more than one track is selected in the track list, the controls and parameters for the topmost selected track are shown.

NOTE

In this documentation, we use **Inspector** to refer to the **Track** tab of the **Inspector**.

Opening the Editor Inspector

The **Editor Inspector** shows controls and parameters for the event or part that is displayed in the editor in the lower zone.

PREREQUISITE

The **Sample Editor**, the **Audio Part Editor**, the **Key Editor**, the **Drum Editor**, or the **Score Editor** is shown in the lower zone.

PROCEDURE

1. If the left zone is not visible, click **Show/Hide Left Zone** on the **Project** window toolbar to activate the **Left Zone**.
2. At the bottom of the left zone, click the **Editor** tab.

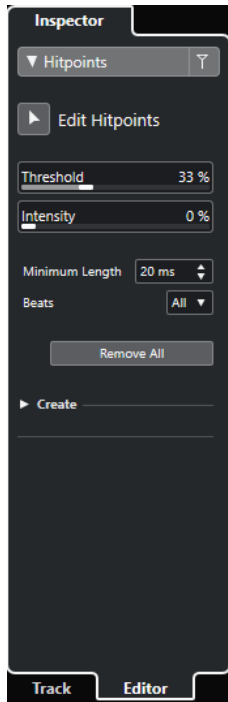

RESULT

The **Editor Inspector** for the event or part opens.

NOTE

The **Editor Inspector** only contains information if an editor is displayed in the lower zone. Otherwise, it is empty.

RELATED LINKS

[Opening the Editor in the Lower Zone](#) on page 55

Inspector Sections

The **Track** tab and the **Editor** tab of the **Inspector** are divided into sections that each contain different controls for the track, event or part.

Not all **Inspector** sections are shown by default. The available sections depend on the type of the selected track, event, or part and on the settings in the setup dialog for the **Track** tab and the **Editor** tab of the **Inspector**.

- To open/close sections, click their names.
If you open one section the other sections are closed.
- To open a section without closing the other sections, **Ctrl/Cmd**-click the section name.

RELATED LINKS

[Track Inspector Settings Dialog](#) on page 97

[Inspector Sections](#) on page 98

[Audio Track Inspector](#) on page 107

[Instrument Track Inspector](#) on page 110

[MIDI Track Inspector](#) on page 116

[Sampler Track Inspector](#) on page 113

[Arranger Track Inspector](#) on page 130

[Marker Track Inspector](#) on page 134
[Video Track Inspector](#) on page 134
[Key Editor Inspector](#) on page 652
[Drum Editor Inspector](#) on page 693
[Sample Editor Inspector](#) on page 387

Lower Zone

The lower zone of the **Project** window allows you to display specific windows and editors in an integrated and fixed zone of the **Project** window. This is useful if you work on single screen systems and notebooks, for example.

To show/hide the lower zone, click **Show/Hide Lower Zone** on the **Project** window toolbar.

The lower zone features the following tabs: **Chord Pads**, **MixConsole**, **Sampler Control**, **MIDI Remote**, and **Editor**.

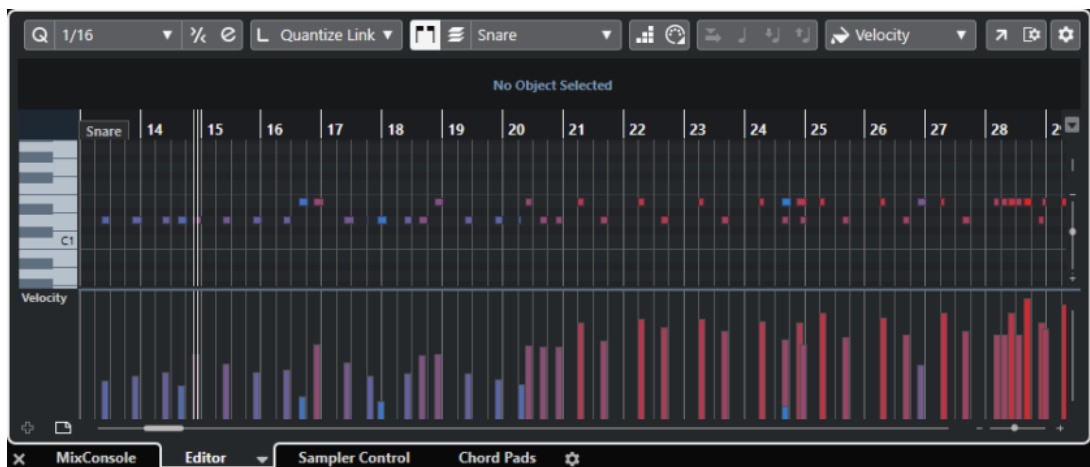

To close the lower zone, click **Close Lower Zone**  to the left of the tabs.

RELATED LINKS

[Opening Chord Pads](#) on page 53
[Opening the MixConsole in the Lower Zone](#) on page 54
[Opening Sampler Control](#) on page 54
[Opening the Editor in the Lower Zone](#) on page 55
[Opening MIDI Remote in the Lower Zone](#) on page 57
[Project Window Toolbar](#) on page 36

Setting up the Lower Zone

The lower zone shows the **Chord Pads**, the **Editor**, the **Sampler Control**, the **MixConsole**, and **MIDI Remote**. You can change the order of the tabs, and you can hide tabs that you do not need.

PROCEDURE

1. Click **Set up Lower Zone** in the bottom right of the lower zone.



2. Do one of the following:

- Activate/Deactivate the options in the pop-up menu to show/hide tabs in the lower zone.
- Select **Setup** to open a dialog where you can activate/deactivate the tabs and change their position.

NOTE

In the **Presets** section of this dialog, you can also save a preset of your configuration.

RESULT

The tabs in the lower zone are shown, according to your configuration.

RELATED LINKS

[Setup Dialog](#) on page 818

Opening Chord Pads

Chord Pads allow you to play with chords and to change their voicings and tensions.

PROCEDURE

1. Click **Show/Hide Lower Zone** on the **Project** window toolbar to activate the lower zone.
2. At the bottom of the lower zone, click the **Chord Pads** tab.

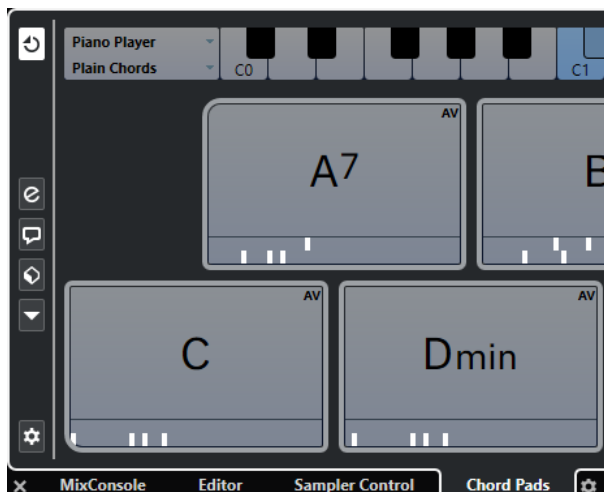

RESULT

The **Chord Pads** are opened.

RELATED LINKS

[Chord Pads](#) on page 726

[Setting up the Lower Zone](#) on page 52

[Project Window Toolbar](#) on page 36

Opening the MixConsole in the Lower Zone

The **MixConsole** in the lower zone allows you to perform all basic mixing procedures from within the lower zone of the **Project** window. At the same time, you see the context of your tracks and events.

PROCEDURE

1. Click **Show/Hide Lower Zone** on the **Project** window toolbar to activate the lower zone.
2. At the bottom of the lower zone, click the **MixConsole** tab.

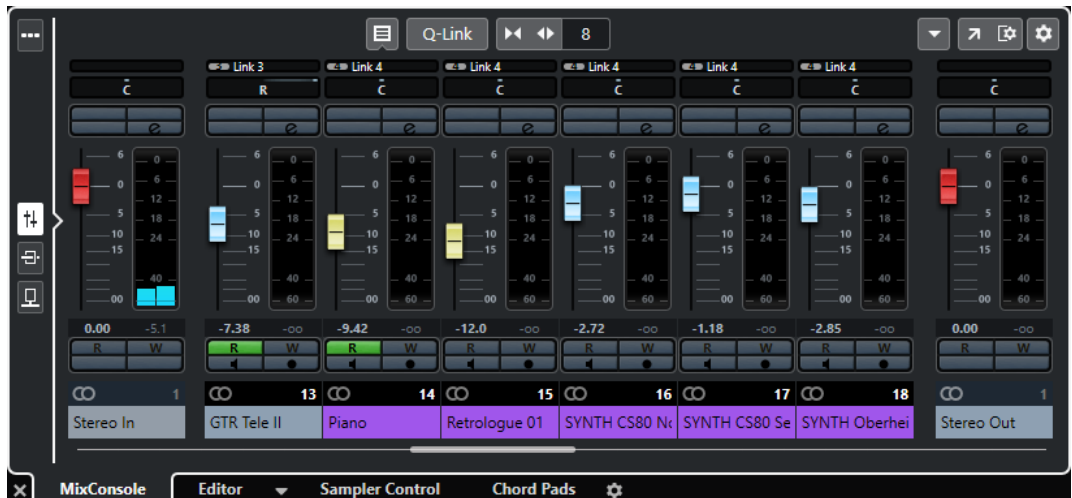

RESULT

The **MixConsole** is displayed in the lower zone.

RELATED LINKS

[MixConsole in Lower Zone](#) on page 279

[Project Window Toolbar](#) on page 36

Opening Sampler Control

Sampler Control allows you to display and edit the waveform of an audio sample on a sampler track.

PROCEDURE

1. Click **Show/Hide Lower Zone** on the **Project** window toolbar to activate the lower zone.
2. At the bottom of the lower zone, click the **Sampler Control** tab.



RESULT

Sampler Control is opened.

RELATED LINKS

[Sampler Tracks](#) on page 421

[Project Window Toolbar](#) on page 36

Opening the Editor in the Lower Zone

The **Editor** in the lower zone allows you to perform event editing procedures from within the lower zone of the **Project** window. At the same time, you see the context of your tracks and events.

NOTE

By default, double-clicking an audio event/part or a MIDI part in the event display or selecting it and pressing **Return** opens the corresponding editor in the lower zone of the **Project** window. Using a menu command opens a separate editor window. You can change this in the **Preferences** dialog (**Editors** page).

PROCEDURE

1. Click **Show/Hide Lower Zone** on the **Project** window toolbar to activate the lower zone.
2. At the bottom of the lower zone, click the **Editor** tab.
3. In the event display, do one of the following:
 - Select a MIDI part.
 - Select an audio event.
 - Select an audio part.

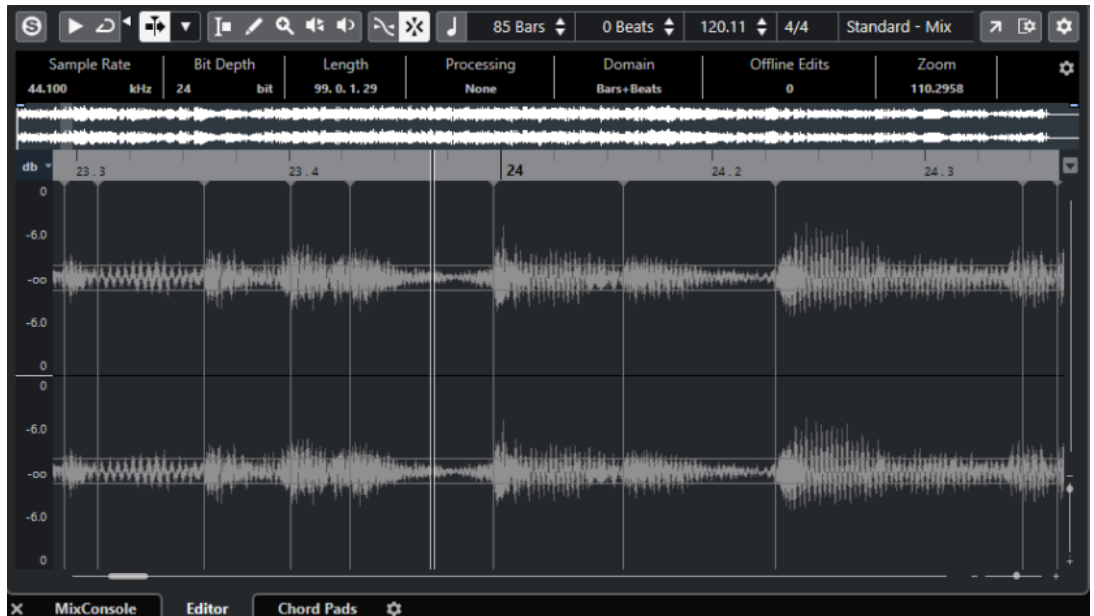

RESULT

Depending on your event or part selection, the lower zone shows either the **Audio Part Editor**, the **Sample Editor**, or one of the MIDI editors.

NOTE

To change the default MIDI editor, select **MIDI > Set up Editor Preferences**, and select an option from the **Default MIDI Editor** pop-up menu.

NOTE

If you open the editor and no event or part is selected, the editor in the lower zone is empty.

RELATED LINKS

[Selecting a different MIDI Editor](#) on page 56
[Project Window Toolbar](#) on page 36

Selecting a different MIDI Editor

You can display the MIDI part that is opened in the editor in the lower zone in a different MIDI editor. You can do this without changing the default MIDI editor.

PROCEDURE

1. On the **Editor** tab in the editor in the lower zone, click **Select MIDI Editor**.
2. Select an editor from the pop-up menu.

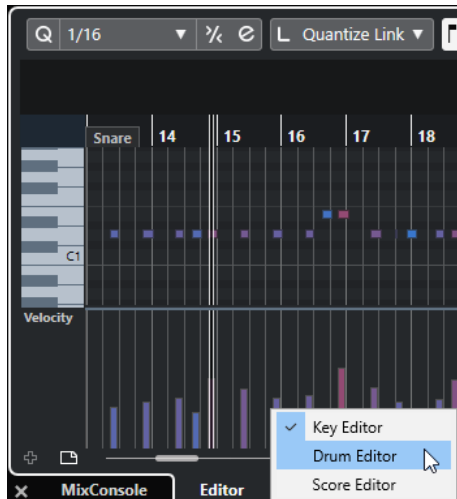

RESULT

The MIDI part is displayed in the selected editor.

NOTE

This selection is temporary. The next time you open the MIDI part, the default MIDI editor is used.

Opening MIDI Remote in the Lower Zone

The **MIDI Remote** tab in the lower zone of the **Project** window allows you to load scripts for MIDI remote controllers. It shows a visual representation of the actual physical controller and its control mappings to Cubase parameters.

PROCEDURE

1. If the lower zone is not visible, click **Show/Hide Lower Zone** on the **Project** window toolbar to activate the lower zone.
2. At the bottom of the lower zone, click the **MIDI Remote** tab.



RESULT

The **MIDI Remote** tab is opened in the lower zone.

NOTE

The **MIDI Remote** tab is not a clickable user interface. All operations are meant to be performed on the connected MIDI controller.

RELATED LINKS

[MIDI Remote](#) on page 540

Right Zone

The right zone of the **Project** window allows you to display the **VSTi** rack and the **Media** rack.

To show/hide the right zone, click **Show/Hide Right Zone** on the **Project** window toolbar.

The top of the right zone features the following tabs: **VSTi** and **Media**.

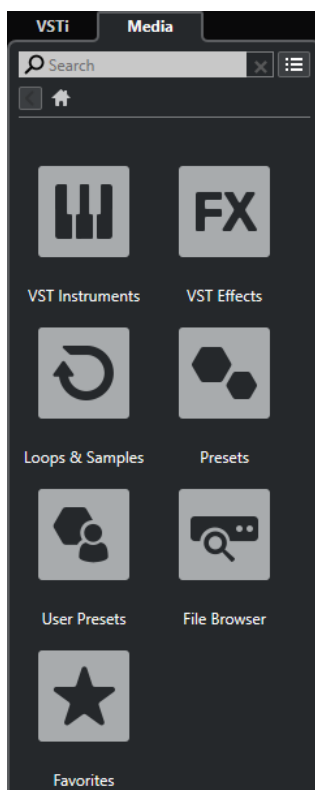

NOTE

You can show/hide specific tabs in the right zone by right-clicking a tab and activating/deactivating the options in the context menu.

RELATED LINKS

[VSTi Rack in the Right Zone](#) on page 59

[Media Rack in the Right Zone](#) on page 62

[Project Window Toolbar](#) on page 36

Opening the VSTi Rack in the Right Zone

You can open the **VSTi** rack in the right zone of the **Project** window. This allows you to add and edit VST instruments, and, at the same time, to see the context of your tracks and events.

PROCEDURE

1. Click **Show/Hide Right Zone** on the **Project** window toolbar to activate the **Right Zone**.
2. At the top of the right zone, click the **VSTi** tab.



RESULT

The **VSTi** rack is opened in the right zone of the **Project** window.

RELATED LINKS

[VSTi Rack in the Right Zone](#) on page 59

[VST Instruments](#) on page 510

[Project Window Toolbar](#) on page 36

VSTi Rack in the Right Zone

The **VSTi** rack in the right zone of the **Project** window allows you to add and edit VST instruments in the context of the **Project** window.

The following sections are available:

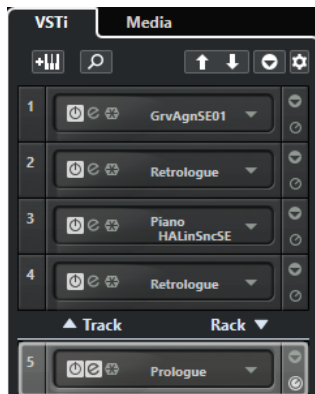

- **Track**
Shows the associated VST instrument for an instrument track.
- **Rack**
Shows a VST instrument.

The following controls are available:

Add Track Instrument



Opens the **Add Track** dialog that allows you to select an instrument and to add an instrument track that is associated with this instrument.

Find Instruments



Opens a selector that allows you to find a loaded instrument.

Set Remote-Control Focus for VST Quick Controls to Previous Instrument



Allows you to set the remote control focus to the previous instrument.

Set Remote-Control Focus for VST Quick Controls to Next Instrument



Allows you to set the remote control focus to the next instrument.

Show/Hide all VST Quick Controls



Shows/Hides the default quick controls for all loaded instruments.

Settings



Opens the **Settings** pop-up menu, where you can activate/deactivate the following modes:

- **Show VST Quick Controls for One Slot Only** shows the **VST Quick Controls** exclusively for the selected instrument.
- **MIDI Channel follows track selection** ensures that the **Channel** selector follows the MIDI track selection in the **Project** window. Use this mode if you work with multitimbral instruments.
- **Remote-Control Focus for VST Quick Controls follows track selection** ensures that the **VST Quick Controls** remote control focus follows the track selection.

RELATED LINKS

[VST Instruments Window](#) on page 515

Opening the Media Rack in the Right Zone

You can show the **Media** rack in the right zone of the **Project** window. This allows you to see the context of your tracks and events when you drag audio events, MIDI parts, presets, or instruments into the **Project** window.

PROCEDURE

1. Click **Show/Hide Right Zone** on the **Project** window toolbar to activate the **Right Zone**.
2. At the top of the right zone, click the **Media** tab.

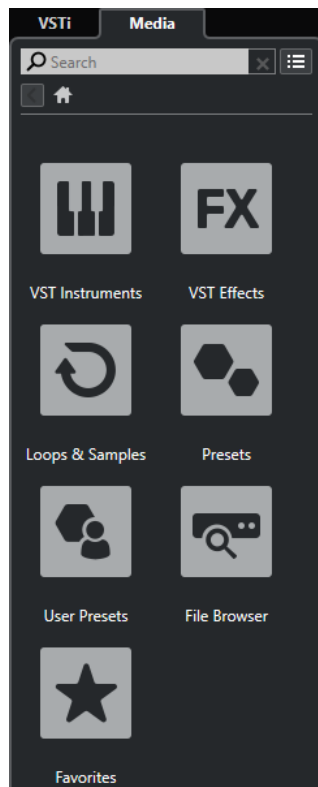

RESULT

The **Media** rack is opened in the right zone of the **Project** window.

RELATED LINKS

[Media Rack in the Right Zone](#) on page 62

[MediaBay and Media Rack](#) on page 466

[Project Window Toolbar](#) on page 36

Media Rack in the Right Zone

The **Media** rack in the right zone of the **Project** window allows you to drag audio events, MIDI parts, or instrument presets into the event display. It lists Steinberg factory content and any installed Steinberg content sets.

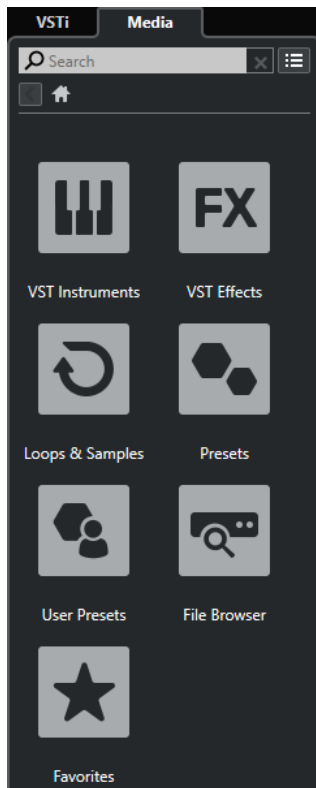

The **Media** rack **Home** tab displays the following tiles:

VST Instruments

Shows all included VST instruments.

VST Effects

Shows all included VST effects.

Loops & Samples

Shows audio loops, MIDI loops, or instrument sounds ordered by content set.

Presets

Shows the track presets, strip presets, FX chain presets, and VST FX presets.

User Presets

Shows track presets, strip presets, pattern banks, FX chain presets, VST FX presets, and instrument presets that are listed in the **User** folder.

Favorites

Shows your favorite folders and allows you to add new favorites. The favorites are automatically added to the **MediaBay** database.

File Browser

Shows your file system and the pre-defined folders **Favorites**, **This Computer**, **VST Sound**, **Factory Content**, and **User Content** where you can search for media files and access them immediately.

RELATED LINKS

[Media Rack in Right Zone](#) on page 466

[MediaBay and Media Rack](#) on page 466

Keyboard Focus in the Project Window

The different zones in the **Project** window can be controlled by key commands. For this to work, you must set the keyboard focus to the zone that you want to control by key commands.

The following **Project** window zones can have the keyboard focus:

- Project zone

NOTE

If you activate **Divide Track List**, the area of the project zone that has the focus is indicated by a highlighted and solid focus frame, whereas the non-active area is shown with a dashed frame.

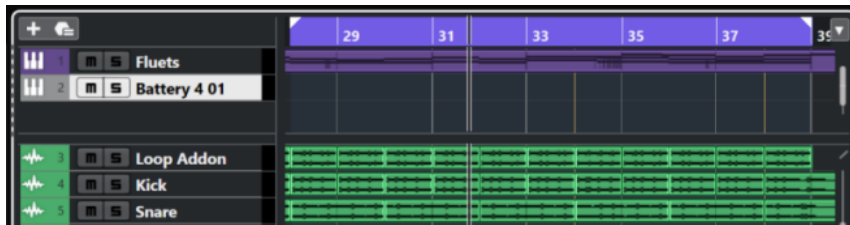

- Left zone
- Lower zone
- Right zone

If a zone has the keyboard focus, the border that surrounds it is highlighted in a specific color.

NOTE

You can change the focus color in the **Preferences** dialog (**User Interface—Color Schemes** page).

RELATED LINKS

[Project Zone](#) on page 35

[Left Zone](#) on page 47

[Lower Zone](#) on page 52

[Right Zone](#) on page 58

[Project Window](#) on page 34

[Dividing the Track List](#) on page 42

Activating Keyboard Focus for a Zone

You can activate the keyboard focus for a zone via mouse-click or key commands.

PROCEDURE

- Do one of the following:
 - To activate any zone, click in it.

- To activate the next zone, press **Tab**. This allows you to move forward through the zones.
- To activate the previous zone, press **Shift - Tab**.

NOTE

The editor in the lower zone automatically gets the keyboard focus if you double-click an event or part in the event display, if you select an event or part and press **Return**, or if you use key commands to open the zone.

RESULT

The keyboard focus is activated for this zone and the border of the zone is highlighted.

NOTE

The project zone and the lower zone have separate toolbars and info lines. If you use the toolbar or the info line for one of these zones, the corresponding zone automatically gets the focus.

RELATED LINKS

[Keyboard Focus in the Project Window](#) on page 63

Zooming in the Project Window

To zoom in the **Project** window, use the standard zoom techniques.

NOTE

If screen redraws are slow on your system, activate **Quick Zoom** in the **Preferences** dialog (**Editing** page).

Zooming Horizontally

- Select the **Zoom** tool and click in the event display to zoom in. To zoom out, hold down **Alt/Opt** and click.
- Use the horizontal zoom sliders to zoom in and out.
- Click the lower half of the ruler and drag down to zoom in horizontally. Click the lower half of the ruler and drag up to zoom out horizontally.
- Click **H** to zoom in horizontally. Click **G** to zoom out horizontally.

NOTE

If the **Grid Type** in the **Project** window toolbar is set to **Adapt to Zoom**, the horizontal zoom level affects the grid and snap resolution in the event display.

Zooming Vertically

- Select the **Zoom** tool, click in the event display, and drag a selection rectangle to zoom in vertically and horizontally.

NOTE

For this to work, you must deactivate the **Zoom Tool Standard Mode: Horizontal Zooming Only** option in the **Preferences** dialog (**Editing—Tools** page).

- Use the vertical zoom sliders to zoom in and out. If you have made any individual track height adjustments, the relative height differences are maintained.
- Click **Shift - H** to zoom in vertically. Click **Shift - G** to zoom out vertically.

RELATED LINKS

[Zoom Submenu](#) on page 65

[Zoom Presets](#) on page 66

[Zooming in on Cycle Markers](#) on page 67

[Zoom History](#) on page 67

[Grid Type Menu](#) on page 70

Zooming in on Audio Contents

You can zoom in vertically on the contents of audio parts and events. This is useful when viewing quiet audio passages.

PROCEDURE

- Click the waveform zoom slider in the top right corner of the event display and drag up.

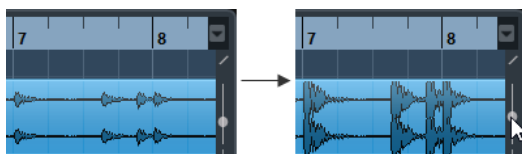

RESULT

The contents of audio parts and events in your project are zoomed in vertically.

AFTER COMPLETING THIS TASK

To get an approximate reading on the level of the audio events by viewing the waveforms, zoom out by dragging the slider all the way down again. Otherwise, zoomed waveforms may be mistaken for clipped audio.

Zoom Submenu

The **Zoom** submenu contains options for zooming in the **Project** window.

- To open the **Zoom** submenu, select **Edit > Zoom**.

The following options are available:

Zoom In/Zoom Out

Zooms in/out one step, centering on the project cursor.

Zoom Full

Zooms out so that the whole project is visible. The whole project means the timeline from the project start to the length set in the **Project Setup** dialog.

Zoom to Selection

Zooms in horizontally and vertically so that the current selection fills the screen.

Zoom to Selection (Horiz.)

Zooms in horizontally so that the current selection fills the screen.

Zoom to Event

Zooms in to show the currently selected event. This option is available in the **Sample Editor** and in some MIDI editors.

Zoom In Vertically/Zoom Out Vertically

Zooms in/out one step vertically.

Zoom In Tracks/Zoom Out Tracks

Zooms the selected tracks in/out one step vertically.

Zoom Selected Tracks

Zooms in vertically on the selected tracks and minimizes the height of all other tracks.

Undo Zoom/Redo Zoom

These options allow you to undo/redo the last zoom operation.

RELATED LINKS

[Zoom Submenu](#) on page 390

Zoom Presets

You can create zoom presets to set up different zoom settings. For example, you can create a zoom preset that displays the entire project and a second zoom preset with a high zoom factor for detailed editing. The **Zoom Presets** pop-up menu allows you to select, create, and organize zoom presets.

- To open the **Zoom Presets** pop-up menu, click the button to the left of the horizontal zoom control.

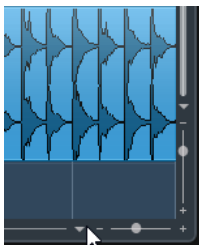

The upper part of the menu lists the zoom presets.

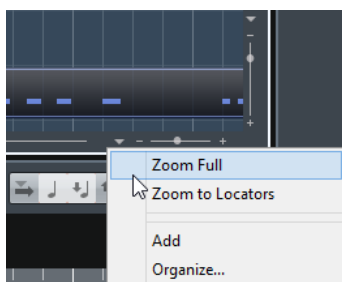

- To save the current zoom setting as a preset, open the **Zoom Presets** pop-up menu and select **Add**. In the **Type in Preset Name** dialog that opens, type in a name for the preset and click **OK**.
- To apply a preset, select it from the **Zoom Presets** pop-up menu.
- To display the entire project, open the **Zoom Presets** pop-up menu and select **Zoom Full**.

This displays the project from the **Project Start Time** to the **Project Length**, as set in the **Project Setup** dialog.

- To delete a preset, open the **Zoom Presets** pop-up menu and select **Organize**. In the dialog that opens, select the preset in the list and click **Delete**.
- To rename a preset, open the **Zoom Presets** pop-up menu and select **Organize**. In the dialog that opens, select a preset from the list and click **Rename**. Type in a new name for the preset. Click **OK** to close the dialogs.

IMPORTANT

Once set, zoom presets are available for all projects that you open or create.

Zooming in on Cycle Markers

You can zoom in on the area between cycle markers in the project.

PREREQUISITE

You have created at least one cycle marker for the project.

PROCEDURE

- Click the button to the left of the horizontal zoom control to open the **Zoom Presets** pop-up menu, and select a cycle marker.

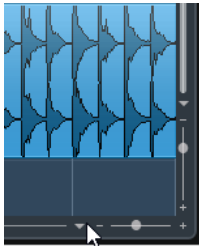

The middle part of the pop-up menu lists any cycle markers that you have added to the project.

RESULT

The event display is zoomed in to encompass the marker area.

RELATED LINKS

[Markers Window](#) on page 271

Zoom History

You can undo and redo zoom operations. This enables you to zoom in several steps and then easily go back to the zoom stage at which you started.

You can undo and redo zoom operations in the following ways:

- To undo zoom, select **Edit > Zoom > Undo Zoom** or double-click with the zoom tool.
- To redo zoom, select **Edit > Zoom > Redo Zoom** or press **Alt/Opt** and double-click with the zoom tool.

Snap Function

The **Snap** function helps you to find exact positions when editing in the **Project** window. It does this by restricting horizontal movement and positioning to certain positions. Operations affected by **Snap** include moving, copying, drawing, sizing, splitting, range selection, etc.

- To activate/deactivate **Snap**, activate/deactivate **Snap**  on the toolbar.

Setting the Snap Point

You can set the snap point at any position of the audio event.

PROCEDURE

1. Select an event.
2. Position the project cursor within the selected audio event.
3. Select **Audio > Snap Point to Cursor**.

RESULT

The snap point is set at the cursor position. The snap point for an event is displayed as a vertical line in the **Project** window.

NOTE

You can also set the snap point in the **Sample Editor**.

RELATED LINKS

- [Adjusting the Snap Point](#) on page 397
- [Snap Point](#) on page 396

Snap to Zero Crossing

Splitting and resizing of audio events can lead to sudden amplitude changes that might cause pops and clicks. To avoid this, activate **Snap to Zero Crossing** to snap to points where the amplitude is zero.

- To activate **Snap to Zero Crossing**, activate **Snap to Zero Crossing**  on the toolbar.

Snap Types Menu

You can select between different snap types to determine the snap point.

- To open the **Snap Type** pop-up menu, click **Snap Type**  on the toolbar.

The following snap types are available:

Grid

The snap points are set with the **Grid Type** pop-up menu. The options depend on the primary time format.

If you select **Seconds** as ruler format, time-based grid options are available.

If you select **Bars+Beats** as ruler format, musical grid options are available.

Grid Relative

Events and parts are not magnetic to the grid. Rather, the grid determines the step size for moving the events. This means that a moved event keeps its original position relative to the grid.

For example, if an event starts at the position 3.04.01, with **Snap** set to **Grid Relative** and **Grid Type** set to **Bar**, you can move the event in steps of one bar to the positions 4.04.01, 5.04.01, and so on.

NOTE

This only applies to dragging existing events or parts. When you create new events or parts, this **Snap Type** works like **Grid**.

Events

If this option is activated, the start and end positions of other events and parts become magnetic. This means that, if you drag an event to a position near the start or the end of another event, it is automatically aligned with the start or end of the other event.

For audio events, the position of the snap point is also magnetic. This includes marker events on the marker track.

Shuffle

Shuffle is useful when you want to change the order of adjacent events. If you have two adjacent events and drag the first one to the right, past the second event, the two events change places.



The same principle works when changing the order of more than two events.

Cursor

This grid type causes the project cursor to become magnetic. Dragging an event near the cursor causes the event to be aligned with the cursor position.

Grid + Cursor

This is a combination of **Grid** and **Cursor**.

Events + Cursor

This is a combination of **Events** and **Cursor**.

Events + Grid + Cursor

This is a combination of **Events**, **Grid**, and **Cursor**.

RELATED LINKS

[Selecting the Primary Time Format](#) on page 201

Grid Type Menu

Allows you to specify a grid type that determines the grid and snap resolution in the event display.

NOTE

This setting only has an effect if **Snap Type** is set to one of the grid options.

- To open the **Grid Type** pop-up menu, click **Grid Type**  on the toolbar.

If you select **Bars+Beats** as display format, the following grid types are available:

Bar

Sets the grid and snap resolution to bars.

Beat

Sets the grid and snap resolution to beats.

Use Quantize

Sets the grid and snap resolution to the value that is activated in the **Quantize Presets** pop-up menu.

Adapt to Zoom

Sets the grid and snap resolution to the horizontal zoom level. The more you zoom in on the event display, the finer the resolution. High zoom levels allow you to snap to 64th notes, low zoom levels allow you to snap to bars.

NOTE

Adapt to Zoom is only available if **Bars+Beats** is set as ruler display format.

NOTE

You can assign key commands to the grid types in the **Key Commands** dialog in the **Edit** category.

If you select **Seconds** as the display format, the following grid types are available:

1 ms

Sets the grid and snap resolution to 1 ms.

10 ms

Sets the grid and snap resolution to 10 ms.

100 ms

Sets the grid and snap resolution to 100 ms.

1000 ms

Sets the grid and snap resolution to 1000 ms.

If you select **Timecode** as the display format, the following grid types are available:

Subframe

Sets the grid and snap resolution to 1 subframe.

1/4 frame

Sets the grid and snap resolution to ¼ frame.

1/2 frame

Sets the grid and snap resolution to ½ frame.

1 frame

Sets the grid and snap resolution to 1 frame.

2 frames

Sets the grid and snap resolution to 2 frames.

1 second

Sets the grid and snap resolution to 1 second.

NOTE

If you activate this as a display format and **Show Timecode Subframes** is activated in the **Preferences** dialog (**Transport** page), the frames will also display subframes. There are 80 subframes per frame.

If you select **Samples** as the display format, the following grid types are available:

1 sample

Sets the grid and snap resolution to 1 sample.

10 samples

Sets the grid and snap resolution to 10 samples.

100 samples

Sets the grid and snap resolution to 100 samples.

44100 samples

Sets the grid and snap resolution to 44100 samples.

RELATED LINKS

[Snap Types Menu](#) on page 68

[Zooming in the Project Window](#) on page 64

[Ruler Display Format Menu](#) on page 44

Snap Grid

In the **Project** window, and in some of the editors, you can have events, parts, and ranges snap to the grid.

The grid is based on the following settings:

- **Primary time format**
You can set the primary time format on the **Transport** panel.
- **Snap Type**
You can select the **Snap Type** on the **Project** window toolbar.
- **Grid Type**
You can select the **Grid Type** on the **Project** window toolbar.

The **Snap Type** pop-up menu allows you to determine if the events snap to the grid, to other events, or to the cursor.

NOTE

If you want your events to snap to the grid while you are editing, select one of the grid-related snap types, **Grid** or **Grid Relative**.

If you selected one of the grid-related snap types, the **Grid Type** pop-up menu on the **Project** window toolbar defines what the events snap to. The values that are shown depend on the primary time format:

- If you select **Bars+Beats** as a primary time format, you can select **Bar** or **Beat** as the **Grid Type** to snap your events to bars or beats. If you activate **Use Quantize** as the **Grid Type**, your events snap to the value that you set up in the **Quantize Presets** pop-up menu. If you activate **Adapt to Zoom** as the **Grid Type**, snapping depends on the zoom level.
- You can select **Seconds**, **Timecode**, or **Samples** as a primary time format to have your events snap to time positions.

You can also set up a different grid in the following editors:

- **Key Editor**
- **Drum Editor**
- **Audio Part Editor**
- **Sample Editor**

NOTE

In the **Project** window and in the editors, the grid is represented by vertical grid lines in the event display. You can change the overlay intensity of the displayed grid lines by raising the **Grid Overlay Intensity** in the **Preferences** dialog (**Event Display** page).

RELATED LINKS

- [Snap Function](#) on page 68
- [Project Setup Dialog](#) on page 88
- [Ruler](#) on page 44
- [Snap Types Menu](#) on page 68
- [Ruler Modes](#) on page 45
- [Selecting the Primary Time Format](#) on page 201
- [Grid Type Menu](#) on page 70

Cross-Hair Cursor

The cross-hair cursor is displayed when working in the **Project** window and in the editors, facilitating navigation and editing, especially for large projects.

- You can set up the cross-hair cursor in the **Preferences** dialog (**Editing—Tools** page).
You can set up the colors for the line and the mask of the cross-hair cursor and define their width.

The cross-hair cursor works as follows:

- When the **Object Selection** tool or one of its subtools is selected, the cross-hair cursor appears when you start moving/copying a part/event, or when using the event handles.



Cross-hair cursor when moving an event.

- When the **Object Selection** tool, the **Split** tool, or any other tool that makes use of this function is selected, the cross-hair cursor appears as soon as you move the mouse over the event display.
- The cross-hair cursor is only available for particular tools. The **Mute** tool, for example, does not use a cross-hair cursor, as you click on an event to mute it.

Edit History Dialog

The **Edit History** dialog contains a list of all your edits. This allows you to undo any actions in the **Project** window as well as in the editors.

- To open the **Edit History** dialog, select **Edit > History**.

#	Action	Time	State	Details
1	Move Selected Tracks	9:20:59 AM	Executed	Track: Edit 1
2	Move Selected Tracks	9:21:11 AM	Executed	Track: Drums
3	Move Selected Tracks	9:21:19 AM	Executed	Track: Intro Pad

Action

Shows the name of the action.

Time

Shows the time when this action was performed.

State

Shows the state of the action.

Details

Shows further details, and allows you to enter new text.

Separator

Move the separator upwards to undo your actions. To redo an action, move the separator down.

NOTE

- You can also undo applied audio processes. However, we recommend to use **Direct Offline Processing** window to modify or delete plug-in effects or audio processes.

RELATED LINKS

[Direct Offline Processing](#) on page 358

Setting the Number of Maximum Undo Steps

You can limit the number of maximum undo steps. This is useful if you run out of memory, for example.

PROCEDURE

1. In the **Preferences** dialog, select **General**.
 2. Set the number in the **Maximum Undo Steps** field.
-

Color Handling

You can colorize events and tracks in Cubase. This contributes to an easier overview in the **Project** window.

RELATED LINKS

- [Color Picker](#) on page 80
- [Project Colors Setup Dialog](#) on page 77
- [Event Colors Menu](#) on page 615
- [Setting Event Colors to Track Colors](#) on page 77
- [Colorizing Events on the Fly](#) on page 76
- [Colorizing Selected Events or Parts](#) on page 76
- [Resetting the Track Color](#) on page 76
- [Colorizing Single Tracks](#) on page 75
- [Colorizing Selected Tracks](#) on page 74
- [Color Handling](#) on page 74
- [User Interface - Track & MixConsole Channel Colors](#) on page 847
- [Automatically Assigning Colors to New Tracks/Channels](#) on page 140

Colorizing Selected Tracks

You can colorize selected tracks.

PROCEDURE

1. In the **Project** window, deselect all events or parts.
2. Select the tracks that you want to colorize.
3. On the **Project** window toolbar, select **Select Color for Selected Tracks or Events**.
The **Colorize** pane opens.

NOTE

If you want to select colors by names, activate the **Select Colors by Name** option in the **Project Colors Setup** dialog (**Options** page).

4. Select a color.
-

RESULT

The selected tracks are colorized, and the events and parts get the track color.

NOTE

If you assign a different color to individual events or parts with the **Color** tool, events or parts no longer follow color changes of the track.

RELATED LINKS

[Colorizing Events on the Fly](#) on page 76

[Options Tab](#) on page 80

Colorizing Single Tracks

You can colorize single tracks via the **Inspector** or the track list. This is useful if you want to ensure that no other tracks, events, or parts are colorized accidentally.

PROCEDURE

1. Do one of the following:

- Select the track that you want to colorize, and, in the **Inspector**, click **Colorize Selected Track**.

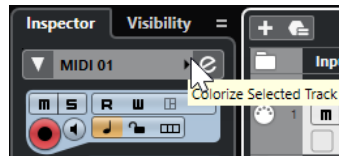

- **Ctrl/Cmd**-click the left area of the track list.

The **Colorize** pane opens.

NOTE

If you want to select colors by names, activate the **Select Colors by Name** option in the **Project Colors Setup** dialog (**Options** page).

2. Select a color.

RESULT

The track is colorized, and any events or parts on that track get the same color.

NOTE

If you assign a different color to individual events or parts with the **Color** tool, they no longer follow color changes of the track.

RELATED LINKS

[Colorizing Events on the Fly](#) on page 76

[Options Tab](#) on page 80

Resetting the Track Color

You can reset the color of a track to the default color.

PROCEDURE

1. In the **Project** window, select the track that you want to reset to the default color, and deselect all events or parts.
 2. On the **Project** window toolbar, select **Select Color for Selected Tracks or Events**.
 3. In the **Colorize** pane, click **Set Track Color to Default**.
-

RESULT

The default color is assigned to the selected track.

Colorizing Selected Events or Parts

You can colorize selected events or parts with **Select Color for Selected Tracks or Events**. By default, events or parts follow the color of the corresponding track. However, you can overwrite this setting and, for example, select the same color for events or parts that reside on different tracks.

PROCEDURE

1. In the **Project** window, select all events or parts that you want to colorize.
2. On the **Project** window toolbar, select **Select Color for Selected Tracks or Events**.
The **Colorize** pane opens.

NOTE

If you want to select colors by names, activate the **Select Colors by Name** option in the **Project Colors Setup** dialog (**Options** page).

3. Select a color.
-

RESULT

The selected events are colorized and no longer follow the color changes of the track.

RELATED LINKS

[Colorizing Events on the Fly](#) on page 76

[Options Tab](#) on page 80

[Event Colors Menu](#) on page 615

Colorizing Events on the Fly

You can colorize events or parts with the **Color** tool. By default, events or parts follow the color of the corresponding track. However, you can overwrite this setting and, for example, select the same color for events or parts that reside on different tracks.

PROCEDURE

1. In the **Project** window toolbar, select the **Color** tool.
2. Do one of the following to select a tool color:
 - **Alt/Opt**-click an event or part to copy its color.

- Move the mouse pointer over the **Color** tool, and use the mouse wheel to step through the colors of the current color set.
3. Optional: Select the events or parts that you want to colorize with the **Object Selection** tool. This is only necessary if you want to colorize multiple events or parts.
 4. On the **Project** window toolbar, select the **Color** tool.
 5. Click the events or parts that you want to colorize.
-

RESULT

The events or parts are colorized and no longer follow color changes of the track.

NOTE

You can also **Ctrl/Cmd**-click an event or part with the **Color** tool to open the **Colorize** pane or to select colors by names.

RELATED LINKS

[Colorizing Selected Events or Parts](#) on page 76

[Options Tab](#) on page 80

[Event Colors Menu](#) on page 615

Setting Event Colors to Track Colors

You can set the color of events or parts to the track color. This is useful if you previously colorized events or parts with the **Color** tool and you want them to follow the track color again.

PROCEDURE

1. In the **Project** window, select the event or part that you want to set to the track color.
 2. On the **Project** window toolbar, click **Select Color for Selected Tracks or Events**.
 3. In the **Colorize** pane, click **Set Event Color to Track**.
-

RESULT

The track color is assigned to the selected event or part.

RELATED LINKS

[Colorizing Events on the Fly](#) on page 76

[Event Colors Menu](#) on page 615

Project Colors Setup Dialog

The **Project Colors Setup** dialog allows you to set up colors for your project.

- To open the **Project Colors Setup** dialog, select **Project > Project Colors Setup**.

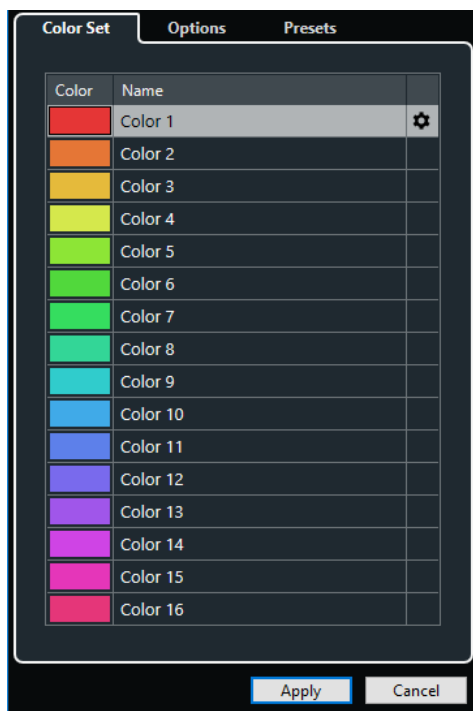

RELATED LINKS

[Color Picker](#) on page 80

[Color Set Tab](#) on page 78

[Presets Tab](#) on page 79

[Options Tab](#) on page 80

Color Set Tab

The **Color Set** tab allows you to change the color set that is used in the project.

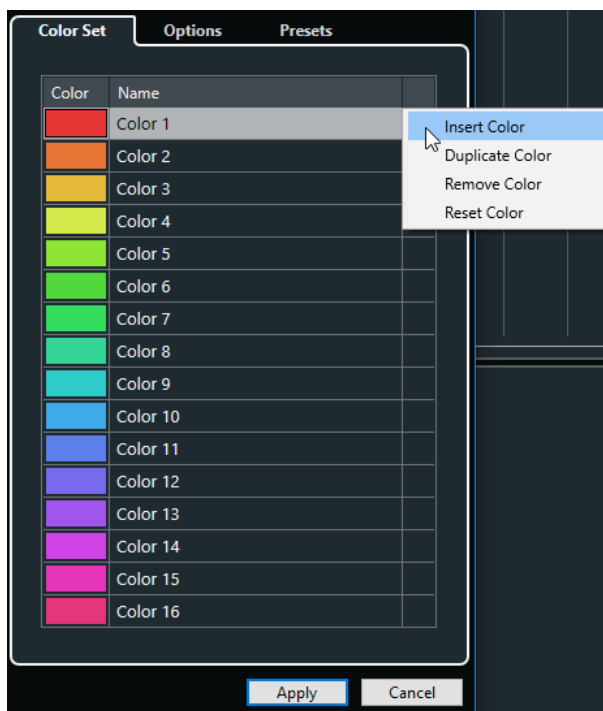

The following options are available:

Color fields

Click a field to open the **Color Picker** and specify a new color.

Name

Shows the name of the color. Double-click to change it.

Set up

Allows you to add or remove color fields.

- **Insert Color**
Adds a new color field.
- **Duplicate Color**
Duplicates the selected color field.
- **Remove Color**
Removes the selected color field.
- **Reset Color**
Resets the selected color field to the factory settings.

Apply

Applies your changes and closes the dialog.

RELATED LINKS

[Color Picker](#) on page 80

Presets Tab

The **Presets** tab allows you to expand the color set to 24 or even 32 colors or to reduce it to 8 colors. You can add tints, and you can sort colors according to their color tint or their basic color.

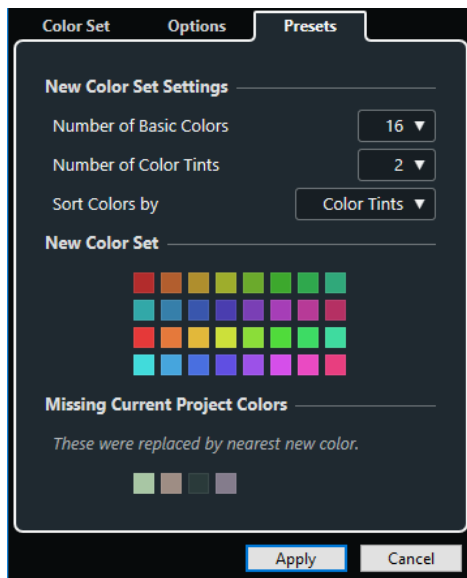

In the **New Color Set Settings** section, the following options are available:

Number of Basic Colors

You can set up 8, 16, 24, or 32 basic colors.

Number of Color Tints

You can set up 1, 2, or 4 color tints.

Sort Colors by

Allows you to sort the colors of the color set by their basic color or by their color tint.

The **New Color Set** section displays the current colors of the new color set.

The **Missing Current Project Colors** section shows which missing colors are replaced. Move the mouse pointer over the color field of a missing color to highlight the color that is used to replace it in the **New Color Set** section.

Apply

Applies your changes and closes the dialog.

Options Tab

The **Options** tab allows you to access the color set options.

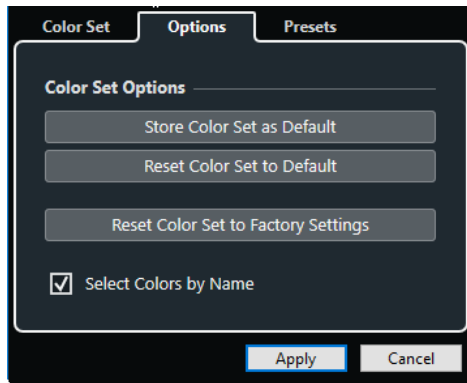

In the **Color Set Options** section, the following options are available:

Store Color Set as Default

Saves the current set of colors as default.

Reset Color Set to Default

Applies the default set of colors.

Reset Color Set to Factory Settings

Returns to the standard color palette.

Select Colors by Name

Allows you to select colors by name.

Apply

Applies your changes and closes the dialog.

Color Picker

The **Color Picker** allows you to define new custom colors.

To open the **Color Picker**, do one of the following:

- Select **Project > Project Colors Setup**, and, in the **Project Colors Setup** dialog on the **Color Set** tab, click a color field.
This allows you to define custom project colors.
- Select **Edit > Preferences**, select one of the **User Interface** entries, and click a color field.
This allows you to define custom user interface colors.

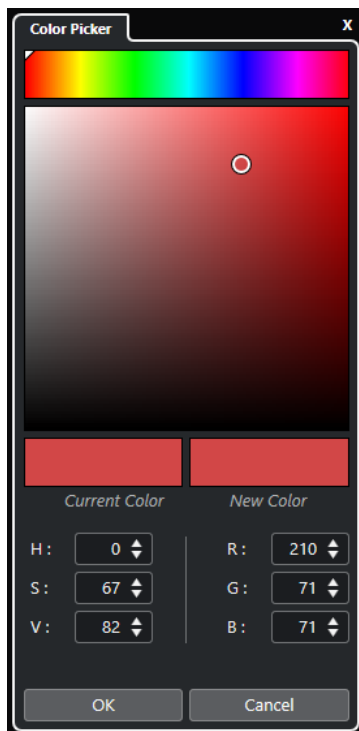

Color selectors

Allow you to select a color shade and the nuance of the shade.

Context menu

Allows you to copy, paste, or reset colors.

Current Color/New Color

Shows the current color and the new color.

Hue/Saturation/Value

Allows you to edit the colors numerically.

Red/Green/Blue

Allows you to edit the colors numerically.

OK

Confirms the color changes.

NOTE

You must restart the application for some changes to take effect.

Project Handling

In Cubase, projects are the central documents. You must create and set up a project to work with the program.

Creating New Projects

You can create empty projects or projects that are based on a template.

PROCEDURE

1. Select **File > New Project.**

Depending on your settings, either the **Hub** or the **Project Assistant** dialog opens.

2. In the location options section, select where to store the new project.

- To use the default location, select **Use default location**.
- To choose another location, select **Prompt for project location**.

3. Do one of the following:

- To create an empty new project, click **Create Empty**.
 - To create a new project from a template, select a template and click **Create**.
-

RESULT

A new, untitled project is created. If you selected a template, the new project is based on this template and includes the corresponding tracks, events, and settings.

NOTE

If you create an empty project, your default presets for the input and output bus configurations are applied. If you have not defined default presets, the last used configurations are applied.

RELATED LINKS

[Presets for Input and Output Busses](#) on page 31

Hub

Hub keeps you up to date with the latest information and assists you with organizing your projects.

To open the **Hub**, do one of the following:

- Select **Hub > Open Hub**.
- Select **File > New Project**.

News Section

The **News** section displays Steinberg news as well as links to interesting deals, the user manuals, the user forum, and the support.

NOTE

Make sure that you have an active Internet connection to access this material.

Projects Section

The **Projects** section allows you to create new projects, which can either be empty or based on a template. It allows you to specify where to save the projects. It also allows you to access recently opened projects or projects that are stored in other locations. This section offers the same functionality as the **Project Assistant** dialog.

Category bar

The available factory templates are sorted into the predefined categories **Recording**, **Scoring**, **Production**, and **Mastering**.

The **Recent** category contains a list of the recently opened projects.

The **More** category contains the default project template and all templates that are not assigned to any of the other categories.

Template list

When you click on one of the category items, the list below the category bar shows the available templates for this category. Any new templates that you create are added at the top of the corresponding list.

Location options

This section allows you to specify where the project is stored.

Open Other

This button allows you to open any project file on your system. This is identical to using the **Open** command on the **File** menu.

RELATED LINKS

[Project Assistant Dialog](#) on page 83

Deactivating the Hub

To start Cubase or to create new projects without the **Hub**, you can deactivate it.

PROCEDURE

1. In the **Preferences** dialog, select **General**.
 2. Deactivate **Use Hub**.
-

RESULT

Cubase starts without opening a project and opens the **Project Assistant** dialog when you create a new project using the **File** menu. However, you can still open the **Hub** through the **Hub** menu.

Project Assistant Dialog

The **Project Assistant** dialog assists you with organizing your projects.

- To open the **Project Assistant** dialog, deactivate **Use Hub** in the **Preferences** dialog (**General** page), and select **File > New Project**.

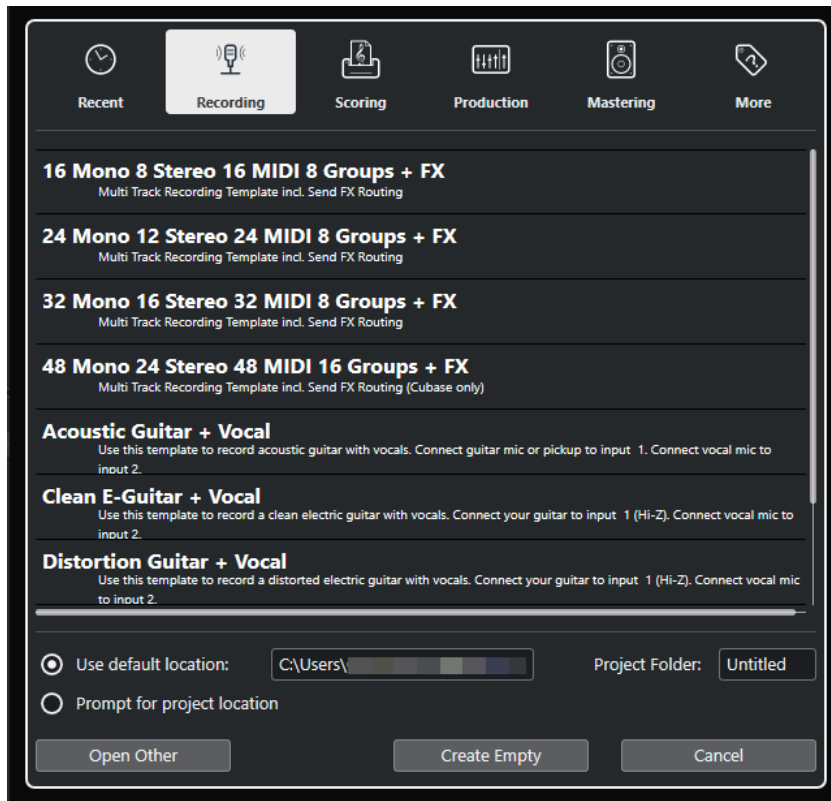

Category bar

The available factory templates are sorted into the predefined categories **Recording**, **Production**, **Scoring**, and **Mastering**.

The **Recent** category contains a list of the recently opened projects.

The **More** category contains the default project template and all templates that are not assigned to any of the other categories.

Template list

When you click on one of the category items, the list below the category bar shows the available factory templates for this category. Any new templates that you create are added at the top of the corresponding list.

Location options

This section allows you to specify where the project is stored.

Open Other

This button allows you to open any project file on your system. This is identical to using the **Open** command from the **File** menu.

Project Files

A project file (extension *.cpr) is the central document in Cubase. A project file contains references to media data that can be saved in the project folder.

NOTE

We recommend to save files in the project folder, even though you can save them in any other location to which you have access.

The project folder contains the project file and the following folders that Cubase automatically creates, if necessary:

- Audio
- Edits
- Images
- Track Pictures

Template Files

Templates can be a good starting point for new projects. Templates are projects where you can save all settings that you regularly use, such as bus configurations, sample rates, record formats, basic track layouts, VSTi setups, drum map setups, etc.

The following template types are available from within the **Hub**:

- Factory templates for specific scenarios. These are listed in the **Recording, Scoring, Production, or Mastering** categories.
- The default template. This is listed in the **More** category.
- Any new user templates that you create and save. These are listed in the **More** category.

Template projects are not saved in project folders. Therefore, they contain no subfolders and no media files.

- To open the location of a specific template, right-click a template in the template list and select **Show in Explorer** (Windows only) or **Reveal in Finder** (macOS only).

Save As Template Dialog

The **Save As Template** dialog allows you to save projects as templates.

- To open the **Save As Template** dialog, select **File > Save As Template**.

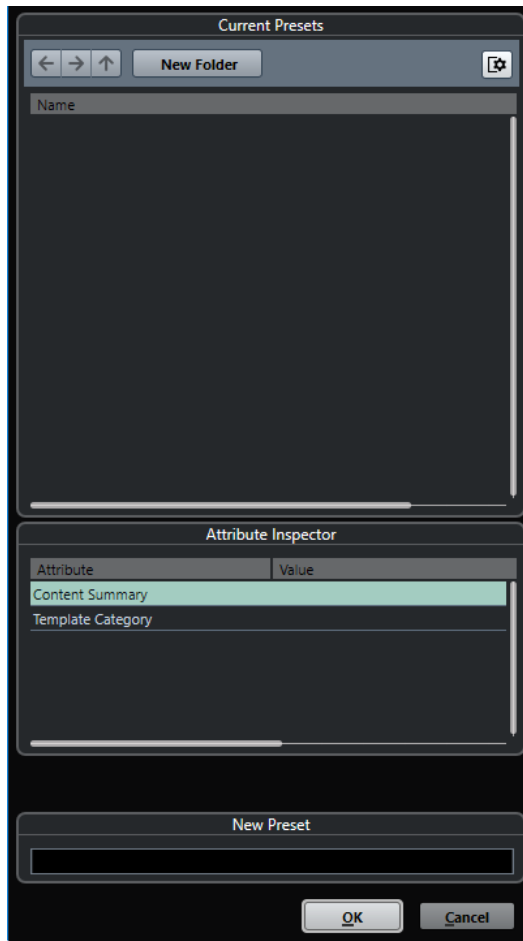

The following options are available in the **Current Presets** section:

New Folder

Allows you to add a folder to the template list.

Template list

Lists the templates and the folders.

The following options are available in the **Attribute Inspector** section:

Value

Click this field to enter a description for the **Content Summary** attribute or to select a template category for **Template Category** attribute.

The following options are available in the **New Preset** section:

New Preset

Allows you to enter a name for the new project template.

Show Attribute Inspector

Allows you to show/hide the **Attribute Inspector**.

Saving a Project Template File

You can save the current project as a template. When you create a new project, you can select this template as a starting point.

PREREQUISITE

You have removed all clips from the **Pool**. This ensures that references to media data from the original project folder are deleted.

PROCEDURE

1. Set up a project.
2. Select **File > Save as Template**.
3. In the **New Preset** section of the **Save as Template** dialog, enter a name for the new project template.

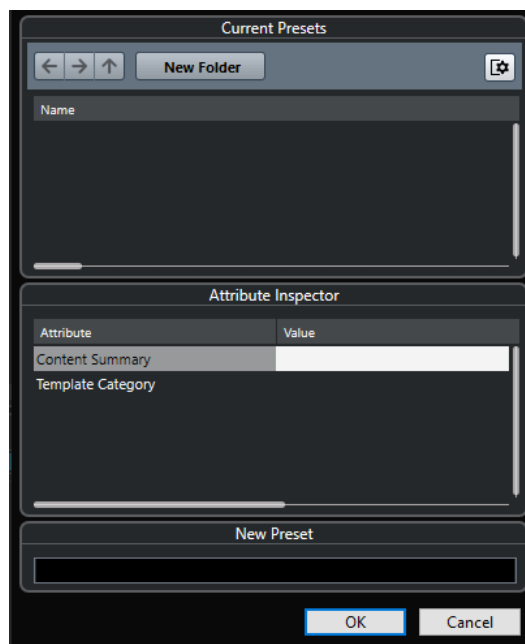

4. In the **Attribute Inspector** section, double-click the **Value** field of the **Content Summary** attribute to enter a description for the template.
5. Click the **Value** field of the **Template Category** attribute and select a template category from the pop-up menu.
If you do not select a category, the new template will be listed in the **Hub**, as part of the **More** category.
6. Click **OK** to save the template.

Renaming Templates

You can rename template files from within the **Hub** or the **Project Assistant**.

PROCEDURE

1. In the **Hub** or in the **Project Assistant**, right-click a template and select **Rename**.
 2. In the **Rename** dialog, enter a new name and click **OK**.
-

Project Setup Dialog

The **Project Setup** dialog allows you to make general settings for your project.

- To open the **Project Setup** dialog, select **Project > Project Setup**.
- To open the **Project Setup** dialog automatically when you create a new project, activate the **Run Setup on Create New Project** option in the **Preferences** dialog (**General** page).

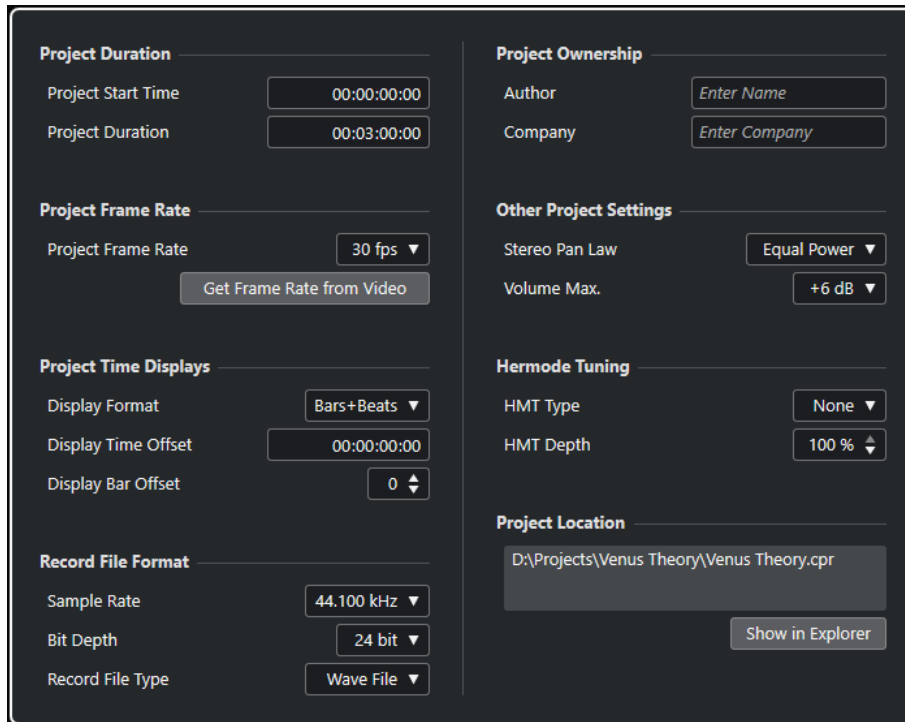

IMPORTANT

While you can change most **Project Setup** settings at any time, you must set the sample rate right after creating a new project. If you change the sample rate at a later stage, you must convert all audio files in the project to the new sample rate to make them play back properly.

In the **Project Duration** section, the following options are available:

Project Start Time

Allows you to specify the start time of the project in timecode format. This also determines the sync start position when synchronizing to external devices.

Project Duration

Allows you to specify the duration of the project.

Project Frame Rate

In the **Project Frame Rate** section, the following options are available:

Project Frame Rate

Allows you to specify the timecode standard and the frame rate for the project. When synchronizing to an external device, this setting must correspond to the frame rate of any incoming timecode.

Get Frame Rate From Video

Allows you to set the project frame rate to the frame rate of an imported video file.

Project Time Displays

In the **Project Time Displays** section, the following options are available:

Display Format

Allows you to specify the global display format for all rulers and position displays in the program, except for the ruler tracks. However, you can make independent display format selections for the individual rulers and displays.

Display Time Offset

Allows you to specify an offset for the time positions in the rulers and position displays to compensate for the **Project Start Time** setting.

Display Bar Offset

This setting is only used in conjunction with the **Bars+Beats** display format. Allows you to specify an offset for the time positions in the rulers and position displays to compensate for the **Project Start Time** setting.

Record File Format

In the **Record File Format** section, the following options are available:

Sample Rate

Allows you to specify the sample rate at which Cubase records and plays back audio.

- If your audio hardware generates the sample rate internally and you select a non-supported sample rate, this is indicated by a different color. In this case, you must set a different sample rate to make your audio files play back properly.
- If you select a sample rate that your audio hardware supports but that differs from its current sample rate setting, it is automatically changed to the project sample rate.
- If your audio hardware is externally clocked and receives external clock signals, sample rate mismatches are accepted.

Bit Depth

Allows you to specify the bit depth of the audio files that you record in Cubase. Select the record format according to the bit depth that is delivered by your audio hardware. The available options are 16 bit, 24 bit, 32 bit, 32 bit float, and 64 bit float.

NOTE

- If your audio interface supports a bit depth of 32 bit and you want to maintain this precision in your recordings, select a **Processing Precision** of 64 bit float in the **Studio Setup** dialog.
 - When you record with effects, consider setting the bit depth to 32 bit float or 64 bit float. This prevents clipping (digital distortion) in the recorded files and keeps the audio quality very high. Effect processing and level or EQ changes in the input channel are performed in 32-bit float or 64-bit float format, depending on the **Processing Precision** setting in the **Studio Setup** dialog. If you record at 16 bit or at 24 bit, the audio is converted to this lower bit depth when it is written to a file. As a result, the signal may degrade. This is independent of the actual bit depth of your audio hardware. Even if the signal from the audio hardware has a bit depth of 16 bit, the signal is 32 bit float or 64 bit float after the effects are added to the input channel.
 - The higher the bit depth value, the larger the files and the more strain is put on the disk system. If this is an issue, lower the record format setting.
-

Record File Type

Allows you to specify the file type of the audio files that you record in Cubase.

NOTE

- For wave file recordings larger than 4 GB, the EBU RIFF standard is used. If you use a FAT 32 disk (not recommended), audio files are split automatically. In the **Preferences** dialog, you can specify what happens if your recorded Wave file is larger than 4 GB.
 - You can set up embedded strings in the **Preferences** dialog.
-

Project Ownership

In the **Project Ownership** section, the following options are available:

Author

Allows you to specify a project author that is written into the file when you export audio files and activate the **Insert iXML chunk** option. You can specify a default author in the **Default Author Name** field of the **Preferences** dialog (**General—Personalization** page).

Company

Allows you to specify a company name that is written into the file when you export audio files and activate the **Insert iXML chunk** option. You can specify a default company in the **Default Company Name** field in the **Preferences** dialog (**General—Personalization** page).

Other Project Settings

In the **Other Project Settings** section, the following options are available:

Stereo Pan Law

If you pan a channel left or right, the sum of the left, and the right side is higher (louder) than if this channel is panned center. These modes allow you to attenuate signals panned center. **0 dB** turns off constant-power panning. **Equal Power** means that the power of the signal remains the same, regardless of the pan setting.

Volume Max

Allows you to specify the maximum fader level. By default, this is set to +12 dB. If you load projects created with Cubase versions older than 5.5, this value is set to the old default value of +6 dB.

Hermoder Tuning

In the **Hermoder Tuning** section, the following options are available:

HMT Type (MIDI only)

Allows you to specify a mode for Hermoder tuning of MIDI notes.

HMT Depth (MIDI only)

Allows you to specify the overall degree of retuning.

Project Location

In the **Project Location** section, the following options are available:

Project Location information

Displays the project location.

Show in Explorer/Reveal in Finder

Opens a file dialog that shows the location of the project file.

RELATED LINKS

[Audio System Page](#) on page 16

[Record - Audio](#) on page 844

Opening Project Files

You can open several saved project files at the same time.

IMPORTANT

If you open a project saved with a different program version and it contains data for functions that are not available in your version, this data may be lost when you save the project with your version.

NOTE

- If you open an external project, the last used view that was saved on your computer is used.
- External projects are automatically connected to the input and output busses. If you open a project created on a computer with an ASIO port configuration that differs from the configuration of your computer, this can result in unwanted audio connections. You can deactivate the automatic connection of input and output busses in the **Preferences** dialog (**VST** page).

PROCEDURE

1. Select **File > Open**.
2. In the file dialog that opens, select the project that you want to open and click **Open**.
3. If there is already an open project, you are asked if you want to activate the new project. Do one of the following:
 - To activate the project, click **Activate**.
 - To open the project without activating it, click **No**.
This reduces load times for projects.

RELATED LINKS

[Do Not Connect Input/Output Busses When Loading External Projects](#) on page 848

[Activating Projects](#) on page 91

Activating Projects

In Cubase you have several projects opened at the same time. However, only one project can be active. The active project is indicated by the lit **Activate Project** button in the upper left corner of the **Project** window. To work on another project, activate the other project.

PROCEDURE

- To activate a project, click **Activate Project** .

NOTE

If you close the active project, you must activate another open project manually, as Cubase cannot automatically activate one of the other open projects.

Opening Recent Projects

You can open recent projects from the recent projects list.

PROCEDURE

- Do one of the following:
 - In the category bar of the **Hub** or the **Project Assistant** dialog, click **Recent**, select a project from the projects list, and click **Open**.
 - Select **File > Recent Projects** and select a recently opened project.
-

Re-Routing Missing Ports

If you open a Cubase project that was created on a different system with other audio hardware, Cubase tries to find matching audio inputs and outputs for the input/output busses. If Cubase cannot resolve all audio/MIDI inputs and outputs that are used in the project, the **Missing Ports** dialog opens.

This allows you to manually re-route any ports specified in the project to ports that are available on your system.

NOTE

To improve the search for matching audio inputs and outputs for the input/output busses, use descriptive, generic names for your input and output ports.

RELATED LINKS

[Renaming the Hardware Inputs and Outputs](#) on page 29

Saving Project Files

You can save the active project as a project file. To keep your projects as manageable as possible, make sure that you save project files and all related files in the respective project folders.

- To save the project and to specify a file name and location, open the **File** menu and select **Save As**.
- To save the project with its current name and location, open the **File** menu and select **Save**.

Auto Save

Cubase can automatically save backup copies of all open project files with unsaved changes.

NOTE

Only the project files are backed up. To include the files from the **Pool** and to save your project in a different location, use the **Back up Project** function.

Cubase can automatically save backup copies of all open projects with unsaved changes. To set this up, activate the **Auto Save** option in the **Preferences** dialog (**General** page). The backup copies are named “<project name>-xx.bak” where xx is an incremental number. Unsaved projects are backed up in a similar way as “UntitledX-xx.bak”, with X being the incremental number for unsaved projects. All backup files are saved in the project folder.

- To specify the time intervals in which a backup copy is created, use the **Auto Save Interval** setting.
- To specify how many backup files are created with the **Auto Save** function, use the **Maximum Backup Files** option. When the maximum number of backup files is reached, the existing files are overwritten, starting with the oldest file.

Saving Project Files As a New Version

You can create and activate a new version of an active project file. This is useful if you are experimenting with edits and arrangements and want to be able to go back to a previous version.

PROCEDURE

- Do one of the following:
 - Select **File > Save New Version**.
 - Press **Ctrl/Cmd - Alt/Opt - S**.

RESULT

The new file is saved under the same name as the original project, with an incremental number attached to it. For example, if your project is called “My Project”, new versions are called “My Project-01”, “My Project-02”, and so on.

Reverting to the Last Saved Version

You can return to the last saved version and discard all changes that have been made.

PROCEDURE

1. Select **File > Revert**.
2. In the warning message, click **Revert**.
If you have recorded or created new audio files since the last version was saved, you are prompted to delete or keep the files.

Choosing a Project Location

You can specify a project location for saving projects in the **Hub** and in the **Project Assistant**.

PROCEDURE

1. Do one of the following:
 - Select **Use default location** to create a project in the default project location. In the **Project folder** field, specify a name for the project folder. If you do not specify a project folder here, the project is saved in a folder named `Untitled`.

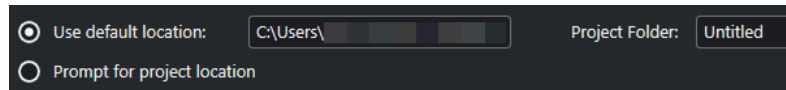

- Click in the path field to change the default project location. Specify the new default location in the file dialog that opens.
 - Activate **Prompt for project location** to open a file dialog where you can specify the project folder location.
2. Do one of the following:
 - Click **Create Empty** to create a new empty project.
 - Select one of the template projects and click **Create** to create a project based on a template.

RESULT

The project is created and saved in the specified location.

Self-Contained Projects

To share your work or to transfer it to another computer, your project must be self-contained.

The following functions facilitate this task:

- Select **Media > Prepare Archive** to verify that every clip that is referenced in the project is located in the project folder and to take actions if that is not the case.
- Select **File > Back up Project** to create a new project folder where you can save the project file and the necessary work data. The original project remains unchanged.

RELATED LINKS

[Preparing Archives](#) on page 94

[Backing up Projects](#) on page 95

Preparing Archives

The **Prepare Archive** function allows you to gather all files that are referenced by your project and to ensure that these are in the project folder. This is useful if you want to move or archive your project.

PROCEDURE

1. Select **Media > Prepare Archive**.
If your project references external files, you are prompted to copy them to your working directory. If any processing has been applied, decide if you want to flatten edits.
2. Click **Proceed**.

RESULT

Your project is ready to be archived. You can move or copy the project folder to another location.

AFTER COMPLETING THIS TASK

Copy audio files that reside within the project folder to the **Audio** folder or save them separately. You must also move your video clips manually, as videos are only referenced and not saved in the project folder.

Backing up Projects

You can create a backup copy of your project. Backups only contain the necessary work data. All media files, except for the files from VST Sound archives, are included as a copy.

PROCEDURE

1. Select **File > Back up Project**.
 2. Select an empty folder or create a new one.
 3. Make your changes in the **Back up Project Options** dialog and click **OK**.
-

RESULT

A copy of the project is saved in the new folder. The original project remains unaffected.

NOTE

VST Sound content provided by Steinberg is copy-protected and is not included in the backup project. If you want to use a backup copy that uses VST Sound content on a different computer, make sure that the corresponding content is also available on that computer.

Back up Project Options Dialog

The **Back up Project Options** dialog allows you to create a backup copy of your project.

- To open the **Back up Project Options** dialog, select **File > Back up Project**.

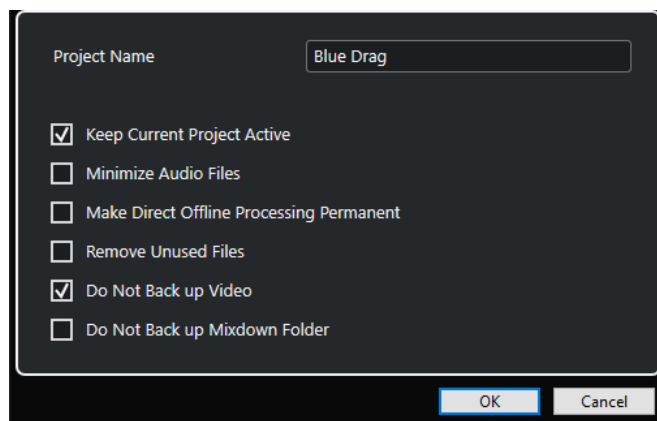

Project Name

Allows you to change the name of the backed up project.

Keep Current Project Active

Allows you to keep the current project active after clicking **OK**.

Minimize Audio Files

Allows you to include only the audio file portions that are actually used in the project. This can significantly reduce the size of the project folder if you are using small sections of large files. It also means that you cannot use other parts of the audio files if you continue working with the project in its new folder.

Make Direct Offline Processing Permanent

Allows you to flatten all edits and to apply all processing and effects permanently to each clip in the **Pool**.

Remove Unused Files

Allows you to remove unused files and to back up only the files that are actually used.

Do Not Back up Video

Allows you to exclude video clips from the video track or from the **Pool** of the current project.

Do Not Back up Mixdown Folder

Allows you to exclude the **Mixdown** folder of your project from the backup.

RELATED LINKS

[Export Audio Mixdown Dialog](#) on page 757

Tracks

Tracks are the building blocks of your project. They allow you to import, add, record, and edit parts and events. Tracks are listed from top to bottom in the track list and extend horizontally across the **Project** window. Each track is assigned to a particular channel strip in the **MixConsole**.

If you select a track in the **Project** window, the controls, settings, and parameters displayed in the **Inspector** and the track list allow you to control the track.

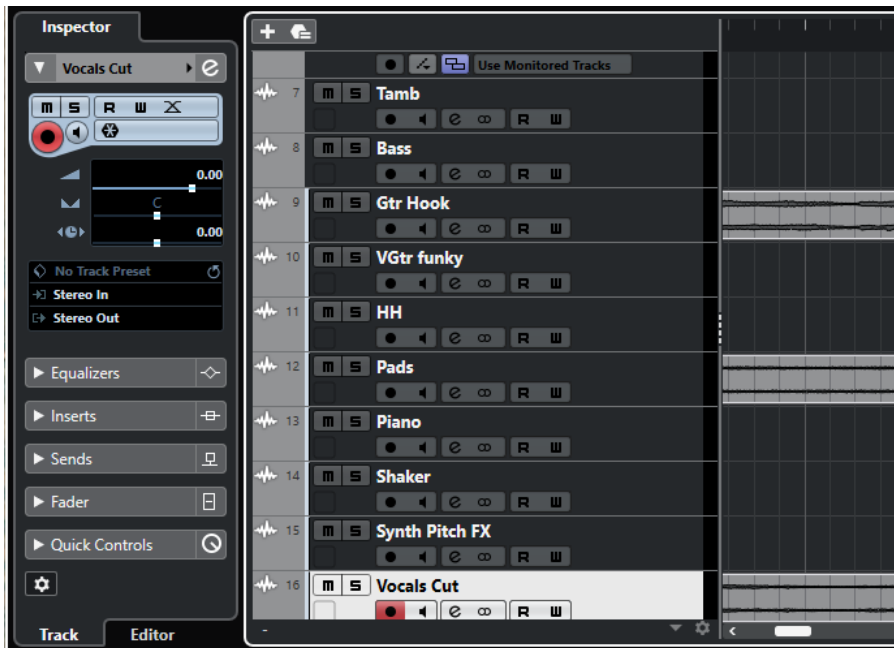

Track Inspector Settings Dialog

The **Track Inspector Settings** dialog allows you to configure the visibility settings of the individual **Inspector** sections for each track type. You can also specify the order of the sections.

- To open the **Track Inspector Settings** dialog, click **Set up Inspector**, and select **Setup** from the pop-up menu.

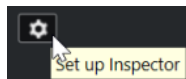

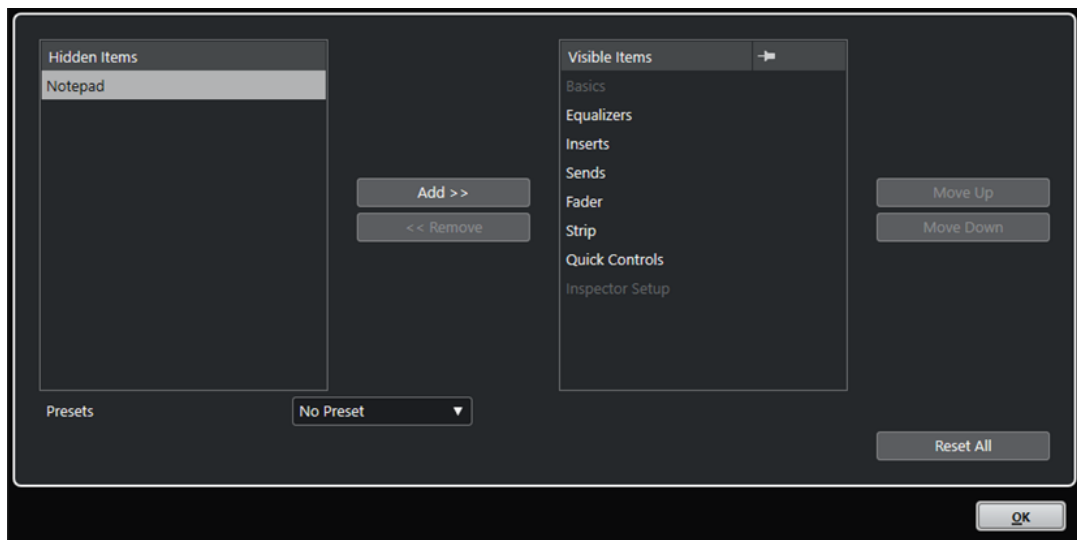

Hidden Items

Displays sections that are hidden in the **Inspector**.

Visible Items

Displays sections that are visible in the **Inspector**.

Pin

Activate **Pin** by clicking the column for a section to prevent this section from being closed automatically.

Add

Allows you to move a selected item from the list of hidden sections to the list of visible sections.

Remove

Allows you to move a selected item from the list of visible sections to the list of hidden sections.

Move Up/Move Down

Allows you to change the position of an item in the list of visible sections.

Presets

Allows you to save **Inspector** settings as presets.

Reset All

Allows you to restore the default **Inspector** settings.

Inspector Sections

Each track type has its basic track settings that are always shown. Apart from these, you can set up other track-specific **Inspector** sections in the **Track Inspector Settings** dialog.

Depending on the track type, you can set up the following **Inspector** sections:

Chords

Allows you to specify how the track follows the chord track.

Inserts

Allows you to add audio insert effects to the track.

Equalizers

Allows you to adjust the EQs for the track. You can have up to four bands of EQs for each track.

Sends

Allows you to route the track to one or several FX channels.

Fader

Shows a duplicate of the corresponding **MixConsole** channel.

Notepad

Allows you to enter notes about the track.

Quick Controls

Allows you to configure quick controls to use remote devices, for example.

MIDI Modifiers

Allows you to transpose or adjust the velocity of the MIDI track events in real time during playback.

Instrument

Shows the audio-related controls for the sampler track.

MIDI Fader

Shows a duplicate of the corresponding **MixConsole** channel.

RELATED LINKS

[Inspector Sections](#) on page 51

[Track Inspector Settings Dialog](#) on page 97

[Insert Effects](#) on page 331

[Send Effects](#) on page 337

[Equalizers \(EQ\)](#) on page 303

[Chords Section for MIDI Tracks](#) on page 718

[Track Quick Controls](#) on page 534

[MIDI Modifiers Section](#) on page 590

Track Controls Settings Dialog

The **Track Controls Settings** dialog allows you to configure which track controls are displayed in the track list. You can also specify the order of controls and group controls so that they are always shown adjacent to each other.

NOTE

The **Track Controls Settings** dialog is available for the main track types. The track types that are shown in the **More Tracks** section of the **Add Track** dialog, however, have a fixed set of track-specific controls. Exceptions to this are the chord track and the video track.

- To open the **Track Controls Settings** dialog, right-click a track in the track list and select **Track Controls Settings** from the context menu, or click **Open Track Controls Settings Dialog** in the bottom right corner of the track list.

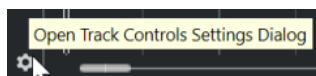

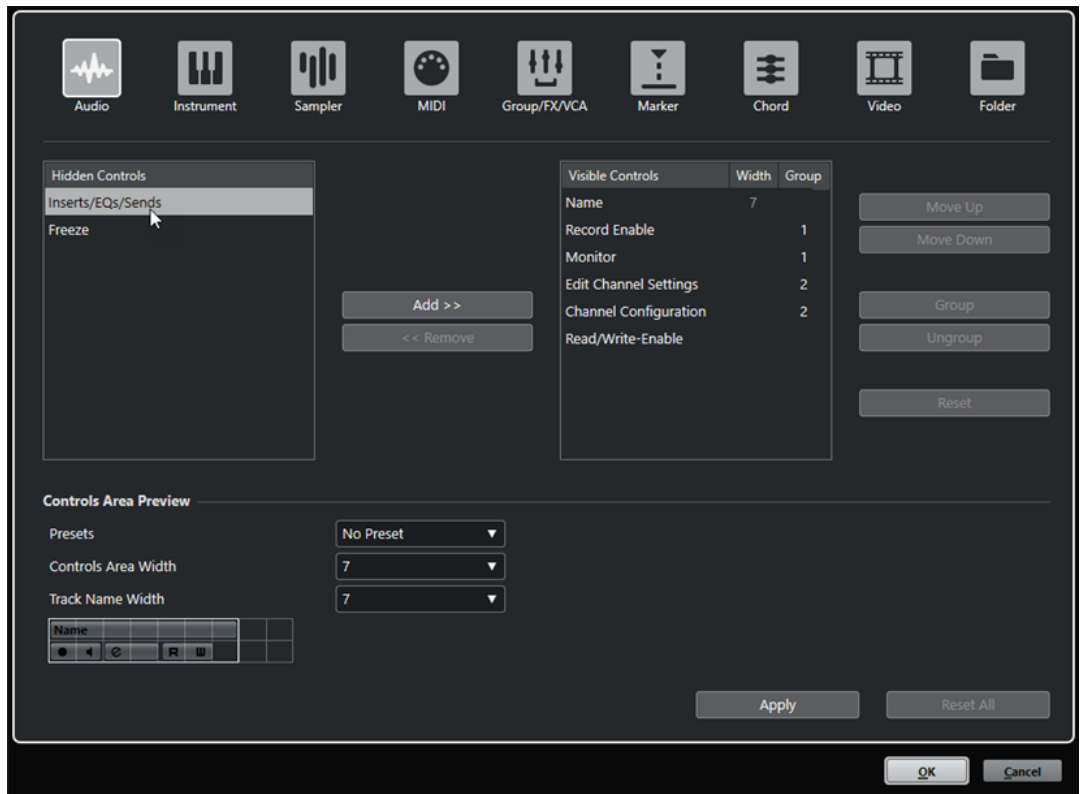

Track type

Allows you to select the track type to which your settings are applied.

Hidden Controls

Displays controls that are hidden in the track list.

Visible Controls

Displays controls that are visible in the track list.

Width

If you click in this column, you can set the maximum length for the track name.

Group

Displays the group number.

Add

Allows you to move a selected item from the list of hidden controls to the list of visible controls.

Remove

Allows you to move a selected item from the list of visible controls to the list of hidden controls. All controls can be removed, except for **Mute** and **Solo**.

Move Up/Move Down

Allows you to change the order of items in the list of visible controls.

Group

Allows you to group two or more selected items in the visible controls list that are next to each other. This ensures that they are always positioned side by side in the track list.

Ungroup

Allows you to ungroup grouped controls in the visible controls list. To remove an entire group, select the first (topmost) element of this group and click **Ungroup**.

Reset

Allows you to restore all default track controls settings for the selected track type.

Controls Area Preview

Shows a preview of the customized track controls.

Presets

Allows you to save settings for track controls as presets. To recall a preset, click **Switch Presets** in the bottom right corner of the track list. The name of the selected preset is shown in the left corner.

Controls Area Width

Allows you to determine the width of the track controls area for the selected track type. In the **Controls Area Preview**, this area is shown with a frame.

Track Name Width (global)

Allows you to determine the global name width for all track types.

Apply

Applies your settings.

Reset All

Allows you to restore all default settings for track controls for all track types.

Track Controls

You can configure which track controls are shown in the track list.

NOTE

You can only configure track controls for the main track types. The track types that are shown in the **More Tracks** section of the **Add Track** dialog, however, have a fixed set of track-specific controls. The chord track and the video track are exceptions to this.

The following track controls are always shown:

Mute



Mutes the track.

Solo



Solos the track.

The track name control is available for all track types:

Name



Shows the name of the track. Double-click to rename the track.

Audio-Related Tracks

The following track controls are specific to audio-related tracks, that is, audio tracks, instrument tracks, sampler tracks, group channel tracks, and FX channel tracks:

Bypass Inserts



Bypasses the inserts for the track.

Bypass EQs



Bypasses the equalizers for the track.

Bypass Sends



Bypasses the sends for the track.

Freeze Channel



Opens a dialog that allows you to set the **Tail Size** time in seconds.

Channel Configuration



Shows the channel configuration of the track.

MIDI-Related Tracks

The following controls are specific to MIDI-related tracks, that is, MIDI tracks, sampler tracks, and instrument tracks:

ASIO Latency Compensation



Moves all recorded events on the track by the current latency.

Programs

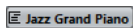

Allows you to select a program.

Drum Map



Allows you to select a drum map for the track.

Audio- and MIDI-Related Tracks

The following track controls are specific to audio- and MIDI-related tracks:

Record Enable



Activates the track for recording.

Monitor



For audio-related tracks, this routes incoming signals to the selected output.

For MIDI and instrument-related tracks, this allows you to route incoming MIDI signals to the selected MIDI output. For this to work, activate **MIDI Thru Active** in the **Preferences** dialog (**MIDI** page).

Edit Channel Settings



Opens the **Channel Settings** window for the track.

Read Automation



Allows you to read track automation.

Write Automation



Allows you to write track automation.

Instrument Tracks

The following controls are specific to instrument tracks:

Edit Instrument



Allows you to open the instrument panel.

Instrument

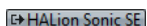

Allows you to select an instrument.

Sampler Tracks

The following controls are specific to sampler tracks:

Open/Close Sampler

Opens/Closes the **Sampler Control** in the lower zone.

MIDI Tracks

The following controls are specific to MIDI tracks:

Channel



Allows you to specify the MIDI channel.

Output

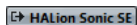

Allows you to specify the output for the track.

Group/FX/VCA Tracks

The following track controls are specific to group/FX/VCA tracks:

Mute Automation



Deactivates the automation read function for the selected parameter.

Automation parameter

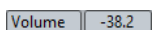

Allows you to select a parameter for automation.

Parameter

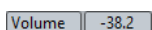

Allows you to select a parameter value for automation.

Marker Tracks

The following controls are specific to marker tracks:

Add Marker



Allows you to add a position marker at the project cursor position. This track control is always shown.

Add Cycle Marker



Allows you to add a cycle marker at the project cursor position. This track control is always shown.

Locate



Allows you to move the project cursor to the selected marker position.

Cycle



Allows you to select a cycle marker.

Zoom



Allows you to zoom in on a cycle marker.

Add Track Dialog

The **Add Track** dialog allows you to set up and add tracks.

To open the **Add Track** dialog, click **Add Track**  in the global track control area of the track list.

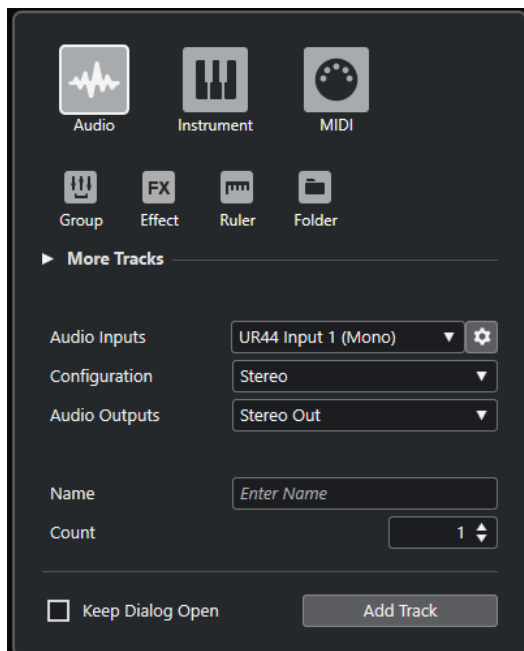

RELATED LINKS

- [Add Track Dialog – Audio](#) on page 105
- [Add Track Dialog – Instrument](#) on page 108
- [Add Track Dialog – Sampler](#) on page 112
- [Add Track Dialog – MIDI](#) on page 115
- [Add Track Dialog – Group Channel](#) on page 118
- [Add Track Dialog – Effect](#) on page 121
- [Add Track Dialog – Ruler](#) on page 124
- [Add Track Dialog – Folder](#) on page 126

- [Arranger Track](#) on page 129
- [Chord Track](#) on page 131
- [Video Tracks](#) on page 133
- [Marker Track](#) on page 134

Audio Tracks

You can use audio tracks for recording and playing back audio events and audio parts. Each audio track has a corresponding audio channel in the **MixConsole**. An audio track can have any number of automation tracks for automating channel parameters, effect settings, etc.

You can add audio tracks via the **Add Track** dialog.

RELATED LINKS

- [Add Track Dialog – Audio](#) on page 105

Add Track Dialog – Audio

The **Audio** page of the **Add Track** dialog allows you to set up and add audio tracks.

To open the **Audio** page of the **Add Track** dialog, do one of the following:

- Click **Add Track**  in the global track controls area of the track list, and click **Audio**. This opens the global **Add Track** dialog on the **Audio** page.

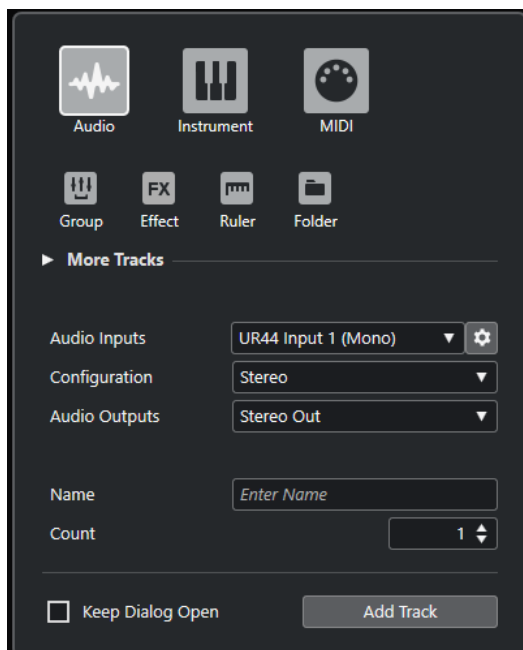

- Select **Project > Add Track > Audio** or right-click in an empty area of the track list, and select **Add Audio Track**.

This opens the **Audio** page of the **Add Track** dialog.

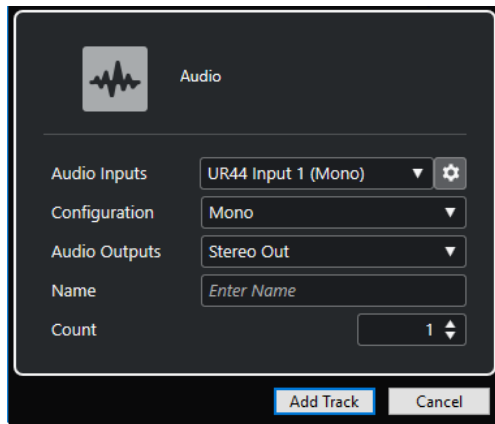

The following settings are available:

Audio Inputs

Opens a window where you can select an input of your connected audio hardware.

If you have added an input bus in the **Audio Connections** window, you can connect to that input bus.

The **Open Audio Connections** button opens the **Audio Connections** window.

Configuration

Allows you to set the channel configuration. Audio-related tracks can be configured as mono or stereo tracks.

Audio Outputs

Allows you to set the output routing.

Name

Allows you to specify a track name.

Count

Allows you to enter the number of tracks that you want to add.

Keep Dialog Open

Activate this to keep the dialog open after clicking **Add Track**. This allows you to click the page of another track type to set up and add more tracks.

NOTE

This is only available if you open the **Add Track** dialog from the global track controls.

Add Track

Adds one or more tracks, according to the track type and the settings of the active page, and closes the dialog.

RELATED LINKS

[Audio Connections Window](#) on page 28

Audio Track Inspector

The **Inspector** for audio tracks contains controls and parameters that allow you to edit your audio track.



The top section of the audio track **Inspector** contains the following basic track settings:

Track name



Click once to show/hide the basic track settings section. Double-click to rename the track.

Colorize Selected Track



Allows you to colorize the selected track.

Edit Channel Settings



Opens the **Channel Settings** window for the track.

Mute



Mutes the track.

Solo



Solos the track.

Read Automation



Allows you to read track automation.

Write Automation



Allows you to write track automation.

Auto Fades Settings



Opens a dialog where you can make separate fade settings for the track.

Record Enable



Activates the track for recording.

Monitor



Routes incoming signals to the selected output.

Freeze Audio Channel



Allows you to freeze the audio channel.

Volume



Allows you to adjust the level of the track.

Pan



Allows you to adjust the panning of the track.

Delay



Allows you to adjust the playback timing of the track.

Load/Save/Reload Track Preset



Loads or saves a track preset or reverts the default presets.

Input Routing



Allows you to specify the input bus for the track.

Output Routing



Allows you to specify the output bus for the track.

RELATED LINKS

[Inspector Sections](#) on page 98

Instrument Tracks

You can use instrument tracks for dedicated VST instruments. Each instrument track has a corresponding instrument channel in the **MixConsole**. An instrument track can have any number of automation tracks.

You can add instrument tracks via the **Add Track** dialog.

RELATED LINKS

[Add Track Dialog – Instrument](#) on page 108

Add Track Dialog – Instrument

The **Instrument** page of the **Add Track** dialog allows you to set up and add instrument tracks.

To open the **Instrument** page of the **Add Track** dialog, do one of the following:

- Click **Add Track**  in the global track control area of the track list, and click **Instrument**. This opens the global **Add Track** dialog on the **Instrument** page.

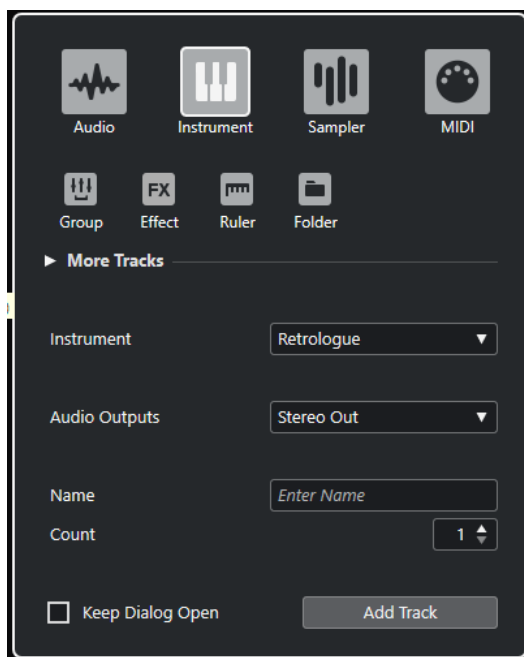

- Select **Project > Add Track > Instrument** or right-click in an empty area of the track list, and select **Add Instrument Track**.

This opens the **Instrument** page of the **Add Track** dialog.

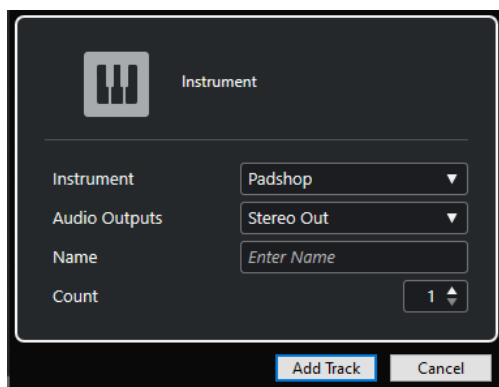

The following settings are available:

Instrument

Allows you to select an instrument.

Audio Outputs

Allows you to set the output routing.

Name

Allows you to specify a track name.

Count

Allows you to enter the number of tracks that you want to add.

Keep Dialog Open

Activate this to keep the dialog open after clicking **Add Track**. This allows you to click the page of another track type to set up and add more tracks.

NOTE

This is only available if you open the **Add Track** dialog from the global track controls.

Add Track

Adds one or more tracks, according to the track type and the settings of the active page, and closes the dialog.

Instrument Track Inspector

The **Inspector** for instrument tracks contains controls and parameters that allow you to control your instrument track. It shows some of the sections from VST instrument channels and MIDI tracks.



The top section of the instrument track **Inspector** contains the following basic track settings:

Track name

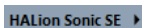

Click once to show/hide the basic track settings section. Double-click to rename the track.

Colorize Selected Track



Allows you to colorize the selected track.

Edit Channel Settings



Opens the **Channel Settings** window for the track.

Mute



Mutes the track.

Solo



Solos the track.

Read Automation



Allows you to read track automation.

Write Automation



Allows you to write track automation.

Record Enable



Activates the track for recording.

Monitor



Routes incoming MIDI to the selected MIDI output. For this to work, activate **MIDI Thru Active** in the **Preferences** dialog (**MIDI** page).

Freeze Instrument Channel



Allows you to freeze the instrument.

Volume



Allows you to adjust the level of the track.

Pan



Allows you to adjust the panning of the track.

Delay



Allows you to adjust the playback timing of the track.

Load/Save/Reload Track Preset



Loads or saves a track preset or reverts the default presets.

Input Routing



Allows you to specify the input bus for the track.

Activate Outputs



This control is only available if the instrument provides more than one output. It allows you to activate one or more outputs for the instrument.

Edit Instrument



Allows you to open the instrument panel.

Programs

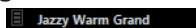

Allows you to select a program.

Drum Maps

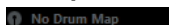

Allows you to select a drum map for the track.

Retrospective Recording

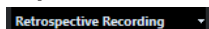

Opens a pop-up menu that allows you to insert a retrospective track recording, that is, MIDI data that was captured during playback.

RELATED LINKS

[Inspector Sections](#) on page 98

[Freezing Instruments](#) on page 520

Sampler Tracks

You can use sampler tracks for controlling the playback of audio samples via MIDI. Each sampler track has a corresponding channel in the **MixConsole**. A sampler track can have any number of automation tracks.

You can add sampler tracks via the **Add Track** dialog.

RELATED LINKS

[Add Track Dialog – Sampler](#) on page 112

[Creating Sampler Tracks](#) on page 422

[Sampler Control](#) on page 423

Add Track Dialog – Sampler

The **Sampler** page of the **Add Track** dialog allows you to set up and add sampler tracks.

To open the **Sampler** page of the **Add Track** dialog, do one of the following:

- Click **Add Track**  in the global track control area of the track list, and click **Sampler**.

This opens the global **Add Track** dialog on the **Sampler** page.

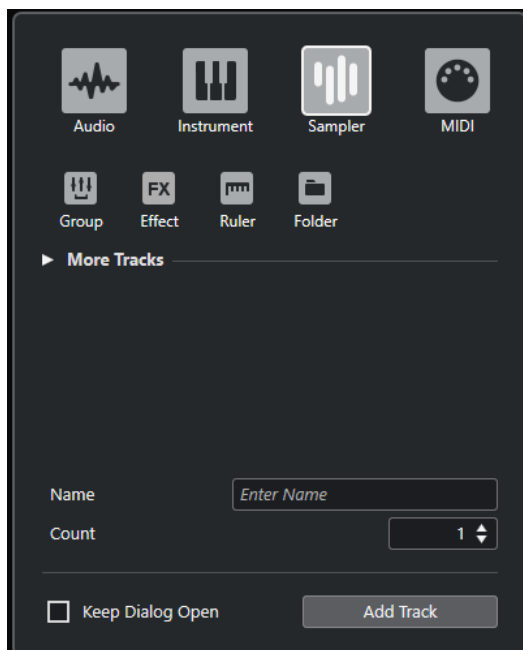

- Select **Project > Add Track > Sampler** or right-click in an empty area of the track list, and select **Add Sampler Track**.

This opens the **Sampler** page of the **Add Track** dialog.

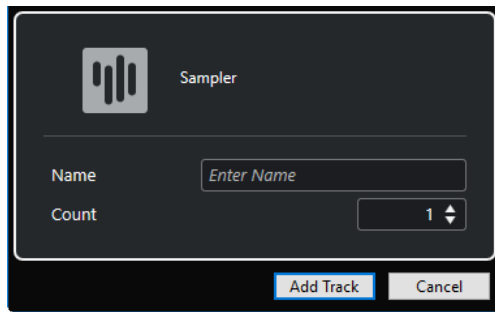

The following settings are available:

Name

Allows you to specify a track name.

Count

Allows you to enter the number of tracks that you want to add.

Keep Dialog Open

Activate this to keep the dialog open after clicking **Add Track**. This allows you to click the page of another track type to set up and add more tracks.

NOTE

This is only available if you open the **Add Track** dialog from the global track controls.

Add Track

Adds one or more tracks, according to the track type and the settings of the active page, and closes the dialog.

Sampler Track Inspector

The **Inspector** for sampler tracks contains controls and parameters that allow you to edit your sampler track.



The top section of the sampler track **Inspector** contains the following basic track settings:

Track name

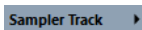

Click once to show/hide the basic track settings section. Double-click to rename the track.

Colorize Selected Track



Allows you to colorize the selected track.

Edit Channel Settings



Opens the **Channel Settings** window for the track.

Mute



Mutes the track.

Solo



Solos the track.

Read Automation



Allows you to read track automation.

Write Automation



Allows you to write track automation.

Record Enable



Activates the track for recording.

Monitor



Routes incoming MIDI to the selected MIDI output. For this to work, activate **MIDI Thru Active** in the **Preferences** dialog (**MIDI** page).

Freeze Sampler Channel



Allows you to freeze the sampler track.

Volume



Allows you to adjust the level of the track.

Pan



Allows you to adjust the panning of the track.

Delay



Allows you to adjust the playback timing of the track.

Load/Save/Reload Track Preset



Loads or saves a track preset or reverts the default presets.

Input Routing



Allows you to specify the input bus for the track.

Retrospective Recording

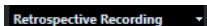

Opens a pop-up menu that allows you to insert a retrospective track recording, that is, MIDI data that was captured during playback.

RELATED LINKS

[Inspector Sections](#) on page 98

[Freezing Sampler Tracks](#) on page 442

MIDI Tracks

You can use MIDI tracks for recording and playing back MIDI parts. Each MIDI track has a corresponding MIDI channel in the **MixConsole**. A MIDI track can have any number of automation tracks.

You can add MIDI tracks via the **Add Track** dialog.

RELATED LINKS

[Add Track Dialog – MIDI](#) on page 115

Add Track Dialog – MIDI

The **MIDI** page of the **Add Track** dialog allows you to set up and add MIDI tracks.

To open the **MIDI** page of the **Add Track** dialog, do one of the following:

- Click **Add Track**  in the global track control area of the track list, and click **MIDI**.

This opens the global **Add Track** dialog on the **MIDI** page.

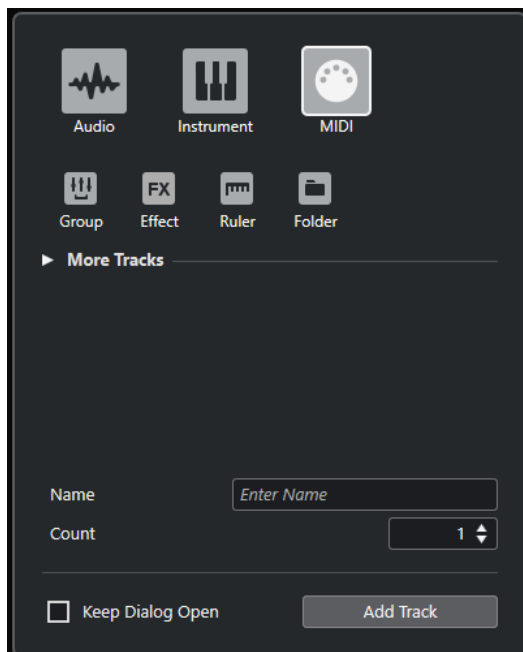

- Select **Project > Add Track > MIDI** or right-click in an empty area of the track list, and select **Add MIDI Track**.

This opens the **MIDI** page of the **Add Track** dialog.

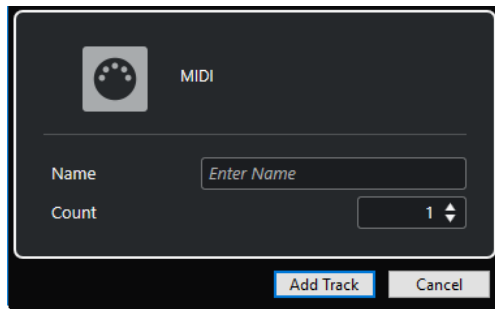

The following settings are available:

Name

Allows you to specify a track name.

Count

Allows you to enter the number of tracks that you want to add.

Keep Dialog Open

Activate this to keep the dialog open after clicking **Add Track**. This allows you to click the page of another track type to set up and add more tracks.

NOTE

This is only available if you open the **Add Track** dialog from the global track controls.

Add Track

Adds one or more tracks, according to the track type and the settings of the active page, and closes the dialog.

MIDI Track Inspector

The **Inspector** for MIDI tracks contains controls and parameters that allow you to control your MIDI track. These affect MIDI events in real time, on playback, for example.

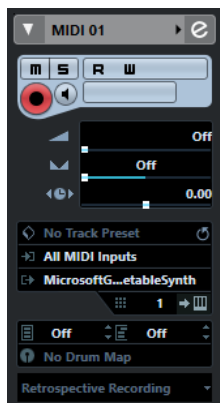

The top section of the MIDI track **Inspector** contains the following basic track settings:

Track name

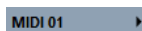

Click once to show/hide the basic track settings section. Double-click to rename the track.

Colorize Selected Track



Allows you to colorize the selected track.

Edit Channel Settings



Opens the **Channel Settings** window for the track.

Mute



Mutes the track.

Solo



Solos the track.

Read Automation



Allows you to read track automation.

Write Automation



Allows you to write track automation.

Record Enable



Activates the track for recording.

Monitor



Routes incoming MIDI to the selected MIDI output. For this to work, activate **MIDI Thru Active** in the **Preferences** dialog (**MIDI** page).

Volume



Allows you to adjust the level of the track.

MIDI Pan



Allows you to adjust the MIDI panning of the track.

Delay



Allows you to adjust the playback timing of the track.

Load/Save/Reload Track Preset



Loads or saves a track preset or reverts the default presets.

Input Routing



Allows you to specify the input bus for the track.

Output Routing



Allows you to specify the output bus for the track.

Channel



Allows you to specify the MIDI channel.

Edit Instrument



Allows you to open the instrument panel.

Bank Selector



Allows you to set a bank select message that is sent to your MIDI device.

Programs

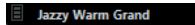

Allows you to select a program.

Program Selector



Allows you to set a program change message that is sent to your MIDI device.

Drum Maps

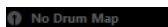

Allows you to select a drum map for the track.

Retrospective Recording

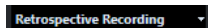

Opens a pop-up menu that allows you to insert a retrospective track recording, that is, MIDI data that was captured during playback.

RELATED LINKS

[Inspector Sections](#) on page 98

Group Channel Tracks

You can use group channel tracks to create a submix of several audio channels and to apply the same effects to them. A group channel track contains no events as such, but displays settings and automation for the corresponding group channel.

For easy management, all group channel tracks are automatically placed in a special group track folder in the track list. Each group channel track has a corresponding channel in the **MixConsole**. A group channel track can have any number of automation tracks.

You can add group channel tracks via the **Add Track** dialog.

RELATED LINKS

[Add Track Dialog – Group Channel](#) on page 118

Add Track Dialog – Group Channel

The **Group** page of the **Add Track** dialog allows you to set up and add group channel tracks.

To open the **Group** page of the **Add Track** dialog, do one of the following:

- Click **Add Track**  in the global track control area of the track list, and click **Group**. This opens the global **Add Track** dialog on the **Group** page.

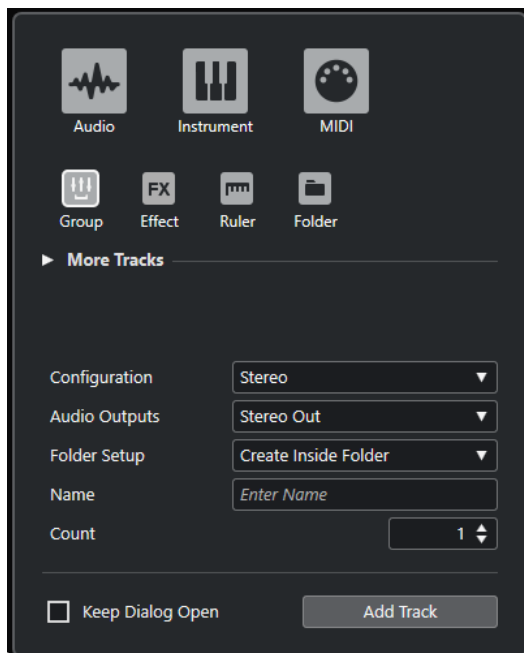

- Select **Project > Add Track > Group**.
This opens the **Group** page of the **Add Track** dialog.

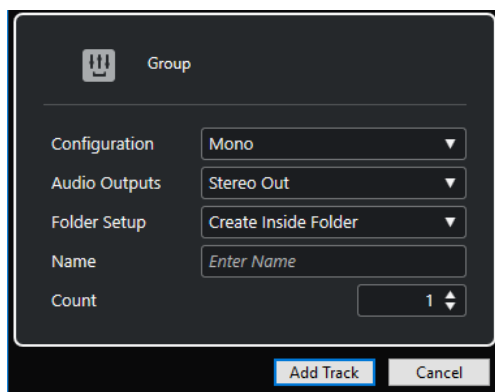

The following settings are available:

Configuration

Allows you to set the channel configuration. Audio-related tracks can be configured as mono or stereo tracks.

Audio Outputs

Allows you to set the output routing.

Folder Setup

Allows you to select whether you want to create the effect inside or outside a dedicated folder.

Name

Allows you to specify a track name.

Count

Allows you to enter the number of tracks that you want to add.

Keep Dialog Open

Activate this to keep the dialog open after clicking **Add Track**. This allows you to click the page of another track type to set up and add more tracks.

NOTE

This is only available if you open the **Add Track** dialog from the global track controls.

Add Track

Adds one or more tracks, according to the track type and the settings of the active page, and closes the dialog.

Group Channel Track Inspector

The **Inspector** for group channel tracks shows the settings for the group channel.



Track name

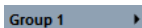

Click once to show/hide the basic track settings section. Double-click to rename the track.

Colorize Selected Track



Allows you to colorize the selected track.

Edit Channel Settings



Opens the **Channel Settings** window for the track.

Mute



Mutes the track.

Solo



Solos the track.

Read Automation



Allows you to read track automation.

Write Automation



Allows you to write track automation.

Volume



Allows you to adjust the level of the track.

Pan



Allows you to adjust the panning of the track.

Output Routing



Allows you to specify the output bus for the track.

NOTE

When you select the group folder track, the **Inspector** shows the folder and the group channels it contains. You can click one of the group channels shown in the folder to display the settings for that group channel in the **Inspector**.

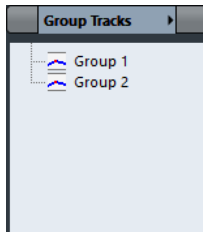

RELATED LINKS

[Inspector Sections](#) on page 98

FX Channel Tracks

You can use FX channel tracks for adding send effects. Each FX channel can contain up to eight effect processors. By routing sends from an audio channel to an FX channel, you send audio from the audio channel to the effects on the FX channel. You can place FX channel tracks in a special FX channel folder, or in the track list, outside an FX channel folder. Each FX channel has a corresponding channel in the **MixConsole**. An FX channel track can have any number of automation tracks.

You can add FX channel tracks via the **Add Track** dialog.

RELATED LINKS

[Add Track Dialog – Effect](#) on page 121

Add Track Dialog – Effect

The **Effect** page of the **Add Track** dialog allows you to set up and add FX channel tracks.

To open the **Effect** page of the **Add Track** dialog, do one of the following:

- Click **Add Track**  in the global track control area of the track list, and click **Effect**.
This opens the global **Add Track** dialog on the **Effect** page.

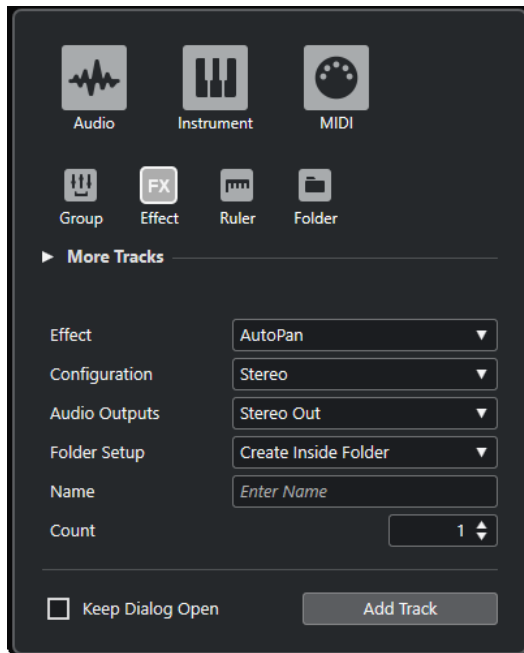

- Select **Project > Add Track > Effect**.
This opens the **Effect** page of the **Add Track** dialog.

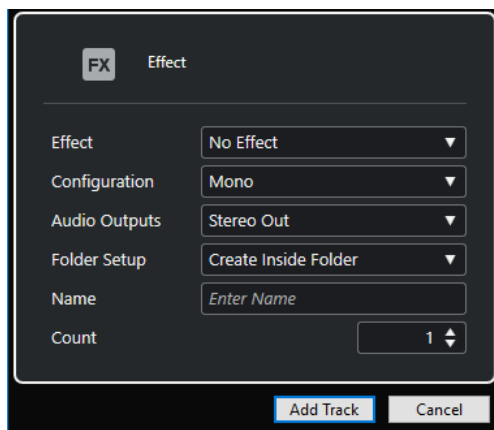

The following settings are available:

Effect

Allows you to select an effect.

Configuration

Allows you to set the channel configuration. Audio-related tracks can be configured as mono or stereo tracks.

Audio Outputs

Allows you to set the output routing.

Folder Setup

Allows you to select whether you want to create the effect inside or outside a dedicated folder.

Name

Allows you to specify a track name.

Count

Allows you to enter the number of tracks that you want to add.

Keep Dialog Open

Activate this to keep the dialog open after clicking **Add Track**. This allows you to click the page of another track type to set up and add more tracks.

NOTE

This is only available if you open the **Add Track** dialog from the global track controls.

Add Track

Adds one or more tracks, according to the track type and the settings of the active page, and closes the dialog.

RELATED LINKS

[Adding FX Channel Tracks](#) on page 338

[Adding FX Channels to Selected Channels](#) on page 339

FX Channel Track Inspector

The **Inspector** for FX channel tracks shows the settings for the FX channel. When you select the folder track instead, the **Inspector** shows the folder and the FX channels it contains. You can click one of the FX channels in the folder to display the settings for that FX channel in the **Inspector**.



Track name

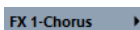

Click once to show/hide the basic track settings section. Double-click to rename the track.

Colorize Selected Track



Allows you to colorize the selected track.

Edit Channel Settings



Opens the **Channel Settings** window for the track.

Mute



Mutes the track.

Solo



Solos the track.

Read Automation



Allows you to read track automation.

Write Automation



Allows you to write track automation.

Volume



Allows you to adjust the level of the track.

Pan



Allows you to adjust the panning of the track.

Output Routing



Allows you to specify the output bus for the track.

RELATED LINKS

[Inspector Sections](#) on page 98

Ruler Track

You can use ruler tracks to show several rulers with different display formats for the timeline. This is completely independent from the main ruler, as well as from rulers and position displays in other windows.

You can add ruler tracks via the **Add Track** dialog.

RELATED LINKS

[Add Track Dialog – Ruler](#) on page 124

Add Track Dialog – Ruler

The **Ruler** page of the **Add Track** dialog allows you to set up and add ruler tracks.

To open the **Ruler** page of the **Add Track** dialog, do one of the following:

- Click **Add Track**  in the global track control area of the track list, and click **Ruler**. This opens the global **Add Track** dialog on the **Ruler** page.

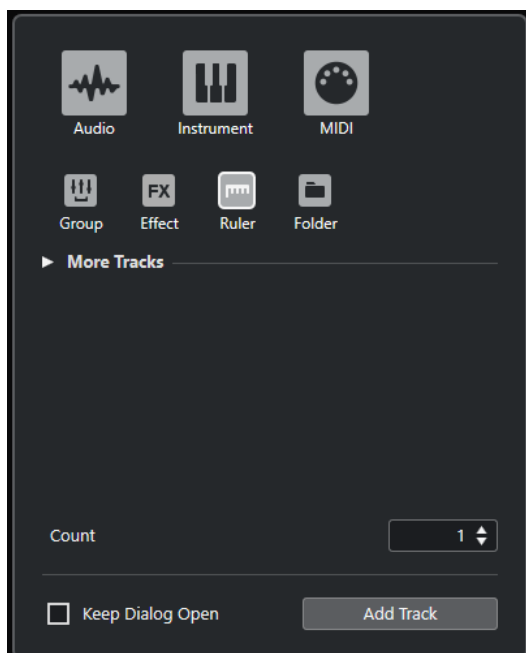

- Select **Project > Add Track > Ruler**.
This opens the **Ruler** page of the **Add Track** dialog.

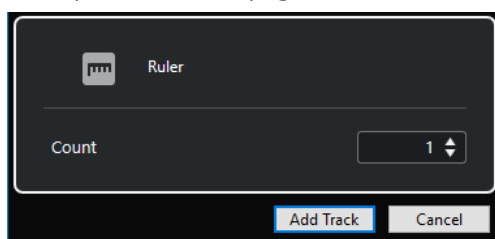

The following settings are available:

Count

Allows you to enter the number of tracks that you want to add.

Keep Dialog Open

Activate this to keep the dialog open after clicking **Add Track**. This allows you to click the page of another track type to set up and add more tracks.

NOTE

This is only available if you open the **Add Track** dialog from the global track controls.

Add Track

Adds one or more tracks, according to the track type and the settings of the active page, and closes the dialog.

Ruler Track Controls

In the track list for ruler tracks, you can change the display format for the ruler.

Click the display format to open a pop-up menu.

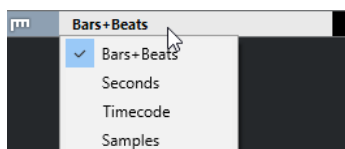

The following display formats are available:

Bars+Beats

Activates a display format of bars, beats, sixteenth notes, and ticks. By default, there are 120 ticks per sixteenth note. To adjust this, change the **MIDI Display Resolution** in the **Preferences** dialog (**MIDI** page).

Seconds

Activates a display format of hours, minutes, seconds, and milliseconds.

Timecode

Activates a display format of hours, minutes, seconds, and frames. The number of frames per second (fps) is set in the **Project Setup** dialog with the **Project Frame Rate** pop-up menu. To display subframes, activate **Show Timecode Subframes** in the **Preferences** dialog (**Transport** page).

Samples

Activates a display format of samples.

NOTE

Ruler tracks are not affected by the display format setting in the **Project Setup** dialog.

Folder Tracks

Folder tracks function as containers for other tracks, making it easier to organize and manage the track structure. They also allow you to edit several tracks at the same time.

You can add folder tracks via the **Add Track** dialog.

RELATED LINKS

[Add Track Dialog – Folder](#) on page 126

Add Track Dialog – Folder

The **Folder** page of the **Add Track** dialog allows you to set up and add folder tracks.

To open the **Folder** page of the **Add Track** dialog, do one of the following:

- Click **Add Track**  in the global track control area of the track list, and click **Folder**. This opens the global **Add Track** dialog on the **Folder** page.

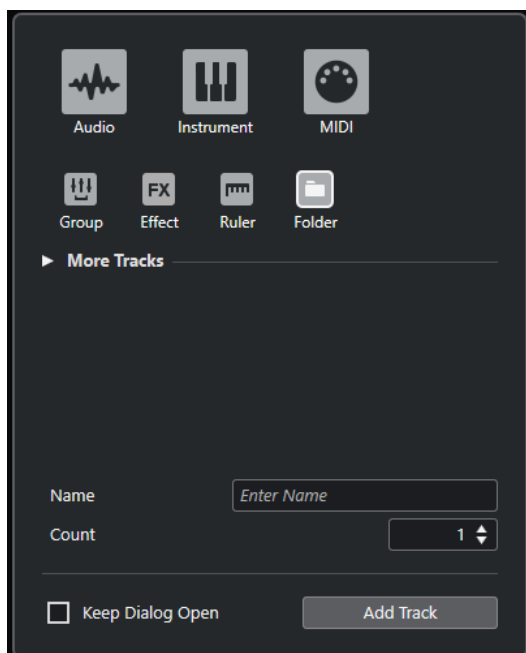

- Select **Project > Add Track > Folder**.
This opens the **Folder** page of the **Add Track** dialog.

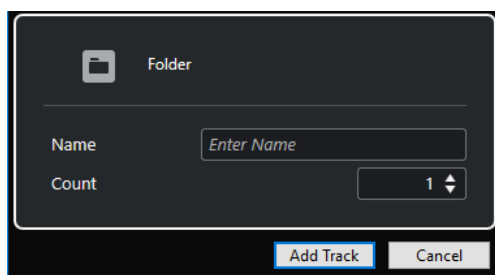

The following settings are available:

Name

Allows you to specify a track name.

Count

Allows you to enter the number of tracks that you want to add.

Keep Dialog Open

Activate this to keep the dialog open after clicking **Add Track**. This allows you to click the page of another track type to set up and add more tracks.

NOTE

This is only available if you open the **Add Track** dialog from the global track controls.

Add Track

Adds one or more tracks, according to the track type and the settings of the active page, and closes the dialog.

Folder Track Inspector

The **Inspector** for folder tracks shows the folder and its underlying track, similar to the folder structure in the File Explorer/macOS Finder. When you select one of the tracks shown under the folder, the **Inspector** shows the settings for that track.

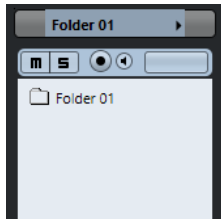

Track name



Double-click to rename the track.

Colorize Selected Track



Allows you to colorize the selected track.

Mute



Mutes the track.

Solo



Solos the track.

Record Enable



Activates the track for recording.

Monitor



For audio-related tracks, this routes incoming signals to the selected output.

For MIDI and instrument-related tracks, this allows you to route incoming MIDI signals to the selected MIDI output. For this to work, activate **MIDI Thru Active** in the **Preferences** dialog (**MIDI** page).

RELATED LINKS

[Inspector Sections](#) on page 98

Folder Track Controls

The track list for folder tracks contains controls and parameters that allow you to edit all tracks in the folder.



Expand/Collapse Folder

Shows/Hides the tracks in the folder. Hidden tracks are played back as usual.

Track name



Double-click to rename the track.

Mute



Mutes the track.

Solo



Solos the track.

Record Enable



Activates the track for recording.

Monitor



For audio-related tracks, this routes incoming signals to the selected output.

For MIDI and instrument-related tracks, this allows you to route incoming MIDI signals to the selected MIDI output. For this to work, activate **MIDI Thru Active** in the **Preferences** dialog (**MIDI** page).

Arranger Track

You can use the arranger track for arranging your project by marking out sections and determining in which order they are to be played back.

You can add this track type to a project only once.

- To add the arranger track to your project, select **Project > Add Track > Arranger**.

Arranger Track Inspector

The arranger track **Inspector** displays the lists of available arranger chains and arranger events.

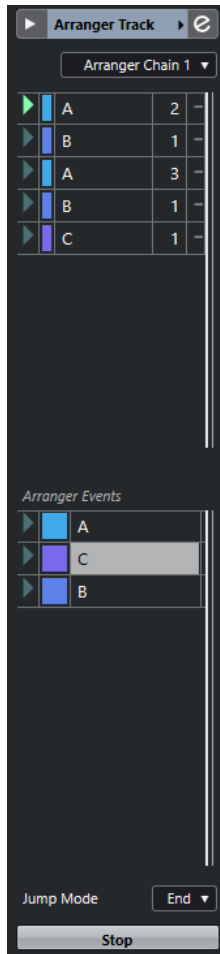

The arranger track **Inspector** contains the following settings:

Track name

Arranger Track ▶

Double-click to rename the track.

Colorize Selected Track



Allows you to colorize the selected track.

Open Arranger Editor



Opens the **Arranger Editor**.

Select Active Arranger Chain + Functions

Arranger Chain 1 ▼

Allows you to select the active arranger chain, to rename it, to create a new one, to duplicate, or to flatten it.

Current Arranger Chain

Current Arranger Chain

Shows the active arranger chain.

Arranger Events

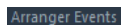

Lists all arranger events in your project. Click the arrow of an arranger event to play it back and start the live mode.

Stop



Allows you to stop the live mode.

Jump Mode

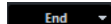

Allows you to define how long the active arranger event is played before jumping to the next one.

Arranger Track Controls

The track list for the arranger track contains controls and parameters that allow you to edit the arranger track.

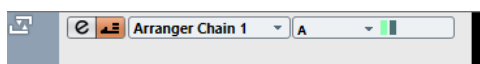

Select Active Arranger Chain

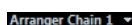

Allows you to select the active arranger chain.

Current Item/Current Repeat



Displays which arranger event and which repeat is active.

Activate Arranger Mode



Allows you to activate and to deactivate the arranger mode.

Open Arranger Editor



Opens the **Arranger Editor** for the track.

Chord Track

You can use the chord track for adding chord and scale events to your project. These can transform the pitches of other events.

You can add this track type to a project only once.

- To add the chord track to your project, select **Project > Add Track > Chord**.

Chord Track Inspector

The chord track **Inspector** contains settings for the chord events.

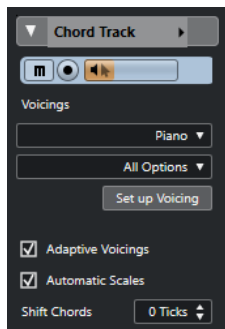

The top section of the chord track **Inspector** contains the following settings:

Track name

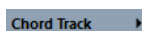

Click to show/hide the basic track settings section.

Colorize Selected Track



Allows you to colorize the selected track.

Mute Chord Track



Mutes the track.

Record Enable



Activates the track for recording.

Acoustic Feedback



Allows you to audition the events on the chord track. For this to work, you need to select a track for auditioning in the track list.

Voicing library



Allows you to set up a voicing library for the track.

Voicing library subset

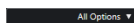

Allows you to select a library subset.

Set up Voicing



Allows you to configure your own voicing parameters for a specific voicing scheme.

Adaptive Voicings



If this option is activated, the voicings are set automatically.

Automatic Scales



If this option is activated, the program automatically creates scale events.

Shift Chords



Allows you to specify an offset value to ensure that chord events also affect the MIDI notes. Enter a negative value to affect notes that have been triggered too early. Enter a positive value to affect notes that have been triggered too late.

RELATED LINKS

[Inspector Sections](#) on page 98

Chord Track Controls

The track list for the chord track contains controls and parameters that allow you to edit the chord track.

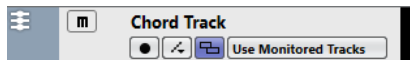

The track list for the chord track contains the following controls:

Name



Shows the name of the track. Double-click to rename the track.

Record Enable



Activates the track for recording.

Mute Chord Track



Mutes the track.

Select Track for Auditioning



Allows you to select a track for auditioning the chord events.

Resolve Display Conflicts



Allows you to show all chord events on the track properly, even at low horizontal zoom levels.

Show Scales



Allows you to show the scale lane in the lower part of the chord track.

Video Tracks

You can use the video track to play back video events. Video files are displayed as events/clips on the video track, with thumbnails representing the frames in the film.

You can add this track type only once to a project.

- To add a video track, select **Project > Add Track > Video**.

Video Track Inspector

The video track **Inspector** contains parameters to control the video track.

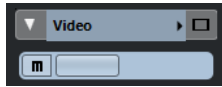

Colorize Selected Track



Allows you to colorize the selected track.

Reveal Video Window



Opens the **Video Player** window.

Mute Video Track



Mutes the track.

RELATED LINKS

[Inspector Sections](#) on page 98

Video Track Controls

The track list for the video track contains parameters to control the video track.

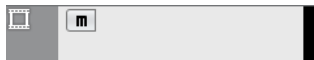

Mute Video Track



Mutes the track.

Name



Shows the name of the track. Double-click to rename the track.

Marker Track

You can use the marker track to add and edit markers that help you to locate certain positions quickly.

You can add this track type only once to a project.

- To add the marker track to your project, select **Project > Add Track > Marker**.

Marker Track Inspector

The marker track **Inspector** displays the marker list.

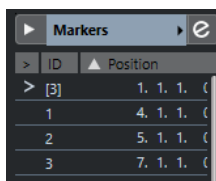

Track name

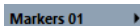

Double-click to rename the track.

Colorize Selected Track



Allows you to colorize the selected track.

Open Marker Window



Opens the **Markers** window.

Marker attributes

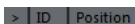

Shows the markers, their IDs, and their time positions. Click in the leftmost column for a marker to move the project cursor to the marker position.

RELATED LINKS

[Inspector Sections](#) on page 98

Marker Track Controls

The track list for the marker track contains controls and parameters that allow you to edit the marker track.



Track name



Double-click to rename the track.

Locate



Allows you to move the project cursor to the selected marker position.

Cycle



Allows you to select a cycle marker.

Zoom



Allows you to zoom in a cycle marker.

Add Marker



Allows you to add a position marker at the project cursor position.

Add Cycle Marker



Allows you to add a cycle marker at the project cursor position.

Track Handling

Tracks are the building blocks of your project. In Cubase, events and parts are placed on tracks.

Adding Tracks via the Add Track Dialog

You can add tracks via the **Add Track** dialog.

PROCEDURE

1. In the global track control area of the track list, click **Add Track** .
2. Do one of the following:
 - Click the track type and set up the options according to your needs.
 - To add other track types, open the **More Tracks** section and click the track type.
3. Click **Add Track**.

RESULT

The new track is added to the project below the selected track.

RELATED LINKS

- [Add Track Dialog – Audio](#) on page 105
- [Add Track Dialog – Instrument](#) on page 108
- [Add Track Dialog – Sampler](#) on page 112
- [Add Track Dialog – MIDI](#) on page 115
- [Add Track Dialog – Effect](#) on page 121
- [Add Track Dialog – Group Channel](#) on page 118
- [Add Track Dialog – Ruler](#) on page 124
- [Add Track Dialog – Folder](#) on page 126
- [Arranger Track](#) on page 129
- [Chord Track](#) on page 131
- [Video Tracks](#) on page 133
- [Marker Track](#) on page 134

Adding Tracks Using Track Presets

You can add tracks based on track presets. Track presets contain sound and channel settings.

PROCEDURE

1. In the global track control area of the track list, click **Use Track Preset** .
 2. Select **Using Track Preset**.
 3. In the **Choose Track Preset** dialog, select a track preset.
The number and type of the added tracks depend on the selected track preset.
 4. Click **OK**.
-

RESULT

The new tracks are added to the project below the selected track.

RELATED LINKS

[Track Presets](#) on page 148

Adding Tracks by Dragging Files from the MediaBay

You can add tracks by dragging files from the **MediaBay**.

PREREQUISITE

One of the following prerequisites must apply:

- The **MediaBay** is open. To open the **MediaBay**, press **F5**.
- The **Media** rack in the right zone of the **Project** window is open. Click **Show/Hide Right Zone** and click the **Media** tab to open it.

PROCEDURE

1. In the **MediaBay**, select the files for which you want to add tracks.
2. Drag the files into the track list.
 - The indicator highlights the position at which the new tracks will be added.
 - If you drag multiple audio files into the track list, choose if you want to place all files on one track or on different tracks.
 - If you drag multiple audio files into the track list, the **Import Options** dialog opens. It allows you to edit the import options.

RESULT

The new tracks are added at the position that was highlighted by the indicator in the track list. The audio files are inserted at the cursor position.

RELATED LINKS

[MediaBay and Media Rack](#) on page 466

[Media Rack in Right Zone](#) on page 466

[Import Options Dialog for Audio Files](#) on page 231

Exporting MIDI Tracks as Standard MIDI Files

You can export MIDI tracks as standard MIDI files. This allows you to transfer MIDI material to virtually any MIDI application on any platform.

PROCEDURE

1. Select **File > Export > MIDI File**.
 2. In the file dialog that opens, specify a location and name for the file.
 3. Click **Save**.
 4. In the **Export Options** dialog, activate the settings that you want to export, and click **OK**.
-

RESULT

The MIDI file is exported. It includes the tempo and the time signature events of the **Tempo Track Editor** or, if the tempo track is deactivated on the **Transport** panel, the current tempo and time signature.

NOTE

If you want to include **Inspector** settings that differ from those specified in the **Export Options**, use **Merge MIDI in Loop** to convert these settings to real MIDI events.

RELATED LINKS

[Export Options Dialog for MIDI Files](#) on page 138

[Merging MIDI Events into a New Part](#) on page 603

Export Options Dialog for MIDI Files

The **Export Options** for MIDI files allow you to specify what data to include in the exported MIDI files.

- To open the **Export Options** for MIDI files, select **File > Export > MIDI File**.

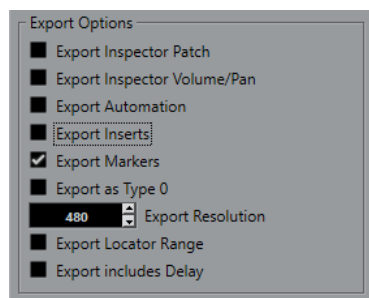

Export Inspector Patch

Includes MIDI patch settings in the **Inspector** as MIDI bank select and program change events in the MIDI file.

Export Inspector Volume/Pan

Includes volume and pan settings in the **Inspector** as MIDI volume and pan events in the MIDI file.

Export Automation

Includes automation as MIDI controller events in the MIDI file.

Export Inserts

Includes MIDI modifiers and MIDI inserts in the MIDI file.

Includes MIDI modifiers in the MIDI file.

Export Markers

Includes markers as standard MIDI file marker events in the MIDI file.

Export as Type 0

Exports a type 0 MIDI file with all data on a single track, but on different MIDI channels. If you deactivate this option, a type 1 MIDI file with data on separate tracks is exported.

Export Resolution

Allows you to set a MIDI resolution between 24 and 960 for the MIDI file. The resolution is the number of pulses, or ticks, per quarter note (PPQ) and determines the precision with which you will be able to view and edit the MIDI data. The higher the

resolution, the higher the precision. Choose the resolution based on the application or sequencer to be used, because certain applications and sequencers may not be able to handle certain resolutions.

Export Locator Range

Exports only the range between the left and the right locator.

Export includes Delay

Includes delay settings you have made in the MIDI file via the **Inspector**.

RELATED LINKS

[Automation](#) on page 500

[Markers](#) on page 270

[MIDI Track Parameters](#) on page 589

[Merging MIDI Events into a New Part](#) on page 603

[Export Options](#) on page 840

[Exporting MIDI Parts as MIDI Files](#) on page 174

Removing Selected Tracks

You can remove selected tracks from the track list.

PROCEDURE

- Select **Project > Remove Selected Tracks**.
If you delete tracks that are not empty, a warning message is displayed.

NOTE

You can deactivate this message. To reactivate the message, activate **Display Warning before Deleting Non-Empty Tracks** in the **Preferences** dialog (**Editing** page).

Removing Empty Tracks

You can remove empty tracks from the track list.

PROCEDURE

- Select **Project > Remove Empty Tracks**.
-

Moving Tracks in the Track List

You can move tracks up or down in the track list.

PROCEDURE

- Select a track and drag it up or down in the track list.
-

Renaming Tracks

You can rename tracks.

PROCEDURE

1. Double-click the track name and type in a new name for the track.
2. Press **Return**.

If you want to assign the same name to all events on the track, hold down any modifier key and press **Return**.

AFTER COMPLETING THIS TASK

If the **Parts Get Track Names** option is activated in the **Preferences** dialog (**Editing** page) and you move an event from one track to another, the moved event will automatically be named according to its new track.

Automatically Assigning Colors to New Tracks/Channels

You can automatically assign colors to newly added tracks or channels.

PROCEDURE

1. Select **Edit > Preferences**.
 2. Open the **User Interface** page, and select **Track & MixConsole Channel Colors**.
 3. Open the **Auto Track/Channel Color Mode** pop-up menu and select an option.
 4. Click **OK**.
-

RESULT

Any tracks/channels that you added by using **Add Track**, or by dragging files from the **Media** rack to the event display, are automatically colored according to your settings.

RELATED LINKS

[User Interface - Track & MixConsole Channel Colors](#) on page 847

Showing Track Pictures

You can add pictures to tracks to recognize your tracks. Track pictures are available for audio, instrument, MIDI, FX channel, and group channel tracks.

PREREQUISITE

Adjust the track height to at least 2 rows.

PROCEDURE

1. Right-click any track in the track list.
2. From the track list context menu, select **Show Track Pictures**.

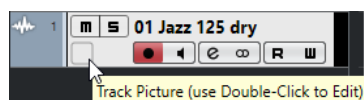

If you move the mouse to the left on a track, a highlighted rectangle appears.

3. Double-click the rectangle.

4. In the **Track Pictures Browser**, select a picture.
 5. Click **OK**.
-

RESULT

The picture is shown in the track list and in the **MixConsole** pictures section.

RELATED LINKS

[Track Pictures Browser](#) on page 141

[Adding Track Pictures to MixConsole Channels](#) on page 313

Track Pictures Browser

The **Track Pictures Browser** allows you to set up and select pictures that can be shown in the track list and in the **MixConsole**. With track pictures, you can recognize tracks and channels. You can select pictures from the factory content or add new ones to the user library.

- To open the **Track Pictures Browser** for a track, double-click the square in the lower left side of the track list.

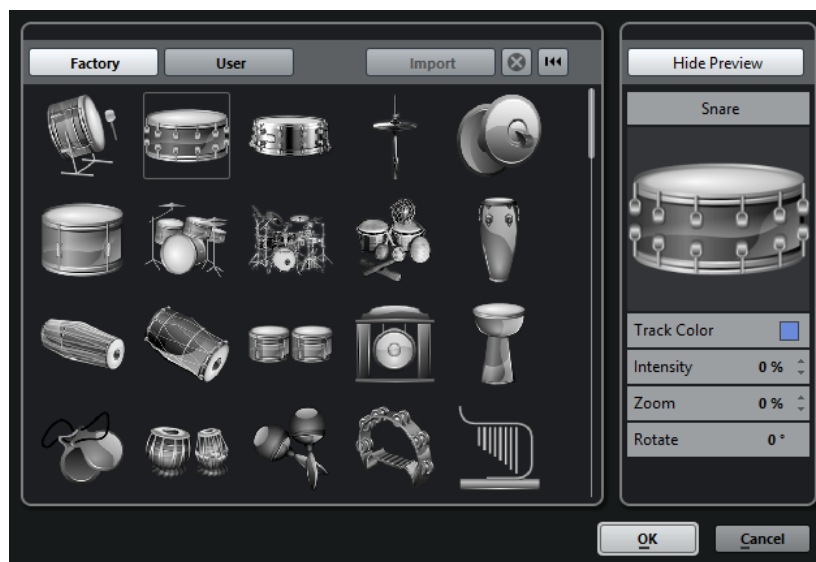

Factory

Shows the factory content in the pictures browser.

Pictures browser

Shows the pictures that you can assign to the selected track/channel.

User

Shows your user content in the pictures browser.

Import

Opens a file dialog that allows you to select pictures in bmp, jpeg, or png format and add them to the user library.

Remove Selected Pictures from User Library

Removes the selected pictures from the user library.

Reset Current Picture

Removes the picture from the selected track/channel.

Show Preview/Hide Preview

Opens/Closes a section with further color and zoom settings.

Track Picture Preview

Shows the current track picture. When you zoom in the picture, you can drag it with the mouse to change its visible part.

Track Color

Opens the **Color Picker** that allows you to select a track color.

Intensity

Allows you to apply the track color to the track picture and to set the color intensity.

Zoom

Allows you to change the size of the track picture.

Rotate

Allows you to rotate the track picture.

RELATED LINKS

[Showing Track Pictures](#) on page 140

[Adding Track Pictures to MixConsole Channels](#) on page 313

Setting the Track Height

You can enlarge the track height to show the events on the track in detail, or you can decrease the height of several tracks to get a better overview of your project.

- To change the height of an individual track, click its lower border in the track list and drag up or down.
- To change the height of all tracks simultaneously, hold down **Ctrl/Cmd**, click the lower border of one track, and drag up or down.
- To set the number of tracks to view in the **Project** window, use the track zoom menu.
- To set the track height automatically when you select a track, click **Edit > Enlarge Selected Track**.

RELATED LINKS

[Track Zoom Menu](#) on page 142

[Track Controls Settings Dialog](#) on page 99

Track Zoom Menu

The track zoom pop-up menu allows you to set the number of tracks and the track height in the **Project** window.

- To open the track zoom pop-up menu in the lower right of the **Project** window, click the arrow button above the vertical zoom control.

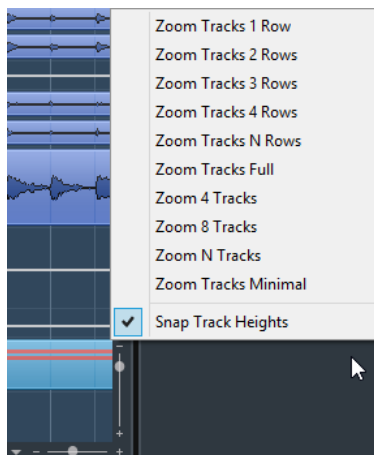

The following options are available:

Zoom Tracks x Rows

Zooms all track heights to show the specified number of rows.

Zoom Tracks Full

Zooms all tracks to fit in the active **Project** window.

Zoom Tracks N Rows

Allows you to set the number of rows to fit in the active **Project** window.

Zoom x Tracks

Zooms the specified number of tracks to fit in the active **Project** window.

Zoom N Tracks

Allows you to set the number of tracks to fit in the active **Project** window.

Zoom Tracks Minimal

Zooms all track heights to the minimum size.

Snap Track Heights

Changes the track height in fixed increments when you resize it.

Selecting Tracks

You can select one or multiple tracks in the track list.

- To select a track, click on it in the track list.
- To select several tracks, **Ctrl/Cmd**-click several tracks.
- To select a continuous range of tracks, **Shift**-click the first and last track in a continuous range of tracks.

Selected tracks are highlighted.

RELATED LINKS

[Track Selection Follows Event Selection](#) on page 829

[Scroll to Selected Track](#) on page 832

[Select Channel/Track on Solo](#) on page 832

[Select Channel/Track on Edit Settings](#) on page 832

Selecting Tracks with Arrow Keys

You can select tracks and events with the **Up Arrow** key or the **Down Arrow** key on the computer keyboard. You can also make the **Up Arrow** key and the **Down Arrow** key exclusively available for selecting tracks.

- To make the **Up Arrow** key and the **Down Arrow** key exclusively available for selecting tracks, activate **Use Up/Down Navigation Commands for Selecting Tracks Only** in the **Preferences** dialog (**Editing** page).

The following applies:

- If this option is deactivated and no event/part is selected in the **Project** window, the **Up Arrow** key and the **Down Arrow** key are used to step through the tracks in the track list.
- If this option is deactivated and an event/part is selected in the **Project** window, the **Up Arrow** key and the **Down Arrow** key still step through the tracks in the track list – but on the selected track, the first event/part is automatically selected as well.
- If this option is activated, the **Up Arrow** key and the **Down Arrow** key are only used to change the track selection – the current event/part selection in the **Project** window is not altered.

Deselecting Tracks

You can deselect tracks that are selected in the track list.

PROCEDURE

- **Shift**-click a selected track.

RESULT

The track is deselected.

Duplicating Tracks

You can duplicate a track with all of its contents and channel settings.

PROCEDURE

- Select **Project > Duplicate Tracks**.

RESULT

The duplicated track appears below the original track.

Disabling Tracks

You can disable audio, instrument, MIDI, and sampler tracks that you do not want to play back or process at the moment. Disabling a track zeroes its output volume and shuts down all disk activity and processing for the track.

PROCEDURE

1. Select the tracks that you want to disable.
2. Right-click in the track list and select **Disable Selected Tracks** from the context menu.

RESULT

The track color changes and the corresponding channel in the **MixConsole** is hidden.

To enable the disabled tracks and to restore all channel settings, right-click in the track list and select **Enable Selected Tracks**.

Freezing Multiple Tracks

You can freeze multiple selected audio, instrument, or sampler tracks.

PROCEDURE

1. In the track list, select the tracks that you want to freeze.
2. Do one of the following:
 - Select **Edit > Freeze/Unfreeze > Selected Tracks**.
 - Right-click one of the selected tracks, and from the context menu, select **Freeze/Unfreeze Selected Tracks**.

NOTE

If you select several tracks, and you click **Freeze Audio Channel**, **Freeze Instrument Channel** or **Freeze Sampler Channel** in the **Inspector**, only the active track is frozen.

3. In the **Freeze Channel Options** dialog, make your changes.

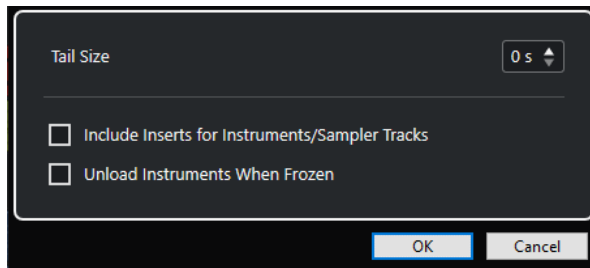

NOTE

You can also select **Edit > Freeze/Unfreeze > Selected Tracks (with Current Settings)** to freeze the tracks without showing the **Freeze Channel Options** dialog. In this case, the last settings are applied.

4. Click **OK**.
-

RESULT

- The output of the tracks are rendered to audio files, and on playback you hear the same sound as before freezing.
- Less CPU load is used.
- The **Freeze Audio Channel**, **Freeze Instrument Channel** or **Freeze Sampler Channel** buttons light up.
- The track controls are grayed out.
- The audio events and MIDI parts are locked.
- You can still adjust the level and panning, make EQ settings, and adjust the effect sends.
- The **Sampler Control** section in the lower zone of the **Project** window is disabled.

NOTE

The audio file is saved in the **Freeze** folder that can be found in the following location:

- Windows: within the **Project** folder
 - macOS: **User/Documents**
-

The freeze options are saved and used for all further freeze operations.

NOTE

In the **Key Commands** dialog in the **Edit** category, you can also assign a key command for **Freeze/Unfreeze Selected Tracks** and **Freeze/Unfreeze Selected Tracks (with Current Settings)**.

AFTER COMPLETING THIS TASK

To unfreeze the frozen tracks, select them and select **Edit > Freeze/Unfreeze > Selected Tracks** or **Edit > Freeze/Unfreeze > Selected Tracks (with Current Settings)**.

RELATED LINKS

[Freezing Insert Effects](#) on page 336

[Freezing Instruments](#) on page 520

[Freeze Channel Options Dialog for Instruments](#) on page 521

[Unfreeze Channel Options Dialog for Instruments](#) on page 522

[Freezing Sampler Tracks](#) on page 442

[Freeze Channel Options Dialog for Sampler Tracks](#) on page 442

[Unfreeze Channel Options Dialog for Sampler Tracks](#) on page 443

Organizing Tracks in Folder Tracks

You can organize your tracks in folders by moving tracks into folder tracks. This allows you to perform editing on several tracks as one entity. Folder tracks can contain any type of track, including other folder tracks.

- To add a folder track, click **Add Track** in the global track control area of the track list, and click **Folder**.
- To move tracks into a folder, select them and drag them into the folder track.
- To remove tracks from a folder, select them and drag them out of the folder.
- To hide/show tracks in a folder, click the **Expand/Collapse Folder** button of the folder track.
- To hide/show data on a folder track, open the context menu for the folder track, and select an option from the **Show Data on Folder Tracks** submenu.
- To mute/solo all tracks in a folder track, click the **Mute** or **Solo** button for the folder track.

NOTE

Hidden tracks are played back as usual.

Handling Overlapping Audio

The basic rule for audio tracks is that each track can only play back a single audio event at a time. If two or more events overlap, only the one that is in the front is played back. You can, however, select the event/region that you want to play back.

PROCEDURE

- Do one of the following:
 - Right-click the audio event in the event display and select the desired event or region from the **To Front** or **Set to Region** submenu.

NOTE

The available options depend on whether you performed a linear or a cycle recording and on the record mode you used. When recording audio in cycle mode, the recorded event is divided into regions, one for each take.

-
- Click the middle handle on the lower border of a stacked event, and select an entry from the pop-up menu.
-

Events Display on Folder Tracks

Closed folder tracks can display data of the contained audio, MIDI, and instrument tracks as data blocks or as events.

When you close folder tracks, the contents of the contained tracks are displayed as data blocks or events. Depending on the folder track height, the display of the events can be more or less detailed.

Modifying Event Display on Folder Tracks

You can modify the event display on folder tracks.

PROCEDURE

1. Right-click the folder track.
2. On the context menu, select **Show Data on Folder Tracks**.

You have the following options:

- **Always Show Data**
Always displays data blocks or event details.
- **Never Show Data**
Displays nothing.
- **Hide Data When Expanded**
Hides the display of events when you open folder tracks.
- **Show Event Details**
Displays event details instead of data blocks.

NOTE

You can change these settings in the **Preferences** dialog (**Event Display—Folders** page).

RELATED LINKS

[Event Display - Folders](#) on page 837

Track Presets

Track presets are templates that can be applied to newly created or existing tracks of the same type.

You can create them from any track types (audio, MIDI, instrument, sampler, group, FX, VST instrument return, input, and output channels). They contain sound and channel settings, and they allow you to quickly browse, preview, select, and change sounds, or to reuse channel settings across projects.

Track presets are organized in the **MediaBay**.

When you apply a track preset, all the settings that are saved in the preset are applied.

Track presets can only be applied to tracks of their own type. The only exception are instrument tracks. For these, VST presets are also available.

NOTE

- Once a track preset is applied, you cannot undo the changes. It is not possible to remove an applied preset from a track and return to the previous state. If you are not satisfied with the track settings, you have to either edit the settings manually or apply another preset.
 - Applying VST presets to instrument tracks leads to the removal of modifiers, inserts, or EQs. These settings are not stored in VST presets.
-

Audio Track Presets

Track presets for audio tracks, group tracks, FX tracks, VST instrument channels, input channels, and output channels include all the settings that define the sound.

You can use the factory presets as a starting point for your own editing and save the audio settings that you optimized for an artist you often work with as a preset for future recordings.

The following data is saved in audio track presets:

- Insert effects settings (including VST effect presets)
- EQ settings
- Volume and pan
- Input gain and phase

NOTE

To access the track presets functions for input and output channels, activate the **Write** buttons for input and output channels in the **MixConsole**. This creates input and output channel tracks in the track list.

MIDI Track Presets

You can use MIDI track presets for multitimbral VST instruments.

When creating MIDI track presets, you can either include the channel or the patch.

The following data is saved in MIDI track presets:

- MIDI modifiers (Transpose, etc.)
- Output and Channel or Program Change
- Volume and pan

- Staff settings
- Color settings
- Drum map settings

Creating a Track Preset

You can create a track preset from a single track or from a combination of tracks.

PROCEDURE

1. In the **Project** window, select one or more tracks.
2. In the track list, right-click one of the selected tracks and select **Save Track Preset**.
3. In the **New Preset** section, enter a name for the new preset.

NOTE

You can also define attributes for the preset.

-
4. Click **OK** to save the preset and exit the dialog.
-

RESULT

Track presets are saved within the application folder in the track presets folder. They are saved in default subfolders, named according to their track type: audio, MIDI, instrument, and multi.

Loading Presets for Tracks

You can choose from a variety of track presets.

PROCEDURE

1. In the **Inspector**, click the **Preset Management** icon on the right side of the **Inserts** section.
 2. Select **From Track Preset**.
 3. In the **Results** browser, double-click a track preset to apply it.
-

RELATED LINKS

[Track Presets](#) on page 148

Loading Presets for VST Instruments

When working with VST instruments, you can choose from a variety of presets via the **Results** browser.

PROCEDURE

1. In the track list, right-click the instrument track and select **Load Track Preset**.
 2. In the **Results** browser, double-click a preset to apply it.
-

Instrument Track Presets

Instrument track presets offer both MIDI and audio features and are the best choice when handling sounds of simple, mono-timbral VST instruments.

Use instrument track presets to audition your tracks or to save your preferred sound settings, for example. You can also extract sounds from instrument track presets to use them in instrument tracks.

The following data is saved in instrument track presets:

- Audio insert effects
- Audio EQ
- Audio volume and pan
- MIDI insert effects
- MIDI track parameters
- The VST instrument used for the track
- Staff settings
- Color settings
- Drum map settings

VST Presets

VST instrument presets behave like instrument track presets. You can extract sounds from VST presets to use them in instrument tracks.

The following data is saved in VST instrument presets:

- VST instrument
- VST instrument settings

NOTE

Modifiers, inserts, and EQ settings are not saved.

VST effect plug-ins are available in VST 3 and VST 2 format.

NOTE

In this manual, VST presets stands for VST 3 instrument presets, unless stated otherwise.

Extracting the Sound from an Instrument Track or VST Preset

For instrument tracks, you can extract the sound of an instrument track preset or VST preset.

PROCEDURE

1. Select the instrument track to which you want to apply a sound.
 2. In the **Inspector**, click **Extract Sound from Track Preset**.
 3. In the preset browser, select an instrument track preset or a VST preset.
 4. Double-click the preset to load the settings.
-

RESULT

The VST instrument and its settings (but no inserts, EQs, or modifiers) on the existing track are overwritten with the data of the track preset. The previous VST instrument for this instrument track is removed. The new VST instrument is set up for the instrument track.

Multi-Track Presets

You can use multi-track presets, for example, when recording setups that require several microphones (a drum set or a choir, where you always record under the same conditions), and you have to edit the resulting tracks in a similar way. Furthermore, they can be used when working with layered tracks, where you use several tracks to generate a certain sound instead of manipulating only one track.

If you select more than one track when creating a track preset, the settings of all selected tracks are saved as a single multi-track preset. Multi-track presets can only be applied if the target tracks are of the same type, number, and sequence as the tracks in the track preset. Therefore, they should be used in recurring situations with similar tracks and settings.

Loading Multi-Track Presets

You can apply multi-track presets to several selected tracks.

PROCEDURE

1. In the **Project** window, select several tracks.

NOTE

Multi-track presets can only be applied if track type, number, and sequence are identical for the selected tracks and the track preset.

2. In the track list, right-click a track and select **Load Track Preset**.
3. In the preset browser, select a multi-track preset.
4. Double-click the preset to load it.

RESULT

The preset is applied.

Sampler Track Presets

You can use sampler track presets to reuse created sounds in later projects or newly created sampler tracks.

The following data is saved in sampler track presets:

- Audio insert effects
- Audio EQ
- Audio volume and pan
- MIDI track parameters
- Color settings

RELATED LINKS

[Sampler Tracks](#) on page 112

Creating a Sampler Track Preset

You can create a sampler track preset from a sampler track or you can use the **Sampler Control** toolbar.

PROCEDURE

1. In the **Sampler Control** toolbar, click **Preset Management** .
2. Click **Save Track Preset**.
3. In the **Save Track Preset** dialog, type in a name for the new preset.
4. Click **OK** to save the preset and to exit the dialog.

RESULT

The new sampler track preset is saved. It is displayed in the **Preset Name** field on the info line. Sampler track presets are saved within the application folder of the sampler track presets folder.

RELATED LINKS

[Creating a Track Preset](#) on page 149

Loading Track or VST Presets

You can apply track or VST presets to selected tracks.

PROCEDURE

1. In the **Project** window, select a track.
2. Do one of the following:
 - In the **Inspector**, click **Load Track Preset**.
 - In the track list, right-click the track and select **Load Track Preset**.
 - In the **Sampler Control** toolbar, click the **Preset Management** button next to the **Preset Name** field and select **Load Track Preset**.
3. In the preset browser, select a track, VST, or sampler track preset.
4. Double-click the preset to load it.

RESULT

The preset is applied.

NOTE

You can also drag and drop track presets from the **MediaBay** or from the File Explorer/macOS Finder onto a track of the same type.

RELATED LINKS

[Filters Section](#) on page 491

Parts and Events

Parts and events are the basic building blocks in Cubase.

Events

In Cubase, you can view and edit most event types on their specific tracks in the **Project** window.

You can add events by importing or recording.

RELATED LINKS

[Audio Regions](#) on page 155

[MIDI Events](#) on page 156

Audio Events

Audio events are created automatically when you record or import audio in the **Project** window.

You can view and edit audio events in the **Project** window and in the **Sample Editor**.

An audio event triggers the playback of the corresponding audio clip. By adjusting the **Offset** and the **Length** values of the event, you can determine which section of the audio clip is played back. The audio clip itself remains unchanged.

RELATED LINKS

[Project Window](#) on page 34

[Sample Editor](#) on page 380

[Audio Files and Audio Clips](#) on page 154

[Basic Recording Methods](#) on page 211

Creating Audio Events

You can create audio events by recording or importing audio into the **Project** window.

PROCEDURE

- Do one of the following:
 - Record some audio.
 - Select **File > Import > Audio File** to import an audio file from your hard disk or from any external storage device.
 - Select **File > Import > Audio CD** to import an audio file from an audio CD.
 - Select **File > Import > Audio from Video File** to import audio from a video file on your hard disk or from any external storage device.
 - Drag an audio file from the **MediaBay**, the **Audio Part Editor**, or the **Sample Editor**, and drop it in the event display.
 - Copy an event from a different Cubase project, and paste it in the event display.
-

RELATED LINKS

- [Basic Recording Methods](#) on page 211
- [Audio File Import](#) on page 231
- [Importing Audio CD Tracks](#) on page 234
- [Importing Audio from Video Files](#) on page 236
- [MediaBay and Media Rack](#) on page 466
- [Audio Part Editor](#) on page 411
- [Sample Editor](#) on page 380

Creating New Files From Events

An audio event plays a section of an audio clip, which, in turn, refers to one or more audio files on the hard disk. However, you can create a new file that consists only of the section that is played by the event.

PROCEDURE

1. Select one or several audio events.
2. Set up fade in, fade out, and event volume.
These settings will be applied to the new file.
3. Select **Audio > Bounce Selection**.
You are asked whether you want to replace the selected event or not.
4. Do one of the following:
 - To create a new file that only contains the audio in the original event, click **Replace**.
 - To create a new file and add a clip for the new file to the **Pool**, click **No**.

RESULT

If you clicked **Replace**, a clip for the new file is added to the **Pool**, and the original event is replaced by a new event playing the new clip.

If you clicked **No**, the original event is not replaced.

NOTE

You can also apply the **Bounce Selection** function to audio parts. In that case, the audio of all events in the part is combined to a single audio file. If you select **Replace** when asked, the part is replaced with a single audio event playing a clip of the new file.

RELATED LINKS

- [Event-Based Fades](#) on page 250

Audio Files and Audio Clips

In Cubase, audio editing and processing are non-destructive.

When you edit or process audio in the **Project** window, the audio file on the hard disk remains untouched. Instead, your changes are saved to an audio clip that is automatically created on import or during recording, and that refers to the audio file. This allows you to undo changes or revert to the original version.

If you apply processing to a specific section of an audio clip, a new audio file that contains only this section is created. The processing is applied to the new audio file only, and the audio clip is automatically adjusted, so that it refers both to the original file and to the new, processed file. During playback, the program will switch between the original file and the processed file at the

correct positions. You will hear this as a single recording, with processing applied to one section only.

This allows you to undo processing at a later stage, and to apply different processing to different audio clips that refer to the same original file.

You can view and edit audio clips in the **Pool**.

RELATED LINKS

[Pool](#) on page 446

[Audio Regions](#) on page 155

[Replacing Clips in Events](#) on page 155

Replacing Clips in Events

You can replace the clips in audio events.

PROCEDURE

- Do one of the following:
 - Hold down **Shift**, drag an audio file from the File Explorer/macOS Finder, and drop it onto the event.
 - Click a clip in the **Pool**, hold down **Shift**, and drop it onto the event.

RESULT

The clip in the event is replaced. However, the event edits remain unchanged. If the new clip is shorter than the replaced clip, the length of the event is adapted. If the new clip is longer than the replaced clip, the length of the event stays the same.

RELATED LINKS

[Inserting Clips into a Project via Drag and Drop](#) on page 453

Audio Regions

Cubase allows you to create audio regions within audio clips to mark important sections in the audio.

You can view audio regions in the **Pool**. You can create and edit them in the **Sample Editor**.

NOTE

If you want to use an individual audio file in different contexts, or if you want to create several loops from one audio file, convert the corresponding regions of the audio clip to events and bounce them into separate audio files. This is necessary because different events that refer to the same clip access the same clip information.

RELATED LINKS

[Pool](#) on page 446

[Regions List](#) on page 393

Creating Regions

You can create regions from several selected audio events or from selection ranges.

PROCEDURE

1. Select several audio events or selection ranges.
2. Select **Audio > Advanced > Event or Range as Region**.
3. In the **Create Regions** dialog, enter a name for the regions, and click **OK**.

RESULT

A region is created in the corresponding clip, with the start and the end position of the region determined by the start and the end position of the event or selection range within the clip.

RELATED LINKS

[Creating Regions](#) on page 394

Creating Events from Regions

You can create events from regions, which replace the original event.

PROCEDURE

1. Select an audio event whose clip contains regions within the boundaries of the event.
2. Select **Audio > Advanced > Events from Regions**.

RESULT

The original event is removed and replaced by events positioned and sized according to the regions.

MIDI Events

MIDI events are created automatically when you record or import MIDI in the **Project** window.

You can view and edit MIDI events in the **Key Editor**, the **Drum Editor**, or the **Score Editor**.

RELATED LINKS

[Project Window](#) on page 34

[Key Editor](#) on page 643

[Drum Editor](#) on page 685

[Score Editor](#) on page 672

[Basic Recording Methods](#) on page 211

Creating MIDI Events

You can create MIDI events by recording or importing MIDI into the **Project** window.

PROCEDURE

- Do one of the following:
 - Record MIDI.
 - Select **File > Import > MIDI File** to import a MIDI file from your hard disk.
 - Drag a MIDI file from the File Explorer/macOS Finder, from one of the MIDI editors, or from the **MediaBay**, and drop it into the event display.

- Copy an event from a different Cubase project and paste it in the event display.
-

RELATED LINKS

[Basic Recording Methods](#) on page 211

[Importing MIDI Files](#) on page 239

[MIDI Editors](#) on page 614

[MediaBay and Media Rack](#) on page 466

Parts

Parts are containers for MIDI or audio events and for tracks.

RELATED LINKS

[Audio Parts](#) on page 157

[MIDI Parts](#) on page 157

[Folder Parts](#) on page 158

Audio Parts

Audio parts are containers for audio events. If you want to treat several audio events as one unit in the **Project** window, you can convert them to a part.

You can create audio parts in the following ways:

- Select the **Draw** tool and draw on the audio track.
- Press **Alt/Opt**, select the **Object Selection** tool, and draw on the audio track.
- Select the **Object Selection** tool, and double-click on the audio track, between the left and right locator.
- Select several audio events on an audio track, and select **Audio > Events to Part**.

NOTE

To make the events appear as independent objects on the track again, select the part, and select **Audio > Dissolve Part**.

RELATED LINKS

[Audio Part Editor](#) on page 411

MIDI Parts

A MIDI part is automatically created when you record. It contains the recorded events.

However, you can also create empty MIDI parts in the following ways:

- Select the **Draw** tool and draw on the MIDI track.
- Press **Alt/Opt**, select the **Object Selection** tool, and draw on the MIDI track.
- Select the **Object Selection** tool, and double-click on the MIDI track, between the left and the right locator.

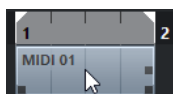

Folder Parts

A folder part is a graphic representation of events and parts on the tracks in the folder.

Folder parts indicate the time position as well as the vertical track position. If part colors are used, these are also shown in the folder part.

Any editing that you perform on a folder part affects all the events and parts it contains. Tracks inside a folder can be edited as one entity.

NOTE

To edit the individual tracks within the folder, you can double-click the folder part. This opens the editors for the events and parts that are present on the tracks.

RELATED LINKS

[Event Colors Menu](#) on page 615

Editing Techniques for Parts and Events

This section describes techniques for editing in the **Project** window. If not explicitly stated, all descriptions apply to both events and parts, even though we use the term event for convenience.

In the **Project** window, you can edit events using the following techniques:

- By selecting and using one of the tools in the **Project** window toolbar.

NOTE

Some editing tools feature additional functions if you press modifier keys. You can customize the default modifier keys in the **Preferences** dialog (**Editing—Tool Modifiers** page).

- By opening the **Edit** menu and selecting one of the functions.
- By editing on the info line.
- By using a key command.

NOTE

Snap is taken into account.

RELATED LINKS

[Editing Tool Modifiers](#) on page 833

Auditioning Audio Parts and Events

You can audition audio parts and events in the **Project** window by using the **Audition** tool.

PROCEDURE

1. On the **Project** window toolbar, click **Play** and select **Play**.
 2. Click where you want playback to start, and keep the mouse button pressed.
 3. Optional: Select **Media > MediaBay**, and in the **Previewer** section, adjust the **Preview Level**.
-

RESULT

The track on which you click is played back, starting at the click position. Playback is stopped when you release the mouse button.

NOTE

When auditioning, the **Main Mix** bus is always used for monitoring.

RELATED LINKS

[Project Window Toolbar](#) on page 36

[Previewer Section](#) on page 487

Scrubbing

The **Scrub** tool allows you to locate positions in events by playing back, forwards or backwards.

PROCEDURE

1. Click **Play**.
 2. Click again to open a pop-up menu.
 3. Select **Scrub**.
 4. Click the event and keep the mouse button pressed.
 5. Drag to the left or right.
-

RESULT

The project cursor moves correspondingly, and the event is played back. The speed and the pitch of the playback depend on how fast you move the mouse.

NOTE

Insert effects are bypassed when scrubbing with the mouse.

RELATED LINKS

[Project Window Toolbar](#) on page 36

Scrub Tool

Scrubbing can be quite a burden on your system. If playback problems occur, open the **Preferences** dialog (**Transport—Scrub** page), and deactivate **Use High Quality Scrub Mode**. This lowers the resampling quality but makes scrubbing less demanding on the processor, especially with large projects.

In the **Preferences** dialog (**Transport—Scrub** page), you can also adjust the **Scrub** volume.

Selecting with the Object Selection Tool

PROCEDURE

1. Click **Object Selection**.
2. In the event display, click the events that you want to select.

NOTE

You can also use the **Up Arrow**, **Down Arrow**, **Left Arrow** or **Right Arrow** keys on the computer keyboard to select the event on the upper or lower track or the previous or next event on the same track.

RELATED LINKS

[Project Window Toolbar](#) on page 36

[Event Display](#) on page 834

Select Submenu

If the **Object Selection** tool is selected, the **Select** submenu features specific options for selecting events in the **Project** window.

- To open the **Select** submenu, select **Edit > Select**.

All

Selects all events in the **Project** window.

None

Deselects all events in the **Project** window.

Invert

Inverts the selection. All selected events are deselected, and all events that were not selected are selected instead.

In Loop

Selects all events that are partly or wholly between the left and right locator.

From Start to Cursor

Selects all events that end to the left of the project cursor.

From Cursor to End

Selects all events that start to the right of the project cursor.

Equal Pitch all Octaves/Equal Pitch same Octave

These functions are available in the MIDI editors and the **Sample Editor**.

Select Controllers in Note Range

This function is available in the MIDI editors.

All on Selected Tracks

Selects all events on the selected track.

Events under Cursor

Automatically selects all events on the selected tracks that are touched by the project cursor.

Select Event

This function is available in the **Sample Editor**.

Left Selection Side to Cursor/Right Selection Side to Cursor

These functions are only used for range selection editing.

NOTE

- When the **Range Selection** tool is selected, the **Select** submenu features different functions.
-

RELATED LINKS

[Select Menu for Selection Ranges](#) on page 175

[Range Editing](#) on page 391

[Event Display](#) on page 834

Removing Events

You can remove events from the **Project** window.

PROCEDURE

- To remove an event from the **Project** window, do one of the following:
 - On the **Project** window toolbar, activate **Erase** and click the event.
 - In the event display, select the events and select **Edit > Delete**.
 - In the event display, select the events and press **Backspace**.
-

RELATED LINKS

[Project Window Toolbar](#) on page 36

Event Movement Options

Cubase provides several methods to move events in the **Project** window.

You can move events using any of the following methods:

- Use the **Object Selection** tool.
- Use the **Nudge** buttons.
- Select **Edit > Move**, and select one of the options.
- Select the event, and edit the start position on the info line.

RELATED LINKS

[Moving Events with the Object Selection Tool](#) on page 161

[Moving Events with the Nudge Buttons](#) on page 162

[Move Submenu](#) on page 164

[Moving Events via the Info Line](#) on page 165

Moving Events with the Object Selection Tool

You can select one or several events with the **Object Selection** tool and drag them to a new position.

PROCEDURE

1. Select **Object Selection** .
2. Click the events that you want to move, and drag them to a new position.

NOTE

You can only drag events to tracks of the same type. If you hold down **Ctrl/Cmd** while dragging, you can restrict the movement either horizontally or vertically.

RESULT

The events are moved. If you moved several events, their relative positions are kept.

NOTE

To avoid accidentally moving events when you click them in the **Project** window, when you move an event by dragging, the response is slightly delayed. You can adjust this delay with the **Drag Delay** setting in the **Preferences** dialog (**Editing** page).

Moving Events with the Nudge Buttons

You can move one or several selected events by using the nudge buttons on the **Project** window toolbar.

PREREQUISITE

You have activated the **Nudge** section in the **Project** window toolbar.

PROCEDURE

1. Click the points to the right of the **Nudge** section.

The **Nudge** buttons become available.



2. In the event display, select the events that you want to move, and do one of the following:
 - Click **Move Left** or use the corresponding key command **Ctrl/Cmd - Left Arrow** to move the events to the left.
 - Click **Move Right** or use the corresponding key command **Ctrl/Cmd - Right Arrow** to move the events to the right.
-

RESULT

The selected events or parts are moved.

RELATED LINKS

[Setting up a Snap Grid for Nudge Operations](#) on page 163

[Project Window Toolbar](#) on page 36

[Snap Grid](#) on page 71

[Ruler](#) on page 44

[Ruler Display Format Menu](#) on page 44

[Grid Type Menu](#) on page 70

Setting up a Snap Grid for Nudge Operations

You can set up an independent snap grid just for nudge operations. This way, you can perform all editing with the mouse using a musical (tempo-related) grid that is set to **Bars+Beats** while all nudge operations and corresponding key commands are based on a linear (time-related) grid.

PREREQUISITE

The primary time format on the **Transport** panel is set to **Bars+Beats**. Your project contains some parts or events that you want to move to a time-related position.

PROCEDURE

1. Right-click the **Project** window toolbar and activate **Nudge**.

The **Nudge Settings** become available on the toolbar.

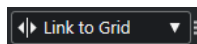

2. Open the **Nudge Settings** pop-up menu to select a time-related format for your nudge operations.



The settings **Link to Grid** and **Link to Primary Time Format** are deactivated.

3. Optional: Select **Project > Add Track > Ruler** to add a ruler track. In the track list for the ruler track, select the same display format as for your nudge operations.

This is not necessary, but it helps you to get visual control over your nudge operations.

4. On the **Project** window toolbar, click the points to the right of the **Nudge Settings** section.

The **Nudge** buttons become available.



5. In the event display, select the events or parts that you want to move, and do one of the following:

- To nudge the events to the left, click **Move Left** or use the corresponding key command **Ctrl/Cmd - Left Arrow**.
 - To nudge the events to the right, click **Move Right** or use the corresponding key command **Ctrl/Cmd - Right Arrow**.
-

RESULT

The selected events or parts that you nudged are moved. They snap to the linear grid that you set in the **Nudge Settings** pop-up menu. If you now move some events or parts using the mouse, these will snap to the musical grid that you set with the primary time format.

RELATED LINKS

[Selecting the Primary Time Format](#) on page 201

[Ruler Track Controls](#) on page 125

[Snap Grid](#) on page 71

[Nudge](#) on page 39

[Moving Events with the Nudge Buttons](#) on page 162

[Resizing Events with the Nudge Buttons](#) on page 167

[Resizing Events Using the Nudge Settings](#) on page 168

Move Submenu

If the **Object Selection** tool is selected, the **Move** submenu features options for moving events to specific positions in the **Project** window.

- To open the **Move** submenu, select **Edit > Move**.

The following options are available:

Event Starts to Cursor

Moves the starts of the selected events to the project cursor position. If you selected several events on the same track, the subsequent events keep their relative position.

Event Ends to Cursor

Moves the ends of the selected events to the project cursor position. If you selected several events on the same track, the subsequent events keep their relative position.

Events to Origin

Moves the selected events to the positions at which they were originally recorded.

Events to Selected Track

Moves the selected events to separate tracks, starting on the selected track. The events are placed at their current positions.

Events to Front

Moves the selected events to the front. This is useful if you have overlapping audio events and you want to play back another event.

Events to Back

Moves the selected events to the back. This is useful if you have overlapping audio events and you want to play back another event.

Moving Events via the Info Line

You can move a selected event by changing its start value on the info line.

PROCEDURE

1. Select the event that you want to move.
2. On the info line, double-click the **Start** field, and enter a new value for the event start.

RESULT

The event is moved by the set value.

Renaming Events

PROCEDURE

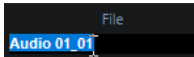
- Do one of the following:
 - Select the events, and type in a new name in the **File** field on the info line.
- 
- Change the track name, hold down a modifier key, and press **Return** to rename all events according to the track.

Event Resize Options

You can resize events by moving their start or end positions individually.

To resize events, you can use the **Object Selection**, the **Scrub** tool or the **Nudge** buttons.

Resizing also works if the **Combine Selection Tools** mode is active.

IMPORTANT

When resizing events, automation data is not taken into account.

RELATED LINKS

- [Resizing Events with the Object Selection Tool - Normal Sizing](#) on page 165
- [Resizing Events with the Object Selection Tool - Sizing Moves Contents](#) on page 166
- [Resizing Events with the Object Selection Tool - Sizing Applies Time Stretch](#) on page 166
- [Resizing Events with the Nudge Buttons](#) on page 167
- [Resizing Events with the Scrub Tool](#) on page 168
- [Snap Function](#) on page 68

Resizing Events with the Object Selection Tool - Normal Sizing

You can move the start or end point of the event.

PROCEDURE

1. Select **Object Selection**.
2. Click the **Object Selection** tool again, and select **Normal Sizing** from the pop-up menu.
3. Click and drag the lower left or right corner of the event.



NOTE

If your event contains fades and you want to adapt their length while sizing the event, hold down **Ctrl/Cmd - Alt/Opt**.

RESULT

The event is resized and, depending on where you dragged, more or less of the content is revealed. If several events are selected, they are all resized in the same way.

RELATED LINKS

[Project Window Toolbar](#) on page 36

[Editing - Tool Modifiers](#) on page 832

Resizing Events with the Object Selection Tool - Sizing Moves Contents

You can move the start or end point of the event and move the content.

PROCEDURE

1. Select **Object Selection**.
2. Click the **Object Selection** tool again, and select **Sizing Moves Contents** from the pop-up menu.
3. Click and drag the lower left or right corner of the event.



RESULT

The event is resized, and the content follows. If several events are selected, they are all resized in the same way.

RELATED LINKS

[Project Window Toolbar](#) on page 36

Resizing Events with the Object Selection Tool - Sizing Applies Time Stretch

You can move the start or the end point of the event and time-stretch the content to fit the new event length.

PROCEDURE

1. Select **Object Selection**.
 2. Click the **Object Selection** tool again, and select **Sizing Applies Time Stretch** from the pop-up menu.
 3. Click and drag the lower left or right corner of the event.
-

RESULT

The part is stretched or compressed to fit the new length.

- If you resize MIDI parts, the note events are stretched (moved and resized). Controller data are stretched, too.
- If you resize audio parts, the events are moved, and the referenced audio files are time-stretched to fit the new length.
If several events are selected, they are all resized in the same way.

RELATED LINKS

[Time Stretch](#) on page 367

[Project Window Toolbar](#) on page 36

Resizing Events with the Nudge Buttons

You can change the start or the end position of events. The setting on the **Grid Type** pop-up menu applies.

PREREQUISITE

The **Object Selection** tool is set to **Normal Sizing** or **Sizing Moves Contents**.

PROCEDURE

1. Right-click the **Project** window toolbar and activate **Nudge**.

The **Nudge Settings** become available on the toolbar.

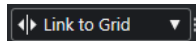

2. Click the points to the right of the section.

The **Nudge** buttons become available.



3. Select the event.

4. Do one of the following:

- Click **Nudge Start Left** or use the corresponding key command **Alt/Opt - Left Arrow** to move the event start to the left.
- Click **Nudge Start Right** or use the corresponding key command **Alt/Opt - Shift - Right Arrow** to move the event start to the right.
- Click **Nudge End Left** or use the corresponding key command **Alt/Opt - Shift - Left Arrow** to move the event end to the left.
- Click **Nudge End Right** or use the corresponding key command **Alt/Opt - Right Arrow** to move the event end to the right.

RESULT

The start or end position of the selected events is moved, and the setting on the **Grid Type** pop-up menu applies.

RELATED LINKS

[Project Window Toolbar](#) on page 36

[Resizing Events Using the Nudge Settings](#) on page 168

[Setting up a Snap Grid for Nudge Operations](#) on page 163

[Ruler](#) on page 44

[Ruler Display Format Menu](#) on page 44
[Grid Type Menu](#) on page 70

Resizing Events Using the Nudge Settings

You can move the start or the end position of events. The setting on the **Nudge Settings** pop-up menu applies.

PREREQUISITE

The **Object Selection** tool is set to **Normal Sizing** or **Sizing Moves Contents**.

PROCEDURE

1. Right-click the **Project** window toolbar and activate **Nudge**.

The **Nudge Settings** become available on the toolbar.

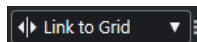

2. Open the **Nudge Settings** pop-up menu, and activate a format and a value for your operations.

3. Click the points to the right of the section.

The **Nudge** buttons become available.



4. Select the event.

5. Do one of the following:

- Click **Nudge Start Left** or use the corresponding key command **Alt/Opt - Left Arrow** to move the event start to the left.
 - Click **Nudge Start Right** or use the corresponding key command **Alt/Opt - Shift - Right Arrow** to move the event start to the right.
 - Click **Nudge End Left** or use the corresponding key command **Alt/Opt - Shift - Left Arrow** to move the event end to the left.
 - Click **Nudge End Right** or use the corresponding key command **Alt/Opt - Right Arrow** to move the event end to the right.
-

RESULT

The start or the end position of the selected events is moved, and the setting on the **Nudge Settings** pop-up menu applies.

RELATED LINKS

[Setting up a Snap Grid for Nudge Operations](#) on page 163
[Selecting the Primary Time Format](#) on page 201
[Snap Grid](#) on page 71
[Resizing Events with the Nudge Buttons](#) on page 167

Resizing Events with the Scrub Tool

You can scrub the event when moving the start or the end point of the event.

PROCEDURE

1. Click **Play**.
2. Click **Play** again to open a pop-up menu.

3. Select **Scrub**.
 4. Click and drag the lower left or right corner of the event.
-

RESULT

The event is resized, and you get an acoustic feedback while dragging.

RELATED LINKS

[Project Window Toolbar](#) on page 36

Splitting Events

PROCEDURE

- Do one of the following:
 - Select **Split**, and click the event that you want to split.
 - Select **Object Selection**, hold down **Alt/Opt**, and click the event.
 - Move the project cursor to the position where you want to split the events, and select **Edit > Functions > Split at Cursor**.

NOTE

This splits all events on all tracks that are intersected by the project cursor. If you select specific events, only these events are split.

- Set up the left and right locators at the position where you want to split the events, and select **Edit > Functions > Split Loop**.

NOTE

This splits all events on all tracks that are intersected by the locators. If you select specific events, only these events are split.

RESULT

The events are split.

NOTE

If you split a MIDI part so that the split position intersects one or several MIDI notes and **Split MIDI Events** is activated in the **Preferences** dialog (**Editing—MIDI** page), the intersected notes are split and new notes are created at the beginning of the second part. If **Split MIDI Events** is deactivated, the notes remain in the first part, but stick out after the end of the part.

RELATED LINKS

[Project Window Toolbar](#) on page 36

Splitting Events Repeatedly

You can repeatedly split events into multiple events of equal size.

PROCEDURE

- Select **Split** , hold down **Alt/Opt**, and click the event where you want to make the first split.

RESULT

The event is automatically split into as many equal events as the length of the original event allows.

Gluing Events

In the **Project** window, you can glue two or more events on the same track.

PROCEDURE

- Do one of the following:
 - Select the events that you want to glue, and select **Edit > Glue**.
 - Select **Glue**, and click the event that you want to glue to the next event.
 - Select **Glue**, hold down **Alt/Opt**, and click the event that you want to glue to all following events.

RESULT

The events are glued together.

NOTE

If you first split an audio event and then glue the parts together again, an event is created. In any other case, a part is created.

RELATED LINKS

[Project Window Toolbar](#) on page 36

Pasting Events

You can paste events from the clipboard.

PROCEDURE

- Do one of the following:
 - Select the events, and select **Edit > Functions > Paste at Origin** to paste the event at the same position from which you cut or copied it.
 - Select the events, select the track where you want to paste them, and select **Edit > Functions > Paste Relative to Cursor** to paste the events while keeping their relative position to the project cursor.

RESULT

If you paste an audio event, it is inserted on the selected track, positioned so that its snap point is aligned with the cursor position.

If the selected track is of the wrong type, the event is inserted on its original track.

Pasting Events to Matching Track Names

You can copy events in one project and paste them at the first track that matches the exact track name in another project.

PROCEDURE

1. Copy the events in one project.
2. Activate the project where you want to paste the events.
3. Select **Edit > Functions > Paste to Matching Track Name**.

RESULT

The events are inserted on the track with the name that exactly matches the original track name. For all events that have no matching track name, new tracks are created.

Duplicating Events

In the **Project** window, you can duplicate selected events.

PROCEDURE

- Select the event and do one of the following:
 - Select **Edit > Functions > Duplicate**.
 - Hold down **Alt/Opt**, and drag the event to a new position.

NOTE

If you hold down **Ctrl/Cmd** as well, direction of the movement is restricted to either horizontal or vertical.

RESULT

A copy of the selected event is created and placed after the original. If several events are selected, all of these are copied as one unit, maintaining the relative distance between the events.

NOTE

If you duplicate audio events, the copies always refer to the same audio clip.

Repeating Events

PROCEDURE

- Do one of the following:
 - Select the events, and select **Edit > Functions > Repeat** to open the **Repeat Events** dialog, which allows you to create a number of real or shared copies of the selected events.
 - Select the events, hold down **Alt/Opt**, click the handle in the lower right corner of the last selected event, and drag to the right to create a real copy.

- Move the mouse pointer over the middle of the right event border so that it becomes a pointing hand symbol. Click and drag to the right to create a real copy.
- Select the events, hold down **Alt/Opt - Shift**, and drag to the right to create a shared copy.

NOTE

This applies to MIDI events only.

- Move the mouse pointer over the middle of the right event border so that it becomes a pointing hand symbol, hold down **Shift**, click and drag to the right to create a shared copy.

NOTE

Repeating by dragging only works if the track has a height of at least 2 rows.

RELATED LINKS

[Shared Copies](#) on page 172

[Repeat Events Dialog](#) on page 172

[Setting the Track Height](#) on page 142

Repeat Events Dialog

The **Repeat Events** dialog allows you to create a number of real or shared copies of the selected events.

- To open the **Repeat Events** dialog, select **Edit > Functions > Repeat**.

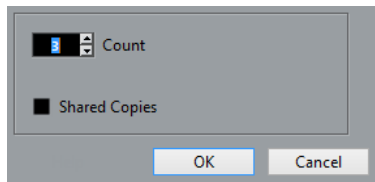

Count

Allows you to specify how many times you want the event to be repeated.

Shared Copies

Activate to create a shared copy.

RELATED LINKS

[Shared Copies](#) on page 172

Shared Copies

Shared copies are useful if you want to create copies that are automatically edited in the same way as the original event.

You can create shared copies by using the **Repeat Events** dialog.

You can convert a shared copy to a real copy by selecting **Edit > Functions > Convert to Real Copy**. This creates a new version of the clip that you can edit independently. The new clip is automatically added to the **Pool**.

RELATED LINKS

- [Repeating Events](#) on page 171
- [Repeat Events Dialog](#) on page 172

Fill Loop

You can create a number of copies between the right and left locators.

- Select **Edit > Functions > Fill Loop** to create a number of copies, starting at the left locator and ending at the right locator.
The last copy is automatically shortened to end at the right locator position.

Moving the Contents of Events

You can move the content of an event without changing its position in the **Project** window.

PROCEDURE

- Hold down **Ctrl/Cmd - Alt/Opt**, click the event, and drag to the left or right.

NOTE

You can change the default modifier key for **Slip Event Content** in the **Select Tool** category of the **Preferences** dialog (**Editing-Tool Modifiers** page).

RESULT

The content of the event is moved.

NOTE

- You cannot move the content of an audio event past the start or the end of the actual audio clip. If the event plays the whole clip, you cannot move the content at all.
 - You can set up key commands for **Slip Event Content Left** and **Slip Event Content Right** in the **Edit** category of the **Key Commands** dialog to move the content of events to the left or to the right.
-

RELATED LINKS

- [Setting up Tool Modifier Keys](#) on page 816

Inverting the Phase of Audio Events

You can invert the phase of audio events in the **Project** window.

PROCEDURE

1. In the **Project** window, select one or multiple audio events.
 2. On the info line, click the **Invert Phase** field.
-

RESULT

The phase of the events is inverted. This is reflected on the info line.

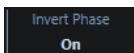

RELATED LINKS

[Info Line](#) on page 46

Muting Events

You can mute events in the **Project** window. Muted events can be edited as usual, with the exception of adjusting fades, but they cannot be played back.

PROCEDURE

- Do one of the following:
 - Select the **Mute** tool, and click the events or drag a selection rectangle around them.
 - Select the events, and select **Edit > Mute**.

RESULT

The events are muted and grayed out.



You can unmute events by selecting them and selecting **Edit > Unmute**.

RELATED LINKS

[Project Window Toolbar](#) on page 36

Exporting MIDI Parts as MIDI Files

You can export MIDI parts as MIDI files.

PROCEDURE

1. In the **Project** window, select the MIDI part that you want to export.
2. Drag the MIDI part to the File Explorer/macOS Finder.

RESULT

A corresponding MIDI file is exported. The **Export Options** for MIDI files are taken into account.

RELATED LINKS

[Export Options Dialog for MIDI Files](#) on page 138

Range Editing

Editing in the **Project** window is not restricted to handling whole events and parts. You can also work with selection ranges, which are independent from the event/part and track boundaries.

Creating a Selection Range

PROCEDURE

1. On the **Project** window toolbar, select **Range Selection**.
2. Do one of the following:
 - Draw a selection rectangle around the range that you want to select.
 - Select **Edit > Select**, and select one of the menu functions.
 - Double-click an event to create a selection range that encompasses it.

NOTE

If you hold down **Shift** and double-click several events in a row, you can create a selection range that encompasses several events.

RELATED LINKS

[Select Menu for Selection Ranges](#) on page 175

Select Menu for Selection Ranges

If the **Range Selection** tool is selected, the **Select** submenu features specific options for selecting ranges in the **Project** window.

- To open the range selection options menu, select the **Range Selection** tool and select **Edit > Select**.

All

Makes a selection that covers all tracks, from the start of the project to the end. You can define the track length with the **Project Duration** setting in the **Project Setup** dialog.

None

Removes the current selection range.

Invert

Inverts the selection. All selected events are deselected, and all events that were not selected are selected. Only used for event selection.

In Loop

Makes a selection between the left and right locator on all tracks.

From Start to Cursor

Makes a selection on all tracks, from the start of the project to the project cursor.

From Cursor to End

Makes a selection on all tracks, from the project cursor to the end of the project.

Equal Pitch - all Octaves

This function requires that you select a single note. It selects all notes of this part that have the same pitch in any octave as the selected note.

Equal Pitch - same Octave

This function requires that you select a single note. It selects all notes of this part that have the same pitch and the same octave as the selected note.

Select Controllers in Note Range

Selects the controllers within the note range.

All on Selected Tracks

Selects all events on the selected track. Only used for event selection.

Events under Cursor

Selects all events on the selected tracks that are touched by the project cursor.

Select Event

This is available in the **Sample Editor**.

Left Selection Side to Cursor

Moves the left side of the current selection range to the project cursor position.

Right Selection Side to Cursor

Moves the right side of the current selection range to the project cursor position.

RELATED LINKS

[Project Setup Dialog](#) on page 88

[Selecting with the Object Selection Tool](#) on page 159

[Select Submenu](#) on page 160

Selecting Ranges for Several Tracks

You can create selection ranges that cover several tracks. It is also possible to exclude tracks from a selection range.

PROCEDURE

1. Create a selection range from the first to the last track.
 2. Press **Ctrl/Cmd Alt/Opt**.
 3. In the selection range, click on the tracks that you want to exclude from the selection.
-

Editing Selection Ranges

You can edit selection ranges, that is, adjust their size, move or duplicate them, split them, etc.

Adjusting the Size of Selection Ranges

You can adjust the size of a selection range.

PREREQUISITE

You have created a selection range.

CHOICES

- Drag the edges of the selection range vertically or horizontally.
 - Hold down **Shift**, and click where you want to extend/reduce the size of the selection range. The closest selection range edge is moved to the position at which you clicked.
 - On the info line, adjust the values for **Range Start**, **Range End**, **Range Length**, **Top Track** or **Bottom Track**.
 - Use the buttons **Nudge Start Left**, **Nudge Start Right**, **Nudge End Left** or **Nudge End Right** in the **Nudge** section of the **Project** window toolbar.
The edges are moved by the amount specified on the **Grid** pop-up menu or by the amount set on the **Nudge Settings** pop-up menu.
 - Use the key commands in the **Nudge** category of the **Key Commands** dialog:
 - Use **Alt/Opt - Left Arrow**, the default key command for **Nudge Start Left**.
 - Use **Alt/Opt - Right Arrow**, the default key command for **Nudge Start Right**.
 - Use **Alt/Opt - Shift - Left Arrow**, the default key command for **Nudge End Left**.
 - Use **Alt/Opt - Shift - Right Arrow**, the default key command for **Nudge End Right**.
 - Use **Alt/Opt - Down Arrow**, the default key command for **Nudge Bottom Down**.
 - Use **Alt/Opt - Shift - Up Arrow**, the default key command for **Nudge Bottom Up**.
 - Use **Alt/Opt - Shift - Down Arrow**, the default key command for **Nudge Top Down**.
 - Use **Alt/Opt - Up Arrow**, the default key command for **Nudge Top Up**.
-

RELATED LINKS

- [Nudge Category](#) on page 810
- [Setup Context Menus](#) on page 817
- [Moving Events with the Nudge Buttons](#) on page 162
- [Resizing Events with the Nudge Buttons](#) on page 167
- [Nudge](#) on page 39

Moving Selection Ranges

You can move selection ranges and their contents to a new position.

PREREQUISITE

You have created a selection range.

PROCEDURE

- Click the selection range, and drag it to a new position.
-

RESULT

The contents of the selection range are moved to the new position. If the range intersected events or parts, these are split before moving, so that only the sections within the selection range are affected.

RELATED LINKS

- [Nudging Selection Ranges](#) on page 178
- [Creating a Selection Range](#) on page 175
- [Duplicating Events](#) on page 171

Nudging Selection Ranges

You can nudge selection ranges to a new position without moving their contents.

PREREQUISITE

- You have created a selection range.
- You have activated the **Nudge** section by right-clicking the **Project** window toolbar and activating **Nudge**.

PROCEDURE

1. Open the **Grid Type** pop-up menu and select a value to set the nudge amount.
2. Do one of the following:
 - In the **Nudge** section of the toolbar, click **Move Left** or use the corresponding key command **Ctrl/Cmd - Left Arrow**.
 - In the **Nudge** section of the toolbar, click **Move Right** or use the corresponding key command **Ctrl/Cmd - Right Arrow**.

RESULT

The selection range is nudged according to your settings, but the contents of the selection are not moved.

RELATED LINKS

- [Moving Selection Ranges](#) on page 177
- [Creating a Selection Range](#) on page 175
- [Duplicating Events](#) on page 171

Duplicating Selection Ranges

PREREQUISITE

You have created a selection range.

PROCEDURE

- Click the selection range, hold down **Alt/Opt**, and drag.

RELATED LINKS

- [Creating a Selection Range](#) on page 175

Cut, Copy, and Paste of Selection Ranges

You can cut or copy and paste selection ranges, using the functions on the **Edit** menu. You can also use the **Cut Time** and **Paste Time** options.

Cut

Cuts the data in the selection range and moves it to the clipboard. The selection range is replaced by empty track space in the **Project** window, meaning that events to the right of the range keep their positions.

Copy

Copies the data in the selection range to the clipboard.

Paste

Pastes the clipboard data to the start position and track of the current selection. Existing events on the tracks remain at their original position.

Paste at Origin

Pastes the clipboard data back at its original position. Existing events on the tracks remain at their original position.

This option is available in **Edit > Functions**.

Cut Time

Cuts the selection range and moves it to the clipboard. Events to the right of the removed range are moved to the left to fill the gap.

This option is available in **Edit > Range**.

Paste Time

Pastes the selection range from the clipboard to the start position and track of the current selection. Existing events are moved to make room for the pasted data.

This option is available in **Edit > Range**.

Paste Time at Origin

Pastes the selection range from the clipboard to its original position. Existing events are moved to make room for the pasted data.

This option is available in **Edit > Range**.

Global Copy

Copies everything between the left and right locator.

This option is available in **Edit > Range**.

Deleting Data in Selection Ranges

- To replace data within the deleted selection range with empty track space, select **Edit > Delete** or press **Backspace**.
Events to the right of the range keep their position.
- To remove the selection range and make the events to the right move to the left to fill the gap, select **Edit > Range > Delete Time**.

Splitting Selection Ranges

You can split events or parts at the selection range edges, that is, at the start and at the end of a selection range.

PROCEDURE

1. On the **Project** window toolbar, activate the **Range Selection** tool.
2. Do one of the following:
 - Select **Edit > Range > Split**.
 - Press **Shift-X**.

RESULT

The events or parts are split at the edges of the selection range.

Cropping Selection Ranges

You can crop events or parts that are partially within the selection range.

PREREQUISITE

You have created a selection range.

PROCEDURE

- Select **Edit > Range > Crop**.

RESULT

Events that are entirely inside or outside the selection range are not affected.

Inserting Silence

You can insert empty track space from the start of the selection range. The length of the silence equals the length of the selection range.

- To insert silence, select **Edit > Range > Insert Silence**.
Events to the right of the selection range start are moved to the right to make room. Events that are intersected by the selection range start are split, and the right section is moved to the right.

Playback and Transport

Cubase offers multiple methods and functions to control playback and transport.

Transport Panel

The **Transport** panel contains the main transport functions as well as many other options related to playback and recording.

- To show the **Transport** panel, select **Transport > Transport Panel** or press **F2**.

Transport Panel Sections

The **Transport** panel has different sections that you can show or hide by activating the corresponding options on the **Transport** panel context menu.

- To show all **Transport** panel sections, right-click anywhere on the **Transport** panel and select **Show All**.

The following sections are available:

Audio Performance Meter

Audio Performance Meter



The upper bar displays either the current realtime peak or the ASIO-Guard load, depending on which of the two has the higher value. The lower bar shows the hard disk transfer load of the disk engine.

For a more detailed display of realtime peak and ASIO-Guard load, click to open the **Audio Performance** window.

Common Record Modes

Common Record Modes



Allow you to determine what happens if you click **Record** during an audio or MIDI recording, and where to start the recording.

Audio Record Modes

Audio Record Modes

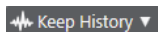

Allow you to select what happens when you record over existing audio events.

MIDI Record Modes

MIDI Record Modes

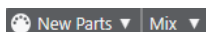

Allow you to select what happens when you record over existing MIDI parts.

MIDI Auto Quantize

Automatic MIDI Record Quantize



Activates automatic quantizing during a MIDI recording.

Locators

Go to Left Locator Position



Allows you to go to the left locator position.

Left Locator Position

1. 5. 1. 0

Shows the left locator position.

Go to Right Locator Position



Allows you to go to the right locator position.

Right Locator Position

4. 8. 1. 0

Shows the right locator position.

Locator Range Duration

Locators to Selection



Allows you to set the locators to the selection.

Locator Range Duration

4. 8. 1. 0

Shows the duration of the locator range.

Punch Points

Punch In



Activates **Punch In**.

Punch Out



Activates **Punch Out**.

Transport Controls

Go to Previous Marker/Zero



Moves the project cursor to the previous marker/zero position on the timeline.

Go to Next Marker/Project End



Moves the project cursor to the next marker/project end.

Rewind



Moves backward.

Forward



Moves forward.

Cycle



Activates/Deactivates cycle mode.

Stop



Stops playback.

Start



Starts playback.

Transport Record



Activates/Deactivates record mode.

Time Display

Select Primary Time Format



Allows you to select a time format for the primary time display.

Primary Time Display

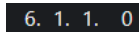

Shows the position of the project cursor in the selected time format.

Markers

Jump to Marker



Allows you to set and locate marker positions.

Open Markers Window



Opens the **Markers** window.

Pre-roll & Post-roll

Activate Pre-roll



Activates pre-roll.

Pre-roll Amount

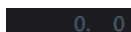

Allows you to set the pre-roll position. To show/hide this, click the points on the divider.

Activate Post-roll



Activates post-roll.

Post-roll Amount



Allows you to set the post-roll position. To show/hide this, click the points on the divider.

Tempo & Time Signature

Activate Tempo Track

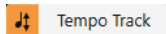

Allows you to activate/deactivate the tempo track.

Tempo



Allows you to set the tempo value.

Time Signature



Allows you to set the first time signature value. To show/hide this, click the points on the divider.

Activate External Sync

Activate External Sync



Activates external synchronization.

Open Synchronization Setup



Allows you to open the **Project Synchronization Setup** dialog.

Click & Count-In & Click Pattern

Activate Metronome Click



Activates the metronome click.

Activate Count-in



Activates the metronome click in count-in.

Open Metronome Setup



Opens the **Metronome Setup** dialog. To show/hide this, click the points on the divider.

Input/Output Activity

MIDI In Activity



Displays the MIDI input signals.

MIDI Out Activity



Displays the MIDI output signals.

Audio Activity



Displays the audio input/output signals.

Audio Clipping



Displays audio clipping.

Level Display



Displays the output level.

Level Control



Allows you to control the output level.

Set up Transport

Set up Transport



Opens a pop-up menu where you can set up which elements are visible.

RELATED LINKS

[Transport](#) on page 845

[Transport - Scrub](#) on page 846

Transport Menu

The **Transport** menu contains several transport functions as well as many other options related to playback and recording.

Transport Panel

Opens the **Transport** panel.

Transport Commands

Start

Starts playback.

Stop

Stops playback.

Start/Stop

Starts/Stops playback.

Cycle

Activates/Deactivates cycle mode.

Record

Activates/Deactivates record mode.

Rewind

Moves backward.

Forward

Moves forward.

Fast Rewind

Moves backward at a faster speed.

Fast Forward

Moves forward at a faster speed.

Nudge Cursor Left

Moves the project cursor position to the left.

Nudge Cursor Right

Moves the project cursor position to the right.

Enter Project Cursor Position

Allows you to enter the project cursor position manually.

Enter Tempo

Allows you to enter the tempo manually.

Enter Time Signature

Allows you to enter the time signature manually.

Go to Project Start

Moves the project cursor position to the start of the project.

Go to Project End

Moves the project cursor position to the end of the project.

Exchange Time Formats

Switches the primary and the secondary time display.

Locators

Go to Left Locator Position

Moves the project cursor position to the left locator.

Go to Right Locator Position

Moves the project cursor position to the right locator.

Set Left Locator to Project Cursor Position

Sets the left locator to the project cursor position.

Set Right Locator to Project Cursor Position

Sets the right locator to the project cursor position.

Enter Left Locator Position

Allows you to enter the position of the left locator manually.

Enter Right Locator Position

Allows you to enter the position of the right locator manually.

Enter Locator Range Duration

Allows you to enter the duration of the locator range manually.

Set Locators to Selection Range

Sets the locators to encompass the selection.

Exchange Left & Right Locator Positions

Switches the positions of the left and right locator.

Loop Selection Range

Activates playback from the start of the current selection and keeps starting over again when reaching the selection end.

Punch Points

Activate Punch In

Activates/Deactivates punch in.

Activate Punch Out

Activates/Deactivates punch out.

Go to Punch In Position (Left Locator)

Moves the project cursor position to the punch in position.

Go to Punch Out Position (Right Locator)

Moves the project cursor position to the punch out position.

Set Project Cursor Position

Locate Selection Start

Moves the project cursor to the beginning of the selection.

Locate Selection End

Moves the project cursor to the end of the selection.

Locate Next Marker

Moves the project cursor to the next marker.

Locate Previous Marker

Moves the project cursor to the previous marker.

Locate Next Hitpoint

Moves the project cursor to the next hitpoint on the selected track.

Locate Previous Hitpoint

Moves the project cursor to the previous hitpoint on the selected track.

Locate Next Event

Moves the project cursor to the next event on the selected track.

Locate Previous Event

Moves the project cursor to the previous event on the selected track.

Play Project Range

Play from Selection Start

Activates playback from the start of the current selection.

Play from Selection End

Activates playback from the end of the current selection.

Play until Selection Start

Activates playback two seconds before the start of the current selection and stops at the selection start.

Play until Selection End

Activates playback two seconds before the end of the current selection and stops at the selection end.

Play until Next Marker

Activates playback from the project cursor and stops at the next marker.

Play Selection Range

Activates playback from the start of the current selection and stops at the selection end.

Pre-roll & Post-roll

Use Pre-roll

Activates/Deactivates the pre-roll.

Use Post-roll

Activates/Deactivates the post-roll.

Post-roll from Selection Start

Starts playback from the beginning of the selected range and stops after the time set in the post-roll field on the **Transport** panel.

Post-roll from Selection End

Starts playback from the end of the selected range and stops after the time set in the post-roll field on the **Transport** panel.

Pre-roll to Selection Start

Stops playback at the selection start. The playback start position is set in the pre-roll field on the **Transport** panel.

Pre-roll to Selection End

Stops playback at the selection end. The playback start position is set in the pre-roll field on the **Transport** panel.

Use Tempo Track

Activates/Deactivates the tempo track.

Common Record Modes

Punch In/Out

Activates/Deactivates punch in/out.

Re-Record

Activates/Deactivates the re-record mode.

Start Recording at Project Cursor Position

Activates/Deactivates the start of the recording at the project cursor position.

Start Recording at Left Locator/Punch In Position

Activates/Deactivates the start of the recording at the left locator.

Audio Record Mode

These options allow you to select what happens when you record over existing events.

Keep History

Keeps existing events or portions of events.

Cycle History + Replace

Replaces existing events or portions of events with the new recording. In cycle mode, all takes from the current cycle recording are kept.

Replace

Replaces existing events or portions of events with the last take.

MIDI Record Mode

These options allow you to select what happens when you record over existing parts.

New Parts

Keeps existing parts and saves the new recording as a new part.

Merge

Keeps existing events in parts and adds the newly recorded events.

Replace

Replaces existing events in parts with the new recording.

Auto Quantize in Record

Activates automatic quantizing during recording.

MIDI Cycle Record Mode

Mix

Adds everything you record to what was previously recorded.

Overwrite

Overwrites all MIDI that you have recorded on previous laps as soon as you play a MIDI note or send any MIDI message.

Keep Last

Replaces previously recorded laps only if the new lap is completed.

Auto Quantize in Record

Activates automatic quantizing during recording.

MIDI Retrospective Recording

Allows you to recover MIDI data that you play in **Stop** mode or during playback. The following options are available:

Insert from All MIDI Inputs

Inserts MIDI data that was sent to all track inputs as a linear MIDI part on the selected track.

Insert from Track Input as Linear Recording

Inserts MIDI data that was sent to the track input as a linear MIDI part on the selected track.

Insert from Track Input as Cycle Recording

Inserts MIDI data that was sent to the track input as stacked MIDI parts on the selected track.

Empty All Buffers

Empties the retrospective record buffer for the selected track.

Metronome Setup

Opens the **Metronome Setup** dialog.

Activate Metronome

Activates/Deactivates the metronome click.

Project Synchronization Setup

Opens the **Project Synchronization Setup** dialog.

Activate External Sync

Sets Cubase to be synchronized externally.

RELATED LINKS

[Left and Right Locators](#) on page 197

[Punch In and Punch Out](#) on page 203

[Pre-Roll and Post-Roll](#) on page 202

[Common Record Modes Menu](#) on page 214

[Audio Record Modes](#) on page 219

[MIDI Record Modes](#) on page 226

[Recovery of MIDI Recordings](#) on page 227

[Metronome Click](#) on page 203

Transport Bar

The **Transport Bar** contains all transport functions in an integrated and fixed zone of the **Project** window.

- To activate the **Transport Bar**, click **Set up Window Layout** on the **Project** window toolbar and activate **Transport Bar**.
- To display all transport elements, right-click in an empty area of the **Transport Bar** and select **Show All**.
- To show all controls of a section, click the points to the right of the section, and drag all the way to the right. To hide the controls again, drag to the left.



RELATED LINKS

[Transport Bar](#) on page 47

[Project Window Toolbar](#) on page 36

Transport Bar Sections

The **Transport Bar** has different sections that you can show or hide by activating the corresponding options on the context menu.

- To activate the **Transport Bar**, click **Set up Window Layout** on the **Project** window toolbar and activate **Transport Bar**.
- To show/hide tools, open the **Transport Bar** context menu by right-clicking in an empty area of the **Transport Bar**, and activate the tools that you want to display. To show all tools, select **Show All**.

Constrain Delay Compensation

Constrain Delay Compensation



Minimizes the latency effects of the delay compensation.

Common Record Modes

Common Record Modes



Allow you to determine what happens if you click **Record** during an audio or MIDI recording, and where to start the recording.

Audio Record Modes

Audio Record Modes

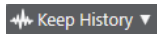

Allow you to select what happens when you record over existing audio events.

MIDI Record Modes

MIDI Record Modes

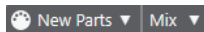

Allow you to select what happens when you record over existing MIDI parts.

MIDI Auto Quantize

Automatic MIDI Record Quantize



Activates automatic quantizing during a MIDI recording.

Left Divider

Left Divider

Tools that are placed to the left of the divider are always shown.

Audio Performance Meter

Audio Performance Meter

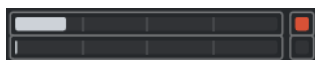

The upper bar displays either the current realtime peak or the ASIO-Guard load, depending on which of the two has the higher value. The lower bar shows the hard disk transfer load of the disk engine.

For a more detailed display of realtime peak and ASIO-Guard load, click to open the **Audio Performance** window.

Locators

Go to Left Locator Position



Allows you to go to the left locator position.

Left Locator Position

1. 5. 1. 0

Shows the left locator position.

Go to Right Locator Position



Allows you to go to the right locator position.

Right Locator Position

4. 8. 1. 0

Shows the right locator position.

Locator Range Duration

Locators to Selection



Allows you to set the locators to the selection.

Locator Range Duration

4. 8. 1. 0

Shows the duration of the locator range.

Punch Points

Punch In



Activates **Punch In**.

Punch Out



Activates **Punch Out**.

Transport Controls

Go to Previous Marker/Zero



Moves the project cursor to the previous marker/zero position on the timeline.

Go to Next Marker/Project End



Moves the project cursor to the next marker/project end.

Rewind



Moves backward.

Forward



Moves forward.

Cycle



Activates/Deactivates cycle mode.

Stop



Stops playback.

Start



Starts playback.

Transport Record



Activates/Deactivates record mode.

Retrospective Record

Insert Retrospective Recording from All MIDI Inputs on Selected Track



Allows you to recover MIDI notes that you played in stop mode or during playback.

Time Displays

Select Primary Time Format



Allows you to select a time format for the primary time display.

Primary Time Display

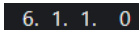

Shows the position of the project cursor in the selected time format.

Markers

Jump to Marker



Allows you to set and locate marker positions.

Open Markers Window



Opens the **Markers** window.

Pre-roll & Post-roll

Activate Pre-roll



Activates pre-roll.

Pre-roll Amount

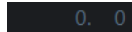

Allows you to set the pre-roll position. To show/hide this, click the points on the divider.

Activate Post-roll



Activates post-roll.

Post-roll Amount

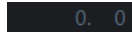

Allows you to set the post-roll position. To show/hide this, click the points on the divider.

Tempo & Time Signature

Activate Tempo Track

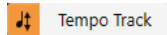

Allows you to activate/deactivate the tempo track.

Tempo



Allows you to set the tempo value.

Time Signature



Allows you to set the first time signature value. To show/hide this, click the points on the divider.

Right Divider

Right Divider

Tools that are placed to the right of the divider are always shown.

Activate External Sync

Activate External Sync



Activates external synchronization.

Open Synchronization Setup



Allows you to open the **Project Synchronization Setup** dialog.

Click & Count-in

Activate Metronome Click



Activates the metronome click.

Activate Count-in



Activates the metronome click in count-in.

Open Metronome Setup



Opens the **Metronome Setup** dialog. To show/hide this, click the points on the divider.

Input/Output Activity

MIDI In Activity



Displays the MIDI input signals.

MIDI Out Activity



Displays the MIDI output signals.

Audio Activity



Displays the audio input/output signals.

Audio Clipping



Displays audio clipping.

Level Display



Displays the output level.

Level Control



Allows you to control the output level.

Set up Transport Bar

Set up Transport



Opens a pop-up menu where you can set up which elements are visible.

Transport Pop-Up Window

The **Transport** pop-up window allows you to access specific transport commands if the **Transport** panel, the **Transport Bar**, and the **Transport Controls** in the **Project** window toolbar are closed or hidden.

The following default key commands open the **Transport Bar** pop-up window:

Enter Left Locator

Shift - L

Enter Right Locator

Shift - R

Enter Project Cursor Position

Shift - P

Enter Tempo

Shift - T

Enter Time Signature

Shift - C

Enter Punch In Position

Shift - I

Enter Punch Out Position

Shift - O

Go to Left Locator

Num 1

Go to Right Locator

Num 2

A specific key command opens the corresponding section of the **Transport** pop-up window:



Transport pop-up window for entering the left **Locator** position.

NOTE

To close the **Transport** pop-up window, press **Esc**.

Time Display Window

The **Time Display** window allows you to view the current time position in a separate window. You can adjust its size and specify the time format that you want to display.

- To open the **Time Display** window, select **Studio > More Options > Time Display**.

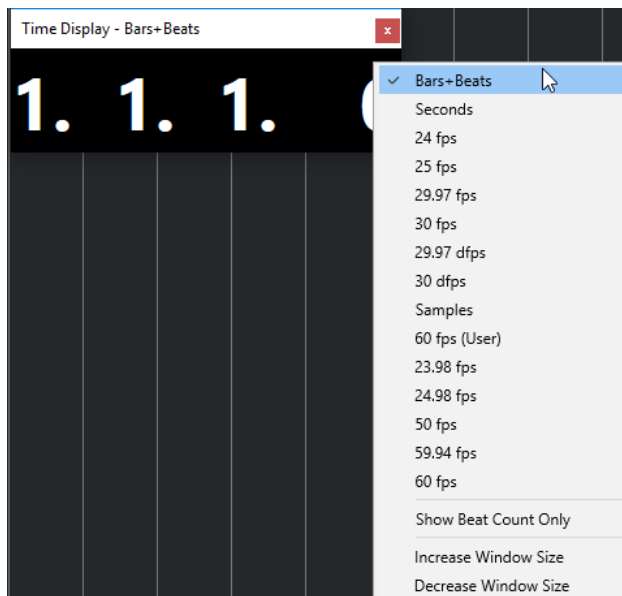

Right-click the window to access the following options:

Bars+Beats

Displays the time in bars and beats.

Seconds

Displays the time in seconds.

fps

Displays the time in frames per second.

Samples

Displays the time in samples.

Show Beat Count Only

Shows the beat counts only. This is useful if you want to use the **Time Display** window as a visual metronome.

Increase Window Size

Increases the size of the window and the displayed values.

Decrease Window Size

Decreases the size of the window and the displayed values.

NOTE

You can set up the **Window Transparency** in the **Studio Setup** dialog (**Time Display** page).

RELATED LINKS

[Time Signature Events](#) on page 756

Left and Right Locators

The left and right locators are a pair of markers that you can use as reference positions in the **Project** window and in the editors.

Locators help you, for example, to do the following:

- Positioning the project cursor.
- Defining start and stop positions for recording.
- Defining start positions for importing or exporting events.
- Setting up a cycle range.
- Selecting, copying, creating or splitting events.



Locators are indicated by the flags in the ruler.

The area between the left and the right locator is the locator range. The locator range is highlighted in the ruler and in the event display.

NOTE

In the event display of the MIDI editors, the locator range is only highlighted if **Show Part Borders** is deactivated.

- To activate/deactivate cycle mode, click the locator range in the upper part of the ruler or activate **Activate Cycle** in the transport controls.



- NOTE

If you activate cycle mode and the right locator is positioned before the left locator, the locator range is skipped during playback.



RELATED LINKS

- [Project Window Toolbar](#) on page 36
- [Setting the Project Cursor](#) on page 200
- [Activating Recording Manually](#) on page 212
- [Activating Recording Automatically](#) on page 212
- [Cycle Recording](#) on page 213
- [Punch In and Punch Out](#) on page 203
- [Common Record Modes Menu](#) on page 214
- [Import Options for MIDI Files](#) on page 238
- [Export Options Dialog for MIDI Files](#) on page 138
- [Export Audio Mixdown](#) on page 757
- [Setting the Locators Using Cycle Markers](#) on page 271
- [Select Submenu](#) on page 160
- [Select Menu for Selection Ranges](#) on page 175
- [Cut, Copy, and Paste of Selection Ranges](#) on page 178
- [Audio Parts](#) on page 157
- [MIDI Parts](#) on page 157
- [Fill Loop](#) on page 173
- [Splitting Events](#) on page 169
- [Transport](#) on page 845

Setting the Left Locator

Setting the left locator can be useful if you want to add a reference position in the **Project** window and in the editors.

PROCEDURE

- Do one of the following:
 - Press **Ctrl/Cmd**, and click in the upper part of the ruler to set the left locator to that position.
 - Adjust the **Left Locator Position** value.
This is available in the **Locators** section of the **Project** window toolbar, the editor toolbars, the **Transport** panel, and the **Transport Bar**.
 - Drag the left locator handle in the upper part of the ruler.
 - Press **Ctrl/Cmd**, and, on the numeric keypad, press **1** to set the left locator to the project cursor position.
 - Press **Alt/Opt**, and click **Go to Left Locator Position** on the **Transport** panel.
-

Setting the Right Locator

Setting the right locator can be useful if you want to add a reference position in the **Project** window and in the editors.

PROCEDURE

- Do one of the following:
 - Press **Alt/Opt**, and click in the upper part of the ruler to set the right locator to that position.
 - Adjust the **Right Locator Position** value.
This is available in the **Locators** section of the **Project** window toolbar, the editor toolbars, the **Transport** panel, and the **Transport Bar**.
 - Drag the right locator handle in the upper part of the ruler.
 - Press **Ctrl/Cmd**, and, on the numeric keypad, press **2** to set the right locator to the project cursor position.
 - Press **Alt/Opt**, and click **Go to Right Locator Position** on the **Transport** panel.
-

Setting up Locator Ranges

You can set up the locator range, that is, the area between the left and the right locator.

PROCEDURE

- Do one of the following:
 - Click and drag in the upper part of the ruler.
 - Select a range or an event, and press **P** to set the locators to the selection.
 - Double-click a cycle marker.
 - Press **Ctrl/Cmd - Alt/Opt**, and click at a position in the upper part of the ruler to set both locators to the nearest snap position.
-

RESULT

The locator range is set up and highlighted in the ruler and in the event display. **Snap** is taken into account.

Moving Locator Ranges

In the ruler, you can move the locator range.

PREREQUISITE

You have set up a locator range.

PROCEDURE

1. Move the mouse pointer to the upper part of the ruler inside a locator range.
A hand symbol is shown.
 2. Click and drag to the left or to the right to move the locator range.
-

Setting the Project Cursor

You can set the project cursor to the position where you click, or to markers or other predefined positions.

PROCEDURE

- Do one of the following:
 - Hold down **Shift - Alt/Opt**, and click in the **Project** window event display.
 - Click **Go to Previous Marker/Zero** or **Go to Next Marker/Project End**.
These are available in the **Transport Controls** section of the **Project** window toolbar, the editor toolbars, the **Transport** panel, and the **Transport Bar**.
 - Click in the lower part of the ruler.
 - Select **Transport > Set Project Cursor Position**, and select an entry in the submenu.
 - Use a key command.

NOTE

You can assign key commands for setting the project cursor location in the **Transport** category of the **Key Commands** dialog. In addition to the default key commands, you can set up further commands, for example, for moving the project cursor forward or backward in fixed intervals.

RELATED LINKS

- [Transport Panel Sections](#) on page 181
- [Ruler](#) on page 44
- [Transport Menu](#) on page 185
- [Transport](#) on page 845
- [Transport Bar](#) on page 190
- [Left and Right Locators](#) on page 197
- [Key Commands](#) on page 801

Auto-Scroll Settings Menu

Auto-Scroll allows you to keep the project cursor visible in the window during playback.

If you activate **Auto-Scroll** on the toolbar of the **Project** window or in one of the editors, the following modes are available in the **Select Auto-Scroll Settings** pop-up menu:

Page Scroll

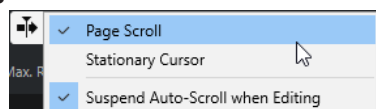

The project cursor moves from the left side to the right side of the window. When the project cursor reaches the right side of the window, the ruler and the project cursor jump to the left side of the window and start over again. This behavior can be compared to turning a page of a book.

Stationary Cursor

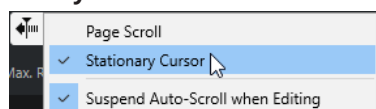

The project cursor is kept in the middle of the window, and the ruler scrolls continuously to the left.

RELATED LINKS

[Project Window Toolbar](#) on page 36

Suspend Auto-Scroll When Editing

If you do not want the **Project** window display to change when editing during playback, activate **Suspend Auto-Scroll when Editing**.

Suspend Auto-Scroll when Editing is available as an option in the **Select Auto-Scroll Settings** pop-up menu to the right of the **Auto-Scroll** button.

If this option is activated, auto-scrolling is suspended as soon as you click anywhere in the event display during playback until playback stops or until you click **Auto-Scroll** again.

As a visual feedback, the **Auto-Scroll** button changes its color.

Time Formats

You can set up different time formats.

Selecting the Primary Time Format

On the **Transport** panel, you can select the primary time format. This is the global display format that is used for all rulers and position displays in the program, except for the ruler tracks.

PROCEDURE

1. In the main transport section on the **Transport** panel, click **Select Primary Time Format**.
2. Select a time format from the pop-up menu.

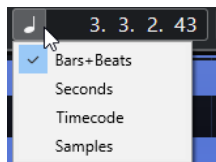

RESULT

The time format on the **Transport** panel and all rulers and position displays are updated.

NOTE

You can also select **Project > Project Setup**. In the **Project Time Displays** section, open the **Display Format** pop-up menu to select the primary time format.

RELATED LINKS

[Project Setup Dialog](#) on page 88

Independent Time Displays

You can show time displays that are independent from the global display format.

To select an independent time display, do one of the following:

- In the ruler of the **Project** window or any editor, click the arrow button to the right of the ruler.
- Select **Project > Add Track > Ruler** to add a ruler track, and right-click the ruler.
- In the **Main Transport** section of the **Transport** panel, click **Select Secondary Time Format**.

RELATED LINKS

[Ruler](#) on page 44

[Ruler Track](#) on page 124

Pre-Roll and Post-Roll

You can activate pre-roll and post-roll with the corresponding buttons in the **Pre-roll & Post-roll** section on the **Transport** panel or by selecting **Transport > Pre-roll & Post-roll > Use Pre-roll/Use Post-roll**.

NOTE

To show the **Pre-roll & Post-roll** section, right-click anywhere in the **Transport** panel or in the **Transport Bar** and activate **Pre-roll & Post-roll**.

- By setting a pre-roll value, you instruct Cubase to roll back a short section whenever playback is activated.

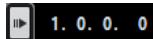

- By setting a post-roll value, you instruct Cubase to play back a short section after automatic punch out before stopping.

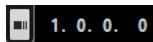

NOTE



This only works if **Punch Out** is activated on the **Transport** panel, and if **Stop after Automatic Punch Out** is activated in the **Preferences** dialog (**Record** page).

Using Pre-Roll and Post-Roll

You can set up a pre-roll and a post-roll value for recording.

PREREQUISITE

PROCEDURE

1. Set the locators to where you want to start and end recording.
 2. On the **Transport** panel or in the **Transport Bar**, activate **Punch In** and **Punch Out**.
 3. In the **Preferences** dialog, select **Record**.
 4. Activate **Stop after Automatic Punch Out**.
 5. Right-click anywhere on the **Transport** panel or in the **Transport Bar** and activate **Pre-roll & Post-roll**.
 6. In the **Pre-roll & Post-roll** section, activate **Pre-roll**  and **Post-roll** .
 7. In the **Pre-roll Amount** and **Post-roll Amount** fields, enter the pre-roll and post-roll values.
 8. Activate **Record**.
-

RESULT

The project cursor rolls back by the specified pre-roll value, and playback starts. When the cursor reaches the left locator, recording is automatically activated. When the cursor reaches the right locator, recording is deactivated, but playback continues for the specified post-roll value before stopping.

Punch In and Punch Out

The punch in and the punch out points are a pair of markers that you can use for punch in and punch out of recordings. The punch in position determines the record start position and the punch out position determines the record stop position.

You can activate punch in and punch out by activating the corresponding buttons on the **Transport** panel.

The punch in position is locked to the left locator position and the punch out position to the right locator position.

RELATED LINKS

[Activating Recording Automatically](#) on page 212

[Stopping Recording Automatically with Punch Out](#) on page 213

Metronome Click

You can use the metronome click as a timing reference for playing along and recording. The two parameters that govern the timing of the metronome are project tempo and the time signature.

- To activate the metronome click, activate **Activate Metronome Click** on the **Transport** panel.
You can also select **Transport > Activate Metronome** or use the corresponding key command.
- To define if the metronome click is played during playback, recording or count-in, select **Transport > Metronome Setup**, and make your changes on the **General** tab.
- To set up the sounds for the metronome click, select **Transport > Metronome Setup**, and make your changes on the **Click Sounds** tab.

RELATED LINKS

[Transport Panel Sections](#) on page 181

[Project Tempo Modes](#) on page 748

Metronome Setup Dialog

The **Metronome Setup** dialog allows you to make settings for the metronome.

To open the **Metronome Setup** dialog, do one of the following:

- Select **Transport > Metronome Setup**.
- In the **Transport Bar**, open the **Click & Count-In** section, and click **Open Metronome Setup**.

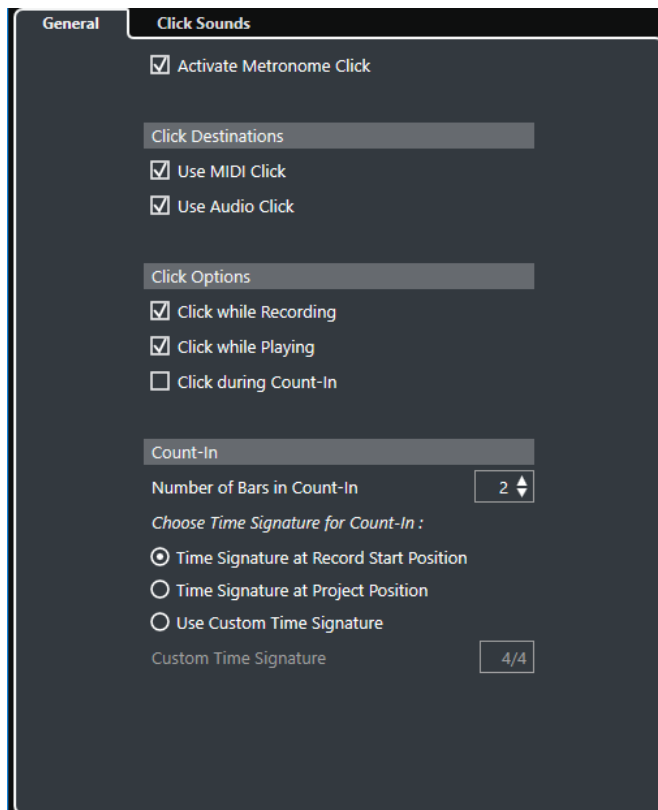

RELATED LINKS

[General Tab](#) on page 205

[Click Sounds Tab](#) on page 206

[Transport Bar Sections](#) on page 191

General Tab

The **General** tab allows you to make basic metronome settings.

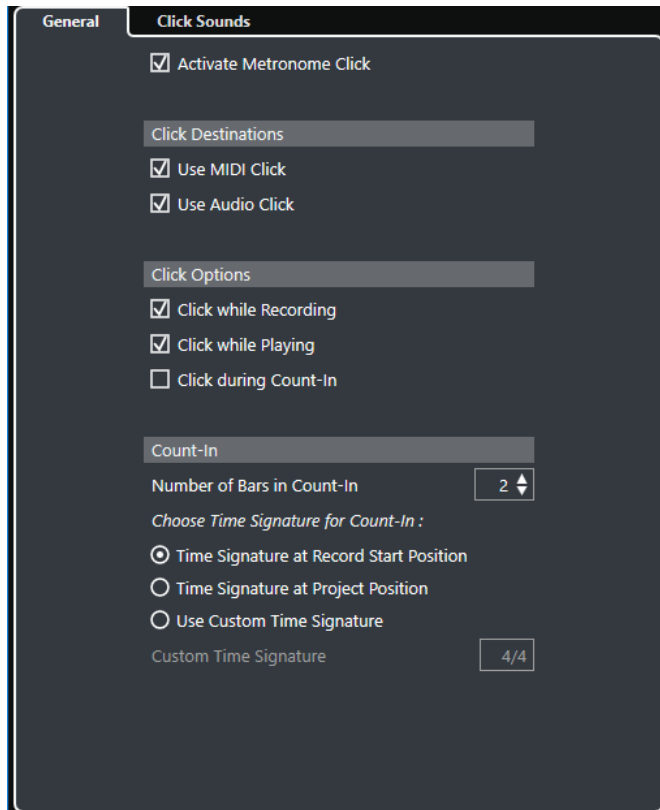

In the topmost section, the following options are available:

Activate Metronome Click

Activates/Deactivates the metronome click.

In the **Click Destinations** section, the following options are available:

Use MIDI Click

Activates a MIDI click for the metronome.

Use Audio Click

Activates an audio click for the metronome that is output via the audio hardware.

In the **Click Options** section, the following options are available:

Click while Recording

Activates the metronome click during recording.

Click while Playing

Activates the metronome click during playback.

Click during Count-In

Activates a musical count-in that is played when you start recording from stop mode.

In the **Count-In** section, the following options are available:

- **Number of Bars in Count-In**

Allows you to set the number of bars that the metronome counts in before recording starts.

- **Time Signature at Record Start Position**
Activate this to let the count-in automatically use the time signature and tempo set at the position where recording starts.
- **Time Signature at Project Position**
Activate this to let the count-in use the time signature at the project position.
- **Use Custom Time Signature**
Allows you to set a time signature for the count-in. In this mode, signature changes in the project do not affect the count-in.

Click Sounds Tab

The **Click Sounds** tab allows you to set up and audition the MIDI click and the audio click. You can use the default audio or MIDI click, choose from a list of factory preset sounds, or assign your own custom sounds.

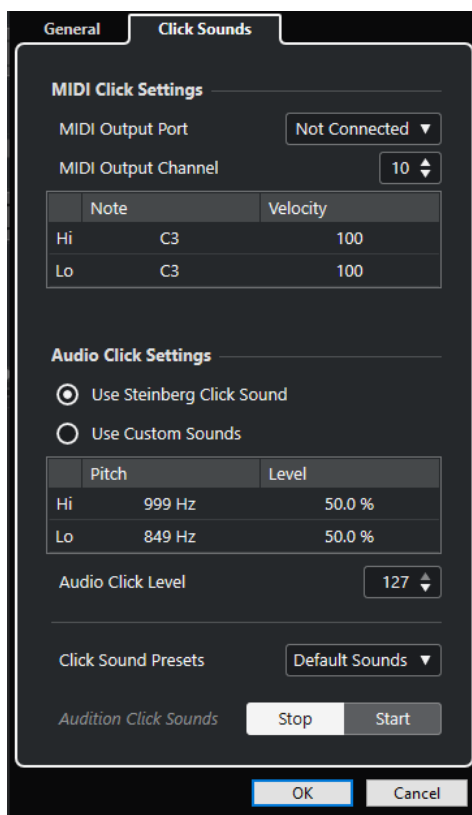

The **MIDI Click Settings** section allows you to set up the MIDI click that sounds if you activate **Use MIDI Click** in the **Click Destinations** section on the **General** tab.

MIDI Output Port

Allows you to select a MIDI output port for the MIDI click. You can also select a VST instrument previously set up in the **VST Instruments** window.

MIDI Output Channel

Allows you to select a MIDI output channel for the MIDI click.

Note

Allows you to set the MIDI note number, that is, the pitch from C-2 to G8. Set the note number for the first beat in a bar in the top row, and the note numbers for the other beats in the rows below.

Velocity

Allows you to set the velocity of the MIDI click sound. Set the velocity for the first beat in a bar in the top row and the velocities for the other beats in the rows below.

The **Audio Click Settings** section allows you to set up the audio click that sounds if you activate **Use Audio Click** in the **Click Destinations** section on the **General** tab.

Use Steinberg Click Sound

Activates the default sounds for the metronome click.

Pitch

Allows you to set the pitch for the default sounds. Set the pitch for the first beat in a bar in the top row and the pitches for the other beats in the rows below.

Level

Allows you to set the level for the default sounds. Set the level for the first beat in a bar in the top row and the levels for the other beats in the rows below.

Use Custom Sounds

Activates custom sounds for the metronome click. For this to work, you must select an audio file for the custom sounds by clicking in the **Sound** column.

Sound

Allows you to select an audio file for the custom sounds. Select an audio file for the first beat in a bar in the top row and the audio files for the other beats in the rows below.

Level

Allows you to set the level for the custom sounds. Set the level for the first beat in a bar in the top row and the levels for the other beats in the rows below.

Audio Click Level

Allows you to adjust the level of the audio click.

Click Sound Presets

Allows you to load one of the click sound presets that supports up to 4 accents. Amongst other click sounds that are suited for a broad range of applications, you can also select **Steinberg Click Sound**, the default click sound of Cubase.

You can also create your own presets and save them.

Audition Click Sounds

Click **Start** to audition the activated click sounds.

Setting up a Custom Audio Click Sound

If you do not want to use the default click sound, you can set up your own custom sound.

PREREQUISITE

In the **Metronome Setup** dialog on the **General** tab, **Activate Metronome Click** is activated. In the **Click Destinations** section, **Use Audio Click** is activated.

PROCEDURE

1. Open the **Click Sounds** tab, and in the **Audio Click Settings** section, activate **Use Custom Sounds**.
2. In the **Sound** column, click the top row.
3. In the file dialog, navigate to the audio file that you want to use as a custom sound for the first beat and select it.

4. Click **Open**.
 5. Click the other rows to select audio files for the other beats.
 6. Set the level of the sounds by clicking the respective rows in the **Level** column and adjusting the value.
 7. Optional: Click **Start** to audition the custom sounds.
-

RESULT

The metronome uses the defined custom sounds for the audio click.

AFTER COMPLETING THIS TASK

Open the **Click Sound Presets** pop-up menu, and save your custom sounds as a preset.

Chase

Chase is a function that makes sure your MIDI instruments sound as they should when you locate to a new position and start playback. This is accomplished by the program transmitting a number of MIDI messages to your instruments each time that you move to a new position in the project, making sure all MIDI devices are set up correctly with regard to program change, controller messages (such as MIDI volume), etc.

EXAMPLE

You have a MIDI track with a program change event inserted at the beginning. This event makes a synth switch to a piano sound.

At the beginning of the first chorus, you have another program change event, which makes the same synth switch to a string sound.

You now play back the song. It begins with the piano sound and then switches to the string sound. In the middle of the chorus, you stop and rewind to some point between the beginning and the second program change. The synth now still plays the string sound, although, in this section, it should really be a piano.

The **Chase** function takes care of that. If program change events are set to be chased, Cubase tracks the music back to the beginning, finds the first program change, and transmits it to your synth, setting it to the correct sound.

The same can apply to other event types as well. In the **Preferences** dialog (**MIDI** page), the **Chase Events** settings determine which event types are chased when you locate to a new position and start playback.

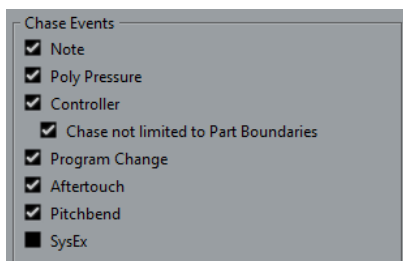

RELATED LINKS

[Chase Events](#) on page 839

On-Screen Keyboard

The **On-Screen Keyboard** allows you to play and record MIDI notes by using your computer keyboard or mouse. This is useful if you have no external MIDI instrument at hand and you do not want to draw in notes with the **Draw** tool.

When the **On-Screen Keyboard** is displayed, the usual key commands are blocked because they are reserved for the **On-Screen Keyboard**. The only exceptions are:

- Save: **Ctrl/Cmd - S**
- Start/Stop Record: **Num ***
- Start/Stop Playback: **Space**
- Jump to Left Locator: **Num 1**
- Delete: **Delete** or **Backspace**
- Cycle on/off: **Num /**
- Show/Hide Transport panel: **F2**
- Show/Hide On-Screen Keyboard: **Alt/Opt - K**

Recording MIDI With the On-Screen Keyboard

You can use the **On-Screen Keyboard** to record MIDI in Cubase.

PREREQUISITE

You have selected a MIDI or instrument track and activated **Record Enable**.

PROCEDURE

1. Select **Studio > On-Screen Keyboard**.
2. On the **Transport** panel, activate **Record**.
3. Perform one of the following actions to enter notes:
 - Click on the keys of the **On-Screen Keyboard**.
 - Press the corresponding key on your computer keyboard.

NOTE

Press several keys simultaneously to enter polyphonic parts. The maximum number of notes that can be played at one time varies between the different operating systems and hardware configurations.

AFTER COMPLETING THIS TASK

Close the **On-Screen Keyboard** to make all key commands available again.

On-Screen Keyboard Options

The **On-Screen Keyboard** offers different display modes as well as other options.

- To open the **On-Screen Keyboard**, select **Studio > On-Screen Keyboard**.

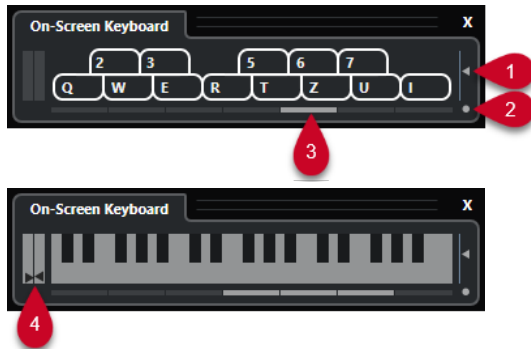

1 Note Velocity Level

This slider allows you to adjust the volume of the **On-Screen Keyboard**. You can also use **Up Arrow** or **Down Arrow** for this.

2 Change On-Screen Keyboard Type

This button allows you to switch between computer keyboard and piano keyboard display mode.

In computer keyboard mode, you can use the two rows of keys that are displayed on the **On-Screen Keyboard** to enter notes.

The piano keyboard has a wider range of keys. It allows you to enter more than one voice simultaneously. You can also use **Tab** for this.

3 Octave Offset

These buttons allow you to switch the keyboard range to a lower or higher octave. You have seven full octaves at your disposal. You can also use **Left Arrow** or **Right Arrow** for this.

4 Pitchbend/Modulation Sliders

These sliders are only available in piano keyboard mode. The left slider displays pitchbend, the right slider shows modulation changes. To introduce modulation, click on a key and drag upwards or downwards. To introduce pitchbend, drag left or right.

Recording

In Cubase, you can record audio and MIDI.

Make the following initial preparations:

- Set up, connect, and calibrate your audio hardware.
- Open a project and set up the parameters in the **Project Setup** dialog according to your specifications.

The parameters in the **Project Setup** dialog determine the record file format, sample rate, project duration, etc. that affect the audio recordings that you make during the course of the project.

- If you plan to record MIDI, set up and connect your MIDI equipment.

RELATED LINKS

[Setting up Audio](#) on page 13

[Setting up MIDI](#) on page 22

Basic Recording Methods

The basic recording methods apply to audio and MIDI recordings.

Record Enabling Tracks

To be able to record, you must record-enable the tracks on which you want to record.

PROCEDURE

- Do one of the following:
 - Activate **Record Enable** in the track list.
 - Activate **Record Enable** in the **MixConsole**.
 - Select the track that you want to record-enable, and activate **Record Enable** in the **Inspector**.

RESULT

The tracks are record-enabled.

NOTE

If you set up a key command for **Activate Record Enable for all Audio Tracks** in the **Mixer** category of the **Key Commands** dialog, you can record-enable all audio tracks simultaneously. The exact number of audio tracks that you can record simultaneously depends on your computer CPU and hard disk performance. Activate the **Warn on Processing Overloads** option in the **Preferences** dialog (**VST** page) to show a warning message as soon as the **Processing Overload** indicator lights up during recording.

RELATED LINKS

[Editing - Project & MixConsole](#) on page 832

[VST](#) on page 848

Record Enabling Tracks on Selection

You can set up a preference so that tracks are record-enabled when you select them.

PROCEDURE

1. Select **Edit > Preferences**.
 2. Open the **Editing—Project & MixConsole** page and activate **Enable Record on Selected Audio Track** or **Enable Record on Selected MIDI Track**.
-

RESULT

The tracks are record-enabled when you select them.

Activating Recording Manually

You can activate recording manually.

PROCEDURE

- Do one of the following:
 - Click **Record** on the **Transport** panel, on the toolbar, or in the **Transport Bar**.
 - Press **Num ***.
-

RESULT

Recording starts from the current cursor position.

NOTE

When you start recording in stop mode, you can start recording from the left locator. For this to work, you must select **Transport > Common Record Modes** and activate **Start Record at Left Locator/Punch In Position**. The metronome count-in will be applied.

Activating Recording Automatically

Cubase can automatically switch from playback to recording at a given position. This is useful if you must replace a section of a recording and want to listen to what is already recorded up to the recording start position.

PROCEDURE

1. Set the left locator to the position where you want to start recording.
 2. Activate **Punch In** on the **Transport** panel.
 3. Activate playback from any position before the left locator.
-

RESULT

When the project cursor reaches the left locator, recording is automatically activated.

RELATED LINKS

[Punch In and Punch Out](#) on page 203

Stopping Recording

You can stop recording manually.

PROCEDURE

- Do one of the following:
 - Click **Stop** on the **Transport** panel.
 - Press **Num ***.
-

RESULT

Recording stops while playback continues.

Stopping Recording Automatically with Punch Out

Activating **Punch Out** allows you to stop recording automatically at the defined punch out position.

PROCEDURE

- Activate **Punch Out** on the **Transport** panel.
-

RESULT

Recording stops automatically when the project cursor reaches the punch out position. Playback continues.

RELATED LINKS

[Punch In and Punch Out](#) on page 203

Stopping Recording and Playback

You can manually stop recording and playback.

PROCEDURE

- Do one of the following:
 - Click **Stop** on the **Transport** panel.
 - Press **Num 0**.
-

RESULT

Recording and playback stops.

Cycle Recording

You can record in a cycle, that is, you can record a selected section repeatedly and seamlessly.

PREREQUISITE

A cycle is set up with the left and right locators.

PROCEDURE

1. Click **Activate Cycle** on the **Transport** panel to activate cycle mode.
2. Activate recording from the left locator, before or within the cycle.

As soon as the project cursor reaches the right locator, it jumps back to the left locator and continues recording a new lap.

RESULT

The results of cycle recording depend on the selected record mode. They also differ for audio and MIDI.

RELATED LINKS

[Left and Right Locators](#) on page 197

[MIDI Recording](#) on page 224

[Audio Recording](#) on page 219

Common Record Modes Menu

The **Common Record Modes** determine what happens if you click **Record** during an audio or MIDI recording.

- To access the record modes, select **Transport > Common Record Modes**.
You can also access the **Common Record Modes** by clicking the upper part of the **Record Modes** section on the **Transport** panel.

Punch In/Out

In this mode, the recording is stopped.

Re-Record

In this mode, the recording is reinitiated, the events are removed, and recording is restarted from the exact same position.

Start Recording at Project Cursor Position

In this mode, recording starts from the cursor position.

Start Recording at Left Locator/Punch In Position

In this mode, recording starts from the left locator.

RELATED LINKS

[Transport Menu](#) on page 185

[Transport Panel Sections](#) on page 181

Re-Recording

If you activate the **Re-Record** mode, you can reinitiate your recording by hitting the **Record** button again. Recording will restart from the initial position.

PROCEDURE

1. Select **Transport > Common Record Modes**, and activate **Re-Record**.
 2. Activate recording.
 3. Click **Record** again to restart recording.
-

RESULT

The project cursor jumps back to the record start position, and recording is reinitiated.

NOTE

The previous recordings are removed from the project and cannot be retrieved using **Undo**. However, they remain in the **Pool**.

Monitoring

In Cubase, monitoring means listening to the input signal while preparing to record or while recording.

The following ways of monitoring are available:

- Via Cubase.
- Externally by listening to the signal before it reaches Cubase.
- By using ASIO Direct Monitoring.
This is a combination of both other methods.

Monitoring via Cubase

If you use monitoring via Cubase, the input signal is mixed with the audio playback. This requires an audio hardware configuration with a low latency value.

PROCEDURE

1. In the track list, activate **Monitor**.



2. In the **MixConsole**, adjust the monitoring level and the panning.
You can add effects and EQ to the monitor signal using the channel of the track. If you are using plug-in effects with large inherent delays, the automatic delay compensation function in Cubase will increase the latency. If this is a problem, you can use the **Constrain Delay Compensation** function while recording.
3. In the **Preferences** dialog, select **VST**.
4. Open the **Auto Monitoring** pop-up menu, and select a monitoring mode.

RESULT

The monitored signal will be delayed according to the latency value, which depends on your audio hardware and drivers. You can check the latency of your hardware in the **Studio Setup** dialog (**Audio System** page).

RELATED LINKS

[VST](#) on page 848

[Constrain Delay Compensation](#) on page 523

External Monitoring

External monitoring means listening to the input signal before it is sent into Cubase. It requires an external mixer for mixing the audio playback with the input signal. The latency value of the audio hardware configuration does not affect the monitor signal. When using external monitoring, you cannot control the level of the monitor signal from within Cubase or add VST effects or EQ to the monitor signal.

PROCEDURE

1. In the **Preferences** dialog, select **VST**.
 2. Open the **Auto Monitoring** pop-up menu and select **Manual**.
 3. Deactivate **Monitor** in Cubase.
 4. On your mixing desk or mixer application for your audio hardware, activate the **Thru** or **Direct Thru** mode to send the input audio back out again.
-

ASIO Direct Monitoring

If your audio hardware is ASIO 2.0 compatible, it may support ASIO Direct Monitoring. This feature may also be available for audio hardware with macOS drivers. In ASIO Direct Monitoring mode, the monitoring is done in the audio hardware, and monitoring is controlled via Cubase. The latency value of the audio hardware configuration does not affect the monitor signal when using ASIO Direct Monitoring.

PROCEDURE

1. In the track list, activate **Monitor**.



2. Select **Studio > Studio Setup**.
 3. In the **Devices** list, select your audio hardware driver, and activate **Direct Monitoring**.
If the checkbox is grayed out, your audio hardware (or its driver) does not support ASIO Direct Monitoring. Consult the audio hardware manufacturer for details.
 4. In the **Preferences** dialog, select **VST**.
 5. Open the **Auto Monitoring** pop-up menu, and select a monitoring mode.
 6. In the **MixConsole**, adjust the monitoring level and panning.
Depending on the audio hardware, this might not be possible.
-

AFTER COMPLETING THIS TASK

You can monitor the input levels of audio tracks, that is, you can map the input bus metering to monitor-enabled audio tracks and watch the input levels of your audio tracks when working in the **Project** window.

- Activate **Map Input Bus Metering to Audio Track (in Direct Monitoring)** in the **Preferences** dialog (**Metering** page).
As the tracks are mirroring the input bus signal, you will see the same signal in both places. When using mapped metering, any functions that you apply to the audio track are not reflected in its meters.

RELATED LINKS

[VST on page 848](#)

Monitoring MIDI Tracks

You can monitor everything you play and record through the MIDI output and channel that are selected for the MIDI track.

PREREQUISITE

Local Off is activated on your MIDI instrument.

PROCEDURE

1. In the **Preferences** dialog, select **MIDI**.
2. Make sure **MIDI Thru Active** is activated.
3. In the track list, activate **Monitor**.



RESULT

Incoming MIDI is echoed back out again.

RELATED LINKS

[MIDI](#) on page 839

Audio Recording Specifics

Specific preparations and settings are required for audio recording.

Audio Recording Preparations

Before you can record audio, you must make some preparations.

Selecting a Record File Format

You can set up the record file format, that is, the sample rate, bit depth, and the record file type for new audio files.

PROCEDURE

1. Select **Project > Project Setup**.
2. Set up the settings for **Sample Rate**, **Bit Depth**, and **Record File Type**.

IMPORTANT

The bit depth and the file type can be changed at any time, while the sample rate of a project cannot be changed at a later stage.

RELATED LINKS

[Creating New Projects](#) on page 82

Setting the Audio Record Folder

Each Cubase project has a project folder containing an **Audio** folder. By default, this is where recorded audio files are stored. However, if needed, you can select record folders independently for each audio track.

PROCEDURE

1. In the track list, select all tracks to which you want to assign the same record folder.
2. Right-click one of the tracks to open the context menu.
3. Select **Set Record Folder**.
4. In the file dialog, navigate to the folder that you want to use as the record folder or create a new folder by clicking **New Folder**.

If you want separate folders for different types of material (speech, ambient sounds, music, etc.), you can create subfolders within the project **Audio** folder and assign different tracks to different subfolders. This way, all audio files still reside within the project folder, which makes managing the project easier.

Getting the Track Ready for Recording

Before you can record audio, you must add a track and set it up.

Adding a Track and Setting the Channel Configuration

To record audio, you must add an audio track and set up its channel configuration. The channel configuration of the track determines the channel configuration of the recorded audio file.

PROCEDURE

1. In the global track controls area of the track list, click **Add Track** .
 2. Click **Audio**.
 3. In the **Count** value field, select the number of tracks that you want to add.
 4. Open the **Configuration** pop-up menu, and select a channel configuration.
 5. Optional: In the **Name** field, enter a track name.
 6. Click **Add Track**.
-

RELATED LINKS

[Add Track Dialog – Audio](#) on page 105

RAM Requirements for Recording

Each track on which you record requires a certain amount of RAM, and the memory usage increases, the longer the recording lasts. For each audio channel, 2.4 MB of RAM are required for **MixConsole** settings, etc. The memory usage increases with the length of the recording, the sample rate, and the number of tracks you record. Consider the RAM limitation of your operating system when setting up your project for recording.

Selecting an Input Bus for the Track

Before you can record on your track, you must add and set up the required input busses and specify from which input bus the track records.

PROCEDURE

1. In the **Inspector** for the audio track, open the **Input Routing** pop-up menu.

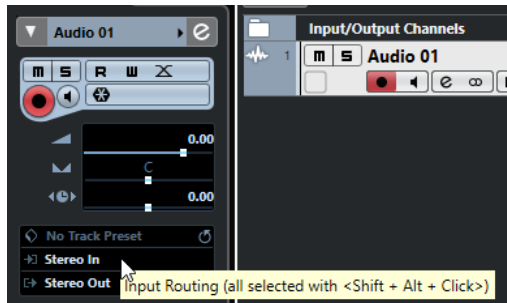

2. Select an input bus.
-

RELATED LINKS

- [Setting up Input and Output Ports](#) on page 21
- [Audio Bus Setup](#) on page 22
- [Audio Track Inspector](#) on page 107

Audio Recording

To record audio, use any of the basic recording methods.

When you finish recording, an audio file is created in the **Audio** folder within the project folder. In the **Pool**, an audio clip is created for the audio file, and an audio event that plays the whole clip appears on the recording track. Finally, a waveform image is calculated for the audio event. If the recording was very long, this may take a while.

NOTE

The waveform image is calculated and displayed during the actual recording process. This real-time calculation uses some processing power. If your processor is slow or if you are working on a CPU-intensive project, deactivate **Create Audio Images during Record** in the **Preferences** dialog (**Record—Audio** page).

RELATED LINKS

- [Basic Recording Methods](#) on page 211
- [Cycle Recording](#) on page 213

Audio Record Modes

By selecting an **Audio Record Mode**, you decide what happens to your recording and to any existing events on the track where you are recording. This is necessary because the tracks you record on are not necessarily empty. There may be situations where you record over existing events, especially in cycle mode.

- To access the record modes, select **Transport > Audio Record Mode**.
You can also access the **Audio Record Modes** by clicking to the right of the audio symbol in the **Record Modes** section on the **Transport** panel.

Keep History

Existing events or portions of events that overlap with a new recording are kept.

Cycle History + Replace

Existing events or portions of events that overlap with a new recording are replaced by the new recording. However, if you record in cycle mode, all takes from the current cycle recording are kept.

Replace

Existing events or portions of events that overlap with a new recording are replaced by the last recorded take.

RELATED LINKS

[Transport Menu](#) on page 185

[Transport Panel Sections](#) on page 181

Recording and Effects

Cubase allows you to add effects and/or EQ while recording. This is done by adding insert effects and/or making EQ settings for the input channel in the **MixConsole**.

IMPORTANT

If you record with effects, the effects become part of the audio file itself. You cannot change the effect settings after recording.

When you record with effects, consider using 32-bit float or 64-bit float format. This way, the bit depth is not reduced, which means there is no risk of clipping at this stage. Also, this preserves the signal quality perfectly. If you record in 16-bit or 24-bit format, the available headroom is lower, which means clipping can occur if the signal is too loud.

Undoing Recordings

You can undo a recording immediately after recording it.

PROCEDURE

- Select **Edit > Undo**.
-

RESULT

- The events that you just recorded are deleted from the **Project** window.
- The audio clips in the **Pool** are moved to the trash folder.

AFTER COMPLETING THIS TASK

To remove the recorded audio files from the hard disk, select **Media > Open Pool Window**, right-click the **Trash** icon and select **Empty Trash**.

RELATED LINKS

[Pool Window](#) on page 446

Recovery of Audio Recordings

Cubase allows you to recover audio recordings.

You can recover audio recordings in two situations:

- You hit **Record** too late.
For this to work, you must specify an audio pre-record time.
- The system failed during recording.

Specifying an Audio Pre-Record Time

You can capture up to 1 minute of any incoming audio that you play in stop mode or during playback. This is possible because Cubase can capture audio input in buffer memory, even when not recording.

PROCEDURE

1. In the **Preferences** dialog, select **Record > Audio**.
2. Specify a time (up to 60 seconds) in the **Audio Pre-Record Seconds** field.
This activates the buffering of audio input, making pre-recording possible.
3. Make sure that the audio track is record-enabled and receives audio from the signal source.
4. When you have played some audio material that you want to capture (either in stop mode or during playback), click **Record**.
5. Stop the recording after a few seconds.
This creates an audio event that starts where the cursor position was when you activated recording. If you were in stop mode, and the cursor was at the beginning of the project, you may have to move the event to the right in the next step. If you were playing along to a project, you can leave the event where it is.
6. Select the **Object Selection** tool.
7. Place the cursor on the bottom left edge of the event, so that a double arrow appears. Then click and drag to the left.

RESULT

The event is now extended, and the audio that you played before activating the recording is inserted. This means that if you played along during playback, the captured notes end up exactly where you played them in relation to the project.

RELATED LINKS

[Record - Audio](#) on page 844

Recovery of Audio Recordings after System Failure

Cubase allows you to recover audio recordings after a system failure.

When you experience a computer crash during a recording, relaunch the system, and check the project record folder. By default, this is the **Audio** subfolder inside the project folder. It should contain the audio file that you recorded, from the moment when you started recording to the time when your computer crashed.

NOTE

- This feature does not constitute an overall guarantee by Steinberg. While the program itself is capable of recovering audio recordings after a system failure, it is always possible that a computer crash, power cut, etc. might have damaged another component of the computer, making it impossible to save or recover any of the data.

- Do not try to actively bring about this kind of situation to test this feature. Although the internal program processes are designed to cope with such situations, Steinberg cannot guarantee that other parts of the computer are not damaged as a consequence.
-

MIDI Recording Specifics

Specific preparations and settings are required for MIDI recordings.

RELATED LINKS

[MIDI Recording Specifics](#) on page 222

[Recording in MIDI Editors](#) on page 224

[MIDI Record Modes](#) on page 226

MIDI Recording Preparations

The preparations described in the following sections mainly focus on external MIDI devices.

MIDI Instruments and Channels

Most MIDI synthesizers can play several sounds simultaneously, each on a different MIDI channel. This allows you to play back several sounds (bass, piano, etc.) from the same instrument.

Some devices, such as General MIDI compatible sound modules, always receive on all 16 MIDI channels. If you have such an instrument, you do not have to adjust any settings in the instrument.

On other instruments, use the front panel controls to specify the number of parts, timbres, and the like, so that they all receive on one MIDI channel.

For more information, refer to the manual that came with your instrument.

Naming MIDI Ports

MIDI inputs and outputs are often displayed with long and complicated names. In Cubase, you can rename your MIDI ports to more descriptive names.

PROCEDURE

1. Select **Studio > Studio Setup**.
 2. In the **Devices** list, select **MIDI Port Setup**.
The available MIDI inputs and outputs are listed. On Windows, the device to choose depends on your system.
 3. Click in the **Show As** column, and type in a new name.
 4. Click **OK**.
-

RESULT

The new port names appear on the **Input Routing** on the **Output Routing** pop-up menus.

Setting the MIDI Input

In the **Inspector**, set the MIDI input for the track.

PROCEDURE

1. In the track list, select the track to which you want to assign a MIDI input.
2. In the topmost **Inspector** section, open the **Input Routing** pop-up menu, and select an input.

The available inputs depend on the type of MIDI interface that you use. If you hold down **Shift-Alt/Opt**, the selected MIDI input is used for all selected MIDI tracks.

NOTE

If you select **All MIDI Inputs**, the track receives MIDI data from all available MIDI inputs.

Setting the MIDI Channel and Output

The MIDI channel and the output settings determine where the recorded MIDI is routed during playback. They are also relevant for monitoring MIDI in Cubase. You can select the channel and the output from the track list or in the **Inspector**.

PROCEDURE

1. In the track list, select the track to which you want to assign a MIDI channel and an output.
2. In the topmost **Inspector** section, open the **Output Routing** pop-up menu and select an output.

The available outputs depend on the type of MIDI interface that you use. If you hold down **Shift-Alt/Opt**, the selected MIDI output is used for all selected MIDI tracks.

3. Open the **Channel** pop-up menu, and select a MIDI channel.

NOTE

If you select **Any** as the MIDI channel, the MIDI material is routed to the channels that are used by your MIDI instrument.

Selecting a Sound

You can select sounds from within Cubase by instructing the program to send Program Change and Bank Select messages to your MIDI device.

PROCEDURE

1. In the track list, select the track to which you want to assign a sound.
2. In the track list or in the **Inspector**, open the **Program Selector** pop-up menu, and select a program.
Program Change messages give you access to 128 different program locations.
3. If your MIDI instruments have more than 128 programs, you can open the **Bank Selector** pop-up menu and select different banks, each containing 128 programs.

NOTE

Bank Select messages are recognized differently by different MIDI instruments. The structure and the numbering of banks and programs may also vary. Refer to the documentation of your MIDI instruments for details.

RELATED LINKS

[MIDI Track Inspector](#) on page 116

Recording in MIDI Editors

You can record MIDI data into the MIDI part that is opened in a MIDI editor.

PREREQUISITE

You have selected **Merge** or **Replace** as the **MIDI Record Mode**.

PROCEDURE

1. Click in the MIDI editor so that it gets the focus.
 2. In the MIDI editor toolbar, activate **Record in Editor**.
 3. Do one of the following to activate recording:
 - Click **Record** on the **Transport** panel.
 - Click **Record** on the toolbar.
-

RESULT

The MIDI data is recorded into the MIDI part that is open in the MIDI editor. If you record outside the part borders, the part is automatically enlarged.

RELATED LINKS

[Key Editor Toolbar](#) on page 645

MIDI Recording

To record MIDI, use any of the basic recording methods.

When you finish recording, a part that contains MIDI events is created in the **Project** window.

NOTE

If you perform a live recording on a VST instrument, you usually compensate the latency of the audio card by starting to play earlier. As a consequence, the timestamps are recorded too early. If you activate **ASIO Latency Compensation** on the track list, all recorded events are moved by the current latency setting.

The following preferences affect MIDI recording:

- Length Adjustment
- Snap MIDI Parts to Bars
- MIDI Record Catch Range in ms
- ASIO Latency Compensation Active by Default

You can find them in the **Preferences** dialog on the **MIDI** and on the **Record—MIDI** page.

RELATED LINKS

[Basic Recording Methods](#) on page 211

[MIDI](#) on page 839

[Record - MIDI](#) on page 844

Types of MIDI Messages

You can record different types of MIDI messages.

- To specify which event types are recorded, deactivate the options for the type of MIDI message that you want to record in the **Preferences** dialog (**MIDI—MIDI Filter** page).

RELATED LINKS

[MIDI - MIDI Filter](#) on page 842

Note Messages

Cubase records note-on, note-off, and MIDI channel messages.

If you press and release a key on your synthesizer or on another MIDI keyboard, the following messages are recorded:

- Note-on (key down)
- Note-off (key up)
- MIDI channel

NOTE

Normally, the MIDI channel information is overridden by the MIDI channel setting for the track. However, if you set the track **Any** as the MIDI channel, the notes is played back on their original channels.

Continuous Messages

Pitchbend, aftertouch, and controllers, such as modulation wheel, sustain pedal, volume, etc. are considered continuous MIDI events, as opposed to the momentary key down and key up messages.

You can record continuous messages with or separate from the notes, that is, afterwards or before.

You can record continuous messages on their own tracks, separately from the notes to which they belong. As long as you set the two tracks to the same output and MIDI channel, the MIDI instrument identifies them as two simultaneously created recordings.

Program Change Messages

When you switch from one program to another on your synthesizer or on another MIDI keyboard, a number corresponding to that program is sent out as a Program Change Message via MIDI.

You can record Program Change Messages with or separate from the notes, that is, afterwards or before.

You can record Program Change Messages on their own tracks, separately from the notes to which they belong. As long as you set the two tracks to the same output and MIDI channel, the MIDI instrument identifies them as two simultaneously created recordings.

System Exclusive Messages

SysEx (System Exclusive) messages are special types of MIDI messages that are used to send data that only makes sense to a unit of a certain make and type.

SysEx can be used to transmit a list of the numbers that make up the settings of one or more sounds in a synth.

Reset Function

The **Reset** function sends out note-off messages and resets controllers on all MIDI channels. This is sometimes necessary if you experience hanging notes, constant vibrato, etc. when punching in and out on MIDI recordings with pitchbend or controller data.

- To perform a manual MIDI reset, select **MIDI > Reset**.
- If you want Cubase to perform a MIDI reset on stop, activate **Reset on Stop** in the **Preferences** dialog (**MIDI** page).
- If you want Cubase to insert a reset event at the end of a recorded part, activate **Insert Reset Events after Record** in the **Preferences** dialog (**MIDI** page).

This resets controller data such as sustain, aftertouch, pitchbend, modulation, and breath control. This is useful if a MIDI part is recorded and the sustain pedal is still held after stopping the recording. Usually, this would cause all following parts to be played with sustain, as the pedal off command was not recorded.

RELATED LINKS

[MIDI](#) on page 839

MIDI Record Modes

By selecting a **MIDI Record Mode**, you decide what happens to any existing parts on the track where you are recording. MIDI tracks can play back all events in overlapping parts. If you record several parts in the same locations or move parts so that they overlap, you will hear the events in all parts.

NOTE

If you activate **Record in Editor** to record MIDI data in the editor, all new recordings are merged into the active part, and the **MIDI Record Modes** do not apply.

- To access the record modes, select **Transport > MIDI Record Mode**.
You can also access the **MIDI Record Modes** by clicking to the right of the MIDI symbol in the **MIDI Recording Modes** section on the **Transport** panel.

MIDI Record Mode

New Parts

Existing parts that overlap with a new recording are kept. The new recording is saved as a new part.

Merge

Existing events in parts that overlap with a new recording are kept. The newly recorded events are added to the existing part.

Replace

Existing events in parts that overlap with a new recording are replaced.

MIDI Cycle Record Mode

When you record MIDI in cycle mode, the result not only depends on the MIDI record mode, but also on the cycle record mode that is selected in the **Cycled MIDI Recording Only** section.

Mix

For each completed lap, everything you record is added to what was previously recorded. This is useful for building up rhythm patterns. Record a hi-hat part on the first lap, the bass drum part on the second lap, etc.

Overwrite

As soon as you play a MIDI note or send any MIDI message, all MIDI that you have recorded on previous laps is overwritten from that point. Make sure that you stop playing before the next lap begins. Otherwise, you will overwrite the entire take.

Keep Last

Each completed lap replaces the previously recorded lap. If you deactivate recording or press **Stop** before the cursor reaches the right locator, the previous take will be kept. If you do not play or input any MIDI during a lap, nothing happens, and the previous take is kept.

RELATED LINKS

[MIDI Recording Specifics](#) on page 222

[Recording in MIDI Editors](#) on page 224

[Transport Menu](#) on page 185

[Transport Panel Sections](#) on page 181

Automatic MIDI Record Quantize

Cubase can automatically quantize MIDI notes on recording.

- **Automatic MIDI Record Quantize**  is available in the **MIDI Auto Quantize** section of the **Transport Bar**.

If you activate **Auto Quantize**, the notes that you record are automatically quantized according to the quantize settings.

RELATED LINKS

[Quantizing MIDI and Audio](#) on page 240

[Quantize Panel](#) on page 243

Recovery of MIDI Recordings

Cubase allows you to recover MIDI data, including controller data, that was captured in **Stop** mode or during playback.

The MIDI data is stored in the retrospective record buffer, and you can insert it as a MIDI part on the selected MIDI track.

The buffer captures up to 10000 MIDI events. This can amount to a MIDI recording of around 2 minutes and 30 seconds. However, if you use a keyboard that produces a large amount of MIDI controller events, such as the ROLI Seaboard, this only corresponds to a recording of around 20 seconds.

NOTE

In the **Preferences** dialog (**Record—MIDI** page), you can specify a **Retrospective Record Buffer Size**.

If the buffer is full, the MIDI events that were captured first are replaced by the new events. MIDI events in the buffer are also replaced in the following situations:

- You have inserted the retrospective recording on a track, and you play new events in **Stop** mode or during playback.
- You play MIDI notes in **Stop** mode, and you do not play for more than 30 seconds, before playing further MIDI events in **Stop** mode.

NOTE

You can also empty the buffer manually.

RELATED LINKS

[Record - MIDI](#) on page 844

[Emptying the Retrospective Record Buffer](#) on page 230

Inserting a Retrospective Recording from All MIDI Inputs into the Selected Track

You can insert a retrospective recording, that is, MIDI data that was sent to **All MIDI Inputs** in **Stop** mode or during playback, into the selected track.

PREREQUISITE

You have played MIDI notes in **Stop** mode or during playback, and you want to recover them.

PROCEDURE

1. Select the MIDI track into which you want to insert the captured MIDI data.
 2. Select **Transport > MIDI Retrospective Recording > Insert from All MIDI Inputs**.
-

RESULT

The MIDI data that was captured at **All MIDI Inputs** is inserted into the selected track as a single, linear MIDI part.

NOTE

If you insert buffer data from multiple selected tracks, the timing offsets between the data played on the different tracks are retained.

Inserting a Retrospective Track Recording

You can insert a retrospective track recording, that is, MIDI data that was sent to the track input in **Stop** mode or during playback, into the selected track.

PREREQUISITE

You have played MIDI notes in **Stop** mode or during playback, and you want to recover them.

PROCEDURE

1. Select the MIDI track into which you want to insert the captured MIDI data.
2. In the top section of the MIDI track **Inspector**, click **Retrospective Recording**.

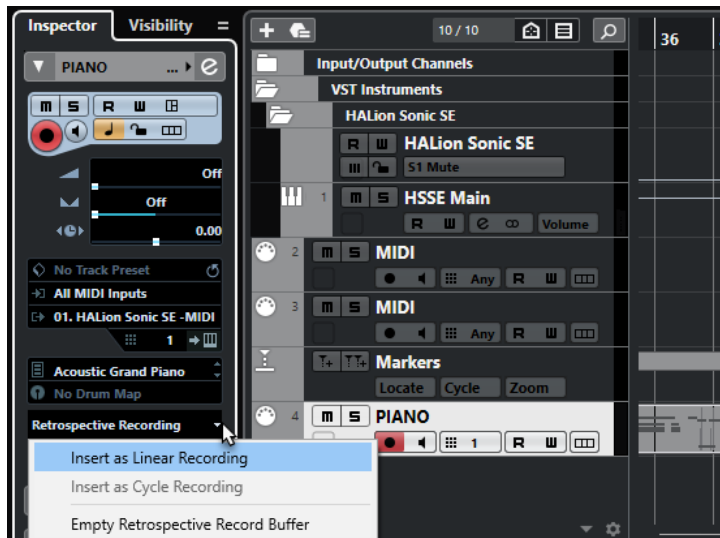

3. From the pop-up menu, select one of the following:
 - To insert the MIDI data as one, continuous MIDI part, select **Insert as Linear Recording**.
 - To insert the MIDI data as stacked MIDI parts, select **Insert as Cycle Recording**.

NOTE

This is only available if your MIDI data was captured during playback, and if cycle mode was active.

RESULT

The MIDI data that was captured at the track input is inserted into the track.

NOTE

If the data was captured during playback, it is inserted at the position where you played it. If the data was captured in **Stop** mode, it is inserted at the project cursor position.

Inserting a Retrospective Track Recording into an Editor

You can insert a retrospective track recording, that is, MIDI data that was sent to the track input in **Stop** mode or during playback, into the MIDI part that is open in a MIDI editor.

PREREQUISITE

You have played MIDI notes in **Stop** mode or during playback, and you want to recover them.

PROCEDURE

1. Double-click the MIDI part where you want to insert the captured MIDI data to open it in a MIDI editor.
 2. On the MIDI editor toolbar, click **Insert MIDI Retrospective Recording in Editor**.
-

RESULT

The MIDI data that was captured on the track input is inserted into the MIDI part.

- If the data was captured during playback, it is inserted into the MIDI part along the timeline.
- If the data was captured in **Stop** mode, it is inserted at the project cursor position.

Emptying the Retrospective Record Buffer

You can empty the retrospective record buffer manually.

PROCEDURE

- Do one of the following:
 - In the top section of the MIDI track **Inspector**, open the **Retrospective Recording** pop-up menu, and select **Empty Retrospective Record Buffer**.
 - Select a track, and select **Transport > MIDI Retrospective Recording > Empty All Buffers**.
-

Remaining Record Time

The **Max. Record Time** displays the time that is left for recording.

51h 25min

The available time depends on the current setup, for example, on the amount of tracks that are record-enabled, the sample rate for your project, and the available hard disk space.

- To open the display, select **Studio > More Options > Max. Record Time**.

NOTE

The remaining recording time is also shown in the status line above the track list.

If you use individual record folders to store your tracks on different drives, the time display refers to the medium with the least available storage space.

Lock Record

The **Lock Record** function prevents you from accidentally deactivating record mode.

- Select **Edit > Key Commands**. In the **Transport** category, assign key commands to the **Lock Record** and **Unlock Record** commands.

If **Lock Record** is activated and you want to enter stop mode, confirm this in the corresponding dialog. You can also use the **Unlock Record** key command first and then enter stop mode as usual.

NOTE

An automatic punch out at the right locator position is ignored in **Lock Record** mode.

Importing Audio and MIDI Files

You can add audio and MIDI files to your project by importing them.

Audio File Import

You can import compressed and uncompressed audio files in a variety of different formats. You can also import audio from audio CDs or extract the audio of video files.

RELATED LINKS

[Importing Audio Files](#) on page 233

[Importing Audio CD Tracks](#) on page 234

[Importing Audio from Video Files](#) on page 236

[Importing ReCycle Files](#) on page 237

[Importing Media](#) on page 459

Setting up Audio File Import Options

You can specify how to handle audio files on import.

PROCEDURE

1. In the **Preferences** dialog, select **Editing > Audio**.
2. Select an option from the **On Import Audio Files** pop-up menu.

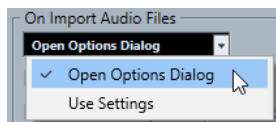

3. Click **OK**.

RESULT

The import settings are saved and take effect when you import audio.

- If you selected **Open Options Dialog**, the **Import Options** dialog opens on every import and allows you to make your changes.
- If you selected **Use Settings**, the settings specified in the **On Import Audio Files** section of the **Preferences** dialog are used.

RELATED LINKS

[Import Options Dialog for Audio Files](#) on page 231

[On Import Audio Files Settings](#) on page 232

Import Options Dialog for Audio Files

The **Import Options** dialog allows you to make specific settings for the audio import.

- When you import audio files and **Open Options Dialog** is activated in the **On Import Audio Files** section of the **Preferences** dialog (**Editing—Audio** page), the **Import Options** dialog opens.

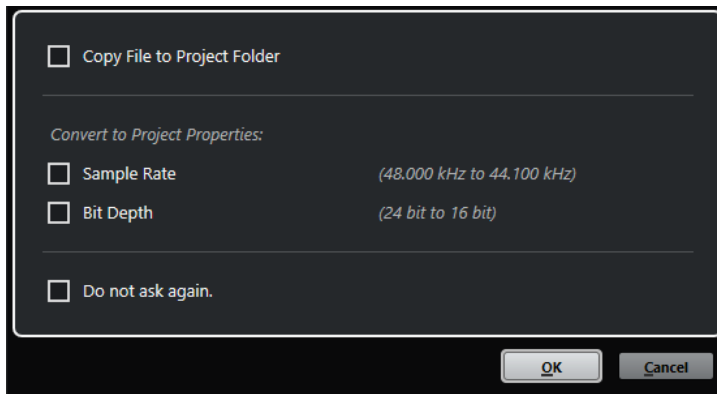

Import Options dialog for single file import

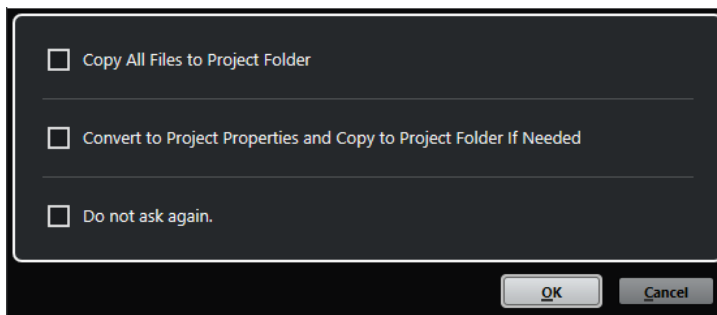

Import Options dialog for multiple file import

Copy File to Project Folder/Copy All Files to Project Folder

Copies the audio file to the **Audio** folder of the project and causes the clip refer to the copy.

Deactivate this option if you want the clip to refer to the original file in the original location. In this case, it is marked as “external” in the **Pool**.

Convert to Project Settings/Convert to Project Settings and Copy to Project Folder If Needed

Converts the imported file if the sample rate or the bit depth differ from the settings in the **Project Setup** dialog. For single file import, you can choose which properties are converted.

Do not ask again

Always applies the current settings without opening the dialog again. You can reset this option in the **Preferences** dialog (**Editing—Audio** page).

RELATED LINKS

[Setting up Audio File Import Options](#) on page 231

On Import Audio Files Settings

You can set up standard settings that are performed automatically, each time you import audio files.

- When you import audio files and **Use Settings** is activated in the **On Import Audio Files** section of the **Preferences** dialog (**Editing—Audio** page), the settings are used for importing audio.

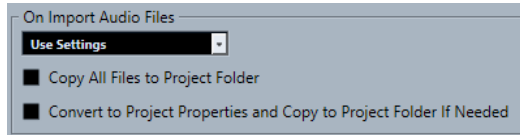

Copy File to Project Folder/Copy All Files to Project Folder

Copies the audio file to the **Audio** folder of the project and causes the clip refer to the copy.

Deactivate this option if you want the clip to refer to the original file in the original location. In this case, it is marked as “external” in the **Pool**.

Convert to Project Settings/Convert to Project Settings and Copy to Project Folder If Needed

Converts the imported file if the sample rate or the bit depth differ from the settings in the **Project Setup** dialog. For single file import, you can choose which properties are converted.

Importing Audio Files

You can import uncompressed audio and compressed audio in several formats.

PROCEDURE

1. Select **File > Import > Audio File**.
2. In the file dialog that opens, locate and select the audio file, and click **Open**.
3. Make your changes in the **Import Options** dialog.

NOTE

If **Use Settings** is activated in the **Preferences** dialog (**Editing—Audio** page), the corresponding import settings are used.

RESULT

In the **Project** window, an event referencing the audio file is inserted into the selected track at the project cursor position. If no track was selected, a new track is created.

A new audio clip is created and added to the **Pool**.

If you chose a compressed audio file other than FLAC, Cubase copies the original compressed file and converts it to wave format (Windows) or AIFF format (macOS).

NOTE

The resulting Wave/AIFF file is significantly larger than the original compressed file.

The imported file is placed in the **Audio** folder of the project.

RELATED LINKS

[Setting up Audio File Import Options](#) on page 231

Supported Compressed Audio File Formats

Cubase allows you to import compressed audio files.

The following compressed audio file formats are supported:

FLAC file

This is an open source format that reduces the size of audio files by 50 % to 60 %, compared to regular Wave files. The file extension is **.flac**.

MPEG 1 Layer 3 file

This is a family of standards used for encoding audio-visual information, such as movies, video, and music in a digital compressed format. Cubase can read MPEG Layer 2 and MPEG Layer 3. MP3 files are highly compressed files that still provide good audio quality. The file extension is **.mp3**.

Ogg Vorbis file

This is an open source, patent-free audio encoding and streaming technology. The Ogg Vorbis encoder uses variable bit rate encoding. It offers small, compressed audio files of comparatively high audio quality. The file extension is **.ogg**.

Windows Media Audio file (Windows only)

This is an audio file format defined by Microsoft Inc. WMA files can be decreased in size, with no loss of audio quality. The file extension is **.wma**.

Importing Audio CD Tracks

You can import audio from audio CDs into Cubase projects.

PROCEDURE

1. Select **File > Import > Audio CD** to import CD tracks into the **Project** window.
2. Activate every audio file that you want to import in the **Copy** column.
3. Optional: Set a **Default Name** and a **Destination Folder** for the imported audio files.
4. Click the **Copy** button to create a local copy of the audio files or sections.
5. Click **OK**.

RESULT

The copied audio files are imported into the **Project** window and inserted into new tracks at the project cursor position. By default, imported audio CD tracks are saved as wave files (Windows) or AIFF files (macOS), in the **Audio** folder of the current project.

New audio clips are created and added to the **Pool**.

NOTE

You can also import audio files to the **Pool** without importing them into the **Project** window.

RELATED LINKS

[Importing Media](#) on page 459

Import From Audio CD Dialog

The **Import from Audio CD** dialog allows you to specify how the CD tracks are imported.

- To open the **Import from Audio CD** dialog, select **File > Import > Audio CD**.

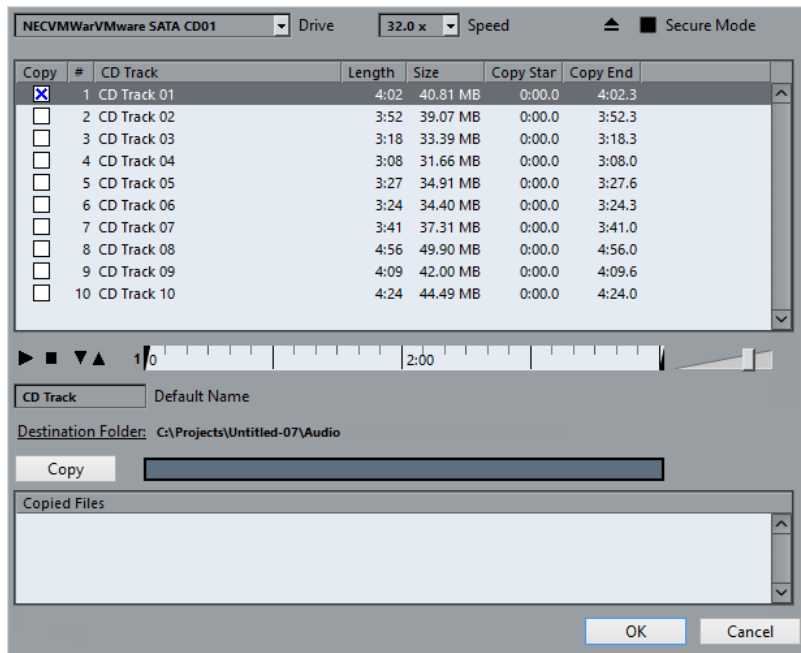

Drive

Opens a pop-up menu that allows you to select the correct CD drive.

Speed (Windows only)

Allows you to select the data transfer speed.

NOTE

While you normally want to use the fastest possible speed, you may have to select a slower speed for flawless audio extraction.

Eject CD

Opens the CD drive.

Secure Mode (Windows only)

Activates error checking and correction when reading the CD.

Columns

The columns in the dialog have the following functions:

Copy

Activate this option for the tracks that you want to copy/import.

#

Shows the track number.

CD Track

The name of the CD track. On import, this is used as file name. It is provided automatically from CDDB, if available.

To rename a track, click the track name and enter a new name.

Length

The length of the audio CD track in minutes and seconds.

Size

The file size of the audio CD track in MB.

Copy Start

The start of the section that is imported. On the ruler, drag the **Left Marker** to the right to adjust this.

Copy End

The end of the section that is imported. On the ruler, drag the **Right Marker** to the left to adjust this.

The Ruler

The ruler has the following functions:

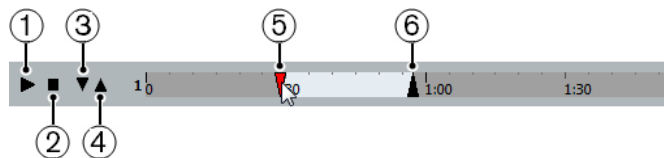

1 Play Tracks

Plays back the selected track from the start to the end or from the left marker to the right marker.

2 Stop Playback

Stops playback.

3 Play from Left Marker

Starts playback at the left marker.

4 Play to Right Marker

Starts playback a few moments prior to the right marker and stops at the right marker.

5 Left Marker

Allows you to set the copy start manually.

6 Right Marker

Allows you to set the copy end manually.

Destination Folder

Allows you to select a folder for the imported files.

Copy

Copies the files.

Copied Files

Lists the files that you copied for import.

Importing Audio from Video Files

You can import audio from a video file without importing the video itself.

PROCEDURE

1. Select **File > Import > Audio from Video File**.
 2. In the file dialog that opens, locate and select the video file, and click **Open**.
-

RESULT

The audio of the selected video file is extracted and converted to a wave file that is saved in the **Audio** folder.

A new audio clip is created and added to the **Pool**. In the **Project** window, an event referencing the audio file is inserted on the selected track at the project cursor position. If no track was selected, a new track is created.

RELATED LINKS

[Extracting Audio from Video](#) on page 800

[Importing Video Files](#) on page 792

Importing ReCycle Files

You can import REX and REX2 audio files created by ReCycle from Propellerhead Software. ReCycle slices a loop and creates separate samples of each beat, so that you can tempo match and edit a loop as if it was made of individual sounds.

PREREQUISITE

REX Shared Library is installed on your system.

PROCEDURE

1. Select an audio track, and move the project cursor to where you want the imported file to start.
2. Select **File > Import > Audio File**.
3. In the file dialog, open the file type pop-up menu, and select **REX File** or **REX 2 File**.
4. Select the file you want to import, and click **Open**.

RESULT

The file is imported and automatically adjusted to the current Cubase tempo.

The imported REX file consists of several events, one for each slice in the loop. The events are automatically placed in an audio part on the selected track and positioned so that the original internal timing of the loop is preserved.

AFTER COMPLETING THIS TASK

Open the part in the **Audio Part Editor** to edit each slice separately by muting, moving, and resizing events, adding effects and processing, for example.

You can also adjust the tempo and have the REX file automatically follow, provided that its track is set to a musical time base.

NOTE

You can achieve similar results by using Cubase's own loop slicing features.

RELATED LINKS

[Slices](#) on page 403

MIDI File Import

Cubase can import standard MIDI files. This allows you to transfer MIDI material to and from virtually any MIDI application, on any platform.

Import Options for MIDI Files

The **Import Options** for MIDI files allow you to specify what data to include in imported MIDI files.

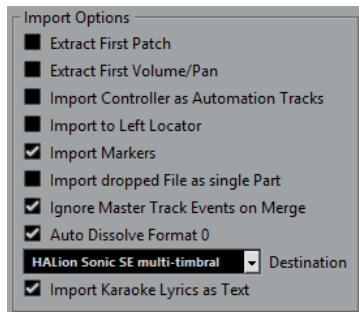

Extract First Patch

Converts the first **Program Change** and **Bank Select** events for each track to **Inspector** settings for the track.

Extract First Volume/Pan

Converts the first **MIDI Volume** and **Pan** events for each track to **Inspector** settings for the track.

Import Controller as Automation Tracks

Converts **MIDI Controller** events in the MIDI file to automation data for the MIDI tracks.

Import to Left Locator

Aligns the imported MIDI file to the position of the left locator.

Import Markers

Imports any markers that have been added.

Import Dropped File as Single Part

Places the file on one track if you drag a MIDI file into the project.

Ignore Master Track Events on Merge

Ignores tempo track data if you import a MIDI file into the current project. The imported MIDI file adapts to the current tempo track in the project.

Auto Dissolve Format 0

Automatically dissolves imported MIDI files of type 0. Each embedded MIDI channel in the file is placed on a separate track in the **Project** window.

Destination

Allows you to specify what happens when you drag a MIDI file into the project.

- **MIDI Tracks** creates MIDI tracks for the imported file.
- **Instrument Tracks** creates instrument tracks for each MIDI channel in the MIDI file and causes the program to automatically load appropriate presets.

- **HALion Sonic SE multi-timbral** creates several MIDI tracks, each routed to a separate instance of HALion Sonic SE in the **VST Instruments** window, and loads the appropriate presets.

Import Karaoke Lyrics as Text

Converts karaoke lyrics in the MIDI file to text that can be displayed in the **Score Editor**. If this option is deactivated, lyrics are only shown in the **List Editor**.

Importing MIDI Files

You can import MIDI files into Cubase.

PROCEDURE

1. Select **File > Import > MIDI File**.
 2. Optional: If a project is open, choose if you want to create a new project. If you select **No**, the MIDI file is imported into the current project.
 3. In the file dialog that opens, locate and select the MIDI file, and click **Open**.
-

RESULT

The MIDI file is imported. The result depends on the contents of the MIDI file and the settings you made in the **Import Options** section of the **Preferences** dialog (**MIDI—MIDI File** page).

RELATED LINKS

[Import Options for MIDI Files](#) on page 238
[Markers](#) on page 270

Yamaha XF Format

Cubase supports the Yamaha XF format. XF is an extension of the standard MIDI file format that allows you to save song-specific data with a MIDI file of type 0.

When importing a MIDI file containing XF data, this data is placed in parts on separate tracks called **XF Data**, **Chord Data**, or **SysEx Data**. You can edit such a part in the **List Editor** to add or change lyrics, for example.

IMPORTANT

Do not change the order of events within the XF data or the event data itself, unless you have a lot of experience with XF data.

Cubase can also export XF data as part of a MIDI file of type 0. If you do not want to export the XF data with the MIDI data, mute or delete the tracks containing the XF data.

MIDI Loops

In Cubase, you can import MIDI loops.

To import MIDI loops, use the **MediaBay**. MIDI loops have the file extension **.midiloop**.

RELATED LINKS

[Importing MIDI Loops](#) on page 524

Quantizing MIDI and Audio

Quantizing means moving recorded audio or MIDI and positioning it on the nearest grid position that is musically relevant. Quantizing is designed to correct errors, but you can also use it in a creative way.

You can quantize audio and MIDI to a grid or to a groove.

Audio and MIDI can be quantized at the same time. However, what exactly happens during quantizing differs for audio and MIDI:

- Audio quantizing affects the audio event starts.
- MIDI quantizing can affect the starts of MIDI events in a part, the MIDI event lengths, or the MIDI event ends.

NOTE

Quantizing is based on the original position of the events. Therefore, you can freely try out different quantize settings without the risk of destroying anything.

RELATED LINKS

[Quantizing Audio Event Starts](#) on page 242

[Quantizing MIDI Event Starts](#) on page 241

[Quantizing MIDI Event Lengths](#) on page 242

[Quantizing MIDI Event Ends](#) on page 242

Quantize Functions

The quantize functions are available in the **Edit** menu and in the **Snap** and **Quantize** sections of the **Project** window toolbar and the **Sample Editor** toolbar.

Quantize Functions on the Edit Menu

Quantize

Quantizes audio or MIDI event starts.

Reset Quantize

Reverts your audio or MIDI to its original, unquantized state, and resets any length changes that you performed in the **Quantize Panel**.

Quantize Panel

Opens the **Quantize Panel**.

Advanced Quantize

From this submenu, you can select the following functions:

- **Quantize MIDI Event Lengths**
Cuts off the ends of selected MIDI events so that the events match the length quantize value. The start positions are kept.
- **Quantize MIDI Event Ends**
Moves the ends of MIDI events to the nearest grid positions.

- **Freeze MIDI Quantize**
Makes the start and end positions of MIDI events permanent. This function is useful in situations where you want to quantize a second time, based on the current quantized positions rather than the original positions.
- **Create Groove Quantize Preset**
Creates a groove quantize preset based on hitpoints that you have created in the **Sample Editor**.

Quantize Functions on the Project Window Toolbar and on the Sample Editor Toolbar

Apply Quantize



Applies the quantize settings.

Quantize Presets



Allows you to select a quantize preset.

Soft Quantize On/Off



Activates/Deactivates soft quantize.

Open Quantize Panel



Opens the **Quantize Panel**.

Quantizing MIDI Event Starts

You can quantize the MIDI event start positions.

PREREQUISITE

You have set up a quantize grid on the **Quantize Presets** pop-up menu on the **Project** window toolbar.

PROCEDURE

1. Perform one of the following actions:
 - In the **Key Editor**, select the MIDI events that you want to quantize.
 - In the **Project** window, select a MIDI part.
2. Select **Edit > Quantize**.

RESULT

The starts of the selected MIDI events or all events of the selected MIDI part are quantized. Events that do not match exact note positions are moved to the closest grid position. The note lengths are maintained.

Quantizing MIDI Event Lengths

You can quantize the MIDI event lengths.

PREREQUISITE

You have set up a length quantize value on the **Length Quantize** pop-up menu on the **Key Editor** toolbar.

PROCEDURE

1. Perform one of the following actions:
 - In the **Key Editor**, select the MIDI events that you want to quantize.
 - In the **Project** window, select a MIDI part.
 2. Select **Edit > Advanced Quantize > Quantize MIDI Event Lengths**.
-

RESULT

The ends of the selected MIDI events are cut off so that the events match the length quantize value. The start positions are kept.

NOTE

If you have selected **Quantize Link** in the **Length Quantize** pop-up menu of the **Key Editor** toolbar, the events are resized according to the grid that is set up in the **Quantize Presets** pop-up menu. The **Swing**, **Tuplet**, and **Catch Range** settings on the **Quantize Panel** are taken into account.

Quantizing MIDI Event Ends

You can quantize the MIDI event end positions.

PREREQUISITE

You have set up a quantize grid on the **Quantize Presets** pop-up menu on the **Project** window toolbar.

PROCEDURE

1. Perform one of the following actions:
 - In the **Key Editor**, select the MIDI events that you want to quantize.
 - In the **Project** window, select a MIDI part.
 2. Select **Edit > Advanced Quantize > Quantize MIDI Event Ends**.
-

RESULT

The ends of the MIDI events are moved to the nearest grid positions.

Quantizing Audio Event Starts

You can quantize the audio event start positions.

PREREQUISITE

You have set up a quantize grid on the **Quantize Presets** pop-up menu on the **Project** window toolbar.

PROCEDURE

1. In the **Project** window, select an audio event, a sliced loop, or an audio part.
 2. Select **Edit > Quantize**.
-

RESULT

The event snap point, or, if not available, the start of the audio event, is quantized. Event starts that do not match exact note positions are moved to the closest grid positions.

NOTE

If you use the **Quantize** function on an audio part, the starts of the events inside the part are quantized.

Quantize Panel

The **Quantize Panel** allows you to define how to quantize audio or MIDI to the grid or to a groove. Depending on what method you choose, different parameters are shown.

To open the **Quantize Panel**, perform one of the following actions:

- Click **Open Quantize Panel** on the toolbar.
- Select **Edit > Quantize Panel**.

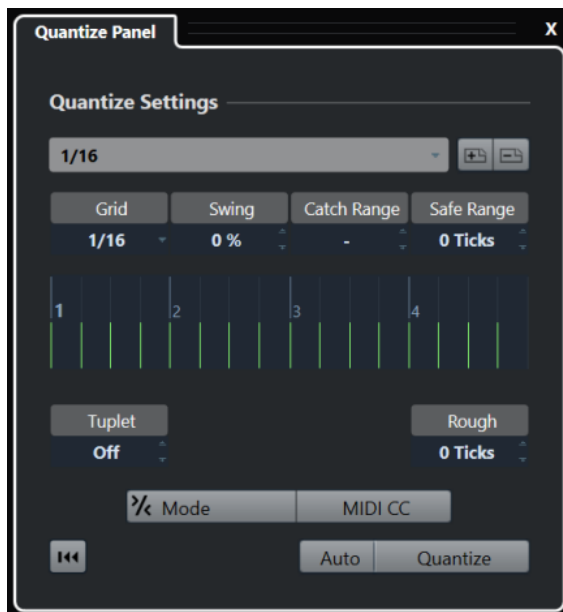

Quantize Presets

The quantize presets are displayed at the top of the **Quantize Panel**. Here, you can load and save presets that include all settings for quantizing.

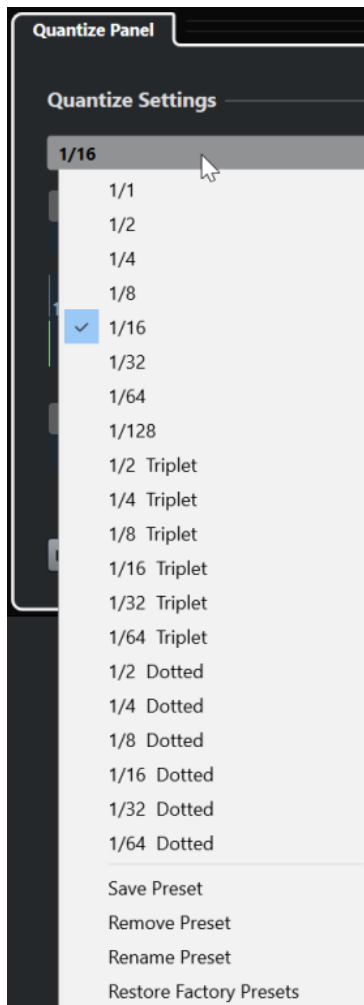

Select Preset

Allows you to select a preset.

Save Preset

Allows you to save the current settings as presets, so that they become available on all **Quantize Presets** pop-up menus.

Remove Preset

Allows you to remove the selected preset.

Rename Preset

Opens a dialog where you can rename the selected preset.

Restore Factory Presets

Allows you to restore the factory presets.

Creating Groove Quantize Presets

You can create a groove quantize preset, based on hitpoints that you have created in the **Sample Editor**.

PROCEDURE

1. In the **Project** window, double-click the audio event from which you want to extract the timing.
The **Sample Editor** opens.
2. Open the **Hitpoints** section.
The hitpoints for the audio event are automatically detected and displayed.
3. Open the **Create** section, and click **Groove**.
The groove is extracted.

RESULT

The groove is extracted from the audio event and made available in the **Quantize Presets** pop-up menu on the **Project** window toolbar.

AFTER COMPLETING THIS TASK

Open the **Quantize Panel**, and save the groove as a preset.

RELATED LINKS

- [Creating a Groove Quantize Preset](#) on page 405
- [Quantize Presets](#) on page 244

Options For Quantizing to a Musical Grid

You can use the musical grid to quantize your recorded music.

- To access the options for quantizing to a musical grid, select a musical time format from the **Select Preset** pop-up menu on the **Quantize Panel**.

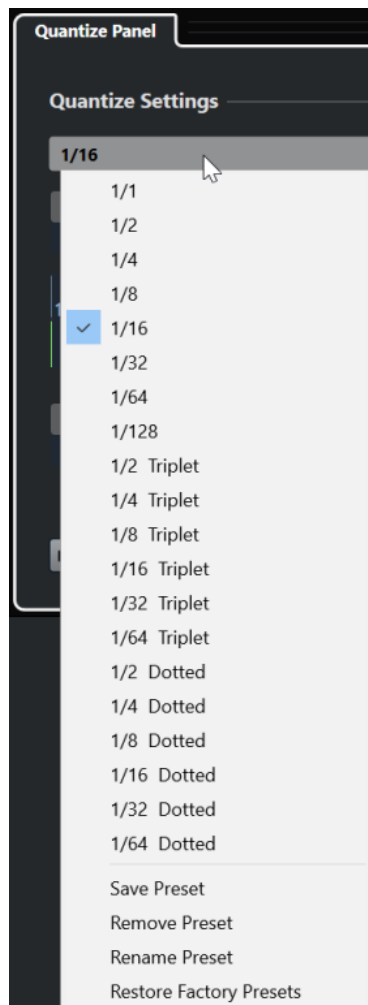

The following options are available:

Grid

Allows you to select the basic value for the quantize grid.

Swing

Offsets every second position in the grid, creating a swing or shuffle feel.

NOTE

Swing is only available if **Grid** is set to a straight value and **Tuplet** is deactivated.

Catch Range

Allows you to set a value that determines that quantizing only affects audio or MIDI within the set distance from the grid lines. This is reflected in the grid display.

Safe Range

Creates a safe zone before and after the quantize positions. If you specify a distance in ticks (120 ticks = one 16th note), events within this zone are not quantized. As a result, slight variations are kept.

Grid Display

Shows the quantize grid. Quantized audio or MIDI is moved to the positions indicated by the vertical grid lines.

Tuplet

Creates rhythmically more complex grids by dividing the grid into smaller steps, thereby creating n-tuplets.

Rough

Allows you to set a distance in ticks, so that your audio or MIDI is quantized to random positions within the specified distance from the quantize grid. This allows for slight variations and, at the same time, prevents your audio or MIDI from ending up too far away from the grid.

Soft Quantize Mode

Applies a loose quantization so that your audio or MIDI moves only part of the way to the closest quantize grid position. The **Quantize Strength** value to the right determines how close your audio or MIDI moves towards the grid.

NOTE

Soft quantizing is based on the current quantized positions and not on the original event positions. You can repeatedly use the soft quantize mode to gradually move your audio or MIDI closer to the quantize grid until you have found the right timing.

MIDI CC

Automatically moves controllers related to MIDI notes (pitchbend, etc.) with the notes when these are quantized.

Reset Quantize

Resets your audio or MIDI to its original, unquantized state.

IMPORTANT

This function has no effect on an event that was moved manually.

Auto

Immediately applies any changes to the selected parts or events. A way of using this feature is to set up a playback loop and to adjust the settings until you are satisfied with the result.

Quantize

Applies your settings.

Options for Quantizing to a Groove

You can generate a timing grid from a MIDI part or an audio loop and use this groove to quantize your recorded music. This way, you can recreate the rhythmic feel of this specific event or part.

To access the options for quantizing to a groove, select a MIDI part from an audio loop, an audio event with hitpoints, or sliced audio. Perform one of the following actions:

- Drag the part or event to the grid display in the middle of the **Quantize Panel**.
- Select **Edit > Advanced Quantize > Create Groove Quantize Preset**.

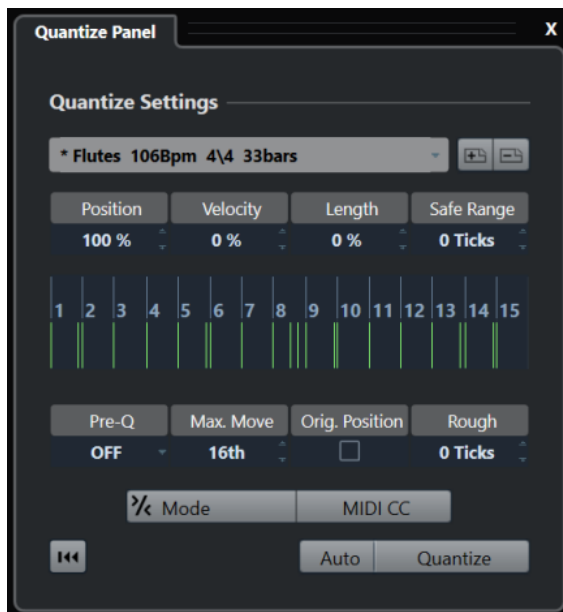

The following options become available:

Position

Determines how much the timing of the groove affects the music.

Velocity (MIDI Only)

Determines how much the velocity values within the groove affect the music.

NOTE

Not all grooves contain velocity information.

Length (MIDI Only)

Allows you to specify how much the lengths of the notes are affected by the groove.

NOTE

For drums, the **Length** setting is ignored.

Safe Range

Allows you to create a safe zone before and after the quantize positions. If you specify a distance in ticks (120 ticks = one 16th note), events within this zone are not quantized. As a result, slight variations are kept.

Grid display

Shows the quantize grid. Quantized audio or MIDI is moved to the positions indicated by the vertical grid lines.

Pre-Q

Allows you to select a musical grid to which you can quantize your audio or MIDI first. This moves the notes closer to their groove destination.

NOTE

If you apply a shuffle groove to a 16th-note pattern, for example, set up a pre-quantize value of 16 to straighten up the timing before applying the groove quantizing.

Max. Move

Allows you to select a note value to specify a maximum distance for audio or MIDI movement.

Orig. Position

Sets the original starting position of the quantized material as the starting point of the quantizing. This allows you to synchronize material that does not start from bar 1 of the project.

Rough Quantize

Allows you to set a distance in ticks so that your audio or MIDI is quantized to random positions within the specified distance from the quantize grid. This allows for slight variations and, at the same time, prevents your audio or MIDI from ending up too far away from the grid.

Soft Quantize Mode

Applies a loose quantization so that your audio or MIDI moves only part of the way to the closest quantize grid position. The **Quantize Strength** value to the right determines how close your audio or MIDI moves towards the grid.

NOTE

Soft quantizing is based on the current quantized positions and not on the original event positions. You can repeatedly use the soft quantize mode to gradually move your audio or MIDI closer to the quantize grid until you have found the right timing.

MIDI CC

Automatically moves controllers related to MIDI notes (pitchbend, etc.) with the notes when these are quantized.

Reset Quantize

Resets your audio or MIDI to its original, unquantized state.

IMPORTANT

This function has no effect on an event that was moved manually.

Auto

Immediately applies any changes to the selected parts or events. A way of using this feature is to set up a playback loop and to adjust the settings until you are satisfied with the result.

Quantize

Applies your settings.

RELATED LINKS

[Creating Groove Quantize Presets](#) on page 245

Fades and Crossfades

Fades allow you to gradually increase or decrease the volume at the start or at the end of audio events or audio clips, and to create smooth transitions.

You can create the following fades:

- Fade ins/fade outs

Fade ins and fade outs allow you to gradually increase or decrease the volume of audio events or audio clips. Fade ins and fade outs can be either event-based or clip-based.

Event-based fades are calculated in real time when you play back audio events. You can create different fade curves for several events, even if they refer to the same audio clip.

NOTE

The more event-based fades you apply, the more processing power is used.

Clip-based fades are applied to the audio clip. Events that refer to the same clip will have the same fades.

- Crossfades

Crossfades allow you to create smooth transitions for consecutive audio events on the same track. Crossfades are always event-based.

- Auto fades

Auto fades allow you to automatically apply short fade ins and fade outs to the events on specific audio tracks. You can also apply them globally on all audio tracks. This creates smooth transitions between events.

RELATED LINKS

[Event-Based Fades](#) on page 250

[Creating Clip-Based Fades](#) on page 254

[Crossfades](#) on page 255

[Auto Fades and Crossfades](#) on page 258

Event-Based Fades

You can create event-based fade ins and fade outs. These are calculated in real time when you play back audio events. You can create different fade curves for several events, even if they refer to the same audio clip.

There are several ways to create event-based fades:

- By using the event handles
- By using range selections

You can edit event-based fades in the **Fade** dialogs.

RELATED LINKS

[Creating and Editing Fades with the Handles](#) on page 251

[Creating and Editing Fades with the Range Selection Tool](#) on page 252

[Fade Dialog for Event-Based Fades](#) on page 252

Creating and Editing Fades with the Handles

You can create and edit event-based fade ins and fade outs using the event handles. This gives you a visual feedback and allows you to apply the same fade type to several selected events.

PROCEDURE

1. Select the audio events for which you want to create fades, and point at one of them with the mouse.

Triangular fade handles become visible in the upper left and right corners.

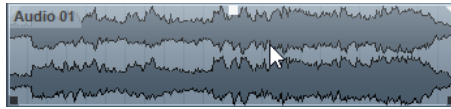

2. Perform one of the following actions:

- To create a fade in, drag the left fade handle to the right.

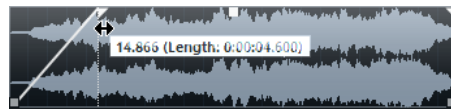

- To create a fade out, drag the right fade handle to the left.

RESULT

The fade is applied and displayed in the event waveform. If you select multiple events, the same fade is applied to all selected events.

NOTE

You can change the length of the fades at any time by dragging the handles.

Event Handles

Audio events have a fade-in and a fade-out handle, as well as a volume handle. These handles provide a quick way to change the fade length or the volume of events in the **Project** window.

Event handles become visible if you point the mouse at an event or if you select events.

NOTE

To show event handles and fade curves permanently, that is, not only when you point at events, activate **Show Event Volume Curves Always** in the **Preferences** dialog (**Event Display—Audio** page).

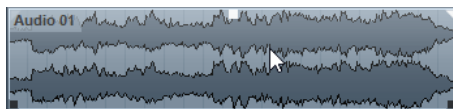

In the upper left and right corners, you find triangular fade handles that allow you to change the fade-in or fade-out length. The square handle at the top, in the middle, allows you to change the volume.

- To change the fade-in length, drag the fade handle in the upper left to the right or to the left.
- To change the fade-out length, drag the fade handle in the upper right to the left or to the right.
- To change the volume, drag the volume handle in the top middle up or down.

Fade and volume changes are reflected in the event waveform and on the info line.

NOTE

To change the event volume and the fades with the mouse wheel, activate **Use Mouse Wheel for Event Volume and Fades** in the **Preferences** dialog (**Editing—Audio** page). To move the fade in end point, press **Shift** while moving the mouse wheel, and position the mouse pointer somewhere in the left half of the event. When the mouse pointer is in the right half of the event, the fade out start point is moved.

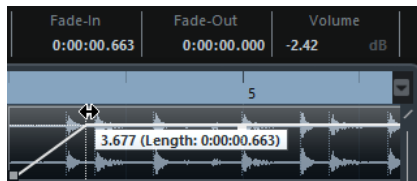

Creating and Editing Fades with the Range Selection Tool

You can create and edit event-based fades with the **Range Selection** tool. Using the **Range Selection** tool is useful if you want to create fades for multiple audio events on separate tracks.

PROCEDURE

1. On the **Project** window toolbar, select the **Range Selection** tool.

NOTE

If you select a range that spans multiple audio events on multiple audio tracks, you can create fades on multiple tracks.

2. Select a range in the middle of the event, and select **Audio > Fades > Adjust Fades to Range**.
-

Removing Event-Based Fades

You can remove event-based fades.

PROCEDURE

1. Select the event with the **Object Selection** tool.
 2. Do one of the following:
 - To remove a fade in, select **Audio > Fades > Remove Fade In**.
 - To remove a fade out, select **Audio > Fades > Remove Fade Out**.
 - To remove a fade in and a fade out, select **Audio > Fades > Remove Fades**.
-

Fade Dialog for Event-Based Fades

The fade dialog for event-based fades allows you to set up the selected event-based fades.

- To open the dialog for event-based fades, create a fade for one or more audio events, select the events, and select **Audio > Fades > Open Fade Editor(s)**.

NOTE

If you select several events, you can adjust the fade curves for all selected events at the same time. This is useful if you want to apply the same type of fade in to more than one event, for example.

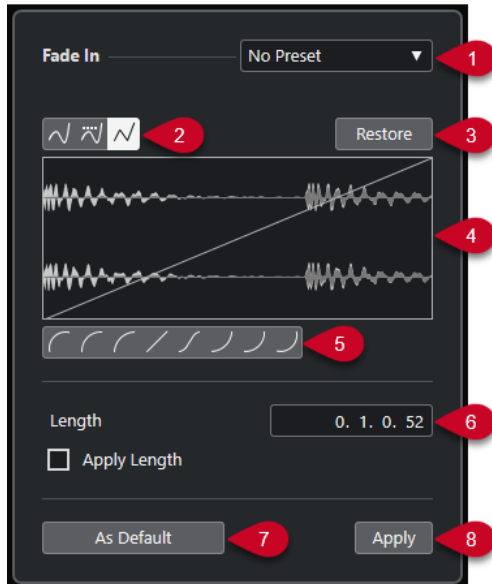

The following options are available:

1 Presets pop-up menu

Allows you to set up presets for fade-in or fade-out curves.

- To apply a saved preset, select it from the pop-up menu.
- To remove a saved preset, select it from the pop-up menu and click **Remove**.

2 Curve Type buttons

Apply a spline interpolation, a damped spline interpolation, or a linear interpolation to the curve.

3 Restore

Click this button to cancel any changes you have made since opening the dialog.

4 Fade display

Shows the shape of the fade curve. The darker waveform displays the result, whereas the current waveform is displayed in a lighter shade.

- To add points, click the curve.
- To change the curve shape, click and drag existing points.
- To remove a point from the curve, drag it outside the display.

5 Curve Shape buttons

Give you quick access to some common curve shapes.

6 Length field

Allows you to enter fade lengths numerically. The format of the values displayed here is determined by the time display on the **Transport** panel.

- If you activate **Apply Length**, the value entered in the **Fade Length** value field is used when clicking **Apply** or **OK**.

- If you set the current fade as the default fade, the length value is included as part of the default settings.

7 As Default

Saves the current settings as the default fade.

8 Apply

Applies the current fade settings to the selected events.

Creating Clip-Based Fades

You can create and edit clip-based fade ins and fade outs using **Direct Offline Processing**. These fades are applied to the audio clip. Events that refer to the same clip receive the same fades.

PROCEDURE

1. In the **Project** window, select one or more audio events or a range for which you want to create a fade.
The length of your selection determines the length of the fade area.
 2. Perform one of the following actions:
 - To create a fade in, select **Audio > Processes > Fade In**.
 - To create a fade out, select **Audio > Processes > Fade Out**.
 3. In the **Direct Offline Processing** window, click the **Curve Type** buttons to specify a fade curve, or click and drag with the mouse to draw in a curve in the curve display.
 4. Optional: Activate **Audition** to hear the effect of the specified fade on the selected audio event.
-

RESULT

The fade is applied to the audio.

RELATED LINKS

[Direct Offline Processing](#) on page 358

[Fade In/Fade Out](#) on page 364

[On Processing Shared Clips](#) on page 254

On Processing Shared Clips

If several events refer to the same audio clip, this clip is a shared clip. If you edit one of the events that refer to a shared clip, you can decide if you want to apply the processing to all events referring to this clip.

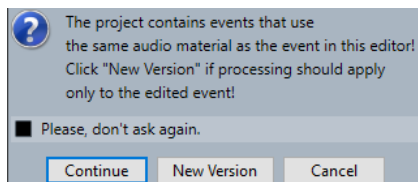

Continue

Click **Continue** to apply the processing to all events that refer to the audio clip.

New Version

Click **New Version** to create a separate, new version of the audio clip for the selected event.

Crossfades

Crossfades allow you to create smooth transitions for consecutive audio events on the same track. Crossfades are always event-based.

You can only create crossfades if the consecutive events or their respective clips overlap.

- If the audio events overlap, a crossfade of the default shape (linear, symmetric) is applied in the overlapping area.

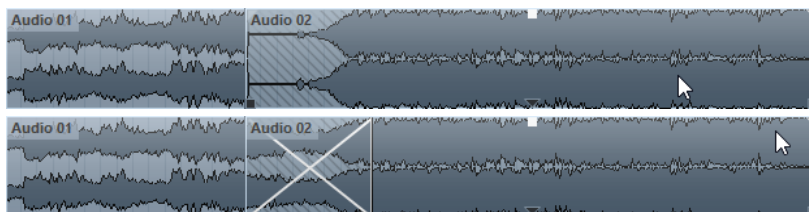

NOTE

You can edit the default crossfade length and shape in the **Crossfade** editor.

- If the respective audio clips overlap, the two events are resized so that they overlap, and a crossfade of the default length and shape is applied in the overlapping area.
- If neither the audio events nor the clips overlap, a crossfade cannot be created.

RELATED LINKS

[Crossfade Editor](#) on page 256

Creating Crossfades

You can create crossfades between two consecutive audio events.

PROCEDURE

1. Perform one of the following actions:
 - To create a crossfade between two events, select the **Object Selection** tool, and select two consecutive audio events.
 - To create a crossfade to a selected range between two events, select the **Range Selection** tool, and select a range covering the area where you want to apply a crossfade.
2. Select **Audio > Fades > Crossfade** or use the key command **X**.

RESULT

The crossfade is applied.

Changing the Crossfade Length

You can change the length of a crossfade.

PROCEDURE

1. Select the **Range Selection** tool.
2. Select a range between two events that covers the length of the crossfade you want to apply.
3. Select **Audio > Fades > Adjust Fades to Range**.

RESULT

The crossfade length is adjusted to the selected range.



Crossfade Editor

The **Crossfade** editor allows you to edit crossfades. It contains fade-in and fade-out curve settings, and common settings.

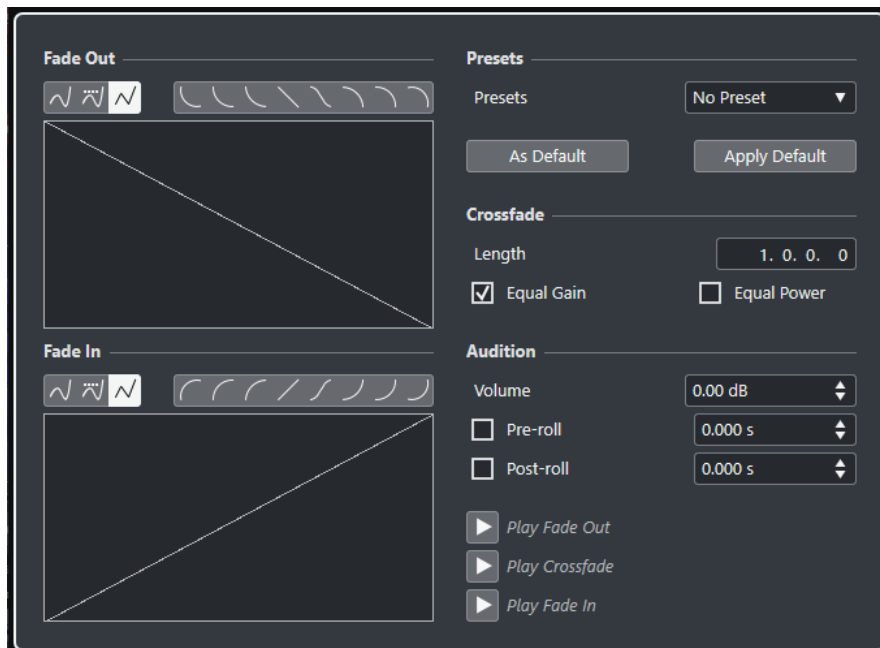
- To open the **Crossfade** editor, select one or both crossfaded events, and select **Audio > Fades > Crossfade** or double-click the crossfade zone.



Curve Type buttons

Determine whether the corresponding fade curve uses **Spline Interpolation** , **Damped Spline Interpolation** , or **Linear Interpolation** .

Curve Shape buttons

Give you quick access to some common curve shapes.



Fade Curve displays

Show the shape of the fade-out and fade-in curve, respectively.

- To add points, click a curve.
- To change the fade shape, click and drag existing points.
- To remove a point, drag a point outside the display.

Presets

Click **Save Preset** on the **Presets** pop-up menu to store the crossfade settings so that you can apply them to other events.

- To remove a preset, select it on the pop-up menu and click **Remove Preset**.

Default buttons

Click **As Default** to store the current settings as default. Default settings are used whenever you create new crossfades.

Click **Recall Default** to apply the curves and settings of the default crossfade.

Length

Specifies the length of the crossfade area. Cubase tries to center the crossfade, that is, the length change is applied equally to both sides. To be able to resize a crossfade, it must be possible to resize the corresponding event. For example, if the fade-out event already plays its audio clip to the end, its end point cannot be moved any further to the right.

Equal Gain

Adjusts the fade curves so that the summed fade-in and fade-out amplitudes are the same all along the crossfade region. This can be beneficial for short crossfades.

Equal Power

Adjusts the fade curves so that the energy (power) of the crossfade is constant all along the crossfade region.

Equal Power curves have only one editable curve point. You cannot change the curve shape if this mode is selected.

Volume

Allows you to set the audition level.

Pre-roll and Post-roll

- To start playback before the fade area, activate **Use Pre-roll**.
- To stop playback after the fade area, activate **Use Post-roll**.
- To adjust the pre-roll time, use the **Pre-roll Amount** value field.
- To adjust the post-roll time, use the **Post-roll Amount** value field.

Audition buttons

- To audition the fade-out part of the crossfade, click **Play Fade Out**.
- To audition the whole crossfade, click **Play Crossfade**.
- To audition the fade-in part of the crossfade, click **Play Fade In**.

You can set up key commands for this in the **Key Commands** dialog.

RELATED LINKS

[Key Commands](#) on page 801

[Event Handles](#) on page 251

[Auto-Scroll Settings Menu](#) on page 200

Removing Crossfades

You can remove crossfades.

PROCEDURE

1. Perform one of the following actions:
 - Select the **Object Selection** tool, and select one of the crossfaded events.
 - Select the **Range Selection** tool, and select the crossfades you want to remove.
2. Select **Audio > Fades > Remove Fades**.

RESULT

The selected crossfades are removed.

NOTE

You can also remove a crossfade by clicking and dragging it outside the event.

Auto Fades and Crossfades

Cubase features an **Auto Fade** function that can be set either globally or separately for each audio track. Auto fades allow you to create smoother transitions between events by applying fade ins and fade outs with a length between 1 and 500 ms.

IMPORTANT

As event-based fades are calculated in real time during playback, applying auto fades to a higher number of audio events results in a higher demand on the processor.

NOTE

Auto fades are not indicated by fade lines.

Auto Fades Dialog

The **Auto Fades** dialog allows you to set up auto fades and crossfades, either for the entire project or individually, for each audio track.

- To open the global **Auto Fades** dialog, select **Project > Auto Fades Settings**.
- To open the **Auto Fades** dialog for a track, right-click in the track list and select **Auto Fades Settings**.

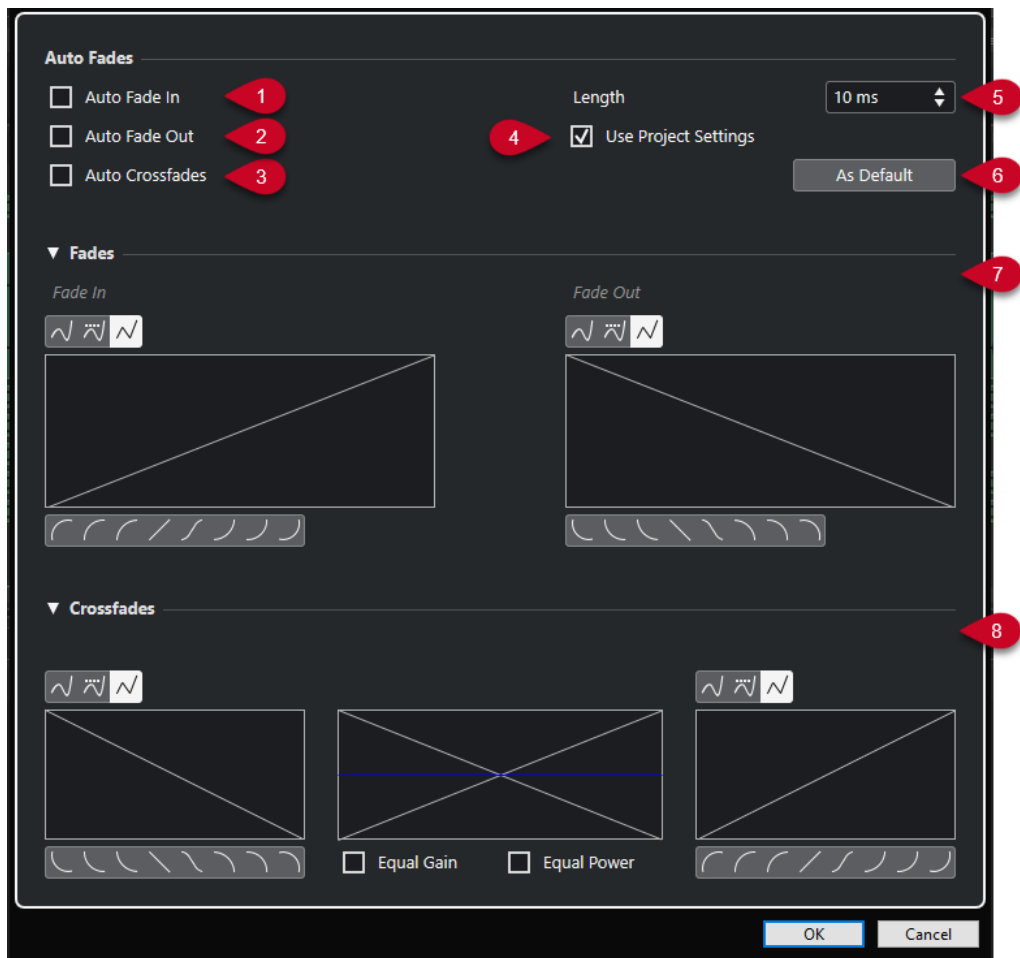

1 Auto Fade In

Activates auto fade ins.

2 Auto Fade Out

Activates auto fade outs.

3 Auto Crossfades

Activates auto crossfades.

4 Use Project Settings

This is only available if you opened the **Auto Fades** dialog for individual tracks. Deactivate this to set up and apply the settings to individual tracks only. To apply the global settings again, activate **Use Project Settings**.

5 Length

Specifies the length of the auto fades or crossfades.

6 As Default

Saves the current settings as default.

7 Fades section

Provides the settings for auto fades.

The **Curve Type** buttons allow you to determine whether the corresponding fade curve uses **Spline Interpolation** , **Damped Spline Interpolation**  or **Linear Interpolation** .

The **Curve Shape** buttons give you quick access to common curve shapes.

8 Crossfades section

Provides the settings for auto crossfades.

Equal Gain allows you to adjust the fade curves so that the summed fade-in and fade-out amplitudes are the same, all along the crossfade region.

Equal Power allows you to adjust the fade curves so that the energy (power) of the crossfade is constant, all along the crossfade region.

Making Global Auto Fade Settings

You can set up auto fades and crossfades for the whole project.

PROCEDURE

1. Select **Project > Auto Fades Settings**.
This opens the **Auto Fades** dialog for the project.
 2. Set up the fades as desired.
 3. Click **OK**.
-

RELATED LINKS

[Fade Dialog for Event-Based Fades](#) on page 252

[Crossfade Editor](#) on page 256

Making Auto Fade Settings for Individual Tracks

As auto fades use computing power, we recommend turning global auto fades off and activating them for individual tracks only.

PROCEDURE

1. Perform one of the following actions:
 - Right-click the track in the track list. From the context menu, select **Auto Fades Settings**.
 - Select the track. In the **Inspector**, click **Auto Fades Settings**.The **Auto Fades** dialog for the track opens.
 2. Deactivate **Use Project Settings**.
Any settings you make are applied to the track only.
 3. Set up the auto fades.
 4. Click **OK**.
-

Arranger Track

The arranger functions in Cubase allow you to work in a non-linear fashion. Using an arranger track allows you to specify how and when specific sections are played back, even for live performances. This way, you do not need to move, copy, and paste events in the **Project** window.

NOTE

There can only be one arranger track in a project.

To use the arranger functions, add an arranger track and define arranger events. Arranger events can be of any length. They can overlap and are not bound to the start or end of existing events and parts. You can order them in a list and add repeats as desired.

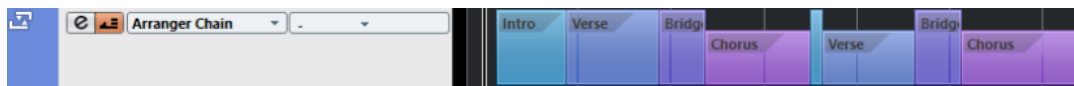

To edit arranger events, use the standard techniques. Copies from arranger events are independent from the original event.

You can create several arranger chains that allow you to save different versions of a song within the project.

You can flatten arranger chains to convert them into a linear project.

RELATED LINKS

[Adding Arranger Events on the Arranger Track](#) on page 261

[Setting up an Arranger Chain and Adding Events](#) on page 265

[Flattening the Arranger Chain](#) on page 267

Adding Arranger Events on the Arranger Track

On the arranger track, you can add arranger events that define specific sections of the project.

PREREQUISITE

Snap is activated, and **Snap Type** is set to **Events**.

PROCEDURE

1. Select **Project > Add Track > Arranger**.
The arranger track is added.
2. Select the **Draw** tool, and draw an arranger event on the arranger track.
An arranger event is added.
3. Draw as many events as you need.

RESULT

The arranger events are added to your project.

AFTER COMPLETING THIS TASK

Use the functions of the **Arranger Editor** to arrange the events.

RELATED LINKS

[Arranger Track](#) on page 129

[Setting up an Arranger Chain and Adding Events](#) on page 265

[Snap Function](#) on page 68

[Snap Types Menu](#) on page 68

Renaming Arranger Events

When you add arranger events, they are automatically named in alphabetical order. You can change the names so that they reflect the structure of your project, such as Intro, Chorus, Bridge, for example.

PROCEDURE

1. Select the arranger event that you want to rename.
 2. Perform one of the following actions:
 - Select the event name on the info line.
 - Hold down **Alt/Opt**, and double-click the name in the arranger chain.
 3. Enter a new name.
-

Arranger Editor

The **Arranger Editor** allows you to set up arranger chains.

- To open the **Arranger Editor**, select an arranger track, and click **Open Arranger Editor** in the track list.

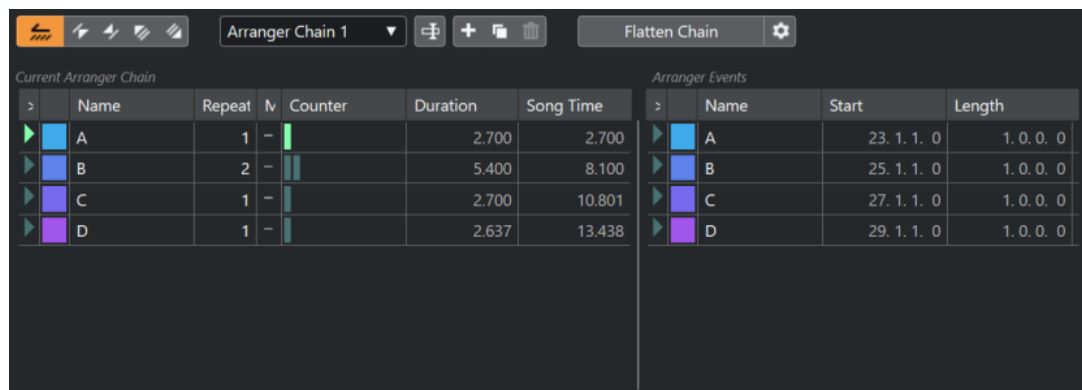

Arranger toolbar

Shows the transport buttons, the arranger transport buttons, and the arranger tools.

Current Arranger Chain

Shows the order in which the events are played back, from top to bottom, and how many times they are repeated.

NOTE

Initially, the arranger chain is empty. To use it, add events from the **Arranger Events** list.

Arranger Events

Lists the available arranger events in the same order as they appear on the timeline.

Arranger Editor Toolbar

The **Arranger Editor** contains tools and shortcuts for setting the flatten options.

- To open the **Arranger Editor**, select an arranger track, and click **Open Arranger Editor**  in the track list.

Activate Arranger Mode



Activates playback in arranger mode.

Previous Chain Step



Navigates to the previous entry in the current arranger chain list.

Next Chain Step



Navigates to the next entry in the current arranger chain list.

First Repeat of Current Chain Step



Navigates to the first repeat of the current entry in the current arranger chain list.

Last Repeat of Current Chain Step



Navigates to the last repeat of the current entry in the current arranger chain list.

Select Active Chain

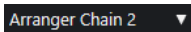

Allows you to select and activate an arranger chain.

Rename Current Chain



Allows you to rename the current arranger chain.

Create New Chain



Creates a new, empty arranger chain.

Duplicate Current Chain



Creates a duplicate of the current arranger chain, containing the same events.

Remove Current Chain



Removes the selected arranger chain. This is only available if you have created more than one arranger chain.

Flatten Chain

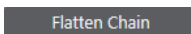

Converts the current arranger chain into a linear project.

Flatten (with Options & Preferences)



Allows you to set up the flatten options.

Arranger Chain Repeat Modes

The **Arranger Editor** features a function that allows you to repeat and loop your arranger events. This way, you can create a sketch of a song structure.

- To open the **Arranger Editor**, select an arranger track, and click **Open Arranger Editor** in the track list.

To select one of the repeat modes, click the **Mode** column in the **Current Arranger Chain** list.

1 Normal

Plays back the arranger chain exactly the way you set it up.

2 Repeat Forever

Repeats the current arranger event in a loop until you click another event in the **Arranger Editor** or until you click **Play** once again.

3 Pause After Repeats

Pauses playback after all repeats of the current arranger event have been played back.

NOTE

During playback, the **Counter** column indicates which repetition of the event is playing.

Flatten Options & Preferences

The flatten options allow you to define what happens when you flatten the arranger track.

- To show the flatten options, open the **Arranger Editor**, and click **Flatten (with Options & Preferences)**.

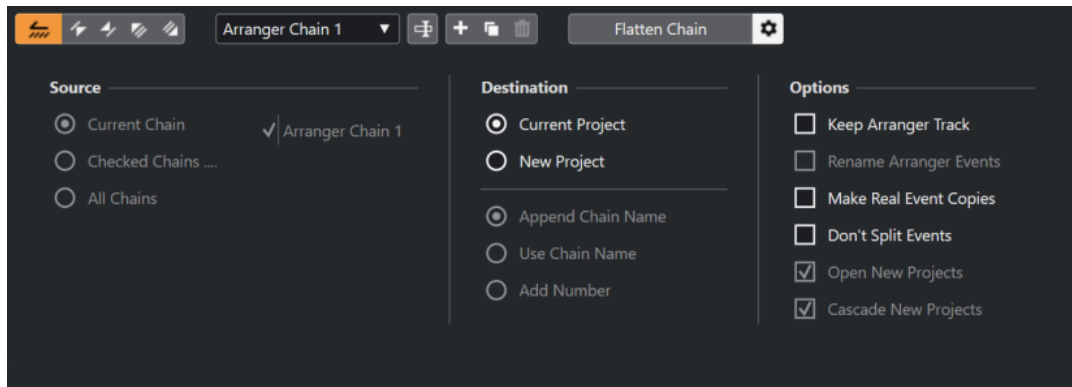

In the **Source** section, you can specify which arranger chains are flattened.

Current Chain

Flattens the current chain only.

Checked Chains

Opens a list of the available arranger chains where you can activate the arranger tracks that you want to flatten.

All Chains

Flattens all arranger chains of the current project.

The **Destination** section allows you to choose where the result of the flattening is saved.

Current Project

This is only available if **Source** is set to **Current Chain**. Activate this option to save the flattened chain in the current project.

New Project

Allows you to flatten one or more chains in a new project with the following naming options:

- **Append Chain Name**
Appends the chain names to the project name.
- **Use Chain Name**
Names the new projects after the current arranger chains.
- **Add Number**
Names the new projects after the old ones and adds a number.

The **Options** section contains further settings.

Keep Arranger Track

Keeps the arranger track after flattening. Activate **Rename Arranger Events** to append numbers to the events.

Make Real Event Copies

Allows you to create real copies of the arranger track instead of shared copies.

Don't Split Events

Excludes MIDI notes that start before or are longer than the arranger event. Only MIDI notes that begin and end inside the arranger event are taken into account.

Open New Projects

Creates a new project for every flattened arranger chain. If you activate **Cascade New Projects**, the opened projects are cascaded.

RELATED LINKS

[Flattening the Arranger Chain](#) on page 267

Setting up an Arranger Chain and Adding Events

In the **Arranger Editor**, you can set up arranger chains and add events to them.

PROCEDURE

1. Click **e** to open the **Arranger Editor**.
2. Activate **Activate Arranger Mode**.

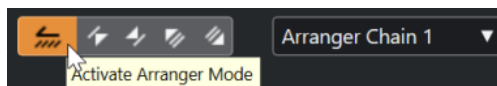

3. Perform one of the following actions to add arranger events to the arranger chain:
 - Double-click an event in the **Arranger Events** list.
 - Select one or more events in the **Arranger Events** list, right-click, and select **Append Selected In Arranger Chain**.
 - Drag an arranger event from the **Arranger Events** list, and drop it in the **Current Arranger Chain** list.

- Drag an arranger event from the **Project** window, and drop it in the **Current Arranger Chain** list.

4. Click **Play**.

RESULT

The arranger events are played back in the order that you specified in the arranger chain.

RELATED LINKS

[Arranger Chain Repeat Modes](#) on page 264

Adding a New Arranger Chain

You can create several arranger chains in order to set up alternative versions for playback.

PREREQUISITE

Arranger Mode is activated.

PROCEDURE

1. Open the **Arranger Editor**.
 2. Click **Create New Chain**.
-

RESULT

A new, empty arranger chain is activated. This is reflected by a new name in the **Select Active Chain** pop-up menu and a new, empty **Current Arranger Chain** list.

Editing Arranger Events in the Arranger Chain

In the **Current Arranger Chain** list, you can edit your arranger events.

You can perform the following actions:

- To select multiple events, **Ctrl/Cmd**-click or **Shift**-click them.
- To move events in the list, drag them up or down.
- To copy events, select them, hold **Alt/Opt** and drag.
- To repeat events, click in the **Repeats** column, and enter the number of repeats.
- To specify how the event is repeated, click in the **Mode** column, and select a **Repeat Mode** from the pop-up menu.
- To move the playback position to the start of an event, click the arrow to the left of the event.
- To remove an event from the list, right-click, and, from the context menu, select **Remove Touched**.
- To remove several events, select them, right-click, and, from the context menu, select **Remove Selected**.

RELATED LINKS

[Arranger Chain Repeat Modes](#) on page 264

Flattening the Arranger Chain

When you have set up an arranger chain that you like, and you are sure that you do not want to edit it any more, you can convert it into a linear project.

PREREQUISITE

You have saved a copy of the project before flattening the arranger chain.

NOTE

Flattening the arranger chain may remove events and parts from the project. Only use **Flatten** when you are sure that you do not want to edit the arranger track/chain any more. If in doubt, save a copy of the project before flattening the arranger chain.

PROCEDURE

1. Select the arranger chain that you want to convert into a linear project.
2. Optional: Click **Flatten (with Options & Preferences)**.

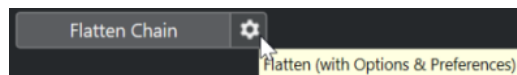

3. Optional: Activate the desired flattening options.

NOTE

If you realize that you want to do further adjustments, click **Go Back**. The activated flatten options are kept.

4. Click **Flatten**.
-

RESULT

The events and parts in the project are reordered, repeated, resized, moved and/or deleted, so that they correspond exactly to the arranger chain.

Jump Mode

If you have set up an arranger track and play it back, you have live access to the playback order. This way, you can loop your arranger events with more flexibility regarding the length of the playback.

PREREQUISITE

An arranger chain is set up, and the arranger mode is activated.

PROCEDURE

1. Play back your project.
2. In the lower part of the **Inspector**, open the **Jump Mode** pop-up menu, and select an option from the pop-up menu.

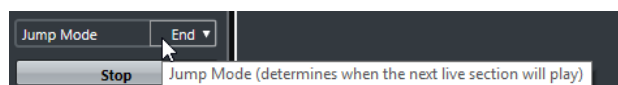

This determines how long the active arranger event is played before jumping to the next one.

3. In the **Arranger Events** list of the **Inspector**, click the arrow to the left of the arranger event that you want to trigger.
-

RESULT

The arranger event is looped according to your settings, until you click another arranger event.

NOTE

You can assign key commands to trigger arranger events in the **Arranger** category of the **Key Commands** dialog.

AFTER COMPLETING THIS TASK

- To stop **Jump Mode**, click **Stop**.
- To continue playback from a specific arranger event, click the arranger event in the **Current Arranger Chain** list.

RELATED LINKS

[Jump Mode Options](#) on page 268

Jump Mode Options

The **Jump Mode** pop-up menu allows you to define how long the active arranger event is played before jumping to the next one.

- To show the **Inspector** for the arranger track, select the arranger track in the track list.

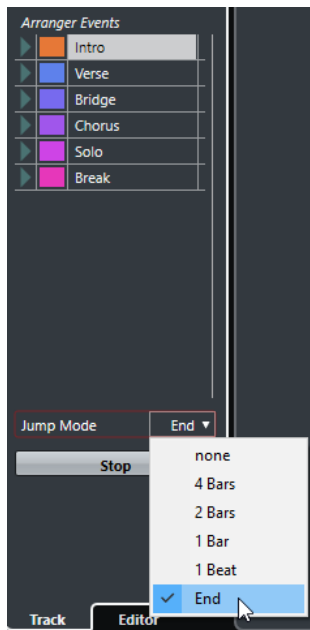

The following options are available:

None

Jumps to the next section immediately.

4 Bars, 2 Bars

Jumps to the next arranger event after 2 or 4 bars. If the current arranger event is shorter than 2 or 4 bars, playback jumps to the next arranger event at the end of the event.

1 Bar

Jumps to the next section at the next barline.

1 Beat

Jumps to the next section at the next beat.

End

Plays the current section to the end, then jumps to the next section.

Arranging Music to Video

When you compose music for video, you can use arranger events to fill a specific video section with music.

PREREQUISITE

You have connected and set up an external sync master device to your computer. You have created a new, empty project and added a MIDI track.

NOTE

The following values and settings are just meant as an example.

PROCEDURE

1. Create a MIDI part that starts at position 00:00:00:00 and ends at position 00:01:00:00.
 2. Create a MIDI part that starts at position 00:01:00:00 and ends at position 00:02:00:00.
 3. Create a MIDI part that starts at position 00:02:00:00 and ends at position 00:03:00:00.
 4. On the **Transport** panel, activate **Sync**.
 5. Select **Project > Add Track > Arranger**.
The arranger track is added.
 6. On the arranger track, add arranger events at the positions of the MIDI parts.
 7. Set up the arranger chain A-A-B-B-C-C.
 8. Activate **Arranger** mode and start playback.
 9. On your external sync master device, start the external timecode at position 00:00:10:00.
In your project, the position 00:00:10:00 is located, and arranger part A is played back.
 10. Start your external sync master device at a position that does not match the project start time, for example, 00:01:10:00.
In your project, the position 00:01:10:00 is located, and arranger part A is played back.
-

RESULT

If you position the external sync master device to a position that does not match the project start time, Cubase automatically jumps to the right position in the arranger track.

NOTE

The reference for the external timecode can be MIDI or any other timecode that can be interpreted by Cubase.

RELATED LINKS

[Arranger Track](#) on page 129

Markers

Markers are used to locate certain positions quickly. There are two types of markers: position markers and cycle markers.

If you often find yourself jumping to a specific position within a project, you should insert a marker at this position. You can also use markers to make range selections or for zooming.

Markers are located on the marker track. You can add 1 marker track.

Vertical marker lines are shown in the **Project** window to indicate marker positions on all tracks throughout the entire project.

NOTE

- Marker lines are shown behind other events on other tracks. If you need a more pronounced indication of the lines, consider lowering the **Event Opacity** in the **Preferences** dialog (**Event Display** page).

RELATED LINKS

[Position Markers](#) on page 270

[Cycle Markers](#) on page 270

[Marker Track](#) on page 275

[Event Opacity](#) on page 835

Position Markers

Position markers allow you to save a specific position.

Position markers on the marker track are shown as marker events: vertical lines with the marker description (if assigned) and number beside it. If you select a marker track, all of its markers are shown in the **Inspector**.

Cycle Markers

By creating cycle markers, you can save any number of left and right locator positions as start and end positions of a range and recall them by double-clicking on the corresponding marker.

Cycle markers are shown on a marker track as two markers bridged by a horizontal line. Cycle markers are ideal for saving sections of a project.

By defining cycle markers for the intro, verse, and chorus of a song, for example, you can quickly navigate to the song sections and repeat the section by activating **Activate Cycle** on the **Transport** panel.

Setting the Locators Using Cycle Markers

Cycle markers represent ranges in your project. You can use them for moving the left and right locators.

PROCEDURE

- To set the left locator to the cycle marker start and the right locator to the cycle marker end, perform one of the following actions:
 - Double-click on a cycle marker.
 - Select a cycle marker from the **Cycle** pop-up menu in the track list.

RESULT

The left and right locators are moved to encompass the cycle marker.

AFTER COMPLETING THIS TASK

Now you can move the project cursor position to the start or the end of the cycle marker by moving it to the corresponding locator or use cycle markers to export specific ranges of your project with the **Export Audio Mixdown** dialog.

Editing Cycle Markers

When editing cycle markers on a marker track, snap is taken into account.

- To add a cycle marker, press **Ctrl/Cmd**, click and drag on the marker track.
- To change the start/end position of a cycle marker, drag the start/end handle.
- To move a cycle marker to another position, drag the upper border.
- To delete a cycle marker, click with the **Erase** tool.
If you hold down **Alt/Opt** when you click, all consecutive markers are deleted.
- To cut a range in a cycle marker, select a range in the cycle marker, and press **Ctrl/Cmd - X**.
- To set the marker start/end of the selected cycle marker to the cursor position, select **Project > Markers** to open the **Markers** window, and select **Functions > Set Marker Start/End to Cursor**.
- To set the left and right locators, double-click a cycle marker.
- To zoom in on a cycle marker, press **Alt/Opt**, and double-click the cycle marker.

Markers Window

In the **Markers** window, you can view and edit markers.

To open the **Markers** window, you have the following possibilities:

- Select **Project > Markers**.
- On the **Transport** panel in the marker section, click **Open Markers Window**.
- Use a key command (by default **Ctrl/Cmd - M**).

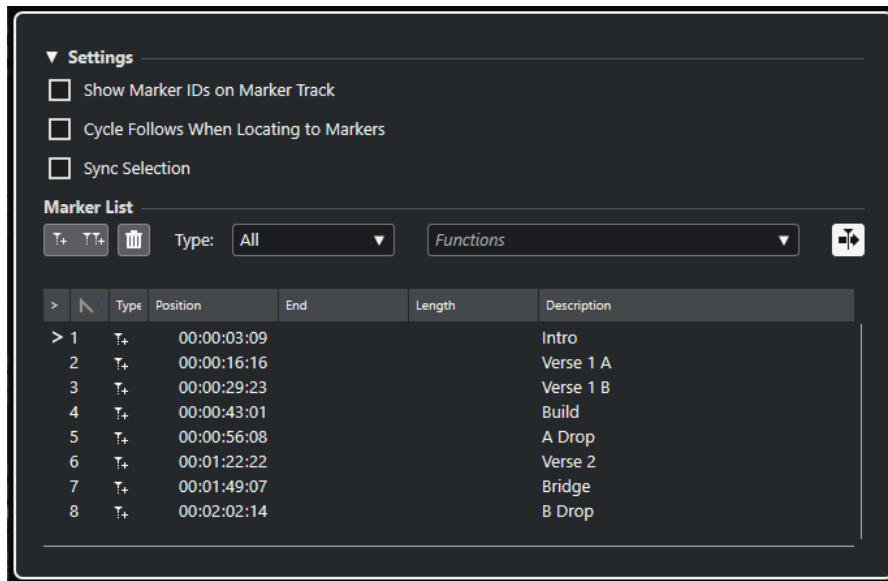

Settings Section

Show Marker IDs on Marker Track

If this option is activated, the marker IDs are shown on marker track events.

Cycle Follows When Locating to Markers

This automatically sets the left and right locators to a position or cycle marker when locating to this marker. This is useful if you need to set the locators on the fly during recording for Punch In/Punch Out, for example.

Sync Selection

If this option is activated, the selection in the **Markers** window is linked to the selection in the **Project** window.

IMPORTANT

This option is automatically deactivated when a recording is started. You can activate it again after stopping the recording.

Marker List Section

Add Position Marker

Adds a position marker at the cursor position.

Add Cycle Marker

Adds a cycle marker at the cursor position.

Remove Marker

Removes the marker that is selected in the marker list.

Functions pop-up menu

Allows you to move selected markers on the project timeline and to reassign the marker IDs of all position or cycle markers in the marker list.

- **Move Markers to Cursor** moves position markers or start positions of cycle markers to the cursor position.
- **Reassign Position Marker IDs** reassigns the IDs for all position markers on the active marker track to match the order of markers on the track.

- **Reassign Cycle Marker IDs** reassigns the IDs for all cycle markers on the active marker track to match the order of markers on the track.

Auto-Scroll with Project Cursor

Allows you to keep track of the locate arrow, even if your project contains a high number of markers. If this option is activated, the **Markers** window is automatically scrolled to keep the locate arrow visible.

List of markers

Lists the markers of the selected track.

Editing in the Markers Window

In the **Markers** window, you can select, edit, add, move, and remove markers.

- To select or edit a marker, click on it.
Select multiple markers by **Shift**- or **Ctrl/Cmd**-clicking them.
- To add a position marker at the cursor position, click **Add Position Marker**.
A position marker is added at the current project cursor position on the marker track.
- To add a cycle marker at the cursor position, click **Add Cycle Marker**.
This adds a cycle marker between the left and right locators on the marker track.
- To move position markers or the start of cycle markers to the cursor position, select the markers. From the **Functions** pop-up menu, select **Move Markers to Cursor**. For cycle markers, this operation moves the end of the marker accordingly.

NOTE

Alternatively, you can enter the new position numerically in the **Position** column.

- To remove markers, select them, and click **Remove Marker**.

RELATED LINKS

[Markers Window](#) on page 271

Navigating in the Marker List

You can navigate in the marker list using your computer keyboard, and you can select entries by pressing **Return**. This is a quick and easy way to jump to markers during playback or recording.

- To move to the previous/next marker in the list, press the **Up Arrow / Down Arrow** keys.
- To jump to the first/last marker, press the **Home / End** keys.
- To move up/down a page in the list, press the **Page Up / Page Down** keys.

Sorting and Reordering the Marker List

You can customize the display of the marker attributes in the marker list by sorting or reordering the columns.

- To sort the marker list by a specific attribute, click on the corresponding column header.
- To reorder the marker attributes, drag and drop the corresponding column headers.
- To adjust the width of a column, place the mouse pointer between two column headers, and drag left or right.

NOTE

Regardless of what attributes you sort by, the second sort criterion will always be the position attribute.

Marker Attributes

Marker attributes are shown in the marker list of the **Markers** window.

- To open the **Markers** window, select **Project > Markers**.

The following attribute columns are available:

Locate



An arrow indicates which marker is at the project cursor position (or closest to the project cursor). If you click in this column, the project cursor is moved to the corresponding marker position. This column cannot be hidden.

ID

Shows the marker ID numbers.

Type

Indicates whether a marker is a position marker or a cycle marker.

Position

Allows you to view and edit the time positions for position markers and the start positions for cycle markers. This column cannot be hidden.

End

Allows you to view and edit the end positions of cycle markers.

Length

Allows you to view and edit the length of cycle markers.

Description

Allows you to view and edit marker descriptions.

RELATED LINKS

[Marker IDs](#) on page 275

[Cycle Markers](#) on page 270

Editing Attributes

You can edit marker attributes in the **Markers** window or on the info line.

To edit marker attributes in the **Markers** window, proceed as follows:

- To edit a marker attribute, select the corresponding marker, click in the desired attribute column, and make your changes.
- To change the attributes of several markers, select the markers, and activate the checkbox for the attribute.

All selected markers change their attributes accordingly. Note that this does not work when clicking on a timecode value or a text field.

NOTE

To navigate in the list of marker attributes, you can also use the **Tab** key and the **Up Arrow**, **Down Arrow**, **Left Arrow**, and **Right Arrow** keys.

To edit a marker attribute on the info line, select the marker in the **Project** window, and click the corresponding attribute field on the info line.

NOTE

To choose which marker attributes are displayed on the info line, click **Set up Info Line** to the right of the info line.

RELATED LINKS

[Info Line](#) on page 46

Marker IDs

Each position or cycle marker on a marker track has its own marker ID.

When you add a position marker, it is automatically and sequentially assigned an ID number, starting from **1**. IDs for cycle markers are shown in brackets and start from **1**.

You can change ID numbers at any time, which allows you to assign specific markers to key commands.

You can also automatically reassign the IDs for all position or cycle markers to match the order of markers on a track. To do so, select the corresponding function from the **Functions** pop-up menu.

RELATED LINKS

[Reassigning Marker IDs](#) on page 275

Reassigning Marker IDs

Sometimes, especially when setting markers on the fly, you may forget or miss to set a marker. When added later, the ID of this marker does not correspond to its position on the marker track. Therefore, it is possible to reassign the IDs for all markers on a track.

PROCEDURE

1. Open the **Markers** window.
 2. From the **Functions** pop-up menu, select either **Reassign Position Marker IDs** or **Reassign Cycle Marker IDs**.
-

RESULT

The marker IDs of the selected type are reassigned to match the order of markers on the marker track.

Marker Track

A marker track is used for adding and editing markers.

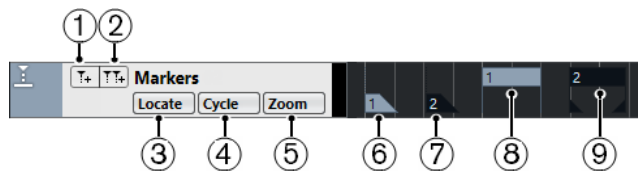

1 Add Position Marker

Adds a position marker at the cursor position.

2 Add Cycle Marker

Adds a cycle marker at the cursor position.

3 Locate pop-up menu

If you select a position or a cycle marker in this pop-up menu, the corresponding marker in the event display or in the **Markers** window is selected.

4 Cycle pop-up menu

If you select a cycle marker in this pop-up menu, the left and right locators are set to the corresponding cycle marker.

5 Zoom pop-up menu

If you select a cycle marker in this pop-up menu, the view zooms to the corresponding cycle marker.

6 Marker event (inactive)

Shows an inactive marker event.

7 Marker event (active)

Shows an active marker event.

8 Cycle marker event (inactive)

Shows an inactive cycle marker event.

9 Cycle marker event (active)

Shows an active cycle marker event.

Adding, Moving, and Removing the Marker Track

You can add, move, and remove the marker track.

- To add a marker track to the project, select **Project > Add Track > Marker**.
- To move a marker track to another position in the track list, click and drag it up or down.
- To remove the marker track, right-click it in the track list and select **Remove Selected Tracks**.
- To remove an empty marker track, select **Project > Remove Empty Tracks**. This also removes any other tracks that are empty.

Editing Markers on the Marker Track

You can edit markers on the marker track.

- To add a position marker, click **Add Position Marker** or use the **Draw** tool.
- To add a cycle marker, click **Add Cycle Marker** or use the **Draw** tool.
- To select a marker, use the standard techniques.
- To resize a cycle marker, select it, and drag the handles. You can also do this numerically on the info line.

- To move a marker, select it and drag it. You can also edit marker positions on the info line.
- To remove a marker, select it, and press **Delete** or use the **Erase** tool.

RELATED LINKS

[Marker Track](#) on page 275

Using Markers to Select Ranges

Markers can be used in conjunction with the **Range Selection** tool to make range selections in the **Project** window. This is useful if you quickly want to make a selection that spans all tracks in the project.

PROCEDURE

1. Set markers at the start and at the end of the section that you want to move or copy.
 2. Select the **Range Selection** tool, and double-click on the marker track between the markers. Everything in the project within the marker boundaries is selected. Any function or processing you perform now affects the selection only.
 3. Click on the marker track in the selected range, and drag the range to a new position. If you hold down **Alt/Opt** while you drag the range, the selection in the **Project** window is copied instead.
-

Importing and Exporting Markers

Markers and marker tracks can be imported and exported.

The following files can contain markers:

- MIDI files

RELATED LINKS

[Importing Markers via MIDI](#) on page 277

[Exporting Markers via MIDI](#) on page 278

Importing Markers via MIDI

You can import position markers by importing MIDI files that contain markers. This is useful if you want to use your marker tracks in other projects or if you want to share them with other Cubase users. Any markers you have added are included in the MIDI file as standard MIDI file marker events.

- Activate **Import Markers** in the **Preferences** dialog (**MIDI—MIDI File** page).

The following settings are imported:

- The start position of position markers and cycle markers

RELATED LINKS

[Importing MIDI Files](#) on page 239

Exporting Markers via MIDI

You can export your markers as part of a MIDI file.

- To include any markers in the MIDI file, activate **Export Markers** in the **Export Options** dialog.

The following settings are exported:

- The start position of position markers and cycle markers

NOTE

To export markers via MIDI export, your project must contain a marker track.

RELATED LINKS

[Exporting MIDI Tracks as Standard MIDI Files](#) on page 137

MixConsole

The **MixConsole** provides a common environment for producing mixes in stereo. It allows you to control level, pan, solo/mute status, etc. for audio and MIDI channels. Furthermore, you can set up the input and output routing for multiple tracks or channels at the same time.

You can open the **MixConsole** in a separate window or in the lower zone of the **Project** window.

While the **MixConsole** in the lower zone of the **Project** window features the key functions for mixing, the separate **MixConsole** window gives you access to additional functions and settings.

RELATED LINKS

[MixConsole in Lower Zone](#) on page 279

[MixConsole Window](#) on page 280

MixConsole in Lower Zone

You can show a **MixConsole** in the lower zone of the **Project** window. This is useful if you want to access the most important **MixConsole** functions from within a fixed zone of the **Project** window. The **MixConsole** in the lower zone of the **Project** window is a separate **MixConsole** that does not follow any visibility changes you perform in the **MixConsole** window.

To open a **MixConsole** in the lower zone of the **Project** window, do one of the following:

- Press **Alt/Opt - F3**.
- Select **Studio > MixConsole in Project Window**.

The **MixConsole** in the lower zone of the **Project** window is divided into the following sections:

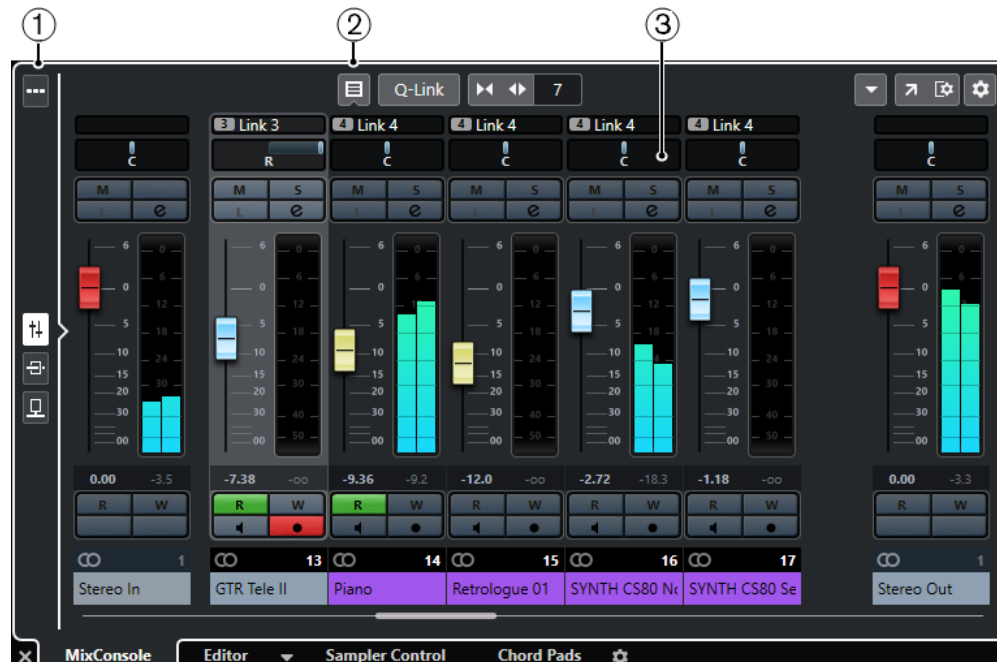

1 Page selector

Allows you to select what page is displayed in the fader section: the channel faders, the insert effects for a channel, or the send effects. The top button allows you to show/hide the toolbar.

2 Toolbar

The toolbar shows tools and shortcuts for settings and functions in the **MixConsole**.

3 Fader section

The fader section is always visible and shows all channels in the same order as in the track list.

RELATED LINKS

[Fader Section](#) on page 293

[Inserts](#) on page 302

[Sends](#) on page 312

[Filtering Channel Types](#) on page 288

[Linking Channels](#) on page 291

[Functions Menu](#) on page 291

MixConsole Window

You can open the **MixConsole** in a separate window.

To open the **MixConsole**, do one of the following:

- Press **F3**.
- Select **Studio > MixConsole**.
- On the **Project** window toolbar, click **Open MixConsole**.

NOTE

This is only visible on the toolbar if the **Media & MixConsole Windows** section is activated.

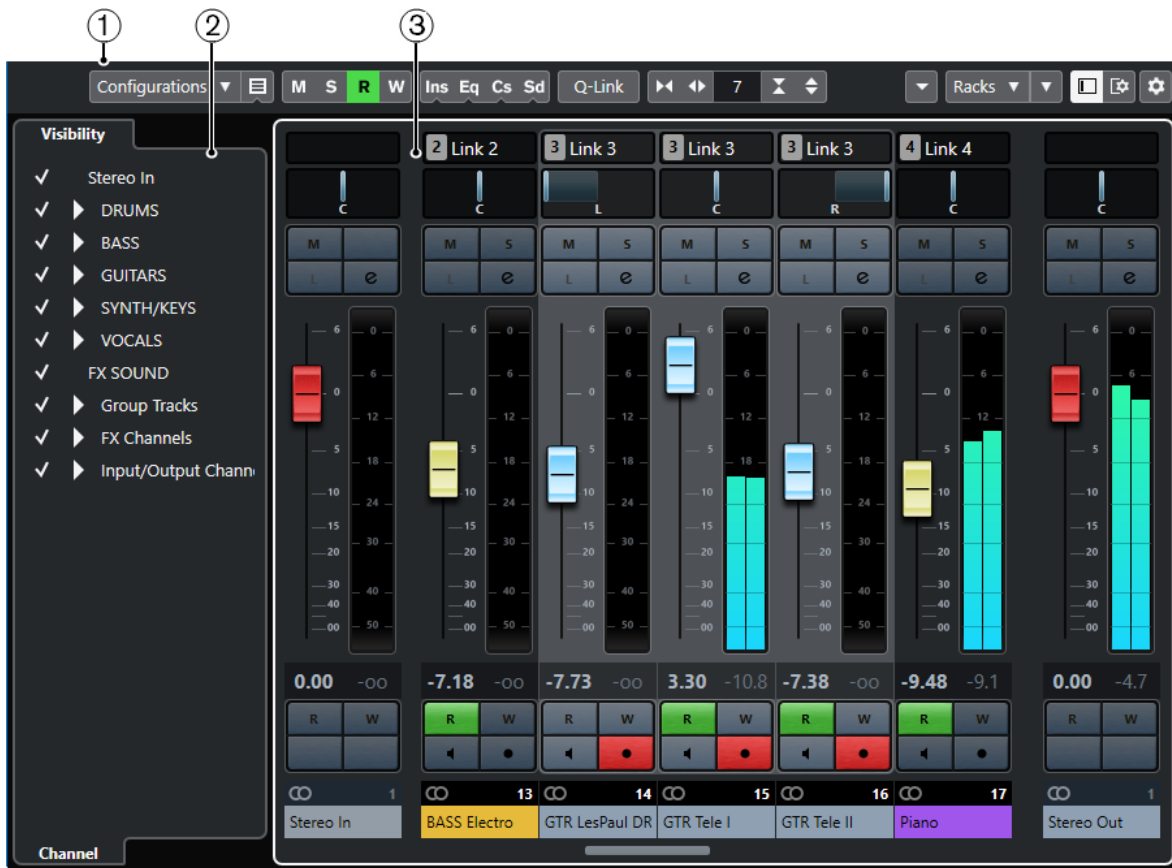

The **MixConsole** is divided into the following sections:

1 Toolbar

The toolbar shows tools and shortcuts for settings and functions in the **MixConsole**.

2 Left Zone

Allows you to set up the visibility of channels in the fader section.

3 Fader section

The fader section is always visible and shows all channels in the same order as in the track list.



Apart from the main sections, you can also access the following sections from within the **MixConsole** window:

1 Meter bridge

Allows you to monitor the levels of your channels.

2 Equalizer curves

Allows you to draw an EQ curve. Click in the curve display to open a larger view where you can edit the curve points.

3 Channel racks

Allows you to show additional channel controls, as needed.

4 Pictures

Allows you to add a track picture to the selected channel. Pictures can help you identify your **MixConsole** channels quickly.

5 Notepad

Allows you to enter notes and comments about a channel. Each channel has its own notepad.

6 Channel Latency

Allows you to show the latencies caused by insert effects or channel strip modules.

RELATED LINKS

- [MixConsole Left Zone](#) on page 283
- [MixConsole Toolbar](#) on page 284
- [Project Window Toolbar](#) on page 36
- [Fader Section](#) on page 293
- [Channel Racks Selector](#) on page 289
- [Adding Track Pictures to MixConsole Channels](#) on page 313
- [Adding Notes to a MixConsole Channel](#) on page 313
- [Channel Latency Overview](#) on page 314
- [Channel Strips](#) on page 306

MixConsole Left Zone

The left zone of the **MixConsole** shows a list of the **MixConsole** channels that allows you to show/hide specific channels.

- To show/hide the left zone of the **MixConsole**, click **Show/Hide Left Zone** in the **MixConsole** window toolbar.

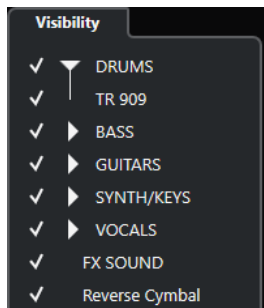

Visibility

Lists all channels contained in your project and allows you to show/hide specific channels.

RELATED LINKS

- [MixConsole Toolbar](#) on page 284

MixConsole Visibility

The **Visibility** tab in the **MixConsole** lists all channels contained in your project, and allows you to show/hide specific channels.

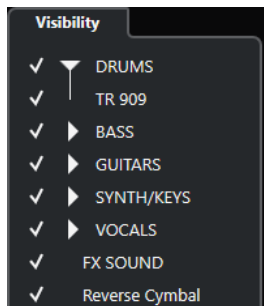

- To show/hide channels, check/uncheck them by clicking to the left of the channel name.
- To collapse/expand groups and folders, click the group or folder name.

NOTE

The **MixConsole** in the lower zone of the **Project** window does not follow any visibility changes that you perform in the **MixConsole** window and vice versa.

MixConsole Toolbar

The toolbar contains tools and shortcuts for settings and functions in the **MixConsole**.

NOTE

The **MixConsole** toolbar in the lower zone of the **Project** window contains a limited set of tools.

Left Divider

Left Divider

Allows you to use the left divider. Tools that are placed to the left of the divider are always shown.

Channel Visibility Configuration

Channel Visibility Configurations

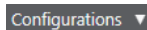
 Configurations ▼

Allows you to create configurations that are useful for switching quickly between different visibility setups.

Set Channel Type Filter



Opens the channel filter that allows you to show/hide all channels of a certain channel type.

Racks

Select Rack Types

 Racks ▼

Opens the rack selector that allows you to show/hide specific racks.

Rack Settings



Opens a pop-up menu with settings for the racks.

Locators

Go to Left Locator Position



Allows you to go to the left locator position.

Left Locator Position

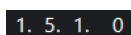
 1. 5. 1. 0

Shows the left locator position.

Go to Right Locator Position



Allows you to go to the right locator position.

Right Locator Position

4. 8. 1. 0

Shows the right locator position.

Locator Range Duration

Locators to Selection



Allows you to set the locators to the selection.

Locator Range Duration

4. 8. 1. 0

Shows the duration of the locator range.

Transport Buttons

Go to Previous Marker/Zero



Moves the project cursor to the previous marker/zero position on the timeline.

Go to Next Marker/Project End



Moves the project cursor to the next marker/project end.

Rewind



Moves backward.

Forward



Moves forward.

Activate Cycle



Activates/Deactivates cycle mode.

Stop



Stops playback.

Start



Starts playback.

Transport Record



Activates/Deactivates record mode.

Time Displays

Primary Time Display

6. 1. 1. 0

Shows the position of the project cursor in the selected time format.

Select Primary Time Format



Allows you to select a time format for the primary time display.

Secondary Time Display

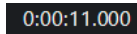

Shows the position of the project cursor in the selected time format.

Select Secondary Time Format



Allows you to select a time format for the secondary time display.

Markers

Jump to Marker



Allows you to set and locate marker positions.

Open Markers Window



Opens the **Markers** window.

State Buttons

Deactivate All Mute States



Deactivates all mute states.

Deactivate All Solo States



Deactivates all solo states.

Activate/Deactivate Read for All Tracks



Activates/Deactivates read automation for all tracks.

Activate/Deactivate Write for All Tracks



Activates/Deactivates write automation for all tracks.

Bypass Inserts



Bypasses all inserts.

Bypass EQs



Bypasses all EQs.

Bypass Channel Strip



Bypasses all channel strip modules.

Bypass Sends



Bypasses all sends.

Link Group

Temporary Link Mode



Synchronizes all touched parameters of selected channels.

Zoom Palette

Reduce Channel Width



Allows you to reduce the channel width.

Set Number of Channels



Displays the set number of channels.

Increase Channel Width



Allows you to increase the channel width.

Reduce Rack Height



Allows you to reduce the rack height.

Increase Rack Height



Allows you to increase the rack height.

Audio Performance Meter

Audio Performance Meter



The upper bar displays either the current realtime peak or the ASIO-Guard load, depending on which of the two has the higher value. The lower bar shows the hard disk transfer load of the disk engine.

For a more detailed display of realtime peak and ASIO-Guard load, click to open the **Audio Performance** window.

Right Divider

Right Divider

Tools that are placed to the right of the divider are always shown.

Mixer Functions Menu

Functions Menu



Opens a pop-up menu where you can select a **MixConsole** function.

Window Zone Controls

Show/Hide Left Zone



Shows/Hides the left zone of the window.

Set up Window Layout



Allows you to set up the window layout.

Set up Toolbar

Set up Toolbar



Opens a pop-up menu where you can set up which toolbar elements are visible.

Filtering Channel Types

The channel types filter on the **MixConsole** toolbar allows you to determine which channel types are shown.

PROCEDURE

1. Click **Set Channel Type Filter**.

This opens the channel types filter.

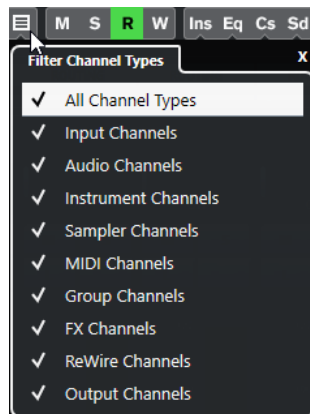

2. Click to the left of a channel type to uncheck it and to hide all channels of that type.

RESULT

Channels of the filtered type are removed from the fader section, and the color of the **Set Channel Type Filter** button changes to indicate that a channel type is hidden.

Channel Visibility Configurations Menu

The **Channel Visibility Configurations** button on the **MixConsole** toolbar allows you to create configurations that are useful for switching quickly between different visibility setups.

The button displays the name of the active configuration. A list of configurations is shown as soon as you create at least one configuration. To load a configuration, select it from the menu. Channel visibility configurations are saved with the project.

Add Configuration

Opens the **Add Configuration** dialog that allows you to save the configuration and to enter a name for it.

Update Configuration

If you change the active configuration, this is indicated by an asterisk after the configuration name. Use this function to save changes to the active configuration.

Rename Configuration

Opens the **Rename Configuration** dialog that allows you to rename the active configuration.

Delete Configuration

Allows you to delete the active configuration.

Move Configuration to Position

This function becomes available if 2 or more configurations exist. It allows you to change the position of the active configuration on the menu. This is useful, as you can assign key commands to the first 8 configurations in the **Channel & Track Visibility** category of the **Key Commands** dialog.

Saving Configurations

To quickly switch between different channel setups, you can save configurations. The configurations contain visibility settings as well as the show/hide status of channel types and racks.

PROCEDURE

1. Set up the configuration that you want to save.
 2. On the toolbar, click **Channel Visibility Configurations**.
 3. From the pop-up menu, select **Add Configuration**.
 4. In the **Add Configuration** dialog, enter a name for the configuration.
 5. Click **OK**.
-

RESULT

The configuration is saved, and you can return to it at any time.

Rack Selector

The rack selector allows you to activate specific **MixConsole** functions that are organized in racks, such as routing, insert, or send handling.

Channel Racks Selector

You can activate and deactivate the different channel racks in the **MixConsole**.

- To open the rack selector, click **Select Rack Types** on the **MixConsole** toolbar.

Depending on the channel type, you can activate/deactivate the following racks:

Hardware

Allows you to control your audio hardware effects. This rack is only available if supported by your hardware.

Routing

Allows you to set up the input and output routing. For MIDI, you can also select the MIDI channel.

Pre (Filters/Gain/Phase)

Contains input filter controls along with **Phase** and **Gain** controls for audio-related channels.

Inserts

Allows you to select insert effects for your channel.

Equalizers (audio-related channels only)

Allows you to set the channel EQ.

Channel Strip (audio-related channels only)

Allows you to integrate channel strip modules, such as Gate, Compressor, EQ, Transformer, Saturator, and Limiter that allow you to enhance your sound.

Sends

Allows you to select send effects for your channel.

RELATED LINKS

[MixConsole Toolbar](#) on page 284

Rack Settings Menu

The **Rack Settings** pop-up menu allows you to make settings for the racks.

- To open the **Rack Settings** pop-up menu, click **Rack Settings** on the **MixConsole** toolbar.

Exclusive Expanded Rack

Shows the selected rack exclusively and collapses the other racks.

Fixed Number of Slots

Shows all available slots for the **Inserts**, **Sends**, **Cues**, and **Quick Controls** racks.

Link Racks to Configurations

If this option is activated, the rack status is taken into account when you save and load a configuration.

Show Pre/Filters as <Combined Label & Setting>

Select **Combined Label & Setting** if you want to show the label and the setting in one line.

Select **Separate Label & Setting** if you want to show the label and the setting in separate lines.

Show Inserts as <Plug-in Names & Insert Controls>

Select **Plug-in Names** if you want to show the plug-in names only.

Select **Plug-in Names & Insert Controls** if you want to show the plug-in names and the insert controls.

Show All Channel Strip Controls

Shows all available controls on the **Channel Strip** rack.

Show One Channel Strip Type

Shows only one channel strip type at a time.

Show Sends as <Send Destination & Gain>

Select **Send Destination & Gain** if you want to show the destination and the gain in one line.

Select **Send Destination, Gain & Send Controls** if you want to show the destination, the gain and the send controls.

RELATED LINKS

[MixConsole Toolbar](#) on page 284

Linking Channels

You can link selected channels in the **MixConsole** temporarily. Any change that is applied to one channel is mirrored by all linked channels.

Using Quick Link

You can activate the **Temporary Link Mode** to synchronize all touched parameters of selected channels.

PROCEDURE

1. Select the channels that you want to link.
2. On the **MixConsole** toolbar, activate **Q-Link**.

NOTE

You can also press **Shift - Alt/Opt** to temporarily link channels. In that case, the link is only active as long as you press the keys.

3. Change the parameters for one of the selected channels.
-

RESULT

The changes are applied to all selected channels until you deactivate **Q-Link**.

Functions Menu

The **Functions Menu** contains tools and shortcuts for settings and functions in the **MixConsole**.

- To open the **Functions Menu**, click **Functions Menu** on the **MixConsole** toolbar.

Scroll to Selected Channel

If this option is activated and you select a channel on the **Visibility** tab, the selected channel is automatically displayed in the fader section.

Copy First Selected Channel's Settings

Copies the settings of the first selected channel.

Paste Settings to Selected Channels

Pastes the settings to the selected channels.

Zoom

Opens a submenu where you can increase or reduce the channel width and the rack height.

Open Audio Connections

Opens the **Audio Connections** window.

Constrain Delay Compensation

Allows you to activate/deactivate the **Constrain Delay Compensation** that keeps all channels in perfect sync and automatically compensates any delay inherent in VST plug-ins during playback.

EQ/Filter Transition

Allows you to change the **EQ/Filter Transition** mode from **Soft** to **Quick**.

Save Selected Channels

Saves the settings for the selected channels.

Load Selected Channels

Loads the settings for the selected channels.

Global Meter Settings

Opens a submenu where you can set up the global meter settings.

Reset MixConsole Channels

Allows you to reset EQ, insert, and send effect settings for all channels or for selected channels only. Solo and mute buttons are deactivated, the volume fader is set to 0 dB, and pan is set to the center position.

RELATED LINKS

[MixConsole Toolbar](#) on page 284

Saving MixConsole Settings

You can save **MixConsole** settings for selected audio-related channels and load them into any project.

PROCEDURE

1. Select the channels with the settings that you want to save.
2. Select **Functions Menu > Save Selected Channels**.
3. In the file dialog, specify the file name and location.
4. Click **Save**.

RESULT

The settings for the selected channels are saved with the file extension `.vmx`. The input/output routing is not saved.

Loading MixConsole Settings

You can load **MixConsole** settings that have been saved for selected channels.

PROCEDURE

1. Select the same number of channels that you selected when you saved your **MixConsole** settings.
The loaded **MixConsole** settings are applied in the same order as originally saved. For example, if you have saved the settings for channels 4, 6, and 8, and apply these settings to channels 1, 2, and 3, the settings saved for channel 4 are applied to channel 1, the settings saved for channel 6 to channel 2, and so on.
2. Select **Functions Menu > Load Selected Channels**.
3. In the **Load Selected Channels** dialog, select the `.vmx` file and click **Open**.

RESULT

The channel settings are applied to the selected channels.

NOTE

When you apply loaded **MixConsole** settings to fewer channels, some of the saved settings are not applied. Since the saved settings are applied from left to right, as shown in the **MixConsole**, the settings for the channels furthest to the right are not applied to any channels.

Fader Section

The fader section is the heart of the **MixConsole**. It shows input and output channels in conjunction with audio, instrument, MIDI, group, and FX channels.

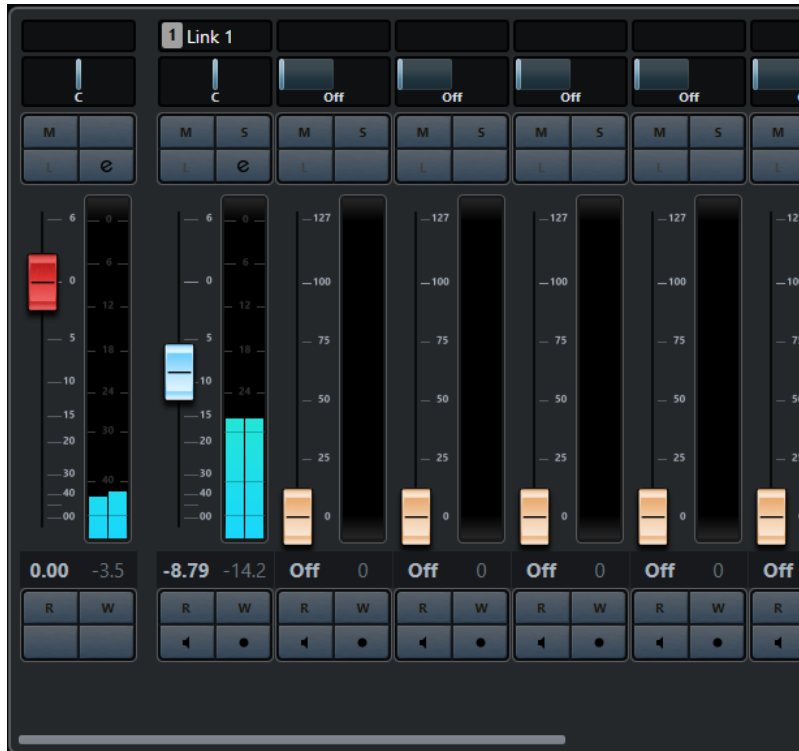

NOTE

If a channel is deactivated on the **Visibility** tab or if its channel type is deactivated, it is not shown in the fader section. The **MixConsole** in the lower zone of the **Project** window does not follow any visibility changes you perform in the **MixConsole** window and vice versa. It is linked to the track visibility of the **Project** window.

The fader section allows you to do the following:

- Set panorama
- Activate mute and solo
- Open channel settings
- Set volume
- Enable automation
- Set input levels

NOTE

All fader section functions and settings are also available in the **MixConsole** in the lower zone of the **Project** window.

RELATED LINKS

[Channel Settings](#) on page 315

[Write/Read Automation](#) on page 501

Pan Control

For each audio-related channel with at least a stereo output configuration, you can find a pan control at the top of the fader section. For MIDI channels, the pan control sends out MIDI pan messages. The result depends on how your MIDI instrument is set to respond to pan.

The pan control allows you to position a channel in the stereo spectrum.

- To make fine adjustments, hold down **Shift** when you move the pan control.
- To select the default center pan position, hold down **Ctrl/Cmd**, and click the pan control.
- To edit the value numerically, double-click the pan control.

RELATED LINKS

[Creating New Projects](#) on page 82

Stereo Balance Panner

The stereo balance panner allows you to control the balance between the left and right channels. It is activated by default.

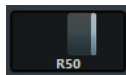

Pan Bypass

You can bypass the panning for all audio-related channels.

- To activate panning bypass, click the button to the left or press **Ctrl/Cmd - Alt/Opt - Shift** and click the pan control.
- To deactivate panning bypass, press **Ctrl/Cmd - Alt/Opt - Shift**, and click again.

When panning is bypassed for a channel, the following happens:

- Mono channels are panned center.
- Stereo channels are panned hard left and right.

Using Solo and Mute

You can silence one or several channels using **Solo** and **Mute**.

- To silence a channel, click **Mute**.
Click again to deactivate the mute state for the channel.
- To mute all other channels, click **Solo** for a channel.
Click again to deactivate the solo state.
- To deactivate the mute or solo states for all channels simultaneously, click **Deactivate All Mute States** or **Deactivate All Solo States** on the toolbar.

- To activate exclusive solo mode, hold down **Ctrl/Cmd**, and click **Solo** for the channel. The **Solo** buttons of all other channels are deactivated.
- To activate solo defeat for a channel, **Ctrl/Cmd - Alt/Opt**-click **Solo**.



You can also click and hold **Solo** to activate solo defeat. In this mode, the channel is not muted when you solo another channel. Click again to deactivate solo defeat.

Volume

Each channel in the fader section of the **MixConsole** has a volume fader. The fader levels are displayed below the fader, in dB for audio-related channels and as MIDI volume (0 to 127) for MIDI channels.

- To change the volume, move the fader up or down.
- To make fine volume adjustments, press **Shift** while moving the faders.
- To reset the volume to its default value, press **Ctrl/Cmd** and click a fader.

For audio channels, the volume fader controls the volume of the channel before it is routed to an output bus, directly or via a group channel. For output channels, the volume fader controls the master output level of all audio channels that are routed to an output bus. For MIDI channels, the volume fader controls the volume changes in the **MixConsole** by sending out MIDI volume messages to the connected instruments that are set to respond to MIDI messages.

Global Meter Settings Menu

You can change the meter characteristics for audio channels using the context menu of the channel meter.

Right-click the channel meter and select one of the following options from the **Global Meter Settings** menu:

Meter Peak - Hold Peaks

If this option is activated, the highest registered levels are held and shown as static horizontal lines in the meter.

Meter Peak - Hold Forever

If this option is activated, the peak levels are shown until you reset the meters. If this option is deactivated, you can use the **Meters' Peak Hold Time** parameter in the **Preferences** dialog (**Metering** page) to specify for how long the peak levels are held. The peak hold time can be between 500 and 30000 ms.

Meter Position - Input

If this option is activated, the meters show input levels for all audio channels and input/output channels. The input meters are post input gain.

Meter Position - Post-Fader

If this option is activated, the meters show post-fader levels.

Meter Position - Post-Panner

If this option is activated, the meters show post-fader levels and also reflect pan settings.

Reset Meters

Resets the meters.

Setting up Meter Colors

Setting up meter colors can help you to keep an overview of what levels are being reached.

PROCEDURE

1. In the **Preferences** dialog, select **Metering > Appearance**.

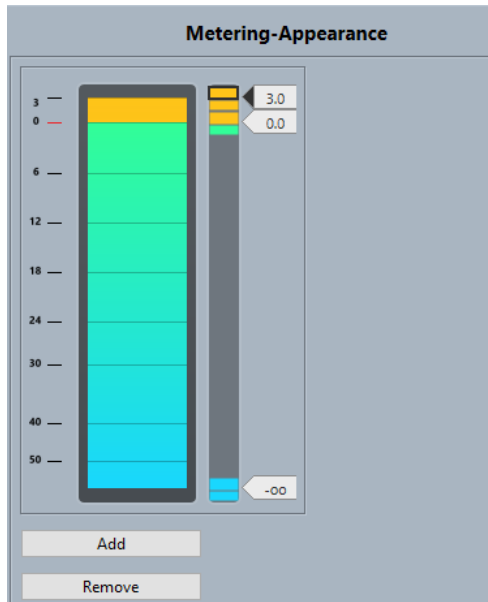

2. Do one of the following to set the level position for a color change:
 - Double-click a level position to the right of the meter scale and enter the level (dB) value. To enter dB values smaller than zero, add a minus sign before the entered number.
 - Click a level position, and drag it to a specific level. Press **Shift** for more accurate positioning.
 - Click a level position, and nudge it up or down with the **Up Arrow** / **Down Arrow** keys. Press **Shift** for faster positioning.
3. Click the upper or lower part of a color handle so that a frame is shown. In the color picker, select a color.

Selecting the same color for the upper and lower part of the handle results in a meter that changes its colors gradually. Different colors indicate level changes even more precisely.

NOTE

- To add more color handles, click **Add**, or **Alt**-click at a level position to the right of the meter scale. Each new handle is automatically associated with a default color.
 - To remove a handle, select the handle and click **Remove**, or **Ctrl/Cmd**-click the handle.
-

4. Click **OK**.
-

RELATED LINKS

[Metering - Appearance](#) on page 843

Level Meters

The channel meters show the level when you play back audio or MIDI. The **Meter Peak Level** indicator shows the highest registered level.

- To reset the peak level, **Alt/Opt**-click the **Meter Peak Level** value.

NOTE

Input and output channels have clipping indicators. When they light up, lower the gain or the levels until the indicator is no longer lit.

Input Levels

When recording digital sound, it is important to set the input levels high enough to ensure low noise and high audio quality. At the same time, you must avoid clipping (digital distortion).

Setting Input Levels

In the **MixConsole**, you can set the input level. Make sure that the signal is loud enough but does not exceed 0 dB.

PROCEDURE

1. Select **Functions Menu > Global Meter Settings > Meter Position** and activate **Input**.

In this mode, the input channel level meters show the level of the signal at the input of the bus, before any adjustments, such as input gain, EQ, effects, level, or pan are made. This allows you to check the level of the unprocessed signal coming into the audio hardware.

2. Play back the audio, and check the level meter for the input channel.

The signal should be as loud as possible without exceeding 0 dB, that is, the clipping indicator for the input bus should not light up.

3. If necessary, adjust the input level in one of the following ways:

- Adjust the output level of the sound source or the external mixer.
- If possible, use the application program of the audio hardware to set the input levels. Refer to the documentation for the audio hardware.
- If your audio hardware supports the ASIO control panel function, it may be possible to make input level settings. To open the ASIO control panel, select **Studio > Studio Setup**. In the **Devices** list, select your audio card. When this is selected, you can open the control panel by clicking **Control Panel** in the settings section to the right.

4. Optional: Select **Functions Menu > Global Meter Settings > Meter Position** and activate **Post-Fader**.

NOTE

This allows you to check the level of the audio being written to a file on your hard disk, which is only necessary if you make any adjustments to the input channel.

5. Optional: In the **Channel Racks** section, in the **Inserts** rack, click a slot and select an effect, or in the **Equalizers** rack, make your EQ settings.

For some effects, you may want to adjust the level of the signal going into the effect. Use the input gain function for this. Press **Shift** or **Alt/Opt** to adjust the input gain.

6. Play back the audio, and check the level meter of the input channel.

The signal should be reasonably loud without exceeding 0 dB, that is, the clipping indicator for the input bus should not light up.

7. If necessary, use the input channel fader to adjust the signal level.
-

Clipping

Clipping typically occurs in the audio hardware when an analog signal is too loud and therefore converted to digital in the A/D converters of the hardware.

Channel Racks

The **Channel Racks** section contains specific **MixConsole** functions, such as routing, insert, or send handling. These are organized in racks.

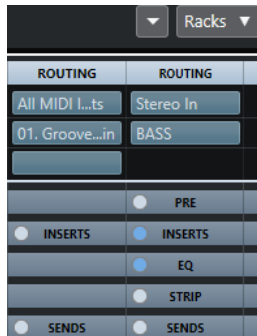

NOTE

The **MixConsole** in the lower zone of the **Project** window features the **Inserts** and the **Sends** rack only.

RELATED LINKS

- [Routing](#) on page 299
- [Pre \(Filters/Gain/Phase\)](#) on page 300
- [Inserts](#) on page 302
- [Equalizers \(EQ\)](#) on page 303
- [Channel Strips](#) on page 306
- [Sends](#) on page 312

Copying and Moving Rack and Channel Settings

You can use drag and drop to copy or move rack and channel settings.

NOTE

This function is only available in the **MixConsole** window.

Drag and drop works between different channels or different rack slots on the same channel. When you drag, a visual feedback indicates the sections where you can drop your settings.

The following applies:

- To move the rack settings from one rack to another, drag the rack, and drop it on the rack to which you want to move the settings.
- To copy the rack settings from one rack to another, press **Alt/Opt**, drag the rack, and drop it on the rack to which you want to copy the settings.
- To copy the channel settings from one channel to another, drag the channel, and drop it on the channel to which you want to copy the settings.

- To copy the channel settings from one channel to another, including the output routing settings, press **Alt/Opt**, drag the channel, and drop it on the channel to which you want to copy the settings.

You can copy rack and channel settings between different types of channels, provided that the target channels have corresponding settings.

- For example, copying from input/output channels leaves the sends settings in the target channel unaffected.

Routing

The **Routing** rack allows you to configure input and output routing, that is, setting up input and output busses.

NOTE

This channel rack is only available in the **MixConsole** window.

Input busses are used when you record on an audio track. In this case, you must select from which input bus to receive the audio.

NOTE

The settings that you make for the input channel become a permanent part of the recorded audio file.

Output busses are used when you play back an audio, group, or FX channel. In this case, you must route the channel to an output bus.

Setting up Routing

You can set up the input and output busses in the **Routing** rack of the **MixConsole**.

PREREQUISITE

Set up busses and group channels in the **Audio Connections** window.

PROCEDURE

1. On the **MixConsole** toolbar, click **Racks**, and activate **Routing** to show the **Routing** rack above the fader section.
 2. Click one of the slots of the **Routing** rack to open the input or the output routing pop-up menu for a channel.
 3. In the routing selector, select an entry.
 - To set up the routing for multiple selected channels simultaneously, press **Shift-Alt/Opt** and select a bus.
 - To set several selected channels to incrementing busses (the second selected channel to the second bus, the third to the third bus, etc.), press **Shift** and select a bus.
 - To disconnect input or output bus assignments, select **No Bus**.
-

Input Busses

The input routing selector only lists busses that correspond to the channel configuration.

Input Routing Configurations for Mono Channels

For mono channels, the following input routing configurations are available:

- Mono input busses.
- Mono output busses, or mono group output busses.
These should not lead to feedback.

RELATED LINKS

[Routing](#) on page 299

Input Routing Configurations for Stereo Channels

For stereo channels, the following input routing configurations are available:

- Mono or stereo input busses.
- Mono or stereo output busses, and mono or stereo group output busses.
These should not lead to feedback.

RELATED LINKS

[Routing](#) on page 299

Output Busses

For output busses, any assignment is possible.

You can route the output of audio, instrument, group, and FX channels to output, group, FX channels, or use it as effect side-chain source.

Routing the outputs from multiple audio channels to a group allows you to control the channel levels using one fader, and to apply the same effects and equalization to all the channels.

Pre (Filters/Gain/Phase)

The **Pre** rack for audio-related channels features a high-cut and a low-cut filter as well as gain and phase settings.

NOTE

This channel rack is only available in the **MixConsole** window.

NOTE

You cannot edit the **Pre** rack settings in the EQ curve display.

RELATED LINKS

[Equalizer Settings](#) on page 304

Making Filter Settings

Each audio-related channel has separate high-cut and low-cut filters that allow you to attenuate signals with frequencies that are higher or lower than the cutoff frequency.

PROCEDURE

1. On the **MixConsole** toolbar, click **Racks**, and activate **Pre (Filters/Gain/Phase)** to show the **Pre** rack above the fader section.
 2. Click to the left of the high-cut filter to activate the high-cut filter. You have the following options:
 - Drag the slider to adjust the cutoff frequency.
The available range spans from 20 kHz to 50 Hz.
 - Click **Select Filter Slope** on the right of the high-cut filter to select a filter slope.
You can choose between 6, 12, 24, 36, and 48 dB. The default value is 12 dB.
 3. Click to the left of the low-cut filter to activate the low-cut filter. You have the following options:
 - Drag the slider to adjust the cutoff frequency.
The available range spans from 20 Hz to 20 kHz.
 - Click **Select Filter Slope** on the right of the low-cut filter to select a filter slope.
You can choose between 6, 12, 24, 36, and 48 dB. The default value is 12 dB.
-

RESULT

The changed settings are visible in the curve display. If you deactivate the high-cut and low-cut filters, the filter curves are removed from the display. Bypassed high-cut and low-cut filters are displayed in a different color.

Making Input Gain Settings

The **Pre-Gain** slider allows you to change the level of a signal before it reaches the EQ and the effects section. This is useful, as the level going into certain effects can change the way the signal is affected. A compressor, for example, can be driven harder by raising the input gain. You can also use gain to boost the level of poorly recorded signals.

PROCEDURE

1. On the **MixConsole** toolbar, click **Racks**, and activate **Pre (Filters/Gain/Phase)** to show the **Pre** rack above the fader section.
 2. Drag the **Gain** slider to the left or to the right to cut or boost the gain.
-

Making Phase Settings

Each audio-related channel and input/output channel has a **Phase** button that allows you to correct the phase for balanced lines and microphones that are wired backwards or that are out of phase due to their positioning.

PROCEDURE

1. On the **MixConsole** toolbar, click **Racks** and activate **Pre (Filters/Gain/Phase)** to show the **Pre** rack above the fader section.
 2. Activate **Phase** to invert the phase polarity for the signal.
-

Inserts

The **Inserts** rack for audio-related channels features insert effect slots that allow you to load insert effects for a channel. For MIDI channels, you can load MIDI inserts.

For further information, see the separate document **Plug-in Reference**.

RELATED LINKS

[Audio Effects](#) on page 329

Adding Insert Effects

You can add insert effects into **MixConsole** channels.

PROCEDURE

1. On the **MixConsole** toolbar, click **Racks**, and activate **Inserts** to show the **Inserts** rack above the fader section.
2. Click one of the insert slots to open the insert selector.
3. Click an insert effect to select it.

RESULT

The selected insert effect is loaded and automatically activated. Its plug-in panel opens.

Bypassing Insert Effects

You can bypass all insert effects.

- To bypass all inserts, click **Bypass** at the top of the **Inserts** rack.
- To bypass a single insert, click the button on the left of the inserts slot.
- To deactivate bypass, click the button again.

Activating Side-Chaining for Inserts

Some of the inserts feature side-chain functionality.

PROCEDURE

1. Right-click an insert effect.
2. From the context menu, select **Activate/Deactivate Side-Chaining**.

Saving/Loading FX Chain Presets

You can save and load all insert rack settings using FX chain presets. FX chain presets have the file name extension `.fxchainpreset`.

PROCEDURE

- In the top right corner of the **Inserts** rack, open the **Presets** pop-up menu, and perform one of the following actions:
 - To save the current settings as a preset, select **Save FX Chain Preset** and name your preset.
 - To load a preset, select **Load FX Chain Preset** and select a preset.

NOTE

You can also apply inserts with EQ and channel strip settings from track presets. You can load, tag, and save FX chain presets in the **MediaBay**.

Equalizers (EQ)

The **Equalizers (EQ)** rack is only available for audio-related channels. It features a built-in parametric equalizer with up to 4 bands for each audio channel.

NOTE

This channel rack is only available in the **MixConsole** window.

Activating Equalizer Bands

On the **EQ** rack, you can activate up to 4 EQ bands for each audio channel.

PROCEDURE

1. On the **MixConsole** toolbar, click **Racks**, and activate **Equalizers** to show the **EQ** rack above the fader section.
2. Click **Activate/Deactivate Band** to activate an EQ band.

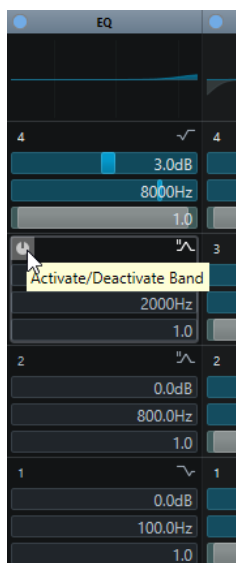

Equalizer Settings

You can make equalizer settings for the 4 bands. These have different default frequency values and different Q names. However, they all have the same frequency range (20 Hz to 20 kHz). You can specify different filter types for each individual module.

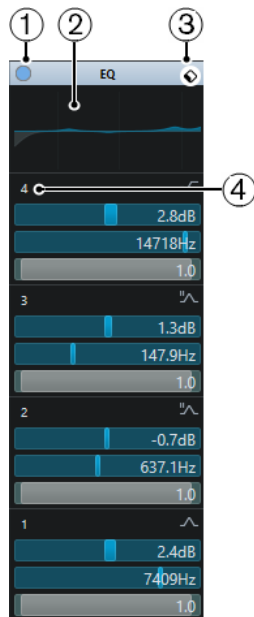

1 Bypass EQ

Click to bypass all EQ bands.

2 Curve display

Click on the display in a channel to show a larger version. The display is also available in the **Equalizers** section of the track **Inspector** in the **Project** window and in the **Channel Settings** window.

Clicking the curve display enlarges the view and shows a cross-hair cursor. The current mouse position shows the frequency, note value, offset, and level at the top or bottom of the display.

- Click to add a curve point and activate the corresponding EQ band.
- Double-click the curve point to deactivate it.
- Drag the curve point up or down to adjust the gain.
- Press **Ctrl/Cmd** to edit only the gain.
- Drag left or right to adjust the frequency.
- Press **Alt/Opt** to edit only the frequency.
- Press **Shift** while dragging to set the Q-factor.
- To invert the EQ curve, open the context menu, and select **Invert EQ Settings**.

The final curve shows the EQ settings as well as active high-cut and low-cut filters of the **Pre** rack settings. Bypassed filter settings are shown in a different color than the active settings. Disabled filter settings are hidden from the display.

NOTE

You cannot edit the high-cut and low-cut filters in the curve display. To edit the filters, open the **Pre** rack.

3 Select Preset

Opens a pop-up menu where you can load/save a preset.

4 **Activate/Deactivate Band**

Click to activate/deactivate an EQ band.

Band Settings

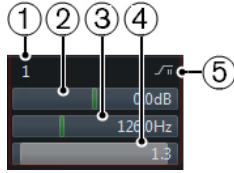

1 **Activate/Deactivate Band**

Activates/Deactivates the equalizer band.

2 **Gain**

Sets the amount of cut or boost. The range is ± 24 dB.

3 **Frequency**

Sets the center frequency of the frequency range to be cut or boosted. You can set the frequency either in Hz or as a note value. If you enter a note value, the frequency is automatically displayed in Hz. For example, a note value of A3 sets the frequency to 440 Hz. When you enter a note value, you can also enter a cent offset. For example, enter A5 -23 or C4 +49.

NOTE

Make sure that you enter a space between the note and the cent offset. Otherwise, the cent offsets are not taken into account.

4 **Q-Factor**

Determines the width of the affected frequency range. Higher values result in narrower frequency ranges.

5 **Select EQ Band Type**

Opens a pop-up menu where you can select an EQ type for the band. Bands 1 and 4 can act as parametric, shelving, or high/low-cut filters. EQ bands 2 and 3 are always parametric filters.

RELATED LINKS

[Making Filter Settings](#) on page 301

Saving/Loading EQ Presets

You can save and load EQ presets.

PROCEDURE

- In the top right corner of the **EQ** rack, open the presets pop-up menu, and perform one of the following actions:
 - To save the current settings as a preset, select **Save Preset**, and name your preset.
 - To load a preset, select **Load Preset**, and select a preset.

NOTE

You can also apply EQ with insert and channel strip settings from track presets. You can load, tag, and save EQ presets in the **MediaBay**.

Channel Strips

The **Channel Strip** rack available for audio-related channels only. It allows you to load built-in processing modules for separate channels. You can change the position of specific modules in the signal flow via drag and drop.

NOTE

The **Channel Strip** rack is available in the **MixConsole** window only.

Noise Gate

Allows you to silence audio signals below a set threshold level. As soon as the signal level exceeds the set threshold, the gate opens to let the signal through.

Compressor

Allows you to create smooth compression effects. Drag the compressor up or down to change its position in the signal flow.

EQ

Allows you to make EQ settings.

Tools

Provides various tools.

Sat

Allows you to add warmth to the sound.

Limit

Allows you to avoid clipping, even at high levels.

Noise Gate

Noise gating silences audio signals below a set threshold. As soon as the signal level exceeds the threshold, the gate opens to let the signal through.

Threshold

Determines the level at which **Gate** is activated. Signal levels above the set threshold trigger the gate to open, and signal levels below the set threshold close the gate.

Range

Adjusts the attenuation of the gate when it is shut. The higher the value, the higher the level of the signal that passes through the shut gate.

Attack

Sets the time after which the gate opens when it is triggered.

Release

Sets the time after which the gate closes.

Listen Filter

Allows you to monitor the filtered signal.

Activate Filter

Activates/Deactivates the internal side-chain and allows you to set up a filter to modify the signal detection.

Auto Release

Automatically finds the best **Release** setting for the audio material.

Filter Frequency

If the internal side-chain is activated, this parameter sets the filter frequency for the signal detection.

Q-Factor

If the internal side-chain is activated, this parameter sets the resonance of the filter for the signal detection.

State LED

Indicates whether the gate is open (LED lights up in green), closed (LED lights up in red), or in an intermediate state (LED lights up in yellow).

Compressor

This channel strip module reduces the dynamic range of the audio, making softer sounds louder or louder sounds softer, or both.

Open the pop-up menu to select between **Standard Compressor**, **Tube Compressor**, and **VintageCompressor**.

Standard Compressor

The **Standard Compressor** allows you to create smooth compression effects. Drag the compressor up or down to change its position in the signal flow.

Threshold

Determines the level where the compressor kicks in. Only signal levels above the set threshold are processed.

Ratio

Sets the amount of gain reduction that is applied to signals above the set threshold. A ratio of 3:1 means that for every 3 dB the input level increases, the output level increases by 1 dB.

Attack

Determines how fast the compressor responds to signals above the set threshold. The longer the attack time, the more of the early part of the signal passes through unprocessed.

Release

Sets the time it takes for the gain to return to its original level when the signal drops below the threshold.

Auto Make-Up

Automatically adjusts the output for gain loss.

Auto Release

Automatically finds the best **Release** setting for the audio material.

Make-Up Gain

Compensates for output gain loss caused by compression.

Gain Reduction LED

Indicates the level of compression of the signal.

RELATED LINKS

[Standard Compressor – Details View](#) on page 320

Tube Compressor

The **Tube Compressor** with integrated tube-simulation allows you to achieve smooth and warm compression effects. The VU meter shows the level of gain reduction. This compressor features an internal side-chain section that lets you filter the trigger signal.

Input Gain

Determines the compression level. The higher the input gain, the more compression is applied.

Output Gain

Sets the output gain.

Gain Reduction LED

Indicates the level of compression of the signal.

Attack

Determines how fast the compressor responds. The longer the attack time, the more of the early part of the signal passes through unprocessed.

Release

Sets the time it takes for the gain to return to its original level.

Auto Release

Automatically finds the best **Release** setting for the audio material.

Drive

Controls the amount of tube saturation.

Mix

Sets the level balance between the dry signal and the wet signal.

RELATED LINKS

[Tube Compressor – Details View](#) on page 321

VintageCompressor

The **VintageCompressor** is modeled after vintage compressors.

Input Gain

In combination with the **Output Gain** setting, this parameter determines the compression level. The higher the input gain setting and the lower the output gain setting, the more compression is applied.

Output Gain

Sets the output gain.

Attack

Determines the response time of the compressor. The longer the attack time, the more of the early part of the signal passes through unprocessed.

Release

Sets the time it takes for the gain to return to its original level.

Attack Mode (Punch)

If this option is activated, the early attack phase of the signal is preserved, retaining the original punch in the audio material, even with short **Attack** settings.

Auto Release

Automatically finds the best **Release** setting for the audio material.

Gain Reduction LED

Indicates the level of compression of the signal.

RELATED LINKS

[VintageCompressor - Details View](#) on page 322

EQ

You can make equalizer settings for the 4 bands. They have different default frequency values and different Q names. However, they all have the same frequency range (20 Hz to 20 kHz). You can specify different filter types for each individual module.

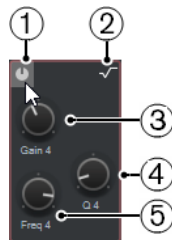

1 Activate/Deactivate Band

Activates/Deactivates the equalizer band.

2 Select EQ Band Type

Opens a pop-up menu where you can select an EQ type for the band. Bands 1 and 4 can act as parametric, shelf, or high/low-cut filters. EQ bands 2 and 3 are always parametric filters.

3 Gain

Sets the amount of cut or boost. The range is ± 24 dB.

4 Q-Factor

Determines the width of the affected frequency range. Higher values result in narrower frequency ranges.

5 Frequency

Sets the center frequency of the frequency range to be cut or boosted.

Tools

Provides a tool to attenuate or boost the gain of the attack and release phase of your audio.

EnvelopeShaper

This channel strip module can be used to attenuate or boost the gain of the attack and the release phases of audio material. You can use the knobs to change parameter values. Be careful with levels when boosting the gain. If needed, reduce the output level to avoid clipping.

Attack

Changes the gain of the attack phase of the signal.

Release

Changes the gain of the release phase of the signal.

Attack Length

Determines the length of the attack phase.

Output Gain

Sets the output level.

Sat

Allows you to add warmth to the sound. Open the pop-up menu to select between **Tape Saturation**, and **Tube Saturation**.

Tape Saturation

This channel strip module simulates the saturation and compression of recording on analog tape machines.

Drive

Controls the amount of tape saturation.

Low-Frequency

This is a low shelving filter with fixed frequency.

High-Frequency

This is a high-cut filter. Use the frequency fader to reduce harshness of the output signal.

Dual

Simulates the use of two tape machines.

Auto Gain

Adjusts the gain automatically.

Output

Sets the output gain.

Drive Amount LED

Indicates the amount of drive of the signal.

Tube Saturation

This channel strip module simulates the saturation and compression of recording of analogue tube compressors.

Drive

Controls the amount of tube saturation.

Low-Frequency

This is a low shelving filter with fixed frequency.

High-Frequency

This is a high-cut filter. Use the frequency fader to reduce harshness.

Output Gain

Sets the output gain.

Drive Amount LED

Indicates the amount of drive of the signal.

Limit

Allows you to avoid clipping, even at high levels. Open the pop-up menu to choose between **Brickwall Limiter**, **Maximizer**, and **Standard Limiter**.

Brickwall Limiter

Brickwall Limiter ensures that the output level never exceeds a set limit. Due to its fast attack time, **Brickwall Limiter** can reduce even short audio level peaks without creating audible artifacts. However, this channel strip module creates a latency of 1 ms.

Threshold

Determines the level where the limiter kicks in. Only signal levels above the set threshold are processed.

Release

Sets the time it takes for the gain to return to the original level when the signal drops below the threshold.

Auto Release

Automatically finds the best **Release** setting for the audio material.

Gain Reduction LED

Displays the amount of gain reduction.

Maximizer

This channel strip module raises the loudness of audio material without the risk of clipping.

Optimize

Determines the loudness of the signal.

Mix Amount

Sets the level balance between the dry signal and the wet signal.

Output

Determines the maximum output level. Set this to 0 dB to avoid clipping.

Gain Reduction LED

Displays the amount of gain reduction.

Standard Limiter

This channel strip module is designed to ensure that the output level does not exceed a set output level, to avoid clipping in subsequent devices. **Standard Limiter** can adjust and optimize the **Release** parameter automatically, according to the audio material, or it can be set manually.

Input

Adjusts the input gain.

Release

Sets the time it takes for the gain to return to its original level. If **Auto Release** is activated, **Standard Limiter** automatically finds the best **Release** setting for the audio material.

Output

Determines the maximum output level.

Gain Reduction LED

Displays the amount of gain reduction.

Saving/Loading Strip Presets

You can save and load strip presets. Strip presets have the file name extension `.strippreset`.

PROCEDURE

- In the top right corner of the **Channel Strip** rack, open the **Presets** pop-up menu, and perform one of the following actions:
 - To save the current settings as a preset, select **Save Strip Preset**, and name your preset.
 - To load a preset, select **Load Strip Preset**, and select a preset.

NOTE

You can also apply channel strip settings with insert and EQ settings from track presets. You can load, tag, and save strip presets in the **MediaBay**.

RELATED LINKS

[Loading Strip Presets](#) on page 495

Sends

The **Sends** rack for audio-related channels offers send effect slots. These slots allow you to load send effects and value sliders for determining the send level for a channel. For MIDI channels, the **Sends** rack features send effect slots that allow you to load send effects.

You can use sends to route audio, instrument, group, and FX channels to output, group, FX channels, or use them as effect side-chain sources.

Adding Send Effects

On the **Sends** rack, you can add send effects.

PROCEDURE

1. On the **MixConsole** toolbar, click **Racks**, and activate **Sends** to show the rack above the fader section.
 2. Click one of the send slots to open the send selector.
 3. Click a send effect to select it.
The selected send effect is loaded.
 4. Click on the left of the slot to activate the send.
-

Bypassing Send Effects

You can bypass all send effects.

- To bypass all sends, click the bypass button at the top of the **Sends** rack.
- To deactivate bypass, click the button again.

Adding FX Channels to a Send

You can add an FX channel track that is routed to a send from within the **MixConsole**.

PROCEDURE

1. Right-click on the send slot to open the context menu.

2. Select **Add FX Channel to <send name>**.
 3. In the **Add FX Channel Track** window, select the effect and configuration.
 4. Click **OK**.
-

RESULT

The FX channel track is added in the **Project** window, and the send is automatically routed to it.

Adding Track Pictures to MixConsole Channels

You can add track pictures to one or multiple channels in the **MixConsole**.

PROCEDURE

1. On the **MixConsole** toolbar, click **Set up Window Layout**, and activate **Pictures**.
The **Pictures** section is shown below the **Channel Racks** section.
 2. Do one of the following:
 - To add a picture to a channel, select the channel, and double-click the pictures section.
 - To add the same picture to multiple channels, select multiple channels, hold **Shift**, and double-click the pictures section.
 3. In the **Track Pictures Browser**, select a picture.
 4. Click **OK**.
-

RESULT

The picture is shown in the track list and in the **MixConsole** pictures section.

RELATED LINKS

[Track Pictures Browser](#) on page 141

[Showing Track Pictures](#) on page 140

Adding Notes to a MixConsole Channel

You can add annotations to **MixConsole** channels.

PROCEDURE

1. On the **MixConsole** toolbar, click **Set up Window Layout**, and activate **Notepad**.
The **Notepad** section is shown above the fader section.
 2. Select the channel for which you want to add notes, click in the **Notepad** section, and enter your notes.
 3. To close the **Notepad**, press **Esc**, or click in another section of the **MixConsole**.
-

Applying Channel Colors to Channel Controls

You can apply channel colors to the channel controls. This is useful if you have many channels in the **MixConsole** and you want to identify them by their color.

PREREQUISITE

You have manually or automatically assigned track/channel colors.

PROCEDURE

1. Select **Edit > Preferences**.
2. Open the **User Interface** page, and select **Track & MixConsole Channel Colors**.
3. In the **Colorize Tracks and MixConsole Channels** section, activate **MixConsole Channels**.
4. Optional: To adjust the brightness of a selected channel, adjust the **Selected Channel Brightness** slider.

NOTE

By default, the selected channel is shown in gray. If you want to display the selected channel in color, activate **Show Color for Selected Channel**. You can then discern it from the other channels by its pronounced color strength.

5. Click **OK**.

RESULT

The channel colors are applied to the channel controls.

RELATED LINKS

[Automatically Assigning Colors to New Tracks/Channels](#) on page 140

[Colorizing Single Tracks](#) on page 75

[Colorizing Selected Tracks](#) on page 74

[User Interface](#) on page 846

[User Interface - Track & MixConsole Channel Colors](#) on page 847

Channel Latency Overview

The **Channel Latency Overview** displays the latencies caused by insert effects, channel strip modules, or panners for audio-related channels in the **MixConsole**.

- Click **Set up Window Layout** on the **MixConsole** toolbar, and activate **Channel Latency** to show channel latencies in the fader section, then click **Open Channel Latency Overview** to open an overview of the latencies for a specific channel.

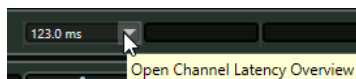

NOTE

The **Channel Latency Overview** is only available if latencies are present.

The **Channel Latency Overview** shows the following information:

Channel Latency Overview			
Name	Type	Latency (ms)	Latency (Samples)
MultibandCompressor	Inserts 1	113.4 (*)	5442
Brickwall Limiter	Inserts 2	1.0 (**)	48
<i>Total Channel Latency</i>		114.4	5490

Name

The name of the plug-in that causes the latency.

Type

Indicates if the latency is caused by an insert effect, a channel strip module, or a panner.

Latency (ms)

Shows the latency in milliseconds.

NOTE

- If the latency value is marked with **(*)**, the corresponding plug-in features a **Live** button or a low latency mode. If you activate **Constrain Delay Compensation**, this mode is automatically activated.
- If the latency value is marked with **(**)**, the corresponding plug-in does not feature a **Live** button or a low latency mode. If you activate **Constrain Delay Compensation** and the plug-in latency is higher than the **Constrain Delay Compensation** threshold, this plug-in is automatically deactivated.

NOTE

If you want any plug-in delay to be compensated during playback, make sure that **Constrain Delay Compensation** is deactivated.

Latency (Samples)

Shows the latency in samples.

Total Channel Latency

Shows the total latency for that channel in milliseconds and in samples.

RELATED LINKS

[Plug-In Delay Compensation](#) on page 331

[Functions Menu](#) on page 291

[Constrain Delay Compensation](#) on page 523

[MixConsole Window](#) on page 280

[VST](#) on page 848

Channel Settings

You can open each **MixConsole** channel in a separate **Channel Settings** window. This allows for a better overview and easy editing of individual channels and their settings.

The channel selection in the **Channel Settings** window is synchronized with the channel selection in the **MixConsole** and the track selection in the **Project** window.

NOTE

To separate the channel selection in the **Channel Settings** window from the channel selection in the **MixConsole**, open the **Functions Menu** on the toolbar of the **Channel Settings** window, and deactivate **Follow 'e' buttons or selection changes**.

To open the channel settings for an audio-related channel, do one of the following:

- In the fader section of the **MixConsole**, select the channel, and click **Edit Channel Settings**.
- In the track list, select the track, and, in the top section of the **Inspector**, click **Edit Channel Settings**.
- In the track list, select the track, and, on the track, click **Edit Channel Settings**.

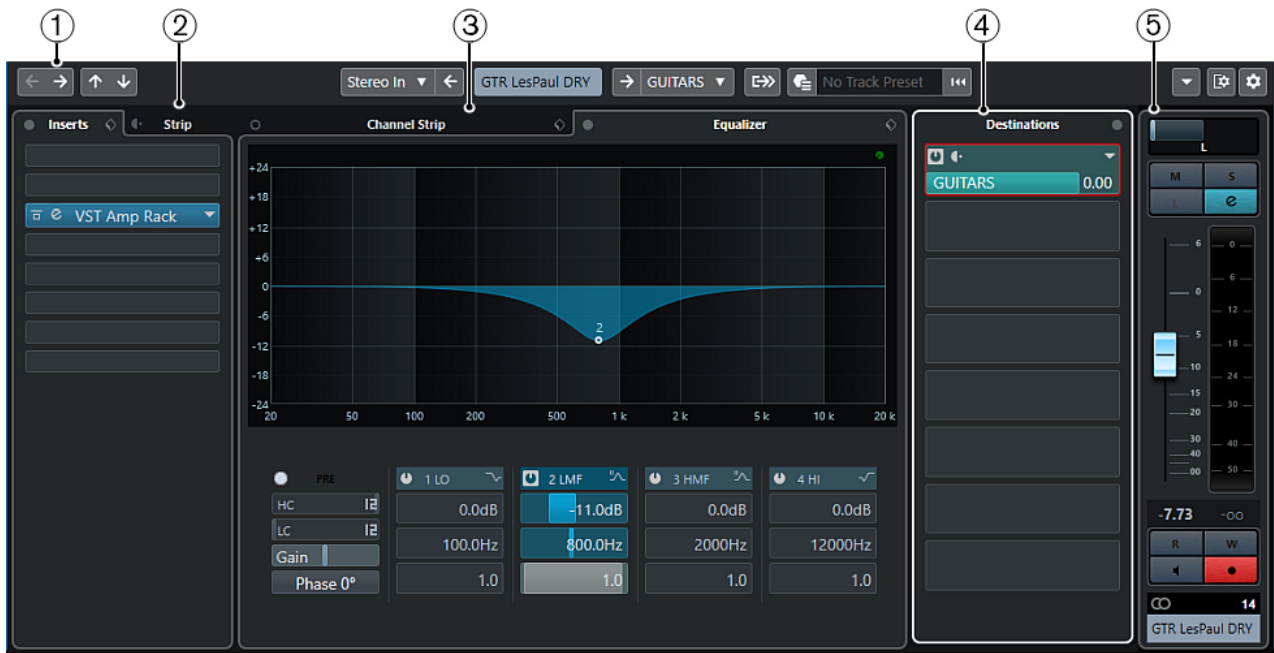

The **Channel Settings** window is divided into several sections:

1 Toolbar

The toolbar shows tools and shortcuts for settings and functions in the **Channel Settings** window.

2 Inserts/Strip

The **Inserts** section features insert effect slots that allow you to load insert effects for a channel.

The **Strip** section allows you to load built-in processing modules for separate channels.

3 Channel Strip/Equalizer

The **Channel Strip** section allows you to load built-in processing modules for separate channels.

The **Equalizer** section features a built-in parametric equalizer with up to 4 bands for each audio channel.

4 Destinations

The **Destinations** section features send effect slots that allow you to load send effects.

5 Fader

The fader section shows the current channel.

The sections are arranged in zones at the left and right of the **Channel Settings** window.

RELATED LINKS

[Channel Settings – Channel Inserts](#) on page 319

[Channel Settings – Channel Strip](#) on page 319

[Channel Settings – Equalizer](#) on page 325

[Channel Settings – Destinations](#) on page 326

[Channel Settings – Channel Faders](#) on page 327

[Equalizer Settings](#) on page 304

Channel Settings Toolbar

The toolbar in the **Channel Settings** window contains tools and shortcuts for settings and functions in the **Channel Settings** window.

Channel Navigation

Go to Last Edited Channel



Shows the channel that you last edited in the **Channel Settings** window. This is only available if you have edited at least 2 channels.

Go to Next Edited Channel



Shows the next channel in the **Channel Settings** window. This is only available if you have edited at least 2 channels.

Go to Previous MixConsole Channel



Shows the previous **MixConsole** channel in the **Channel Settings** window.

Go to Next MixConsole Channel



Shows the next **MixConsole** channel in the **Channel Settings** window.

Left Divider

Left Divider

Tools that are placed to the left of the divider are always shown.

Channel Sources

Input

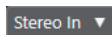

Opens the name of the input channel.

Go to Input/Select an Input



Shows the input channel in the **Channel Settings** window.

Channel Name

Channel Name

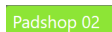

Shows the name of the channel that is shown in the **Channel Settings** window.

Channel Destinations

Go to Output/Select an Output



Opens the output channel in the **Channel Settings** window.

Output

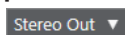

Shows the name of the output channel.

Edit Instrument

Edit VST Instrument



Allows you to open the VST instrument control panel. This is available for MIDI and instrument channels only.

Output Chain

Show Output Chain



Shows the output chain. This allows you to keep track of more complicated output routings.

Track Templates

Load/Save Track Preset



Allows you to load/save track presets.

Reload Track Preset



Allows you to reload track presets.

Channel Functions

Functions Menu



Opens a pop-up menu where you can select a **Channel Settings** function.

Window Zone Controls

Set up Window Layout



Allows you to set up the window layout.

Set up Toolbar



Opens a pop-up menu where you can set up which toolbar elements are visible.

Channel Settings – Channel Inserts

The **Channel Inserts** section is shown in the **Channel Settings** window.

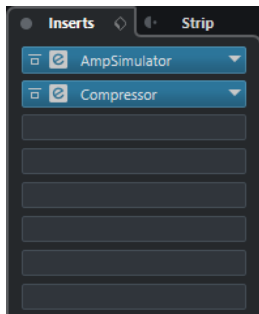

Bypass Inserts

Bypasses the insert effects for the channel.

Inserts

Allows you to add insert effects for the channel.

Preset Management

Allows you to load or save FX Chain presets.

Move Channel Strip to Pre/Post-Inserts Position

Allows you to move the channel strip to a pre-fader position or to a post-fader position in the signal flow.

Strip

Allows you to activate and set up channel strip modules for the channel.

RELATED LINKS

[Channel Settings](#) on page 315

Channel Settings – Channel Strip

The **Channel Strip/Equalizer** section is shown in the **Channel Settings** window.



Bypass Channel Strip

Bypasses the channel strip modules for the channel.

NOTE

You can reset the channel strip modules for the channel by **Alt/Opt**-clicking this button.

Channel Strip

Allows you to activate and set up channel strip modules for the channel.

Preset Management

Allows you to load or save strip presets.

Channel Strip Modules

The following channel strip modules are shown:

- Noise Gate
- Compressor
- EQ
- Tools
- Sat
- Limit

You can change the position of channel strip modules in the signal chain by dragging.

RELATED LINKS

[Noise Gate](#) on page 306

[Compressor](#) on page 307

[EQ](#) on page 309

[Tools](#) on page 309

[Sat](#) on page 310

[Limit](#) on page 311

[Channel Settings](#) on page 315

Standard Compressor – Details View

The **Standard Compressor** features a details view with more controls and value readouts for the meters.

- To open the details view, click **Edit Module** .



In the details view, the following additional parameters are available:

- Soft Knee/High Ratio
- Hold
- Analysis
- Dry Mix
- Input Gain meter
- Output Gain meter
- Gain Reduction meter

You can close the details view by clicking **Close Module** .

RELATED LINKS

[Standard Compressor](#) on page 307

Tube Compressor – Details View

The **Tube Compressor** features a details view with more controls and value readouts for the meters.

- To open the details view, click **Edit Module** .



In the details view, the following additional parameters are available:

- Character
- Low/High switch for Ratio
- Side-chain section with Frequency, Filter Type, Q-Factor, and Monitor
- Input Gain meter
- Output Gain meter

You can close the details view by clicking **Close Module** .

RELATED LINKS

[Tube Compressor](#) on page 308

VintageCompressor - Details View

The **VintageCompressor** features a details view with more controls and value readouts for the meters.

- To open the details view, click **Edit Module** .



In the details view, the following additional parameters are available:

- Mix
- Ratio buttons
- Input Gain meter
- Output Gain meter
- Gain Reduction meter

You can close the details view by clicking **Close Module** .

RELATED LINKS

[VintageCompressor](#) on page 308

Maximizer – Details View

The **Maximizer** features a details view with more controls and value readouts for the meters.

- To open the details view, click **Edit Module** .



In the details view, the following additional parameters are available:

- Classic
This mode is suited for all styles of music.
- Modern
This mode is particularly suited for contemporary styles of music. **Release** allows you to set the overall release time, **Recover** allows for a faster signal recovering at the beginning of the release phase.
- Soft Clip
Activate this to start limiting or clipping the signal softly and to generate harmonics that add a warm, tube-like characteristic to the audio material.
- High resolution input/output meter with gain reduction.

You can close the details view by clicking **Close Module** .

RELATED LINKS

[Maximizer](#) on page 311

Channel Settings – Equalizer

The **Channel Strip/Equalizer** section is shown in the **Channel Settings** window.



Bypass Equalizers

Bypasses the equalizer settings for the channel.

NOTE

You can reset the equalizers by **Alt/Opt**-clicking this button.

Preset Management

Allows you to load or save equalizer presets.

Equalizer Settings

Opens the **Equalizer Settings** panel.

Equalizer display

Allows you to make equalizer settings for the 4 bands in a large EQ curve display with several modes.

Equalizer Controls

Allows you to make equalizer settings for the 4 bands in a large EQ curve display with several modes.

RELATED LINKS

[Channel Settings](#) on page 315

Equalizer Settings Panel

The **Equalizer Settings** panel allows you to set up the equalizer.

- To open the **Equalizer Settings** panel, click **Equalizer Settings** in the **Equalizer** section of the **Channel Settings** window.

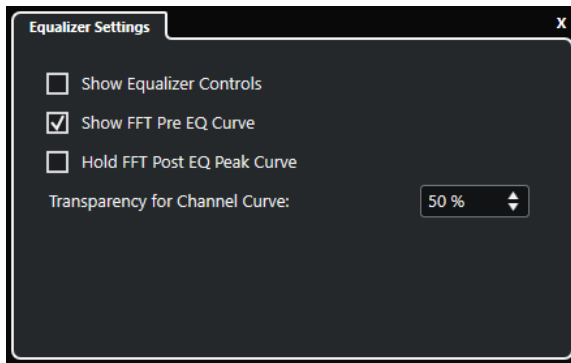

Show Equalizer Controls

Shows/Hides the equalizer controls.

Show FFT Pre EQ Curve

Shows/Hides the FFT (Fast Fourier Transform) input curve for the reference channel.

Hold FFT Post EQ Peak Curve

Holds the peak values of the FFT (Fast Fourier Transform) output curve for the reference channel.

Transparency for Channel Curve

Allows you to adjust the transparency of the filled area for the spectral curve.

Channel Settings – Destinations

The **Channel Sends** section is shown in the **Channel Settings** window.

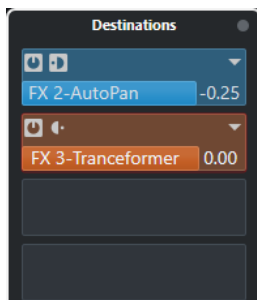

Bypass Sends

Bypasses the send effects for the channel.

Sends—Destinations

Allows you to set up a destination for the send effects of the channel.

RELATED LINKS

[Channel Settings](#) on page 315

Channel Settings – Channel Faders

The **Channel Faders** section is shown in the **Channel Settings** window.



The controls are the same as in the **MixConsole** fader section.

RELATED LINKS

[Fader Section](#) on page 293

[Channel Settings](#) on page 315

Keyboard Focus in the MixConsole

You can control the left zone, the channel rack section, and the fader section with the computer keyboard.

For this to work, the section must have the focus. If a section has the keyboard focus, the border that surrounds it is highlighted in a specific color.

Activating Keyboard Focus

To be able to control the **MixConsole** with the keyboard, you must activate the keyboard focus.

PROCEDURE

1. Click in an empty area of the section to activate the keyboard focus.
 2. Press **Tab** to activate the next section. This allows you to cycle forward through the sections.
 3. Press **Shift - Tab** to activate the previous section.
-

Navigating in a Section

Once you have activated the focus for a section, you can control it with the computer keyboard. In the channel racks section and in the fader section, controls that are selected for keyboard control are indicated by a red border.

CHOICES

- To navigate through the controls, use the **Up Arrow**, **Down Arrow**, **Left Arrow**, or **Right Arrow** keys.
 - To activate or deactivate a switch, press **Return**.
 - To expand or collapse an active rack, to open or close a value field in a slot, or to open the plug-in panel for a loaded plug-in, press **Return**.
 - To access the controls in the left zone, press **Ctrl/Cmd - Return**.
 - To access the controls in the middle zone, press **Return**.
 - To access the controls in the right zone, press **Alt/Opt - Return**.
 - To close a pop-up menu or a plug-in panel, press **Esc**.
 - To enable or disable the loaded plug-in, press **Ctrl/Cmd - Alt/Opt - Return**.
-

Audio Effects

Cubase comes with a number of included effect plug-ins that you can use to process audio, group, and instrument channels.

The effects and their parameters are described in the separate document **Plug-in Reference**.

Insert Effects and Send Effects

You can apply effects to audio channels by using insert effects or send effects.

Insert Effects

Insert effects are inserted into the signal chain of an audio channel. As a result, the whole channel signal passes through the effect.

You can add up to 8 different insert effects per channel.

Use insert effects for effects such as distortion, filters, or other effects that change the tonal or dynamic characteristics of the sound.

To add and edit insert effects, you can use the following inserts sections:

- The **Inserts** rack in the **MixConsole**.

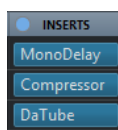

- The **Inserts** section in the **Channel Settings** window.

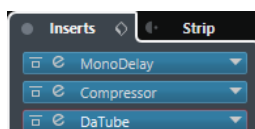

- The **Inserts** section in the **Inspector**.

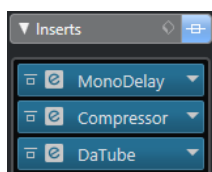

Send Effects

Send effects can be added to FX channel tracks, and the audio data to be processed can be routed to the effect. This way, the send effects remain outside the audio channel's signal path.

Each audio channel has 8 sends, each of which can be freely routed to an effect (or to a chain of effects).

Use send effects in the following cases:

- To control the balance between the dry and the wet sound individually for each channel.
- To use the same effect for several different audio channels.

To edit send effects, you can use the following sends sections:

- The **Sends** rack in the **MixConsole**.

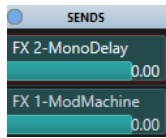

- The **Destinations** section in the **Channel Settings** window.

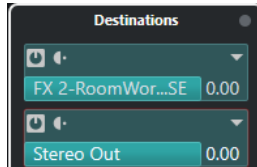

- The **Sends** section in the **Inspector**.

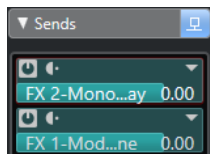

RELATED LINKS

[Direct Offline Processing](#) on page 358

VST Standard

Audio effects can be integrated in Cubase, thanks to the VST standard. At the moment, the VST 3 and VST 2 standards are supported.

The VST 3 plug-in standard offers improvements like smart plug-in processing and side-chain inputs. VST 3 retains full backwards compatibility to VST 2.

Smart Plug-In Processing

Smart plug-in processing is a technology that serves to disengage the processing for plug-ins when no signal is present. This reduces the CPU load on silent passages and allows you to load more effects.

To activate smart plug-in processing, activate **Suspend VST 3 plug-in processing when no audio signals are received** in the **Preferences** dialog (**VST—Plug-ins** page).

NOTE

Check the processor for the passage with the largest number of events playing simultaneously to make sure that your system offers the required performance at every time position.

Side-Chain Inputs

Several VST 3 effects feature side-chain inputs. These allow you to control the operation of the effect via external signals that are routed to the side-chain input.

The effect processing is still applied to the main audio signal.

RELATED LINKS

[Side-Chaining](#) on page 342

Plug-In Delay Compensation

Some audio effects, especially dynamics processors that feature a look-ahead functionality, may take a brief time to process the audio fed into them. As a result, the output audio is slightly delayed. To compensate for this, Cubase provides plug-in delay compensation.

Plug-in delay compensation is featured throughout the entire audio path, maintaining the sync and timing of all audio channels.

VST 3 dynamics plug-ins with look-ahead functionality feature a **Live** button that allows you to disengage the look-ahead. This minimizes latency during real-time recording. For details, see the separate document **Plug-in Reference**.

To avoid latency during real-time recording or real-time playback of VST instruments, you can also use **Constrain Delay Compensation**.

RELATED LINKS

[Constrain Delay Compensation](#) on page 523

[MixConsole Window](#) on page 280

Tempo Sync

Plug-ins can receive timing and tempo information from Cubase. This is useful to synchronize plug-in parameters, such as modulation rates or delay times, to the project tempo.

Timing and tempo information is provided to plug-ins of the standard VST 2.0 or later.

To set up tempo sync, you must specify a base note value. Straight, triplet, or dotted note values (1/1 to 1/32) are supported.

For details about the included effects, see the separate document **Plug-in Reference**.

Insert Effects

Insert effects can be inserted in the signal chain of an audio channel. This way, the whole channel signal passes through the effect.

You can add up to 8 different insert effects for each audio-related channel (audio track, group channel track, FX channel track, or instrument channel) or output bus.

The signal passes through the insert effects from top to bottom, according to their slot positions.

You can define post-fader insert slots for any channel. Post-fader insert slots are always post-EQ and post-fader.

NOTE

To show all post-fader slots in the **MixConsole**, open the **Rack Settings**, and activate **Fixed Number of Slots**.

Use post-fader slots for insert effects where you want the level to remain unchanged after the effect. Dithering and maximizers are typically used as post-fader insert effects for output busses, for example.

NOTE

If you want to use an effect with identical settings on several channels, set up a group channel, and apply your effect as a single insert for this group.

RELATED LINKS

[Dither Effects](#) on page 346

[Adding Insert Effects to Group Channels](#) on page 333

[Rack Settings Menu](#) on page 290

Adding Insert Effects

If you add insert effects to audio channels, the audio is routed through the insert effects.

PROCEDURE

1. Select the audio track.
2. In the track list, click **Edit Channel Settings**.
The **Channel Settings** window for the audio channel opens.
3. In the **Inserts** section, click the first insert slot on the **Inserts** tab, and select an effect from the selector.

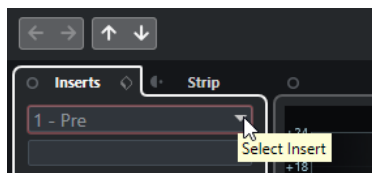

RESULT

The selected insert effect is loaded and activated, and the audio is routed through it. The effect control panel is opened.

RELATED LINKS

[Effect Control Panel](#) on page 347

Adding Insert Effects to Busses

If you add insert effects to input busses, the effects become a permanent part of the recorded audio file. If you add insert effects to output busses, all audio routed to that bus is affected. Insert effects that are added to output busses are sometimes referred to as master effects.

PROCEDURE

1. Select **Studio > MixConsole** to open the **MixConsole**.
 2. In the fader section, perform one of the following actions:
 - Locate the input channel, and click **Edit Channel Settings** to edit the input bus.
 - Locate the output channel, and click **Edit Channel Settings** to edit the output bus.The **Channel Settings** window for the selected channel opens.
 3. In the **Inserts** section, click the first insert slot on the **Inserts** tab, and select an effect from the selector.
-

RESULT

The selected insert effect is added to the bus and activated. The effect control panel is opened.

Adding Insert Effects to Group Channels

If you add insert effects to group channels, you can process several audio tracks through the same effect.

PROCEDURE

1. In the global track controls area of the track list, click **Add Track** .
2. Click **Group**.
3. Open the **Audio Outputs** pop-up menu, and select the desired output bus.
4. Click **Add Track**.
The group track is added to the track list.
5. In the **Inspector** for the group track, open the **Inserts** section.
6. Click the first effect slot, and select an effect from the selector.
7. In the **Inspector** for the audio tracks, open the **Output Routing** pop-up menus and select the group.

RESULT

The signal from the audio track is routed through the group channel and passes through the insert effect.

RELATED LINKS

[Add Track Dialog – Group Channel](#) on page 118

Adding Group Channels to Selected Channels

You can add a group channel to several selected channels.

PREREQUISITE

Your project contains some tracks that you want to route to a group channel.

PROCEDURE

1. In the track list, right-click the tracks that you want to route to a group channel, and select **Add Track > Group Channel to Selected Channels**.
2. In the **Add Track** dialog, open the **Configuration** pop-up menu, and select a channel configuration for the group channel track.
3. Open the **Folder Setup** pop-up menu, and select whether to create group channel tracks inside or outside a dedicated folder.
4. Click **OK**.

RESULT

The group channel track is added to the track list. In the **Output Routing** pop-up menu of the selected tracks, the group is selected. The tracks are routed to the group channel.

RELATED LINKS

[Add Track Dialog – Group Channel](#) on page 118

Copying Insert Effects

You can add insert effects to audio channels by copying them from other audio channels or from other slots of the same audio channel.

PREREQUISITE

You have added at least one insert effect to an audio channel.

PROCEDURE

1. Select **Studio > MixConsole**.
 2. In the **Inserts** rack, locate the insert effect that you want to copy.
 3. Hold down **Alt/Opt**, and drag the insert effect on an insert slot.
-

RESULT

The insert effect is copied. If the destination slot already contains an insert effect, the existing effect is moved down one slot.

Rearranging Insert Effects

You can change the position of an insert effect in the signal chain of the audio channel by moving it to a different slot of the same channel. You can also move an insert effect to another audio channel.

PREREQUISITE

You have added at least one insert effect to an audio channel.

PROCEDURE

1. Select **Studio > MixConsole**.
 2. In the **Inserts** rack, locate the insert effect that you want to rearrange.
 3. Drag the insert effect to another insert slot.
-

RESULT

The insert effect is removed from the source slot and placed on the destination slot. If the destination slot already contains an insert effect, this effect is moved to the next insert slot.

Deactivating Insert Effects

If you want to listen to a track without having it processed by an effect, but do not want to remove this effect completely from the insert slot, you can deactivate it.

PREREQUISITE

You have added an insert effect to an audio channel.

PROCEDURE

1. In the track list, select the audio track with the insert effect that you want to deactivate.
2. In the **Inspector**, open the **Inserts** section, and **Alt/Opt**-click **Bypass Insert**.

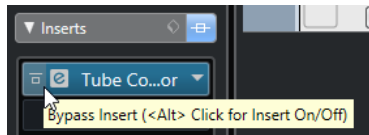

RESULT

The effect is deactivated, and all processing is terminated, but the effect is still loaded.

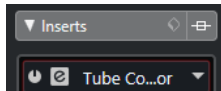

Bypassing Insert Effects

If you want to listen to the track without having it processed by a particular effect, but do not want to remove this effect completely from the insert slot, you can bypass it. A bypassed effect is still processing in the background. This allows for crackle-free comparison of the original with the processed signal.

PREREQUISITE

You have added an insert effect to an audio channel.

PROCEDURE

1. In the track list, select the audio track with the insert effect that you want to bypass.
2. In the **Inspector**, open the **Inserts** section, and click **Bypass Insert**.

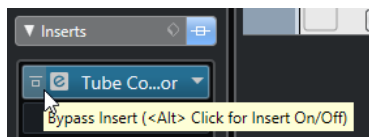

RESULT

The effect is bypassed but still processing in the background.

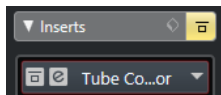

Removing Insert Effects

PROCEDURE

1. In the track list, select the audio track with the insert effect that you want to remove.
2. In the **Inspector**, open the **Inserts** section.
3. On the effect that you want to remove, click **Select Insert**.
4. In the effect selector, select **No Effect**.

RESULT

The insert effect is removed from the audio channel.

Freezing Insert Effects

Freezing an audio track and its insert effects allows you to reduce processor power. However, frozen tracks are locked for editing. You cannot edit, remove, or add insert effects for the frozen track.

PREREQUISITE

You have made all settings for the track and you are sure that you do not need to edit it anymore.

PROCEDURE

1. In the **Inspector** for the audio track that you want to freeze, click **Freeze Audio Channel**.



2. In the **Freeze Channel Options** dialog, specify a **Tail Size** in seconds.
This adds time at the end of the rendered file. As a result, reverb and delay tails can fully fade out.

RESULT

- The output of the audio track is rendered to an audio file, and on playback you hear the same sound as before freezing.
- Less CPU load is used.
- The **Freeze Audio Channel** button lights up.
- The track controls are grayed out.
- The audio events are locked.
- You can still adjust the level and panning, make EQ settings, and adjust the effect sends.

NOTE

The audio file is saved in the **Freeze** folder that can be found in the following location:

- Windows: within the **Project** folder
- macOS: **User/Documents**

AFTER COMPLETING THIS TASK

To unfreeze a frozen track, click **Freeze** again.

RELATED LINKS

[Freezing Multiple Tracks](#) on page 145

VST Effect Selector

The VST effect selector allows you to select VST effects from the active collection.

- To open the VST effect selector, open the **Inserts** section of the audio track **Inspector**, and on an insert slot, click **Select Insert**.

The following controls are available:

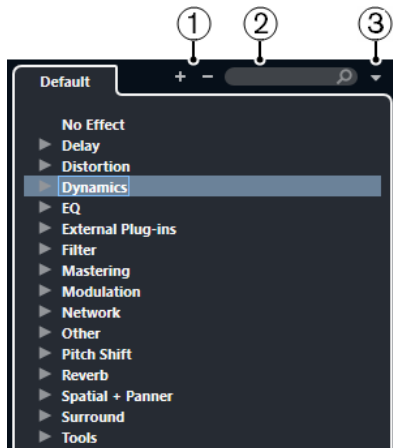

1 Expand Tree/Collapse Tree

Expands/Collapses the tree.

2 Search VST Effect

Allows you to search for VST effects by typing in the name or parts of the name or the category.

3 Plug-in Collections and Options

Allows you to select a collection.

If you select the **Default** collection, the options **Sort By Category** and **Sort by Vendor** become available. These allow you to sort the default collection.

Send Effects

Send effects are outside the signal path of an audio channel. The audio data to be processed must be sent to the effect.

- You can select an FX channel track as the routing destination for a send.
- You can route different sends to different FX channels.
- You can control the amount of signals sent to the FX channel by adjusting the effect send level.

NOTE

In the **Preferences** dialog (**VST** page), you can set a default send level. Use **Ctrl/Cmd**-click to set the send level to this default value.

To do this, create FX channel tracks.

RELATED LINKS

[FX Channel Tracks](#) on page 337

[VST](#) on page 848

FX Channel Tracks

You can use FX channel tracks as routing destinations for audio sends. The audio is sent to the FX channel and through any insert effects set up for it.

- You can add several insert effects to an FX channel.
The signal passes through the effects in series, from the top downward.

- You can rename FX channel tracks, just like any other tracks.
- You can add automation tracks to FX channel tracks.
This allows for automating various effect parameters.
- You can route the effect return to any output bus.
- You can adjust the FX channel in the **MixConsole**.
This includes adjusting the effect return level, the balance, and the EQ.

When you add an FX channel track, you can choose whether to create FX channel tracks inside or outside a dedicated folder. If you select **Create Inside Folder**, FX channel tracks are shown in a dedicated folder.

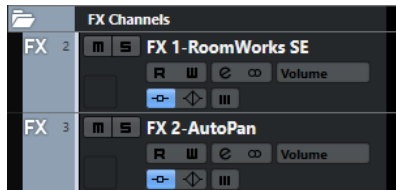

This results in a better overview and facilitates editing the FX channel tracks.

NOTE

To save screen space, collapse the FX channel folders.

RELATED LINKS

[Adding FX Channel Tracks](#) on page 338

Adding FX Channel Tracks

PROCEDURE

1. In the global track controls area of the track list, click **Add Track** .
 2. Click **Effect**.
 3. Open the **Effect** pop-up menu, and select an effect for the FX channel track.
 4. Open the **Configuration** pop-up menu, and select a channel configuration for the FX channel track.
 5. Open the **Folder Setup** pop-up menu, and choose whether to create FX channel tracks inside or outside a dedicated folder.
 6. Click **Add Track**.
-

RESULT

The FX channel track is added to the track list, and the selected effect is loaded into the first available insert effect slot of the FX channel.

RELATED LINKS

[Add Track Dialog – Effect](#) on page 121

Adding FX Channels to Send Slots

PROCEDURE

1. In the track list, select the tracks to which you want to add an FX channel.

2. In the **Inspector**, open the **Sends** section.
 3. Right-click the send slot for the FX channel, and select **Add FX Channel to Send**.
 4. Open the **Effect** pop-up menu, and select an effect for the FX channel track.
 5. Open the **Configuration** pop-up menu, and select a channel configuration for the FX channel track.
 6. Open the **Folder Setup** pop-up menu, and choose whether to create FX channel tracks inside or outside a dedicated folder.
 7. Click **Add Track**.
-

RESULT

The FX channel track is added to the track send slot.

Adding FX Channels to Selected Channels

PREREQUISITE

Your project contains some tracks to which you want to add an FX channel.

PROCEDURE

1. In the track list, select all tracks to which you want to add an FX channel.
 2. Right-click one of the tracks, and select **Add Track > FX Channel to Selected Channels**.
 3. In the **Add Track** dialog, open the **Effect** pop-up menu, and select an effect for the FX channel track.
 4. Open the **Configuration** pop-up menu, and select a channel configuration for the FX channel track.
 5. Open the **Folder Setup** pop-up menu, and choose whether to create FX channel tracks inside or outside a dedicated folder.
 6. Click **OK**.
-

RESULT

The FX channel track is added to the track list. The selected effect is loaded into the first available insert effect slot of the FX channel and to the first available send effect slot of all channels that you selected.

RELATED LINKS

[Add Track Dialog – Effect](#) on page 121

Adding Insert Effects to FX Channel Tracks

You can add insert effects to FX channel tracks.

PREREQUISITE

You have added an FX channel track and set up the correct output bus in the **Output Routing** pop-up menu.

PROCEDURE

1. In the track list for the FX channel track, click **Edit Channel Settings**.
The **Channel Settings** window for the FX channel track opens.

2. In the **Inserts** section, click an insert slot on the **Inserts** tab, and select an effect from the selector.
-

RESULT

The selected effect is added to the FX channel track as an insert effect.

Routing Audio Channels to FX Channels

If you route an audio channel send to an FX channel, the audio is routed through the insert effects that you have set up for the FX channel.

PROCEDURE

1. Select the audio track.
2. In the track list, click **Edit Channel Settings** to open the **Channel Settings** window.
3. On the **Destinations** tab, click **Select Destination** for an effect slot, and select the FX channel track from the selector.

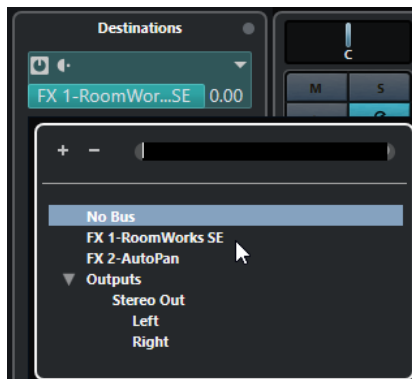

4. On the send slot, click **Activate/Deactivate Send**.

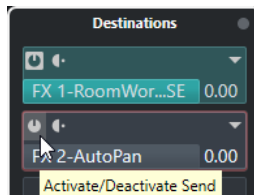

RESULT

The audio is routed through the FX channel.

AFTER COMPLETING THIS TASK

In the **Channel Settings** window for the audio channel, hold down **Alt/Opt** and double-click to show the send destination. If you have routed the send to an FX channel, the effect control panel is opened.

RELATED LINKS

[Adding FX Channel Tracks](#) on page 338

Pre/Post Fader Sends

You can choose whether to send the signal from the audio channel to the FX channel before or after the audio channel volume fader.

- Pre-fader sends
The audio channel signal is sent to the FX channel before the audio channel volume fader.
- Post-fader sends
The audio channel signal is sent to the FX channel after the audio channel volume fader.
- To move a send to a pre-fader position, open the **Channel Settings** window for the audio channel, right-click a send, and select **Move to Pre-Fader**.

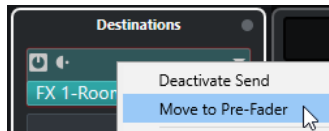

The **Pre-/Post-Fader** button indicates that the send is in pre-fader position.

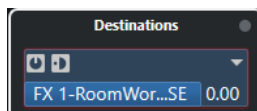

- To move a send to post-fader position, open the **Channel Settings** window for the audio channel, right-click a send, and select **Move to Post-Fader**.

The **Pre-/Post-Fader** button indicates that the send is in post-fader position.

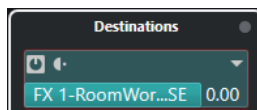

NOTE

If you activate **Mute Pre-Send when Mute** in the **Preferences** dialog (**VST** page), sends in pre-fader mode are muted if you mute their channels.

Setting the Level for the Sends

PROCEDURE

1. In the track list, select the FX channel track that contains the effect for which you want to set the level.
2. Open the **Inserts** section of the **Inspector**, and click the effect slot to open the effect control panel.
3. In the effect control panel, set the **Mix** control to 100.
This allows for full control of the effect level when you use the effect sends to control the signal balance later.
4. In the track list, select the audio track that is routed through the effect for which you want to set the level.
5. Click **Edit Channel Settings** to open the **Channel Settings** window for the audio track.
6. On the **Destinations** tab, locate the effect slot and drag to the left or to the right to set the send level. **Ctrl/Cmd**-click to set the level to the default send level, as specified in the **Preferences** dialog (**VST** page).

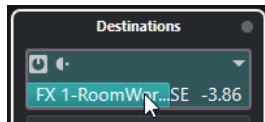

This determines how much of the signal from the audio channel is routed to the FX channel.

RESULT

The effect level is adjusted according to your settings.

NOTE

To determine how much of the signal is sent from the FX channel to the output bus, open the **Channel Settings** window for the FX channel track, and adjust the effect return level.

Side-Chaining

Many VST 3 effects support side-chaining. Side-chaining allows you to use the output of one track to control the action of an effect on another track.

Effects from the following categories feature side-chaining:

- Modulation
- Delay
- Filter

By activating side-chaining, you can do the following:

- Use the side-chain signal as a modulation source.
- Apply ducking to the instrument, that is, reduce the volume of the instrument track when a signal is present on the audio track.
- Compress the signals on one audio track when a second audio track starts.
This is commonly used to add compression on a bass sound when the drums are hit.

NOTE

For detailed descriptions of the plug-ins that feature side-chaining, see the separate document **Plug-in Reference**.

NOTE

- Certain combinations of tracks and side-chain inputs may lead to feedback loops and additional latency. If this is the case, the side-chain options are not available.
 - Side-chain connections are only kept when you move an effect within a channel. When you drag and drop an effect between channels, or when you copy an effect into another effect slot, the side-chain connections are lost.
-

Side-Chain and Modulation

Side-chain signals bypass the built-in LFO modulation and apply modulation according to the envelope of the side-chain signal. Since each channel is analyzed and modulated separately, this allows for creating astonishing spatial modulation effects.

RELATED LINKS

[Side-Chain Routing](#) on page 344

[Triggering a Delay Effect with Side-Chain Signals](#) on page 343

[Triggering a Compressor with Side-Chain Signals](#) on page 344

[Creating Side-Chain Connections From Multiple Inputs](#) on page 346

Triggering a Delay Effect with Side-Chain Signals

You can use side-chain signals to create a ducking delay effect. This is useful if you want to apply a delay effect that is audible only when no signal is present on a track.

PROCEDURE

1. Select the audio track that contains the audio you want to delay.
2. Select **Project > Duplicate Tracks**.
The events on the duplicated track are only used to reduce the volume of the effect that is added to the original track.
3. Select the original track.
4. In the **Inspector**, open the **Inserts** section and select **Delay > PingPongDelay**, for example.
5. On the effect control panel, make your effect settings, and click **Activate/Deactivate Side-Chaining**.



6. Click **Set up Side-Chain Routing**.
 7. Click **Add Side-Chain Source**, and select the duplicate track from the selector.
 8. Optional: Adjust the send level in the **Level** value field.
 9. In the **Project** window, select the duplicate track.
 10. In the **Inspector**, click **Output Routing**, and select the side-chain node for the **PingPongDelay** effect.
-

RESULT

The signals from the duplicated track are routed to the effect. Every time the audio signals on the track set in, the delay effect is deactivated.

NOTE

To ensure that audio signals of low or medium volume also silence the delay effect, you can adjust the volume of the duplicated track.

RELATED LINKS

[Side-Chaining](#) on page 342

[Side-Chain Routing](#) on page 344

Triggering a Compressor with Side-Chain Signals

Compression, expansion, or gating can be triggered by side-chain signals exceeding a specified threshold. This allows you to lower the volume of one audio signal every time another audio signal sets in.

PREREQUISITE

You have set up a project with a bass guitar and a bass drum track, for example, and you want to lower the bass guitar volume each time the bass drum hits.

PROCEDURE

1. Select the bass guitar track.
 2. In the **Inspector**, open the **Inserts** section.
 3. Click the first effect slot, and, from the selector, select **Dynamics > Compressor**.
 4. On the effect control panel, make your effect settings, and click **Activate/Deactivate Side-Chaining**.
 5. On the effect control panel, click **Set up Side-Chain Routing**.
 6. Click **Add Side-Chain Source**, and select the bass drum track from the selector.
 7. Optional: Adjust the send level in the **Level** value field.
-

RESULT

You have connected the bass drum track side-chain to the **Compressor** on the destination track. The bass drum signal triggers the **Compressor** on the bass guitar track. When you now play back the project, the bass guitar is compressed whenever the signals on the bass drum track exceed the set threshold.

RELATED LINKS

[Side-Chaining](#) on page 342

[Side-Chain Routing](#) on page 344

Side-Chain Routing

The **Side-Chain Routing** panel allows you to set up the side-chain routing for the selected plug-in.

- To open the **Side-Chain Routing** panel, click **Set up Side-Chain Routing** on the plug-in control panel.

The following controls are available:

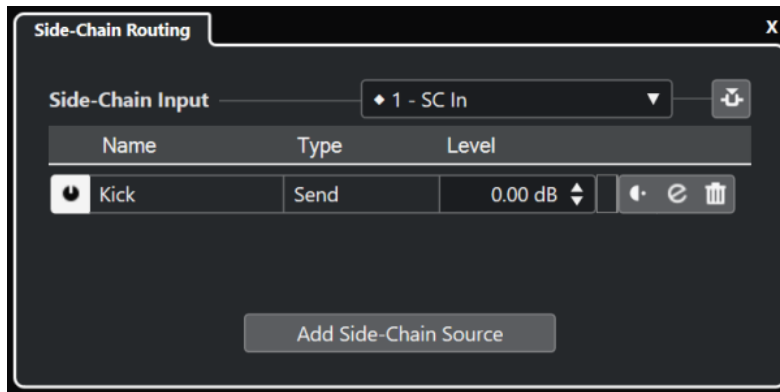

Select the Plug-in Side-Chain Input

This pop-up menu is only available if your plug-in supports several side-chain inputs. From the pop-up menu, select the input for which you want to add a side-chain source. Side-chain plug-in inputs that are routed to side-chain sources are indicated by a rhombus next to the input name. The number of available side-chain inputs depends on the plug-in.

Activate/Deactivate Side-Chaining

Activates/Deactivates the side-chain functionality.

Activate/Deactivate Side-Chain Source

Enables/Disables the side-chain source.

Name

Shows the name of the side-chain source.

Type

Shows the type of the side-chain source.

Level

Allows you to adjust the send level.

Meter

Shows the volume level of the input track.

Pre-/Post-Fader

Allows you to set the insert to pre-fader position or to post-fader position.

Edit Channel Settings

Opens the **Channel Settings** window for the selected side-chain source.

Remove Side-Chain Source

Removes the side-chain source.

Add Side-Chain Source

Opens a selector that allows you to add a side-chain source.

RELATED LINKS

[Side-Chaining](#) on page 342

[Creating Side-Chain Connections From Multiple Inputs](#) on page 346

Creating Side-Chain Connections From Multiple Inputs

For plug-ins that support multiple side-chain inputs, you can create side-chain connections coming from multiple side-chain inputs of that plug-in.

PREREQUISITE

You are using an effect plug-in that supports several side-chain inputs, such as the **Squasher** plug-in.

PROCEDURE

1. In the **Project** window, select an audio track.
2. In the track list, click **Edit Channel Settings**.
The **Channel Settings** window for the audio channel opens.
3. In the **Inserts** section, click the first insert slot on the **Inserts** tab, and, from the selector select the effect plug-in that supports several side-chain inputs.
The selected insert effect is loaded and activated, and the audio is routed through it. The effect control panel opens.
4. On the effect control panel, click **Set up Side-Chain Routing**.
5. In the **Side-Chain Routing** panel, click **Select the Plug-in Side-Chain Input**, and, from the pop-up menu, select the plug-in input for the side-chain source.
The number of available side-chain inputs depends on the plug-in.
6. Click **Add Side-Chain Source**, and select a source from the pop-up menu.
7. Optional: Repeat the steps above to activate more plug-in inputs.
8. Adjust the effect plug-in, as required and do not forget to activate the corresponding side-chain inputs.

RESULT

The number of possible side-chain inputs determines the number of bands that can be controlled by side-chain sources.

RELATED LINKS

[Side-Chaining](#) on page 342

[Side-Chain Routing](#) on page 344

Dither Effects

Dither effects allow you to control the noise produced by quantization errors that can occur when you mix down to a lower bit depth.

Dithering adds a special kind of noise at an extremely low level to minimize the impact of quantization errors. This is hardly noticeable and preferable to the distortion caused by the errors.

Applying Dither Effects

PROCEDURE

1. Select **Studio > MixConsole**.
2. Open the **Rack Settings**, and activate **Fixed Number of Slots**.

3. Click **Edit Channel Settings** for the output channel.
4. In the **Inserts** section, click a post-fader effect slot, and select **Mastering > UV22HR**.
5. On the plug-in panel, select a bit depth for the mixdown file you want to create.

RELATED LINKS

- [Export Audio Mixdown](#) on page 757
- [Rack Settings Menu](#) on page 290

Effect Control Panel

The effect control panel allows you to set up the effect parameters. The contents, design, and layout of the control panel depend on the selected effect.

- To open the control panel for a plug-in, click the effect slot.

The following controls are available for all effects:



- 1 **Activate Effect**
Activates/Deactivates the effect.
- 2 **Bypass Effect**
Allows you to bypass the effect.
- 3 **Read Automation/Write Automation**
Allows you to read/write automation for the effect parameter settings.
- 4 **Switch between A/B Settings**
Switches to setting B when setting A is active, and to setting A when setting B is active.
- 5 **Apply current settings to A and B**
Copies the effect parameters of effect setting A to effect setting B, and vice versa.
- 6 **Activate/Deactivate Side-Chaining**
Activates/Deactivates the side-chain functionality.
- 7 **Set up Side-Chain Routing**
Allows you to set up the side-chain routing for the selected plug-in.

8 Preset browser

Opens the preset browser, where you can select another preset.

9 Load previous Program/Load next Program

Loads the previous/next program in the preset browser.

10 Preset Management

Opens a pop-up menu that allows you to save or load a preset.

11 Add VST Plug-in Picture to Media Rack

Adds a picture of the VST plug-in to the **Media** rack. This is available for plug-ins of other vendors only.

12 Functions menu

Opens a pop-up menu with specific functions and settings.

13 Show/Hide VST Quick Controls

Shows/hides the quick controls.

14 Focus Quick Controls Lock State: Locked/Unlocked

Allows you to lock the focus of the quick control to the plug-in window.

15 Focus Quick Controls Indicator

If this indicator is lit, the plug-in window has the quick control focus.

NOTE

For detailed information about the included effects and their parameters, see the separate document **Plug-in Reference**.

RELATED LINKS

[Hiding/Showing Effect Control Panels](#) on page 350

Effect Control Panel Context Menu

The context menu and the **Functions** menu on the effect control panel display functions and settings that are specific to the effect.

Do one of the following:

- Right-click into an empty area of the effect control panel.
- Open the **Functions** pop-up menu on the effect control panel.

The following functions are available:

Copy <VST effect name> Setting/Paste <VST effect name> Setting

Allows you to copy the effect settings and to paste them to another effect.

Load Preset/Save Preset

Allows you to load/to save a preset.

Default Preset

Allows you to define and save a default preset.

Switch to A Setting/Switch to B Setting

Switches to setting B when setting A is active, and to setting A when setting B is active.

Apply Current Settings to A/Apply Current Settings to B

Copies the effect parameters of effect setting A to effect setting B, and vice versa.

Activate Outputs

Allows you to activate one or more outputs for the effect.

Activate/Deactivate Side-Chaining

Activates/Deactivates side-chaining for the effect.

NOTE

This option is only available for VST 3 effects that support side-chaining.

Remote Control Editor

Opens the **Remote Control Editor**.

Switch to Generic Editor

Opens the generic editor for the effect.

Allow Window to be Resized

Allows for dynamic resizing of third-party plug-in windows in Cubase. This is useful if you activated **Enable HiDPI** (Windows only) in the **Preferences** dialog (**General** page) and your plug-in does not support dpi settings.

NOTE

Allow Window to be Resized is a plug-in-specific setting. Activate/deactivate it for every plug-in that requires it.

RELATED LINKS

[General](#) on page 838

[Side-Chaining](#) on page 342

Fine-Tuning Effect Settings

You can take your effect parameter settings as a starting point for further fine-tuning and subsequent comparison of the new settings with the original settings.

PREREQUISITE

You have adjusted the parameters for an effect.

PROCEDURE

1. On the control panel for the effect, click **Switch between A/B Settings**.
This copies the initial parameter setting A to setting B.
 2. Fine-tune the effect parameters.
These parameter settings are now saved as setting B.
-

RESULT

You can now switch between both settings by clicking **Switch between A/B Settings**. You can compare them, make further adjustments or just go back to setting A. Settings A and B are saved with the project.

AFTER COMPLETING THIS TASK

You can copy the settings between A and B by clicking **Copy A to B**. These settings can serve as a starting point for further fine-tuning.

Hiding/Showing Effect Control Panels

When you add an audio effect, the respective plug-in control panel opens automatically. You can hide the control panels from view. This contributes to a better overview, in case you added a number of plug-ins to your project whose control panels clutter up the screen.

PROCEDURE

- Select **Window > Hide Plug-in Windows**.

NOTE

Hide Plug-in Windows also hides VST instrument control panels.

RESULT

The control panels are hidden and sent to the back of the application. To show them again, select **Show Plug-in Windows**.

RELATED LINKS

[Effect Control Panel](#) on page 347

Closing All Control Panels

When you add an audio effect, the respective plug-in control panel opens automatically. You can close all control panels at once.

PROCEDURE

- Select **Window > Close All Plug-in Windows**.

NOTE

Close All Plug-in Windows also closes VST instrument control panels.

RESULT

The control panels are closed.

RELATED LINKS

[Effect Control Panel](#) on page 347

Effect Presets

Effect presets store the parameter settings of an effect. The included effects feature a number of presets that you can load, adjust, and save.

The following effect preset types are available:

- VST presets for a plug-in are plug-in parameter settings for a specific effect.
- Insert presets that contain the whole insert effects rack with settings for each effect.

Effect presets are saved in the following location:

- Windows: `\Users\\My Documents\VST 3 Presets\\`
- macOS: `/Users/<user name>/Library/Audio/Presets/<company>/<plug-in name>`

RELATED LINKS

[Loading Presets for Effects](#) on page 351

[Loading Insert Presets](#) on page 354

Preset Browser

The preset browser allows you to select a VST preset for the loaded effect.

- To open the preset browser, click the preset browser field in the effect control panel.

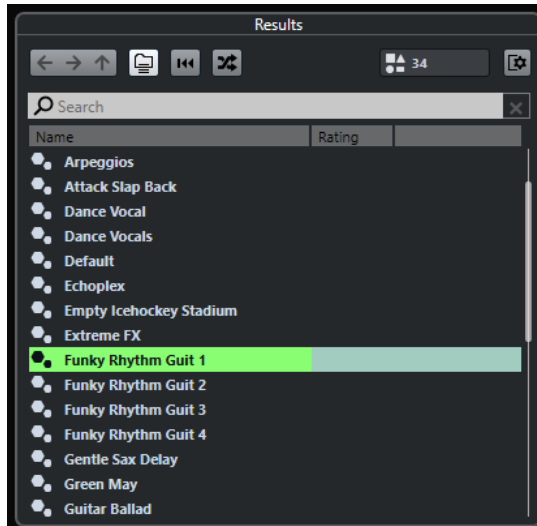

The **Results** section of the presets browser lists the available presets for the selected effect.

Loading Presets for Effects

Most VST effect plug-ins feature a number of useful presets that you can instantly select.

PREREQUISITE

You have loaded an effect, either as a channel insert or into an FX channel, and the effect control panel is open.

PROCEDURE

1. Click the preset browser field at the top of the control panel.



2. In the **Results** section, select a preset from the list.
3. Double-click to load the preset that you want to apply.

RESULT

The preset is loaded.

AFTER COMPLETING THIS TASK

To return to the preset that was selected when you opened the preset browser, click **Revert to Last Setting**.

Saving Effect Presets

You can save your effect settings as presets for further use.

PROCEDURE

1. Open the **Preset Management** pop-up menu.



2. Select **Save Preset**.

The **Save <plug-in name> Preset** dialog opens.

3. In the **New Preset** section, enter a name for the new preset.

4. Optional: Click **New Folder** to add a subfolder inside the effect preset folder.

5. Optional: Click **Show Attribute Inspector** in the bottom left corner of the dialog, and define attributes for the preset.

6. Click **OK**.

RESULT

The effect preset is saved.

Saving Default Effect Presets

You can save your effect parameter settings as default effect presets. This allows you to load your parameter settings automatically, every time you select the effect.

PROCEDURE

1. Open the **Preset Management** pop-up menu.



2. Select **Save as Default Preset**.

3. Click **Yes**.

RESULT

The effect settings are saved as default presets. Every time you load the effect, the default preset is loaded automatically.

Copying and Pasting Presets Between Effects

You can copy and paste effect presets between different instances of the same plug-in.

PROCEDURE

1. Open the control panel for the effect that you want to copy.

2. Right-click the control panel and select **Copy <plug-in name> Setting** from the context menu.

3. Open another instance of the same effect.
 4. Right-click the control panel, and select **Paste <plug-in name> Setting** from the context menu.
-

Saving Insert Presets

You can save the inserts for a channel as an inserts preset, including all parameter settings. Insert presets can be applied to audio, instrument, FX channel, or group tracks.

PREREQUISITE

You have loaded a combination of insert effects, and the effect parameters are set up for each effect.

PROCEDURE

1. Select the track.
2. In the **Inspector**, open the **Inserts** section.
3. On the **Inserts** tab, click **Preset Management**, and select **Save FX Chain Preset**.

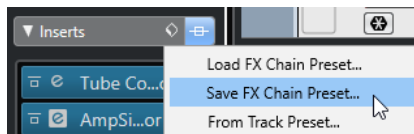

4. In the **Save FX Chain Preset** pane, enter a name for the new preset in the **New Preset** section.
 5. Click **OK**.
-

RESULT

The insert effects and their effect parameters are saved as insert presets.

Loading Insert Presets

You can load insert presets into audio, group, instrument, and FX channels.

PREREQUISITE

You have saved a combination of insert effects as insert presets.

PROCEDURE

1. Select the track to which you want to apply the new preset.
2. In the **Inspector**, open the **Inserts** section.
3. On the **Inserts** section, click **Preset Management** and select **Load FX Chain Preset**.
4. Select an insert preset.

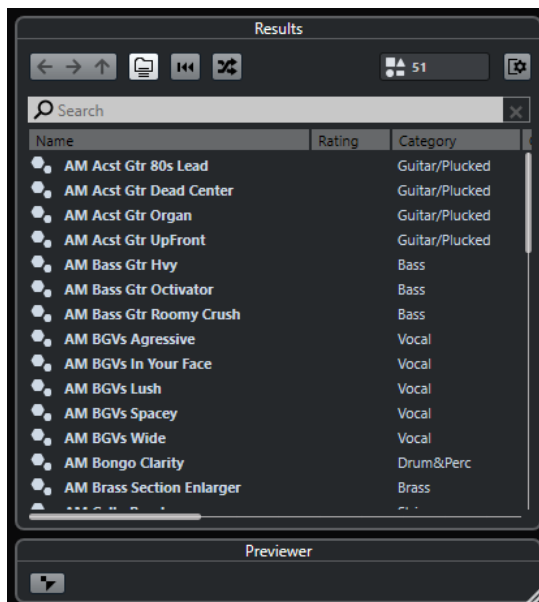

5. Double-click to apply the preset, and close the pane.
-

RESULT

The effects of the insert effect preset are loaded and any plug-ins that were previously loaded for the track are removed.

Loading Insert Effect Settings from Track Presets

You can extract the effects that are used in a track preset and load them into your inserts rack.

PROCEDURE

1. Select the track to which you want to apply the new preset.
 2. In the **Inspector**, open the **Inserts** section.
 3. On the **Inserts** tab, click **Preset Management** and select **From Track Preset**.
 4. In the track preset pane, select the preset that contains the insert effects you want to load.
 5. Double-click to load the effects and close the pane.
-

RESULT

The effects used in the track preset are loaded.

RELATED LINKS

[Track Presets](#) on page 148

System Component Information Window

The **System Component Information** window lists all available audio-codec plug-ins, program plug-ins, project import-export plug-ins, and the virtual file system plug-ins.

- To open the **System Component Information** window, select **Studio > More Options > System Component Information**.

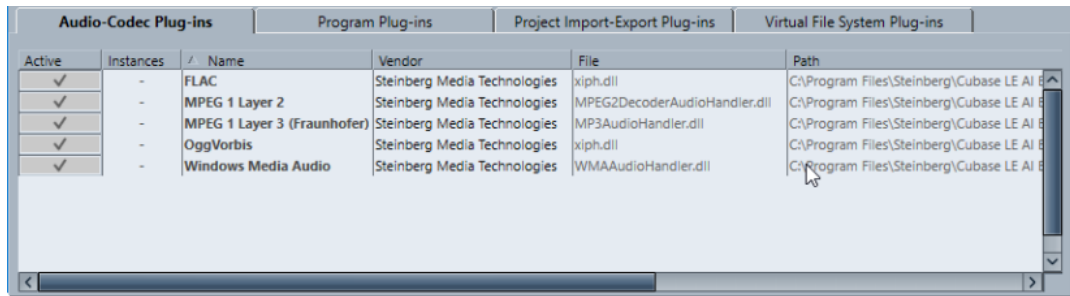

Audio-Codec Plug-ins		Program Plug-ins	Project Import-Export Plug-ins	Virtual File System Plug-ins	
Active	Instances	Name	Vendor	File	Path
<input checked="" type="checkbox"/>	-	FLAC	Steinberg Media Technologies	xiph.dll	C:\Program Files\Steinberg\Cubase LE AI B
<input checked="" type="checkbox"/>	-	MPEG 1 Layer 2	Steinberg Media Technologies	MPEG2DecoderAudioHandler.dll	C:\Program Files\Steinberg\Cubase LE AI B
<input checked="" type="checkbox"/>	-	MPEG 1 Layer 3 (Fraunhofer)	Steinberg Media Technologies	MP3AudioHandler.dll	C:\Program Files\Steinberg\Cubase LE AI B
<input checked="" type="checkbox"/>	-	OggVorbis	Steinberg Media Technologies	xiph.dll	C:\Program Files\Steinberg\Cubase LE AI B
<input checked="" type="checkbox"/>	-	Windows Media Audio	Steinberg Media Technologies	WMAAudioHandler.dll	C:\Program Files\Steinberg\Cubase LE AI B

The following columns are available:

Active

Allows you to activate or deactivate a plug-in.

Instances

The number of plug-in instances that are used in Cubase.

Name

The name of the plug-in.

Vendor

The manufacturer of the plug-in.

File

The name of the plug-in, including its file name extension.

Path

The path on which the plug-in file is located.

Category

The category of each plug-in.

Version

The version of the plug-in.

SDK

The version of the VST protocol that is compatible with the plug-in.

Managing System Components in the System Component Information Window

- To make a plug-in available for selection, activate the checkbox in the left column. Only activated plug-ins appear in the effect selectors.
- To see where a plug-in is used, click in the **Instances** column.

NOTE

A plug-in may be in use, even if it is not activated in the left column. The left column only determines whether or not the plug-in is visible on the effect selectors.

Exporting System Component Information Files

For archiving purposes or troubleshooting, you can save system component information as an XML file.

- The system component file contains information on the installed/available plug-ins, their version, vendor, etc.
- The XML file can be opened in any editor application that supports the XML format.

NOTE

The export function is not available for program plug-ins.

PROCEDURE

1. In the **System Component Information** window, right-click in the middle of the window, and select **Export**.
 2. In the dialog, specify a name and a location for the export file.
 3. Click **Save** to export the file.
-

Direct Offline Processing

Direct Offline Processing allows you to instantly add audio processes to the selected audio events, clips, or ranges, without destroying the original audio.

Applying offline effects is common practice in dialogue editing and sound design. Offline processing has several advantages over applying real-time mixer effects:

- The workflow is clip-based. This allows you to apply different effects to events on the same track.
- The **MixConsole** can be kept clean from insert effects and parameter changes. This facilitates subsequent mixing by another person, on a different system.
- Less CPU load is used.

Direct Offline Processing allows you to undo any changes regarding audio processes. You can always revert to the original version. This is possible because processing does not affect the actual audio files.

If you process an event, a clip, or a selection range, the following happens:

- A new audio file is created in the **Edits** folder within your project folder. This file contains the processed audio, and the processed section of the audio clip refers to it.
- The original file remains unaffected. The unprocessed sections still refer to it.

All applied offline processing is saved with the project and can still be modified after reopening the project. **Direct Offline Processing** operations on the selected audio are persistent in project backups.

Processing is always applied to the selection. The selection can include one or multiple events in the **Project** window or in the **Audio Part Editor**, an audio clip in the **Pool**, or a selection range on one or multiple events in the **Project** window or in the **Sample Editor**. If a selection is shorter than the audio file, only the selected range is processed.

If you select an event that is a shared copy and therefore refers to a clip that is used by other events in the project, you can decide how to proceed:

- Select **Continue** to process all shared copies.
- Select **New Version** to process the selected event only.

NOTE

This only works if **Open Options Dialog** is selected for the **On Processing Shared Clips** setting in the **Preferences** dialog (**Editing—Audio** page).

RELATED LINKS

[Modifying Processes](#) on page 362

[Editing - Audio](#) on page 829

[Direct Offline Processing Workflow](#) on page 359

[Direct Offline Processing Window](#) on page 359

Direct Offline Processing Workflow

You can perform offline processing operations in the **Direct Offline Processing** window. The window always shows the processing of the selected audio.

When you add or modify offline processing, the following applies:

- If you add a process, its last used parameter settings are loaded. You can reset it to its default settings by clicking **Reset to Default Values**.
- All changes are instantly applied to the audio.
- If you modify parameters or remove processing, these changes are instantly applied to the audio.
- You get a visual feedback while a process is running.

NOTE

You can add, modify, or delete audio processes at any time, even if a process is running. A new rendering process is instantly started.

- You can undo and redo all **Direct Offline Processing** operations by using **Ctrl/Cmd - Z** or **Shift - Ctrl/Cmd - Z**.
- You can apply all offline processing permanently to the audio.
- If you load a project with offline processing of audio processes that are not available on your computer, these processes are shown as **Not available** in the **Direct Offline Processing** window.

RELATED LINKS

[Direct Offline Processing Window](#) on page 359

[Key Commands for Direct Offline Processing](#) on page 368

Direct Offline Processing Window

The **Direct Offline Processing** window allows you to add, modify, or delete audio processing instantly for one or multiple events, clips, or selection ranges in one window. Furthermore, you can undo any audio processing.

To open the **Direct Offline Processing** window, do one of the following:

- Select **Audio > Direct Offline Processing**.
- Press **F7**.
- On the **Project** window toolbar, click **Open Direct Offline Processing Window**.
- Select **Audio > Processes**, and, from the submenu, select a process.

NOTE

Processes without adjustable parameter settings, such as **Silence**, do not open the **Direct Offline Processing** window when applied from the menu or using a key command.

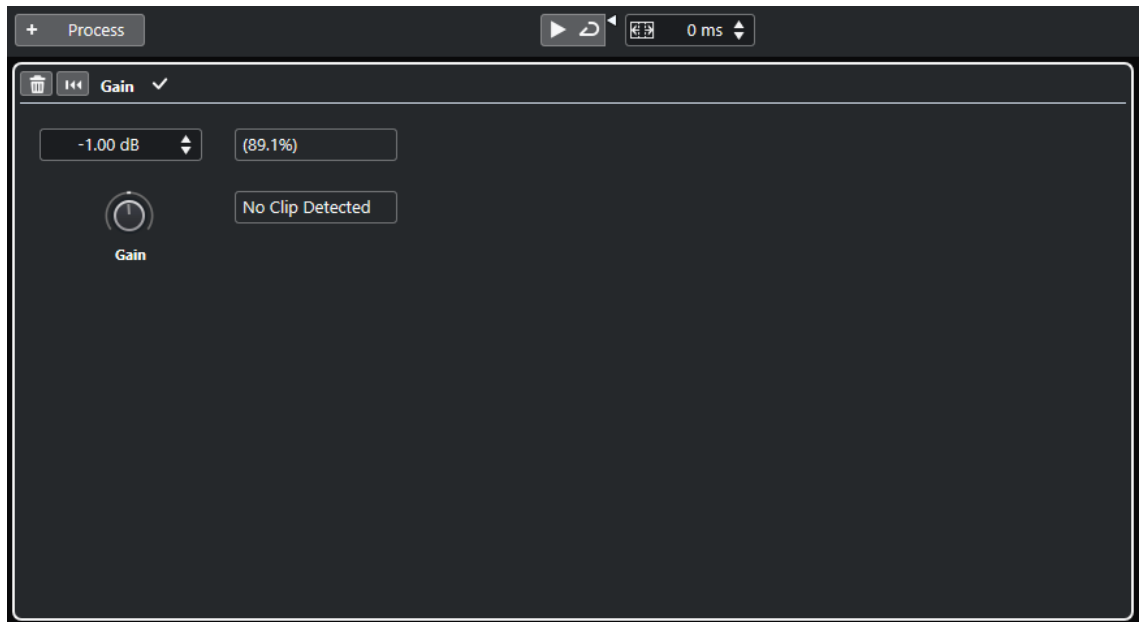

In the **Direct Offline Processing** window, the following options and settings are available:

Toolbar

Allows you to add audio processing, to audition the audio with the current edits, and to make global settings for offline processing.

Process panel

Shows the last added process and allows you to modify or reset its settings, or to delete it.

RELATED LINKS

[Applying Processing](#) on page 361

[Applying Processing to Multiple Events](#) on page 362

[Direct Offline Processing Toolbar](#) on page 360

Direct Offline Processing Toolbar

The **Direct Offline Processing** toolbar allows you to add audio processing, to audition the audio with the current edits, and to make global settings for offline processing.

On the toolbar, the following options and settings are available:

Add Processes

Add Process

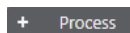

Allows you to add a built-in audio process to the selected event or clip.

Left Divider

Left Divider

Tools that are placed to the left of the divider are always shown.

Audition

Audition



Allows you to audition the selected audio with all processing from the top of the process list to the selected process in the list. All processes below are ignored during playback.

Audition Loop



Loops the playback until you deactivate the **Audition** button.

Audition Volume



Allows you to adjust the volume.

Process Range

Extend Process Range in ms



Allows you to extend the process range beyond the left and right event borders. This allows you to enlarge the event later while retaining the processing that has been applied.

RELATED LINKS

[Process Range Extension](#) on page 362

Applying Processing

You can add processing to one or multiple events, clips, or ranges in the **Direct Offline Processing** window. This includes audio processes and **Sample Editor** operations, such as **Cut**, **Paste**, **Delete**, and using the **Draw** tool.

PROCEDURE

1. Do one of the following:
 - Select an event or a range in the **Project** window.
 - Select a clip in the **Pool**.
 - Select a range in the **Sample Editor**.
 - Select an event or a range in the **Audio Part Editor**.
2. Select **Audio > Direct Offline Processing**.
3. On the **Direct Offline Processing** toolbar, click **Add Process** and select an audio process. The selected audio process is added to process list in the left zone.
4. Activate **Audition**, and make your changes on the process panel.

You get a visual feedback while a process is running. However, even if the processing is not finished, you can activate **Audition** at any time.

RESULT

The audio process is rendered into the audio.

In the **Project** window, the **Pool** or the **Audio Part Editor**, a waveform symbol is displayed for the processed events.

Applying Processing to Multiple Events

Direct Offline Processing allows you to add the built-in audio processes to multiple events at once. You can also modify or delete processing on multiple events simultaneously.

- To apply audio processes to multiple events, select the audio and add, modify, or delete the processing.

NOTE

In the **Direct Offline Processing** window, you can also edit the audio processing of multiple clips in the **Pool** simultaneously.

RELATED LINKS

[Built-In Audio Processes](#) on page 363

[Direct Offline Processing Window](#) on page 359

Process Range Extension

You can extend the process range over the left and the right borders of the audio event.

When adding processing to an event, by default, only the part of the audio clip that corresponds to the event is processed. If you extend the process range, a specified additional range of the clip before and after the event borders is also processed. This allows you to enlarge the event, even after applying the processing.

- To extend the process range, click in the **Extend Process Range in ms** field on the **Direct Offline Processing** toolbar, and specify a value in milliseconds.

NOTE

- For this to work, audio must be available outside the event borders.
 - This setting works globally for all events.
-

Modifying Processes

You can delete or modify some or all processing from a clip in the **Direct Offline Processing** window. This includes the audio processes on the **Processes** pop-up menu and **Sample Editor** operations, such as **Cut**, **Paste**, **Delete**, and drawing with the **Draw** tool.

PROCEDURE

1. Do one of the following:
 - Select the processed event in the **Project** window or in the **Audio Part Editor**.

NOTE

In the **Project** window or in the **Audio Part Editor**, processed events are indicated by a waveform symbol in the upper right corner.

- Select the processed clip from the **Pool**.

NOTE

In the **Pool**, processed clips are indicated by a waveform symbol in the **Status** column.

- Select the processed range in the **Sample Editor**.

2. Select **Audio > Direct Offline Processing**.
 3. Do one of the following:
 - Activate **Audition**, and modify the settings of the process.
 - Reset the process to its default settings by clicking **Reset to Default Values**.
 - Delete the process by clicking **Delete**  on the process panel.
-

RELATED LINKS

- [Direct Offline Processing Window](#) on page 359
- [Pool Window Columns](#) on page 448

Built-In Audio Processes

Cubase provides several built-in audio processes that can be used for **Direct Offline Processing**.

Envelope

Envelope allows you to apply a volume envelope to the selected audio.



Curve Type buttons

Determine whether the corresponding envelope uses **Spline Interpolation**, **Damped Spline Interpolation**, or **Linear Interpolation**.

Envelope display

Shows the shape of the envelope. The resulting waveform shape is shown in a dark tone, while the current waveform shape is displayed in a light tone.

- To add a curve point, click the curve.
- To move a curve point, click and drag.
- To remove a curve point, click and drag it outside the display.

Presets pop-up menu

Allows you to manage your presets.

- To save a preset, select **Save Preset** from the pop-up menu, enter a name, and click **OK**.
- To apply a preset, select it from the pop-up menu.
- To remove a preset, select it from the pop-up menu, and click **Remove Preset**.

Fade In/Fade Out

Fade In and **Fade Out** allow you to apply a fade to the selected audio.

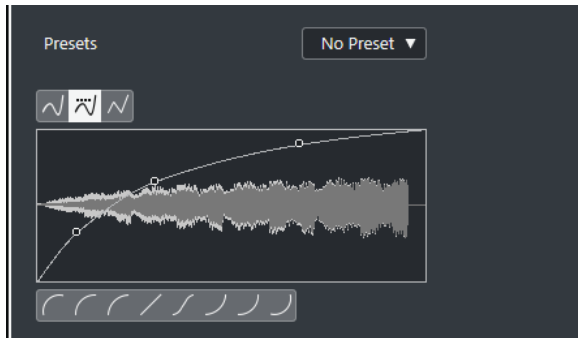

Curve Type buttons

Determine whether the corresponding envelope uses **Spline Interpolation**, **Damped Spline Interpolation**, or **Linear Interpolation**.

Fade display

Shows the shape of the fade curve. The resulting waveform shape is shown in a dark tone, while the current waveform shape is displayed in a light tone.

- To add points, click the curve.
- To change the curve shape, click and drag existing points.
- To remove a point from the curve, drag it outside the display.

Presets pop-up menu

Allows you to manage your presets.

- To save a preset, select **Save Preset** from the pop-up menu, enter a name, and click **OK**.
- To apply a preset, select it from the pop-up menu.
- To remove a preset, select it from the pop-up menu, and click **Remove Preset**.

Curve Shape buttons

These buttons give you quick access to some common curve shapes.

Gain

Gain allows you to change the gain, that is, the level of the selected audio.

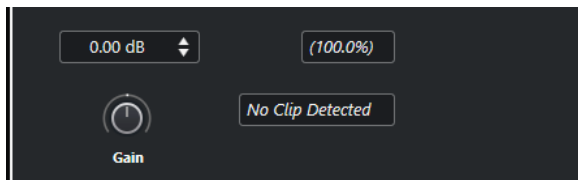

Gain

Allows you to set a gain value between -50 dB and +20 dB.

Clipping Detection text

This text is displayed if you use **Audition** and the gain setting results in audio levels above 0 dB.

NOTE

In case of clipping, lower the **Gain** value, and use the **Normalize** audio process instead. This allows you to increase the level of the audio to the highest extent possible without causing clipping.

RELATED LINKS

[Normalize](#) on page 365

Invert Phase

Invert Phase allows you to invert the phase of the selected audio.

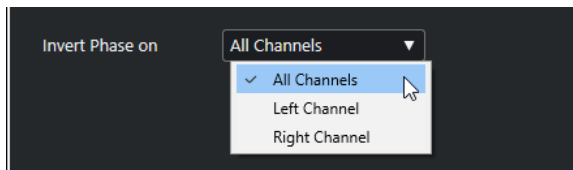

For stereo audio files, a pop-up menu is available. It allows you to specify which channels are phase-inverted: the left channel, the right channel, or both.

Normalize

Normalize allows you to raise or lower the level of audio that was recorded at an inappropriate input level.

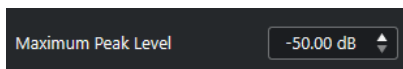

Maximum Peak Level

Allows you to normalize your audio based on the maximum peak level. **Maximum Peak Level in dBFS** sets a maximum peak level for the audio, between -50 dB and 0 dB. The current maximum level of the selected audio is subtracted from this maximum level, and the gain is raised or lowered by the resulting amount.

Remove DC Offset Option

Remove DC Offset allows you to remove any DC offset in the audio selection.

If your audio signal contains too large a component of direct current, you may notice that it is not centered around the zero level axis. This is called DC offset.

- To verify if your audio contains DC offsets, select the audio, and select **Audio > Statistics**.

IMPORTANT

DC offset is normally present throughout the entire recording. Therefore, always apply **Remove DC Offset** to complete audio clips.

There are no adjustable parameters for this audio process.

RELATED LINKS

[Statistics Window](#) on page 378

Resample

Resample allows you to change the length, tempo, and pitch of an event.

If you resample to a higher sample rate, the event gets longer, and the audio plays back at a slower speed, with a lower pitch. If you resample to a lower sample rate, the event gets shorter, and the audio plays back at a faster speed, with a higher pitch.

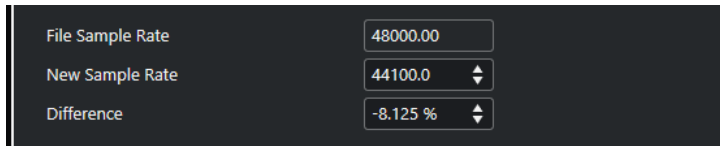

File Sample Rate

Shows the original sample rate of the event.

New Sample Rate

Allows you to resample the event by specifying a sample rate.

Difference

Allows you to resample the event by specifying the difference between the original sample rate and the new sample rate.

Reverse

Reverse allows you to reverse the audio selection so that it sounds as if you play a tape backwards. There are no adjustable parameters for this audio process.

Silence

Silence allows you to replace the selection with silence. There are no adjustable parameters for this audio process.

Stereo Flip

Stereo Flip allows you to manipulate the left and the right channels of stereo audio selections.

In the **Mode** pop-up menu, the available options are:

Flip Left-Right

Swaps the left and right channel.

Left to Stereo

Copies the left channel sound to the right channel.

Right to Stereo

Copies the right channel sound to the left channel.

Merge

Merges both channels on each side for mono sound.

Subtract

Subtracts the left channel information from the right. This function is typically used for karaoke background as it removes the centered mono material from a stereo signal.

Time Stretch

Time Stretch allows you to change the length and the tempo of the selected audio without affecting the pitch.

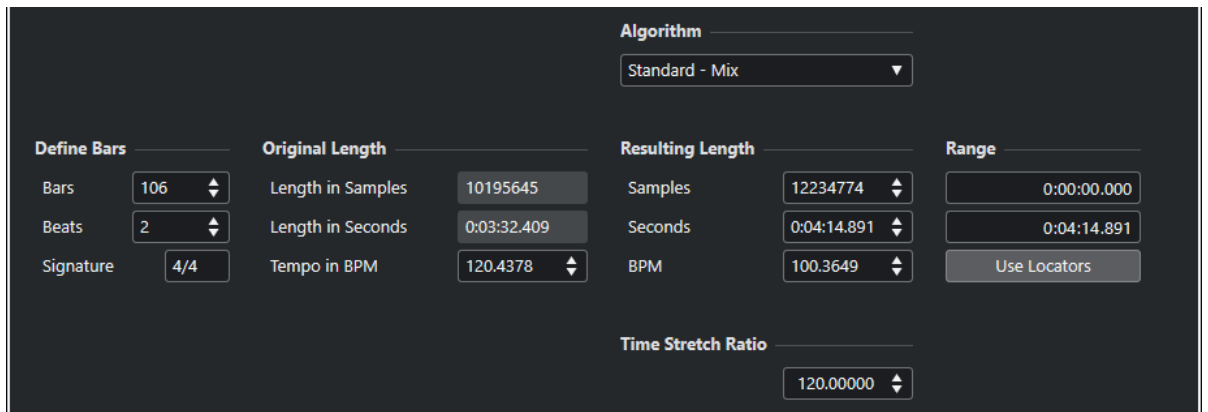

Define Bars

You can set the length of the selected audio and the time signature in this section.

Bars

Allows you to set the length of the selected audio in bars.

Beats

Allows you to set the length of the selected audio in beats.

Signature

Allows you to set the time signature.

Original Length

This section contains information and settings regarding the audio that is selected for processing.

Length in Samples

Shows the length of the selected audio in samples.

Length in Seconds

Shows the length of the selected audio in seconds.

Tempo in BPM

Allows you to enter the actual tempo of the audio in beats per minute. This option allows you to time-stretch the audio to another tempo, without having to compute the actual time stretch amount.

Resulting Length

These values change automatically if you adjust the **Time Stretch Ratio** to stretch the audio so that it fits within a specific time span or tempo.

Samples

Shows the resulting length in samples.

Seconds

Shows the resulting length in seconds.

BPM

Shows the resulting tempo in beats per minute. For this to work, the **Original Length** values must be specified.

Range

These settings allow you to set a range for the time stretch.

Arbitrary Range Start Time

Allows you to set a start position for the range.

Arbitrary Range End Time

Allows you to set an end position for the range.

Use Locators

Allows you to set the **Range** values to the left and right locator positions, respectively.

Algorithm

Allows you to select a time stretch algorithm.

Time Stretch Ratio

Allows you to set the amount of time stretch as a percentage of the original length. If you use the settings in the **Resulting Length** section to specify the amount of time stretch, this value changes automatically.

RELATED LINKS

[Time Stretch Algorithms](#) on page 370

Key Commands for Direct Offline Processing

You can apply offline processing by using key commands.

If you add audio processes via key commands, the following applies:

- The current settings are used.
- The **Direct Offline Processing** window opens. This does not apply if the selected process does not feature any adjustable parameters or if the window is in the background or minimized.
- You can apply offline processing by using key commands, even with **Auto Apply** deactivated.

If the corresponding section in the **Direct Offline Processing** window has the focus, the following default key commands apply:

Option	Key command
Open/Close Direct Offline Processing window	F7
Set focus within Direct Offline Processing window	Tab
Navigate in the process list	Up Arrow / Down Arrow

Option	Key command
--------	-------------

Activate/Deactivate Audition (Playback Toggle triggers Local Preview must be activated in the Preferences dialog)	Space
--	--------------

Undo	Ctrl / Cmd - Z
------	-----------------------

To define key commands for further **Direct Offline Processing** operations, and for directly adding particular audio processes, use the **Key Commands** dialog.

RELATED LINKS

[Direct Offline Processing Window](#) on page 359

[Transport](#) on page 845

[Key Commands](#) on page 801

Time Stretch Algorithms

In Cubase, time stretching algorithms are used for operations like the **Time Stretch** offline process, or in the **Sample Editor**.

NOTE

MPEX algorithms are not supported on Apple silicon-based computers.

RELATED LINKS

[Time Stretch](#) on page 367

[Sample Editor](#) on page 380

[Standard](#) on page 370

[Limitations](#) on page 371

Standard

The **Standard** algorithm is optimized for CPU-efficient realtime processing.

The following presets are available:

Standard – Drums

For percussive sounds. This mode does not change the timing of your audio. If you use it with certain tuned percussion instruments, you may experience audible artifacts. In this case, try **Mix** mode as an alternative.

Standard – Plucked

For audio with transients and a relatively stable spectral sound character like plucked instruments.

Standard – Pads

For pitched audio with slower rhythm and a stable spectral sound character. This minimizes sound artifacts, but the rhythmic accuracy is not preserved.

Standard – Vocals

For slower signals with transients and a prominent tonal character like vocals.

Standard – Mix

For pitched material with a less homogenous sound character. This mode preserves the rhythm and minimizes the artifacts.

Standard – Custom

Allows you to set the time-stretching parameters manually.

Standard – Solo

For monophonic material like solo woodwind/brass instruments or solo vocals, monophonic synths or string instruments that do not play harmonies. This mode preserves the timbre of the audio.

Custom Warp Settings

If you select the **Standard – Custom** mode, a dialog opens where you can manually adjust the parameters that govern the sound quality of the time stretching:

Grain Size

Allows you to determine the size of the grains into which the standard time-stretching algorithm splits the audio. Low grain size values lead to good results for material that has many transients.

Overlap

This is the percentage of the whole grain that will overlap with other grains. Use higher values for material with a stable sound character.

Variance

This is the percentage of the whole length of the grains, and it sets a variation in positioning, so that the overlapping area sounds smooth. A variance setting of 0 produces a sound akin to the time stretching used in early samplers, whereas higher settings produce more rhythmic smearing effects but fewer audio artifacts.

Limitations

Applying time stretching to audio material can lead to a degradation in audio quality and to audible artifacts. The result depends on the source material, the particular stretch operations applied, and the selected audio algorithm preset.

As a rule of thumb, smaller changes in duration cause less degradation. However, there are additional issues one should be aware of when working with time stretching algorithms.

NOTE

In rare cases, editing warped audio events may cause discontinuities at the edit points. You can then try to move the edit point to a different position or bounce the audio event prior to editing.

Reverse Playback and Scrubbing

Most of the algorithms used for time stretching only support forward playback. Reverse playback or scrubbing of warped audio events can lead to recurring artifacts in playback.

Stretch Factor

Some algorithms may put limitations on the maximum degree of time stretching supported.

Audio Functions

Cubase offers particular functions for analyzing the audio in your project.

RELATED LINKS

[Detect Silence Dialog](#) on page 372

[Spectrum Analyzer Window](#) on page 376

[Statistics Window](#) on page 378

Detect Silence Dialog

The **Detect Silence** dialog allows you to search for silent sections in events. You can split events and remove the silent parts from the project, or create regions corresponding to the non-silent sections.

- To open the **Detect Silence** dialog for a selected audio event, clip, or selection range, select **Audio > Advanced > Detect Silence**.

NOTE

If you select multiple events, you can process the selected events successively with individual settings or apply the same settings to all selected events simultaneously.



The following options are available:

Waveform display

Shows the waveform of the selected audio and allows you to preview the analyzed audio before it is processed.

When you move the mouse over the waveform, the mouse pointer changes to a speaker icon. Click the waveform, and hold to play back the audio from this position. The **Preview** slider allows you to set the preview level. **Mute Gaps** mutes sections that are detected as silence when previewing.

- To zoom in and out of the waveform, use the zoom slider to the right, or hold **Ctrl/Cmd** and use the mouse wheel.
- To scroll the waveform, use the scrollbar or the mouse wheel.
- To adjust the **Open Threshold** and **Close Threshold** values, move the squares at the beginning and at the end of the audio file.

The **Detection** section features the following options:

Open Threshold

When the audio level exceeds this value, the function opens and lets the sound pass. Audio material below the set level is detected as silence.

NOTE

This setting is only available if **Peak Level Mode** is activated.

Close Threshold

When the audio level drops below this value, the function closes and detects sounds below this level as silence. This value cannot be higher than the **Open Threshold** value.

NOTE

This setting is only available if **Peak Level Mode** is activated.

Linked

Activate this option to set the same values for **Open Threshold** and **Close Threshold**.

NOTE

This setting is only available if **Peak Level Mode** is activated.

Minimum Time Open

Determines the minimum time that the function lets the sound pass. If your audio contains repeated short sounds and this results in too many short open sections, try raising this value.

Minimum Time Closed

Determines the minimum time that the function remains closed after detecting silence. Set this to a low value to make sure that you do not remove sounds.

Pre-roll

Causes the function to open slightly before an open section. Use this option to avoid removing the attack of sounds.

Post-roll

Causes the function to close slightly after an open section. Use this option to avoid removing the natural decay of sounds.

The **Result** section features the following options:

Number of Sections

Shows the number of events that are created if you click **Process**.

Add as Regions

Creates regions of the non-silent sections.

Region Name

Allows you to specify a name for the non-silent sections.

Auto Number Start

Allows you to specify the start number for the numbers that are automatically appended to the region names.

Strip Silence

Splits the event at the beginning and at the end of each non-silent section and removes the silent sections in between.

Process All Selected Events

Applies the same settings to all selected events. This option is only available if you selected more than one event.

Apply Fades

Applies fade ins and fade outs of the set length to the resulting events.

Analyze

Analyzes the audio event and redraws the waveform display to indicate which sections are considered silent.

Auto

Activate this option to analyze the audio event and to update the display automatically every time you change the settings.

NOTE

If you are working with very long files, consider deactivating the **Auto** option, as this may slow down the process.

Process

Processes the audio according to your settings.

RELATED LINKS

[Removing Silent Sections](#) on page 375

Removing Silent Sections

The **Detect Silence** dialog allows you to detect and remove silent sections of your audio.

PROCEDURE

1. Select one or multiple audio events in the **Project** window.
 2. Select **Audio > Advanced > Detect Silence**.
 3. In the **Detect Silence** dialog, make your changes.
 4. Click **Analyze** to analyze the audio.
The audio is analyzed, and the waveform is redrawn to indicate which sections are considered silent according to your settings. The number of detected regions is displayed.
 5. Optional: Click and hold the waveform display to preview the result.
If **Mute Gaps** is activated, silent sections are muted during preview.
 6. Optional: In the **Detection** section, readjust the settings until you are satisfied with the result.
 7. Optional: In the **Result** section, activate **Add as Regions**.
 8. In the **Result** section, activate **Strip Silence**.
 9. Click **Process**.
-

RESULT

The event is split and the silent sections are removed.

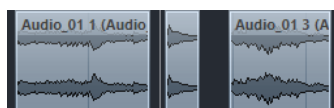

AFTER COMPLETING THIS TASK

- If you have selected more than one event and did not activate **Process All Selected Events**, the **Detect Silence** dialog opens again after processing, allowing you to make separate settings for the next event.

RELATED LINKS

[Detect Silence Dialog](#) on page 372

Spectrum Analyzer Window

The **Spectrum Analyzer** window displays the audio spectrum of an event, clip, or selection range as a two-dimensional graph, with frequency range on the x-axis and level distribution on the y-axis.

- To open the **Spectrum Analyzer** window for a selected audio event, clip, or selection range, select **Audio > Spectrum Analyzer**.

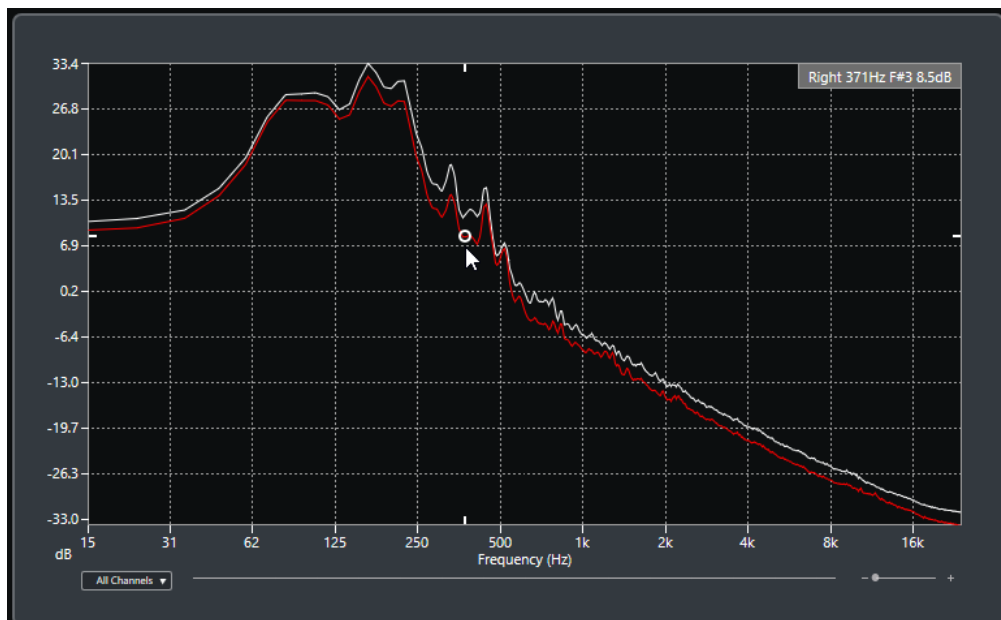

Frequency display

Shows the frequency graphs for the analyzed audio.

If you hover the mouse pointer over a certain position, the channel, frequency, note, and level at that position are shown in the value field at the top of the display.

Channel selector

For multi-channel audio, this pop-up menu allows you to select which channels are shown in the frequency display.

Zoom slider

Allows you to zoom in and out horizontally.

RELATED LINKS

[Analyzing the Audio Spectrum](#) on page 377

Analyzing the Audio Spectrum

The **Spectrum Analyzer** allows you to analyze the audio of a selected event, clip, or selection range.

PROCEDURE

1. Select an audio event, clip, or a selection range.
 2. Select **Audio > Spectrum Analyzer**.
-

RESULT

The audio spectrum of the selected event, clip, or selection range is displayed as a two-dimensional graph in the **Spectrum Analyzer** window.

AFTER COMPLETING THIS TASK

You can display the difference in level between two positions on the same or on different graphs.

RELATED LINKS

[Comparing Level Values](#) on page 377

Comparing Level Values

You can display the difference in level between two positions on the same or on different graphs in the **Spectrum Analyzer** window.

PROCEDURE

1. Move the mouse pointer to the first position and right-click to select it.
 2. Move the mouse pointer to the second frequency position.
-

RESULT

The difference in level between the positions is displayed as value **D** in the value field.

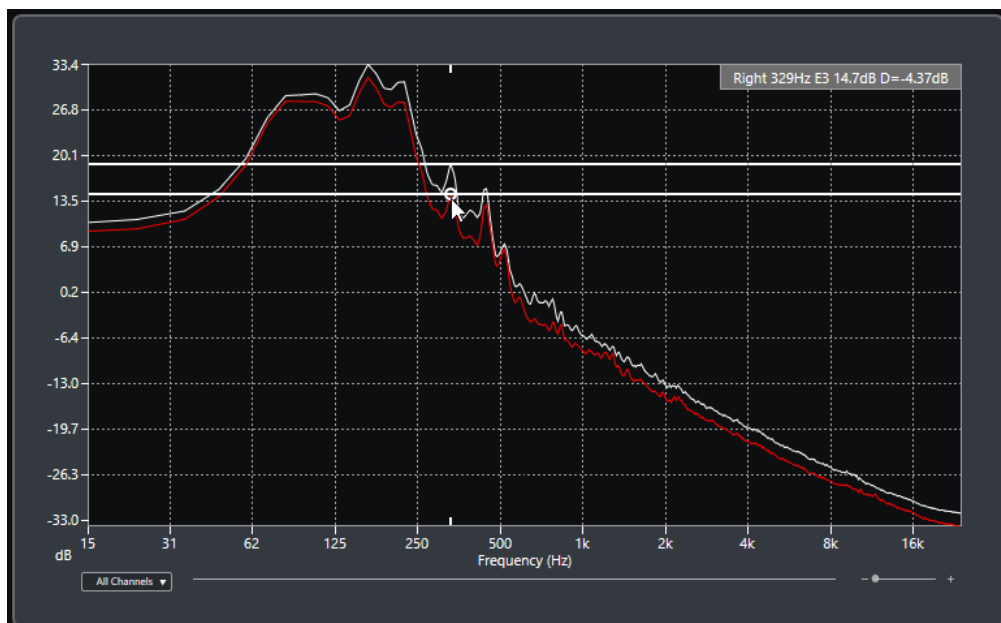

AFTER COMPLETING THIS TASK

Click the frequency display to reset the selection of the first position.

RELATED LINKS

[Spectrum Analyzer Window](#) on page 376

Statistics Window

The **Statistics** function analyzes the selected audio events, clips, or selection ranges.

- To open the **Statistics** window for a selected audio event, clip, or selection range, select **Audio > Statistics**.



Channel	Left	Right
Min. Sample Value	-0.35 dB	-3.73 dB
Max. Sample Value	-2.43 dB	-6.52 dB
Peak Amplitude	-0.35 dB	-3.73 dB
True Peak	-0.35 dB	-3.70 dB
DC Offset	0.00 %	0.00 %
	-∞ dB	-∞ dB
Bit Depth	24 bit	24 bit
Estimated Pitch	1499.8Hz/F#5	1554.1Hz/G5
Sample Rate	44.100 kHz	
Average RMS (AES-17)	-15.47 dB	-18.44 dB
Max. RMS	-14.77 dB	-17.71 dB
Max. RMS All Channels	-14.77 dB	

Copy to Clipboard Close

The **Statistics** window shows the following information:

Channel

Shows the name of the analyzed channel.

Min. Sample Value

Shows the lowest sample value in dB.

Max. Sample Value

Shows the highest sample value in dB.

Peak Amplitude

Shows the largest amplitude in dB.

True Peak

Shows the maximum absolute level of the audio signal waveform in the continuous time domain.

DC Offset

Shows the amount of DC offset as a percentage and in dB.

Bit Depth

Shows the current calculated bit depth.

Estimated Pitch

Shows the estimated pitch.

Sample Rate

Shows the sample rate.

Average RMS (AES17)

Shows the average loudness, in accordance with the AES17 standard.

Max. RMS

Shows the highest RMS value.

Max. RMS All Channels

Shows the highest RMS value of all channels.

RELATED LINKS

[Remove DC Offset Option](#) on page 365

Sample Editor

The **Sample Editor** provides an overview of the selected audio event. It allows you to view and edit audio by cutting and pasting, removing, or drawing audio data, as well as by processing audio. Editing is non-destructive so that you can undo modifications at any time.

You can open the **Sample Editor** in a separate window or in the lower zone of the **Project** window. This is useful if you want to access the **Sample Editor** functions from within a fixed zone of the **Project** window.

To open an audio event in the **Sample Editor**, do one of the following:

- Double-click an event in the **Project** window.
- Select an event in the **Project** window, and press **Return** or **Ctrl/Cmd - E**.
- Select an event in the **Project** window, and select **Audio > Open Sample Editor**.
- In the **Key Commands** dialog in the **Editors** category, assign a key command for **Open Sample Editor**. Select an event in the **Project** window, and use the key command.

NOTE

If you select **Audio > Set up Editor Preferences**, the **Preferences** dialog opens on the **Editors** page. Make your changes to specify if you want the **Sample Editor** to open in a separate window or in the lower zone of the **Project** window.

The **Sample Editor** window:

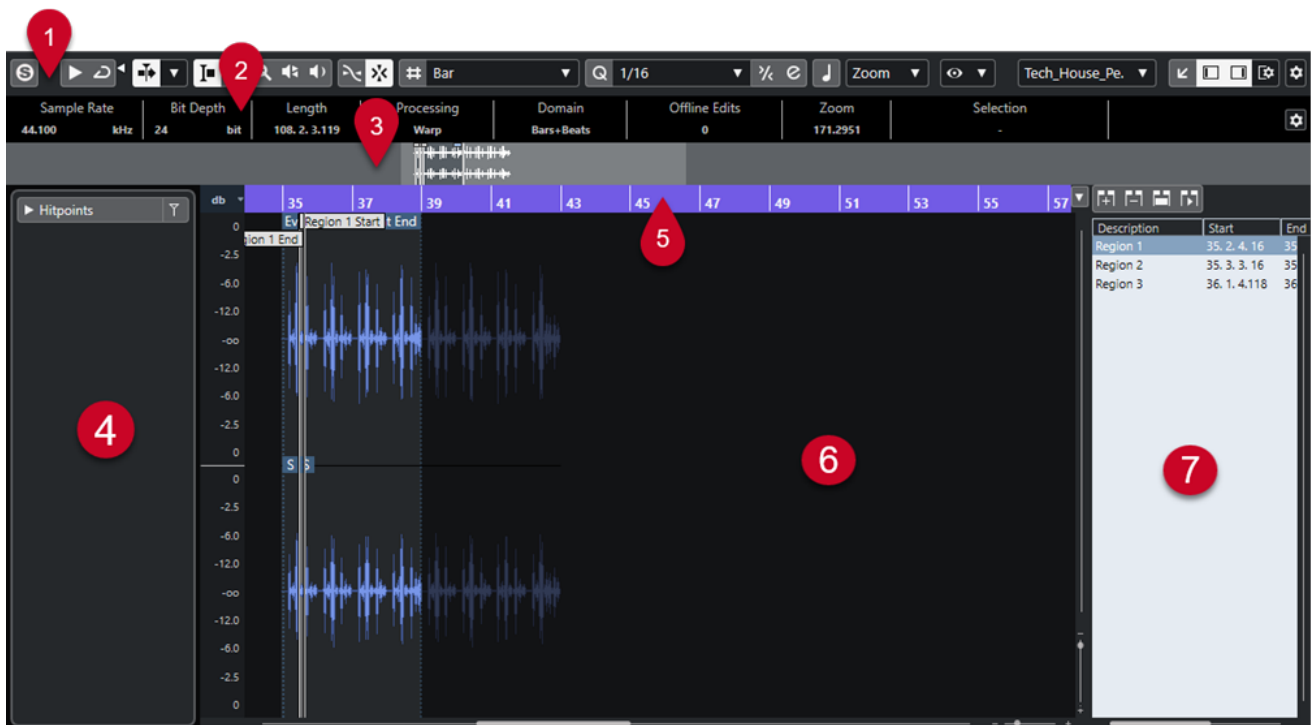

The **Sample Editor** is divided into several sections:

1 Toolbar

Contains tools for selecting, manipulating, and playing back audio.

2 Info Line

Shows information about the audio.

3 Overview

Shows an overview of the whole audio clip and indicates which part of the clip is shown in the waveform display.

4 Sample Editor Inspector

Contains audio editing tools and functions.

NOTE

The **Inspector** for the lower zone editor is shown in the left zone of the **Project** window.

5 Ruler

Shows the timeline and the display format of the project.

6 Waveform display

Shows the waveform image of the edited audio clip.

7 Regions

Allows you to add and edit regions.

NOTE

The info line, the overview line, and the regions can be activated/deactivated by clicking **Set up Window Layout** on the toolbar and activating/deactivating the corresponding options.

RELATED LINKS

[Opening the Editor in the Lower Zone](#) on page 55

[Opening the Editor Inspector](#) on page 50

[Sample Editor Toolbar](#) on page 381

[Info Line](#) on page 386

[Overview Line](#) on page 387

[Sample Editor Inspector](#) on page 387

[Ruler](#) on page 389

[Waveform Display](#) on page 389

[Regions List](#) on page 393

Sample Editor Toolbar

The toolbar contains tools for selecting, editing, and playing back audio.

- To show or hide the toolbar elements, right-click the toolbar, and activate or deactivate the elements.

The following options are available:

Static Buttons

Solo Editor



Solos the selected audio during playback.

Left Divider

Left Divider

Tools that are placed to the left of the divider are always shown.

Auto-Scroll

Auto-Scroll



Keeps the project cursor visible during playback.

Select Auto-Scroll Settings



Allows you to activate **Page Scroll** or **Stationary Cursor** and to activate **Suspend Auto-Scroll When Editing**.

Preview

Audition



Plays back the selected audio.

Audition Loop



Loops the playback until you deactivate **Audition**.

Audition Volume



Allows you to adjust the volume.

Tool Buttons

Range Selection



Selects ranges.

Draw



Draws a volume curve.

Zoom



Zooms in. Hold **Alt/Opt**, and click to zoom out.

Play



Allows you to play back the clip from the position where you click until you release the mouse button.

Scrub



Allows you to locate positions.

Snap

Snap to Zero Crossing



Restricts editing to zero crossings, that is, positions where the amplitude is zero.

Snap On/Off



Restricts horizontal movement and positioning to the specific positions.

Grid Options

Show/Hide Grid



Shows/Hides the grid in the waveform display.

Grid Type



Allows you to select a grid type. The options depend on the display format that is selected for the ruler. If you select **Seconds** as the ruler format, time-based grid options are available. If you select **Bars+Beats** as the ruler format, musical grid options are available.

Quantize

Apply Quantize



Applies the quantize settings.

Quantize Presets



Allows you to select a quantize preset.

Soft Quantize On/Off



Activates/Deactivates soft quantize.

Open Quantize Panel



Opens the **Quantize Panel**.

Musical Mode

Musical Mode



Locks audio clips to the project tempo by using realtime time stretching.

Musical Information

Number of Bars Defined in Audio File



Displays the estimated bars of your audio file.

Remaining Number of Beats Defined in Audio File

0 Beats ▾

Displays the remaining number of beats of your audio file.

Defined Tempo of Audio File

132.00 ▾

Displays the estimated tempo of your audio file.

Defined Time Signature of Audio File

4/4

Displays the estimated time signature of your audio file.

Warping Algorithm for Audio Clip

Standard - Mix ▾

Allows you to select a warp algorithm.

View Options

Zoom Mode

Zoom ▾

Allows you to select a zoom mode for the waveform display.

- If **Global Zoom** is selected, the display follows the zoom and scroll controls of the **Sample Editor**.
- If **Clip-Based Zoom** is selected, the display automatically zooms to the clip of the selected event. In this mode, you cannot scroll beyond the clip borders.
- If **Auto-Zoom to Event** is selected, the display automatically zooms to the active event. In this mode, you can scroll between project start and end.

NOTE

If the **Definition** section of the **Sample Editor** Inspector is opened, **Zoom Mode** is automatically switched from **Global Zoom** to **Clip-Based Zoom**.

Editor Display Mode

👁 ▾

Allows you to select a display mode for the waveform display.

- If **Show Clips and Events** is selected, the display shows the clips and the start and end boundaries of the events that are opened in the **Sample Editor**.
- If **Show Events** is selected, the display shows only the waveform between the start and end boundaries of the events that are opened in the **Sample Editor**.
- If **Show Clips** is selected, the display shows only the clips of the events that are opened in the **Sample Editor**, but not the event boundaries.

Activate Clip for Editing

Percussive Hit 0# ▾

Lists all audio clips that are opened in the **Sample Editor** and allows you to activate one of them for editing.

Independent Track Loop

Independent Track Loop



Activates/Deactivates the independent track loop.

Loop Start Time

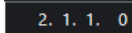

The independent track loop start time.

Loop End Time

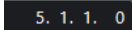

The independent track loop end time.

Right Divider

Right Divider

Tools that are placed to the right of the divider are always shown.

Window Zone Controls

Open in Separate Window



This button is available in the lower zone editor. It opens the editor in a separate window.

Open in Lower Zone



This button is available in the editor window. It opens the editor in the lower zone of the **Project** window.

Set up Window Layout



Allows you to set up the window layout.

Show/Hide Left Zone



Allows you to activate/deactivate the left zone.

Show/Hide Regions



Allows you to activate/deactivate the regions.

Set up Toolbar



Opens a pop-up menu where you can set up which toolbar elements are visible.

RELATED LINKS

[Auto-Scroll Settings Menu](#) on page 200

[Suspend Auto-Scroll When Editing](#) on page 201

Locating Positions with the Scrub Tool

The **Scrub** tool allows you to locate positions in the audio.

PROCEDURE

1. On the toolbar, activate the **Scrub** tool.

2. Click in the waveform display, and keep the mouse button pressed.
The project cursor moves to the position where you clicked.
 3. Drag to the left or to the right.
-

RESULT

The audio is played back, and you can hear at which position the cursor is located.

NOTE

You can determine the speed and the pitch of the playback by dragging faster or more slowly.

Editing Audio Samples with the Draw Tool

You can edit the audio clip at sample level with the **Draw** tool. This way, you can remove audio clicks manually, for example.

PROCEDURE

1. On the audio waveform, locate the sample position that you want to edit, and zoom in to the highest zoom level.
2. Select the **Draw** tool.

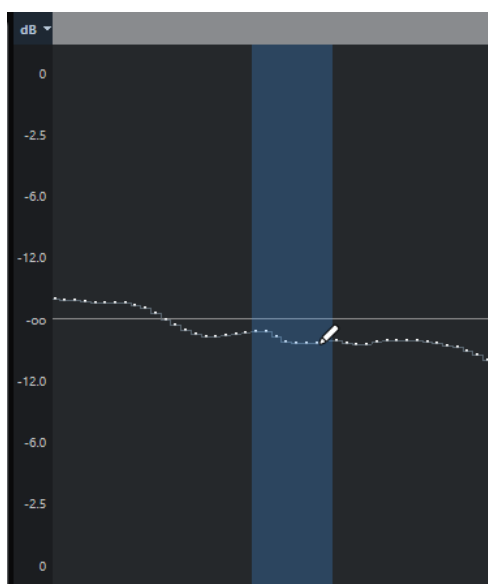

3. Click at the beginning of the section that you want to correct, and draw in the new curve.
-

RESULT

A range selection covering the edited section is automatically applied.

Info Line

The info line shows information about the audio clip, such as the audio format and the selection range.

Sample Rate	Bit Depth	Length	Processing
44.100 kHz	24 bit	47. 3. 0. 30	None

Domain	Offline Edits	Zoom	Selection
Bars+Beats	1	2204.3865	-

- To show or hide the info line, click **Set up Window Layout** on the toolbar, and activate or deactivate **Info Line**.
The on/off status of the info line in the **Sample Editor** window and in the lower zone editor are independent of each other.

NOTE

Initially, length and position values are displayed in the format specified in the **Project Setup** dialog.

Overview Line

The overview line displays the whole clip and indicates which part of the clip is shown in the waveform display.



- To show or hide the overview line, click **Set up Window Layout** on the toolbar, and activate or deactivate the **Overview** option.
The on/off status of the overview line in the **Sample Editor** window and in the lower zone editor are independent of each other.
- 1 Event Start**
Indicates the start of the audio event.
 - 2 Waveform display**
The area in lighter gray indicates the section of the audio that is displayed in the waveform display.
 - You can specify which section of the audio is shown by clicking in the lower half of this display and dragging to the left or right.
 - You can zoom in or out horizontally by dragging the left or the right edge of this display.
 - You can show a different section of the audio by clicking in the upper half of this display and dragging a rectangle.
 - 3 Snap Point**
The dotted vertical line indicates the start of the audio event.
 - 4 Selection**
The blue area indicates which section is selected in the waveform display.
 - 5 Event End**
Indicates the end of the audio event.

Sample Editor Inspector

The **Inspector** shows controls and parameters that allow you to edit the audio event that is opened in the **Sample Editor**.

- In the **Sample Editor** window, you can show or hide the **Inspector** by clicking **Set up Window Layout** on the toolbar and activating or deactivating **Inspector**.

NOTE

In the lower zone editor, the **Inspector** is always shown in the left zone of the **Project** window.

- To open or close the **Inspector** sections, click their names.



RELATED LINKS

[Opening the Editor Inspector](#) on page 50

Hitpoints Section

The **Hitpoints** section allows you to edit hitpoints to slice your audio. Here you can create groove quantize presets, markers, regions, and events based on hitpoints.

- To open the **Hitpoints** section, click its tab in the **Sample Editor Inspector**.

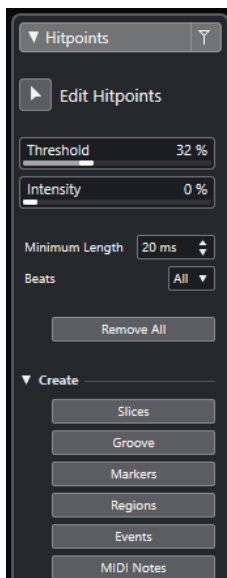

RELATED LINKS

[Hitpoints](#) on page 398

Ruler

The ruler shows the timeline and the display format of the project, the project tempo grid. The ruler is located above the waveform display. It is always shown.

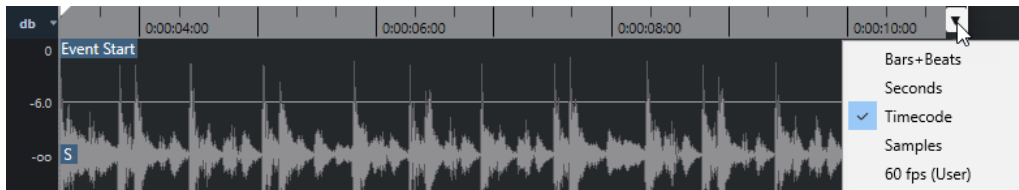

Waveform Display

The waveform display shows the waveform image of the edited audio clip.

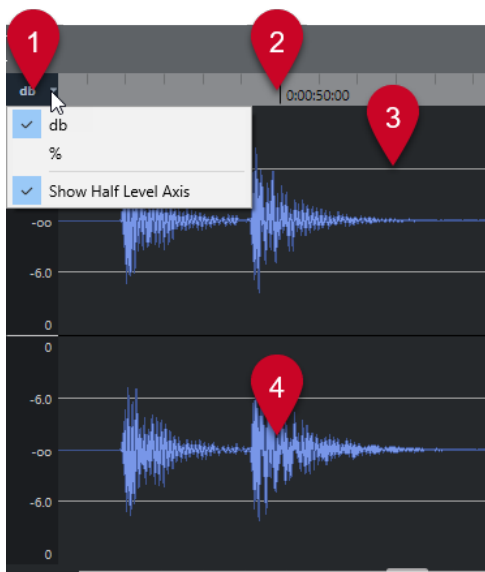

1 Level Scale menu

Allow you to show the level as a percentage or in dB. Here, you can also activate the display of the half level axis.

2 Ruler

Shows the project tempo grid.

3 Half Level Axis

To show the half level axis, open the level scale menu, and select **Show Half Level Axis**.

4 Audio waveform

Shows the waveform image of the selected audio.

NOTE

You can set up a wave image style in the **Preferences** dialog (**Event Display—Audio** page).

Zooming Vertically

You can zoom in the waveform vertically. This allows you to see a specific detail of the waveform.

PROCEDURE

- Drag the vertical zoom slider down to zoom in or drag it upwards to zoom out.



RESULT

The vertical scale changes relative to the height of the **Sample Editor**.

Zooming Horizontally

You can zoom in the waveform horizontally. This allows you to zoom in or out on the time scale.

PROCEDURE

- Drag the horizontal zoom slider to the right to zoom in or to the left to zoom out.



RESULT

The horizontal zoom setting is shown on the info line as samples per pixel. You can zoom in horizontally to a scale of less than one sample per pixel. This is required for using the **Draw** tool.

NOTE

- If you have zoomed in to one sample per pixel or less, the appearance of the samples depends on the **Interpolate Audio Waveforms** option in the **Preferences** dialog (**Event Display—Audio** page).

Zoom Submenu

The **Zoom** submenu of the **Edit** menu contains options for zooming in the **Sample Editor**.

- To open the **Zoom** submenu, select **Edit > Zoom**.

The following options are available:

Zoom In

Zooms in one step, centering on the project cursor.

Zoom Out

Zooms out one step, centering on the project cursor.

Zoom Full

Zooms out according to the **Zoom Mode** in the **Sample Editor**.

- If **Global Zoom** is activated, this function zooms out so that the entire project is visible in the waveform display. The entire project means the timeline from the project start to the length set in the **Project Setup** dialog.
- If **Clip-Based Zoom** or **Auto-Zoom to Event** is activated, this function zooms out so that the entire clip is visible in the waveform display.

Zoom to Selection

Zooms out so that the entire clip is visible in the waveform display.

Zoom to Selection (Horiz.)

Zooms in horizontally so that the current selection fills the waveform display.

Zoom to Event

Zooms in so that the waveform display shows the section of the clip corresponding to the edited audio event. This is not available if you have opened the **Sample Editor** from the **Pool**.

Zoom In Vertically

Zooms in one step vertically.

Zoom Out Vertically

Zooms out one step vertically.

Zoom In On Waveform Vertically

Zooms in on the waveform vertically.

Zoom Out Of Waveform Vertically

Zooms out of the waveform vertically.

Undo/Redo Zoom

Allows you to undo/redo the last zoom operation.

RELATED LINKS

[Zoom Category](#) on page 815

Range Editing

In the **Sample Editor** you can edit selection ranges. This is useful if you want to quickly edit a specific section in the audio waveform, or if you want to create a new event or clip.

You can select only one range at a time. The selection is indicated in the **Selection** field on the info line.

RELATED LINKS

[Shared Copies](#) on page 172

Selecting a Range

PREREQUISITE

Snap to Zero Crossing is activated on the toolbar. This option ensures that the start and the end of the selection are always at zero crossings.

PROCEDURE

1. On the toolbar, activate the **Range Selection** tool.
 2. Click at the position in the waveform display where you want the range to start and drag to the position where you want the range to end.
 3. Optional: Perform one of the following actions to resize the selection range:
 - Drag the left or the right edge of the selection to a new position.
 - Hold down **Shift**, and click at a new position.
-

RESULT

The selected range is highlighted in the waveform display.

NOTE

You can also use the functions in the **Select** pop-up menu to select ranges.

RELATED LINKS

[Select Menu](#) on page 392

Select Menu

Select Submenu on the Edit Menu

If you select **Edit > Select**, the following functions are available:

All

Selects the whole clip.

None

Deselects everything.

In Loop

Selects the audio between the left and right locator.

From Start to Cursor

Selects the audio between the clip start and the project cursor.

From Cursor to End

Selects the audio between the project cursor and the clip end. This option is available if the project cursor is positioned between the clip boundaries.

Select Event

Selects the event.

Left Selection Side to Cursor

Moves the left side of the selection range to the project cursor position. This option is available if the project cursor is positioned between the clip boundaries.

Right Selection Side to Cursor

Moves the right side of the selection range to the project cursor position or the end of the clip, if the project cursor is positioned to the right of the clip.

Creating Events from Selection Ranges

You can create a new event that contains only the selected range.

PROCEDURE

1. Select a range.
 2. Drag the selection range to an audio track in the **Project** window.
-

RELATED LINKS

[Selecting a Range](#) on page 391

Creating Clips from Selection Ranges

You can create a new clip that contains only the selected range.

PROCEDURE

1. Select a range.
2. Click the selected range, and select **Audio > Bounce Selection**.
3. Perform one of the following actions:
 - Click **Replace** if you want to replace the original.
 - Click **No** if you want to keep the original.

RESULT

A new **Sample Editor** window opens with the new clip. It refers to the same audio file as the original clip, but it contains the audio corresponding to the selection range only.

Regions List

Regions are sections within an audio clip that allow you to mark important sections in the audio. You can add and edit regions for the selected audio clip in the regions zone.

- To show or hide the **Regions**, click **Set up Window Layout** on the toolbar, and activate or deactivate **Regions**.

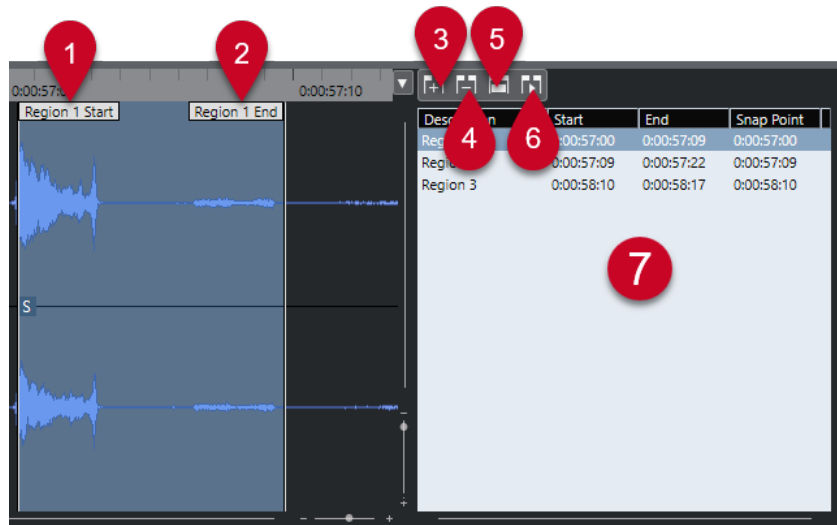

The following controls are available:

- 1 Region Start**
Shows the start of the region in the audio waveform.
- 2 Region End**
Shows the end of the region in the audio waveform.
- 3 Add Region**
Allows you to create a region of the current range selection.
- 4 Remove Region**
Allows you to remove the selected region.
- 5 Select Region**

If you select a region from the list and click this button above, the corresponding section of the audio clip is selected (as if you had selected it with the **Range Selection** tool) and zoomed. This is useful if you want to apply processing to the region only.

6 Play Region

Plays back the selected region.

7 Regions list

Allows you to select and display regions in the audio waveform.

Creating Regions

PREREQUISITE

You have clicked **Set up Window Layout** on the toolbar, and you have activated **Regions**.

PROCEDURE

1. On the **Sample Editor** toolbar, activate the **Range Selection** tool.
 2. In the waveform display, select the range that you want to convert into a region.
 3. Perform one of the following actions:
 - Above the regions list, click **Add Region**.
 - Select **Audio > Advanced > Event or Range as Region**.A region is created, corresponding to the selected range.
 4. Optional: Double-click the region name in the list, and enter a new name.
-

RESULT

The region is added to the regions list.

AFTER COMPLETING THIS TASK

Click the region in the regions list to instantly display it in the **Sample Editor**.

RELATED LINKS

[Creating Regions](#) on page 406

Creating Regions from Hitpoints

You can create regions from hitpoints. This is useful to isolate specific sounds.

PREREQUISITE

The audio event from which you want to create regions is opened in the **Sample Editor**, and the hitpoints are set at the correct positions.

PROCEDURE

- In the **Hitpoints** section of the **Sample Editor Inspector**, click **Create Regions**.
-

RESULT

Regions are created between two hitpoint positions and shown in the **Sample Editor**.

Adjusting Start and End Positions of Regions

PREREQUISITE

You have clicked **Set up Window Layout** on the toolbar, and you have activated **Regions**. You have created regions.

PROCEDURE

- Perform one of the following actions:
 - Drag the **Region Start** or **Region End** handle to a different position in the waveform display.
 - Double-click the **Start** or **End** field in the regions list, and enter a new value.

NOTE

The positions are shown in the display format selected for the ruler and the info line, but they are relative to the start of the audio clip.

Removing Regions

PREREQUISITE

You have clicked **Set up Window Layout** on the toolbar, and you have activated **Regions**. You have created regions.

PROCEDURE

1. In the regions list, select the region that you want to remove.
 2. Above the regions list, click **Remove Region**.
-

RESULT

The region is removed from the regions list.

Creating Audio Events from Regions

You can create new audio events from regions using drag and drop.

PREREQUISITE

You have clicked **Set up Window Layout** on the toolbar, and you have activated **Regions**. You have created regions.

PROCEDURE

1. Select the region in the regions list.
 2. Drag the region to the desired position in the **Project** window.
-

RESULT

An event is created from the region.

Snap Point

The snap point is a marker within an audio event that can be used as a reference position.

- To show the snap point, select **Show Clips and Events** or **Show Event** as **Editor Display Mode** on the toolbar.

The event snap point is set as follows:

- If you record an audio event, the snap point is set to the next grid position.
- If you bounce a selection, the snap point is set to the start of the new event or to the first snap point that you set manually.
- If you bounce a range selection, the snap point is set to the start of the new event or to the first snap point that you set manually.
- If you freeze an audio event, the snap point is set to the start of the new event or to the first snap point that you set manually.
- If you export audio, the snap point is set to the start of the new audio file.

NOTE

You can move the snap point to any other relevant position in the audio.

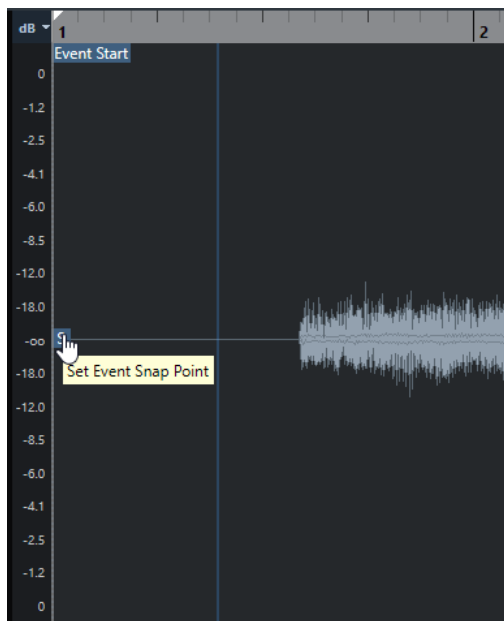

The snap point is used when **Snap** is activated and you insert a clip from the **Sample Editor** in the event display. It is also used when you move or copy events in the event display.

In the **Sample Editor**, you can edit the following snap points:

- Event Snap Point
This is shown in the **Sample Editor** if you open a clip from within the **Project** window.
- Clip Snap Point
This is shown in the **Sample Editor** if you open a clip from the **Pool**.

NOTE

The clip snap point serves as a template for the event snap point. However, it is the event snap point that is taken into account when snapping.

RELATED LINKS

[Sample Editor Toolbar](#) on page 381

[Adjusting the Snap Point](#) on page 397

Adjusting the Snap Point

PREREQUISITE

The audio event is opened in the **Sample Editor**. **Show Clips and Events** or **Show Event** is selected as **Editor Display Mode** on the toolbar.

PROCEDURE

1. Optional: On the **Sample Editor** toolbar, select the **Scrub** tool.
This allows you to audition the audio while setting the snap point.
 2. Move the mouse pointer over the snap point, and drag it to the desired position in the audio event.
The mouse pointer becomes a hand symbol, and a tooltip indicates that you can set the snap point.
-

RESULT

The event snap point is adjusted to the position where you dragged it.

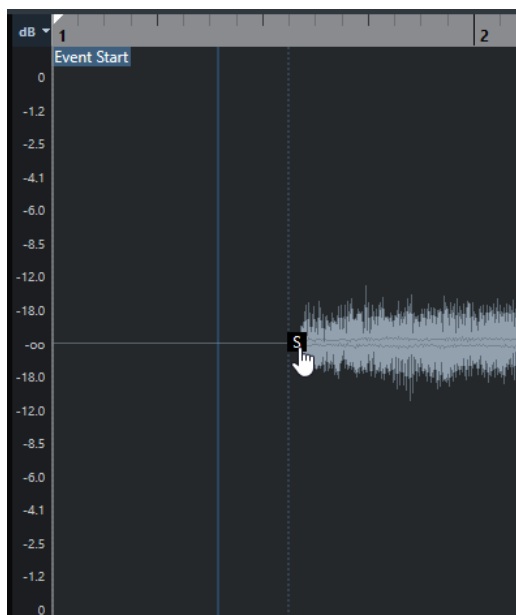

NOTE

You can also adjust the snap point by setting the project cursor at the desired position and selecting **Audio > Snap Point to Cursor**.

RELATED LINKS

[Snap Point](#) on page 396

Hitpoints

Hitpoints mark musically relevant positions in audio files. Cubase can detect these positions and create hitpoints automatically by analyzing onsets and melodic changes of the audio.

NOTE

All hitpoint operations can be performed in the **Sample Editor** window and in the lower zone editor.

When you add an audio file to your project by recording or by importing, Cubase automatically detects hitpoints if **Enable Automatic Hitpoint Detection** is activated in the **Preferences** dialog (**Editing—Audio** page).

In the **Project** window, hitpoints are shown for the selected event, provided that the zoom factor is high enough.

The hitpoint functions are available in the **Hitpoints** section of the **Sample Editor**.

You can use hitpoints for the following purposes:

- Create slices of the audio
Slices allow you to change the tempo and the timing of the audio without affecting its pitch and quality, or to replace or extract individual sounds from loops.
- Quantize audio
- Extract the groove from the audio
The timing is extracted from the audio, and a groove quantize preset is created. You can use this to quantize other events.
- Create markers from the audio
- Create regions from the audio
- Create events from the audio
- Create MIDI notes from the audio

NOTE

Hitpoints work best with drums, rhythmic recordings, or loops.

If the automatic hitpoint detection does not meet your expectations, you can edit hitpoints manually or add additional hitpoints. The following editing operations are available in the **Sample Editor**:

- Locking hitpoints prevents them from being filtered out, regardless of the settings in the **Hitpoints** section. You can lock a hitpoint by pointing at the triangle that represents the hitpoint and clicking on it.
- Disabling hitpoints excludes them from further operations. You can disable a hitpoint that you do not need by pressing **Shift** and clicking on the line that represents the hitpoint.
- You can insert an additional hitpoint by pressing **Alt/Opt** and clicking at the position where you want to insert the hitpoint.

- You can move a hitpoint by moving the mouse pointer on the vertical line that represents the hitpoint and dragging to the left or to the right.

RELATED LINKS

[Calculating Hitpoints](#) on page 399

[Editing Hitpoints Manually](#) on page 401

Calculating Hitpoints

When you add an audio file to your project by recording or by importing, Cubase can automatically detect hitpoints.

PREREQUISITE

Enable Automatic Hitpoint Detection is activated in the **Preferences** dialog (**Editing—Audio** page).

PROCEDURE

1. Import or record an audio file.
Cubase automatically detects hitpoints.

NOTE

If your audio file is very long, this may take a while.

2. Select the audio event in the **Project** window, and make sure the zoom factor is high enough.

RESULT

The hitpoints calculated for the selected event are shown in the **Project** window.

AFTER COMPLETING THIS TASK

You can manually edit detected hitpoints or add further hitpoints in the **Sample Editor**.

RELATED LINKS

[Editing - Audio](#) on page 829

[Editing Hitpoints Manually](#) on page 401

Hitpoint Filters in the Hitpoint Section

Cubase can automatically detect and filter hitpoints.

For the automatic hitpoint detection to work, **Enable Automatic Hitpoint Detection** must be activated in the **Preferences** dialog (**Editing—Audio** page). If the detection result does not meet your expectations, you can adjust the hitpoint filtering manually.

- To filter hitpoints, open the audio event in the **Sample Editor**, and open the **Hitpoints** section.

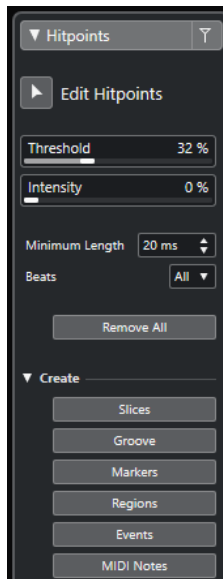

Main Section

Edit Hitpoints

Allows you to edit hitpoints manually in the event display.

Threshold

Filters hitpoints by their peaks. Drag the slider to the right to discard hitpoints of quieter crosstalk signals, for example.

Intensity

Filters hitpoints by their intensity. Drag the slider to the right to discard less intense hitpoints.

Minimum Length

Filters hitpoints by their distance between two hitpoints. This option allows you to avoid creating slices that are too short.

Beats

Filters hitpoints by their musical position. This option allows you to discard hitpoints that do not fit within a certain range of a defined beat value.

Remove All

Removes all automatically calculated and manually created hitpoints. To restore all automatically calculated hitpoints, click **Edit Hitpoints**.

Create Section

Slices

Creates slices at hitpoint positions.

Groove

Creates a groove quantize preset at hitpoint positions.

Markers

Creates markers at hitpoint positions.

Regions

Creates regions at hitpoint positions.

Events

Creates events at hitpoint positions.

MIDI Notes

Creates MIDI notes at hitpoint positions.

RELATED LINKS

[Editing Hitpoints Manually](#) on page 401

Editing Hitpoints Manually

It is crucial for any further editing that the hitpoints are set at the correct positions. Therefore, if the automatic hitpoint detection does not meet your expectations, you can edit hitpoints manually.

PREREQUISITE

The audio event is opened in the **Sample Editor**, and in the **Hitpoints** section, hitpoints are filtered by their peak and/or intensity, by their distance, or by their musical position.

PROCEDURE

1. In the **Hitpoints** section in the **Sample Editor Inspector**, activate the **Edit Hitpoints** tool.

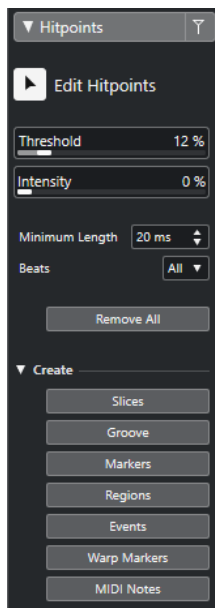

2. Move the mouse to the waveform display, and click between two hitpoints.
The mouse pointer changes to a speaker icon, and the tooltip **Play back Slice** is shown. The slice is played back from the beginning to the end.

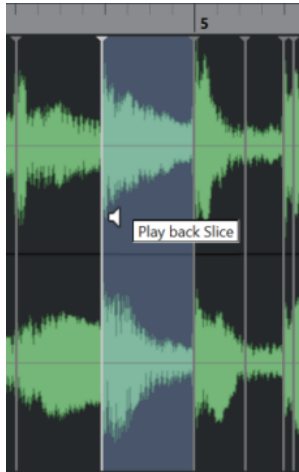

3. To disable a hitpoint that you do not need, press **Shift**, and click on the line that represents the hitpoint.

The mouse pointer changes to a cross icon, and the tooltip **Disable Hitpoints** is shown. Disabled hitpoints are not taken into account for further operations.



4. Press **Tab** to navigate to the next slice.
The slice is played back automatically.
5. To insert a hitpoint, press **Alt/Opt**, and click at the position where you want to insert the hitpoint.
The mouse pointer changes to a draw icon, and the tooltip **Insert Hitpoint** is shown.
6. To move a hitpoint, move the mouse pointer on the vertical line that represents the hitpoint, and drag to the left or to the right.
The mouse pointer changes to a double arrow, and the tooltip **Move Hitpoint** is shown.
Moved hitpoints are locked by default.
7. To make sure that a hitpoint is not accidentally filtered out, lock it by pointing at the triangle that represents it and clicking on it.
The tooltip **Lock Hitpoint** is shown.

RESULT

The hitpoints are edited according to your settings.

NOTE

To reset a hitpoint to its original state, press **Ctrl/Cmd - Alt/Opt** until the tooltip **Enable/Unlock Hitpoints** is shown, and click on the line that represents the hitpoint.

RELATED LINKS

[Hitpoint Filters in the Hitpoint Section](#) on page 399

Locating to Hitpoints in the Project Window

You can navigate through the hitpoints of an audio event in the **Project** window.

PREREQUISITE

Enable Automatic Hitpoint Detection is activated in the **Preferences** dialog (**Editing—Audio** page).

PROCEDURE

1. Select the audio track that contains the audio event for which you want to locate hitpoints.
2. Perform one of the following actions:
 - Press **Alt/Opt - N** to navigate to the next hitpoint.
 - Press **Alt/Opt - B** to navigate to the previous hitpoint.

RESULT

The project cursor jumps to the respective hitpoint.

Slices

You can create slices from hitpoints, where each slice ideally represents an individual sound or beat of the audio.

You can use these slices to change the tempo and the timing of the audio without affecting its pitch and quality.

NOTE

Slices are created in the **Sample Editor** and edited in the **Audio Part Editor**.

Audio that meets the following characteristics is suitable:

- Individual sounds have a noticeable attack.
- The recording quality is good.
- The recording is free of crosstalk signals.
- The audio is free of smearing effects like delays, for example.

Slicing Audio

Slicing audio is useful if you want to change the tempo and the timing of the audio without affecting its pitch and quality.

PREREQUISITE

The audio event is opened in the **Sample Editor**, and the hitpoints are set at the correct positions.

NOTE

When slicing audio, all events referring to the edited clip are also replaced.

PROCEDURE

- Perform one of the following actions:
 - In the **Hitpoints** section in the **Sample Editor Inspector**, open the **Create** section, and click **Slices**.
 - Select **Audio > Hitpoints > Create Audio Slices from Hitpoints**.
-

RESULT

The areas between the hitpoints are sliced and become separate events. The original audio event is replaced by an audio part containing the slices.

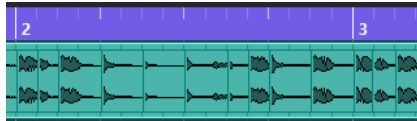

On playback, the audio plays back seamlessly at the project tempo.

AFTER COMPLETING THIS TASK

Change the project tempo. The slices are moved accordingly, keeping their relative positions within the part.

Double-click the sliced audio part, and replace or extract individual slices in the **Audio Part Editor**.

RELATED LINKS

[Slices and the Project Tempo](#) on page 404

[Audio Part Editor](#) on page 411

Slices and the Project Tempo

The project tempo affects how the sliced audio is played back.

RELATED LINKS

[Closing Gaps](#) on page 404

[Deleting Overlaps](#) on page 405

[Musical Mode](#) on page 410

[Making Global Auto Fade Settings](#) on page 260

[Making Auto Fade Settings for Individual Tracks](#) on page 260

Closing Gaps

If the project tempo is slower than the tempo of the original audio event, there may be audible gaps between the slice events in the part. You can close these gaps so that the audio plays without any breaks.

PROCEDURE

- Do one of the following:
 - Select **Audio > Advanced > Close Gaps (Time Stretch)** to apply time stretch to each slice and to close the gaps.
Consider activating auto fades for the corresponding audio track and setting the fade-out to 10 ms to eliminate clicks.
 - Select **Audio > Advanced > Close Gaps (Crossfade)** to apply crossfades to the slices and to close the gaps.
-

AFTER COMPLETING THIS TASK

NOTE

If you decide to change the tempo again, undo your actions and use the original, unstretched file.

Deleting Overlaps

If the project tempo is higher than the tempo of the original audio event, the slice events in the part may overlap. You can delete these overlaps.

PROCEDURE

1. Right-click the track in the track list, and from the context menu, select **Auto Fades Settings**.
 2. In the **Auto Fades** dialog, activate **Auto Crossfades**.
 3. Click **OK**.
 4. Select the overlapping events in the part, and select **Audio > Advanced > Delete Overlaps**.
-

RESULT

The sound is smoothed out.

Creating a Groove Quantize Preset

You can use hitpoints to create a groove quantize preset.

PREREQUISITE

The audio event from which you want to extract the timing is opened in the **Sample Editor**, and the hitpoints are set at the correct positions.

PROCEDURE

- In the **Hitpoints** section in the **Sample Editor Inspector**, open the **Create** section, and click **Groove**.
-

RESULT

The groove is extracted from the audio event and automatically selected in the **Quantize Presets** pop-up menu on the **Project** window toolbar.

AFTER COMPLETING THIS TASK

Open the **Quantize Panel**, and save the groove as a preset.

RELATED LINKS

[Quantize Panel](#) on page 243

Creating Markers

You can create markers at hitpoint positions. This allows you to snap to hitpoint positions.

PREREQUISITE

The audio event from which you want to create markers is opened in the **Sample Editor**, and the hitpoints are set at the correct positions.

PROCEDURE

- In the **Hitpoints** section in the **Sample Editor Inspector**, open the **Create** section, and click **Markers**.
-

RESULT

If your project has no marker track, a marker track is added and activated automatically, and a marker is created at every hitpoint position.

RELATED LINKS

[Markers](#) on page 270

Creating Regions

You can create regions at hitpoint positions. This allows you to isolate recorded sounds.

PREREQUISITE

The audio event from which you want to create regions is opened in the **Sample Editor**, and the hitpoints are set at the correct positions.

PROCEDURE

- In the **Hitpoints** section in the **Sample Editor Inspector**, open the **Create** section, and click **Regions**.
-

RESULT

Regions are created between two hitpoint positions and shown in the **Sample Editor**.

RELATED LINKS

[Creating Regions](#) on page 394

Creating Events

You can create events at hitpoint positions.

PREREQUISITE

The audio event from which you want to create events is opened in the **Sample Editor**, and the hitpoints are set at the correct positions.

PROCEDURE

- In the **Hitpoints** section in the **Sample Editor Inspector**, open the **Create** section, and click **Events**.
-

RESULT

Events are created between two hitpoint positions.

Creating MIDI Notes

You can create MIDI notes from hitpoints. This allows you to double, replace, or enrich drum hits by triggering sounds of a VST instrument.

PREREQUISITE

The audio event from which you want to create MIDI notes is opened in the **Sample Editor**, and the hitpoints are set at the correct positions.

PROCEDURE

1. In the **Hitpoints** section in the **Sample Editor Inspector**, open the **Create** section, and click **MIDI Notes**.
2. In the **Convert Hitpoints to MIDI Notes** dialog, set up the parameters.
3. Click **OK**.

RESULT

A MIDI track is added to your project, and MIDI notes are created at every hitpoint position.

AFTER COMPLETING THIS TASK

Assign a VST instrument to the MIDI track, and select a sound to enrich the audio.

Convert Hitpoints to MIDI Notes Dialog

The **Convert Hitpoints to MIDI Notes** dialog allows you to specify how to convert hitpoints when you create MIDI notes from hitpoints.

- To open the **Convert Hitpoints to MIDI Notes** dialog, open the **Create** section in the **Hitpoints** section of the **Sample Editor Inspector**, and click **MIDI Notes**.

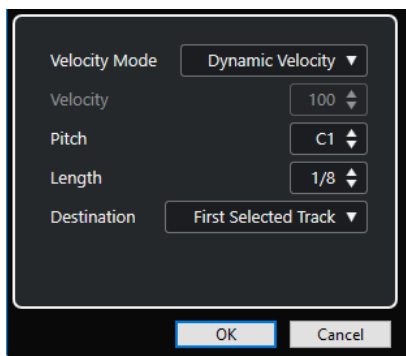

The following options are available:

Velocity Mode

Allows you to select a velocity mode:

- If you want the velocity values of the created MIDI notes to vary according to the peak levels of the corresponding hitpoints, select **Dynamic Velocity**.
- If you want to assign the same velocity value to all created MIDI notes, select **Fixed Velocity**.

Velocity

Sets the **Fixed Velocity**.

Pitch

Sets a note pitch for all created MIDI notes.

Length

Sets a note length for all created MIDI notes.

Destination

Allows you to select a destination:

- To place the MIDI part on the first selected MIDI or instrument track, select **First Selected Track**.

NOTE

Any MIDI parts from previous conversions on this track will be deleted.

- To create a new MIDI track for the MIDI part, select **New MIDI Track**.
- To copy the MIDI part to the clipboard, select **Project Clipboard**.

Tempo Matching Audio

Cubase offers several functions that allow you to match the tempo of the audio in your project.

In the **Sample Editor** window and in the lower zone editor, you can perform the following tempo matching operations:

- **Stretch to Project Tempo**
Stretches the selected event to match the project tempo.
- **Musical Mode**
Applies realtime time stretching to audio clips, so that they match the project tempo.

RELATED LINKS

[Stretching Audio Events to the Project Tempo](#) on page 409

[Musical Mode](#) on page 410

Algorithm Presets

You can select an algorithm preset that is applied for realtime playback and time stretching.

The **Warping Algorithm for Audio Clip** pop-up menu on the toolbar and in the **Inspector** of the **Sample Editor** contains various presets that determine the audio quality of the realtime time stretching.

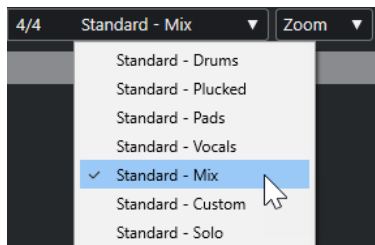

The algorithm preset affects warp changes in **Musical Mode**.

RELATED LINKS

[Algorithm Presets](#) on page 409

[Time Stretch Algorithms](#) on page 370

Stretching Audio Events to the Project Tempo

You can stretch audio loops to the project tempo.

PROCEDURE

1. Select **File > Import > Audio File**, select the audio loop that you want to import, and click **OK**.
 2. Select the audio loop in the project.
 3. Select **Audio > Advanced > Stretch to Project Tempo**.
-

RESULT

The audio loop is stretched to match the project tempo.

Musical Mode

The **Musical Mode** allows you to tempo-match audio loops to the project tempo.

If you activate **Musical Mode** for an audio clip, realtime time stretching is applied to the clip so that it matches the project tempo. The audio events adapt to any tempo changes in Cubase, just like MIDI events.

In the **Sample Editor**, you can activate **Musical Mode** on the toolbar.

NOTE

- You can also activate/deactivate **Musical Mode** from within the **Pool** by clicking the corresponding checkbox in the **Musical Mode** column.
 - Cubase supports ACID® loops. These loops are standard audio files, but with embedded tempo/length information. When ACID® files are imported into Cubase, **Musical Mode** is automatically activated, and the loops adapt to the project tempo.
-

Audio Part Editor

The **Audio Part Editor** provides an overview of the selected audio parts. It allows you to view, audition, and edit parts by cutting and pasting, crossfading, drawing level curves, or by processing parts. Editing is non-destructive so that you can undo modifications at any time.

You can open the **Audio Part Editor** in a separate window or in the lower zone of the **Project** window. Opening the **Audio Part Editor** in the lower zone of the **Project** window is useful if you want to access the **Audio Part Editor** functions from within a fixed zone of the **Project** window.

To open an audio part in the **Audio Part Editor**, do one of the following:

- Double-click an audio part in the **Project**.
- Select an audio part in the **Project** window, and press **Return** or **Ctrl/Cmd - E**.
- Select an audio part in the **Project** window, and select **Audio > Open Audio Part Editor**.
- In the **Key Commands** dialog in the **Editors** category, assign a key command for **Open Audio Part Editor**. Select an audio part in the **Project** window, and use the key command.

NOTE

If you select **Audio > Set up Editor Preferences**, the **Preferences** dialog opens on the **Editors** page. Specify if you want the **Audio Part Editor** to open in a separate window or in the lower zone of the **Project** window.

The Audio Part Editor

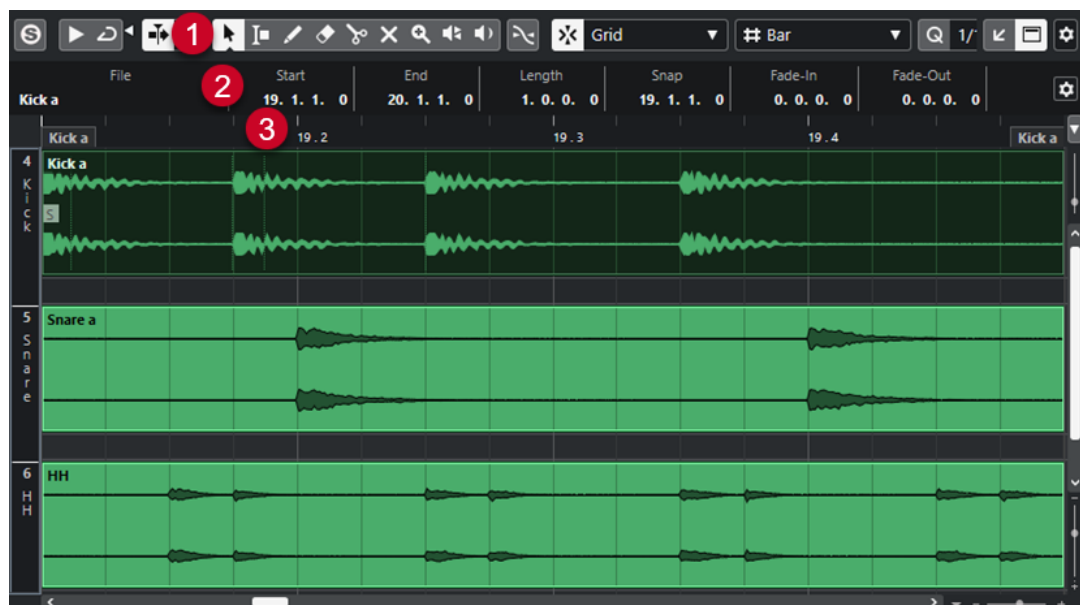

- 1 Toolbar**
Contains tools for selecting, editing, and playing back audio parts.
- 2 Info Line**
Displays information on the audio parts.
- 3 Ruler**

Displays the timeline and the display format of the project.

RELATED LINKS

[Opening the Editor in the Lower Zone](#) on page 55

[Opening the Editor Inspector](#) on page 50

[Ruler](#) on page 44

[Info Line](#) on page 46

[Audio Part Editor Toolbar](#) on page 412

Audio Part Editor Toolbar

The toolbar contains tools for selecting, editing, and playing back audio parts.

- To show or hide the toolbar elements, right-click the toolbar and activate or deactivate the elements.

The following options are available:

Info/Solo

Solo Editor



Solos the selected audio during playback.

Left Divider

Left Divider

Tools that are placed to the left of the divider are always shown.

Auto-Scroll

Auto-Scroll



Keeps the project cursor visible during playback.

Select Auto-Scroll Settings



Allows you to activate **Page Scroll** or **Stationary Cursor** and to activate **Suspend Auto-Scroll When Editing**.

Preview

Audition



Plays back the selected audio.

Audition Loop



Loops the playback until you deactivate **Audition**.

Audition Volume



Allows you to adjust the volume.

Tool Buttons

Object Selection



Selects audio parts.

Range Selection



Selects ranges.

Zoom



Zooms in. Hold **Alt/Opt**, and click to zoom out.

Erase



Deletes audio parts.

Split



Splits audio parts.

Mute



Mutes audio parts.

Draw



Draws a volume curve.

Play



Allows you to play back the clip from the position where you click until you release the mouse button.

Scrub



Allows you to locate positions.

Multiple Part Controls

Show Part Borders



Shows/Hides part borders for the active audio part, within the left and right locators.

Part Editing Mode



Sets the editing mode for parts.

- **Edit All Parts** allows you to edit all parts that are open in the **Editor** at the same time.
- **Edit Active Part** restricts editing operations to the part that is selected in the **Activate Part for Editing** pop-up menu.

Activate Part for Editing

FC04_CK_1_Cra. ▾

Lists all parts that were selected when you opened the editor and allows you to activate a part.

Nudge

Nudge Start Left



Increases the length of the selected event by moving its start to the left.

Nudge Start Right



Decreases the length of the selected event by moving its start to the right.

Move Left



Moves the selected event to the left.

Move Right



Moves the selected event to the right.

Nudge End Left



Decreases the length of the selected event by moving its end to the left.

Nudge End Right



Increases the length of the selected event by moving its end to the right.

Snap

Snap to Zero Crossing



Restricts editing to zero crossings, that is, positions where the amplitude is zero.

Snap On/Off



Restricts horizontal movement and positioning to the specific positions.

Snap Type

Grid ▾

Allows you to specify to what positions you want events to snap.

Grid Type

Grid Type

Bar ▾

Allows you to select a grid type. The options depend on the display format that is selected for the ruler. If you select **Seconds** as the ruler format, time-based grid

options are available. If you select **Bars+Beats** as the ruler format, musical grid options are available.

Quantize

Soft Quantize On/Off



Activates/Deactivates soft quantize.

Quantize Presets



Allows you to select a quantize preset.

Apply Quantize



Applies the quantize settings.

Open Quantize Panel



Opens the **Quantize Panel**.

Event Colors

Select Color for Selected Tracks or Events



Allows you to define audio part colors.

Independent Track Loop

Independent Track Loop



Activates/Deactivates the independent track loop.

Loop Start Time

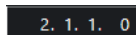

The independent track loop start time.

Loop End Time

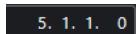

The independent track loop end time.

Right Divider

Right Divider

Tools that are placed to the right of the divider are always shown.

Window Zone Controls

Open in Separate Window



This button is available in the lower zone editor. It opens the editor in a separate window.

Open in Lower Zone



This button is available in the editor window. It opens the editor in the lower zone of the **Project** window.

Show/Hide Info



Allows you to activate/deactivate the info line.

Set up Toolbar



Opens a pop-up menu where you can set up which toolbar elements are visible.

RELATED LINKS

[Auto-Scroll Settings Menu](#) on page 200

[Suspend Auto-Scroll When Editing](#) on page 201

Info Line

The info line shows information about the audio part, such as the start, the end, the length, or the time stretch algorithm.

File	Start	End	Length	Offset	Snap
04 piano 01	1. 1. 1. 0	3. 1. 1. 0	2. 0. 0. 0	0. 0. 0. 0	1. 1. 1. 0
Fade-In	Fade-Out	Volume	Lock	Transpose	Fine-Tune
0. 0. 0. 0	0. 0. 0. 0	0.00 dB	-	0	0
Mute	Musical Mode	Algorithm			
-	-	Standard - Mix			

- To show or hide the info line, activate **Show/Hide Info** on the toolbar. The on/off status of the info line in the **Audio Part Editor** window and in the lower zone editor are independent of each other.

RELATED LINKS

[Audio Part Editor Toolbar](#) on page 412

Ruler

The ruler shows the timeline and the display format of the project.

You can select a separate display format by clicking on the arrow button on the right. Select an option from the pop-up menu.

Lanes

Lanes can make it easier to work with several audio events in a part. Moving some of the events to another lane can facilitate selecting and editing.

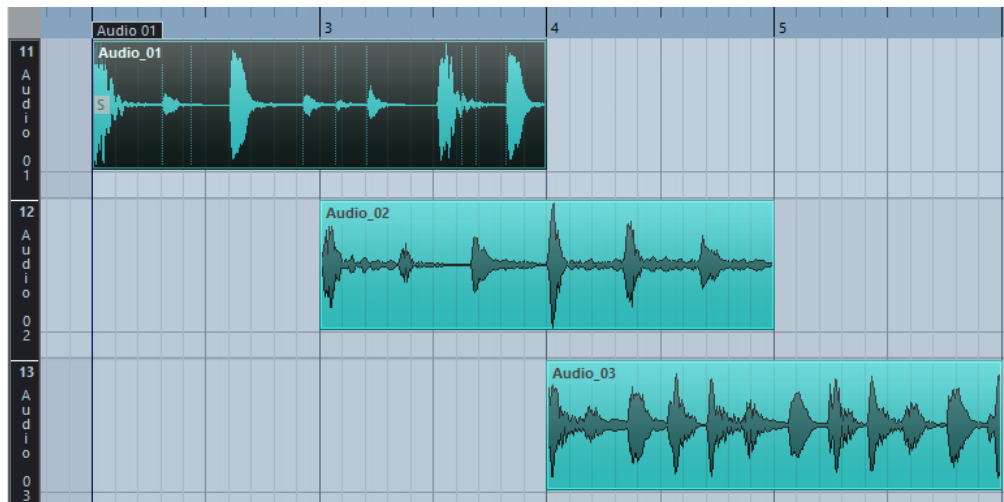

If **Snap** is deactivated and you want to move an event to another lane without accidentally moving it horizontally, press **Ctrl/Cmd** while dragging it up or down.

RELATED LINKS

[Track Handling](#) on page 136

Operations

You can perform all operations in the **Audio Part Editor** window and in the lower zone editor. Zooming, selecting, and editing in the **Audio Part Editor** is done just as in the **Project** window.

NOTE

If a part is a shared copy, any editing you perform affects all shared copies of this part.

RELATED LINKS

[Project Window](#) on page 34

[Shared Copies](#) on page 172

Audition

When auditioning with the **Speaker** tool or **Audition** icon, audio will be routed directly to the main mix (the default output bus).

Auditioning Using the Audition Tool

You can use the **Audition** tool to start a single audition of a selection or to loop an audition by using the **Audition Loop** function.

PROCEDURE

1. Do one of the following:

- To play back the section between the first and last selected event, select the events with the **Object Selection** tool.
 - To play back a range, select a range with the **Range Selection** tool.
 - To start playback from the current cursor position, set the project cursor to that position.
2. On the toolbar, click **Audition**.

NOTE

If you activate **Audition Loop**, playback continues until you deactivate **Audition**.

RELATED LINKS

[Audio Part Editor Toolbar](#) on page 412

Auditioning Using the Play Tool

PROCEDURE

1. Select **Play** on the toolbar.
 2. On an audio part, click and hold at the position from which you want to begin auditioning.
-

RESULT

You are auditioning the audio part. The audition stops at the end of the part you clicked on.

RELATED LINKS

[Audio Part Editor Toolbar](#) on page 412

Auditioning Using Regular Playback

PROCEDURE

1. Set the project cursor to the position where you want to start playback.
 2. Optional: On the toolbar of the **Audio Part Editor**, activate **Solo Editor**.
This way, only the events in the edited part are played back.
 3. On the **Transport** panel, activate **Start**.
-

Setting up the Independent Track Loop

The independent track loop is a sort of mini-cycle, affecting only the edited part. When the loop is activated, the events in the parts within the loop are repeated continuously and completely independent. Other events (on other tracks) are played back as usual. The only interaction between the loop and the regular playback is that, with every iteration of the cycle, the loop starts again as well.

PROCEDURE

1. Activate **Independent Track Loop** on the toolbar.
If it is not visible, right-click the toolbar, and add the **Independent Track Loop** section.
2. **Ctrl/Cmd**-click in the ruler to set the start of the loop. **Alt/Opt**-click to set the end of the loop.

NOTE

You can also edit the start and end positions of the loop numerically in the fields next to the **Loop** button.

RESULT

The loop is displayed in blue in the ruler.

NOTE

The events are looped as long as the **Loop** button is activated and the **Audio Part Editor** is open.

RELATED LINKS

[Setup Options](#) on page 817

[Audio Part Editor Toolbar](#) on page 412

Scrub

In the **Audio Part Editor**, the **Scrub** tool has a separate icon on the toolbar. Apart from that, scrubbing works exactly as in the **Project** window.

RELATED LINKS

[Scrubbing](#) on page 159

Handling Several Parts

When you open the **Audio Part Editor** with several parts selected – all on the same track or on different tracks – they might not all fit in the editor window, which can make it hard to get an overview of the different parts when editing.

Therefore, the toolbar features functions to make working with multiple parts easier and more comprehensive:

- The **Activate Part for Editing** pop-up menu lists all parts that were selected when you opened the editor, and it allows you to activate parts for editing.
As soon as you select a part, it is activated and centered in the display.

NOTE

You can also activate a part by clicking on it with the **Object Selection** tool.

- **Edit Active Part** in the **Part Editing Mode** pop-up menu allows you restrict editing operations to the active part.
If you select **Edit > Select > All** with this option activated, all events in the active part are selected, but no events in other parts.
- You can zoom in on an active part so that it is fully displayed in the window by selecting **Edit > Zoom > Zoom to Event**.
- Select **Show Part Borders** to see clearly defined borders for the active part.
If this option is activated, all parts except the active one are grayed out, so that you can easily identify the borders. There are also two markers in the ruler with the name of the active part, marking its beginning and end. These can be moved freely to change the part borders.

- To switch between parts, activate them via key commands. In the **Key Commands** dialog, there are two functions in the **Edit** category: **Activate Next Part** and **Activate Previous Part**. If you assign key commands to these, you can use them to cycle between parts.

RELATED LINKS

[Key Commands](#) on page 801

[Audio Part Editor Toolbar](#) on page 412

Sampler Tracks

The sampler track feature allows you to chromatically play back any audio from your audio sample library via MIDI. You can create and edit new sounds based on specific samples and integrate them into an existing project.

The sampler track feature includes:

- The **Sampler Control** section in the lower zone of the **Project** window. Here, you can load and edit audio samples, choose between different playback modes, or transfer samples to Steinberg VST instruments.
- A sampler track in your project that allows you to control the playback of the sample that is loaded in **Sampler Control** via MIDI.

RELATED LINKS

[Sampler Control](#) on page 423

[Sampler Tracks](#) on page 112

[Creating Sampler Tracks](#) on page 422

Loading Audio Samples into Sampler Control

You can load audio samples into **Sampler Control** by dragging.

Cubase allows you to load mono or stereo samples in .wav or .aiff file format or REX and REX2 audio files created by ReCycle from Propellerhead Software into **Sampler Control**.

- To load an audio sample, drag it from the **MediaBay**, the **Project** window event display, or the File Explorer/macOS Finder, and drop it in **Sampler Control**.

IMPORTANT

If **Sampler Control** already contains an audio sample, this sample and all of its settings are overwritten.

NOTE

- Audio samples that you load into **Sampler Control** are not copied to the project audio folder. If you want to archive or share your project, including all audio samples that you have loaded into **Sampler Control**, you must create a self-contained project.
- In the **Pool**, all audio samples that you have loaded into **Sampler Control** are listed in a dedicated sampler track subfolder in the main audio folder.
- Imported REX and REX2 files are converted to files in .wav format. These files are stored in a wav folder, created in addition to the original file.

In **Sampler Control**, slicing is activated, and hitpoints are set according to the slice markers of the imported REX file.

RELATED LINKS

[Self-Contained Projects](#) on page 94

[Pool](#) on page 446

[Playback Section](#) on page 428

Loading MIDI Parts into Sampler Control

You can load MIDI parts from instrument tracks or MIDI tracks into **Sampler Control** by dragging.

NOTE

For this to work, the instrument track or the MIDI track must be routed to a VST instrument.

- To load a MIDI part, drag it from the **MediaBay**, the **Project** window event display, or the File Explorer/macOS Finder, and drop it in **Sampler Control**.

IMPORTANT

If **Sampler Control** already contains MIDI, it is overwritten.

Cubase creates an audio file from the MIDI part. This includes the instrument sound and the channel settings from the VST instrument or the return channel. The audio file is copied to the project audio folder.

RELATED LINKS

[VST Instruments](#) on page 510

[Instrument Track Inspector](#) on page 110

[MIDI Track Inspector](#) on page 116

Creating Sampler Tracks

To create a sampler track, do one of the following:

- In the **Project** window, select an audio event, and select **Audio > Create Sampler Track**.
- In the **MediaBay**, right-click an audio file, and select **Create Sampler Track**.
- In the **Sample Editor Inspector**, open the **Range** section, and click **Create Sampler Track**. This creates a sampler track from the selected range. If no range is selected, the entire event is used.
- From the context menu of the track list, select **Add Sampler Track**. In this case, **Sampler Control** is empty, and you must load an audio sample by dragging.

Sampler Control

If the sampler track is selected, **Sampler Control** is available in the lower zone of the **Project** window. **Sampler Control** allows you to view, edit, and play back samples or specific sections of the samples.



1 Toolbar

Contains tools that allow you to select and edit the audio sample, to organize track presets, and to transfer the sample, including its settings, to an instrument.

2 Waveform display/Envelope editor

Shows the waveform image of the sample. Allows you to define the playback range for the sample and to set a loop.

If the envelope editors for the pitch, the filter, or the amp section are shown, you can adjust their envelope curve settings here.

3 Playback and Sound Parameter section

Allows you to make settings for playback, warping, and slicing (**Playback** section), tuning and pitch modulation (**Pitch** section), filtering (**Filter** section), and level and panorama (**Amp** section).

4 Keyboard section

Allows you to set the key range of the sample, its root key, and the modulation range of the pitchbend wheel. These settings are used if you work with an external MIDI device.

RELATED LINKS

[Creating Sampler Tracks](#) on page 422

[Waveform Display](#) on page 427

[Envelope Editors](#) on page 433

[Playback and Sound Parameters](#) on page 428

[Keyboard Section](#) on page 437

Sampler Control Toolbar

The **Sampler Control** toolbar contains various settings and functions.

Read Automation



Allows you to read track automation.

Write Automation



Allows you to write track automation.

Switch between A/B Settings



Allows you to switch between different parameter settings.

Event Received Indicator



This LED indicates incoming MIDI messages via the selected MIDI input. The LED lights up on receiving note-on and controller messages. This way, you can check if Cubase and your MIDI keyboard are connected to the same MIDI device input.

Snap to Zero Crossing



Restricts sample editing to zero crossings, that is, to positions where the amplitude is zero.

Auto-Scroll



Keeps the project cursor visible during playback.

Preset section

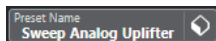

Shows the name of the track preset that is loaded for the sampler track. You can also save and load presets.

Import Audio File



Opens the **Import Audio** dialog that allows you to load an audio file into **Sampler Control**.

NOTE

If **Sampler Control** already contains an audio file, the original file is replaced by the new file.

File Name

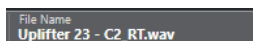

Shows the file name of the sample.

Tempo



Shows the tempo of the loop, as read from the sample file or calculated from the sample length. In **Slice** playback mode, you can manually adjust this value.

Root Key



Shows the root key that determines the pitch of the sample. You can change the root key by entering a new value in the value field or by dragging the root key handle on the **Sampler Control** keyboard.

Fixed Pitch



If a sample is triggered by a MIDI note other than the one defined by the **Root Key** setting, the sample is pitched accordingly. If **Fixed Pitch** is activated, the relation between played note and root key is disregarded, and all keys play the sample just as it was recorded.

NOTE

This setting is only available in **Normal** and **AudioWarp** playback mode.

Loop Mode

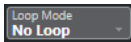

Allows you to select a loop mode for playback via MIDI.

- If this is set to **No Loop**, the sample is played once.
- If this is set to **Continuous**, the sample is played in a continuous loop.
- If this is set to **Alternate**, the sample is played back in a loop that alternates between forward and backward playback.
- If this is set to **Once**, the sample is looped once.
- If this is set to **Until Release**, the sample is looped repeatedly until you release the key on the keyboard.
- If this is set to **Alternate Until Release**, the loop alternates between forward and backward playback for as long as you hold the key.

NOTE

This setting is only available in **Normal** and **AudioWarp** playback mode.

Signature



Shows the detected time signature of the sample. You can manually adjust this value.

NOTE

This setting is only available in **Slice** playback mode.

Bars/Beats



These value fields show the detected length of the sample in bars and beats. You can manually adjust these values, which affects the grid and the tempo.

NOTE

This setting is only available in **Slice** playback mode.

Grid



Sets the grid.

NOTE

This setting is only available in **Slice** playback mode.

One Shot



The sample is played back once from beginning to end, regardless of any loop settings.

Normalize Sample

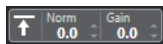

Normalizes the sample by detecting the highest peak level in the sample and adjusting the gain so that it reaches the set **Normalization Level** value. **Sample Gain** allows you to manually modify the gain value afterwards.

Trim Sample



Trims the sample to a selected range. If no range is selected, the sample is trimmed to the range that is set with the sample start/end markers. **Revert to Full Sample** resets the sample to its original range.

NOTE

This setting is only available in **Normal** and **AudioWarp** playback mode.

Reverse Sample



Reverses the sample. This allows you to play back the sample backwards.

Monophonic Mode



Activates monophonic playback. For solo instruments, this usually results in a more naturally sounding performance. With monophonic playback activated, a note that was stolen by another note is retriggered if you still hold the stolen note when you release the new one. You can play trills by holding one note and quickly and repeatedly pressing and releasing another note, for example.

NOTE

If **Monophonic Mode** is deactivated, you can play up to 128 notes simultaneously.

If **Legato Mode** is activated as well and you play legato notes, only the pitch of the sample is set to the new note. The sample is not retriggered, and the envelopes keep running.

Lock Parameter Settings



With this option is activated, the current **Sampler Control** parameter settings are kept if you load another sample into **Sampler Control**.

NOTE

Parameters that are directly related to the sample, for example, sample start/end, loop start/end, root key, or tempo are not kept, but taken from the new sample instead.

MIDI Reset



Stops playback and resets all MIDI controllers to their default values.

This is useful, for example, if you want to stop the playback of a long audio sample in **One Shot** mode.

Transfer to New Instrument



Allows you to transfer the audio sample with all its **Sampler Control** settings to an instrument that is loaded to a new instrument track.

Open in Separate Window



Opens **Sampler Control** in a separate window.

Open in Lower Zone



Opens **Sampler Control** in the lower zone.

RELATED LINKS

[Setting the Root Key Manually](#) on page 439

[Setting up Loops for Audio Samples](#) on page 438

[Normalizing Samples](#) on page 441

[Transferring Samples from Sampler Control to VST Instruments](#) on page 444

Waveform Display

The waveform display shows the waveform of your audio sample. It allows you to define the start and the end of the audio sample, of the loop, and of the fade-in/-out.



Set Sample Start

Defines the sample start. On playback, all audio before the sample start is ignored.

Set Sample End

Defines the sample stop. On playback, all audio after the sample end is ignored.

Set Sample Start and End Markers Simultaneously

When you move the mouse cursor between the sample start and the end marker, a connecting bar appears at the height of the marker flags. Dragging this bar moves both markers simultaneously whilst keeping their relative distance to each other.

Set Sustain Loop Start

Defines where the sustain loop starts.

Set Sustain Loop End

Defines where the sustain loop ends. When this marker is reached, playback jumps back to start of the sustain loop.

Set Sustain Loop Start and End Markers Simultaneously

When you move the mouse cursor between the sustain loop start and end marker, a connecting bar appears at the height of the marker flags. Dragging this bar moves both markers simultaneously whilst keeping their relative distance to each other.

Set Fade In Length

Defines the fade-in length.

Set Fade Out Length

Defines the fade-out length.

Set Sustain Loop Crossfade Length

Loop crossfades allow for smoother loops. This marker defines the length for the loop crossfade.

Ruler

The ruler shows the timeline in the specified display format.

- To select the format, click the arrow button to the right of the ruler, and select an option from the pop-up menu.
You can display bars and beats, seconds, or samples.

Zooming

- To zoom in/out on the time and level axes, use the horizontal and vertical zoom sliders or the corresponding key commands.

RELATED LINKS

[Key Commands](#) on page 801

Playback and Sound Parameters

In the sections below the waveform display, you can edit the settings for playback, warping, and slicing (**Playback** section), tuning and pitch modulation (**Pitch** section), filtering (**Filter** section), and level and panorama (**Amp** section).

RELATED LINKS

[Playback Section](#) on page 428

[Pitch Section](#) on page 431

[Filter Section](#) on page 432

[Amp Section](#) on page 432

Playback Section

In the playback section, you can choose different playback options.

Playback Tab

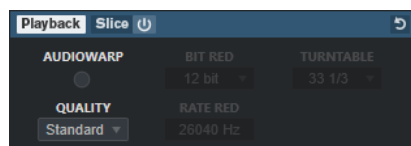

Quality

Sets the quality for sample playback. When samples are played back with a pitch other than their original one, you can choose between different algorithms for transposing them in real time.

- **Standard, High, Best,** and **Extreme** provide different algorithms for transposing samples in real time. The higher the quality setting, the better the suppression of

artifacts, particularly with higher frequencies. Better quality settings, however, also lead to higher processor load. For samples with little high-frequency content, we recommend to use **Standard** quality.

- **Vintage** allows for a deliberate reduction of playback quality by lowering the bit rate and the sample rate to emulate the artifacts of early samplers. **Turntable** emulates a memory-optimized sampling workflow of the past, where turntables were sampled at a higher speed to record short samples, and then tuned down again to correct for the change in pitch. A value of **45** rpm leads to typical vintage artifacts. A value of **78** rpm allows you to increase the effect even further.

NOTE

This option is only available if **AudioWarp** is deactivated.

AudioWarp

Activates/Deactivates AudioWarp for sample playback. AudioWarp allows you to apply time stretching and formant shifting to your samples. You can choose between different warp and sync modes.

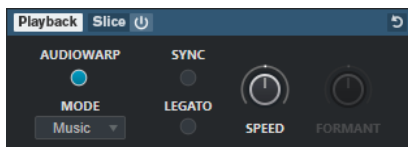

If **AudioWarp** is activated, the following options are available in the **Playback** section:

Mode

Sets the AudioWarp mode.

- **Music** mode offers parameters for time stretching. This mode is suitable for complex material such as drum loops and samples of mixed music. It uses considerably more CPU time than **Solo** mode.

NOTE

The more the sample is stretched, the higher the CPU load.

- **Solo** mode offers parameters for time stretching and formant shifting. This mode is suitable for loops and samples of solo instruments or vocals.

Sync

You can set the playback speed of the sample manually or sync it to the project tempo.

- If **Sync** is deactivated, **Speed** allows you to set the playback speed of the sample manually, in percent.

NOTE

If you set the AudioWarp mode to **Music**, the minimum playback speed adjustment is 12.5 %. Values below this limit have no effect.

- If **Sync** is activated, **Original BPM** allows you to enter the original tempo of the sample in beats per minute. The playback speed of the sample is adjusted to match the tempo of Cubase.

NOTE

If you set the AudioWarp mode to **Music**, the lower limit of the playback speed adjustment is 12.5 %. Values below this limit have no effect.

Legato

If this option is deactivated, each note that is played via MIDI starts playback from the **Sampler Control** position cursor.

If this option is activated, the first note starts playback from the position cursor, and any of the following notes start from the current playback position, for as long as the first note is held.

Formant

Allows you to adjust formant shifting. Formant shifting prevents so-called Mickey Mouse effects when pitch-shifting a sample. This is especially useful for samples of human voices or acoustic instruments.

This parameter is available in AudioWarp mode **Solo** only.

Slice Tab

You can create slices of a sample. These are automatically mapped to the keyboard, so that each slice can be played back individually. During that process, a MIDI phrase that corresponds to the sliced sample is created. If you drag this MIDI phrase to the **Project** window and drop it on the sampler track, a MIDI part is created. Use this part to play back the slices in their original order, or to rearrange the events in the MIDI part in order to change their playback order.

Enabling **Activate/Deactivate Slicing** automatically slices the sample. You can choose between different slice detection modes or combine them. You can manually adjust the position of the slice markers by dragging, and you can **Alt**-click to add or remove slices.

NOTE

Slice playback uses the settings for **Quality** and **AudioWarp** on the **Playback** tab.

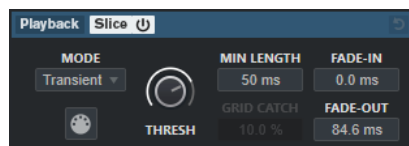

Slice Playback On/Off

Activates/Deactivates slice playback.

Mode

Sets the slice detection mode.

- **Transient** mode allows you to specify the **Threshold** that determines the minimum peak level that a transient needs to become a hitpoint.
- **Grid** mode sets the hitpoints according to the **Grid Resolution** on the **Sampler Control** toolbar.
- **Transient + Grid** mode combines the conditions of both **Transient** and **Grid** mode.
- **Manual** mode allows you to add and to remove slices manually by **Alt**-clicking in the waveform. In this mode, no automatic hitpoint detection is performed.

Threshold

Determines the minimum level that a hitpoint needs to be detected as the start of a new slice.

Minimal Length

Sets the minimal length of a slice.

Grid Catch

In **Transient + Grid** slice detection mode, this parameter specifies how close to the grid a hitpoint must be.

Fade In

Sets the fade-in time for all slices of the loop.

Fade Out

Sets the fade-out time for all slices of the loop.

Drag MIDI Phrase to Project

Click this button, and drag it to the event display to create a MIDI part that corresponds to the sample in your project.

RELATED LINKS

[Slicing Samples](#) on page 441

Pitch Section

In the **Pitch** section, you can adjust the tuning and the pitch of your audio sample. The pitch envelope allows you to modulate the pitch over time.

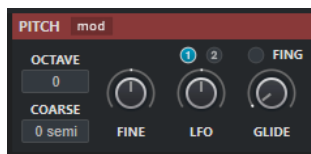

Show/Hide Pitch Modulators

Shows/Hides the pitch envelope and the LFO editor in the waveform window.

Octave

Sets the pitch of the sample in octave steps.

Coarse

Sets the pitch of the sample in semitone steps.

Fine

Fine-tunes the pitch of the sample in cents (hundredths of a semitone).

LFO

Allows you to select the LFO and to set the LFO modulation depth.

Glide

Specifies the time that is needed to bend the pitch of the sample from one note to the following note. If you move this control all the way to the left, **Glide** is deactivated.

If **Fingered** is activated, the pitch only glides between notes that are played legato.

RELATED LINKS

[Envelope Editors](#) on page 433

Filter Section

In the **Filter** section, you can adjust the tone color of the sample sound. The filter envelope allows you to control the cutoff frequency to shape the harmonic content over time.

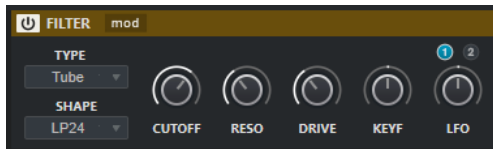

Filter On/Off

Activates/Deactivates the filtering effect.

Show/Hide Filter Modulators

Shows/Hides the filter envelope and the LFO editor in the waveform window.

Type

Sets the filter type.

Shape

Sets the filter shape.

Cutoff

Controls the cutoff frequency of the filter.

Resonance

Sets the filter resonance.

Drive

Determines the level of the input signal and thus, the amount of saturation.

Cutoff Key Follow

Sets the cutoff modulation via the note number. Increase this parameter to raise the cutoff with higher notes. At 100 %, the cutoff frequency follows the played pitch exactly.

LFO

Allows you to select the LFO and to set the LFO modulation depth.

RELATED LINKS

[Envelope Editors](#) on page 433

Amp Section

In the **Amp** section, you can set the volume and the pan of the sample. The amplifier envelope allows you to shape the volume over time.

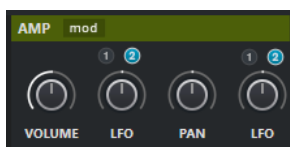

Show/Hide Amp Modulators

Shows/Hides the amp envelope and the LFO editor in the waveform window.

Volume

Sets the level of the sample.

Volume LFO

Allows you to select the volume LFO and to set the volume LFO modulation depth.

Pan

Sets the position of the sample in the stereo panorama.

Pan LFO

Allows you to select the pan LFO and to set the pan LFO modulation depth.

RELATED LINKS

[Envelope Editors](#) on page 433

Envelope Editors

You can adjust the **Pitch**, **Filter**, and **Amp** envelope curves. Each of these envelopes can contain up to 128 nodes.

- Click **Show/Hide Pitch Modulators**, **Show/Hide Filter Modulators**, or **Show/Hide Amp Modulators** in the section header to show/hide the corresponding envelope editor and the LFO section.



Pitch Envelope

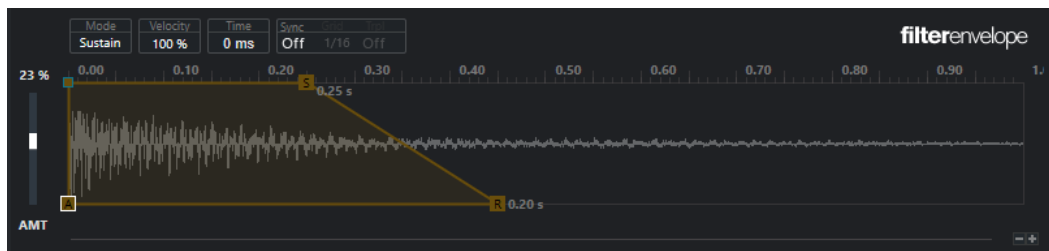

Filter Envelope



Amp Envelope

Envelope Amount

Determines how much the selected envelope affects the audio. This parameter allows for positive and negative values. If the **Envelope Amount** is set to 0, the envelope has no effect.

NOTE

This parameter is only available for **Pitch** and **Filter**.

Envelope display

Shows the pitch, filter, or amp envelope curve. You can adjust it by adding, moving, and deleting nodes. The nodes for attack (**A**), sustain (**S**), and release (**R**) are always shown and cannot be deleted. Next to the release node, the release time of the envelope is shown.

Mode

Determines how the corresponding envelope is played back when it is triggered.

- Select **Sustain** to play the envelope from the first node to the sustain node. The sustain level is held for as long as you play the note. When you release the note, the envelope continues with the stages following the sustain. This mode is suited for looped samples.
- Select **Loop** to play back the envelope from the first node to the loop nodes. Then, the loop is repeated for as long as the key is held. When you release the note, the envelope continues playing the stages that follow the sustain. This mode is suited for adding motion to the sustain of the envelope.
- Select **One Shot** to play the envelope from the first to the last node, even if you release the key. The envelope has no sustain stage. This mode is suited for drum samples.
- Select **Sample Loop** to preserve the natural attack of the sample. The decay of the envelope does not start until the sample has reached the sample loop start.

If you set the second node to the maximum level and use the following nodes to shape the decay during the loop phase of the sample, the envelope only affects the loop phase. The attack of the envelope is still executed.

Velocity

Determines how the velocity affects the level of the corresponding envelope.

The level of the envelope depends on the velocity setting and on how hard you hit a key. The higher the values and the harder you hit a key, the more the level of the envelope increases.

Time

Sets the time value for the selected node.

Sync

Activates/Deactivates tempo sync for the corresponding envelope. **Grid** sets the base note value for tempo-syncing the envelope. **Trpl** allows you to set triplet base notes.

RELATED LINKS

[Selecting Nodes](#) on page 434

[Adding and Removing Nodes](#) on page 435

[Adjusting the Envelope Curve](#) on page 435

[Zoom Functions in the Envelope Editors](#) on page 435

[Synchronizing Envelopes to the Project Tempo](#) on page 440

Selecting Nodes

You can select single nodes or multiple nodes. Selected nodes are edited together.

- To select a node, click on it in the graphical editor.

The **Time** field at the top of the graphical envelope editor shows the parameters of the selected node.

- To add a node to a selection, **Shift**-click the node.
- To select multiple nodes, draw a rectangle around them with the mouse.
If multiple nodes are selected, the **Time** field shows the parameters of the node that is indicated by a white border.
- To select all envelope nodes, press **Ctrl/Cmd - A**.
- If the envelope editor has the keyboard focus, you can select the next or the previous node using **Left Arrow** and **Right Arrow**.

RELATED LINKS

[Keyboard Focus in the Project Window](#) on page 63

Adding and Removing Nodes

You can add up to 128 nodes to an envelope curve.

- To add a node, double-click at the position where you want to add the node.
- To remove a node, double-click it.
- To delete several selected nodes, press **Delete** or **Backspace**.

NOTE

- You cannot remove the attack (**A**), the sustain (**S**), or the release node (**R**).
- All nodes added after the sustain node always affect the release phase of the envelope.

Adjusting the Envelope Curve

The envelope editor allows you to adjust the envelope curve by dragging.

- To move a node horizontally or vertically, click and drag it.
- To move the envelope curve vertically between two nodes, click and drag it.

Zoom Functions in the Envelope Editors

The vertical axis of the envelope editor displays the level. The horizontal axis displays the time.

- To zoom in or out, click the **+** or **-** buttons to the right of the scrollbar below the envelope editor or use the corresponding key commands.
- To zoom in or out at the current position, click in the timeline, and drag up or down.
- To zoom to a specific region, hold **Alt/Opt**, and click and drag the mouse over the region.

RELATED LINKS

[Key Commands](#) on page 801

LFO Editor

Sampler Control provides two monophonic LFOs. These LFOs are only calculated once and feed all voices at the same time.

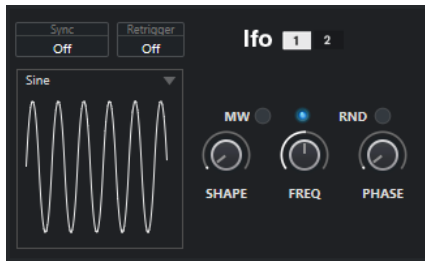

LFO

Allows you to select LFO 1 or 2 for editing.

Sync

Defines how the speed of the corresponding LFO is set.

- **Off** allows you to set the LFO speed in Hz.
- **Tempo + Retrig** allows you to set the LFO speed in note values. The resulting rate depends on the tempo of your project.
- **Tempo + Beat** allows you to set the LFO speed in note values. The resulting rate depends on the tempo of your project. Additionally, the current start phase is calculated based on the current position.

Retrigger

Defines whether the LFO is restarted with the specified start phase when a new note is triggered. This parameter is available for the sync modes **Off** and **Tempo + Retrig**.

- If **Off** is selected, the LFO is not restarted.
- **First Note** restarts the LFO when a note is triggered and no other note is held.
- **Each Note** restarts the LFO every time that a note is triggered.

MW

Allows you to scale the output level of the LFO via the modulation wheel of your keyboard. This allows you, for example, to control the vibrato of the sound with the modulation wheel.

Waveform

Sets the waveform for the selected LFO. You can adjust the selected waveform using the **Shape** control to the right.

- **Sine** produces smooth modulation, suitable for vibrato or tremolo. **Shape** adds additional harmonics to the waveform.
- **Triangle** is similar to **Sine**. **Shape** continuously changes the triangle waveform to a trapezoid.
- **Saw** produces a ramp cycle. **Shape** continuously changes the waveform from ramp down to triangle to ramp up.
- **Pulse** produces stepped modulation, where the modulation switches abruptly between two values. **Shape** continuously changes the ratio between the high and the low state of the waveform. If **Shape** is set to 50 %, an even square wave is produced.
- **Ramp** is similar to the **Saw** waveform. **Shape** increasingly adds silence before the sawtooth ramp up begins.

- **Log** produces a logarithmic modulation. **Shape** continuously changes the logarithmic curvature from negative to positive.
- **S & H 1** produces randomly stepped modulation, where each step is different. When fully turned right, **Shape** puts ramps between the steps and changes the sample and hold signal into a smooth random signal.
- **S & H 2** is similar to **S & H 1**. The steps alternate between random high and low values. When fully turned right, **Shape** puts ramps between the steps and changes the sample and hold signal into a smooth random signal.

Freq

Controls the frequency of the modulation, that is, the speed of the LFO.

If **Sync** is activated for the corresponding LFO, the speed is specified in fractions of beats. If **Sync** is deactivated, you can set the frequency in Hz.

Phase

Sets the initial phase of the waveform when the LFO is retriggered. If **RND** is activated, each note starts with a randomized start phase.

Keyboard Section

In the keyboard section of **Sampler Control**, you can set the root key and the key range of the sample as well as the modulation range of the pitchbend wheel on your MIDI keyboard.



Pitchbend



Determines the maximal modulation that is applied when you move the pitchbend wheel on your MIDI keyboard. You can set the pitchbend range in semitone steps, up to 24 semitones.

Key range handles



Determine the key range of the sample.

NOTE

The set key range is used in **Normal** and **AudioWarp** mode.

Root key handle



Determines the root key of the sample.

RELATED LINKS

- [Setting the Root Key Manually](#) on page 439
- [Setting the Key Range](#) on page 439

Sample Editing and Playback Functions

All sample editing in **Sampler Control** is non-destructive.

Setting Sample Start and End

By setting the sample start and end, you can define what range of the sample is played back when you press a key on your MIDI keyboard.

PREREQUISITE

You have loaded a sample into **Sampler Control**.

PROCEDURE

1. In the waveform display, drag the **Set Sample Start** handle to the right to adjust the sample start point.
 2. Drag the **Set Sample End** handle to the left to adjust the sample end point.
-

RESULT

When you trigger the sample, only the defined range between start and end handle is played back.

AFTER COMPLETING THIS TASK

- You can move both sample start and end markers simultaneously whilst keeping their relative distance to each other by moving the mouse cursor between the two markers and dragging the connecting bar.

NOTE

This only works if no loop mode is selected.

- You can trim the sample length to the defined playback range by clicking **Trim Sample** in the **Sampler Control** toolbar.

RELATED LINKS

[Waveform Display](#) on page 427

[Sampler Control Toolbar](#) on page 423

Setting up Loops for Audio Samples

You can set up a loop that is played back when the sample is triggered.

PREREQUISITE

You have loaded a sample into **Sampler Control**.

PROCEDURE

1. On the toolbar, click **Loop Mode**, and select a loop mode from the pop-up menu.
The **Set Sustain Loop Start** and **Set Sustain Loop End** handles and the green loop range overlay are shown.
2. Drag the **Set Sustain Loop Start** and **Set Sustain Loop End** handles to adjust the loop start and end points.
To create a smooth loop transition, try to match the shape of the green loop range overlay with the shape of the gray sample waveform.

NOTE

You cannot drag the loop start and end points outside the defined sample range.

RESULT

When you trigger the sample in a loop mode, the defined loop range is used.

AFTER COMPLETING THIS TASK

- You can move both start and end markers simultaneously by dragging the area between the loop markers.

RELATED LINKS

[Setting Sample Start and End](#) on page 438

Setting the Root Key Manually

The **Root Key** shows the original pitch of the sample. Sometimes, if the sample does not contain any root key information or if you want the sample to play at a different pitch, you must set the root key manually. In **Slice** mode, lowering the root key allows you to increase the number of slices that can be mapped to your keyboard.

NOTE

If you load a sample that does not contain any root key information, the root key is automatically set to C3.

PROCEDURE

- Do one of the following:
 - In the keyboard section of **Sampler Control**, click and drag the root key handle.
 - On the toolbar of **Sampler Control**, double-click in the **Root Key** field, and enter the new root key via your computer keyboard, your mouse wheel, or your MIDI keyboard.
-

RELATED LINKS

[Keyboard Section](#) on page 437

[Setting the Key Range](#) on page 439

[Slicing Samples](#) on page 441

Setting the Key Range

You can determine the key range for the sample. This is useful for samples that only sound good within a certain key range.

PREREQUISITE

You have loaded a sample into **Sampler Control**.

PROCEDURE

- In the keyboard section, adjust the key range by dragging the range handles above the keyboard display.
-

RESULT

Only keys within the determined key range play a sound when triggered.

RELATED LINKS

[Keyboard Section](#) on page 437

Playing Back Samples

After you have loaded an audio sample into **Sampler Control**, you can play back the sample using an external MIDI keyboard or the **On-Screen Keyboard**.

PREREQUISITE

You have loaded a sample into **Sampler Control** and made all sample editing and settings. You have installed and set up your MIDI keyboard.

PROCEDURE

1. In the track list, activate **Monitor** for the sampler track.
2. Optional: On the **Sampler Control** toolbar, activate **Fixed Pitch**.
This allows you to play back the sample in its original pitch and speed.
3. Hit some notes on your keyboard or use the **On-Screen Keyboard** to play back the sample.

RESULT

If **Fixed Pitch** is deactivated, the sample is played back, and the pitch is defined by the notes you play. If you hit lower keys, the sample is played back with a low pitch. If you hit higher keys, the sample is played back with a high pitch.

If **Fixed Pitch** is activated, the sample is played back in its original pitch.

AFTER COMPLETING THIS TASK

To use the sound of the edited sample in your project, create or record a MIDI event on the sampler track.

RELATED LINKS

[Monitoring via Cubase](#) on page 215

[On-Screen Keyboard](#) on page 209

[Sampler Control Toolbar](#) on page 423

[MIDI Events](#) on page 156

[Basic Recording Methods](#) on page 211

Synchronizing Envelopes to the Project Tempo

You can synchronize the **Pitch Envelope**, the **Filter Envelope**, and the **Amp Envelope** to the tempo of your project. This allows you to set envelope times that relate to musical time intervals, regardless of tempo changes.

PREREQUISITE

You have loaded a sample into **Sampler Control**.

PROCEDURE

1. In the corresponding envelope section, set **Sync** to **On**.
2. Use **Grid** and **Trpl** to set a note value. This sets the note resolution to which envelope nodes snap when coming close enough.

NOTE

- The **Time** field of an envelope node displays times in fractions of a whole note. The fraction is always reduced to the smallest possible value, for example, 2/16 is displayed as 1/8.
 - You can also enter note values manually in the **Time** field. Envelope nodes that do not exactly match a note value display the closest note value.
-

Normalizing Samples

You can normalize samples to a target value. An additional gain control allows you to fine-tune the gain value afterwards.

PREREQUISITE

You have loaded a sample into **Sampler Control**.

PROCEDURE

1. On the **Sampler Control** toolbar, set a **Normalization Level** as the target value.
 2. Click **Normalize Sample**.
The sample is normalized to the target value.
 3. Use **Sample Gain** to fine-tune the normalization result.
-

RELATED LINKS

[Sampler Control Toolbar](#) on page 423

Slicing Samples

You can slice samples into several pieces that are mapped to the keyboard, so that you can play every slice individually.

PREREQUISITE

You have loaded a sample into **Sampler Control**.

PROCEDURE

1. In the playback section, select the **Slice** tab, and activate slicing.
 2. Optional: Change the **Slice Mode**, adjust the slicing parameters, and add or delete slicing markers.
 3. Optional: If you want to increase the number of slices that can be mapped to your keyboard, lower the root key in the keyboard section.
-

RESULT

The slices are automatically mapped to the keyboard, starting on the set root key. You can play a slice by pressing the corresponding key on your MIDI keyboard.

AFTER COMPLETING THIS TASK

You can create a corresponding MIDI phrase in your project by dragging the **Drag MIDI Phrase to Project** button to the event display. This allows you to rearrange the order of the slices.

RELATED LINKS

- [Playback Section](#) on page 428
- [Setting the Root Key Manually](#) on page 439
- [Setting the Key Range](#) on page 439

Freezing Sampler Tracks

You can freeze sampler tracks to reduce the real-time processing load.

PROCEDURE

1. Select the sampler track, and open the top **Inspector** section.
 2. Click **Freeze Sampler Channel**.
 3. In the **Freeze Channel Options** dialog, make your changes.
 4. Click **OK**.
-

RESULT

- The output of the sampler track is rendered to an audio file, and on playback you hear the same sound as before freezing.
- Less CPU load is used.
- The **Freeze Sampler Channel** button lights up.
- The track controls are grayed out.
- The MIDI parts are locked.
- You can still adjust the level and panning, make EQ settings, and adjust the effect sends.
- The **Sampler Control** section in the lower zone of the **Project** window is disabled.

NOTE

The audio file is saved in the **Freeze** folder that can be found in the following location:

- Windows: within the **Project** folder
 - macOS: **User/Documents**
-

AFTER COMPLETING THIS TASK

To unfreeze a frozen track, click **Freeze** again.

RELATED LINKS

- [Freeze Channel Options Dialog for Sampler Tracks](#) on page 442
- [Unfreeze Channel Options Dialog for Sampler Tracks](#) on page 443
- [Freezing Multiple Tracks](#) on page 145

Freeze Channel Options Dialog for Sampler Tracks

The **Freeze Channel Options** dialog allows you to specify exactly what should happen if you freeze a sampler track.

To open the **Freeze Channel Options** dialog, select the sampler track, and do one of the following:

- In the top **Inspector** section, click **Freeze Sampler Channel**.
- Select **Edit > Freeze/Unfreeze > Selected Tracks**.

- Right-click the selected track, and from the context menu, select **Freeze/Unfreeze Selected Tracks**.

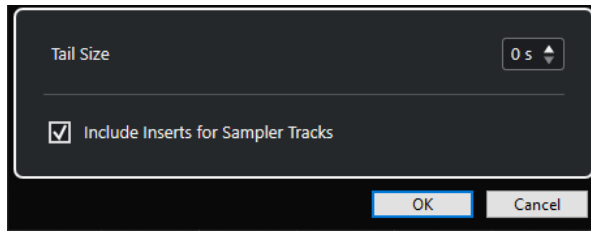

Tail Size

Allows you to set a tail size time to let sounds complete their normal release cycle.

Include Inserts for Sampler Tracks

Activate this option if you want to include insert effects on this channel when freezing the sampler track.

NOTE

You can still adjust level, pan, sends, and EQ.

Deactivate this option if you still want to be able to edit insert effects on this channel.

RELATED LINKS

[Freezing Sampler Tracks](#) on page 442

[Freezing Multiple Tracks](#) on page 145

[Unfreeze Channel Options Dialog for Sampler Tracks](#) on page 443

Unfreeze Channel Options Dialog for Sampler Tracks

The **Unfreeze Channel Options** allows you to specify exactly what should happen if you unfreeze a sampler track.

To open the **Unfreeze Channel Options** dialog, select a frozen sampler track, and do one of the following:

- In the top **Inspector** section, click **Freeze Sampler Channel**.
- Select **Edit > Freeze/Unfreeze > Selected Tracks**.
- Right-click the selected track, and from the context menu, select **Freeze/Unfreeze Selected Tracks**.

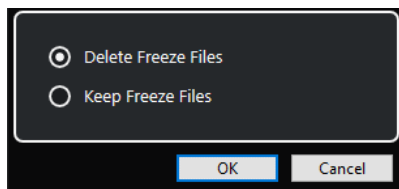

Delete Freeze Files

Deletes the freeze files.

Keep Freeze Files

Keeps the freeze files in the **Freeze** folder that can be found in the following location:

- Windows: within the **Project** folder
- macOS: **User/Documents**

RELATED LINKS

[Freeze Channel Options Dialog for Sampler Tracks](#) on page 442

[Freezing Multiple Tracks](#) on page 145

[Freezing Sampler Tracks](#) on page 442

Transferring Samples from Sampler Control to VST Instruments

You can transfer audio samples to specific Steinberg VST instruments with any settings that you have made in **Sampler Control**.

Transferring audio samples from **Sampler Control** to a VST instrument creates a new instrument track in the track list. This new track is added below the sampler track. The audio sample and all of its settings are loaded in the VST instrument.

You can transfer audio samples from **Sampler Control** to the following Steinberg VST instruments:

- Groove Agent
- Groove Agent SE
- HALion
- Padshop
- Backbone

Transferring a Sample

PREREQUISITE

You have installed Groove Agent, Groove Agent SE, HALion, Padshop, or Backbone. You have loaded an audio sample in **Sampler Control**.

PROCEDURE

1. In the **Sampler Control** toolbar, click **Transfer to New Instrument**.
2. In the pop-up menu, select the instrument to which you want to transfer the sample.

RESULT

In the track list, a new instrument track is created below the sampler track. The instrument track has the same name as the sampler track. The audio sample and its settings are loaded in the selected VST instrument.

NOTE

If a parameter is not available for the VST instrument that you have chosen as the destination, it is either not transferred or it is adapted to a similar parameter in the VST instrument. The following applies:

- Groove Agent/Groove Agent SE: LFO and filter settings are not used.
- Padshop: Sample trimming is not used. A transfer in **AudioWarp** playback mode sets the grain settings to a **Number** of 2 grains and the **Speed** value accordingly. A transfer in **Slice** playback mode uses the selected slice only.

- Backbone: Sample trimming is not used. A transfer in **AudioWarp** playback mode activates **Resynth** mode and sets the **Speed** value accordingly. A transfer in **Slice** playback mode uses the selected slice only.
-

RELATED LINKS

[Transferring a Sample](#) on page 444

Pool

Every time that you record on an audio track, a file is created on your hard disk. A reference to this file, a clip, is added to the **Pool**.

The following rules apply to the **Pool**:

- All audio and video clips that belong to a project are listed in the **Pool**.
- Every project has a separate **Pool**.

The way the **Pool** displays folders and their contents is similar to the way the File Explorer/macOS Finder displays folders and file lists. In the **Pool**, you can perform operations that affect files on disk and operations that only affect clips.

Operations That Affect Files

- Importing clips (audio files can automatically be copied and/or converted)
- Converting file formats
- Renaming clips (this also renames the referenced files on disk) and regions
- Deleting clips
- Preparing file archives for backup
- Minimizing files

Operations That Affect Clips

- Copying clips
- Auditioning clips
- Organizing clips
- Applying audio processing to clips

Pool Window

The **Pool** window allows you to manage the media files of the active project.

To open the **Pool**, do one of the following:

- On the **Project** window toolbar, click **Open Pool Window**. If this icon is not visible, activate the **Media & MixConsole Windows** option on the toolbar context menu.
- Select **Project > Pool**.
- Select **Media > Open Pool Window**.

Media	Used	Status	Mus	Tempo	Sign.	Key	Algorithm	Info	Type	Date	Origin Time	Image	Path
Audio													
Record													
✦ Bass Drum In	1			130.00	4/4	-	élastique Pro	44.100 kHz 24 bit Mono 2:26 m	Wave	11/22/2010	3. 3. 2. 99	[Windows] C:\Users	
✦ Bass-01	3			130.00	4/4	-	élastique Pro	44.100 kHz 24 bit Mono 2:11 m	Wave	11/22/2010	7. 3. 1. 87	[Windows] C:\Users	
✦ Bass Drum Out	1			130.00	4/4	-	élastique Pro	44.100 kHz 24 bit Mono 2:26 m	Wave	11/22/2010	3. 3. 2. 99	[Windows] C:\Users	
✦ Choir	3			130.00	4/4	-	élastique Pro	44.100 kHz 24 bit Stereo 1:28 m	Wave	11/22/2010	15. 1. 2. 19	[Windows] C:\Users	
✦ Close L-01	1			130.00	4/4	-	élastique Pro	44.100 kHz 24 bit Mono 2:26 m	Wave	11/22/2010	3. 3. 2. 99	[Windows] C:\Users	
✦ Close R-01	1			130.00	4/4	-	élastique Pro	44.100 kHz 24 bit Mono 2:26 m	Wave	11/22/2010	3. 3. 2. 99	[Windows] C:\Users	
✦ Doubled Voice	1			130.00	4/4	-	élastique Pro	44.100 kHz 24 bit Mono 2:08 m	Wave	11/22/2010	12. 4. 3. 80	[Windows] C:\Users	
✦ FX Voices	1			130.00	4/4	-	élastique Pro	44.100 kHz 24 bit Stereo 2:08 m	Wave	11/22/2010	12. 4. 2. 56	[Windows] C:\Users	
✦ HiHat-01	1			130.00	4/4	-	élastique Pro	44.100 kHz 24 bit Mono 2:26 m	Wave	11/22/2010	3. 3. 2. 99	[Windows] C:\Users	
✦ Lead Guitar	2			130.00	4/4	-	élastique Pro	44.100 kHz 24 bit Stereo 2:04 m	Wave	11/22/2010	4. 1. 2. 49	[Windows] C:\Users	
✦ Lead Voice	1			130.00	4/4	-	élastique Pro	44.100 kHz 24 bit Mono 2:17 m	Wave	11/22/2010	7. 4. 3. 22	[Windows] C:\Users	
✦ Mono	1			130.00	4/4	-	élastique Pro	44.100 kHz 24 bit Mono 2:26 m	Wave	11/22/2010	3. 3. 2. 99	[Windows] C:\Users	
✦ Overhead L	1			130.00	4/4	-	élastique Pro	44.100 kHz 24 bit Mono 2:26 m	Wave	11/22/2010	3. 3. 2. 99	[Windows] C:\Users	
✦ Overhead R	1			130.00	4/4	-	élastique Pro	44.100 kHz 24 bit Mono 2:26 m	Wave	11/22/2010	3. 3. 2. 99	[Windows] C:\Users	
✦ Rhythm Guitar 2	1			130.00	4/4	-	élastique Pro	44.100 kHz 24 bit Stereo 1:56 m	Wave	11/22/2010	19. 3. 1. 67	[Windows] C:\Users	
✦ Rhythm Guitar 3	1			130.00	4/4	-	élastique Pro	44.100 kHz 24 bit Stereo 2:11 m	Wave	11/22/2010	11. 2. 3. 15	[Windows] C:\Users	
✦ Rhythm Guitar1	2			130.00	4/4	-	élastique Pro	44.100 kHz 24 bit Stereo 2:22 m	Wave	11/22/2010	2. 1. 1. 0	[Windows] C:\Users	
✦ Snare Bottom	1			130.00	4/4	-	élastique Pro	44.100 kHz 24 bit Mono 2:26 m	Wave	11/22/2010	3. 3. 2. 99	[Windows] C:\Users	
✦ Snare Top	1			130.00	4/4	-	élastique Pro	44.100 kHz 24 bit Mono 2:26 m	Wave	11/22/2010	3. 3. 2. 99	[Windows] C:\Users	
✦ Solo_1	12			130.00	4/4	-	Standard - Mi	44.100 kHz 24 bit Mono 17.365 s	Wave	11/22/2010	51. 3. 1. 80	[Windows] C:\Users	
✦ Solo_2	13			130.00	4/4	-	Standard - Mi	44.100 kHz 24 bit Mono 17.166 s	Wave	11/22/2010	51. 3. 1. 20	[Windows] C:\Users	
✦ Solo_3	14			130.00	4/4	-	Standard - Mi	44.100 kHz 24 bit Mono 17.074 s	Wave	11/22/2010	51. 3. 1. 80	[Windows] C:\Users	
✦ Solo_4	13			130.00	4/4	-	Standard - Mi	44.100 kHz 24 bit Mono 16.544 s	Wave	11/22/2010	51. 3. 1. 50	[Windows] C:\Users	
✦ Tom 1-02	1			130.00	4/4	-	élastique Pro	44.100 kHz 24 bit Mono 2:26 m	Wave	11/22/2010	3. 3. 2. 99	[Windows] C:\Users	
✦ Tom 2	1			130.00	4/4	-	élastique Pro	44.100 kHz 24 bit Mono 2:26 m	Wave	11/22/2010	3. 3. 2. 99	[Windows] C:\Users	

The content of the **Pool** is divided into the following folders:

Audio folder

Contains all audio clips and regions that are in the project.

If the project contains one or more sampler tracks, a dedicated **Sampler Track** subfolder is created in the **Audio** folder. This subfolder contains all clips of the samples that you have loaded into **Sampler Control**.

Video folder

Contains all video clips that are in the project.

Trash folder

Contains unused clips that have been moved here from the hard disk for permanent removal.

NOTE

You cannot rename or delete these folders, but you can add any number of subfolders.

Pool Window Columns

The **Pool** window columns display information about the clips and regions.

Media	Used	Status	Mus	Tempo	Sign.	Key	Algorithm	Info	Type	Date	Origin Time	Image	Path
Audio		Record											
Bass Drum In	1	<input type="checkbox"/>		130.00	4/4	-	élastique Pro	44.100 kHz 24 bit Mono 2:26 m	Wave	11/22/2010	3.3.2.99		[Windows] C:\Users
Bass-01	3	<input type="checkbox"/>		130.00	4/4	-	élastique Pro	44.100 kHz 24 bit Mono 2:11 m	Wave	11/22/2010	7.3.1.67		[Windows] C:\Users
Bass Drum Out	1	<input type="checkbox"/>		130.00	4/4	-	élastique Pro	44.100 kHz 24 bit Mono 2:26 m	Wave	11/22/2010	3.3.2.99		[Windows] C:\Users
Choir	3	<input type="checkbox"/>		130.00	4/4	-	élastique Pro	44.100 kHz 24 bit Stereo 1:28 m	Wave	11/22/2010	15.1.2.19		[Windows] C:\Users
Close L-01	1	<input type="checkbox"/>		130.00	4/4	-	élastique Pro	44.100 kHz 24 bit Mono 2:26 m	Wave	11/22/2010	3.3.2.99		[Windows] C:\Users
Close R-01	1	<input type="checkbox"/>		130.00	4/4	-	élastique Pro	44.100 kHz 24 bit Mono 2:26 m	Wave	11/22/2010	3.3.2.99		[Windows] C:\Users
Doubled Voice	1	<input type="checkbox"/>		130.00	4/4	-	élastique Pro	44.100 kHz 24 bit Mono 2:08 m	Wave	11/22/2010	12.4.3.80		[Windows] C:\Users
FX Voices	1	<input type="checkbox"/>		130.00	4/4	-	élastique Pro	44.100 kHz 24 bit Stereo 2:08 m	Wave	11/22/2010	12.4.2.56		[Windows] C:\Users
HiHat-01	1	<input type="checkbox"/>		130.00	4/4	-	élastique Pro	44.100 kHz 24 bit Mono 2:26 m	Wave	11/22/2010	3.3.2.99		[Windows] C:\Users
Lead Guitar	2	<input type="checkbox"/>		130.00	4/4	-	élastique Pro	44.100 kHz 24 bit Stereo 2:04 m	Wave	11/22/2010	4.1.2.49		[Windows] C:\Users
Lead Voice	1	<input type="checkbox"/>		130.00	4/4	-	élastique Pro	44.100 kHz 24 bit Mono 2:17 m	Wave	11/22/2010	7.4.3.22		[Windows] C:\Users
Mono	1	<input type="checkbox"/>		130.00	4/4	-	élastique Pro	44.100 kHz 24 bit Mono 2:26 m	Wave	11/22/2010	3.3.2.99		[Windows] C:\Users
Overhead L	1	<input type="checkbox"/>		130.00	4/4	-	élastique Pro	44.100 kHz 24 bit Mono 2:26 m	Wave	11/22/2010	3.3.2.99		[Windows] C:\Users
Overhead R	1	<input type="checkbox"/>		130.00	4/4	-	élastique Pro	44.100 kHz 24 bit Mono 2:26 m	Wave	11/22/2010	3.3.2.99		[Windows] C:\Users
Rhythm Guitar 2	1	<input type="checkbox"/>		130.00	4/4	-	élastique Pro	44.100 kHz 24 bit Stereo 1:56 m	Wave	11/22/2010	19.3.1.67		[Windows] C:\Users
Rhythm Guitar 3	1	<input type="checkbox"/>		130.00	4/4	-	élastique Pro	44.100 kHz 24 bit Stereo 2:11 m	Wave	11/22/2010	11.2.3.15		[Windows] C:\Users
Rhythm Guitar1	2	<input type="checkbox"/>		130.00	4/4	-	élastique Pro	44.100 kHz 24 bit Stereo 2:22 m	Wave	11/22/2010	2.1.1.0		[Windows] C:\Users
Snare Bottom	1	<input type="checkbox"/>		130.00	4/4	-	élastique Pro	44.100 kHz 24 bit Mono 2:26 m	Wave	11/22/2010	3.3.2.99		[Windows] C:\Users
Snare Top	1	<input type="checkbox"/>		130.00	4/4	-	élastique Pro	44.100 kHz 24 bit Mono 2:26 m	Wave	11/22/2010	3.3.2.99		[Windows] C:\Users
Solo_1	12	<input type="checkbox"/>		130.00	4/4	-	Standard - Ml	44.100 kHz 24 bit Mono 17.365 s	Wave	11/22/2010	51.3.1.80		[Windows] C:\Users
Solo_2	13	<input type="checkbox"/>		130.00	4/4	-	Standard - Ml	44.100 kHz 24 bit Mono 17.166 s	Wave	11/22/2010	51.3.1.20		[Windows] C:\Users
Solo_3	14	<input type="checkbox"/>		130.00	4/4	-	Standard - Ml	44.100 kHz 24 bit Mono 17.074 s	Wave	11/22/2010	51.3.1.80		[Windows] C:\Users
Solo_4	13	<input type="checkbox"/>		130.00	4/4	-	Standard - Ml	44.100 kHz 24 bit Mono 16.544 s	Wave	11/22/2010	51.3.1.50		[Windows] C:\Users
Tom 1-02	1	<input type="checkbox"/>		130.00	4/4	-	élastique Pro	44.100 kHz 24 bit Mono 2:26 m	Wave	11/22/2010	3.3.2.99		[Windows] C:\Users
Tom 2	1	<input type="checkbox"/>		130.00	4/4	-	élastique Pro	44.100 kHz 24 bit Mono 2:26 m	Wave	11/22/2010	3.3.2.99		[Windows] C:\Users

The following columns are available:

Media





Contains the **Audio**, **Video**, and **Trash** folders. If the folders are opened, the clip or region names are shown and can be edited.

Used

Displays how many times a clip is used in the project. If there is no entry in this column, the corresponding clip is not used.

Status

Displays various icons that relate to the current **Pool** and clip status. The following symbols can be displayed:

- **Record** folder  **Record**
Indicates the **Record** folder.
- Process 
Indicates that a clip has been processed.
- Missing 
Indicates that a clip is referenced in the project but missing from the **Pool**.
- External 
Indicates that the file the clip relates to is external, for example, located outside the current **Audio** folder for the project.
- Recorded 

Indicates that the clip has been recorded in the open version of the project. This is useful for quickly finding recently recorded clips.

Musical Mode

You can use **Musical Mode** to tempo-match audio loops to the project tempo. The checkbox in this column allows you to activate or deactivate musical mode. If the **Tempo** column displays "???", you must enter the correct tempo before you can activate **Musical Mode**.

Tempo

Displays the tempo of audio files, if available. If no tempo has been specified, the column displays "???".

Sign.

Displays the time signature, for example, "4/4".

Key

Displays the root key if one has been specified for the file.

Algorithm

Displays the algorithm preset that is used if the audio file is processed.

- To change the default preset, click the preset name, and select another preset from the pop-up menu.

Info

For audio clips, this column displays the sample rate, the bit depth, the number of channels, and the length.

For regions, it displays start and end times in frames.

For video clips, it displays frame rate, the resolution, the number of frames, and the length.

Type

Displays the file format of the clip.

Date

Displays the date when the audio file was last changed.

Origin Time

Displays the original start position where a clip was recorded in the project. As this value can be used as a basis for the **Insert into Project** option in the **Media** or context menu, you can change it if the **Origin Time** value is independent (for example, not for regions).

In the Pool, you can change the value by editing the **Origin Time**. In the **Project** window, you can change the value by moving the event to a new position and selecting **Audio > Update Origin**.

Image

Displays waveform images of audio clips or regions.

Path

Displays the path to the location of a clip on the hard disk.

Reel Name

Audio files may include this attribute, which is then shown in this column. It refers to the reel or tape from which the media was originally captured.

NOTE

You can rearrange the order of the columns by clicking a header and dragging left or right.

Pool Window Toolbar

The toolbar contains tools and settings for working in the **Pool**.

Show Info



Shows/Hides the info line.

Audition



Plays back the selected audio.

Audition Loop



Loops the playback until you deactivate **Audition**.

Audition Volume



Allows you to adjust the volume.

View/Attributes

Allows you to activate/deactivate the attributes that are displayed in the **Pool** window.

+/- All

Opens/Closes all folders.

Import

Allows you to import media files to the **Pool**.

Search

Allows you to search the **Pool** and connected disks for media files.

Project Folder

Displays the path to the folder of the active project.

Pool Record Folder

Displays the path to the **Record** folder of the active project. By default, this is the **Audio** folder. However, you can create a new **Audio** subfolder and designate this as your **Pool Record** folder.

Info Line

The info line shows information about the event or part that you selected from the **Pool**.

- To activate the info line, click **Show Info** at the left of the toolbar.

The info line shows the following information:

Audio Files

The number of audio files in the **Pool**.

Used

The number of audio files in use.

Total Size

The total size of all audio files in the **Pool**.

External Files

The number of files in the **Pool** that do not reside in the project folder (for example, video files).

Search Section

The search section allows you to search the **Pool** and connected disks for media files.

- To open the search section, activate **Search** on the **Pool** window toolbar.

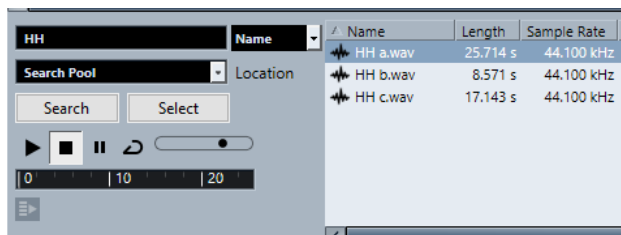

The following elements are available:

Filter

Allows you to set a filter. Click the **Name** to open a pop-up menu to select one of the following search criteria:

- **Name:** partial names or wildcards (*)
- **Size:** less than, more than, equal, between (two values), in seconds, minutes, hours, and bytes
- **Bit Depth:** 8 bit, 16 bit, 24 bit, 32 bit, 32 bit float, 64 bit float
- **Channels:** mono, stereo, and from 3 to 16
- **Sample Rate:** various values, choose **Other** for free setting
- **Date:** various search ranges

Location

Allows you to define a search location.

Search

Starts the search.

Select/Import

Selects the file that you select from the result list in the **Pool** window. If the selected file is not located in the **Pool**, the label of the button changes to **Import**. Click **Import** to import the selected file into the **Pool**.

Previewer

Allows you to listen to the file that you selected from the result list.

Result list

Lists all the files that match the search criteria.

RELATED LINKS

[Searching for Audio Files](#) on page 455

[Using the Extended Search Functionality](#) on page 456

Working with the Pool

NOTE

Most of the **Pool**-related main menu functions are also available on the **Pool** context menu.

Renaming Clips or Regions in the Pool

IMPORTANT

Renaming clips or regions in the **Pool** also renames the referenced files on disk. We recommend to rename clips or regions in the **Pool**. Otherwise, the reference from the clip to the file may get lost.

PROCEDURE

1. In the **Pool** window, select a clip or region, and click the existing name.
 2. Enter a new name and press **Return**.
-

RELATED LINKS

[Missing Files](#) on page 457

Duplicating Clips in the Pool

You can create duplicates of clips and apply different processing methods to them.

NOTE

Duplicating a clip does not create a new file on disk, but a new edit version of the clip that refers to the same audio file.

PROCEDURE

1. In the **Pool** window, select the clip that you want to duplicate.
 2. Select **Media > New Version**.
-

RESULT

A new version of the clip appears in the same **Pool** folder. The duplicated clip is named after the original, with a version number added to it. Regions within a clip are also copied but keep their name.

Inserting Clips into a Project

To insert a clip into a project, you can either use the insert commands on the **Media** menu or drag and drop.

Inserting Clips into a Project via Menu Commands

PROCEDURE

1. In the **Pool** window, select the clips that you want to insert into the project.
2. Select **Media > Insert into Project**, and select one of the insert options.
If several clips are selected, choose whether to insert them on one track or each on a different track.

NOTE

The clips are positioned so that their snap points are aligned with the selected insert position. If you want to adjust the snap point before inserting a clip, double-click a clip to

open the **Sample Editor**. Here, you can adjust the snap position and then perform the insert options.

RESULT

The clip is inserted on the selected track or on a new audio track. If several tracks are selected, the clip will be inserted on the first selected track.

RELATED LINKS

[Adjusting the Snap Point](#) on page 397

Inserting Clips into a Project via Drag and Drop

You can drag a clip from the **Pool** into the **Project** window.

Snap is taken into account if **Snap** is activated.

If you drag the clip into the **Project** window, the cross-hair cursor and a tooltip are shown. The tooltip indicates the timeline position where the snap point of the clip is aligned.

If you position the clip in an empty area of the track list, that is, where no track exists, a new track is created for the inserted event.

NOTE

If you press and hold **Shift** while dragging the clip from the **Pool** onto an event, the clip in this event is replaced.

RELATED LINKS

[Adjusting the Snap Point](#) on page 397

[Replacing Clips in Events](#) on page 155

[Cross-Hair Cursor](#) on page 72

Deleting Clips from the Pool

You can delete clips from the **Pool** with or without deleting the corresponding file from the hard disk.

Removing Clips from the Pool

You can remove clips from the **Pool** without deleting the corresponding files from the hard disk.

PROCEDURE

1. In the **Pool** window, select the clips that you want to remove, and select **Edit > Delete**.
You can also press **Backspace** or **Delete**.
 2. Depending on whether the clips are used by an event, you have the following options:
 - If the clips are used by an event, click **Remove**, and then click **Remove from Pool**.
 - If the clips are not used by an event, click **Remove from Pool**.
-

RESULT

The clips are no longer available in the **Pool** for this project, but the files still exist on the hard disk and can be used for other projects, etc. This operation can be undone.

Deleting Files from the Hard Disk

You can delete clips from the **Pool** by deleting the corresponding files from the hard disk. To delete a file permanently from the hard disk, you must first move the corresponding clips to the **Trash** folder in the **Pool**.

IMPORTANT

Make sure that the audio files that you want to delete are not used in other projects.

PROCEDURE

1. In the **Pool** window, select the clips that you want to delete from the hard disk, and select **Edit > Delete**.

You can also press **Backspace** or **Delete**, or drag the clips into the **Trash** folder.

NOTE

You can retrieve a clip or region from the **Trash** folder by dragging it back into an **Audio** or **Video** folder.

2. Depending on whether the clips are used by an event, you have the following options:
 - If the clips are used by an event, click **Remove**, then click **Trash**.
 - If the clips are not used by an event, click **Trash**.
 3. Select **Media > Empty Trash**.
 4. Click **Erase**.
-

RESULT

The files are deleted from the hard disk.

Removing Unused Clips from the Pool

You can find all clips that are not used in the project in the **Pool**. This allows you to quickly remove all unused clips.

PREREQUISITE

The **Pool** window is open.

PROCEDURE

1. Select **Media > Remove Unused Media**.
 2. Do one of the following:
 - To move the clips to the **Trash** folder, select **Trash**.
 - To remove the clips from the **Pool**, select **Remove from Pool**.
-

Removing Regions from the Pool

PROCEDURE

- In the **Pool**, select a region, and select **Edit > Delete**.
You can also press **Backspace** or **Delete**.

IMPORTANT

If the region is still in use, you are not warned.

Locating Events and Clips

You can quickly display to which clips the selected events belong and to which events the selected clips belong.

Locating Events via Clips in the Pool

You can find out which events in the project refer to a particular clip in the **Pool**.

PROCEDURE

1. In the **Pool** window, select one or more clips.
 2. Select **Media > Select in Project**.
-

RESULT

All events that refer to the selected clips are now selected in the **Project** window.

Locating Clips via Events in the Project Window

You can find out which clip belongs to a particular event in the **Project** window.

PROCEDURE

1. In the **Project** window, select one or more events.
 2. Select **Audio > Find Selected in Pool**.
-

RESULT

The corresponding clips are located and highlighted in the **Pool**.

Searching for Audio Files

The search functions help you locate audio files in the **Pool**, on your hard disk, or on other media. The process is similar to a regular file search, with some additional options.

PROCEDURE

1. In the **Pool** window, click **Search** on the toolbar.
A search pane appears at the bottom of the window, displaying the search functions.

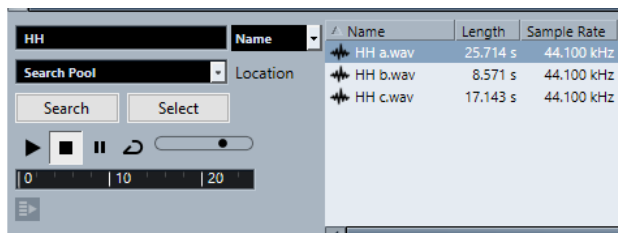

2. Specify the files that you are looking for in the **Name** field.
You can use partial names or wildcards (*).

NOTE

Only audio files of supported formats will be found.

3. Use the **Location** pop-up menu to specify where to search.

The pop-up menu lists all of your local drives and removable media.

- To limit the search to certain folders, select **Select Search Path**, and, in the dialog that opens, select the folder in which you want to search.

The search includes the selected folder and all subfolders.

NOTE

Folders that you have recently selected using the **Select Search Path** function appear on the pop-up menu, so that you can quickly select them again.

4. Click **Search**.

The search is started.

- To cancel the search, click **Stop**.

When the search is finished, the search results are listed on the right.

- To audition a file, select it from the list, and use the playback controls to the left (Play, Stop, Pause, and Loop). If **Auto Play** is activated, selected files are automatically played back.
- To import a file into the **Pool**, double-click the file in the list or select it and click **Import**.

5. To close the search pane, click **Search** on the toolbar again.

RELATED LINKS

[Search Section](#) on page 451

Using the Extended Search Functionality

Apart from the search criterion **Name**, additional search filters are available. The extended search options allow for a detailed search, helping you to master even the largest sound database.

PROCEDURE

1. In the **Pool** window, click **Search** on the toolbar.

The search pane is displayed in the lower part of the **Pool** window.

2. Click **Name** to open the extended search pop-up menu, where you can select and define a search criterion.



The menu also contains the **Add Filter** and **Presets** submenus.

3. Select one of the search criteria from the pop-up menu.
4. Optional: To display more search options, open the extended search pop-up menu, select the **Add Filter** submenu, and select an element.
5. Optional: To save your search filter settings as a preset, open the extended search pop-up menu, select **Presets > Save Preset**, and enter a name for the preset.

Saved presets are added to the **Presets** submenu.

6. Optional: To remove a search filter settings preset, open the extended search pop-up menu, select the preset, and then select **Remove Preset**.
-

RELATED LINKS

[Search Section](#) on page 451

Missing Files

If you open a project and one or more files are missing, the **Resolve Missing Files** dialog opens. If you click **Close**, the project opens without the missing files.

In the **Pool**, you can check which files are considered missing. This is indicated by a question mark in the **Status** column.

A file is considered missing under one of the following conditions:

- The file has been moved or renamed outside the program since you last worked with the project, and you ignored the **Resolve Missing Files** dialog when you opened the project for the current session.
- You have moved or renamed the file outside the program during the current session.
- You have moved or renamed the folder that contains the missing files.

Locating Missing Files

PROCEDURE

1. Select **Media > Find Missing Files**.
 2. In the **Resolve Missing Files** dialog, decide if you want the program to find the file for you (**Search**), if you want to find it yourself (**Locate**), or specify a directory for the program to use when searching for the file (**Folder**).
 - If you select **Search**, a dialog opens to let you specify which folder or disk the program scans. Click **Search Folder**, select a directory or a disk, and click **Start**. If found, select the file from the list and click **Accept**. Afterwards, Cubase tries to map all other missing files automatically.
 - If you select **Locate**, a file dialog opens, allowing you to locate the file manually. Select the file and click **Open**.
 - If you select **Folder**, a dialog opens to let you specify the directory in which the missing file can be found. This might be the preferred method if you have renamed or moved the folder containing the missing file, but the file still has the same name. Once you select the correct folder, the program finds the file and you can close the dialog.
-

Reconstructing Missing Edit Files

If a missing file cannot be found, this is normally indicated by a question mark in the **Status** column of the **Pool**. However, if the missing file is an edit file (a file that is created when you process audio and that is stored in the **Edits** folder within the project folder), it may be possible for the program to reconstruct the edits for the original audio file.

PROCEDURE

1. In the **Pool** window, locate the clips for which files are missing.
2. Check the **Status** column. If the status of the files is "Reconstructible", the files can be reconstructed by Cubase.

3. Select the reconstructible clips, and select **Media > Reconstruct**.
-

RESULT

The editing is performed, and the edit files are recreated.

Removing Missing Files from the Pool

If the **Pool** contains audio files that cannot be found or reconstructed, you may want to remove these.

PROCEDURE

- In the **Pool** window, select **Media > Remove Missing Files**.
-

RESULT

All missing files from the **Pool** and the corresponding events from the **Project** window are removed.

Auditioning Clips in the Pool

You can audition clips in the **Pool** via key commands, the **Audition** button, or by clicking in the waveform image for a clip.

- Use key commands.
If you activate **Playback Toggle Triggers Local Preview** in the **Preferences** dialog (**Transport** page), you can use **Space** to audition. This is the same as activating **Audition** on the toolbar.
- Select a clip and activate **Audition**.
The whole clip plays back. To stop playback, click **Audition** again.
- Click in the waveform image for a clip.
The clip plays back from the selected position in the waveform until the end. To stop playback, click **Audition** or anywhere else in the **Pool** window.

The audio is routed directly to the **Main Mix** (the default output) bus, bypassing the settings of the audio channel, effects, and EQs.

NOTE

You can adjust the auditioning level with the miniature level fader on the toolbar. This does not affect the regular playback level.

If you have activated **Audition Loop** before you audition, the following happens:

- When you click **Audition** to audition a clip, the clip is repeated indefinitely until you stop playback by clicking **Audition** or **Audition Loop** again.
- When you click in the waveform image to audition, the section from the selected point to the end of the clip is repeated indefinitely until you stop playback.

Opening Clips in the Sample Editor

The **Sample Editor** allows you to perform detailed editing on the clip.

- To open a clip in the **Sample Editor**, double-click a clip waveform icon in the **Media** column.

- To open a certain region of a clip in the **Sample Editor**, double-click a region icon in the **Media** column.
You can use this to set a snap point for a clip, for example. When you later insert the clip from the **Pool** into the project, the defined snap point allows it to be properly aligned.

RELATED LINKS

[Adjusting the Snap Point](#) on page 397

[Sample Editor](#) on page 380

Importing Media

The **Import Medium** dialog lets you import files directly into the **Pool**.

To open the dialog, select **Media > Import Medium**, or click **Import** on the **Pool** toolbar.

This opens a standard file dialog, where you can navigate to other folders, audition files, etc. The following audio file formats can be imported:

- Wave (Normal or Broadcast)
- AIFF and AIFC (Compressed AIFF)
- REX or REX 2
- FLAC (Free Lossless Audio Codec)
- MPEG Layer 2 and Layer 3 (MP2 and MP3 files)
- Ogg Vorbis (OGG files)
- Windows Media Audio (Windows only)
- Wave 64 (W64 files)

The following characteristics are possible:

- Stereo or mono
- Any sample rate

NOTE

Files that have a different sample rate than the project sample rate are played back at the wrong speed and pitch.

-
- 8 bit, 16 bit, 24 bit, 32 bit, 32 bit float, or 64 bit float
 - Various video formats

NOTE

You can also use the commands on the **Import** submenu of the **File** menu to import audio or video files into the **Pool**.

RELATED LINKS

[Wave Files](#) on page 765

[Importing ReCycle Files](#) on page 237

[Supported Compressed Audio File Formats](#) on page 233

[Video File Compatibility](#) on page 790

Importing Audio CDs into the Pool

You can import tracks or sections of tracks from an audio CD into the **Pool**. This opens a dialog in which you can specify which tracks are copied from the CD, converted to audio files, and added to the **Pool**.

- To import an audio CD to the **Pool**, select **Media > Import Audio CD**.

RELATED LINKS

[Importing Audio CD Tracks](#) on page 234

Import Options Dialog

The **Import Options** dialog allows you to specify how audio files are imported into the **Pool**.

- If you select a file in the **Import Medium** dialog and click **Open**, the **Import Options** dialog opens.

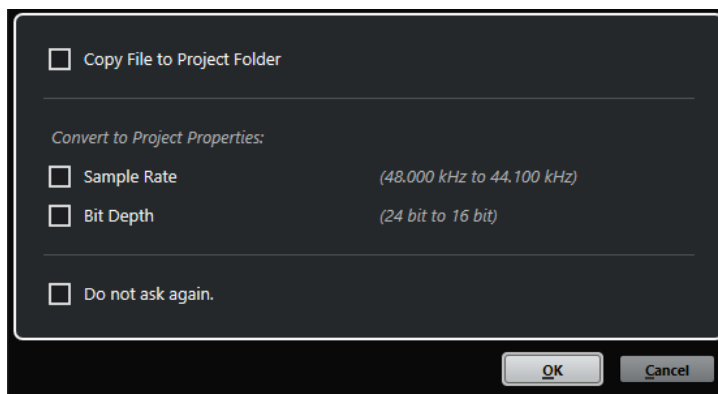

Import Options dialog for single file import

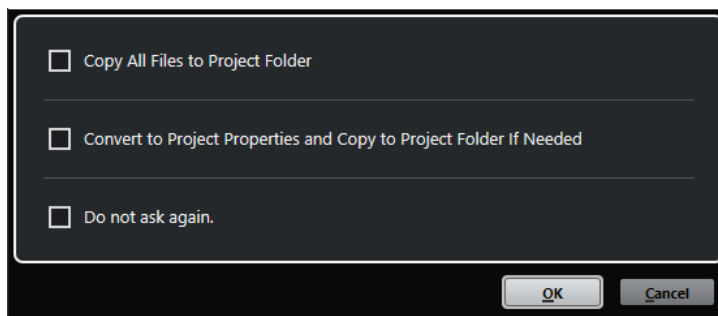

Import Options dialog for multiple file import

Copy File to Project Folder/Copy All Files to Project Folder

Copies the audio file to the **Audio** folder of the project and causes the clip refer to the copy.

Deactivate this option if you want the clip to refer to the original file in the original location. In this case, it is marked as “external” in the **Pool**.

Convert to Project Settings/Convert to Project Settings and Copy to Project Folder If Needed

Converts the imported file if the sample rate or the bit depth differ from the settings in the **Project Setup** dialog. For single file import, you can choose which properties are converted.

Do not ask again

Always applies the current settings without opening the dialog again. You can reset this option in the **Preferences** dialog (**Editing—Audio** page).

RELATED LINKS

[Pool Window Columns](#) on page 448

[Converting Files](#) on page 463

Exporting Regions as Audio Files

If you have created regions within an audio clip, these can be exported as separate audio files. If you have two clips that refer to the same audio file, you can create a separate audio file for each clip.

PROCEDURE

1. In the **Pool** window, select the region that you want to export.
2. Select **Audio > Bounce Selection**.
3. Select the folder in which you want the new file to be created and click **OK**.
4. Optional: If you are using the **Bounce Selection** option to create a separate audio file for a clip that refers to the same audio file as another clip, enter a name for the new audio file.

RESULT

A new audio file is created in the specified folder. The file has the name of the region and is automatically added to the **Pool**.

RELATED LINKS

[Creating Audio Events from Regions](#) on page 395

Changing the Pool Record Folder

All audio clips that you record in the project are saved in the **Pool Record** folder. The **Pool Record** folder is indicated by the text **Record** in the **Status** column and by a dot on the folder itself.

By default, this is the main **Audio** folder. However, you can create a new **Audio** subfolder and designate this as your **Pool Record** folder.

NOTE

The folders that you create in the **Pool** are intended for organizing your files in the **Pool** only. All files are recorded to the folder that you specified as the **Pool Record** folder.

PROCEDURE

1. In the **Pool**, select the **Audio** folder or any audio clip.

NOTE

You cannot designate the **Video** folder or any of its subfolders as the **Pool Record** folder.

2. Select **Media > Create Folder**.
3. Rename the new folder.

4. Select the new folder and select **Media > Set Pool Record Folder**, or click in the **Status** column of the new folder.
-

RESULT

The new folder becomes the **Pool Record** folder. Any audio recorded in the project is saved in this folder.

Organizing Clips and Folders

If you accumulate a large number of clips in the **Pool**, it can be difficult to find specific items. Organizing clips in new subfolders with names that reflect the content can be a solution. For example, you could put all sound effects in one folder, all lead vocals in another, etc.

PROCEDURE

1. In the **Pool** window, select the folder for which you want to create a subfolder.

NOTE

You cannot put audio clips in a video folder and vice versa.

2. Select **Media > Create Folder**.
 3. Rename the folder.
 4. Drag the clips to the new folder.
-

Applying Processing to Clips in the Pool

You can apply audio processing to clips from within the **Pool** in the same way as to events in the **Project** window.

PROCEDURE

1. In the **Pool** window, select the clips that you want to process.
 2. Select **Audio > Direct Offline Processing**, and select a processing method.
-

RESULT

A waveform symbol indicates that the clips have been processed.

RELATED LINKS

[Direct Offline Processing](#) on page 358

Minimizing Files

You can minimize the audio files according to the size of the audio clips referenced in the project. The files that are produced using this option only contain the audio file portions that are actually used in the project.

This can significantly reduce the size of the project, if large portions of the audio files are unused. Therefore, the option is useful for archiving purposes after you have completed a project.

IMPORTANT

This operation permanently changes the selected audio files in the **Pool**. It cannot be undone. If you only want to create the minimized audio files as a copy, leaving the original project untouched, you can use the **Back up Project** option.

NOTE

Minimizing files clears the entire **Edit History**.

PROCEDURE

1. In the **Pool** window, select the files that you want to minimize.
 2. Select **Media > Minimize File**.
 3. Click **Minimize**.
After minimizing, the file references in the stored project become invalid.
 4. Do one of the following:
 - To save the updated project, click **Save Now**.
 - To proceed with the unsaved project, click **Later**.
-

RESULT

Only the audio portions that are actually used in the project remain in the corresponding audio files in the **Pool Record** folder.

RELATED LINKS

[Backing up Projects](#) on page 95

Converting Files

In the **Pool**, you can convert files to another format.

PROCEDURE

1. In the **Pool** window, select the files that you want to convert.
 2. Select **Media > Convert Files**.
 3. In the **Convert Options** dialog, make your changes and click **OK**.
-

Convert Options Dialog

In this dialog, you can convert audio files in the **Pool**.

- To open the **Convert Options** dialog, select a clip in the **Pool** window, and select **Media > Convert Files**.

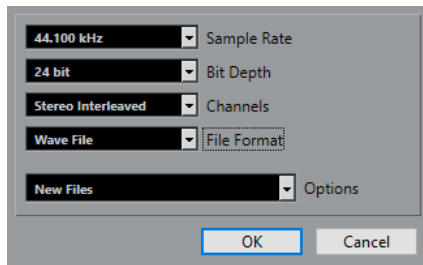

Sample Rate

Allows you to convert to another sample rate.

Bit Depth

Allows you to convert to 16 bit, 24 bit, 32 bit, 32 bit float, or 64 bit float.

Channels

Allows you to convert to mono or stereo interleaved.

File Format

Allows you to convert to Wave, AIFF, Wave 64, or Broadcast Wave Format.

Options

You can use the **Options** pop-up menu to set one of the following options:

- **New Files**
Creates a copy of the file in the audio folder and converts this new file according to the chosen attributes. The new file is added to the **Pool**, but all clip references still point to the original, unconverted file.
- **Replace Files**
Converts the original file without changing clip references. However, the references are saved with the next save action.
- **New + Replace in Pool**
Creates a new copy with the chosen attributes, replaces the original file with the new one in the **Pool**, and redirects the current clip references from the original file to the new file. Select this option if you want your audio clips to refer to the converted file but want to keep the original file on disk. This is useful if the file is used in other projects, for example.

Extracting Audio from Video File

You can extract audio from video files. This automatically generates a new audio clip that appears in the **Pool Record** folder.

NOTE

This function is not available for MPEG-1 video files.

PROCEDURE

1. In the **Pool** window, select **Media > Extract Audio from Video File**.
 2. Select the video file from which you want to extract audio, and click **Open**.
-

RESULT

The audio is extracted from the video file. The audio file gets the same file format and sample rate/width as in the current project, and the same name as the video file.

MediaBay and Media Rack

You can manage media files on your computer as well as presets from multiple sources from within the **MediaBay** or the **Media** rack.

The **MediaBay** window offers advanced functions for working with media files and managing database items. To show the media files on your computer in the **MediaBay**, you must scan the folders or volumes that contain the files so that these are added to the database.

The **Media** rack in the right zone of the **Project** window allows you to access some of the most important **MediaBay** functions from within a fixed zone of the **Project** window. For quick access to specific media files, the **Media** rack allows you to add specific folders on your computer as favorites. Media files within the favorite folders that you add to the **Media** rack are automatically scanned and added to the database.

RELATED LINKS

[MediaBay Window](#) on page 477

[Scanning Folders](#) on page 481

[Media Rack in Right Zone](#) on page 466

[Adding Favorites Using the Favorites Page](#) on page 475

[Adding Favorites Using the File Browser Page](#) on page 476

Media Rack in Right Zone

The **Media** rack in the right zone of the **Project** window allows you to access the **MediaBay** functions from within a fixed zone of the **Project** window.

- To open the **Media** rack in the right zone, click **Show/Hide Right Zone** on the **Project** window toolbar. At the top of the right zone, click the **Media** tab.

The **Media** rack opens on the **Home** page that features different tiles. These tiles correspond to the available media types.

RELATED LINKS

[Showing/Hiding Zones](#) on page 35

[Home Page](#) on page 466

[Project Window Toolbar](#) on page 36

Home Page

The **Home** page gives you access to the tiles that correspond to the available media types, to the **Favorites**, and to the **File Browser**.

- To open the **Home** page, click the **Home** navigation control on the **Media** rack.

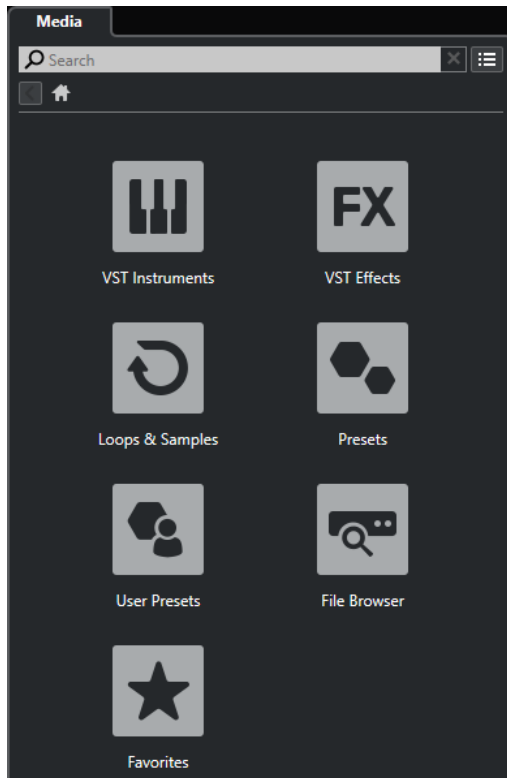

The following tiles are available:

VST Instruments

Shows VST instruments and instrument presets.

VST Effects

Shows VST effects and effect presets.

Loops & Samples

Shows audio loops, MIDI loops, or instrument sounds ordered by content set.

Presets

Shows the track presets, strip presets, FX chain presets, and VST FX presets.

User Presets

Shows track presets, strip presets, pattern banks, FX chain presets, VST FX presets, and instrument presets that are listed in the **User Content** folder.

Shows the track presets, strip presets, FX chain presets, and VST FX presets.

Favorites

Shows your favorite folders and allows you to add new favorites. The folder content is automatically added to the **MediaBay** database.

File Browser

Shows your file system and the pre-defined folders **Favorites**, **This Computer**, **VST Sound**, **Factory Content**, and **User Content**, where you can search for media files and access them immediately.

RELATED LINKS

[Loading Instrument Presets](#) on page 494

[Loading Loops and Samples](#) on page 493

[Loading Track Presets](#) on page 494

[Loading Effect Plug-In Presets](#) on page 495

[Loading FX Chain Presets](#) on page 495

[Loading Strip Presets](#) on page 495

[Adding Favorites Using the Favorites Page](#) on page 475

[Adding Favorites Using the File Browser Page](#) on page 476

Favorites Page

The **Favorites** page allows you to add your own favorite folders to the **Media** rack.

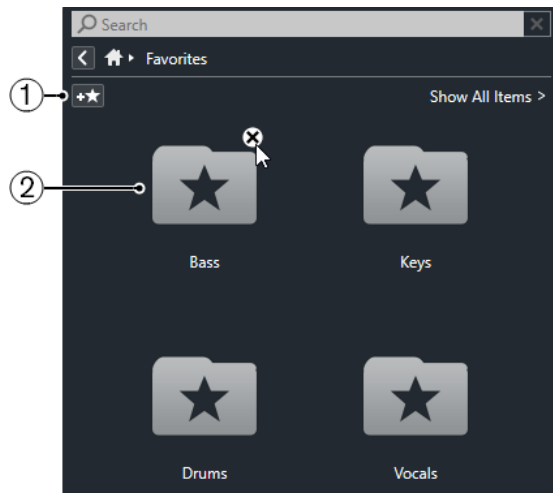

1 Add Favorite

Opens a file dialog where you can navigate to the location of a folder and add it as a favorite folder.

2 Favorite folders

The folders that you added as favorites are displayed as tiles on the **Favorites** page.

- To show the content of a folder, click it.
- To delete a folder from the **Favorites** page, click its close button.

RELATED LINKS

[Adding Favorites Using the Favorites Page](#) on page 475

Results Page

The **Results** page shows all media files that are found in the defined favorite folder.

- To open the **Results** page, click the **Show All Results** navigation control on the **Media** rack.

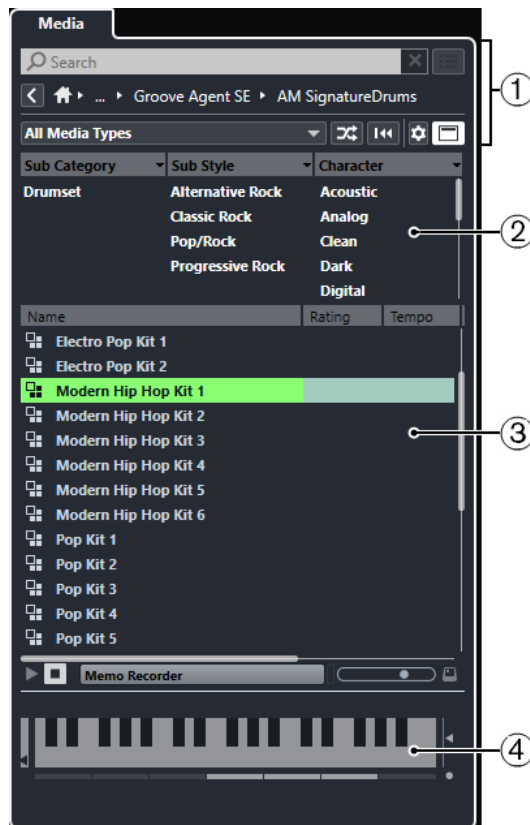

The following options are available:

1 Media Rack navigation controls

Allow you to navigate to specific folders and to filter the **Results** list.

2 Attribute filter

Allows you to view and edit some of the standard file attributes found in your media files.

3 Results list

Shows all media files that are found in the selected folder and allows you to select a media file.

4 Previewer

Allows you to preview the selected media file.

RELATED LINKS

[Media Rack Navigation Controls](#) on page 473

[Setting up the Results List Columns](#) on page 483

[Results Section](#) on page 482

[Previewer Section](#) on page 487

File Browser Page

The **File Browser** page shows all media files that are found in the **File Browser**.

- To open the **File Browser** page, go to the **Home** page of the **Media** rack, and click **File Browser**.

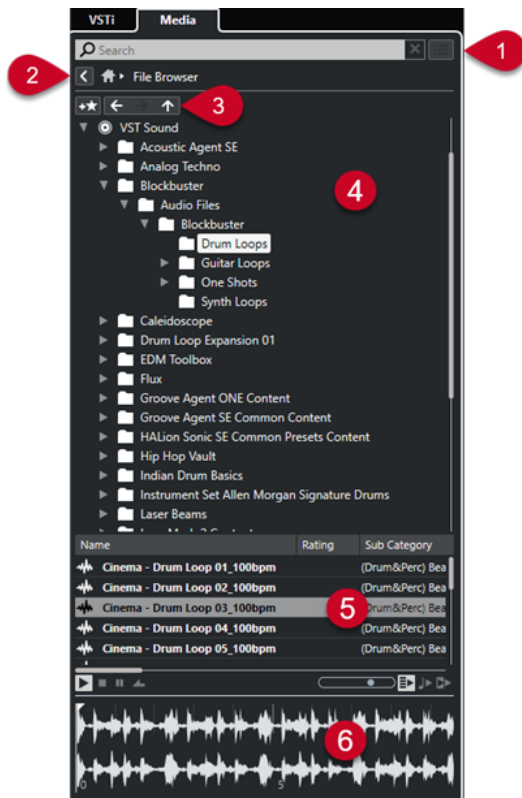

The following options are available:

1 Media Rack navigation controls

Allow you to navigate to specific folders and to filter the **Results** list.

2 Add Favorite

Allows you to add the selected folder as a favorite folder.

3 Back/Forward/Up

Up navigates to the parent folder. **Back** navigates to the previously used folder. **Forward** navigates to the most recent folder.

4 File browser

Allows you to browse selected folders.

5 Results list

Shows all supported media files that are found in the selected folder and allows you to select a media file.

6 Previewer

Allows you to preview the selected media file.

RELATED LINKS

[Media Rack Navigation Controls](#) on page 473

[File Browser Section](#) on page 480

[Results Section](#) on page 482

[Previewer Section](#) on page 487

VST Instruments Page

The **VST Instruments** page shows all VST instruments of the selected collection.

- To open the **VST Instruments** page, go to the **Home** page of the **Media** rack, and click **VST Instruments**.

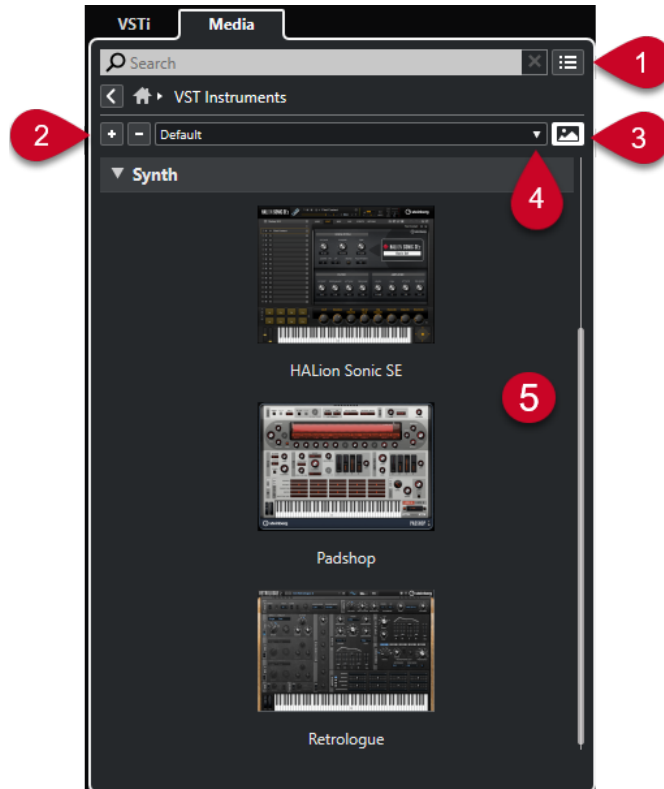

The following options are available:

1 Media Rack navigation controls

Allow you to navigate to specific folders and to filter the **Results** list.

2 Expand All/Collapse All

Expands/Collapses all results.

3 Show/Hide VST Plug-in Pictures

Shows/Hides the pictures of the VST instrument control panels.

4 Plug-in Collections and Options

- **Default** activates the default collection.
- **Sort By Category** sorts the collection by category. This is available for the **Default** collection only.
- **Sort By Vendor** sorts the collection by vendor. This is available for the **Default** collection only.
- **Plug-in Manager** opens the **Plug-in Manager** that allows you to create new plug-in collections. These will be listed in the **Plug-in Collections and Options** menu below the **Default** collection.

5 Plug-in list

Shows the plug-ins of the selected collection.

RELATED LINKS

[VST Plug-in Manager Window](#) on page 529

[Adding Pictures of VST Instruments to the Media Rack](#) on page 476

VST Effects Page

The **VST Effects** page shows the VST effects of the selected collection.

- To open the **VST Effects** page, go to the **Home** page of the **Media** rack, and click **VST Effects**.

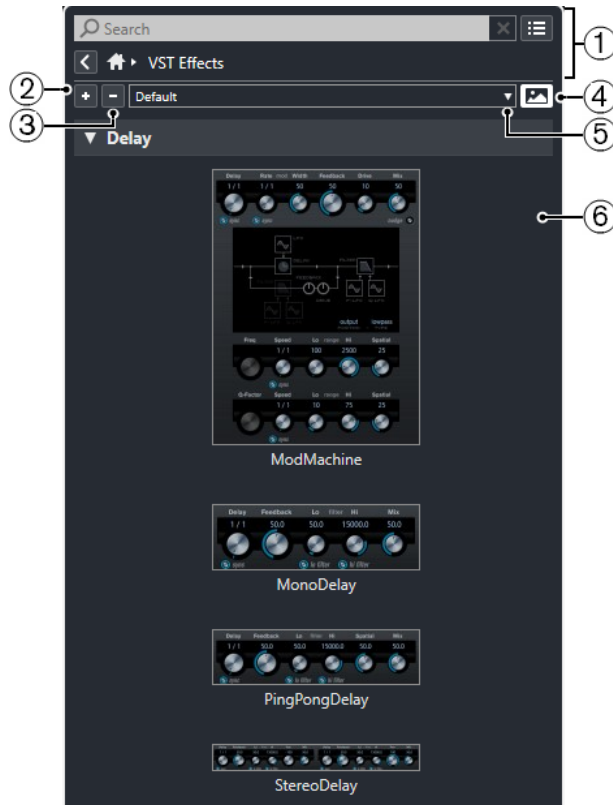

The following options are available:

1 Media Rack navigation controls

Allow you to navigate to specific folders and to filter the **Results** list.

2 Expand All

Expands all results.

3 Collapse All

Collapses all results.

4 Show/Hide VST Plug-in Pictures

Shows/Hides the pictures of the VST effect control panels.

5 Plug-in Collections and Options

- Default** activates the default collection.
- Sort By Category** sorts the collection by category. This is available for the **Default** collection only.
- Sort By Vendor** sorts the collection by vendor. This is available for the **Default** collection only.

- **Plug-in Manager** opens the **Plug-in Manager** that allows you to create new plug-in collections. These will be listed in the **Plug-in Collections and Options** menu below the **Default** collection.

6 Plug-in list

Shows the plug-ins of the selected collection.

RELATED LINKS

[VST Plug-in Manager Window](#) on page 529

[Adding Pictures of VST Effects to the Media Rack](#) on page 477

Media Rack Navigation Controls

The navigation controls allow you to navigate to files and folders in the **Media** rack.

The following controls allow you to perform a text search, and to show the results on the current page.



1 Search

Allows you to search media files by name or by attribute.

2 Reset Search

Allows you to reset the search.

3 Show All Results

Shows the **Results** page for a selected tile. If no tile is selected, all media files are shown.

The following controls allow you to navigate from the current page to other pages.

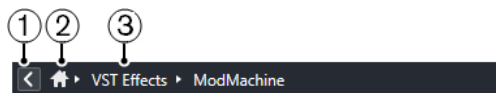

1 Back

Allows you to navigate back to the previous page.

2 Home

Allows you to navigate back to the **Home** page.

3 Breadcrumb path

Shows the path to the current page and allows you to navigate back to the previous page.

The following controls allow you to set up and modify the **Results** page.



1 Select Media Types

Allows you to select the media types that are displayed on the **Results** page.

2 Shuffle Results

Shuffles the **Results** page.

3 Reset Attribute Filter

Lights up if an attribute filter is set. Click this button to reset the attribute filter.

4 Set up Result Columns

Allows you to specify which attribute columns are displayed on the **Results** page.

5 Show/Hide Attribute Filters

Shows/Hides the **Attribute Filters** section.

RELATED LINKS

[Home Page](#) on page 466

[Results Page](#) on page 468

[Media File Attributes](#) on page 491

Working with the Media Rack

The **Media** rack in the right zone of the **Project** window allows you to search for supported media files and included VST instruments, and to add them to your project.

The controls on the different pages of the **Media** rack allow you to browse, filter, select, and preview your media files.

The **Favorites** page and the **File Browser** page allow you to add folders where your media files are located as **Favorites**. This helps you to quickly navigate to these media files.

The tiles and controls on the different pages of the **Media** rack allow you to browse, filter, select, and preview the content.

Once you have located the media file, the instrument, or the preset that you want to use and selected it in the **Results** list, you can insert it into your project by using drag and drop, by using the context menu options, or by double-clicking.

RELATED LINKS

[Media Rack in Right Zone](#) on page 466

[Results Page](#) on page 468

Adding VST Instruments to Projects

You can use the **Media** rack to add VST instruments to your project.

PROCEDURE

1. In the **Media** rack, click the **VST Instruments** tile.
2. Drag an instrument on the track list or on the event display.

NOTE

To exchange the VST instrument of an instrument track, drag the instrument from the **Media** rack, and drop it on the top section of the instrument track **Inspector**. Note that you must manually update the track name if needed.

RELATED LINKS

[Loading Instrument Presets](#) on page 494

Adding VST Effects to Projects

You can use the **Media** rack to add VST effects to your project.

PROCEDURE

1. In the **Media** rack, click the **VST Effects** tile.

2. Do one of the following:
 - To create an FX channel track, drag an effect on the track list.
 - To add the effect to an audio-related track, drag the effect from the **Media** rack, and drop it in the **Inserts** or **Sends** section of the track **Inspector**.
 - To add the effect to an audio-related channel, drag the effect from the **Media** rack, and drop it in the **Inserts** or **Sends** section of the **MixConsole** in the lower zone of the **Project** window or the **Channel Settings** window.
-

RELATED LINKS

[Loading Effect Plug-In Presets](#) on page 495

Applying Track Presets

You can use the **Media** rack to add track presets to your project.

PROCEDURE

1. In the **Media** rack, click the **Presets** tile.
2. Click **Track Presets**.
3. Click **Audio**, **VST Instruments**, **MIDI**, **Multi**, or **Sampler**, depending on the track type.
4. Do one of the following:
 - Drag a track preset on the **Inspector** or into the track list for the corresponding track type.
 - Drag a track preset below the track list to add a new track with the track preset loaded.

NOTE

To exchange the track preset of a track, drag the preset from the **Media** rack, and drop it on the track in the track list. Note that you must manually update the track name if needed.

RESULT

The track preset is applied.

Adding Favorites Using the Favorites Page

You can add favorite folders to the **Favorites** page. This allows you to directly access media files in specific folders.

PROCEDURE

1. In the **Media** rack, click the **Favorites** tile.
 2. At the top left of the page, click **Add Favorite**.
 3. Select the folder that you want to add as a **Favorite**.
 4. Click **OK**.
-

RESULT

- The favorite folder is added to the database.
- On the **Favorites** page, a new tile with the specified name is added.
- In the **File Browser**, a new folder with the specified name is added to the **Favorites** folder.

RELATED LINKS

[Favorites Page](#) on page 468

Adding Favorites Using the File Browser Page

You can add favorite folders using the **File Browser** page. This allows you to directly access media files in specific folders.

PROCEDURE

1. In the **Media** rack, click the **File Browser** tile.
2. In the **File Browser**, navigate to the folder that you want to add as a favorite, and select it.
3. Do one of the following:
 - At the top left of the page, click **Add Favorite**.
 - Right-click the folder, and, from the context menu, select **Add Favorite**.
4. In the **Set Name** dialog that opens, enter a name for the folder.
5. Click **OK**.

RESULT

- The favorite folder is added to the database.
- In the **File Browser**, a new folder with the specified name is added to the **Favorites** folder.
- On the **Favorites** page, a new tile with the specified name is added.

RELATED LINKS

[File Browser Page](#) on page 469

Adding Pictures of VST Instruments to the Media Rack

Pictures of VST instruments from other vendors are not loaded by default. However, you can manually add them to the **Media** rack.

PREREQUISITE

You have added a VST instrument of another vendor as a rack or a track instrument.

PROCEDURE

1. Open the control panel of the VST instrument.
2. On the control panel, click **Add VST Plug-in Picture to Media Rack**.

RESULT

The picture of the VST instrument is shown in the **Media** rack.

RELATED LINKS

[Adding VST Instruments](#) on page 510

[VST Instrument Control Panel](#) on page 511

Adding Pictures of VST Effects to the Media Rack

Pictures of VST effects from other vendors are not loaded by default. However, you can manually add them to the **Media** rack.

PREREQUISITE

You have added a VST effect from another vendor.

PROCEDURE

1. Open the control panel of the VST effect.
2. On the control panel, click **Add VST Plug-in Picture to Media Rack**.

RESULT

The picture of the VST effect is shown in the **Media** rack.

RELATED LINKS

[Adding Insert Effects](#) on page 332

[Effect Control Panel](#) on page 347

MediaBay Window

To open the **MediaBay** in a separate window, do one of the following:

- Select **Media > MediaBay**.
- Press **F5**.



The **MediaBay** is divided into the following sections:

1 File Browser

Allows you to scan specific folders in your file system, and to add favorites.

2 Toolbar

Contains tools and shortcuts for settings and functions in the **MediaBay**, and allows you to switch between the previously defined favorite locations. Favorites in the **MediaBay** window are not automatically scanned.

3 Filters

Allows you to filter the **Results** list by applying a logical or an attribute filter.

4 Results

Displays all supported media files. You can filter the list and perform text searches.

5 Previewer

Allows you to preview the files shown in the **Results** list.

RELATED LINKS

[File Browser Section](#) on page 480

[MediaBay Toolbar](#) on page 478

[Adding Favorites](#) on page 481

[Scanning Folders](#) on page 481

[Filters Section](#) on page 491

[Results Section](#) on page 482

[Previewer Section](#) on page 487

[Setting up the MediaBay](#) on page 480

MediaBay Toolbar

The toolbar contains tools and shortcuts for settings and functions in the **MediaBay**.

Navigation

Back



Navigates to the previously used folder.

Forward



Navigates to the most recent folder.

Up



Navigates to the parent folder.

Favorites

Add Favorite



Allows you to add the selected folder as a favorite folder.

Select Defined Favorite

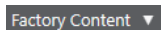

Allows you to select a **Favorite** to quickly browse to the files you are looking for.

Include Folders and Subfolders



Activate this to show the content of folders and subfolders.

Left Divider

Left Divider

Tools that are placed to the left of the divider are always shown.

Text Search

Search

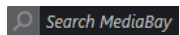

Allows you to search media files by name or by attribute.

Media Types Filter

Select Media Types

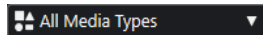

Allows you to select the media types that are displayed on the **Results** page.

Rating Filter

Rating Filter

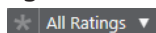

Filters files according to their rating.

Reset Result Filters

Reset Filters



Allows you to reset the filters.

Results

Update Results



Updates the results.

Shuffle Results



Shuffles the **Results** page.

Attribute Counter

Attribute Counter



Shows the number of attributes that are being updated.

Right Divider

Right Divider

Tools that are placed to the right of the divider are always shown.

MediaBay Settings

MediaBay Settings



Opens the **MediaBay** settings.

Window Zone Controls

Show/Hide Left Zone



Shows/Hides the left zone of the window.

Show/Hide Lower Zone



Shows/Hides the lower zone of the window.

Show/Hide Right Zone



Shows/Hides the right zone of the window.

Set up Window Layout



Allows you to set up the window layout.

Set up Toolbar



Opens a pop-up menu where you can set up which toolbar elements are visible.

Setting up the MediaBay

You can show and hide the different sections of the **MediaBay**. This saves screen space and allows you to display only the information that you need.

PROCEDURE

1. Click **Set up Window Layout**.
 2. Activate/Deactivate the checkboxes for the sections that you want to show/hide.
 3. Click outside the pane to exit the setup mode.
-

File Browser Section

The **File Browser** section shows your file system with the pre-defined folders **Favorites**, **This Computer**, **VST Sound**, **Factory Content**, and **User Content**.

- To open the **File Browser** section in the **MediaBay**, click **Set up Window Layout**, and activate **File Browser**.

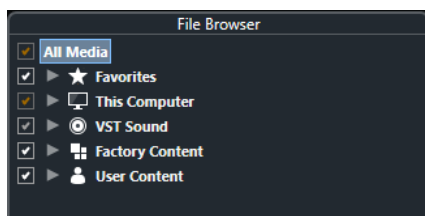

To show the supported media files in the **Results** section of the **MediaBay**, you must scan all folders that you want to include in the search.

You can also add favorite folders. All media files contained in a **Favorite** are automatically scanned.

RELATED LINKS

[Scanning Folders](#) on page 481

[Adding Favorites](#) on page 481

Scanning Folders

To include specific folders in the **MediaBay** search, you must scan them.

PROCEDURE

1. In the **File Browser** section of the **MediaBay**, navigate to the folder that you want to include in the scan.
2. Activate the checkbox for the folder to activate the scan.

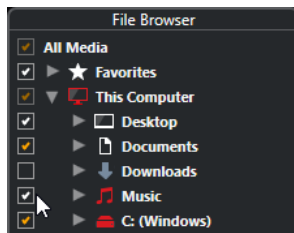

RESULT

All files that are found in the scanned folder are shown in the **Results** list. The scan result is saved in a database file.

The color of the checkmark helps you to identify which folders and subfolders are scanned:

- White indicates that all subfolders are included in the scan.
- Orange indicates that at least one subfolder is excluded from the scan.

The color of the folder indicates the state of the scan:

- Red indicates that a folder is currently being scanned.
- White indicates that all subfolders have been scanned.
- Yellow indicates that at least one subfolder has not been scanned.

NOTE

Please wait until the **MediaBay** completes the scan before you resume your work.

Adding Favorites

You can add favorite folders using the **File Browser** section.

PROCEDURE

1. In the **File Browser** section, navigate to the folder that you want to add as a favorite, and select it.
 2. Right-click the folder or the volume, and, from the context menu, select **Add Favorite**.
 3. In the **Set Name** dialog that opens, enter a name for the folder.
 4. Click **OK**.
-

RESULT

- In the **File Browser** section, a new folder with the specified name is added to the **Favorites** folder.
- In the **Favorites** section, the added favorite is available in the **Select Defined Favorite** pop-up menu.
- In the **Media** rack in the right zone of the **Project** window, a new tile with the specified name is added to the **Favorites** page.

NOTE

Favorites in the **MediaBay** window are not automatically scanned.

AFTER COMPLETING THIS TASK

To remove a **Favorite**, select it in the **Favorites** tree of the **File Browser** section, open the context menu, and select **Remove Favorite**.

RELATED LINKS

[Scanning Folders](#) on page 481

Refresh Views

If you change previously scanned folders by adding or removing files with Cubase closed, you must rescan the corresponding media folders. This also applies if you modified attributes of your user content while using another program.

If you have applied changes to your content and want the changes to be displayed in the **MediaBay**, you must refresh the views of the corresponding media folders.

- To refresh a folder, in the **File Browser** section of the **MediaBay**, right-click the folder, and select **Refresh Views**.
- To display a new drive, in the **File Browser** section of the **MediaBay**, right-click the parent node, and select **Refresh Views**. You can then scan the drive for media files.
- To update the scan state of the folders after modifying the volume database with another program, right-click the volume database, and select **Refresh Views**.

Results Section

The **Results** list shows all the media files that are found in the selected folder of the **File Browser**.

- To show media files in the **Results** section, you must select a scanned folder in the **File Browser** section of the **MediaBay**.

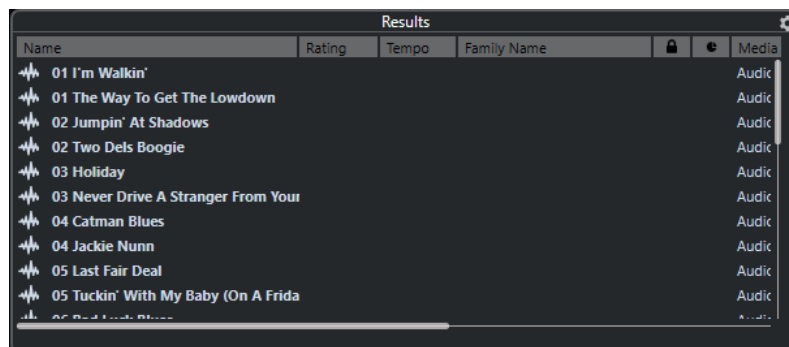

NOTE

You can set the maximum number of files to be displayed in the **Results** list in the **MediaBay Settings**.

Setting up the Results List Columns

For each media type, or for combinations of media types, you can specify the attribute columns to be displayed in the **Results** list.

PROCEDURE

1. In the **Results** section, select the media types for which you want to make settings.
2. Click **Set up Result Columns**, and do one of the following:
 - To show specific columns, activate or deactivate the respective options on the submenu.
 - To remove all columns except **Name**, select **Select None**.
 - To show the default columns, select **Use Defaults**.
 - To show all columns with set attributes, select **All Available**.

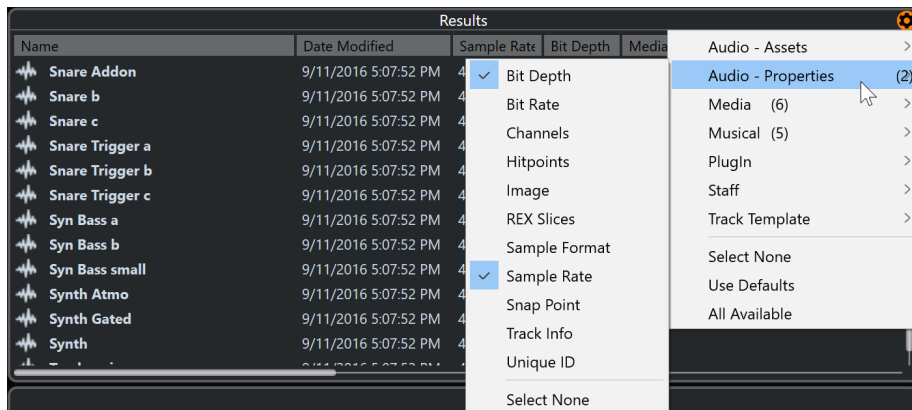

NOTE

RELATED LINKS

[Setting up the MediaBay](#) on page 480

Managing Media Files in the Results List

- To move or to copy a file from the **Results** list to another location, drag it to another folder in the **File Browser** section.
- To change the order of the columns in the **Results** list, click a column header, and drag that header to another position.
- To delete a file, right-click it in the list and select **Delete**. The file is permanently deleted from your computer.

IMPORTANT

If you delete a file using the File Explorer/macOS Finder, it is still displayed in the **Results** list, although it is no longer available to the program. To remedy this, rescan the corresponding folder.

Shuffling the Results List

You can display the **Results** list entries in a random order.

- To shuffle the **Results** list, click **Shuffle Results** in the **MediaBay** toolbar.

Finding the Location of a File

You can display the location of a file on your system in the File Explorer/macOS Finder.

NOTE

This function is not available for files which are part of a VST Sound archive.

PROCEDURE

- In the **Results** list, right-click a file, and select **Show in Explorer/Reveal in Finder**.
-

RESULT

The File Explorer/macOS Finder opens, and the corresponding file is highlighted.

Filtering According to Media Type

You can set up the **Results** list to display only a particular media type or a combination of media types.

PROCEDURE

1. In the **MediaBay** toolbar, open the **Show Media Types** selector.

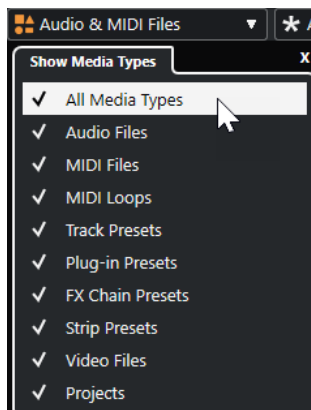

2. Activate the media types that you want to be displayed in the **Results** list.
-

RESULT

The files are filtered by the selected media type.

Show Media Types Selector

You can activate the media types that you want to be displayed in the **Results** list.

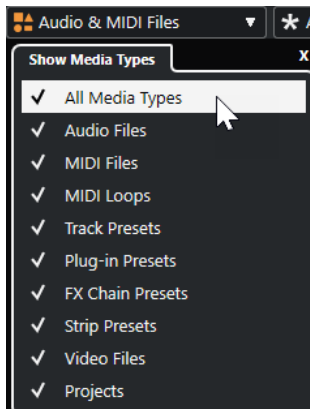

The following media types are available:

Audio Files

Shows all audio files. The supported formats are .wav, .w64, .aiff, .aifc, .rex, .rx2, .mp3, .mp2, .ogg, .wma (Windows only).

MIDI Files

Shows all MIDI files (file name extension .mid).

MIDI Loops

Shows all MIDI loops (file name extension .midiloop).

Track Presets

Shows all track presets for audio, MIDI, and instrument tracks (file name extension .trackpreset). Track presets are a combination of track settings, effects, and **MixConsole** settings that can be applied to new tracks of various types.

Plug-in Presets

Shows all VST presets for instrument and effect plug-ins. Furthermore, EQ presets that you save in the **MixConsole** are listed. These presets contain all parameter settings for a particular plug-in. They can be used to apply sounds to instrument tracks and effects to audio tracks.

Strip Presets

Shows all strip presets (file name extension .strippreset). These presets contain channel strip effect chains.

FX Chain Presets

Shows all effect chain presets (file name extension .fxchainpreset). These presets contain insert effect chains.

Video Files

Shows all video files.

Projects

Shows all project files (.cpr).

RELATED LINKS

[Track Presets](#) on page 148

[Saving/Loading Strip Presets](#) on page 312

[Saving/Loading EQ Presets](#) on page 305

[Saving/Loading FX Chain Presets](#) on page 302
[Video File Compatibility](#) on page 790

Filtering According to Rating

With the **Rating Filter**, you can filter files according to their rating.

NOTE

The **Rating Filter** is not available in the **Media** rack in the right zone.

PROCEDURE

- In the **Rating Filter** section of the **MediaBay** toolbar, select a value from the **Rating Filter** pop-up menu.
-

Performing a Text Search

You can perform a text search of the **Results** list. If you enter text in the text search field on the **MediaBay** toolbar, only media files whose attributes match the entered text are displayed.

- Click the field, and enter the text that you want to find.
For example, if you are looking for all audio loops relating to drum sounds, enter “drum” in the search field. The search results will contain loops called “Drums 01”, “Drumloop”, “Snare Drum”, etc. In addition, all media files with the **Drum&Percussion** category attribute or any other attribute that contains “drum” are found. You can also add apostrophes to find exact matches for the entered words, and you can use boolean operators.

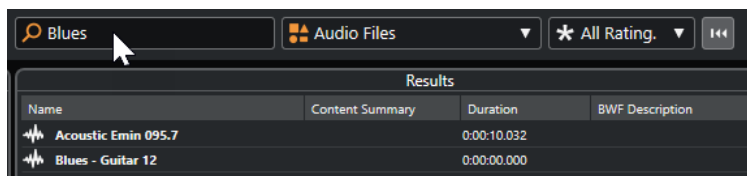

- To reset the text search, delete the text, or click **Reset Filters**.

Boolean Text Search

You can perform advanced searches, using boolean operators or wildcards.

You can use the following elements:

And [+]

[a and b]

When entering strings separated by “and” (or a plus sign), all files that contain both a and b are found.

[And] is the default setting when no boolean operator is used, for example, you can also enter [a b].

Or [,]

[a or b]

When entering strings separated by “or” (or a comma), files that contain either a or b, or both are found.

Not [-]

[not b]

When entering text preceded by “not” (or a minus sign), all files not containing b are found.

Parentheses [()]

[(a or b) + c]

Using parentheses, you can group text strings. In this example, files that contain c and either a or b are found.

Quotation marks [“”]

["your search text"]

With quotation marks, you can define sequences of several words. Files are found if they contain the sequence of words that you entered.

IMPORTANT

When you are searching for files whose names contain a hyphen, put the search text in quotation marks. Otherwise, the program treats the hyphen as the boolean operator “not”.

NOTE

These operators can also be used for logical filtering.

Resetting the Results List

You can reset all filter settings and filter results.

- In the **MediaBay** toolbar, click **Reset Filter**.

Previewer Section

You can preview individual files in the **Previewer** section to find out which one to use in your project.

The elements visible in this section and their functions depend on the media type.

IMPORTANT

The **Previewer** section is not available for video files, project files, and audio track presets.

RELATED LINKS

[MediaBay Settings](#) on page 498

Audio Files Previewer

The **Previewer** for audio files allows you to listen to audio files before you use them in your project.

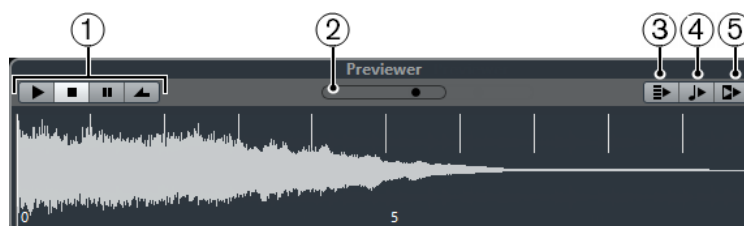

1 Transport controls

Start, stop, pause, and cycle the preview.

2 Preview Level fader

Specifies the preview level.

3 Auto Play New Results Selection

Automatically plays back the selected file.

4 Align Beats to Project

Plays back the selected file in sync with the project, starting at the project cursor position. Note that this can apply real-time time stretching to your audio file.

NOTE

If you import an audio file into your project for which **Align Beats to Project** is activated in the **Previewer**, **Musical Mode** is automatically activated for the corresponding event.

5 Wait for Project Play

Synchronizes the play and stop functions from the **Transport** panel with the play and stop buttons in the **Previewer** section.

To use this option to its full extent, set the left locator to the beginning of a bar, then start playing back the project using the **Transport** panel. The start of the loops that you now select from the **Results** list start together with the project in perfect sync.

RELATED LINKS

[Musical Mode](#) on page 410

MIDI Files Previewer

The **Previewer** for MIDI files allows you to listen to MIDI files before you use them in your project.

- To preview a MIDI file, load a VST instrument, and select it as an output device from the **Select MIDI Output** pop-up menu.



1 Transport controls

Starts and stops the preview.

2 Preview Level fader

Specifies the preview level.

3 Output

Allows you to select the output device.

4 Align Beats to Project

Plays back the selected file in sync with the project, starting at the project cursor position. Note that this can apply real-time time stretching to your MIDI file.

5 Auto Play New Results Selection

Automatically plays back the selected file.

RELATED LINKS

[VST Instruments](#) on page 510

MIDI Loops Previewer

The **Previewer** for MIDI loops allows you to listen to MIDI loops before applying them to your project.

NOTE

MIDI loops are always played back in sync with the project.

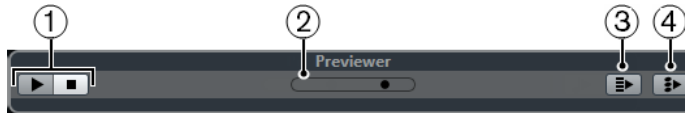

1 Transport controls

Starts and stops the preview.

2 Preview Level fader

Specifies the preview level.

3 Auto Play New Results Selection

Automatically plays back the selected file.

4 Link Playback to Chord Track

Transposes the events of the MIDI loop to play back in context with the chord track. Note that you need a chord track with chord events for this.

If this option is activated and you insert a MIDI loop into the project, **Follow Chord Track** is automatically activated for the track.

RELATED LINKS

[Using Follow Chord Track](#) on page 719

VST Presets and Track Presets Previewer for MIDI and Instrument Tracks

The **Previewer** for VST presets and track presets allows you to listen to presets before you use them in your project.

- To preview track presets for MIDI or instrument tracks and VST presets, you must send some MIDI notes to the track preset via MIDI input, using a MIDI file, the **Memo Recorder** mode, or via the computer keyboard.

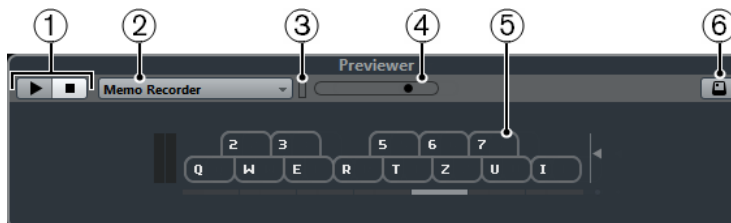

1 Transport controls

Starts and stops the preview.

2 Previewer Sequence Mode

Allows you to load a MIDI file to apply the selected preset to the MIDI file. You can also select the **Memo Recorder** mode that continually repeats a given sequence of notes as a loop.

3 MIDI Activity

Allows you to monitor incoming MIDI messages.

4 Preview Level fader

Specifies the preview level.

5 Keyboard

You can display the **Keyboard** in keyboard display mode or in piano display mode.

6 Computer Keyboard Input

Allows you to use your computer keyboard to preview the presets.

RELATED LINKS

[Previewing Presets Using the Memo Recorder Mode](#) on page 490

[On-Screen Keyboard](#) on page 209

Previewing Presets Via MIDI Input

MIDI input is always active. For example, when a MIDI keyboard is connected to your computer and set up properly, you can start playing the notes to preview the selected preset.

Previewing Presets Using a MIDI File

PROCEDURE

1. From the **Previewer Sequence Mode** pop-up menu, select **Load MIDI File**.
2. In the file dialog that opens, select a MIDI file and click **Open**.
The name of the MIDI file is displayed on the pop-up menu.
3. Click **Play** to the left of the pop-up menu.

RESULT

The notes received from the MIDI file are played back, with the settings of the track preset applied.

NOTE

The recently used MIDI files are still displayed on the menu for quick access. To remove an entry from this list, select it from the menu and select **Remove MIDI File**.

Previewing Presets Using the Memo Recorder Mode

The **Memo Recorder** mode continually repeats a given sequence of notes as a loop.

NOTE

You cannot use the **Memo Recorder** mode when using a MIDI file to preview presets.

PROCEDURE

1. From the **Previewer Sequence Mode** pop-up menu, select **Memo Recorder**.
 2. Activate **Play**.
 3. Play some notes on the MIDI keyboard or on the computer keyboard.
-

RESULT

The notes are played back with the instrument preset you selected in the **Results** section.

When you pause for 2 seconds, the note sequence that you played until this moment is played back in a continuous loop.

To use another sequence, start entering notes again.

Previewing Presets Via the Computer Keyboard

NOTE

If you activate **Computer Keyboard Input**, the computer keyboard is used exclusively for the **Previewer** section. However, you can still use the following key commands: **Ctrl/Cmd-S** (Save), **Num *** (Start/Stop Record), **Space** (Start/Stop Playback), **Num 1** (Jump to left locator), **Delete** or **Backspace**, **Num /** (Cycle on/off), and **F2** (Show/Hide Transport panel).

PROCEDURE

1. Activate **Computer-Keyboard Input**.
2. Play some notes on the computer keyboard.

Filters Section

The **MediaBay** allows you to refine your file searches.

Media File Attributes

Media file attributes are sets of metadata that provide additional information on the file.

The different types of media files have different attributes. For example, .wav audio files have attributes such as name, length, size, sample rate, content set, etc., while .mp3 files have additional attributes, such as artist or genre.

Attribute Filter

Assigning attribute values facilitates organizing your media files. The **Attribute** filter allows you to view and edit some of the standard file attributes in your media files.

The **Filters** section displays all the values that have been specified for the displayed attribute categories. Selecting one of these values filters the results to display only the files to which this attribute value is assigned.

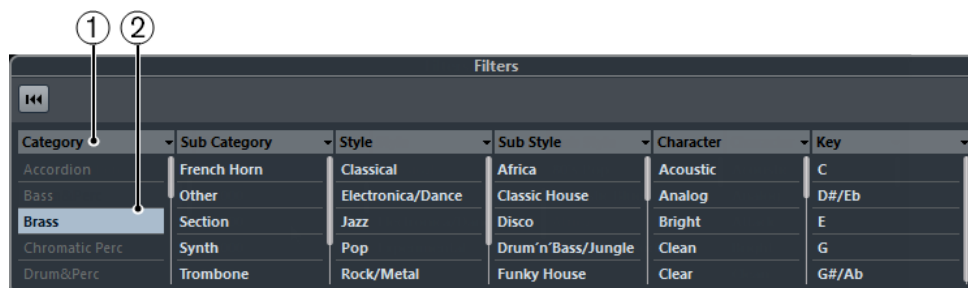

1 Attribute column titles

Allow you to select different attribute categories. If the columns are wide enough, the number of files that match these criteria is displayed to the right of the value.

2 Attribute values

Displays the attribute values and indicates how often a certain attribute value has been assigned to your media files.

NOTE

- Some attributes are linked to each other. For example, there are certain sub-category values available for each category value. Changing the value in one of these attribute columns results in different values in the other column.
- Each attribute column displays only the attribute values that are found.

Applying an Attribute Filter

With the **Attribute** filter, you can quickly find tagged media files with certain attributes.

- To apply an **Attribute** filter, select an attribute value. The **Results** list is filtered accordingly. Apply further attribute filters to narrow down the result.
- To find files that match either one or the other attribute, **Ctrl/Cmd**-click different attribute values in the same column.
- To change the displayed attribute values of a column, click the attribute column title, and select another attribute.

NOTE

Character attributes always form an AND condition.

Performing a Context Menu Search

You can search for files that have the same attribute as the selected file. This allows you to find all the files that have a value in common, for example, if you want to view all the files that were created on the same day.

- In the **Results** list or the **Attribute Inspector**, right-click a file, and select the attribute value from the **Search for** submenu.

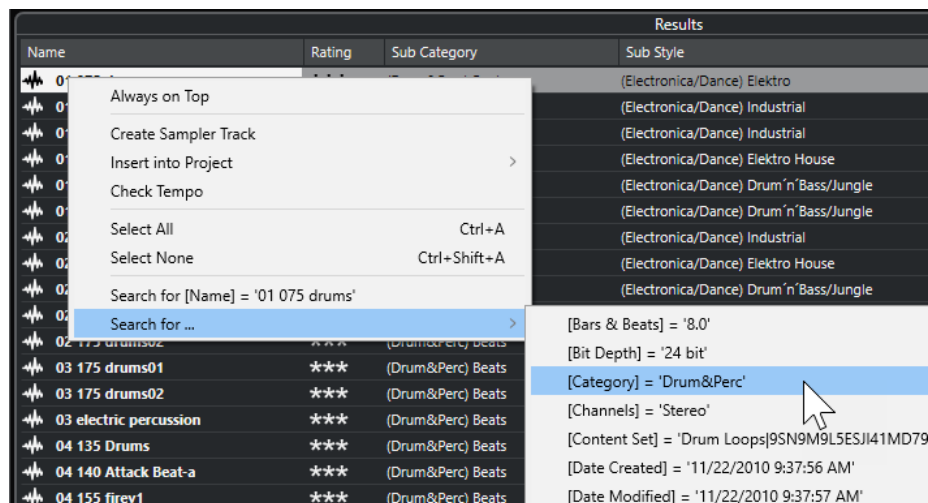

- To reset the filter, click **Go Back**.

Resetting the Filter

PROCEDURE

- To reset the filter, click **Reset Filter** at the top of the **Filters** section.

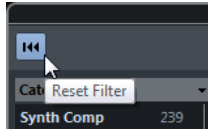

This also resets the **Results** list.

Working with the MediaBay

When you work with many music files, the **MediaBay** helps you to find and organize your content. After scanning your folders, all media files of the supported formats are listed in the **Results** section.

You can set up **Favorites**, that is, folders or directories that contain media files. Usually, files are organized on your computer in a specific way. You might have folders reserved for audio content, folders for special effects, folders for combinations of sounds that make up the ambience noise you need for a certain film take, etc. These can all be set as different **Favorites** in the **MediaBay**, allowing you to limit the files available in the **Results** list according to context.

By using the search and filter options, you can narrow down the results.

You can insert the files into your project by using drag and drop, by double-clicking, or by using the context menu options.

Using Media Files

The **MediaBay** window and the **Media** rack in the right zone of the **Project** window offer you multiple possibilities to search for specific files, loops, samples, presets, and patterns that you can use in your project.

Once you have found the media files that you were looking for, you can load them into your project.

Loading Loops and Samples

PROCEDURE

1. Do one of the following:
 - In the **MediaBay**, open the media types selector, click **MIDI Files**, **Audio Files**, or **MIDI Loops**, and select a media file.
 - In the **Media** rack in the right zone, click the **Loops & Samples** tile, and click the following tiles until you can select the media files from the **Results** list.
 2. Do one of the following:
 - Double-click a media file to create a new instrument or an audio track with the loaded file.
 - Drag the media file to a track in the event display.
-

RESULT

The media file is inserted on the new track or at the insert position.

RELATED LINKS

[Show Media Types Selector](#) on page 485

Loading Track Presets

PROCEDURE

1. Do one of the following:
 - In the **MediaBay**, open the media types selector, click **Track Presets**, and select a preset.
 - In the **Media** rack in the right zone, click **Presets > Track Presets**, and click the following tiles until you can select the preset from the **Results** list.
 2. Do one of the following:
 - Double-click the track preset to create a new track with the loaded preset.
 - Drag the track preset to a track to apply the preset to the track.
-

RESULT

The preset is applied to the track, and all settings of the preset are loaded.

RELATED LINKS

[Show Media Types Selector](#) on page 485

Loading Instrument Presets

PROCEDURE

1. Do one of the following:
 - In the **MediaBay**, open the media types selector, click **Plug-in Presets**, and select a preset for an instrument plug-in.
 - In the **Media** rack in the right zone, click the **VST Instruments** tile, and click the following tiles until you can select the preset from the **Results** list.
 2. Do one of the following:
 - Double-click the instrument preset to create a new instrument track with the loaded instrument preset.
 - Drag the instrument preset to the track list to create a new instrument track with the loaded instrument preset.
 - Drag the instrument preset to the event display to create a new instrument track with the loaded instrument preset.
 - Drag the instrument preset to an instrument track to apply the preset to the track.
-

RESULT

The instrument is loaded as a track instrument, and the preset is applied to the instrument track.

RELATED LINKS

[Adding VST Instruments to Projects](#) on page 474

[Show Media Types Selector](#) on page 485

Loading Effect Plug-In Presets

PROCEDURE

1. Do one of the following:
 - In the **MediaBay**, open the media types selector, click **Plug-in Presets**, and select a preset.
 - In the **Media** rack in the right zone, click **Presets > VST FX Presets**, and click the following tiles until you can select the preset from the **Results** list.
 2. Do one of the following:
 - Drag the plug-in preset to an audio track or to its **Inserts** section in the **Inspector**.
 - Drag the plug-in preset to an empty area of the track list.
-

RESULT

If you drag the plug-in preset to an audio track, the first free insert slots are filled with the corresponding plug-in. If there are no more free slots available, a warning is displayed.

If you drag the plug-in preset to an empty area of the track list, a new FX channel track is created, and the first insert slots of this new track are filled.

RELATED LINKS

[Show Media Types Selector](#) on page 485

[Adding VST Effects to Projects](#) on page 474

Loading FX Chain Presets

PROCEDURE

1. Do one of the following:
 - In the **MediaBay**, open the media types selector, click **FX Chain Presets**, and select a preset.
 - In the **Media** rack in the right zone, click **Presets > FX Chain Presets**, and click the following tiles until you can select the preset from the **Results** list.
 2. In the **Project** window, select an audio track.
 3. Drag the preset from the **MediaBay** or **Media** rack, and drop it onto the open **Inserts** section of the **Inspector**.
-

RESULT

The **FX Chain Preset** is applied to the track, and all settings of the preset are loaded. Any previously loaded inserts are overwritten.

RELATED LINKS

[Show Media Types Selector](#) on page 485

Loading Strip Presets

PROCEDURE

1. Do one of the following:
 - In the **MediaBay**, open the media types selector, click **Strip Presets**, and select a preset.

- In the **Media** rack in the right zone, click **Presets > Strip Presets**, and click the following tiles until you can select the preset from the **Results** list.
2. In the **Project** window, select an audio track.
 3. Drag the preset from the **MediaBay** or **Media** rack and drop it onto the open **Strip** section of the **Inspector**.
-

RESULT

The strip preset is applied to the track, and all settings of the preset are loaded.

RELATED LINKS

[Show Media Types Selector](#) on page 485

[Saving/Loading Strip Presets](#) on page 312

Working with Volume Databases

Cubase saves all media file information used in the **MediaBay**, such as paths and attributes, in a local database file on your computer. However, in some cases, it is necessary to browse and manage this kind of metadata on an external volume.

For example, a sound editor might have to work both at home and in a studio, on two different computers. Therefore, the sound effects are stored on an external storage medium. To be able to connect the external device and browse its contents in the **MediaBay** without having to scan the device, you have to create a volume database for the external device.

You can create volume databases for your computer drives or for external storage media. They contain the same information about the media files as the regular **MediaBay** database.

NOTE

When you launch Cubase, all available volume databases are automatically mounted. Databases that are made available while the program is running have to be mounted manually.

Rescanning Volume Databases

If you have modified the data on your external volume on a different system, you must rescan the **MediaBay**.

RELATED LINKS

[Refresh Views](#) on page 482

Creating Volume Databases

PROCEDURE

- In the **File Browser** section, right-click the external storage medium, drive, or partition of your computer system, and select **Create Volume Database**.

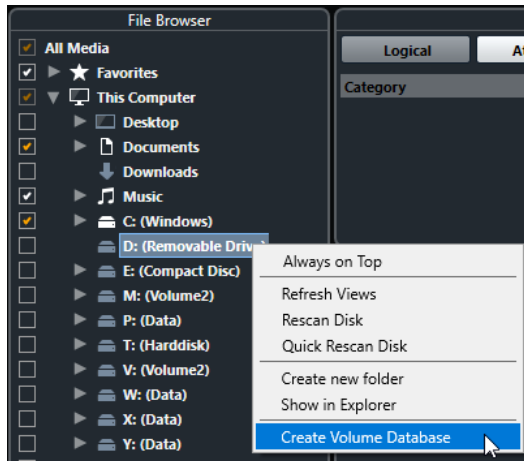

IMPORTANT

Select the topmost directory level for this. You cannot create a database file for a lower-level folder.

NOTE

If you create a volume database on a network drive, multiple users can access it. This can lead to write conflicts, as only one user at a time can write to the database.

RESULT

The file information for this drive is written into a new database file. Volume databases are indicated by the symbol  to the left of the drive name.

NOTE

If the drive contains a large amount of data, this process may take some time.

Volume databases are automatically mounted when Cubase is launched. They are shown in the **File Browser** section, and their data can be viewed and edited in the **Results** list.

RELATED LINKS

[Locked Volume Databases on Network Drives](#) on page 497

Locked Volume Databases on Network Drives

You can unlock volume databases on network drives. This can be necessary, if the system of another user who also used the volume database on the network drive crashed or was not properly disconnected. In this case, Cubase creates a file in a hidden folder, which indicates that the database is still in use.

If this happens, you get a warning message when you launch the program. It shows the name of the user or the system.

Do one of the following:

- Ask the other user to restart Cubase, so that the lock is automatically released.
- If you cannot reach the other user and you do not need to access the database, click **Ignore Database**.

- If you cannot reach the other user and you want to use the database, click **Force unlock** to remove the lock.

Removing Volume Databases

If you have worked on another computer using an external hard disk and return to your own computer and connect the external device as part of your system setup, you no longer need a separate volume database. Any data on this drive can be included in the local database file again, removing the extra database file.

PROCEDURE

- In the **File Browser** section, right-click the volume database, and select **Remove Volume Database**.

RESULT

The metadata is integrated in the local **MediaBay** database file, and the volume database file is deleted.

NOTE

If the drive contains a large amount of data, this process may take some time.

Mounting and Unmounting Volume Databases

Volume databases that are made available while Cubase is running must be mounted manually.

- To manually mount a volume database, right-click the external storage medium, drive, or partition of your computer system that you want to mount, and select **Mount Volume Database**.
- To unmount a volume database, right-click it, and select **Unmount Volume Database**.

MediaBay Settings

- To open a pane with settings for the **MediaBay**, click **MediaBay Settings**.

The following options are available:

Hide Folders That Are Not Scanned

Hides all folders that are not scanned for files. This keeps the tree view in the **File Browser** less cluttered.

Show Only Selected Folder

Shows only the selected folder and its subfolders.

Scan Folders Only When MediaBay Is Open

Scans folders for media files when the **MediaBay** window is open.

If this option is deactivated, the folders are scanned in the background, even when the **MediaBay** window is closed. However, Cubase never scans folders while playing back or recording.

Maximum Items in Results List

Allows you to specify the maximum number of files to be displayed in the **Results** list. This avoids unmanageably long lists of files.

NOTE

The **MediaBay** does not warn you if the maximum number of files has been reached. There might be situations where a certain file cannot be found because the maximum number of files was exceeded.

Show File Extensions in Results List

Shows file name extensions in the **Results** list.

Scan Unknown File Types

When scanning for media files, the **MediaBay** ignores files with unknown file extensions. If this option is activated, the **MediaBay** tries to open and scan any file in the search location and ignores files that cannot be recognized.

Automation

In essence, automation refers to recording values for a particular **MixConsole** or effect parameter. When you create your final mix, Cubase can adjust this particular parameter control.

Recording your Actions

If the settings in your current project are crucial, you may not want to experiment with automation until you know more about how it all fits together. If so, you can create a new project for the following example. The project does not have to contain any audio events, just a few audio tracks.

PROCEDURE

1. On the **Project** window toolbar, click **W** to activate write for all tracks.
2. Start playback and adjust some volume faders and/or other parameter settings in the **MixConsole**.
Stop playback when you are done, and return to the position where you started playback.
3. Click **W** to deactivate the write mode and click **R** to activate read for all tracks.
4. Start playback, and watch the **MixConsole**.
All your actions that were performed during the previous playback are reproduced exactly.
5. Select **Project > Show All Used Automation** to view all recorded automation events.
6. To redo anything that was recorded, click **W** again and start playback from the same position.

NOTE

You can have **W** and **R** activated simultaneously, if you want to watch and listen to your recorded **MixConsole** actions while you are recording fader movements for another channel, etc.

Automation Curves

Within a Cubase project, the changes affecting parameter values over time are represented by curves on automation tracks.

There are different kinds of automation curves:



1 Ramp curves

Ramp curves are created for any parameter that generates continuous multiple values, such as fader or encoder movements.

2 Step curves

Step curves are created for on/off parameters, such as mute.

Static Value Line

When you open an automation track for the first time, it does not contain any automation events. This is indicated by a dotted horizontal line, the static value line, in the event display. This line represents the current parameter setting.

If you manually add any automation events or use write automation for the corresponding parameter and then disable the reading of automation data, the automation curve is grayed out and the static value line is used instead.

As soon as **Read** is enabled, the automation curve is used.

Write/Read Automation

You can automation-enable tracks and **MixConsole** channels by activating their automation write **W** and read **R** buttons.

- If you activate **W** for a channel, virtually all **MixConsole** parameters that you adjust during playback for that specific channel are recorded as automation events.
- If **R** is activated for a channel, all your recorded **MixConsole** actions for that channel are performed during playback.

The **R** and **W** buttons for a track in the track list are identical to the **R** and **W** buttons in the **MixConsole**.

NOTE

R is automatically enabled when you enable **W**. This allows Cubase to read existing automation data at any time. You can separately deactivate **W** if you only want to read existing data.

You can also find global read and write indicator buttons **Activate/Deactivate Read/Write for All Tracks** on the **Project** window toolbar and on the **MixConsole** toolbar. These buttons light up as soon as an **R** or **W** button on any channel/track within your project is enabled. Furthermore, they can be clicked to activate or deactivate **R/W** of all tracks simultaneously.

Writing Automation Data

You can create automation curves manually or automatically.

- Manual writing makes it easy to quickly modify parameter values at specific points, without having to activate playback.
- Automatic writing lets you work almost as if you were using a real mixer.

With both methods, any applied automation data is reflected in both the **MixConsole** by a moved fader, for example, and in the corresponding automation track curve.

RELATED LINKS

[Manual Writing of Automation Data](#) on page 502

Automatic Writing of Automation Data

Every action that you perform is automatically recorded on automation tracks which you can later open for viewing and editing.

PROCEDURE

1. In the track list, click **Show/Hide Automation** for a track to open its automation track.

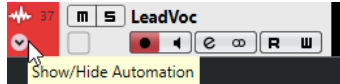

2. Click **W** to enable the writing of automation data on this track.
3. Start playback.
4. Adjust the parameters in the **MixConsole**, in the **Channel Settings** window, or on the effect control panel.

The value settings are recorded and displayed on the automation tracks as a curve. When automation data is being written, the color of the automation track changes, and the delta indicator in the automation track indicates the deviation of the new parameter from any previously automated value.

5. Stop playback and return to the position where you started playback.
 6. Click **W** to disable the writing of automation data.
 7. Start playback.
-

RESULT

All actions that you record are reproduced exactly. When you drag a plug-in to a different insert slot on the same channel, any existing automation data moves with the plug-in. When you drag it to an insert slot on a different channel, any existing automation data is not transferred to the new channel.

Manual Writing of Automation Data

You can manually add automation events by drawing automation curves on an automation track.

PROCEDURE

1. In the track list, click **Show/Hide Automation** for a track to open its automation track.

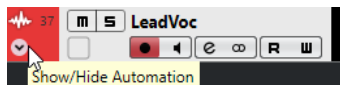

2. Click the automation parameter name, and select the parameter from the pop-up menu.
3. Select the **Draw** tool.
4. Click on the static value line.

An automation event is added, read automation mode is automatically activated, and the static value line changes to a colored automation curve.

5. Click and hold to draw a curve by adding automation events.
When you release the mouse button, the number of automation events is reduced.
 6. Start playback.
-

RESULT

The automated parameter changes with the automation curve, and the corresponding fader in the **MixConsole** moves accordingly.

AFTER COMPLETING THIS TASK

Repeat the procedure in case you are not satisfied with the result. If you draw over existing events, a new curve is created.

Tools for Drawing Automation Data

Apart from the **Draw** tool, you can use the **Object Selection** tool and the **Line** tool to draw automation events. If you click on the automation track with any of these tools, **R** is activated automatically.

- **Object Selection**

If you click on an automation track with the **Object Selection** tool, an automation event is added. If you hold down **Alt/Opt**, you can draw several automation events.

NOTE

Events that are introduced between existing events and do not deviate from the existing curve are removed as soon as you release the mouse button.

To activate the **Line** tool in any other available mode, click the **Line** tool, and click again to open a pop-up menu where you can select the **Line** tool mode.

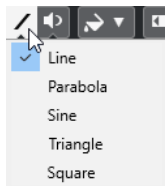

The following **Line** tool modes are available:

Line

If you click on the automation track and drag, with the **Line** tool in **Line** mode, you can create automation events in a line. This is a quick way to create linear fades, etc.

Parabola

If you click and drag on the automation track, with the **Line** tool in **Parabola** mode, you can create more natural curves and fades.

NOTE

The result depends on the direction from which you draw the parabolic curve.

Sine/Triangle/Square

If you click and drag on the automation track, with the **Line** tool in **Sine**, **Triangle**, or **Square** mode and with the **Snap Type** set to **Grid**, the period of the curve, that is, the length of one curve cycle, is determined by the grid setting. If you press **Shift** and drag, you can set the period length manually, in multiples of the grid value.

NOTE

The **Line** tool can only be used for ramp type automation curves.

Editing Automation Events

Automation events can be edited in the same manner as other events.

NOTE

If you move an event or part on a track and you want the automation events to follow automatically, select **Edit > Automation Follows Events**. Any existing automation events at the new position are overwritten.

- You can use the tools on the **Project** window toolbar to edit automation events.
- You can use the automation event editor to edit selected automation events on ramp automation curves.

RELATED LINKS

[Project Window Toolbar](#) on page 36

[Automation Event Editor](#) on page 505

Creating Smooth Transitions Between Automation Events (Bézier Automation Curves)

Cubase supports bézier automation curves that allow you to create smooth transitions between automation events. This way, you can edit linear ramp curves with more precision, flexibility, and intuition.

PREREQUISITE

The **Object Selection** tool is active.

PROCEDURE

1. Move the mouse pointer on the linear ramp curve segment that you want to edit.
A handle is shown on the curve segment.



NOTE

If the automation events are next to each other on an almost horizontal or vertical line, or if they are too close to each other, the handle is not available.

2. Click and drag, with the mouse button pressed to modify the shape of the curve segment.



3. As soon as you are satisfied with the result, release the mouse button.

RESULT

A smooth transition curve is created, reflecting your edits.

If you are not satisfied with the result and want to start over again from the original linear curve segment, double-click the handle.

AFTER COMPLETING THIS TASK

For even more precise editing, add new automation events to your bézier curve segment.



This creates new segments that you can smoothen.



Selecting Automation Events

- To select an automation event, click it with the **Object Selection** tool.
- To select multiple events, drag a selection rectangle with the **Object Selection** tool or **Shift**-click the events.
- To select multiple events, select a range with the **Range Selection** tool or **Shift**-click the events.
- To select all automation events on an automation track, right-click the automation track, and select **Select All Events** from the context menu.

Selected events are indicated by a dark color.

NOTE

If you select several events of a ramp automation curve, the automation event editor becomes available.

RELATED LINKS

[Automation Event Editor](#) on page 505

Automation Event Editor

The automation event editor allows you to edit selected events on the automation track. The automation event editor is only available for automation ramp curves.

NOTE

All editing in the automation event editor only affects the automation events that are part of the selection.

To open the automation event editor, do one of the following:

- Activate the **Object Selection** tool, and drag a selection rectangle on a ramp type automation track.
- Activate the **Range Selection** tool, and select a range on a ramp type automation track.

NOTE

If you work with the **Range Selection** tool, the smart control for **Stretch** is not available.

The automation event editor features the following smart controls for specific editing modes:

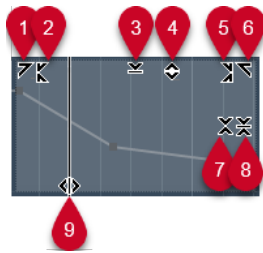

1 Tilt Left

If you click in the upper left corner of the editor, you can tilt the left part of the curve. This allows you to tilt the event values at the start of the curve upwards or downwards.

2 Compress Left

If you **Alt/Opt**-click in the upper left corner of the editor, you can compress or expand the left part of the curve. This allows you to compress or expand the event values at the start of the curve.

3 Scale Vertically

If you click in the middle of the upper border of the editor, you can scale the curve vertically. This allows you to raise or lower the event values of the curve in percent.

4 Move Vertically

If you click on the upper border of the editor, you can move the entire curve vertically. This allows you to raise or lower the values of the event values of the curve.

5 Compress Right

If you **Alt/Opt**-click in the upper right corner of the editor, you can compress or expand the right part of the curve. This allows you to compress or expand the event values at the end of the curve.

6 Tilt Right

If you click in the upper right corner of the editor, you can tilt the right part of the curve. This allows you to tilt the event values at the end of the curve upwards or downwards.

7 Scale Around Relative Center

If you **Alt/Opt**-click in the middle of the right border of the editor, you can scale the curve relative to its center. This allows you to raise or lower the event values horizontally around the center of the editor.

8 Scale Around Absolute Center

If you click in the middle of the right corner of the editor, you can scale the curve absolute to its center. This allows you to raise or lower the event values horizontally around the center of the editor.

9 Stretch

If you click on the lower border of the editor, you can stretch the curve horizontally. This allows you to move the event values of the curve to the left or to the right.

NOTE

To edit the automation curves on several tracks simultaneously, select the automation events on the corresponding automation tracks with the **Object Selection** tool or the **Range Selection** tool, and hold down **Ctrl/Cmd** while using the smart controls.

NOTE

If you select automation events with the **Range Selection** tool, additional automation events are automatically created at the start and at the end of the selection. This ensures that the entire selection is edited.

RELATED LINKS

[Automation Curves](#) on page 500

Quick Vertical Scaling of Automation Events

You can vertically scale the curve segment between two automation events without selecting the events first.

PROCEDURE

1. Move the mouse pointer to the upper border of the automation track, above the linear ramp curve segment that you want to scale.

A handle is shown.



2. Click and drag up or down, with the mouse button pressed.
 3. When you are satisfied with the result, release the mouse button.
-

RESULT

The curve segment between the two automation events is scaled.

Moving Automation Events

Moving Single Automation Events

- To move a selected automation event, click it and drag to the left or to the right.
- To restrict the direction of the movement, press **Ctrl/Cmd** and drag.

NOTE

Snap is taken into account when you move automation curves horizontally. To turn it off temporarily, hold down **Ctrl/Cmd** and any other modifier, and drag.

Moving Multiple Automation Events

- To move a selection of automation events, click inside the selection rectangle, and drag to the left or to the right.

If you made a continuous selection of automation events, events at the destination range are overwritten. However, if you move the same selection range past existing events, they appear again. If a selection range contains automation events that are deselected, dragging is restricted. You cannot move this selection past existing events.

- To copy a continuous selection of automation events, click inside the selection rectangle, hold down **Alt/Opt**, and drag to the left or to the right.

NOTE

If you press **Esc** while dragging the selection rectangle, the selection jumps back to its original position.

RELATED LINKS

[Selecting Automation Events](#) on page 505

Removing Automation Events

- To remove an automation event, click on it with the **Erase** tool.
- To remove multiple automation events, select them, and press **Backspace** or **Delete** or select **Edit > Delete**.
- To remove all automation events from the automation track and close the automation track, click the automation parameter name in the track list, and select **Remove Parameter** from the pop-up menu.

NOTE

When removing automation events, the curve is redrawn to connect the remaining events.

Automation Tracks

Most of the tracks in your project have automation tracks, one for each automated parameter.

To show automation tracks, open them.

Showing/Hiding Automation Tracks

- Position the mouse pointer over the lower left corner of the track, and click the arrow icon (**Show/Hide Automation**) that appears.
- Right-click the track in the track list, and select **Show/Hide Automation** from the context menu.
- To open another automation track, position the mouse pointer over the lower left corner of an automation track, and click + (**Append Automation Track**).
- To show all used automation tracks in the track list, right-click any track, and select **Show All Used Automation** from the context menu.
- To open the corresponding automation track on writing automation parameters, activate **Show Automation Track in Project on Writing Parameter** in the **Preferences** dialog (**Editing** page).

Removing Automation Tracks

- To remove an automation track with all automation events, click the parameter name, and select **Remove Parameter** from the pop-up menu.
- To remove all automation tracks from a track that do not contain automation events, select **Remove Unused Parameters** from any of its automation parameter name pop-up menus.

Assigning a Parameter to an Automation Track

Parameters are already assigned to automation tracks when you open them, according to their order in the parameter list.

PROCEDURE

1. Open an automation track, and click on the automation parameter name.
A parameter list is shown. The content depends on the track type.
2. Do one of the following:
 - Select the parameter.
 - Select **More** to open the **Add Parameter** dialog that lists all parameters that can be automated, and select the parameter.

RESULT

The parameter replaces the current parameter in the automation track.

NOTE

Replacing automation parameters is non-destructive. If the automation track contains any automation data for the parameter that you replaced, this data is still available, although it is not visible. By clicking on the name of the automation parameter in the track list, you can switch back to the replaced parameter. On the pop-up menu, an asterisk (*) after the parameter name indicates hidden automation tracks.

Muting Automation Tracks

By muting an automation track, you turn off automation for a single parameter.

- To mute individual automation tracks, click **Mute Automation** in the track list.

VST Instruments

VST instruments are software synthesizers or other sound sources that are included with Cubase. They are played internally via MIDI. You can add effects or EQ to VST instruments.

Cubase allows you to make use of VST instruments in the following ways:

- By adding a VST instrument and assigning one or several MIDI tracks to it.
- By creating an instrument track.

This is a combination of a VST instrument, an instrument channel, and a MIDI track. You play and record MIDI note data for this track.

NOTE

Some VST instruments are included with Cubase. These are described in the separate document **Plug-in Reference**.

RELATED LINKS

[Instrument Tracks](#) on page 108

Adding VST Instruments

PROCEDURE

1. On the **Studio** menu, select **VST Instruments**.
2. Right-click on an empty area of the **VST Instruments** window.
3. From the context menu, select **Add Rack Instrument**.
4. From the instrument selector, select an instrument.
5. Click **Create**.

RESULT

The instrument control panel opens, and the following tracks are added to the track list:

- A MIDI track with the name of the instrument. The output of the MIDI track is routed to the instrument.

NOTE

In the **Preferences** dialog (**VST—Plug-ins** page), you can specify what happens when you load a VST instrument.

- A folder with the name of the instrument that is added within a **VST Instruments** folder. The instrument folder contains two automation tracks: one for the plug-in parameters and one for the synth channel in the **MixConsole**.

VST Instrument Control Panel

The VST instrument control panel allows you to set up the parameters of the selected instrument. The contents, the design, and the layout of the control panel depend on the selected instrument.

The following controls are available:



- 1 Activate Instrument**
Activates/Deactivates the instrument.
- 2 Read Automation/Write Automation**
Allows you to read/write automation for the instrument parameter settings.
- 3 Switch between A/B Settings**
Switches to setting B when setting A is active, and to setting A when setting B is active.
- 4 Apply current settings to A and B**
Copies the instrument parameters of instrument setting A to instrument setting B, and vice versa.
- 5 Activate/Deactivate Side-Chaining**
Activates the side-chain functionality for VST 3 instruments that support side-chaining.
- 6 Set up Side-Chain Routing**
Allows you to set up the side-chain routing for the selected plug-in.
- 7 Event Received Indicator**
Lights up on receiving note-on and controller messages.
- 8 Preset browser**
Opens the preset browser, where you can select another preset.
- 9 Load previous Program/Load next Program**

Loads the previous/next program in the preset browser.

10 Preset Management

Opens a pop-up menu that allows you to save, rename, or remove a preset.

11 Add VST Plug-in Picture to Media Rack

Adds a picture of the VST plug-in to the **Media** rack. This is only available for plug-ins of other vendors.

12 VST Instrument context menu

Opens a context menu with specific functions and settings.

13 Show/Hide VST Quick Controls

Shows/hides the quick controls.

14 Focus Quick Controls Lock State: Locked/Unlocked

Allows you to lock the focus of the quick control to the plug-in window.

15 Focus Quick Controls Indicator

If this indicator is lit, the plug-in window has the quick control focus.

RELATED LINKS

[Adding Pictures of VST Instruments to the Media Rack](#) on page 476

[VST Instrument Context Menu](#) on page 517

[Hiding/Showing VST Instrument Control Panels](#) on page 512

[Side-Chaining for VST Instruments](#) on page 525

[Setting up Focus Quick Controls in the MIDI Remote Mapping Assistant](#) on page 563

[Focus Quick Controls](#) on page 562

Hiding/Showing VST Instrument Control Panels

When you add a VST instrument, the respective plug-in control panel opens automatically. You can hide the control panels from view. This is useful to get a better overview if you added a number of plug-ins to your project whose control panels clutter up the screen.

PROCEDURE

- Select **Window > Hide Plug-in Windows**.

NOTE

This also hides VST effect control panels.

RESULT

The plug-in windows are hidden and sent to the back of the application. To show them again, select **Show Plug-in Windows**.

RELATED LINKS

[VST Instrument Control Panel](#) on page 511

Closing All Control Panels

When you add a VST instrument, the respective plug-in control panel opens automatically. You can close all control panels at once.

PROCEDURE

- Select **Window > Close All Plug-in Windows**.

NOTE

This also closes VST effect control panels.

RESULT

The control panels are closed.

RELATED LINKS

[VST Instrument Control Panel](#) on page 511

VST Instrument Selector

The VST instrument selector allows you to select VST instruments from the active collection.

To open the VST instrument selector, do one of the following:

- Select **Studio > VST Instruments**, and click **Add Rack Instrument**.
- Select **Studio > VST Instruments**, click **Add Track Instrument**, and open the **Instrument** pop-up menu.

The following controls are available:

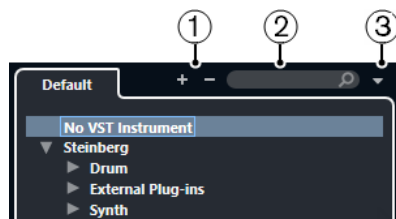

1 Expand Tree/Collapse Tree

Expands/Collapses the tree.

2 Search VST Instrument

Allows you to search for VST instruments by typing in the name or parts of the name or the category.

3 Plug-in Collections and Options

Allows you to select a collection.

If you select the **Default** collection, the options **Sort By Category** and **Sort by Vendor** become available. They allow you to sort the default collection.

Creating Instrument Tracks

You can create instrument tracks that contain dedicated VST instruments.

PROCEDURE

1. In the global track controls area of the track list, click **Add Track** .
2. Click **Instrument**.
3. Open the **Instrument** pop-up menu, and select a VST instrument.
4. Click **Add Track**.

RESULT

The selected VST instrument is loaded for the instrument track. In the **MixConsole**, an instrument channel is added.

VSTi Rack in the Right Zone

The **VSTi** rack in the right zone of the **Project** window allows you to add VST instruments for MIDI and instrument tracks.

All instruments that are used in your project are shown. You can access up to 8 quick controls for each added instrument.

To open the **VSTi** rack in the right zone, click **Show/Hide Right Zone** on the **Project** window toolbar, and, at the top of the right zone, click the **VSTi** tab.



NOTE

The **VSTi** rack in the right zone is just another representation of the **VST Instruments** window. All features are identical.

RELATED LINKS

- [Showing/Hiding Zones](#) on page 35
- [Project Window Toolbar](#) on page 36

VST Instruments Window

The **VST Instruments** window allows you to add VST instruments for MIDI and instrument tracks.

All instruments that are used in your project are shown. You can access up to 8 quick controls for each added instrument.

To open the **VST Instruments** window, select **Studio > VST Instruments**.

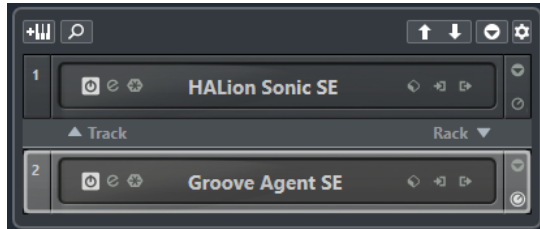

RELATED LINKS

[Instrument Tracks](#) on page 108

VST Instruments Window Toolbar

The **VST Instruments** window toolbar contains controls that allow you to add and set up VST instruments and **VST Quick Controls**.

Add Track Instrument



Opens the **Add Track** dialog that allows you to select an instrument and to add an instrument track that is associated with this instrument.

Find Instruments



Opens a selector that allows you to find a loaded instrument.

Set Remote-Control Focus for VST Quick Controls to Previous Instrument



Allows you to set the remote control focus to the previous instrument.

Set Remote-Control Focus for VST Quick Controls to Next Instrument



Allows you to set the remote control focus to the next instrument.

Show/Hide all VST Quick Controls



Shows/Hides the default quick controls for all loaded instruments.

Settings



Opens the **Settings** pop-up menu, where you can activate/deactivate the following modes:

- **Show VST Quick Controls for One Slot Only** shows the **VST Quick Controls** exclusively for the selected instrument.

- **MIDI Channel follows track selection** ensures that the **Channel** selector follows the MIDI track selection in the **Project** window. Use this mode if you work with multitimbral instruments.
- **Remote-Control Focus for VST Quick Controls follows track selection** ensures that the **VST Quick Controls** remote control focus follows the track selection.

VST Instrument Controls

The VST instrument controls allow you to make settings for a loaded VST instrument.

The following controls are available for each instrument:

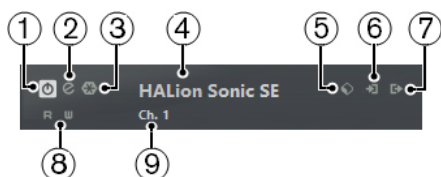

- 1 Activate Instrument**
Activates/Deactivates the instrument.
- 2 Edit Instrument**
Opens the instrument panel.
- 3 Freeze Instrument**
Freezes the instrument. This allows you to save CPU power.
- 4 Instrument selector**
Allows you to select another instrument. Double-click to rename the instrument. The name is shown in the **Output Routing** pop-up menu for MIDI tracks. This is useful for working with several instances of the same instrument.
- 5 Preset Browser**
Allows you to load or save an instrument preset.
- 6 Input Options**
This lights up when MIDI data is received by the instrument. Click this button to open a pop-up menu that allows you to select, mute/unmute, and solo/unsolo for tracks that send MIDI to the instrument (inputs).
NOTE
If you resize the **VST Instruments** window, you can access this option by using an **Input/Output Options** pop-up menu.
- 7 Activate Outputs**
This control is only available if the instrument provides more than one output. It allows you to activate one or more outputs for the instrument.
NOTE
If you resize the **VST Instruments** window, you can access this option by using an **Input/Output Options** pop-up menu.
- 8 Read Automation/Write Automation**
Allows you to read/write automation for the instrument parameter settings.
- 9 Select Quick Control Layer**

Allows you to select a program.

RELATED LINKS

[Freezing Instruments](#) on page 520

VST Instrument Context Menu

The VST instrument control panel context menu and the **Functions** menu on the VST instrument control panel display functions and settings that are specific to the instrument.

Do one of the following:

- Right-click an empty area of the VST instrument control panel.
- Open the **Functions** pop-up menu on the VST instrument control panel.

The following functions are available:

Copy <VST instrument name> Setting/Paste <VST instrument name> Setting

Allows you to copy the instrument settings and paste them to another instrument.

Load Preset/Save Preset

Allows you to load/to save a preset.

Default Preset

Allows you to define and save a default preset.

Switch to A Setting/Switch to B Setting

Switches to setting B when setting A is active, and to setting A when setting B is active.

Apply Current Settings to A/Apply Current Settings to B

Copies the instrument parameters of instrument setting A to instrument setting B, and vice versa.

Activate Outputs

Allows you to activate one or more outputs for the instrument.

Activate/Deactivate Side-Chaining

Activates/Deactivates side-chaining for the instrument.

NOTE

This option is only available for VST 3 instruments that support side-chaining.

Remote Control Editor

Opens the **Remote Control Editor**.

Switch to Generic Editor

Opens the generic editor for the instrument.

Allow Window to be Resized

Allows for dynamic resizing of third-party plug-in windows in Cubase. This is useful if you activated **Enable HiDPI** (Windows only) in the **Preferences** dialog (**General** page) and your plug-in does not support dpi settings.

NOTE

Allow Window to be Resized is a plug-in-specific setting. Activate/deactivate it for every plug-in that requires it.

RELATED LINKS

[General](#) on page 838

[Side-Chaining for VST Instruments](#) on page 525

Presets for Instruments

You can load and save presets for instruments. Presets contain all the settings that are required for the sound that you want.

The following presets for instruments are available:

- **VST Presets**

VST presets include the parameter settings of a VST instrument.

Presets are available from the **VST Instruments** window, from the instrument control panels, and from the **Programs** field in the **Inspector**.

- **Track Presets**

Track presets include the instrument track settings and the settings for the corresponding VST instrument.

Presets are available from the **Inspector** or the track list context menu.

Loading VST Presets

You can load **VST Presets** from the **VST Instruments** window, from the control panel or from the **Inspector**.

PROCEDURE

1. Do one of the following:
 - Select the track that contains the VST instrument. In the **Inspector**, click the **Programs** field.
 - In the **VST Instruments** window, click **Preset Browser** for the instrument, and select **Load Preset**.
 - In the control panel for the VST instrument, click **Preset Browser**, and select **Load Preset**.
2. In the preset browser, select a preset from the list, and double-click it to load it.

RESULT

The preset is applied. To return to the previously loaded preset, open the preset browser again, and click **Revert to Last Setting**.

Saving VST Presets

You can save your settings on VST instruments as VST presets for further use.

PROCEDURE

1. Do one of the following:
 - In the **VST Instruments** window, click **Preset Browser** for the instrument, and select **Save Preset**.
 - In the control panel for the VST instrument, click **Preset Browser**, and select **Save Preset**.

2. In the **Save <VST instrument name> Preset** dialog, enter a name for the preset.
3. Click **OK** to save the preset and close the dialog.

Loading Track Presets

You can load track presets for instrument tracks from the **Inspector**.

PROCEDURE

1. Do one of the following:
 - Select the instrument track, and, in the **Inspector**, click the **Load Track Preset** field.
 - Right-click the instrument track, and, from the context menu, select **Load Track Preset**.
2. In the preset browser, select a preset from the list, and double-click it to load it.

RESULT

The track preset is applied. To return to the previously loaded preset, open the preset browser again, and click **Revert to Last Setting**.

Instrument Presets Results Browser

The **Results** browser for instrument track presets allows you to preview VST presets and to apply them to your instrument track.

- To open the **Results** browser, right-click an instrument track, and select **Load Track Preset**.



VST presets for instruments can be divided into the following groups:

Presets

Presets contain the settings of the entire plug-in. For multitimbral instruments, this includes the settings for all sound slots as well as the global settings.

Programs

Programs contain only the settings for one program. For multitimbral instruments, this includes only the settings for one sound slot.

Saving Track Presets

You can save your settings on instrument tracks as track presets for further use.

PROCEDURE

1. Right-click the instrument track, and, from the context menu, select **Save Track Preset**.
 2. In the **Save Track Preset** dialog, enter a name for the preset.
 3. Click **OK** to save the preset and close the dialog.
-

Playing Back VST Instruments

After you have added a VST instrument and selected a sound, you can play back the VST instrument using the instrument or MIDI track in your project.

PROCEDURE

1. In the track list, activate **Monitor** for the track with the loaded VST instrument.
 2. Press one or more keys on your MIDI keyboard or use the **On-Screen Keyboard**.
The corresponding sounds are triggered on your VST instrument.
 3. Select **Studio > MixConsole** to open the **MixConsole**, and adjust the sound, add EQ or effects, assign another output routing, etc.
-

VST Instruments and Processor Load

VST instruments can consume a lot of CPU power. The more instruments you add, the more likely it is that you run out of processor power during playback.

If the **Processing Overload** indicator in the **Audio Performance** window lights up or you get crackling sounds, you have the following options:

- Activate **Freeze Instrument Channel**.
This renders the instrument into an audio file and unloads it.
- Activate **Suspend VST 3 plug-in processing when no audio signals are received** for VST 3 instruments.
This ensures that your instruments do not consume CPU power on silent passages.

RELATED LINKS

[Freezing Instruments](#) on page 520

[Suspend VST 3 plug-in processing when no audio signals are received](#) on page 849

Freezing Instruments

If you are using a moderately powerful computer or a large number of VST instruments, your computer may not be able to play back all instruments in real time. At this point, you can freeze instruments.

PROCEDURE

1. Do one of the following:
 - Select **Studio > VST Instruments**.
 - Select the instrument track, and open the top **Inspector** section.

2. Click **Freeze Instrument Channel**.
 3. In the **Freeze Channel Options** dialog, make your changes.
 4. Click **OK**.
-

RESULT

- The output of the instrument is rendered to an audio file. On playback you hear the same sound as before freezing.
- Less CPU load is used.
- The **Freeze Instrument Channel** button lights up.
- The track controls are grayed out.
- The MIDI parts are locked.
- You can still adjust the level and panning, make EQ settings, and adjust the effect sends.

NOTE

The audio file is saved in the **Freeze** folder that can be found in the following location:

- Windows: within the **Project** folder
 - macOS: **User/Documents**
-

AFTER COMPLETING THIS TASK

To unfreeze a frozen track, click **Freeze** again.

RELATED LINKS

[Freezing Multiple Tracks](#) on page 145

[Freeze Channel Options Dialog for Instruments](#) on page 521

[Unfreeze Channel Options Dialog for Instruments](#) on page 522

Freeze Channel Options Dialog for Instruments

The **Freeze Channel Options** allows you to specify exactly what is supposed to happen when you freeze an instrument.

To open the **Freeze Channel Options** dialog, select the instrument track, and do one of the following:

- In the top **Inspector** section, click **Freeze Instrument Channel**.
- Select **Edit > Freeze/Unfreeze > Selected Tracks**.
- Right-click the selected track, and from the context menu, select **Freeze/Unfreeze Selected Tracks**.

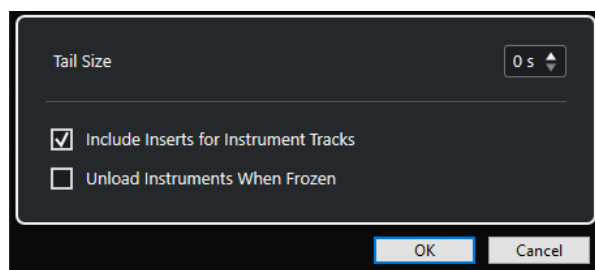

Tail Size

Allows you to set a tail size time to let sounds complete their normal release cycle.

Include Inserts for Instrument Tracks

Activate this option if you want to include insert effects on this channel when freezing the instrument.

NOTE

You can still adjust level, pan, sends, and EQ.

Deactivate this option if you still want to be able to edit insert effects on this channel.

Unload Instruments When Frozen

Activate this option to unload the instrument after freezing. This makes the RAM available again.

RELATED LINKS

[Freezing Multiple Tracks](#) on page 145

[Freezing Instruments](#) on page 520

[Unfreeze Channel Options Dialog for Instruments](#) on page 522

Unfreeze Channel Options Dialog for Instruments

The **Unfreeze Channel Options** allows you to specify exactly what should happen if you unfreeze an instrument track.

To open the **Unfreeze Channel Options** dialog, select a frozen instrument track, and do one of the following:

- In the top **Inspector** section, click **Freeze Instrument Channel**.
- Select **Edit > Freeze/Unfreeze > Selected Tracks**.
- Right-click the selected track, and from the context menu, select **Freeze/Unfreeze Selected Tracks**.

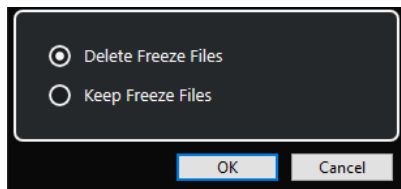

Delete Freeze Files

Deletes the freeze files.

Keep Freeze Files

Keeps the freeze files in the **Freeze** folder that can be found in the following location:

- Windows: within the **Project** folder
- macOS: **User/Documents**

RELATED LINKS

[Freeze Channel Options Dialog for Instruments](#) on page 521

[Freezing Instruments](#) on page 520

[Freezing Multiple Tracks](#) on page 145

Latency

Latency stands for the time it takes for the instrument to produce a sound after you press a key on your MIDI controller. It can be an issue when using VST instruments in real time. Latency depends on your audio hardware and its ASIO driver.

In the **Studio Setup** dialog (**Audio System** page), the input and output latency values should ideally be a few milliseconds.

If the latency is too high to allow comfortable real time VST instrument playback from a keyboard, you can use another MIDI sound source for live playback and recording, and switch to the VST instrument for playback.

RELATED LINKS

[Selecting an Audio Driver](#) on page 15

Delay Compensation

During playback, Cubase automatically compensates any delay inherent in the VST plug-ins you use.

You can specify a **Delay Compensation Threshold** in the **Preferences** dialog (**VST** page), so that only plug-ins with a delay higher than this threshold setting are affected.

Constrain Delay Compensation

To prevent additional latency when you play a VST instrument in real time or record live audio, you can activate **Constrain Delay Compensation**. This minimizes the latency effects of the delay compensation while maintaining the sound of the mix as well as possible.

Constrain Delay Compensation is available on the **Project** window toolbar and in the **Transport** zone. You can also find it as a menu item in the **MixConsole** on the **Functions Menu**.

If you activate **Constrain Delay Compensation** for instrument channels, record-enabled audio track channels, group channels, and output channels, the following happens:

- For VST 3 plug-ins that feature a **Live** button, and for third-party VST 3 plug-ins that feature a low latency mode, activating **Constrain Delay Compensation** activates the **Live** button or the low latency mode for that particular plug-in. For details about the included plug-ins that feature a **Live** button, see the separate document **Plug-in Reference**.
- For VST plug-ins that have no low latency mode, activating **Constrain Delay Compensation** turns off that plug-in.

NOTE

VST plug-ins that are activated for FX channels are disregarded.

After recording or using a VST instrument, deactivate **Constrain Delay Compensation** again, in order to restore full delay compensation.

RELATED LINKS

[Project Window Toolbar](#) on page 36

Import and Export Options

Importing MIDI Loops

You can import MIDI loops (file extension `.midiloop`) in Cubase. These files contain MIDI part information (MIDI notes, controllers, etc.) and all the settings that are saved in instrument track presets. This way, you can reuse instrument patterns in other projects or applications, for example.

PROCEDURE

1. Select **Media > MediaBay**.
2. Optional: On the toolbar, open the **Select Media Types** menu, and activate **MIDI Loops** and **Plug-in Presets**.

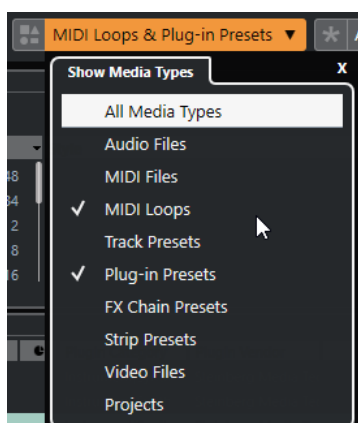

3. In the **Results** list, select a MIDI loop and drag it to an empty section in the **Project** window.

RESULT

An instrument track is created, and the instrument part is inserted at the position where you dragged the file. The **Inspector** reflects all settings that are saved in the MIDI loop, for example, the VST instrument that was used, applied insert effects, track parameters, etc.

NOTE

You can also drag MIDI loops onto existing instrument or MIDI tracks. However, this only imports the part information. This means that this part only contains the MIDI data (notes, controllers) saved in the MIDI loop, but no **Inspector** settings or instrument parameters.

RELATED LINKS

[Presets for Instruments](#) on page 518

[Filtering According to Media Type](#) on page 484

Exporting MIDI Loops

You can export MIDI loops to save a MIDI part, including its instrument and effect settings. This allows you to reproduce patterns that you created, without having to search for the correct sound, style, or effect. MIDI loops have the file extension `.midiloop`.

PROCEDURE

1. Select an instrument part.

2. Select **File > Export > MIDI Loop**.
 3. In the **Save MIDI Loop** dialog, enter a name for the MIDI loop.
 4. Optional: To save attributes for the MIDI loop, click the button below the **New MIDI Loop** section at the bottom left.
The **Attribute Inspector** section opens, allowing you to define attributes for your MIDI loop.
 5. Click **OK**.
-

RESULT

MIDI loop files are saved in the following folder:

Windows: \Users\\AppData\Roaming\Steinberg\MIDI Loops

macOS: /Users/<user name>/Library/Application Support/Steinberg/MIDI Loops/

The default folder cannot be changed. However, you can create subfolders within this folder to organize your MIDI loops. To create a subfolder, click **New Folder** in the **Save MIDI Loop** dialog.

Exporting Instrument Tracks as MIDI Files

You can export instrument tracks as standard MIDI files.

PROCEDURE

1. Select an instrument track.
 2. Select **File > Export > MIDI File**.
 3. In the **Export MIDI File** dialog, select a location, and enter a name for the MIDI file.
 4. Click **Save**.
 5. In the **Export Options** dialog, make your changes.
If you activate **Export Inspector Volume/Pan**, volume and pan information of the VST instrument is converted and written into the MIDI file as controller data.
 6. Click **OK**.
-

RESULT

The instrument track is exported as a standard MIDI file. As there is no MIDI patch information in an instrument track, this information is missing in the resulting MIDI file.

RELATED LINKS

[Exporting MIDI Tracks as Standard MIDI Files](#) on page 137

Side-Chaining for VST Instruments

You can send audio into VST 3 instruments that support side-chaining. Side-chaining allows you to use the output of one track to control the action of an instrument on another track.

Depending on the instrument, activating side-chaining allows you to:

- Use the instrument as an effect plug-in on audio events.
- Use the side-chain signal as a modulation source.
- Apply ducking to the instrument, that is, reduce the volume of the instrument track when a signal is present on the audio track.

You can route the audio signal to the side-chain input of an instrument in different ways:

- To process the audio signal completely through the instrument, route the output of the audio track to the side-chain input of an instrument.
- To use both the clean audio signal and the signal processed by the instrument, route a send to the instrument side-chain.

NOTE

To listen to the audio played through the instrument, trigger a note, either by playing MIDI events or by playing notes on your external MIDI keyboard.

RELATED LINKS

[Using Instruments as Effects on Audio Tracks](#) on page 526

Using Instruments as Effects on Audio Tracks

You can use instruments that support side-chaining to modify the audio on audio tracks. The following example shows you how to apply the parameters in Retrologue to a drum loop.

PREREQUISITE

You have a drum loop on an audio track. You have created an instrument track with Retrologue loaded.

PROCEDURE

1. On the Retrologue control panel, click **Activate/Deactivate Side-Chaining**.
2. On the control panel, click **Set up Side-Chain Routing**.
3. Click **Add Side-Chain Source**, and select the audio track from the selector.
4. In the **Project** window, select the audio track.
5. In the **Inspector** for the audio track, open the **Output Routing** pop-up menu and select Retrologue as a side-chain input.
6. On the Retrologue panel in the **Oscillator Mix** section, adjust the **Input Level** control.
7. Optional: Deactivate oscillators **OSC 1**, **OSC 2**, and **OSC 3**.
8. Do one of the following:
 - On the instrument track, create a MIDI event, set up a cycle with the left and right locators, and activate cycle mode.
 - Play notes on your MIDI keyboard.

NOTE

For this to work, your MIDI keyboard must be installed and set up.

RESULT

When a note is played, the drum loop is played back through Retrologue.

AFTER COMPLETING THIS TASK

Use Retrologue to modify the sound of your drum loop. For example, you can do the following:

- Use the filter and distortion settings on the **Synth** page.
- Modulate the input signal. To do this, select **Modulation Matrix > Destination > Oscillator > Audio Input**.

- Set up a rhythmical modulation on the **Arp** page.
- Use the effects on the **FX** page, for example the **Resonator**.

NOTE

For detailed information about Retrologue and its parameters, see the separate document **Retrologue**.

Installing and Managing VST Plug-ins

Cubase supports the VST 2 and VST 3 plug-in standards. You can install effects and instruments that comply with these formats.

NOTE

Cubase supports 64-bit plug-ins only.

A plug-in is a piece of software that adds a specific functionality to Cubase. The audio effects and instruments that are used in Cubase are VST plug-ins.

VST effect or VST instrument plug-ins normally have their own installation application. Read the documentation or readme files before installing new plug-ins.

When you scan for newly installed plug-ins or relaunch Cubase, the new plug-ins are shown on the VST effect or VST instrument selectors, respectively.

Cubase comes with a number of effect plug-ins included. These effects and their parameters are described in the separate document **Plug-in Reference**.

Plug-ins and Collections

The **VST Plug-in Manager** shows the VST effects and VST instruments that are installed on your computer.

In Cubase, plug-ins are arranged in collections. Only one collection can be active at a time. The plug-ins contained in the active collection are displayed in the selectors, in various locations of the program.

When you launch Cubase, all plug-ins that are found are automatically placed in the **Default** collection. This is the collection of plug-ins that is active by default.

The **Default** collection is created each time you start Cubase or initiate a rescan.

You can, however, add your own VST effect or VST instrument collections. This is useful if you only want to see specific plug-ins that are used in a specific project, for example. When you activate this collection, all VST effects and VST instruments of this collection are shown in the selectors for VST effects or VST instruments.

NOTE

If an installed VST effect or a VST instrument cannot be loaded by Cubase, it is not shown on the **VST Effects** tab or the **VST Instruments** tab, and it is grayed out in any collection. In this case, verify that the plug-in is not copy-protected.

RELATED LINKS

[VST Plug-in Manager Window](#) on page 529

[Adding New Plug-in Collections](#) on page 531

VST Plug-in Manager Window

You can manage VST effects and VST instruments in the **VST Plug-in Manager** window.

- To open the **VST Plug-in Manager** window, select **Studio > VST Plug-in Manager**.

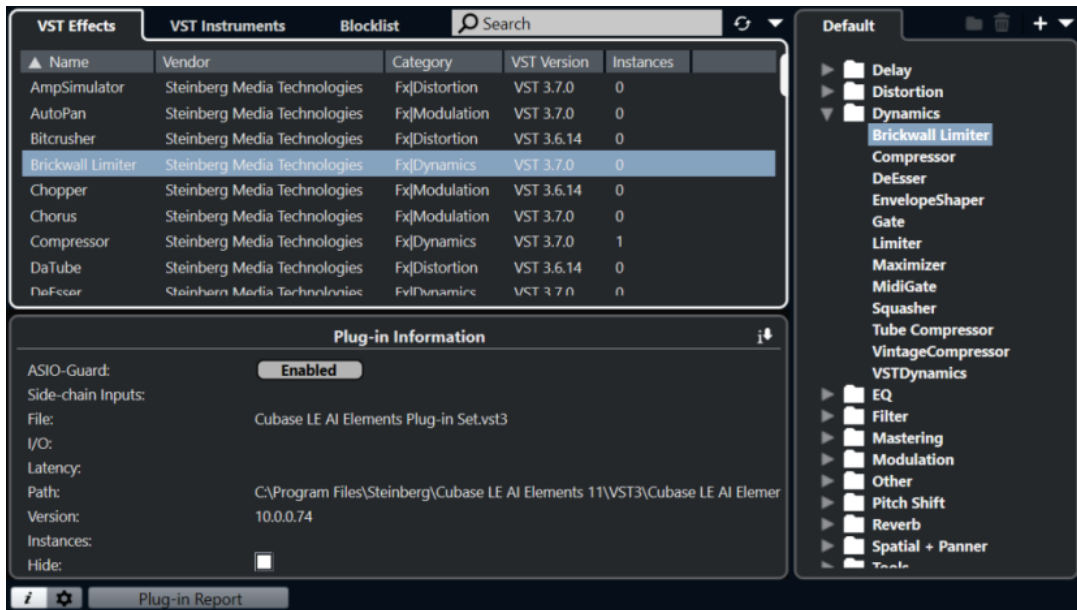

The **VST Plug-in Manager** is divided into the following sections:

VST Effects

Lists all VST effects that are loaded in Cubase. To sort the list by a specific attribute, click the corresponding column header.

VST Instruments

Lists all VST instruments that are loaded in Cubase. To sort the list by a specific attribute, click the corresponding column header.

Blocklist

Lists all VST effects and VST instruments that are installed on your system but not loaded in Cubase, because they might lead to stability problems or even cause the program to crash.

Toolbar

Shows tools and shortcuts for functions in the **VST Plug-in Manager**.

Active collection

Shows the active collection. The plug-ins of the active collection are shown in the selectors for VST effects and VST instruments.

Show VST Plug-in Information

Shows information about the selected plug-in.

VST 2 Plug-in Path Settings

Shows the path of the selected VST 2 plug-in.

Plug-in Report

Opens the File Explorer/macOS Finder that allows you to save a text file that contains information about your system as well as plug-in information. This is useful for troubleshooting, for example.

RELATED LINKS

- [Plug-ins and Collections](#) on page 528
- [Audio System Page](#) on page 16
- [VST Plug-in Manager Toolbar](#) on page 530
- [VST 2 Plug-in Path Settings](#) on page 531
- [Hiding Plug-ins](#) on page 532
- [Reactivating Plug-ins from the Blocklist](#) on page 533

VST Plug-in Manager Toolbar

Shows tools and shortcuts for functions in the **VST Plug-in Manager**.

- To open the **VST Plug-in Manager** window, select **Studio > VST Plug-in Manager**.

Search field



Allows you to search for specific plug-ins on the **VST Effects** tab or on the **VST Instruments** tab by typing in their name.

Rescan All

Rescans the plug-in list.

Display Options



Allows you to choose which plug-ins are shown:

- **Show All Plug-ins** displays all loaded plug-ins.
- **Hide Plug-ins That Are in Active Collection** hides all plug-ins that are part of the active collection.
- **Show Plug-ins That Support 64-Bit Float Processing** shows all VST 3 plug-ins that support 64-bit float processing.

New Folder



Creates a new folder in the current collection.

Delete



Deletes the selected item from the current collection.

New Collection



Creates a new collection.

- **Empty** creates a new, empty collection.
- **Add All Plug-ins** creates a new collection that contains all VST effects or VST instruments, respectively.
- **Copy Current Collection** creates a new collection that contains the current collection.

Plug-in Collections and Options



- **Default** activates the default collection.
- **New Collection** allows you to create a new collection.
- **Remove Unavailable Plug-ins from All Collections** removes all plug-ins that are not available from all user-created collections.

- **Sort By Category** sorts the collection by category.

NOTE

This option is available for the **Default** collection only.

- **Sort By Vendor** sorts the collection by vendor.

NOTE

This option is available for the **Default** collection only.

VST 2 Plug-in Path Settings

Displays information about the selected VST 2 plug-in path.

- To open the **VST 2 Plug-in Path Settings**, select **Studio > VST Plug-in Manager**, and click **VST 2 Plug-in Path Settings**.

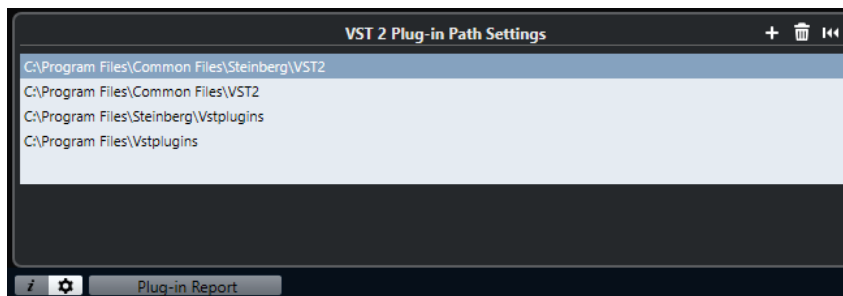

VST 2 Plug-in path list

Shows all VST 2 plug-in paths.

Add Path

Allows you to add a new VST 2 plug-in path.

Delete Path

Deletes the selected VST 2 plug-in path.

Reset

Resets the list to default.

Adding New Plug-in Collections

You can add new collections of VST effects or VST instruments.

PREREQUISITE

A number of effect plug-ins is installed on your computer. These plug-ins are listed in the **VST Plug-in Manager** on the **VST Effects** tab and the **VST Instruments** tab.

PROCEDURE

1. In the **VST Plug-in Manager** toolbar, click **New Collection**, and select an option.

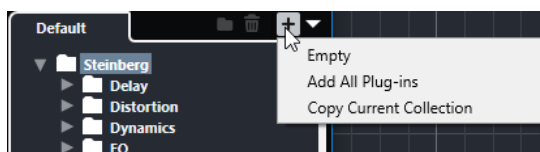

2. In the **New Collection** dialog, enter a name for the new collection, and click **OK**.
 3. Optional: Click **New Folder**.
You can then move your plug-ins into these folders to organize them by categories, for example.
 4. Enter a name for the new folder, and click **OK**.
 5. From the **VST Effects** tab or the **VST Instruments** tab, select the plug-ins that you want to add to the collection, and drag them into the new collection.
If you created folders, you can drag the plug-ins into them.
-

RESULT

The new collection is saved. If you select it, its plug-ins are shown in the plug-in selectors.

AFTER COMPLETING THIS TASK

To remove a plug-in from a collection, select it, and click **Remove**.

RELATED LINKS

[Plug-ins and Collections](#) on page 528

[VST Plug-in Manager Window](#) on page 529

Hiding Plug-ins

You can hide plug-ins from all collections. This is useful if you have installed plug-ins on your computer that you do not want to use in Cubase.

PROCEDURE

1. Select **Studio > VST Plug-in Manager**.
2. On the **VST Effects** tab or on the **VST Instruments** tab, select the plug-ins that you want to hide from view.
3. Click **Show VST Plug-in Information** to show information about the selected plug-in.
4. Activate **Hide**.

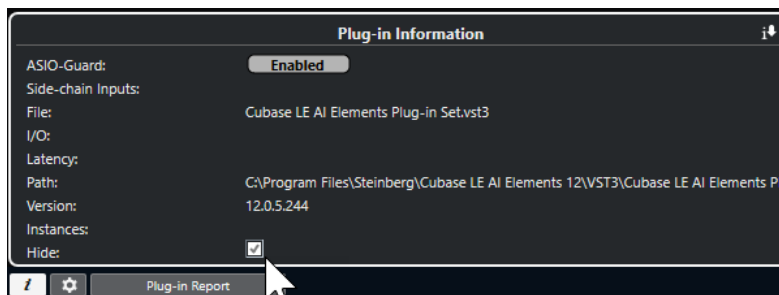

RESULT

The selected plug-in is hidden from view.

RELATED LINKS

[ASIO-Guard](#) on page 825

Reactivating Plug-ins from the Blocklist

You can reactivate 64-bit plug-ins that are on the blocklist.

PROCEDURE

1. On the **Blocklist** tab, select the plug-ins that you want to reactivate.

NOTE

You cannot reactivate 32-bit plug-ins because they are not supported.

2. Click **Reactivate**.
-

RESULT

Cubase rescans the plug-in and removes it from the blocklist.

AFTER COMPLETING THIS TASK

If you want to move the plug-in back to the blocklist, click **Rescan All** in the **VST 2 Plug-in Path Settings**, and restart Cubase.

RELATED LINKS

[VST Plug-in Manager Window](#) on page 529

Track Quick Controls

Cubase allows you to set up 8 different track parameters or settings as **Track Quick Controls** for quick access.

Track Quick Controls are available for the following track types:

- Audio
- MIDI
- Instrument
- Sampler
- FX Channel
- Group Channel

For instrument tracks and for MIDI tracks with a VST instrument assigned to on creation, that is, that you created by loading a rack instrument, **Track Quick Controls** are automatically assigned to the **Quick Controls** of the VST instrument.

For sampler tracks, **Track Quick Controls** are automatically assigned to the sound parameters of **Sampler Control**.

NOTE

You can change the default assignment by assigning different track parameters or by loading a preset.

You can assign parameters to **Quick Controls** in the **Inspector**.

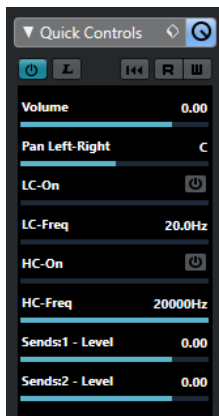

Quick Controls section in the **Inspector**

Quick Controls assignments are saved with the project.

You can assign **Track Quick Controls** to an external remote control device. For this to work, you must connect **Track Quick Controls** with your remote controller.

You can automate parameter settings in the **Quick Controls** section using the **Read/Write** buttons (**R** and **W**).

RELATED LINKS

- [Track Presets](#) on page 148
- [Automation](#) on page 500
- [Channel Racks Selector](#) on page 289

Parameter Assignment

You can assign track, effect, and instrument parameters to **Quick Controls**.

For the parameter assignment, you can use the **Inspector**. You can assign parameters manually, use the **QC Learn Mode**, or load an assignment preset.

RELATED LINKS

- [Assigning Track Parameters to Quick Controls](#) on page 535
- [Assigning Effect Parameters to Quick Controls](#) on page 536
- [Using QC Learn Mode](#) on page 536
- [Setting Instrument Parameter Assignments to Default](#) on page 536
- [Removing Parameter Assignments](#) on page 537
- [Loading Track Quick Control Assignments as Presets](#) on page 537

Assigning Track Parameters to Quick Controls

You can assign track parameters manually.

NOTE

For instrument tracks and MIDI tracks with a VST instrument assigned to on creation, the main parameters of the instrument are automatically assigned to the slots in the **Quick Controls** section of the **Inspector**.

PROCEDURE

1. In the **Inspector** for your track, open the **Quick Controls** section.
2. Click the first slot to open a selector that lists all parameters for the track.
3. Select the parameter that you want to assign to the first **Quick Control**.

The parameter name and its value are displayed in the slot. You can change the value by dragging the slider.

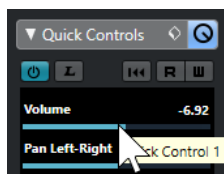

4. Repeat these steps for all slots for which you want to assign track parameters.

RESULT

You can now control the track parameters via the **Quick Controls** section in the **Inspector**.

AFTER COMPLETING THIS TASK

You can rename a **Quick Control** by double-clicking on the name and entering a new one. This is useful if a parameter name is very long, for example.

Assigning Effect Parameters to Quick Controls

You can assign effect parameters to **Quick Control** slots from within plug-in panels.

NOTE

This is available for VST 3 plug-ins that support this function only.

PROCEDURE

- In the effect plug-in panel, right-click the parameter.
 - Select **Add “x” to Quick Controls** (where x is the name of the parameter) to assign the parameter to the next empty slot.
 - Select **Add “x” to Quick Controls Slot** (where x is the name of the parameter), and select the slot from the submenu to assign the parameter to a specific slot.
-

RESULT

You can now control the effect parameters via the **Quick Controls** section in the **Inspector**.

Using QC Learn Mode

The **QC Learn Mode** allows you to assign a parameter by moving controls. This applies to all automatable controls.

PROCEDURE

1. In the **Inspector** for your track, open the **Quick Controls** section.
 2. Activate **QC Learn Mode**.
 3. Select the slot to which you want to assign a parameter.
 4. Move the control.
-

RESULT

The track parameter is assigned to the corresponding control.

RELATED LINKS

[Controlling Automatable Parameters](#) on page 538

Setting Instrument Parameter Assignments to Default

If you have changed the parameter assignment or if you manually routed a MIDI track to a VST instrument, you can retrieve the default assignments.

PROCEDURE

1. In the **Inspector** for the instrument or MIDI track, open the **Quick Controls** section.
 2. Click **Get Default QCs from Plug-in**.
-

RESULT

The instrument parameter assignments are set to default.

Removing Parameter Assignments

You can remove parameter assignments for individual **Quick Controls** or for all **Quick Controls** at the same time.

PROCEDURE

- Do one of the following:
 - To remove a parameter from a slot, click in the corresponding slot, and select **No parameter** from the pop-up menu.

NOTE

You can also double-click the parameter name, press **Delete** or **Backspace**, and confirm with **Return**.

-
- To remove the **Quick Control** assignments for all slots, click **Remove All QC Assignments**.

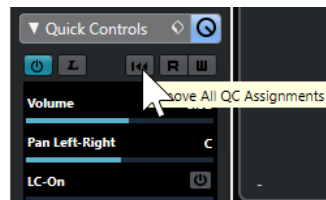

Saving Track Quick Control Assignments as Presets

You can save **Quick Control** assignments as track presets.

PREREQUISITE

You have assigned track parameters to **Quick Controls**.

PROCEDURE

1. In the **Inspector** for your track, open the **Quick Controls** section.
2. Click **Preset Management** .
3. Click **Save Preset**.
4. Enter a name in the **Type in Preset Name** dialog.
5. Click **OK**.

RESULT

The **Quick Control** assignment is saved as a preset.

RELATED LINKS

[Assigning Track Parameters to Quick Controls](#) on page 535

Loading Track Quick Control Assignments as Presets

You can load presets for **Quick Control** assignments.

PROCEDURE

1. In the **Inspector** for your track, open the **Quick Controls** section.

2. Click **Preset Management** .
 3. Select one of the presets from the upper list of the menu.
-

RESULT

The preset is loaded and allows you to access the channel parameters.

Controlling Automatable Parameters

You can use **Quick Controls** to control all automatable parameters. This allows you to control parameters on other tracks using **Quick Controls**.

IMPORTANT

Use this function with caution, as you might accidentally modify parameters on other tracks.

PROCEDURE

1. Create a new, empty audio track, and open the **Quick Controls** section.
2. Hold down **Ctrl/Cmd**, and click the first **Quick Control** slot.
The selector lists all automatable parameters.
3. Open the **VST Mixer** folder.
The selector lists all channels that are available in the **MixConsole** of your project.

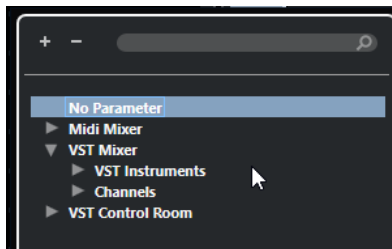

4. Assign a parameter of one particular channel to **Quick Control 1** and a different parameter of another channel to **Quick Control 2**.
-

RESULT

The **Quick Controls** section now allows you to control automatable parameters on different tracks.

IMPORTANT

You cannot save **Quick Control** assignments for automatable parameters on different tracks as track presets.

Showing Automated Quick Control Assignments

You can show all **Quick Control** assignments that have been automated for one track.

PROCEDURE

1. Click the track for which you want to show automated **Quick Control** assignments.
2. In the **Inspector** for your track, open the **Quick Controls** section.

3. Click **Preset Management** .
 4. Select **Show Automated QC Assignments**.
-

RESULT

The automation tracks of the automated **Quick Control** parameters open for the selected track.

NOTE

- If **Volume** is assigned as a **Quick Control** parameter, it is always shown as automated, regardless of whether it is automated or not.
-

MIDI Remote

MIDI Remote allows you to integrate and use third party MIDI controllers in Cubase.

The **MIDI Remote** concept is based on dedicated scripts for specific MIDI controllers. These scripts establish a connection between a specific MIDI controller and Cubase, and include factory mappings to parameters.

The layout and functions of MIDI controllers with a script can be shown on the **MIDI Remote** tab in the lower zone of the **Project** window. If a script is available for your MIDI controller, all you have to do is plug in the controller, and you can start playing.

Cubase includes several MIDI controller scripts. If no script is yet available for your MIDI controller, we encourage you to create one.

The **MIDI Controller Surface Editor** provides you with an easy way to create your own scripts. It allows you to create a surface that describes the layout and the order of the control elements on your MIDI controller.

As an alternative for those who have some programming skills and want to dive deeper into scripting, we have created a **MIDI Remote API** that allows you to develop a script for your dedicated MIDI controller.

RELATED LINKS

[Using Supported MIDI Controllers with MIDI Remote](#) on page 545

[MIDI Remote Tab](#) on page 540

[MIDI Remote Info Line](#) on page 541

[Generic Remote Page \(Legacy\)](#) on page 583

[MIDI Remote API](#) on page 571

[MIDI Remote Mapping Assistant](#) on page 556

[Setting up Focus Quick Controls in the MIDI Remote Mapping Assistant](#) on page 563

MIDI Remote Tab

The **MIDI Remote** tab in the lower zone of the **Project** window allows you to load scripts for MIDI controllers. It shows the layout of your controller and its control mappings to Cubase parameters. All operations that you perform on the connected MIDI controller are displayed on the **MIDI Remote** tab.

NOTE

The purpose of the surfaces that are shown on the **MIDI Remote** tab is to map Cubase functions to your connected MIDI controller. After mapping, you can control those Cubase functions via your MIDI controller.

- To open the **MIDI Remote** tab, click the **MIDI Remote** tab in the lower zone of the **Project** window.



The **MIDI Remote** tab in the lower zone of the **Project** window

The following elements are available:

1 Info line

The **MIDI Remote** info line.

2 MIDI controller surface

Shows which Cubase functions are mapped to which controls on your MIDI controller. You can use multiple MIDI controllers simultaneously. All available supported MIDI controllers are shown in the overview.

RELATED LINKS

[MIDI Remote Info Line](#) on page 541

[MIDI Remote Mapping Assistant](#) on page 556

[Opening MIDI Remote in the Lower Zone](#) on page 57

MIDI Remote Info Line

The **MIDI Remote** info line displays information about the current MIDI controller and the recently used controls.

- To show or hide the info line elements, right-click the info line, and activate or deactivate the elements.

MIDI Controllers Overview

Go to **MIDI Controllers Overview**



Click this to display an overview of all connected and supported MIDI controllers. To go back to the surface of a specific controller, click it.

MIDI Controller

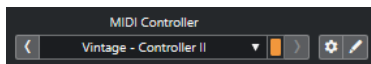

Go to Previous Controller



If you have connected more than one MIDI controller, this allows you to go to the previous MIDI controller.

MIDI Controller

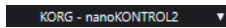

Shows the name of the MIDI controller that is currently shown on the **MIDI Remote** tab in the lower zone of the **Project** window.

Incoming MIDI Data from Other Controller



If you have connected more than one MIDI controller, this shows the activity of the controller that is currently not selected.

Go to Next Controller



If you have connected more than one MIDI controller, this allows you to go to the next MIDI controller.

Open MIDI Remote Manager



Opens the **MIDI Remote Manager** that shows information about the connected MIDI controllers and the installed scripts.

Edit MIDI Controller Surface



NOTE

This is only available if you created the script for the selected MIDI controller with the **MIDI Controller Surface Editor**.

Opens the **MIDI Controller Surface Editor** that allows you to create and edit a surface that corresponds to the layout of your MIDI controller. You can use this surface to assign Cubase functions to controls on your MIDI controller.

Mapping Page

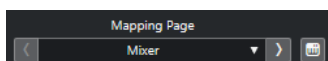

Go to Previous Mapping Page



Activates the previous mapping page for the current controller.

Mapping Page



Allows you to activate a mapping page for the current controller.

Go to Next Mapping Page



Activates the next mapping page for the current controller.

Open Mapping Assistant



Opens the **MIDI Remote Mapping Assistant**.

Quick Control Focus



Quick Control Focus

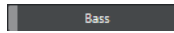

Shows the name of the item that has the quick control focus, that is, either the track name or the plug-in name.

Focus Quick Controls Lock State: Locked/Unlocked



Allows you to lock the focus of the quick controls.

Focus Quick Controls Indicator



Displays which quick controls have the focus.

Quick Control Focus Setup



Opens the **Quick Control Focus Setup** panel.

Zoom Controls

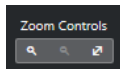

Zoom In



Zooms in on the current MIDI controller surface in the lower zone.

Zoom Out



Zooms out of the current MIDI controller surface in the lower zone.

Zoom Full/Zoom to Fit



Zooms out so that the whole MIDI controller is visible.

NOTE

You can also press **G** to zoom in and **H** to zoom out of the current MIDI controller surface.

Last Touched Control

Last Touched Control

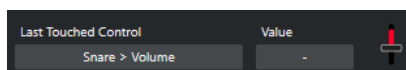

Shows the last hardware control that you touched, the host parameter that the control is assigned to, and its last value.

Last Hovered Control

Last Hovered Control

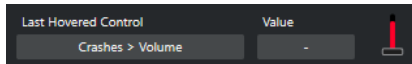

Shows the control that you last hovered with the mouse on the controller surface, the host parameter that the control is assigned to, and its last value.

Scripting Tools

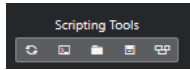

Reload Scripts



Allows you to reload the scripts.

Open MIDI Remote Script Console



Opens the **MIDI Remote Script Console** with script messages.

Open Script Folder



Opens the location of the scripts folder.

Open MIDI Remote API - Programmer's Guide



Opens the **MIDI Remote API** programmer's guide, which allows you to write your own scripts for your MIDI controller.

Show Surface Element Rectangles



Shows the size and position of surface elements while developing scripts.

Open in Separate Window

Open in Separate Window



Opens the **MIDI Remote** tab in a separate window.

Set up Info Line

Set up Info Line



Opens a pop-up menu where you can set up which info line items to display.

RELATED LINKS

[MIDI Remote API](#) on page 571

[MIDI Remote Manager Window](#) on page 564

[Quick Control Focus Setup Panel](#) on page 563

Using Supported MIDI Controllers with MIDI Remote

The layout and the functions of supported MIDI controllers, that is, controllers with a script, are shown on the **MIDI Remote** tab in the lower zone of the **Project** window.

PREREQUISITE

If you have previously used an earlier version of Cubase, and if you already set up your MIDI controller using **Generic Remote**, **Track Quick Controls** or **VST Quick Controls**, open the **Studio Setup** dialog, open the **MIDI Port Setup** page, and set the corresponding MIDI ports to **Not Connected**. This ensures that no double mappings occur when the **MIDI Remote** functionality automatically detects those MIDI controllers on connection.

NOTE

Some of the supported MIDI controllers require additional settings to work with Cubase. To open a document with the necessary information, open the **MIDI Remote** tab, and click **Open Setup Information** ⓘ in the upper right corner of the MIDI controller surface.

PROCEDURE

1. Connect your MIDI controller to your computer.
 2. In the lower zone of the **Project** window, click **MIDI Remote**.
 3. Optional: If you have connected several supported MIDI controllers, click the controller surface that you want to use in the MIDI controllers overview.
-

RESULT

In the **MIDI Remote** tab, the layout and the functions of the connected MIDI controller are displayed. Here, you can also see which Cubase functions are mapped to controls on your MIDI controller.

RELATED LINKS

- [MIDI Port Setup Page](#) on page 24
- [MIDI Remote](#) on page 540
- [VST Quick Controls](#) on page 583
- [Track Quick Controls](#) on page 581

Other MIDI Controllers and MIDI Remote

You can also use MIDI controllers that do not have a ready-to-use script. For this purpose, you must create a custom controller surface.

Cubase offers an easy way to create your own controller surface. It includes the following steps:

- Adding a MIDI controller surface in the **Add MIDI Controller Surface** dialog.
- Editing the MIDI controller surface in the **MIDI Controller Surface Editor**.
- Mapping the controls to Cubase functions in the **MIDI Remote Mapping Assistant**.

You can also create controller surfaces by writing a script with the **MIDI Remote API**.

RELATED LINKS

- [Adding MIDI Controller Surfaces](#) on page 546
- [Editing MIDI Controller Surfaces](#) on page 546
- [MIDI Controller Surface Editor](#) on page 551

[Mapping Controls on MIDI Controllers to Cubase Functions](#) on page 548
[MIDI Remote Mapping Assistant](#) on page 556
[MIDI Remote API](#) on page 571

Adding MIDI Controller Surfaces

If you want to use a MIDI controller that is not yet supported and, for this reason, has no script, you must first add a new MIDI controller surface for it.

PREREQUISITE

If you have previously used an earlier version of Cubase, and if you already set up your MIDI controller using **Generic Remote**, **Track Quick Controls** or **VST Quick Controls**, open the **Studio Setup** dialog, open the **MIDI Port Setup** page, and set the corresponding MIDI ports to **Not Connected**. This ensures that no double mappings occur when the **MIDI Remote** functionality automatically detects those MIDI controllers on connection.

PROCEDURE

1. On the **MIDI Remote** info line, click **Go to MIDI Controllers Overview**.
2. In the overview, click **Add MIDI Controller Surface**.



3. In the **Add MIDI Controller Surface** dialog, enter the required information, and select the MIDI ports of your MIDI controller.

NOTE

- Special characters are not allowed in that dialog.
- Make sure that you select the correct MIDI ports of your MIDI controller. Otherwise, your surface script will not work as expected.

4. Click **Create MIDI Controller Surface**.
-

RESULT

The **MIDI Controller Surface Editor** opens in the lower zone of the **Project** window. Here, you can edit the controller surface.

RELATED LINKS

[Add MIDI Controller Surface Dialog](#) on page 550
[Editing MIDI Controller Surfaces](#) on page 546
[MIDI Controller Surface Editor](#) on page 551
[MIDI Remote Mapping Assistant](#) on page 556
[Deleting Unused MIDI Controller Scripts](#) on page 569

Editing MIDI Controller Surfaces

You can edit MIDI controller surfaces via the **MIDI Controller Surface Editor** in the lower zone of the **Project** window.

PREREQUISITE

You have added a new surface using the **Add MIDI Controller Surface** dialog and clicked **Create MIDI Controller Surface** to open the **MIDI Controller Surface Editor**.

PROCEDURE

1. In the **MIDI Controller Surface Editor**, follow the instructions on the message board to create a surface that corresponds to the layout of your MIDI controller.
When you touch the hardware controls of your MIDI controller, Cubase detects the incoming MIDI messages and associates them with a control in the **MIDI Controller Surface Editor**.
 2. When you are done, do one of the following:
 - To map the controls on your MIDI controller to Cubase functions, click **Open Mapping Assistant** on the **MIDI Controller Surface Editor** info line.
 - To close the **MIDI Controller Surface Editor**, click **Go to MIDI Controller Surface**.
-

RESULT

Your controller surface is added to the **MIDI Remote** tab.

RELATED LINKS

[Adding MIDI Controller Surfaces](#) on page 546

[MIDI Controller Surface Editor](#) on page 551

[MIDI Remote Tab](#) on page 540

Importing MIDI Controller Surface Scripts

You can import MIDI controller surface scripts from other users.

PREREQUISITE

Connect the controller that corresponds to the MIDI controller script that you want to import.

PROCEDURE

1. Do one of the following:
 - Select **Studio > MIDI Remote Manager** to open the **MIDI Remote Manager**.
 - Click **Add MIDI Controller Surface** on the **MIDI Remote** tab to open the **Add MIDI Controller Surface** dialog.
2. On the info line, click **Import Script**.
3. In the file dialog that opens, locate and select a **.midiremote** file, and click **Open**.
.midiremote files contain script files that have the file extension **.js** or **.json**, **.pdf** files with setup information, **.sysex** files, and mappings.

NOTE

Always use the **Import Script** and **Export Script** functions to exchange scripts with other users, instead of just copying **.js** or **.json** files. Otherwise, the additional files and settings are not included.

RESULT

The MIDI controller surface for the imported script opens in the lower zone of the **Project** window.

If the corresponding MIDI controller is not connected, a warning message is shown.

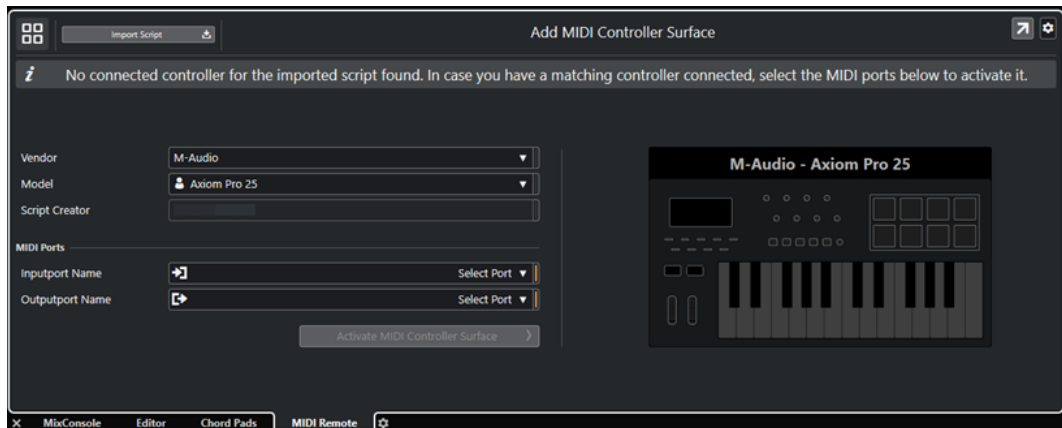

RELATED LINKS

[Add MIDI Controller Surface Dialog](#) on page 550

[MIDI Remote Manager Window](#) on page 564

[MIDI Controller Settings Pane](#) on page 556



Mapping Controls on MIDI Controllers to Cubase Functions

You can map controls on your MIDI controller to Cubase functions.

PREREQUISITE

You have connected a MIDI controller to your computer, and its controller surface is shown on the **MIDI Remote** tab, in the lower zone of the **Project** window.

PROCEDURE

1. Do one of the following:
 - On the info line of the **MIDI Controller Surface Editor**, click **Open Mapping Assistant** .
 - On the info line of the **MIDI Remote** tab, click **Open Mapping Assistant** .
 - On the toolbar of the **Project** window, click **Open MIDI Remote Mapping Assistant** .
2. Do one of the following to select a control on your MIDI controller:
 - Touch the control on your MIDI controller.
 - Click the control in the controller surface of the **MIDI Remote Mapping Assistant**.The name of the control is shown in the **Mapping Assistant**.
3. Do one of the following to select a Cubase function:
 - Select it from the **Functions Browser**.

NOTE

If the **Functions Browser** is not shown in the **MIDI Remote Mapping Assistant**, activate **Show/Hide Functions Browser**.

- Right-click a function in Cubase, and select **Pick for MIDI Remote Mapping**.
- The name of the function is shown in the
- Mapping Assistant**
- .
4. Click **Apply Mapping**.
 5. Repeat the steps above to map more Cubase functions to hardware controls.
-

RESULT

The hardware controls on your controller are now mapped to Cubase functions.

TIP

To quickly apply mappings, you can also try one of the following:

- Select a control on your MIDI controller so that it is shown in the **Mapping Assistant**, and double-click a Cubase function in the **Functions Browser** to map it.
- Select a Cubase function so that it is shown in the **Mapping Assistant**, and double-click a control in the controller surface of the **MIDI Remote Mapping Assistant** to map it.

TIP

In the **Mappings** section of the **MIDI Remote Mapping Assistant**, you can view and edit mapping details.

RELATED LINKS

[MIDI Remote Mapping Assistant](#) on page 556

[Mappings](#) on page 559

Making Changes on MIDI Controller Surfaces

You can make changes on controller surfaces that you created in the **MIDI Controller Surface Editor**.

PREREQUISITE

You have created a controller surface in the **MIDI Controller Surface Editor**.

NOTE

Controller surfaces that you created with a **MIDI Remote API** script, and controller surfaces from factory scripts cannot be edited.

PROCEDURE

1. On the **MIDI Remote** info line, open the **MIDI Controller** pop-up menu, and select the controller surface that you want to edit.

NOTE

Edit MIDI Controller Surface is only available for controller surfaces that you created in the **MIDI Controller Surface Editor**.

2. On the info line, click **Edit MIDI Controller Surface**.

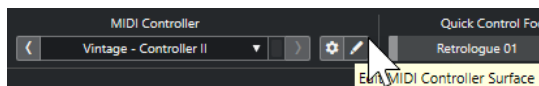

RESULT

In the lower zone of the **Project** window, the **MIDI Controller Surface Editor** opens, where you can make changes to your controller surface.

RELATED LINKS

[MIDI Controller Surface Editor](#) on page 551

[Editing MIDI Controller Surfaces](#) on page 546

Add MIDI Controller Surface Dialog

The **Add MIDI Controller Surface** dialog allows you to add a surface that corresponds to the layout of your MIDI controller.

- To open the **Add MIDI Controller Surface** dialog, click **Add MIDI Controller Surface** on the **MIDI Remote** tab.



NOTE

If the **MIDI Remote** tab shows a controller surface, click **Go to MIDI Controllers Overview** on the **MIDI Remote** info line, then click **Add MIDI Controller Surface**.

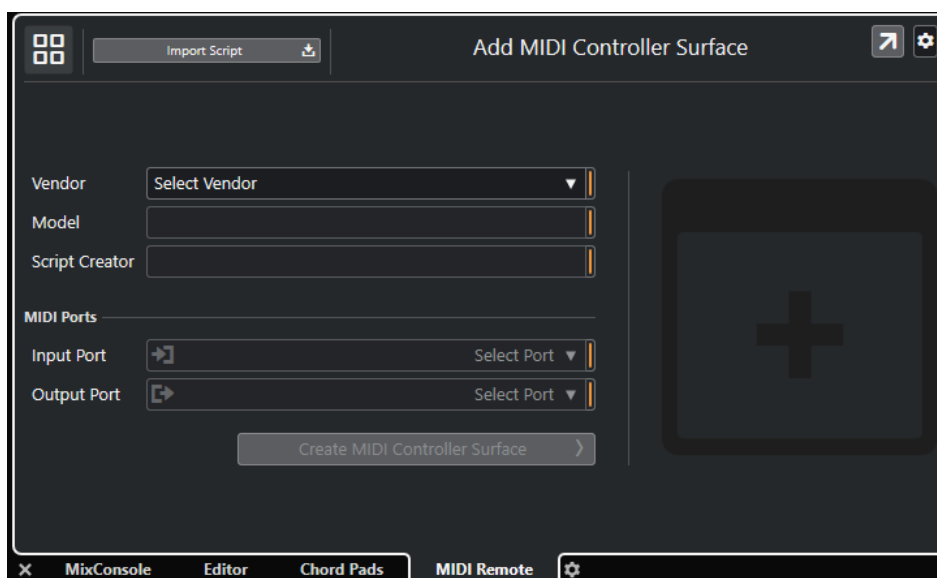

Go to MIDI Controllers Overview

Cancels the operation and returns to the **MIDI Controllers Overview**.

Import Script

Allows you to import MIDI controller scripts.

Vendor

Opens a pop-up menu, where you can select the vendor of the connected MIDI controller from a list.

If the vendor of your MIDI controller is not listed, scroll to the end of the list, and select **Add Vendor** to enter the information manually.

Model

Allows you to enter information about the model of the connected MIDI controller.

Script Creator

Allows you to enter information about the script creator of the connected MIDI controller.

NOTE

Special characters are not allowed.

Input Port

Allows you to select the MIDI input port of your MIDI controller.

NOTE

Make sure that you select the MIDI port of your MIDI controller. Otherwise, your surface script does not work as expected.

Output Port

Allows you to select the MIDI output port of your MIDI controller.

NOTE

Make sure that you select the MIDI port of your MIDI controller. Otherwise, your surface script does not work as expected.

Create MIDI Controller Surface

Adds the surface to the **MIDI Controllers Overview** and opens the **MIDI Controller Surface Editor**. Here, you can create and edit a surface that allows you to assign Cubase functions to controls on your MIDI controller.

RELATED LINKS

[MIDI Remote Page](#) on page 25

[Importing MIDI Controller Surface Scripts](#) on page 547

MIDI Controller Surface Editor

The **MIDI Controller Surface Editor** allows you to create a surface that corresponds to the layout of your MIDI controller. You can then use this surface to assign Cubase functions to controls on your MIDI controller.

- To open the **MIDI Controller Surface Editor**, click **Go to MIDI Controllers Overview** on the **MIDI Remote** info line. In the overview, click **Add MIDI Controller Surface**. In the **Add MIDI Controller Surface** dialog, enter information about **Vendor**, **Model**, **Script Creator**, define the **MIDI Ports**, and click **Create MIDI Controller Surface**.

NOTE

If you already created a script for the selected MIDI controller using the **MIDI Controller Surface Editor**, you can also click **Edit MIDI Controller Surface** on the MIDI Remote info line to reopen the editor and make some changes.

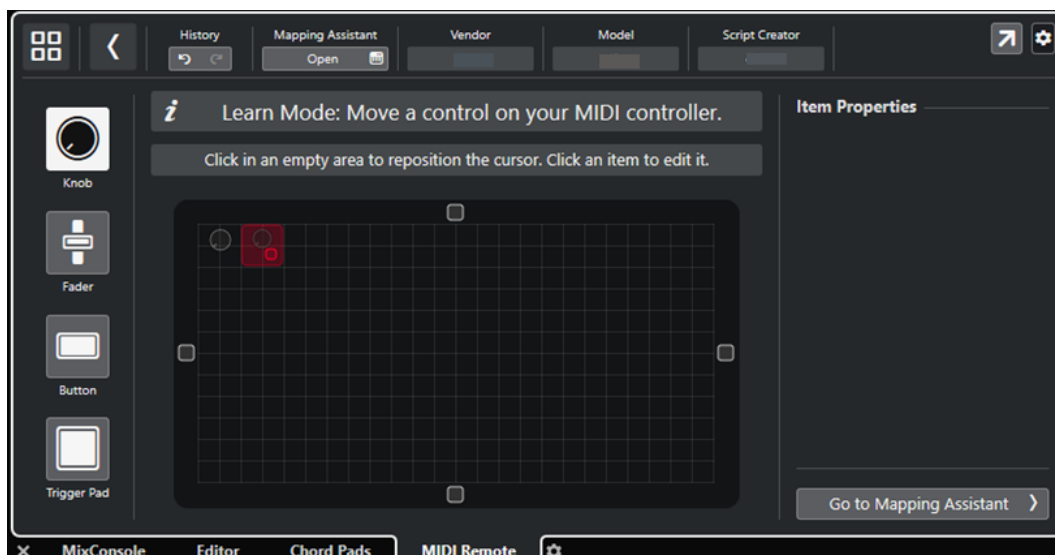

Info line

Contains buttons for **Undo**, **Redo**, and **Open Mapping Assistant**. It also shows the information that you entered when you added the MIDI controller surface.

Message board

Shows if you are in **Learn Mode** or in **Edit Mode** and provides information about the steps that you can perform.

Control types

Allows you to select the type of control that you want to add. You can add knobs, horizontal or vertical faders, buttons, and trigger pads.

Surface display

Shows the added controls and allows you to edit them. The surface that you create allows you to later map controls of your MIDI controller to Cubase functions. The surface is added to the **MIDI Controllers Overview** on the **MIDI Remote** tab.

Item Properties

Shows the properties that are assigned to the selected control. The **Item Properties** are available in **Edit Mode**.

Go to Mapping Assistant

Closes the **MIDI Controller Surface Editor** and opens the **Mapping Assistant** that allows you to map controls of your MIDI controller to Cubase functions.

RELATED LINKS

- [Adding MIDI Controller Surfaces](#) on page 546
- [Editing MIDI Controller Surfaces](#) on page 546
- [MIDI Remote Tab](#) on page 540
- [MIDI Remote API](#) on page 571
- [Learn Mode and Edit Mode](#) on page 553
- [Add MIDI Controller Surface Dialog](#) on page 550
- [MIDI Remote Mapping Assistant](#) on page 556
- [Item Properties](#) on page 554

Learn Mode and Edit Mode

The different steps to take when creating a new surface for your MIDI controller in the **MIDI Controller Surface Editor** are divided into two modes: **Learn Mode** and **Edit Mode**.

Learn Mode

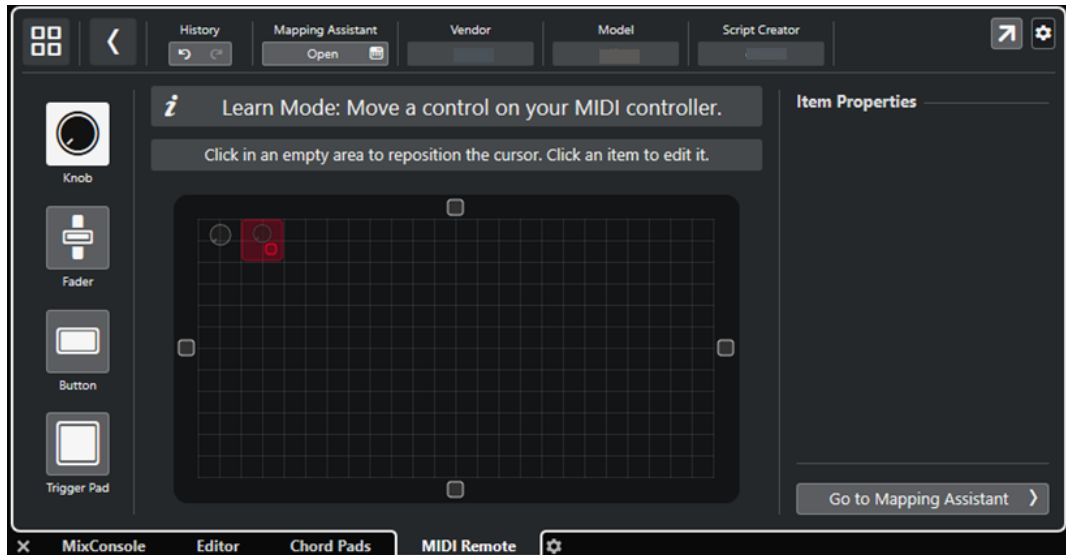

Learn Mode allows you to add controls to the surface display by sending MIDI messages from your MIDI controller to Cubase. In order to do so, move the corresponding hardware controls. In **Learn Mode**, the cursor is red.



- Select a control type to the left of the surface display.
- To reposition the cursor, click an empty area or use **Up Arrow**, **Down Arrow**, **Left Arrow**, or **Right Arrow**.
- To change the size of the cursor and thereby the size of the control, hold down **Shift** while using **Up Arrow**, **Down Arrow**, **Left Arrow**, or **Right Arrow**.

NOTE

All editing in the surface display is based on a fixed grid.

Edit Mode

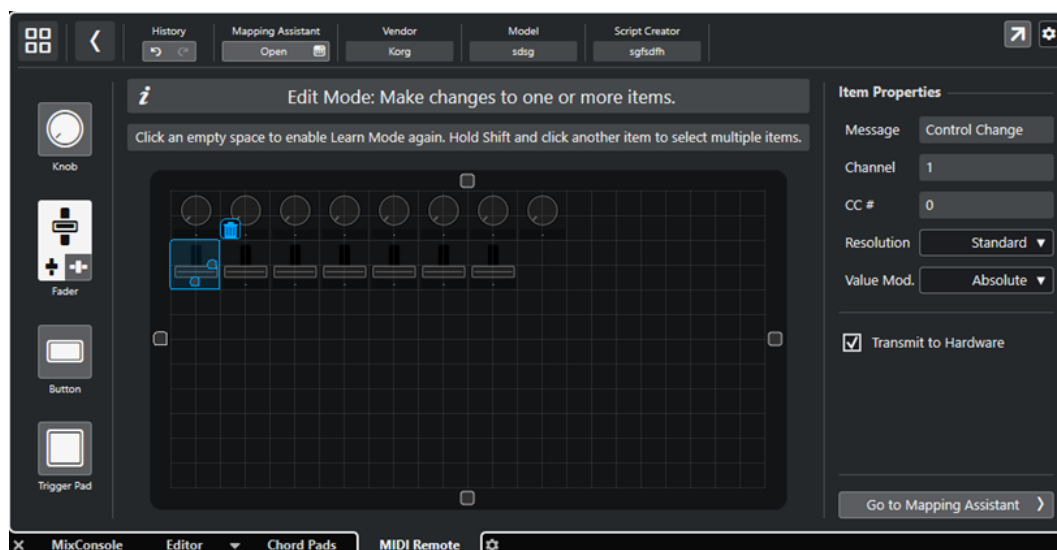

Edit Mode allows you to edit the selected control. In **Edit Mode**, the selected control is displayed in blue.

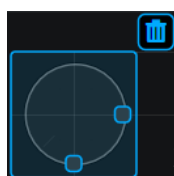

- To change the dimensions of the control, drag the control handles.
- To move a control, click and drag or use **Up Arrow**, **Down Arrow**, **Left Arrow**, or **Right Arrow**.
- To select multiple controls, hold down **Shift**.
- To remove a control, click the trash icon.
- To specify the control properties, use the **Item Properties** to the right of the surface display.

RELATED LINKS

[MIDI Remote Tab](#) on page 540

[MIDI Remote API](#) on page 571

[MIDI Controller Surface Editor](#) on page 551

Item Properties

The **Item Properties** are available in **Edit Mode**. They show the properties for the control that you select from the **MIDI Controller Surface Editor**.

- To show the **Item Properties**, open the **MIDI Controller Surface Editor**. Use the **Learn Mode** to create surface controls that are assigned to your MIDI controller, and select a surface control in the surface display to activate **Edit Mode**.

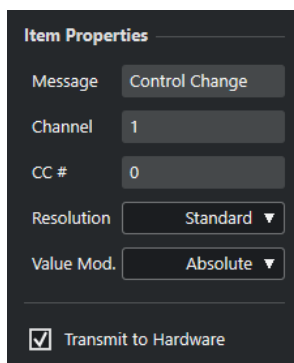

The following properties are available:

Message/Command

Shows the MIDI message type that is assigned to the control, for example, control change, program change, etc.

Channel

Shows the MIDI channel that is assigned to the control.

CC

Shows the MIDI controller number that is assigned to the control.

CC Mode/Resolution

Allows you to set the resolution of the controls of your MIDI controller: **Standard**, **14 Bit**, or **14 Bit NRPN**.

Value Mode

Allows you to set the value mode of the controls of your MIDI controller to **Absolute**, which means that MIDI controllers send absolute value messages from 0 to 127.

You can also select one of the relative modes. Relative or endless MIDI controllers can send value increment and value decrement messages. This is useful to avoid parameter jumps that can occur when the state of a control in the software and the corresponding control on the hardware MIDI controller differ. The following relative modes are available:

- **Relative Signed Bit**
Increases from 065 to 127, decreases from 001 to 063.
- **Relative Binary Offset**
Increases from 065 to 127, decreases from 063 to 000.
- **Relative Twos Complement**
Increases from 001 to 64, decrease from 127 to 065.

NOTE

We suggest that you experiment with the modes until you find what works best for you.

Transmit to Hardware

By default, mapped MIDI CCs are sent back to the MIDI controller. If this is not what you want, deactivate this option.

RELATED LINKS

[MIDI Controller Surface Editor](#) on page 551

[Edit Mode](#) on page 554

MIDI Controller Settings Pane

The **MIDI Controller Settings** pane allows you to access the most important controller settings.

- To open the **MIDI Controller Settings** for the selected MIDI controller, click **MIDI Controller Settings** to the top right of the corresponding MIDI controller surface.

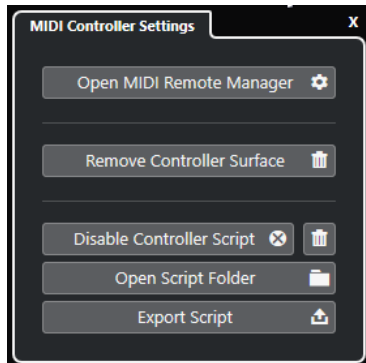

Open MIDI Remote Manager

Opens the **MIDI Remote Manager**, which shows information about the connected MIDI controllers and the installed scripts.

Remove Controller Surface

Removes the selected controller surface.

NOTE

This is only available for controller surfaces that are currently disconnected.

Disable Controller Script

Disables the script of the selected controller surface.

Delete Script

Deletes the script of the selected controller surface.

Open Script Folder

Opens the location of the scripts folder.

Export Script

Exports the script of the selected controller surface.

RELATED LINKS

[Disabling Controller Scripts](#) on page 569

[Deleting Unused MIDI Controller Scripts](#) on page 569

[Importing MIDI Controller Surface Scripts](#) on page 547

[MIDI Remote Manager Window](#) on page 564

[MIDI Remote Manager - MIDI Controllers Tab](#) on page 566

MIDI Remote Mapping Assistant

The **MIDI Remote Mapping Assistant** allows you to map the controls of your MIDI controller to functions in Cubase.

To open the **MIDI Remote Mapping Assistant**, select a MIDI controller from the **MIDI Controller** pop-up menu on the info line of the **MIDI Remote** tab, and do one of the following:

- On the MIDI controller surface, double-click a control.
- On the info line of the **MIDI Remote** tab, click **Open Mapping Assistant**.
- On the toolbar of the **Project** window, click **Open MIDI Remote Mapping Assistant**.
- On the info line of the **MIDI Controller Surface Editor**, click **Open Mapping Assistant**.

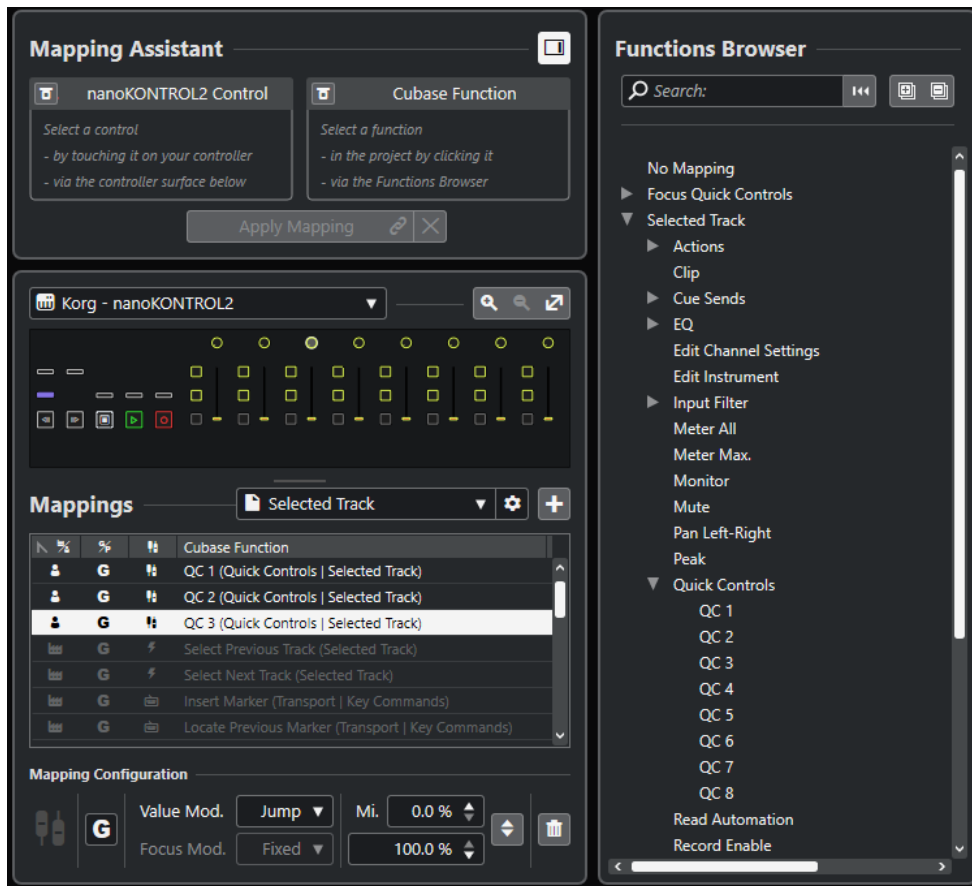

The following sections are available:

Mapping Assistant

Show/Hide Functions Browser

Opens/closes the **Functions Browser** in the right zone.

Mapping Assistant

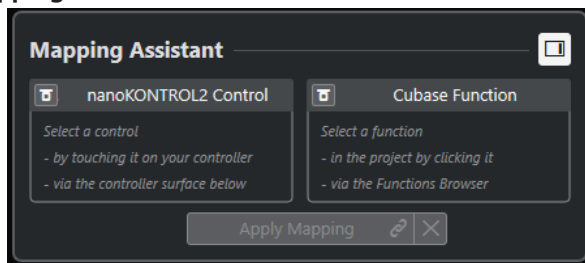

Mapping Assistant without Mapping

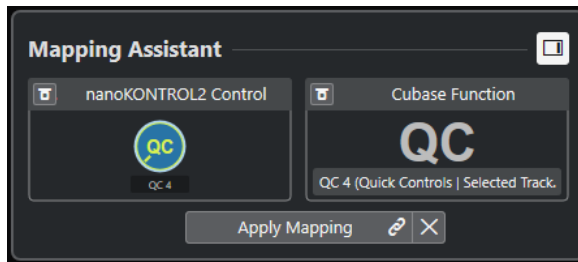

A control on your MIDI controller and a Cubase function selected for mapping

The **Mapping Assistant** guides you through the mapping process. It allows you to select a control on your MIDI controller and a Cubase function for mapping.

Bypass MIDI Controller Learn Mode

- If this is deactivated, you can touch a control on your MIDI controller or click a control in the controller surface to select it for mapping.
- If this is activated, you must click a control in the controller surface to select it for mapping. Activate this if your MIDI controller constantly sends MIDI data and thereby disturbs the mapping.

Bypass Function Learn Mode

- If this is deactivated, you can use a Cubase function or click a function in the **Functions Browser** to select it for mapping.
- If this is activated, you must right-click a Cubase function and select **Pick for MIDI Remote Mapping** to select it for mapping. You can also click a function in the **Functions Browser**.

Apply Mapping

Applies the mapping.

Reset Mapping

Allows you to reset the mapping.

Controller Surface

Controller Surface

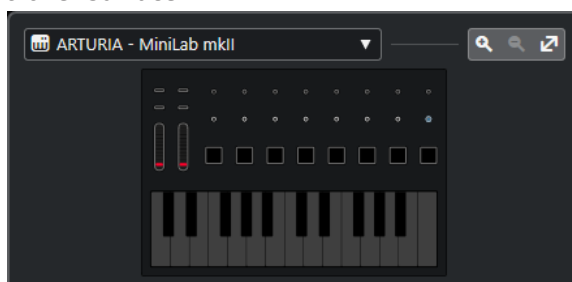

Shows a representation of your MIDI controller that allows you to view and edit mappings. If your MIDI controller offers different layer zones, an indicator displays the active layer zone. You can use the mouse wheel to switch from one layer zone to the other.

NOTE

You might need to zoom in on the controller surface to display the layer zone indicator.

Zoom controls



Allow you to zoom in and out of the controller surface.

NOTE

You can also press **G** to zoom in and **H** to zoom out of the current controller surface.

Mappings

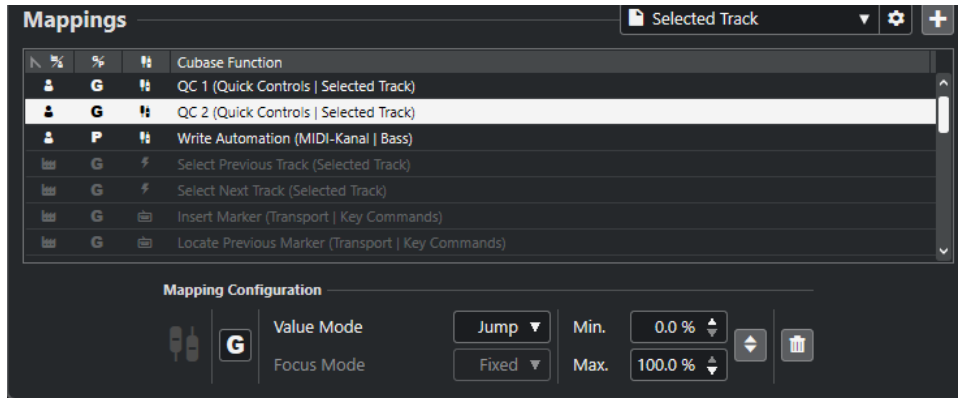

Mapping Page

Shows the active mapping page.

Mapping Page Settings

Opens a menu that allows you to delete, rename, or duplicate the selected mapping page.

Add Mapping Page

Opens a dialog that allows you to add a new, empty mapping page.

Mapping List

To sort the list by a specific attribute, click the corresponding column header.

- **Mapping Page Type**
Indicates whether the mapping is saved as a **Factory** mapping or as a **User** mapping.
- **Mapping Scope**
Indicates whether the mapping has a **Global** scope or a **Project** scope.
- **Mapping Type**
Shows the type of the selected mapping:
 - **Parameter Mapping**
A mapping between a control on your MIDI controller and Cubase value.
 - **Key Command Mapping**
A mapping between a control on your MIDI controller and a Cubase key command.
 - **Action Mapping**
A mapping between a control on your MIDI controller and a mapping page action, such as switching to another mapping page, for example.
- **Cubase Functions**
Displays the Cubase function that is mapped.

The **Mapping Configuration** shows the details for the mapping that you select from the mapping list.

Value Mode

Allows you to configure how Cubase functions take over values from controls on your MIDI controller. This is useful in case the control value does not match the parameter value.

- **Jump**
Sends a new value to the Cubase function, as soon as you move the control on your MIDI controller. This can result in abrupt value changes.
- **Pickup**
Picks up on the value of the Cubase function, as soon as the control that you move on your MIDI controller reaches that value. This results in smooth value changes but requires you to estimate the pickup value.
- **Scaled**
Compares the value of the Cubase function to the control value, as soon as you move the control on your MIDI controller, and approaches the two values in a smooth way. As soon as the values are identical, the function follows the control value. This results in smooth value changes.
- **Toggle**
Allows you to toggle the state of the mapped function. This is useful for mute and solo controls, for example.

Focus Mode

- **Fixed**
Sets a fixed focus to the Cubase function that is picked for mapping.
- **Track Selection**
Sets the focus according to the track selection.

Min. Value/Max. Value

Allows you to set the value range of the mapped Cubase function.

Invert Minimum and Maximum

Inverts the minimum and maximum values.

Remove Selected Mappings

Allows you to remove the selected mapping.

Functions Browser

Functions Browser

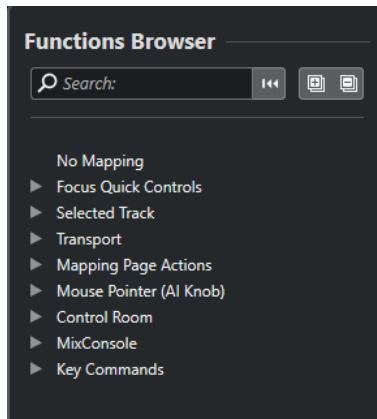

This section shows the mappable functions in a browser view with different categories. Select a function in the browser to show it in the Cubase **Function** section of the **Mapping Assistant**.

Search

Allows you to search for functions by typing in their name or parts of their name.

Reset Filter

Allows you to reset the search filter.

Expand All

Expands all entries.

Collapse All

Collapses all entries.

RELATED LINKS

[Mapping Pages and Mapping Scopes](#) on page 561

[Mapping Controls on MIDI Controllers to Cubase Functions](#) on page 548

[Adding MIDI Controller Surfaces](#) on page 546

Mapping Pages and Mapping Scopes

Mapping Pages

All mappings of Cubase functions and controls on your MIDI controller are saved on mapping pages. A MIDI controller can have different mapping pages for different purposes, but only one mapping page can be active. The active mapping page is shown in the lower zone.

Cubase comes with several scripts that include one or more factory pages with factory mappings. Neither the factory pages nor the factory mappings can be removed. However, you can use factory pages as a basis for your own user mappings. All mappings that you apply are saved as user mappings.

The **Mapping Page Type** column of the **MIDI Remote Mapping Assistant** indicates if a mapping is a user mapping  or a factory mapping .

Mapping Scopes

All factory mappings are automatically set to **Global** scope, that is, they are saved with the program. You cannot change the mapping scope for factory mappings.

All user mappings that you add by selecting a function in the **Functions Browser** are automatically set to **Global** scope.

All user mappings that you add by picking a Cubase function or by using it are considered ad hoc mappings, and therefore, automatically set to **Project** scope. The only exception are functions that can also be found in the **Functions Browser**. These are automatically set to **Global** scope.

NOTE

For user mappings, you can change the mapping scope manually by selecting an option from the **Mapping Scope** menu in the **Mapping Configuration** section.

RELATED LINKS

[MIDI Remote Mapping Assistant](#) on page 556

Focus Quick Controls

Focus Quick Controls are focus-dependent quick controls. This means that the active window focus determines which parameters respond to your MIDI controller.

Focus Quick Controls are the most versatile form of quick controls. You can set them up in the **Functions Browser** of the **MIDI Remote Mapping Assistant**.

To set up the focus behavior for the focus quick controls, activate one of the options in the **Quick Control Focus Setup**. All hardware controls on your MIDI controller that are mapped as focus quick controls follow this focus.

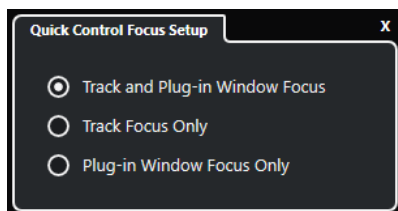

By default, **Track and Plug-in Window Focus** is active. As a result, the following conditions apply:

- If the **Project** window has the focus, your hardware controls the quick controls of the selected track.
- If the plug-in window has the focus, your hardware controls the quick controls of the active plug-in window.

RELATED LINKS

[Quick Control Focus Setup Panel](#) on page 563

[Setting up Focus Quick Controls in the MIDI Remote Mapping Assistant](#) on page 563

[Quick Control Focus](#) on page 543

[VST Instrument Control Panel](#) on page 511

[Effect Control Panel](#) on page 347

[Locking the Quick Control Focus](#) on page 564

Setting up Focus Quick Controls in the MIDI Remote Mapping Assistant

You can set up **Focus Quick Controls** in the **MIDI Remote Mapping Assistant**. **Focus Quick Controls** are focus-dependent quick controls, that is, the active window focus determines which parameters respond to your MIDI controller.

PREREQUISITE

You have connected a MIDI controller to your computer, and its controller surface is shown on the **MIDI Remote** tab in the lower zone of the **Project** window.

PROCEDURE

1. Do one of the following:
 - On the **MIDI Remote** info line, click **Open Mapping Assistant**.
 - On the **Project** window toolbar, click **Open MIDI Remote Mapping Assistant**.
 2. Do one of the following to select a hardware control on your MIDI controller:
 - Click the control in the controller surface of the **MIDI Remote Mapping Assistant**.
 - Touch the control on your MIDI controller.

The name of the control is displayed in the **Mapping Assistant**.
 3. Activate **Show/Hide Functions Browser**.
 4. In the **Focus Quick Controls** category of the **Functions Browser**, select a quick control.
 5. Click **Apply Mapping**.
 6. Repeat the steps above to map more **Focus Quick Controls** to your MIDI controller.
-

RESULT

The **Focus Quick Controls** are now mapped to your MIDI controller.

RELATED LINKS

[Using Supported MIDI Controllers with MIDI Remote](#) on page 545

[Other MIDI Controllers and MIDI Remote](#) on page 545

[Adding MIDI Controller Surfaces](#) on page 546

[Editing MIDI Controller Surfaces](#) on page 546

[Focus Quick Controls](#) on page 562

[Locking the Quick Control Focus](#) on page 564

[VST Instrument Control Panel](#) on page 511

[Effect Control Panel](#) on page 347

Quick Control Focus Setup Panel

The **Quick Control Focus Setup** panel allows you to configure the focus behavior for the focus quick controls.

- To open the **Quick Control Focus Setup** panel, click **Quick Control Focus Setup** on the **MIDI Remote** info line.

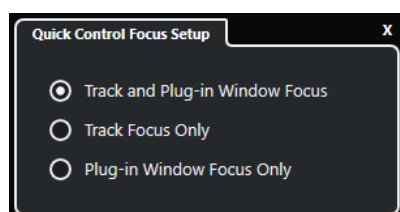

The following options are available:

Track and Plug-in Window Focus

The quick control focus depends on the active window. If the **Project** window is active, the selected track has the quick control focus. If the plug-in window is active, the plug-in has the focus.

Track Focus Only

The quick control focus is always on the selected track.

Plug-in Window Focus Only

The quick control focus is always on the active plug-in window.

RELATED LINKS

[MIDI Remote Info Line](#) on page 541

Locking the Quick Control Focus

You can lock the **Quick Control Focus** to a specific track or plug-in window.

PROCEDURE

1. Do one of the following:
 - To lock the focus to a specific plug-in window, open the corresponding window.
 - To lock the focus to a specific track, select the track from the track list, and make sure that the **Quick Control Focus** section is shown on the **MIDI Remote** info line.
2. Activate the lock by clicking **Focus Quick Controls Lock State: Unlocked** .

RESULT

The **Quick Control Focus** section of the **MIDI Remote** info line shows the name of the track or the plug-in window that has the focus. The corresponding set of quick controls remains active, even if another window gets the focus.

RELATED LINKS

[Setting up Focus Quick Controls in the MIDI Remote Mapping Assistant](#) on page 563

[Quick Control Focus Setup Panel](#) on page 563

[VST Instrument Control Panel](#) on page 511

[Effect Control Panel](#) on page 347

[Quick Control Focus](#) on page 543

MIDI Remote Manager Window

The **MIDI Remote Manager** window displays information about the connected MIDI controllers and the installed scripts.

To open the **MIDI Remote Manager** window, do one of the following:

- In the **MIDI Controller** section of the **MIDI Remote** info line, click **Open MIDI Remote Manager**.
- Select **Studio > MIDI Remote Manager**.

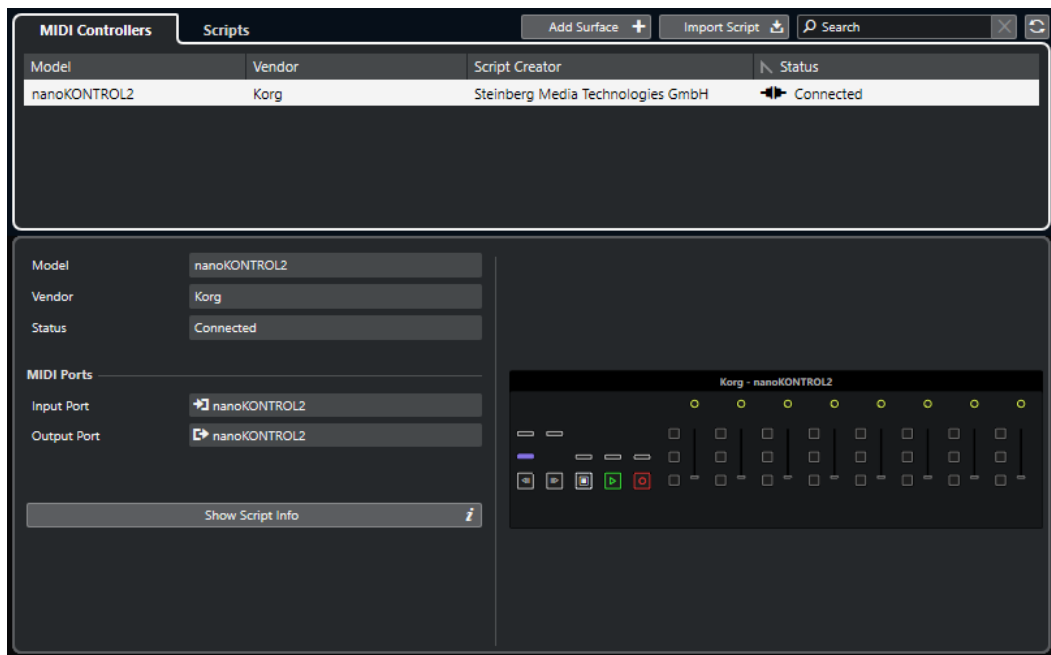

MIDI Controllers

The **MIDI Controllers** tab lists all MIDI controllers, the ones that are currently connected and active, but also the ones which have been active before. To sort the list by a specific attribute, click the corresponding column header. Select a controller from the list to display its information in the bottom part of the window.

Scripts

The **Scripts** tab lists all scripts that are installed by the names of the corresponding controllers. To sort the list by a specific attribute, click the corresponding column header. Select a controller name from the list to display information about the script in the bottom part of the window.

Add Surface

Opens the **Add MIDI Controller Surface** dialog, which allows you to add a new MIDI controller surface for a MIDI controller that has no script.

Import Script

Allows you to import MIDI controller scripts.

Search

The search field allows you to search for specific controllers and scripts on the **MIDI Controllers** tab and on the **Scripts** tab by typing in their name.

Reload Scripts

Allows you to reload the scripts.

RELATED LINKS

[MIDI Remote Info Line](#) on page 541

[MIDI Controller Surface Editor](#) on page 551

[Deleting Unused MIDI Controller Scripts](#) on page 569

[Add MIDI Controller Surface Dialog](#) on page 550

[MIDI Remote Manager - MIDI Controllers Tab](#) on page 566

[MIDI Remote Manager - Scripts Tab](#) on page 567

[Importing MIDI Controller Surface Scripts](#) on page 547

MIDI Remote Manager - MIDI Controllers Tab

The **MIDI Controllers** tab of the **MIDI Remote Manager** window displays information about the connected MIDI controllers.

To show information for a specific MIDI controller, select it from the MIDI controllers list in the upper part of the **MIDI Remote Manager** window.

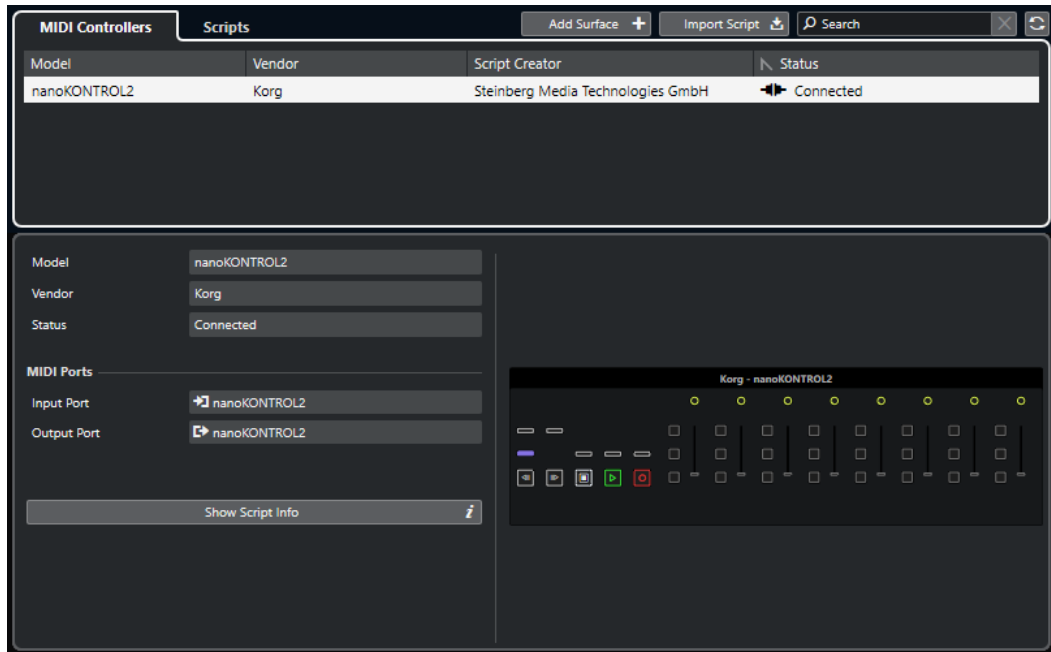

Model

The model of the selected MIDI controller.

Vendor

The vendor of the selected MIDI controller.

Status

The status of the selected MIDI controller.

Input Port

Shows the MIDI input port of your MIDI controller.

Output Port

Shows the MIDI output port of your MIDI controller.

Show Script Info

Opens the **Scripts** tab for the selected MIDI controller.

Remove Controller Surface

Removes the selected controller surface.

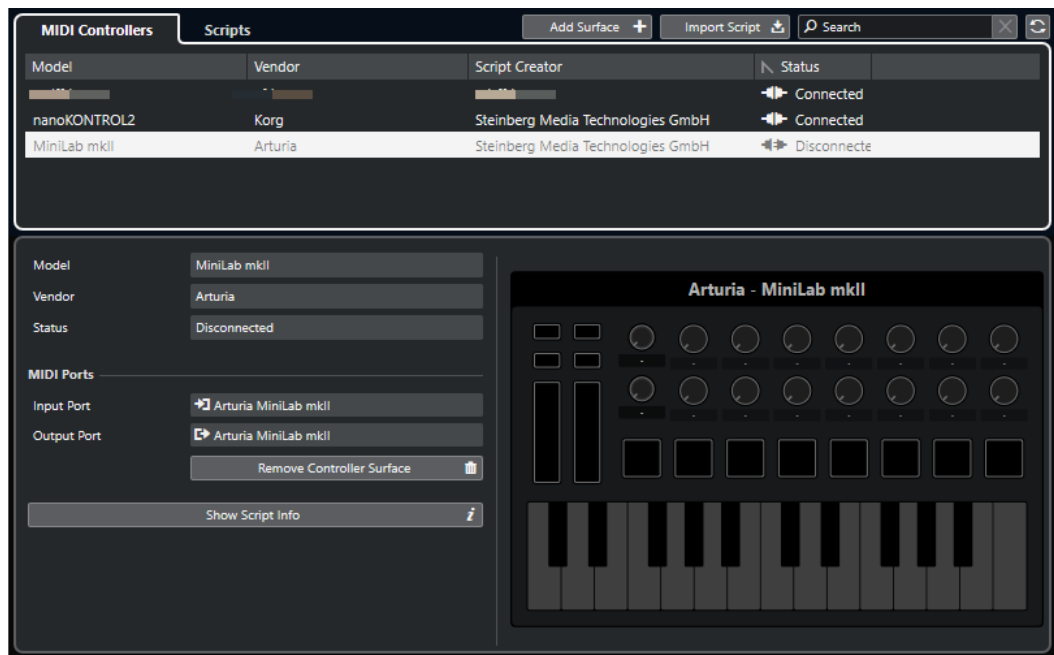

NOTE

This is only available for controller surfaces that are currently disconnected.

RELATED LINKS

- [MIDI Remote Manager Window](#) on page 564
- [MIDI Controller Surface Editor](#) on page 551
- [MIDI Remote Manager - Scripts Tab](#) on page 567
- [MIDI Controller Settings Pane](#) on page 556

MIDI Remote Manager - Scripts Tab

The **Scripts** tab of the **MIDI Remote Manager** window displays script information for the connected MIDI controllers.

To show script information for a specific MIDI controller, select the MIDI controller from the MIDI controllers list in the upper part of the **MIDI Remote Manager** window.

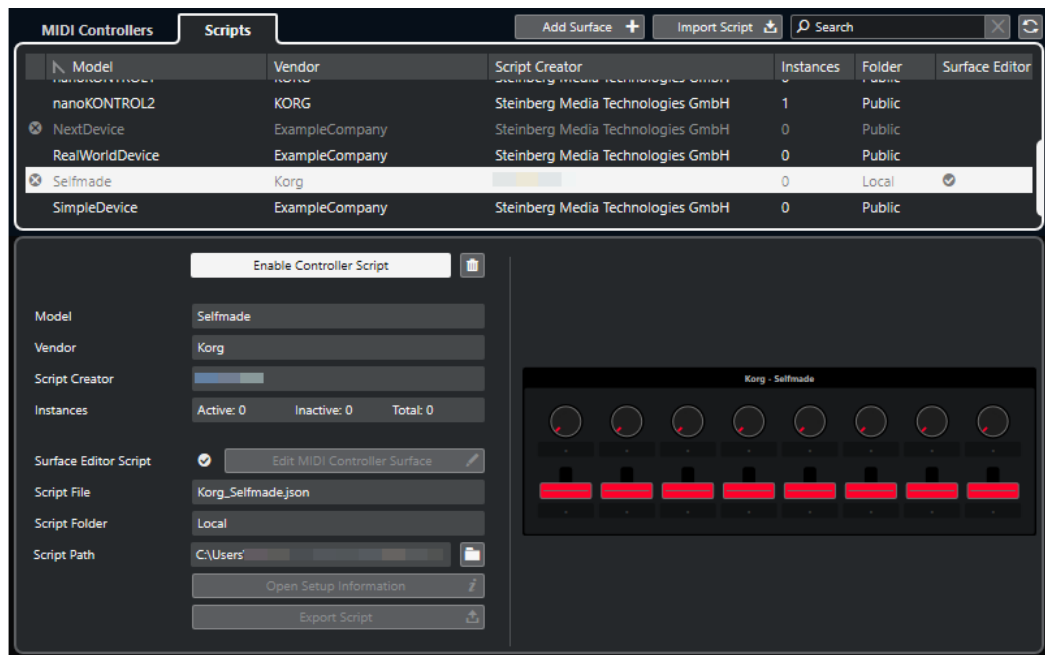

Disable Controller Script/Enable Controller Script

Disables/enables the selected controller script.

Delete Script

Deletes the selected controller script.

Model

The model of the selected MIDI controller.

Vendor

The vendor of the selected MIDI controller.

Script Creator

The script creator of the selected MIDI controller.

Instances

The number of instances of the selected MIDI controller.

Surface Editor Script

If the selected MIDI controller script was created with the **MIDI Controller Surface Editor**, this is indicated by a checkmark. Click **Edit MIDI Controller Surface** to open the **MIDI Controller Surface Editor**.

Script File

The file name of the script.

Script Folder

The name of the folder where the script is located.

Script Path

The file path to the script file.

Open Script Folder

Opens the folder where the script is located.

Open Setup Information

Opens setup information for the selected MIDI controller. This is only available for particular MIDI controllers that require specific settings to communicate with Cubase.

Export Script

Opens a file dialog that allows you to export the selected script.

RELATED LINKS

[MIDI Controller Surface Editor](#) on page 551

[Deleting Unused MIDI Controller Scripts](#) on page 569

Deleting Unused MIDI Controller Scripts

You can delete MIDI controller scripts that you no longer need. However, you can only delete scripts that you have created by adding your own MIDI controller surfaces.

PROCEDURE

1. On the **MIDI Remote** info line, click **Open MIDI Remote Manager**.
2. Open the **Scripts** tab.
3. From the table, select the script that you want to delete.
4. Click **Delete Script**.

NOTE

Delete Script is available for user scripts only. To disable public scripts, click **Disable Controller Script** instead.

RESULT

The script folder is moved to trash, and the controller surface is removed from the MIDI controllers overview.

RELATED LINKS

[Adding MIDI Controller Surfaces](#) on page 546

[MIDI Remote Manager Window](#) on page 564

[MIDI Controller Settings Pane](#) on page 556

Disabling Controller Scripts

You can disable controller scripts. This is useful if you want to use a custom script for a MIDI controller with a public controller script assigned to it, for example.

PROCEDURE

1. On the **MIDI Remote** info line, click **Open MIDI Remote Manager**.
 2. Open the **Scripts** tab.
 3. Select the public script that you want to disable, and click **Disable Controller Script**.
 4. Select the custom script that you want to enable instead, and click **Enable Controller Script**.
-

RELATED LINKS

[Adding MIDI Controller Surfaces](#) on page 546

[MIDI Remote Manager Window](#) on page 564

[MIDI Controller Settings Pane](#) on page 556

MIDI Remote Script Console

The **MIDI Remote Console** displays script messages.

To open the **MIDI Remote Script Console**, activate **Scripting Tools** in the **MIDI Remote** info line context menu, and click **Open MIDI Remote Script Console**.

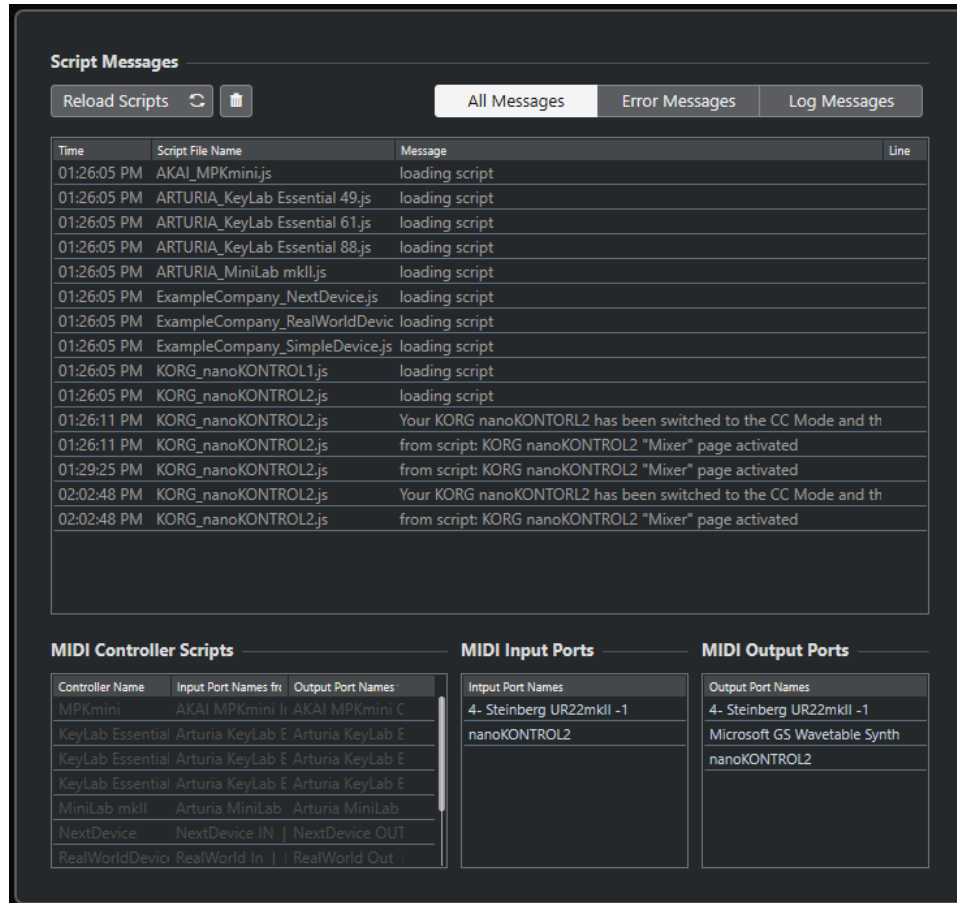

Reload Scripts

Allows you to reload the scripts that are displayed in the **MIDI Remote Script Console**.

Clear All Messages

Clears all messages from the message display.

All Messages

Shows all messages in the message display.

Error Messages

Shows error messages in the message display.

Log Messages

Shows log messages in the message display.

MIDI Controller Scripts

Shows information about the available MIDI controller scripts.

MIDI Input Ports

Shows information about the currently used MIDI input ports.

MIDI Output Ports

Shows information about the currently used MIDI output ports.

MIDI Remote API

The application programming interface **MIDI Remote API** allows you to develop a script, that is, a device driver for dedicated MIDI controllers.

Scripts describe the layout and the order of the controls of a specific MIDI controller. They include factory mappings to Cubase parameters.

Cubase comes with scripts for a number of MIDI controllers. If you connect one of these controllers, it is automatically detected and displayed on the **MIDI Remote** tab.

If no script is available for your controller, we encourage you to write one. Refer to the description in the **MIDI Remote API - Programmer's Guide**.

TIP

To access the **MIDI Remote API - Programmer's Guide**, right-click the info line on the **MIDI Remote** tab, activate the **Scripting Tools**, and click **Open MIDI Remote API - Programmer's Guide**.

NOTE

If you do not have any programming skills, you can use the **MIDI Controller Surface Editor** to create a surface editor script for your MIDI controller.

RELATED LINKS

[Scripting Tools](#) on page 544

[MIDI Controller Surface Editor](#) on page 551

Remote-Controlling Cubase

You can control Cubase with a connected MIDI device via MIDI.

The supported devices are described in the separate document **Remote Control Devices**. You can also use a generic MIDI controller to remote-control Cubase.

NOTE

Most remote control devices are able to control both MIDI and audio channels in Cubase, but the parameter setup may be different. Audio-specific controls, such as EQ, are disregarded when controlling MIDI channels.

RELATED LINKS

[Generic Remote Page \(Legacy\)](#) on page 583

Connecting Remote Devices

You can connect your remote device via USB or via MIDI.

PROCEDURE

- Do one of the following:
 - If your remote device provides a USB MIDI port, use a USB cable to connect it to the USB port of your computer.
 - If your remote device provides a MIDI output, use a MIDI cable to connect it to a MIDI input on your MIDI interface.

NOTE

If the remote device features indicators, motorized faders, or other feedback devices, connect a MIDI Out on the interface to a MIDI In on the remote device.

RELATED LINKS

[MIDI Connections](#) on page 23

Removing the Remote Input from All MIDI Inputs

To avoid that you accidentally record data from the remote device when you record MIDI, remove the remote input from **All MIDI Inputs**.

PROCEDURE

1. Select **Studio > Studio Setup**.
2. In the **Devices** list, select **MIDI Port Setup**.
3. In the table on the right, deactivate **In 'All MIDI Inputs'** for the MIDI input to which you have connected the MIDI remote device.
The **State** column reads **Inactive**.

4. Click **OK**.
-

RESULT

The remote unit input is removed from the **All MIDI Inputs** group.

RELATED LINKS

[MIDI Port Setup Page](#) on page 24

Setting up Remote Devices

PROCEDURE

1. Select **Studio > Studio Setup**.
2. Click **Add** in the top left corner, and select a remote device from the pop-up menu to add it to the **Devices** list.

NOTE

If your device is not available in the pop-up menu, select **Generic Remote**.

3. In the **Devices** list, select the device.
Depending on the selected device, either a list of programmable function commands or a blank panel is shown in the right half of the dialog window.

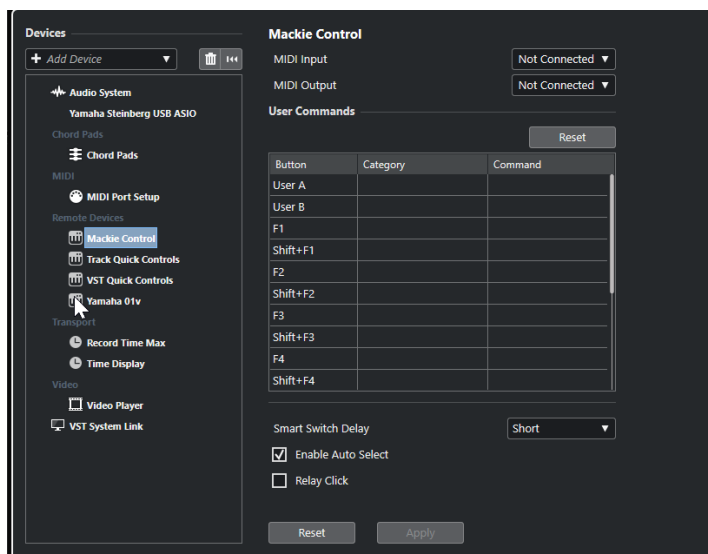

4. Open the **MIDI Input** pop-up menu, and select a MIDI input.
 5. Optional: Open the **MIDI Output** pop-up menu, and select a MIDI output.
 6. Click **OK**.
-

RESULT

You can now use the MIDI device to control Cubase functions.

A bright stripe in the **Project** window and in the **MixConsole** indicates the channels that are linked to the remote control device.



You can open a panel for the added device by selecting **Studio > More Options**.

AFTER COMPLETING THIS TASK

Depending on your external MIDI control device, you might need to configure the parameters.

Resetting Remote Devices

You can reset remote devices. This is necessary if the communication between Cubase and a remote device is interrupted or if the handshaking protocol fails to establish the connection.

PROCEDURE

1. Select **Studio > Studio Setup**.
2. In the **Devices** list, select the remote device.
3. Click **Reset** in the lower part of the **Studio Setup** dialog to reset the selected remote device.

NOTE

To reset all devices in the **Devices** list, click **Reset All Devices** in the top left of the dialog.

RELATED LINKS

[Studio Setup Dialog](#) on page 12

Global Options for Remote Controllers

On the page for your remote device, global functions may be available.

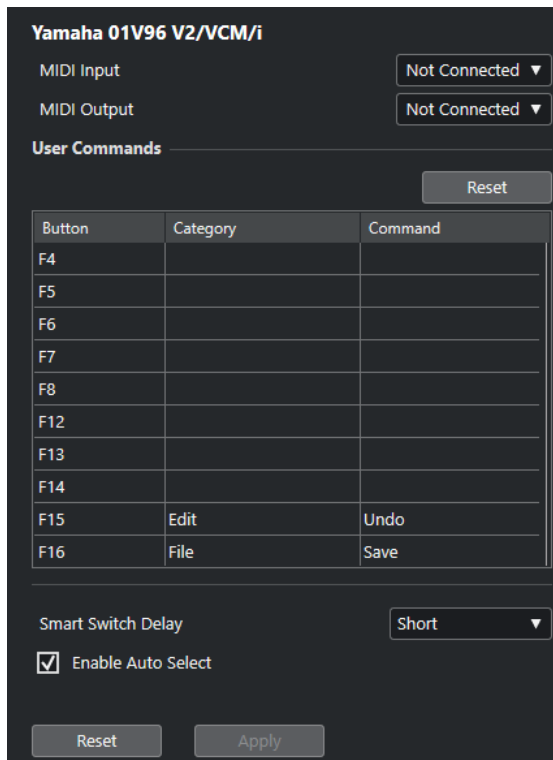

MIDI Input

Allows you to select a MIDI input.

MIDI Output

Allows you to select a MIDI output.

User Commands

Lists the controls or buttons of your remote device.

Smart Switch Delay

Allows you to specify a delay for the smart switch function. Functions that support the smart switch behavior are activated for as long as the button is pressed.

Enable Auto Select

For touch-sensitive remote control devices, this automatically selects a channel when you touch a fader. For devices without touch-sensitive faders, the channel is selected as soon as you move the fader.

Remote Devices and Automation

You can write automation via remote devices.

If your remote device does not have touch-sensitive controls and you want to replace existing automation data in **Write** mode, consider the following:

- Make sure that you move only the controller that you want to replace.
- Stop playback to deactivate **Write** mode.

As a result, all data for the corresponding parameter is replaced, from the position where you moved the control up to the position where you stop playback.

Assigning Commands to Remote Devices

You can assign any Cubase command to which a key command can be assigned to remote devices.

PROCEDURE

1. Select **Studio > Studio Setup**.

2. In the **Devices** list, select your remote device.

In the **User Commands** section, the controls or buttons of your remote device are listed in the **Button** column.

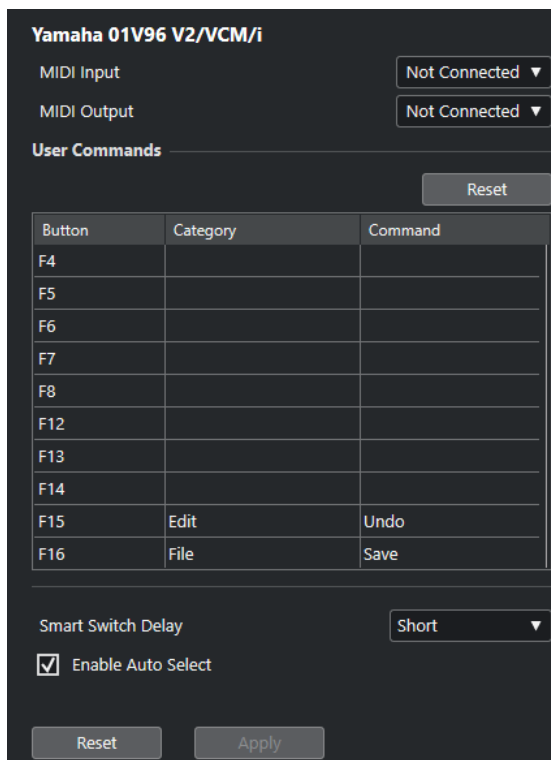

3. Click in the **Category** column for the control to which you want to assign a Cubase command, and select the category from the pop-up menu.

The categories correspond to the categories in the **Key Commands** dialog.

4. Click in the **Command** column, and select the Cubase command from the pop-up menu.

The available items on the pop-up menu depend on the selected category.

5. Click **Apply**.

RESULT

The selected function is assigned to the button or control on the remote device.

RELATED LINKS

[Key Commands](#) on page 801

Remote Control Editor

The **Remote Control Editor** allows you to define your own mapping of VST plug-in parameters to the controls of the supported hardware controllers. This is useful if you think that the automatic mapping of plug-in parameters to remote control devices is not intuitive enough.

- To open the **Remote Control Editor**, right-click the plug-in panel of the plug-in that you want to remote-control, and select **Remote Control Editor**.

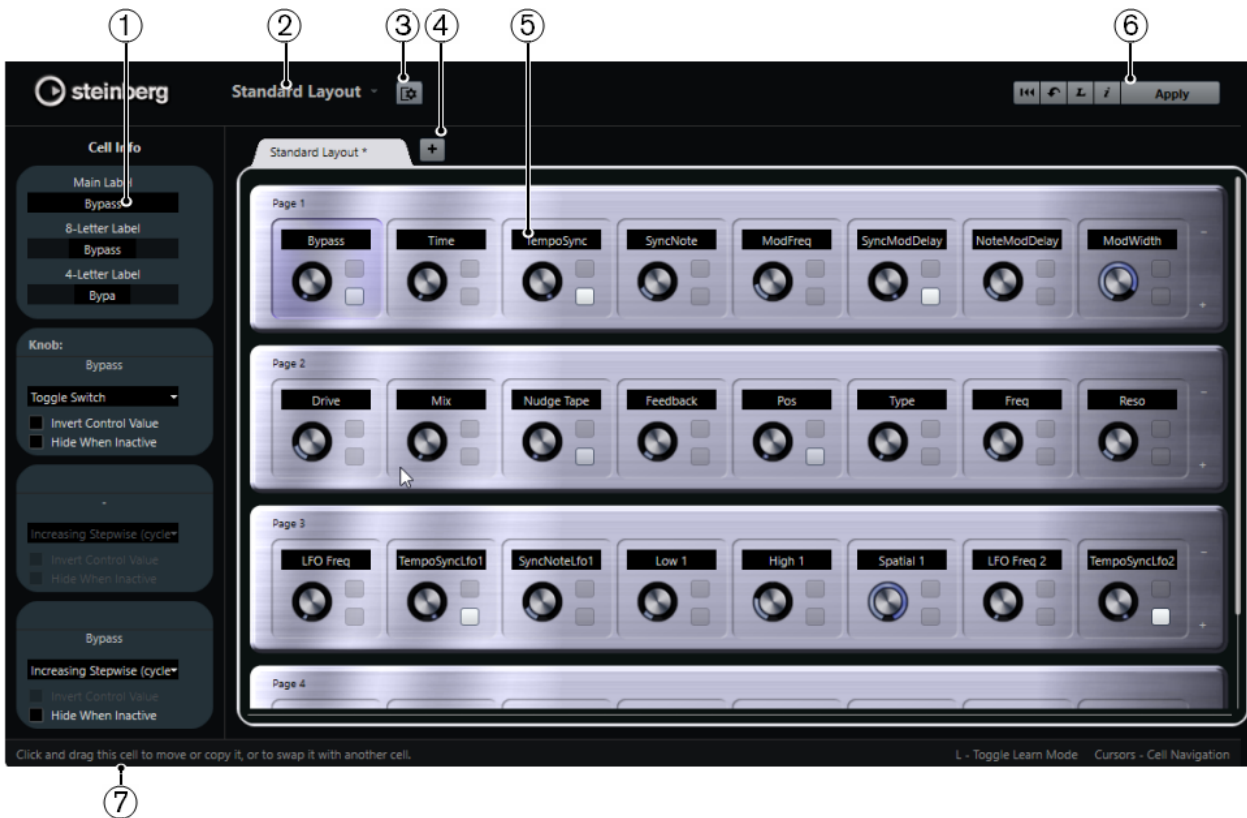

1 Inspector

Contains the settings and the parameter assignment for the selected cell. The upper section contains settings for the text label. The lower section contains settings for the knob and the switches.

2 Layout Selection

Shows the name of the layout. Click to select a different layout.

3 Set up Cell Layout

Opens the **Cell Layout Configuration**, where you can specify the number of cells per page and select the switch layout for the pages. To specify the number of switches for a cell, activate/deactivate them.

4 Add New Hardware Layout

Adds a new layout for a particular hardware type. To remove a hardware layout, click its **Close** button.

5 Layout section

Displays layouts that represent the hardware devices that are used to remote-control the plug-in parameters. Here, you can change the parameter assignments, the name in the text label, the cell setup, and the order of cells and pages.

6 Toolbar

Shows tools for setting up the layout.

7 Status Bar

Shows information about an element when you position the mouse pointer over it in the editor window.

RELATED LINKS

[Remote Control Editor Toolbar](#) on page 578

Remote Control Editor Toolbar

Shows tools for setting up the layout.

Remove All Assignments



Removes all parameter assignments.

Get Default Factory Layout/Copy Layout from Other Tab



Reverts to the default settings for the current layout or copies the settings of one layout page to another.

Activate/Deactivate Learn Mode



Activates/Deactivates **Learn** mode for the **Remote Control Editor**.

Activate/Deactivate Assignment Inspection View



Shows the current assignment of all cells in a layout.

Apply Current Layout

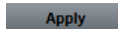

Saves the settings. If the hardware supports this function, the changes are immediately reflected on the hardware controllers.

Control Settings

You can define the control style for switches or knobs to which you have assigned a function. This includes the LED ring or changing its behavior from continuous value representation to on/off, for example.

To open the **Control Settings** panel, right-click the control.

NOTE

Not all hardware devices support all control type settings.

Control Type Settings for Knobs

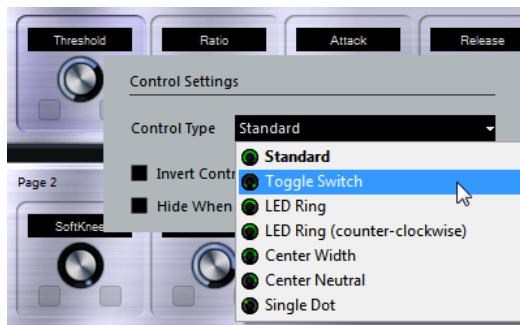

The following control types are available for knobs:

Standard

A standard knob with an undefined LED style.

Toggle Switch

A knob with 2 states.

LED Ring

An LED ring around the knob. The setting increases clockwise.

LED Ring (counter-clockwise)

An LED ring around the knob. The setting increases counter-clockwise.

Center Width

An LED ring that starts at the top center position. When the settings increase, an LED is shown, which is growing in both directions.

Center Neutral

A dial that starts at the top center position and can be moved left or right, like a pan control, for example.

Single Dot

An LED ring around the knob. The setting increases clockwise, with a dot indicating the current value.

Control Type Settings for Switches

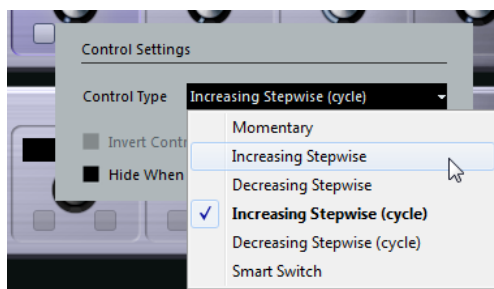

The following options are available for switches:

Momentary

Activates the assigned function for as long as you hold the switch.

Increasing Stepwise

Steps through the available settings until the maximum is reached.

Decreasing Stepwise

Steps through the available settings in reverse order until the minimum is reached.

Increasing Stepwise (cycle)

Steps through the available settings, starting over with the minimum value when the maximum is reached.

Decreasing Stepwise (cycle)

Steps through the available settings in reverse order, starting over with the maximum value when the minimum is reached.

Smart Switch

Switches between 2 states every time you press the switch. Enters **Momentary** mode if you hold the switch.

Invert Control Value

Inverts the control state/value.

Hide When Inactive

Hides plug-in parameters when they are inactive or disabled.

Assigning Parameters to Controls

PROCEDURE

1. On the **Remote Control Editor** toolbar, click **Activate/Deactivate Learn Mode**.
2. Select the control that you want to assign to a plug-in parameter.
3. Do one of the following:
 - Click a parameter on the plug-in panel.
 - Double-click on a control in the **Remote Control Editor**, and select a parameter from the list of available plug-in parameters.
4. Press **Esc** to end **Learn** mode.

RESULT

The parameter is assigned to the control.

NOTE

To remove the parameter assignment for a cell, activate **Learn** mode, select the cell, and press **Delete** or **Backspace**.

RELATED LINKS

[Remote Control Editor Toolbar](#) on page 578

Editing the Layout

In the layout section, you can perform a number of editing operations and arrange the pages to your liking.

- To navigate from cell to cell, use the cursor keys.

- To step through the controls within the cells in **Learn** mode, press **Shift**, and use the cursor keys.
- To step through the different layouts, use **Tab** and **Shift-Tab**.
- To copy the settings of one cell to another, select a cell, press **Alt**, and drag it to another cell.
- To move a cell, drag it to an empty cell.
- To swap the contents of 2 cells, press **Ctrl/Cmd**, and drag one cell to the other.

NOTE

Drag and drop also works between different pages.

- To add a page to a layout, click **Add New Page**.



- To remove a page, click **Remove Current Page**.
- To specify the label for a cell, use the top 3 text fields in the **Inspector**.

The first text field displays the long name, as it is shown in the cell. In the second field, you can enter a name that can contain up to 8 characters, and up to 4 characters in the third.

NOTE

This is useful if your hardware devices have value fields that only display a limited number of characters.

Track Quick Controls

If you have an external remote control device, you can set it up to control up to 8 parameters of each audio track, MIDI track or instrument track, using the **Track Quick Controls** feature in Cubase.

To show the **Track Quick Controls** for a specific track, select the track from the track list, and, in the **Inspector**, open the **Quick Controls** section.

RELATED LINKS

[Track Quick Controls](#) on page 534

[Using Supported MIDI Controllers with MIDI Remote](#) on page 545

[Setting up Focus Quick Controls in the MIDI Remote Mapping Assistant](#) on page 563

Setting up Track Quick Controls with Remote Controllers (Legacy)

Track Quick Controls become particularly powerful if you use them in conjunction with a remote controller.

We recommend to set up **Track Quick Controls** in the **MIDI Remote Mapping Assistant** and to use the **Studio Setup** dialog only in case you already used **Track Quick Controls** with an earlier version of Cubase.

PREREQUISITE

The MIDI output on your remote device is connected to a MIDI input on your MIDI interface.

PROCEDURE

1. Select **Studio > Studio Setup**.
 2. In the **Devices** list, select **Track Quick Controls**.
 3. Open the **MIDI Input** pop-up menu, and select a MIDI input.
 4. Optional: Open the **MIDI Output** pop-up menu, and select a MIDI output.
 5. Click **Apply**.
 6. Activate **Learn**.
 7. In the **Control Name** column, select **QuickControl 1**.
 8. On your MIDI device, move the control that you want to connect with the first quick control.
 9. Select the next slot in the **Control Name** column, and repeat the previous steps.
 10. Click **OK**.
-

RESULT

The **Track Quick Controls** are now connected with control elements on your MIDI device. If you move a control element, the value of the parameter that is assigned to the corresponding **Track Quick Controls** changes accordingly.

NOTE

The remote controller setup for **Track Quick Controls** is saved globally, that is, it is independent of any projects.

RELATED LINKS

[Generic Remote Page \(Legacy\)](#) on page 583

[Setting up Focus Quick Controls in the MIDI Remote Mapping Assistant](#) on page 563

Activating Pick-up Mode for Hardware Controls (Legacy)

Pick-up Mode allows you to change configured **Quick Control** parameters without accidentally modifying the previous values. This is useful if you want the control to pick up the parameter at the value to which it was last set. If you move a hardware control, the parameter only changes when the control reaches the previous value.

NOTE

This only applies to hardware controllers whose controls use specific ranges.

PROCEDURE

1. Select **Studio > Studio Setup**.
 2. In the **Devices** list, select **Track Quick Controls** or **VST Quick Controls**.
 3. Activate **Pick-up Mode**.
 4. Click **OK**.
-

VST Quick Controls

If you have an external remote control device, you can control up to 8 parameters of a VST instrument via the **VST Quick Controls** feature in Cubase.

RELATED LINKS

[VST Instrument Control Panel](#) on page 511

[Effect Control Panel](#) on page 347

[Using Supported MIDI Controllers with MIDI Remote](#) on page 545

[Setting up Focus Quick Controls in the MIDI Remote Mapping Assistant](#) on page 563

[VST Quick Controls in the VSTi Rack \(Legacy\)](#) on page 583

VST Quick Controls in the VSTi Rack (Legacy)

VST Quick Controls allow you to remote-control a VST instrument from within the **VSTi** rack.

To show the **VST Quick Controls** on the **VSTi** rack, activate **Show/Hide all VST Quick Controls**.

The following controls are available on each rack:



1 Show/Hide VST Quick Controls

Allows you to show/hide the **VST Quick Controls** for the instrument.

2 VST Quick Controls

Allow you to remote-control the parameters of the instrument.

NOTE

The number of **VST Quick Controls** that are displayed depends on the size of the **VST Instruments** window.

3 Set Remote-Control Focus for VST Quick Controls

Allows you to activate the **VST Quick Controls** to remote-control the instrument.

Generic Remote Page (Legacy)

You can use a generic MIDI controller to remote-control almost any function in Cubase. After setting up the **Generic Remote** device, you can control the specified parameters via the MIDI remote device.

- To open the **Generic Remote** page, select **Studio > Studio Setup**, and, from the **Devices** list, select **Generic Remote**.

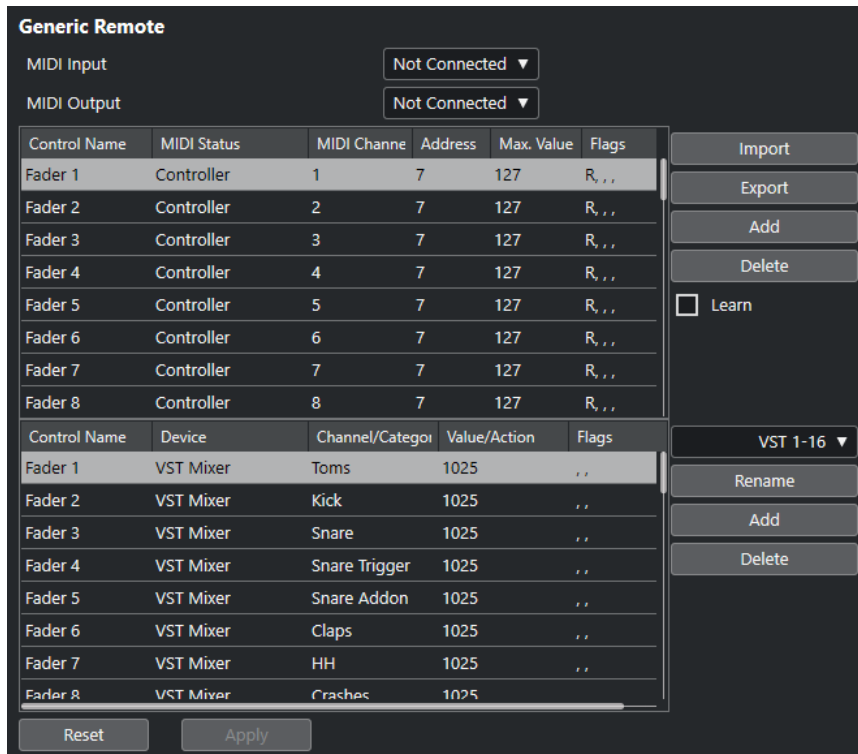

The following options are available:

MIDI Input

Allows you to select the MIDI input port to which your remote device is connected.

MIDI Output

Allows you to select the MIDI output port to which your remote device is connected.

MIDI Remote Control Configuration

The upper table shows the MIDI remote control configuration of your remote device.

Cubase Control Assignment

The lower table allows you to assign Cubase controls to your remote device.

RELATED LINKS

[MIDI Remote Control Configuration Section](#) on page 584

[Cubase Control Assignment Section](#) on page 586

MIDI Remote Control Configuration Section

The MIDI remote control configuration section is displayed in the upper table of the **Generic Remote** setup page.

- To open the **Generic Remote** settings, select **Studio > Studio Setup**, and, from the **Devices** list, select **Generic Remote**.

Control Name	MIDI Status	MIDI Channel	Address	Max. Value	Flags
Fader 1	Controller	1	7	127	R, , ,
Fader 2	Controller	2	7	127	R, , ,
Fader 3	Controller	3	7	127	R, , ,
Fader 4	Controller	4	7	127	R, , ,
Fader 5	Controller	5	7	127	R, , ,
Fader 6	Controller	6	7	127	R, , ,
Fader 7	Controller	7	7	127	R, , ,
Fader 8	Controller	8	7	127	R, , ,

Buttons: Import, Export, Add, Delete, Learn

The following options are available in the upper table:

Control Name

Double-click this field to change the name of the control and to enter the name written on the console, for example. This name change is automatically reflected in the lower table.

MIDI Status

Allows you to specify the type of MIDI message sent by the control.

MIDI Channel

Allows you to select the MIDI channel on which the controller is transmitted.

Address

Allows you to specify the continuous controller number, the pitch of a note, or the address of an NRPN/RPN continuous controller.

Max. Value

Allows you to specify the maximum value that the control transmits. This value is used by the program to scale the value range of the MIDI controller to the value range of the program parameter.

Flags

Allows you to select one of the following flags:

- **Receive**
Activate this if the MIDI message should be processed on reception.
- **Transmit**
Activate this if a MIDI message should be transmitted when the corresponding value in the program changes.
- **Relative**
Activate this if the control is an endless rotary encoder, which reports the number of turns instead of an absolute value.
- **Pick-up**
Activate this if you want the control to pick up the parameter at the value to which it was last set.

The buttons and the options to the right of the table have the following functions:

Import

Allows you to import saved remote setup files.

Export

Allows you to export the current setup with the file extension **.xml**.

Add

Adds controls to the bottom of the table.

Delete

Deletes the selected control from the table.

Learn

Allows you to assign MIDI messages by learning.

Cubase Control Assignment Section

You can specify the Cubase control assignment section in the lower table of the **Generic Remote** setup page. Each row in the table is assigned to the controller in the corresponding row of the MIDI remote-control configuration table.

- To open the **Generic Remote** settings, select **Studio > Studio Setup**, and, from the **Devices** list, select **Generic Remote**.

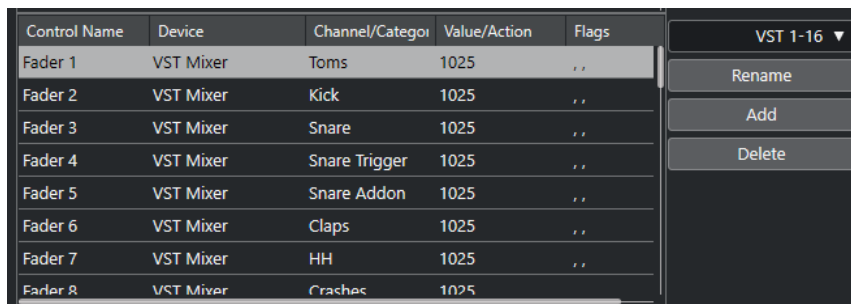

Control Name	Device	Channel/Category	Value/Action	Flags
Fader 1	VST Mixer	Toms	1025	..
Fader 2	VST Mixer	Kick	1025	..
Fader 3	VST Mixer	Snare	1025	..
Fader 4	VST Mixer	Snare Trigger	1025	..
Fader 5	VST Mixer	Snare Addon	1025	..
Fader 6	VST Mixer	Claps	1025	..
Fader 7	VST Mixer	HH	1025	..
Fader 8	VST Mixer	Crashes	1025	..

The following options are available:

Control Name

Reflects the control name selected in the upper table.

Device

Allows you to select the Cubase device that you want to control.

Channel/Category

Allows you to select the channel or the command category that you want to control.

Value/Action

Allows you to select the parameter of the channel that you want to control. If the **Command** device is selected, this is where you specify the **Action** of the category.

Flags

Allows you to select one of the following flags:

- **Push Button**
Activate this if the parameter should only be changed if the received MIDI message shows a value unequal to 0.
- **Toggle**
Activate this if the parameter value should be switched between minimum and maximum value, each time a MIDI message is received.
You can combine **Push Button** and **Toggle** for remote controls which do not latch the state of a button. This is useful to control the mute status with a device on which pressing the mute button turns it on, and releasing the mute button turns it off.
- **Not Automated**
Activate this if you do not want the parameter value to be automated.

The buttons to the right of the table have the following functions:

Bank pop-up menu

Allows you to switch banks. This is necessary if your MIDI control device has 16 volume faders and you are using 32 **MixConsole** channels in Cubase, for example.

Rename

Allows you to rename the selected bank.

Add

Adds banks to the pop-up menu.

Delete

Deletes the selected bank from the pop-up menu.

RELATED LINKS

[Assignable Devices and Functions](#) on page 587

Assignable Devices and Functions

The **Device** column in the Cubase control assignment section lists the Cubase devices that you can control.

Command

Allows you to assign Cubase commands to which a key command can be assigned. If you select **Add Track** in the **Channel/Category** column and **Audio** in the **Value/Action** column, you can add audio tracks via your MIDI device, for example.

VST Quick Controls Manager

Allows you to assign **VST Quick Controls**. If you select **Device** in the **Channel/Category** column and one of the **Quick Control** options in the **Value/Action** column, you can control the **VST quick control** via your MIDI device.

Mixer

Allows you to control **MixConsole** functions. If you select one of the available channels or **Selected** in the **Channel/Category** column and one of the options in the **Value/Action** column, you can control the function of that specific channel or of the selected channel via your MIDI device.

Transport

Allows you to control the transport functions. If you select **Device** in the **Channel/Category** column and one of the options in the **Value/Action** column, you can control the function via your MIDI device.

Metronome

Allows you to control metronome functions. If you select **Device** in the **Channel/Category** column and one of the options in the **Value/Action** column, you can control the function via your MIDI device.

VST Mixer

Allows you to control **MixConsole** functions. If you select one of the available channels or **Selected** in the **Channel/Category** column and one of the options in the **Value/Action** column, you can control the function of that specific channel or of the selected channel via your MIDI device.

NOTE

You can also control all **VST Instruments** that you added in the **Project** window and that are listed in the **Device** column.

Assigning MIDI Messages in Learn Mode

You can assign MIDI messages in **Learn** mode.

PROCEDURE

1. Select **Studio > Studio Setup**.
 2. In the **Devices** list, select **Generic Remote**.
 3. Activate **Learn**.
 4. Select the control in the upper table, and move the corresponding control on your MIDI device.
-

RESULT

The values for **MIDI Status**, **MIDI Channel**, and **Address** are automatically set to those of the moved control.

NOTE

If you use the **Learn** function for a control that sends a program change value, **Prog. Change Trigger** is automatically selected in the **MIDI Status** pop-up menu. This allows you to use the different values of a program change parameter to control different parameters in Cubase.

If this does not produce the expected results, try using the **Prog. Change** value instead.

MIDI Realtime Parameters

MIDI realtime means that you can change or transform MIDI events on MIDI or instrument tracks before they are sent to the MIDI outputs. This allows you to change the way MIDI data is played back.

The actual MIDI events on the track are not affected. Therefore, MIDI realtime changes are not reflected in any MIDI editor.

The following functions allow you to change MIDI events in real time:

- MIDI track parameters
- MIDI modifiers
- **Transpose** and **Velocity** on the info line

NOTE

To convert the track settings to real MIDI events, select **MIDI > Freeze MIDI Modifiers** or **MIDI > Merge MIDI in Loop**.

RELATED LINKS

[Merging MIDI Events into a New Part](#) on page 603

MIDI Track Parameters

The MIDI track parameters are located in the topmost **Inspector** section for MIDI and instrument tracks.

These settings either affect the basic functionality of the track (mute, solo, enable record, etc.) or send out additional MIDI data to the connected devices (program change, volume, etc.).

The following track parameters allow you to change MIDI events in real time:

- MIDI Volume
- MIDI Pan
- Track Delay

RELATED LINKS

[MIDI Track Inspector](#) on page 116

MIDI Modifiers

MIDI modifiers allow you to modify MIDI events during playback.

You can use them for the following purposes:

- To modify already existing MIDI events on MIDI or instrument tracks.
- To modify MIDI events that you play live.

NOTE

When playing live, select and record-enable the track, and activate **MIDI Thru Active** in the **Preferences** dialog (**MIDI** page).

MIDI Modifiers Section

- To open the **MIDI Modifiers** section, select a MIDI track, and, in the **Inspector**, click **MIDI Modifiers**.

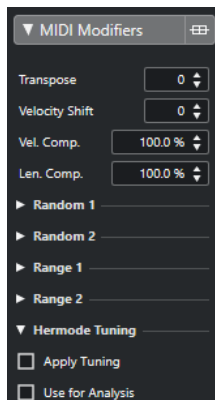

NOTE

To compare the result of your modifier settings with the unprocessed MIDI, you can use the bypass button in the MIDI modifiers section. If this button is activated, the MIDI modifiers settings are temporarily disabled.



Transpose

Allows you to transpose all notes on the track in semitones. Extreme transpositions can produce rather strange and unwanted results.

Velocity Shift

Allows you to add a velocity value to all notes on the track. Positive values increase the velocity while negative values lower the velocity.

Length Compression

Allows you to add a multiplier to the length of all notes on the track. The value is set with a numerator and a denominator.

Velocity Compression

Allows you to add a multiplier to the velocity of all notes on the track. The value is set with a numerator and a denominator. This parameter also affects the velocity differences between the notes, thus compressing or expanding the velocity scale. Values smaller than 1/1 compress the velocity range. Values greater than 1/1 together with negative **Velocity Shift** values expand the velocity range.

IMPORTANT

The maximum velocity is 127, no matter how much you try to expand.

NOTE

Combine this setting with the **Velocity Shift** parameter.

Random 1/Random 2

Allows you to introduce random variations to various properties of MIDI notes.

Range 1/Range 2

Allows you to specify a pitch or velocity range and to either force all notes to fit within this range or to exclude all notes outside this range from playback.

HMT: Apply Tuning

Activate this option to apply Hermode tuning to the notes played on this track.

HMT: Use for Analysis

Activate this option to use the notes you played on this track to calculate retuning.

RELATED LINKS

[Musical Scale Setup Dialog](#) on page 713

Setting up Random Variations

You can set up random variations for position, pitch, velocity, and length of MIDI events using one or two random generators.

PROCEDURE

1. Select a MIDI or instrument track.
 2. In the **Inspector**, open the **MIDI Modifiers** section.
 3. Open one of the **Random** sections and in the **Random Target** pop-up menu, select the note property you want to randomize.
 4. Specify the limits of the randomization in the value fields.
The values vary between the minimum and maximum value. You cannot set the minimum value higher than the maximum value.
 5. Optional: Repeat for other random values.
 6. Play back the track to listen to the randomized events.
-

RESULT

The corresponding properties are randomized.

NOTE

Depending on the track content, certain changes might not be immediately noticeable or might have no effect at all.

AFTER COMPLETING THIS TASK

Deactivate the random function by opening the **Random Target** pop-up menu and selecting **Off**.

Setting up Ranges

You can filter out pitches or velocities that do not match a specified range, or you can force them to fit a specified range.

PROCEDURE

1. Select a MIDI or instrument track.
2. In the **Inspector**, open the **MIDI Modifiers** section.
3. Open one of the **Range** sections, and in the **Range Target** pop-up menu and select a mode.
4. Set the minimum and maximum values with the two fields to the right.

NOTE

You can make independent settings for the two **Range** sections.

AFTER COMPLETING THIS TASK

To deactivate the function, open the **Range Target** pop-up menu, and select **Off**.

Range Modes

The **Range Target** pop-up menu offers different range modes to choose from. Values are displayed as numbers, from 0 to 127, for the velocity modes, and as note numbers, from C-2 to G8, for the pitch modes.

Vel. Limit

Allows you to force all velocity values to fit within the range that you specified by setting **min** and **max** values. Values below the lower limit are set to the **min** value, velocity values above the higher setting are set to the **max** value.

Vel. Filter

Allows you to filter out notes with velocity values below the **min** value or above the **max** value.

Note Limit

Allows you to transpose all notes below the **min** value upwards and all notes above the **max** value downwards in octave steps.

Note Filter

Allows you to filter out notes that are lower than the **min** value or higher than the **max** value.

Applying Hermode Tuning

Hermode tuning changes the tuning of the notes that you play. It creates clear frequencies for every fifth and third interval, for example. Retuning only affects individual notes and maintains the pitch relationship between keys and notes. Retuning is a continuous process and takes the musical context into account.

PROCEDURE

1. Select a MIDI or instrument track.
2. In the **Inspector**, open the **MIDI Modifiers** section.
3. Open the **Hermode Tuning** section and activate **Apply Tuning**.
4. Activate **Use for Analysis** to use the notes you play to calculate retuning.

NOTE

If you use tracks with acoustic piano, activate **Use for Analysis**, and deactivate **Apply Tuning**. This excludes the piano from being tuned, as this would sound unnatural.

5. Select **Project > Project Setup** to open the **Project Setup** dialog.
6. Open the **HMT Type** pop-up menu, and select one of the options.
7. Play some notes.

It may take a moment until all notes are recalculated and you can listen to the results of the retuning.

NOTE

Notes that are produced by MIDI plug-ins are not taken into account.

RESULT

If you use a VST 3 instrument that supports Micro Tuning and Note Expression, notes are retuned dynamically while you play them. With VST instruments that support Note Expression, this also works in **MIDI Thru** mode.

If you use a track with a loaded VST 2 instrument, the notes you play are retuned on every keystroke.

RELATED LINKS

[Hermodé Tuning](#) on page 593

Hermodé Tuning

You can select different Hermodé tuning types.

- To select a Hermodé tuning type, select **Project > Project Setup**, and select an option from the **HMT Type** pop-up menu.

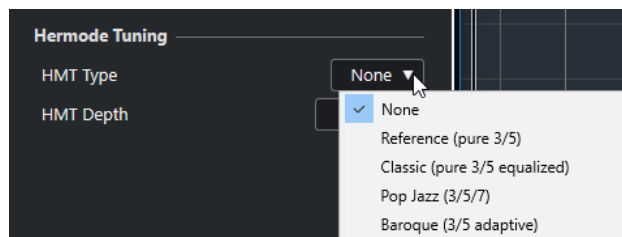

The following options are available:

None

No tuning is applied.

Reference (pure 3/5)

Tunes pure thirds and fifths.

Classic (pure 3/5 equalized)

Tunes pure thirds and fifths. In conflict situations, a slight equalization is applied. This tuning type is suitable for all kinds of music.

Pop Jazz (3/5/7)

Tunes pure thirds and fifths, as well as natural sevenths. This tuning type should not be applied to polyphonic music. Try this with pop or jazz.

Baroque (3/5 adaptive)

Tunes pure thirds and fifths. The degree of purity changes according to the sequence of harmonies. This tuning type is suitable for church organ and polyphonic music.

Freezing MIDI Modifiers

You can apply all filter settings permanently to the selected track. The settings are applied to the events on the track, and all modifiers are set to zero.

PROCEDURE

1. Select the MIDI track.
 2. Select **MIDI > Freeze MIDI Modifiers**.
-

RESULT

The following settings are frozen:

- Several settings in the top section of the **Inspector**, such as **Delay**, **Program Selector**, and **Bank Selector**.
- The settings in the **MIDI Modifiers** section, such as **Transpose**, **Vel. Shift**, **Vel. Comp.**, and **Len. Comp.**.
- The info line settings **Transpose** and **Velocity**.

RELATED LINKS

[MIDI Track Inspector](#) on page 116

Transpose and Velocity on the Info Line

You can edit the transposition and the velocity for selected MIDI parts on the info line. This only affects the notes in playback.

- Use the **Transpose** field to transpose the selected parts in semitone steps.
The value is added to the transposition set for the entire track.
- Use the **Velocity** field to offset the velocity for the selected parts.
The value is added to the velocities of the notes in the parts.

Using MIDI Devices

The **MIDI Device Manager** allows you to work with MIDI devices, that is, representations of external MIDI hardware.

You can install preset MIDI devices or define new ones. This is useful for global control and patch selection.

Program Change Messages and Bank Select Messages

To select a patch, that is, a sound in your MIDI device you must send a program change message to that device.

Program Change Messages

You can record program change messages, or enter them in a MIDI part. You can open the **Inspector** for the MIDI track and select a value in the **Program Selector** field.

Program change messages allow you to select between 128 different patches in your MIDI device.

Bank Select Messages

Many MIDI instruments, however, contain a larger number of patch locations. To make these available from within Cubase, you must send bank select messages.

Bank select messages allow you to select between 128 different programs in your MIDI device.

If your device supports MIDI bank select, you can open the **Inspector** for the MIDI track and select a value in the **Bank Selector** field to select a bank, and then use the **Program Selector** field to select a program in this bank.

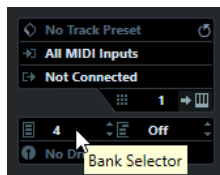

Unfortunately, different instrument manufacturers use different schemes for how bank select messages are constructed, which can lead to some confusion and make it hard to select the correct sound. Also, selecting patches by numbers seems unnecessarily cumbersome, when most instruments use names for their patches nowadays.

The **MIDI Device Manager** allows you to specify which MIDI devices you are using, and to select to which device each MIDI track is routed. This allows you to select patches by name in the track list or **Inspector**.

RELATED LINKS

[MIDI Device Manager](#) on page 596

Patch Banks

The **Patch Banks** list can have two or more main banks, depending on the selected device.

This is due to the fact that different types of patches are handled differently in the instruments. Patches, for example, typically are regular programs that you play one at a time. Performances, however, may be combinations of programs, which could be split across the keyboard, layered, or used for multitimbral playback, and so on.

For devices with several banks you can select **Bank Assignment** to specify which bank a specific MIDI channel should use.

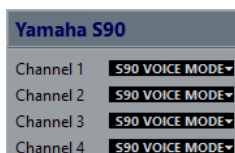

The **Bank Assignment** affects which bank is displayed when you select programs by name for the device in the track list or **Inspector**.

Many instruments use MIDI channel 10 as an exclusive drum channel, for example. If this is the case, select the **Drums** or **Rhythm Set** or **Percussion** bank for channel 10 in this list. This allows you to choose between different drum kits in the track list or **Inspector**.

MIDI Device Manager

The **MIDI Device Manager** allows you to install preset MIDI devices or define new ones.

- To open the **MIDI Device Manager**, select **Studio > More Options > MIDI Device Manager**.

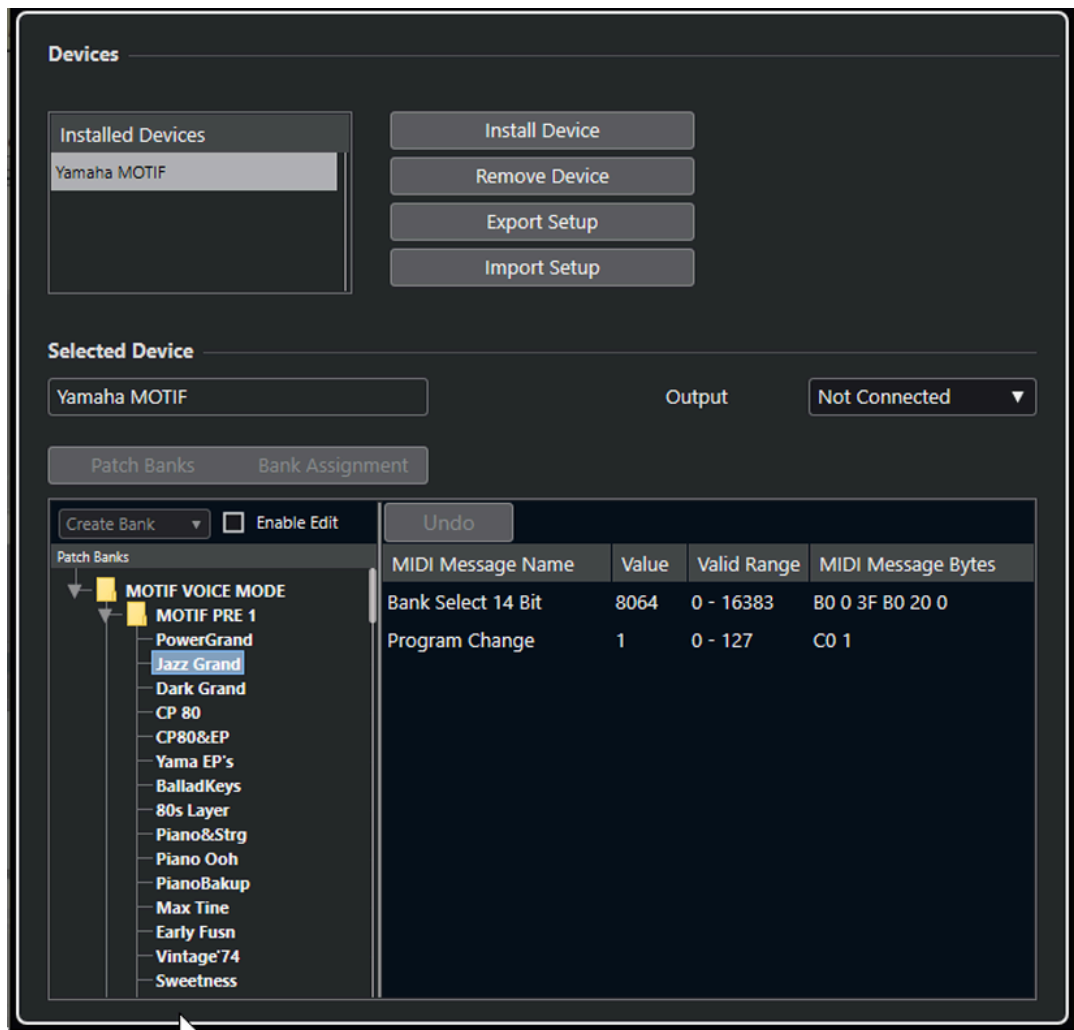

Installed Devices list

Lists the connected MIDI devices and the imported device setups.

Install Device

Allows you to install a preset device. These presets are simple patch name scripts that do not include any device mapping of parameters and controls and no graphic panels.

For more information about patch name scripts, see the separate document **MIDI Devices**.

Remove Device

Removes the selected device.

Export Setup

Exports the MIDI device setup as XML file.

Import Setup

Allows you to import an XML file of a MIDI device setup. Device setups can include device mapping, and/or patch information. Device setups are also added to the list of installed devices when imported.

Output

Allows you to select a MIDI output for the selected device.

Enable Edit

Activate this to enable the editing of the selected device.

Commands

Allows you to edit the selected device. The patch structure for the selected device is shown to the left.

MIDI Messages

Shows which MIDI messages are sent out to select the patch that is highlighted in the list to the left.

Commands for Patches

In the **MIDI Device Manager**, patches can be structured in banks, folders, and presets.

NOTE

Activate **Enable Edit** to use the commands pop-up menu for the selected device.

The commands pop-up menu contains the following items:

Create Bank

Creates a new bank in the **Patch Banks** list. You can rename this by clicking on it and typing a new name.

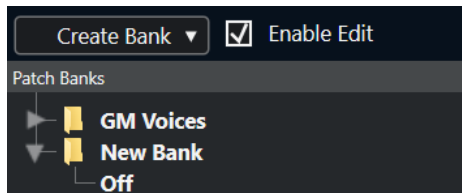

If you specify more than one bank, a **Bank Assignment** button is added next to the **Patch Banks** button.

New Folder

Creates a new subfolder in the selected bank or folder. This could correspond to a group of patches in the MIDI device, or just be a way for you to categorize sounds.

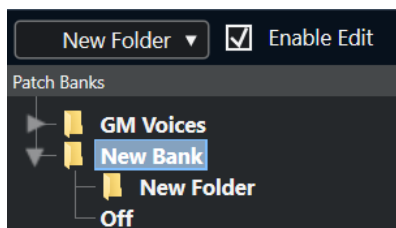

New Preset

Adds a new preset in the selected bank or folder. If you select it, the corresponding MIDI events are shown to the right. The default program change value for a new preset is 0, but you can adjust the number in the **Value** column.

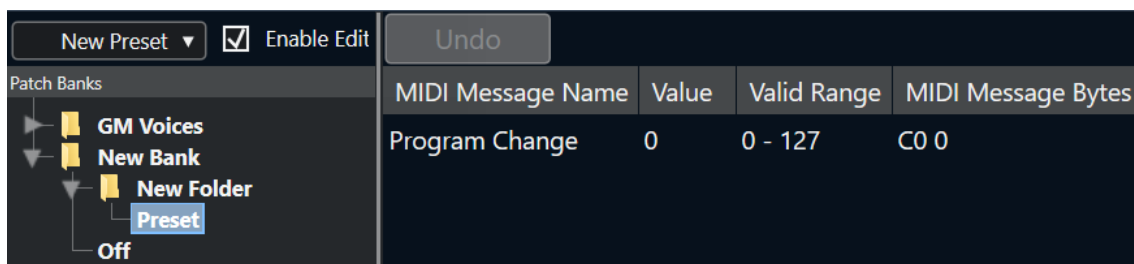

You can move presets between banks and folders via drag and drop.

Add Multiple Presets

Allows you to set up a range of presets and add them to the selected bank or folder.

NOTE

You can remove banks, folders, and presets by selecting them and pressing **Backspace**.

IMPORTANT

For details on which MIDI events are used for selecting patches in the MIDI device, consult its documentation.

RELATED LINKS

[Add Preset Functions](#) on page 599

[Patch Banks](#) on page 596

Add Preset Functions

If you add or select a preset for the selected bank or folder, further functions become available to the right. If you add multiple presets, the **Add Multiple Presets** dialog opens with further functions.

The following columns are available:

MIDI Message Name

The name of the MIDI message.

- To change an event, click it, and select another option from the pop-up menu.
- To add another event, click below the last event, and select an option from the pop-up menu.
- To remove an event, select it and press **Delete** or **Backspace**.

IMPORTANT

If you insert a **Bank Select** event, keep in mind that, depending on your device, you must choose **CC: BankSelect MSB**, **Bank Select 14 Bit**, **Bank Select 14 Bit MSB-LSB Swapped** or some other option.

Value

The value of the event.

MIDI Message Bytes

The message bytes of the event.

Valid Range

The valid range of the event.

Default Name

For multiple presets you can specify a default name. The added events will get this name, followed by a number.

Installing Preset MIDI Devices

You can install preset MIDI devices, that is, patch name scripts that do not include device mapping.

PROCEDURE

1. Select **Studio > More Options > MIDI Device Manager**.
 2. Click **Install Device**.
 3. In the **Add MIDI Device** dialog, do one of the following:
 - Select the script of the device in the list.
 - Select **GM Device** or **XG Device** if your device is not listed, but compatible with these standards, and type in the name of your instrument in the next dialog.
 4. Click **OK**.
 5. Select the device in the **Installed Devices** list, and open the **Output** pop-up menu.
 6. Select the MIDI output that the device is connected to.
-

RESULT

The structure of the patch name script is shown. It usually has one or several layers of banks or groups with patches.

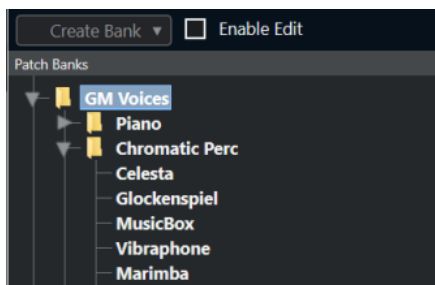

Selecting Patches for Installed Devices

If you installed a device and you select it from the **Output Routing** pop-up menu for the MIDI track, you can select patches by name.

PROCEDURE

1. Select the MIDI track that you want to associate to the installed device, and open the top section of the **Inspector**.
2. Open the **Output Routing** pop-up menu, and select the installed device.
This routes the MIDI track to the MIDI output specified for the device in the **MIDI Device Manager**. The **Bank Selector** and the **Program Selector** fields are replaced by a single **Program Selector** field that reads **Off**.
3. Open the **Program Selector**.
A program list, similar to the one in the **MIDI Device Manager**, is shown.

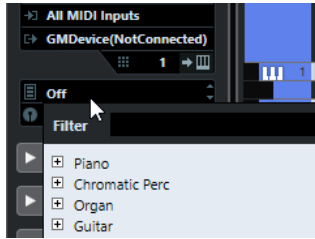

4. Select an entry in the list.
-

RESULT

The corresponding MIDI message is sent to the device.

Renaming Patches in Devices

If you have replaced some of the factory presets with your own patches, you can modify the device so that the patch name list matches the actual device.

PROCEDURE

1. Select **Studio > More Options > MIDI Device Manager**.
 2. Select the device in the **Installed Devices** list.
Make sure that the **Patch Banks** tab is selected.
 3. Activate **Enable Edit**.
 4. In the **Patch Banks** list, locate the patch you want to rename and click the name.
 5. Type in the new name and press **Return**.
-

RESULT

The patch is renamed.

AFTER COMPLETING THIS TASK

To avoid modifying the device by accident, deactivate **Enable Edit**.

Defining New MIDI Devices

You can define new MIDI devices.

PROCEDURE

1. Select **Studio > More Options > MIDI Device Manager**.
 2. Click **Install Device**.
 3. In the **Add MIDI Device** dialog, select **Define New**.
 4. Click **OK**.
 5. In the **Create New MIDI Device** dialog, enter the name of the device and activate the MIDI channels that you would like to use.
 6. Click **OK**.
 7. Select the device in the **Installed Devices** list.
 8. Activate **Enable Edit** and use the commands pop-up menu to organize the patch structure of the new device.
-

MIDI Functions

MIDI functions allow you to permanently edit MIDI events or MIDI parts in the **Project** window or from within a MIDI editor.

Which events are affected when you use a MIDI function depends on the function, the active window, and the current selection:

- In the **Project** window, the MIDI functions apply to all selected parts, affecting all events of the relevant types in them.
- In the MIDI editors, MIDI functions apply to all selected events. If no events are selected, all events in the edited parts are affected.

NOTE

Some MIDI functions only apply to MIDI events of a certain type. For example, **Delete Controllers** only applies to MIDI controller events.

RELATED LINKS

[MIDI Realtime Parameters](#) on page 589

Transpose Setup Dialog

The **Transpose Setup** dialog contains settings for transposing the selected events.

- To open the **Transpose Setup** dialog, select the MIDI notes that you want to transpose, and select **MIDI > Transpose Setup**.

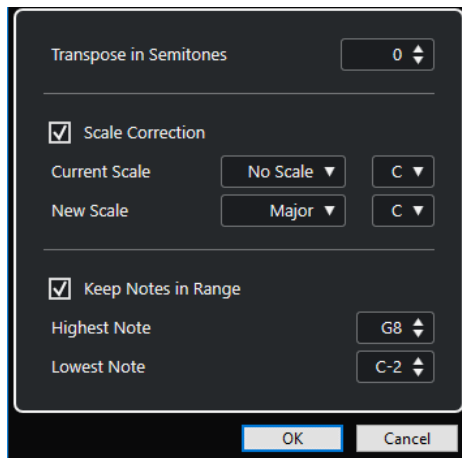

The following settings are available:

Transpose in Semitones

Sets the amount of transposition.

Scale Correction

Transposes the selected notes to the closest note of a specific scale type. This allows you to change the key and the tonality.

- Select a root note and a scale type for the current scale in the **Current Scale** pop-up menus.
- Select a root note and a scale type for the new scale in the **New Scale** pop-up menus.

NOTE

If the new root note differs from the current root note, this leads to an entirely different key.

Keep Notes in Range

Limits the transposition of notes to the note values that you specify with the **Highest Note** and **Lowest Note** settings.

NOTE

Notes that would be outside the range after transposition are shifted to another octave, keeping the correct transposed pitch if possible. If the range between the upper and lower limit is very narrow, the note is transposed as far as possible, that is, to notes specified with the **Highest Note** and **Lowest Note** values. If you set **Highest Note** and **Lowest Note** to the same value, all notes are transposed to this pitch.

RELATED LINKS

[Musical Scale Setup Dialog](#) on page 713

Merging MIDI Events into a New Part

You can merge all MIDI events into a new part, apply MIDI modifiers, and generate a new part.

PROCEDURE

1. Do one of the following:
 - Mute the tracks or parts that you do not want to include in the merge.
 - Solo the track that contains the events that you want to include in the merge.
2. Set up the left and right locators to encompass the area that you want to merge.

NOTE

Only events starting within this area will be included.

3. Optional: Select a track for the new part.
If you do not select a track, a new MIDI track is created. If several MIDI tracks are selected, the new part is inserted on the first selected track.
 4. Select **MIDI > Merge MIDI in Loop**.
 5. In the **MIDI Merge Options** dialog, make your changes.
 6. Click **OK**.
-

RESULT

A new part is created between the locators on the destination track, containing the processed MIDI events.

RELATED LINKS

[MIDI Merge Options Dialog](#) on page 604

[Freezing MIDI Modifiers](#) on page 594

MIDI Merge Options Dialog

- To open the **MIDI Merge Options** dialog, select a MIDI part, and select **MIDI > Merge MIDI in Loop**.

The following options are available:

Include Inserts

Applies MIDI modifiers.

Erase Destination

Deletes MIDI data between the left and right locators on the destination track.

Include Chase

Includes events placed outside the selected part but relating to it in the processing, for example, a program change right before the left locator.

Convert VST 3

Converts all VST 3 data within the selected area to MIDI data.

RELATED LINKS

[Chase](#) on page 208

Applying Effects to a Single Part

You can apply MIDI modifiers to a single part.

PROCEDURE

1. Set up your MIDI modifiers the way you want them for the part.
2. Set the locators to encompass the part.
3. In the track list, select the track with the part.
4. Select **MIDI > Merge MIDI in Loop**.
5. In the **MIDI Merge Options** dialog, activate **Erase Destination**.
6. Click **OK**.

RESULT

A new part is created on the same track, containing the processed events. The original part is deleted.

AFTER COMPLETING THIS TASK

Turn off or reset all MIDI modifiers, so that the track plays back as before.

Dissolve Part Dialog

You can separate MIDI events in a part according to channels or pitches and dissolve the part to different tracks or lanes.

- To open the **Dissolve Part** dialog, select the MIDI part you want to dissolve and select **MIDI > Dissolve Part**.

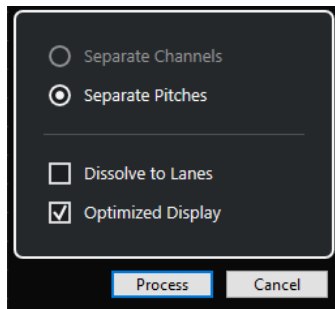

The following settings are available:

Separate Channels

Separates MIDI events according to their channel. This is useful for MIDI parts on MIDI channel **Any** that contain events on different MIDI channels.

Separate Pitches

Separates MIDI events according to their pitch. This is useful for drum and percussion tracks, where different pitches usually correspond to separate drum sounds.

Dissolve to Lanes

Dissolves the part to lanes.

Optimized Display

Automatically removes silent areas of the resulting parts.

NOTE

This option is not available when **Dissolve to Lanes** is activated.

Dissolving Parts into Separate Channels

You can dissolve MIDI parts that contain events on different MIDI channels, and distribute the events into new parts on new tracks, one for each MIDI channel found.

PROCEDURE

1. Select the parts that contain MIDI events on different channels.
 2. Select **MIDI > Dissolve Part**.
 3. Activate **Separate Channels**.
 4. Click **Process**.
-

RESULT

For each MIDI channel used in the selected parts, a new MIDI track is created and set to the corresponding MIDI channel. Each event is copied into the part on the track with the corresponding MIDI channel, and the original parts are muted.

MIDI Channel Setting

Setting a track to MIDI channel **Any** causes each MIDI event to play back on its original MIDI channel, rather than a channel set for the whole track.

There are two main situations when **Any** channel tracks are useful:

- When you record several MIDI channels at the same time.

You may for example have a MIDI keyboard with several keyboard zones, where each zone sends MIDI on a separate channel. Setting the channel to **Any** allows you to play back the recording with different sounds for each zone (since the different MIDI notes play back on separate MIDI channels).

- When you have imported a MIDI file of Type 0.
MIDI files of Type 0 contain only one track, with notes on up to 16 different MIDI channels. If you were to set this track to a specific MIDI channel, all notes in the MIDI file would be played back with the same sound. Setting the track to **Any** causes the imported file to play back as intended.

Dissolving Parts into Separate Pitches

You can dissolve MIDI parts that contain events of different pitches and distribute the events into new parts on new tracks, one for each MIDI pitch found. This is useful if the different pitches are used for separating different sounds such as MIDI drum tracks or sampler sound FX tracks. By dissolving such parts, you can work with each sound individually, on a separate track.

PROCEDURE

1. Select the parts that contain MIDI events of different pitches.
2. Select **MIDI > Dissolve Part**.
3. Activate **Separate Pitches**.
4. Click **Process**.

RESULT

For each MIDI pitch used in the selected parts, a new MIDI track is created. Each event is copied into the part on the track for the corresponding pitch, and the original parts are muted.

Repeating MIDI Events of Independent Track Loops

You can repeat the MIDI events inside an independent track loop to fill up a MIDI part. This is useful if you want to convert the events of an independent track loop to actual MIDI events.

PREREQUISITE

You have set up an independent track loop and the **Key Editor** is open. The part ends after the end of the independent track loop.

PROCEDURE

- Select **MIDI > Repeat Loop**.

RESULT

The events of the independent track loop are repeated to the end of the part. Events that are located to the right of the independent track loop in the part are replaced.

RELATED LINKS

[Setting up the Independent Track Loop](#) on page 418

Extending MIDI Notes

You can extend MIDI notes so that they reach the next notes.

PREREQUISITE

A MIDI part with some note events is open in the **Key Editor**.

PROCEDURE

1. Select the note events that you want to extend to the next notes.
 2. Select **MIDI > Functions > Legato**.
-

RESULT

The selected note events are extended to the start of the next notes.

NOTE

To specify a gap or overlap for this, adjust the **Legato Overlap** setting in the **Preferences** dialog (**Editing—MIDI** page).

RELATED LINKS

[Key Editor Inspector](#) on page 652

Fixing MIDI Note Lengths

You can set the length of selected MIDI notes to the **Length Quantize** value.

PREREQUISITE

A MIDI part with some note events is open in the **Key Editor**.

PROCEDURE

1. On the **Key Editor** toolbar, open the **Length Quantize** pop-up menu and select the desired note length.
 2. Select the note events that you want to fix.
 3. Select **MIDI > Functions > Fixed Lengths**.
-

RESULT

The selected note events are set to the specified **Length Quantize** value.

RELATED LINKS

[Key Editor Toolbar](#) on page 645

Fixing MIDI Note Velocities

You can set the velocity of selected MIDI notes to the **Note Insert Velocity** value.

PREREQUISITE

A MIDI part with some note events is open in the **Key Editor**.

PROCEDURE

1. On the **Key Editor** toolbar, open the **Set up Insert Velocities** pop-up menu and select a velocity value.
 2. Select the note events that you want to fix.
 3. Select **MIDI > Functions > Fixed Velocity**.
-

RESULT

The selected note events are set to the specified **Note Insert Velocity** value.

RELATED LINKS

[Key Editor Toolbar](#) on page 645

MIDI Insert Velocities Dialog

- To open the **MIDI Insert Velocities** dialog, open the **Set up Insert Velocities** pop-up menu in the **Key Editor** toolbar, and select **Setup**.

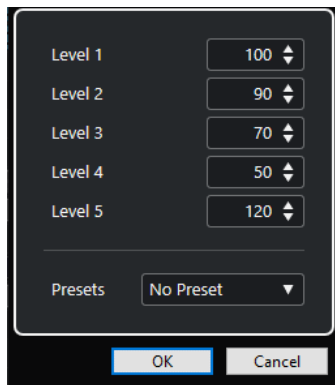

Level fields

Allow you to set the velocity values that are shown in the **Set up Insert Velocities** pop-up menu.

Presets

Allows you to save velocity values as presets.

RELATED LINKS

[Key Editor Toolbar](#) on page 645

[Fixing MIDI Note Velocities](#) on page 607

[Velocity Dialog](#) on page 609

Rendering Sustain Pedal Data to Note Lengths

You can render sustain pedal data to note lengths. This is useful if you recorded MIDI data with a MIDI keyboard and a sustain pedal, and you want to extend the actual MIDI notes for as long as you held the pedal, in order to edit the notes later.

PREREQUISITE

You recorded MIDI using a MIDI keyboard and a sustain pedal. The MIDI part is open in the **Key Editor**.

PROCEDURE

1. Select the note events.
 2. Select **MIDI > Functions > Pedals to Note Length**.
-

RESULT

The selected notes are lengthened to match the sustain pedal off position, and the sustain controller on/off events are removed.

Deleting Overlaps

You can delete overlaps of notes that have the same or different pitches. This is useful if your MIDI instruments cannot handle overlapping events.

PROCEDURE

1. Select the note events.
 2. Do one of the following:
 - Select **MIDI > Functions > Delete Overlaps (mono)**.
 - Select **MIDI > Functions > Delete Overlaps (poly)**.
-

RESULT

The overlapping MIDI notes are shortened, so that no note begins before another ends.

Editing Velocity

You can manipulate the velocity of notes.

PROCEDURE

1. Select the note events.
 2. Select **MIDI > Functions > Velocity**.
 3. Open the **Type** pop-up menu and select an option.
 4. Depending on the **Type**, enter a **Ratio**, an **Amount** or an **Upper** and **Lower** value.
 5. Click **OK**.
-

RESULT

The note velocities are changed according to your settings.

RELATED LINKS

[Velocity Dialog](#) on page 609

Velocity Dialog

- To open the **Velocity** dialog, select a MIDI part, and select **MIDI > Functions > Velocity**.

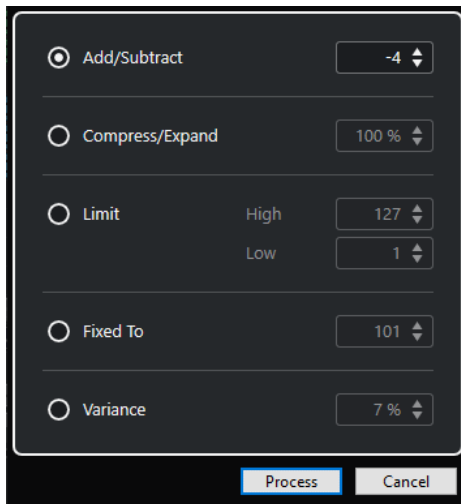

Add/Subtract

Adds the specified value to the velocity value. You can enter positive or negative values.

Compress/Expand

Compresses or expands the dynamic range of MIDI notes by the specified value. You can enter values from 0 to 300 %. A factor higher than 1 (over 100 %) expands the differences between velocity values, while using a factor lower than 1 (under 100 %) compresses them.

- To compress the dynamic range, use ratio values below 100 %.
After compression, you can add a velocity amount to maintain the average velocity level.
- To expand the dynamic range, use ratio values above 100 %.
Before expansion, you can adjust the velocity to the middle of the range.

Limit

Limits the velocity values so that they stay between the **Low** and the **High** values.

Fixed To

Fixes the velocity value to the specified value.

Variance

Sets the velocities to a value between the current velocity value and a lower value. You can specify the percentage of variance.

RELATED LINKS

- [Key Editor Toolbar](#) on page 645
- [MIDI Insert Velocities Dialog](#) on page 608
- [Fixing MIDI Note Velocities](#) on page 607

Deleting Double Notes

You can delete double notes of the same pitch on the exact same position from selected MIDI parts. Double notes can occur when recording in cycle mode, after quantizing, for example.

PROCEDURE

1. Select the MIDI part that contains the double notes.

2. Select **MIDI > Functions > Delete Doubles**.
-

RESULT

The double notes are automatically deleted.

Deleting Controller Data

You can delete controller data from selected MIDI parts.

PROCEDURE

1. Select the MIDI parts that contain the controller data.
 2. Select **MIDI > Functions > Delete Controllers**.
-

RESULT

The controller data is automatically deleted.

Deleting Continuous Controller Data

You can delete continuous controller data from selected MIDI parts.

PROCEDURE

1. Select the MIDI parts that contain the controller data.
 2. Select **MIDI > Functions > Delete Continuous Controllers**.
-

RESULT

The continuous controller data is automatically deleted. However, On/Off events, such as sustain pedal events, are kept.

Restricting Polyphonic Voices

You can restrict polyphonic voices in selected MIDI notes or parts. This is useful if you have an instrument with limited polyphony and want to make sure all notes are played.

PROCEDURE

1. Select the MIDI notes or parts that contain the voices.
 2. Select **MIDI > Functions > Restrict Polyphony**.
 3. Specify how many voices you want to use.
 4. Click **OK**.
-

RESULT

The notes are shortened as required, so that they end before the next note starts.

Thinning Out Controller Data

You can thin out controller data in selected MIDI parts. Use this to ease the load on your external MIDI devices if you have recorded very dense controller curves.

PROCEDURE

1. Select the MIDI parts that contain the controllers that you want to thin out.
2. Select **MIDI > Functions > Thin Out Data**.

RESULT

The controller data is thinned out.

Extracting MIDI Automation

You can convert continuous controllers of your recorded MIDI parts into MIDI track automation data, so that you can edit them in the **Project** window.

PROCEDURE

1. Select the MIDI part that contains the continuous controller data.
2. Select **MIDI > Functions > Extract MIDI Automation**.
3. Right-click the MIDI or instrument track in the **Project** window and select **Show Used Automation (Selected Tracks)**.

This shows the MIDI controller data on the automation track.

RESULT

In the **Project** window, an automation track is created for each of the continuous controllers in the MIDI part.

In the MIDI editors, the controller data is removed from the controller lane.

NOTE

This only works for continuous controllers. Data such as aftertouch, pitchbend, or SysEx cannot be converted to MIDI track automation data.

Reversing the Playback Order of MIDI Events

You can invert the order of the selected events or of all events in selected part rhythmically. This causes the MIDI to play backwards. However, this is different from reversing an audio recording. The individual MIDI notes still play as usual, but the playback order changes.

PROCEDURE

1. Select the MIDI events or the MIDI part.
2. Select **MIDI > Functions > Reverse**.

RESULT

The playback order of the events is reversed while the individual notes still play as usual in the MIDI instrument. Technically, this function reverses the note-on message of a note within a part or selection.

Inverting the Order of Selected MIDI Events

This function inverts the order of the selected events, or of all events in the selected parts, graphically. Technically, this function turns a note-on message into a note-off message and vice versa, which can lead to rhythmic inaccuracies if the note-off position of a note has not been quantized.

PROCEDURE

1. Select the MIDI events or the MIDI part.
 2. Select **MIDI > Functions > Mirror**.
-

RESULT

The order of the events is inverted while the individual notes still play as usual in the MIDI instrument. Technically, this function turns a note-on message into a note-off message and vice versa which can lead to rhythmic inaccuracies if the note-off position of a note has not been quantized.

MIDI Editors

There are several ways to edit MIDI in Cubase. You can use the tools and functions in the **Project** window for large-scale editing or the functions on the **MIDI** menu to process MIDI parts in various ways. To manually edit your MIDI data on a graphical interface, you can use the MIDI editors.

- The **Key Editor** presents notes graphically in a piano roll-style grid. The **Key Editor** also allows for detailed editing of non-note events such as MIDI controllers.
- The **Drum Editor** is similar to the **Key Editor**, but each key corresponds to a separate drum sound.
You can use the **Drum Editor** to edit drum or percussion parts.
- The **Score Editor** shows MIDI notes as a musical score and offers basic score editing and printing.

RELATED LINKS

[Key Editor](#) on page 643

[Drum Editor](#) on page 685

[Score Editor](#) on page 672

Common MIDI Editor Functions

You can use the tools and functions within the MIDI editors to process MIDI parts in various ways.

Changing the Ruler Display Format

You can change the display format for the ruler. By default, the ruler shows the timeline in the display format that is selected on the **Transport** panel.

PROCEDURE

- Click the arrow button to the right of the ruler and select an option from the pop-up menu.
-

RELATED LINKS

[Ruler Display Format Menu](#) on page 44

Zooming in MIDI Editors

The MIDI editors provide several zooming options:

- The zoom sliders.

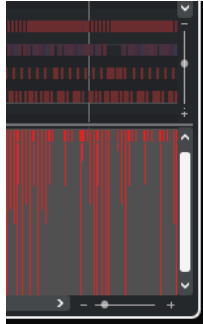

- The **Zoom** tool.
- The **Zoom** submenu in the **Edit** menu.

When you use the **Zoom** tool for zooming, you can determine if you want to zoom horizontal only or horizontal and vertical at a time.

- To activate/deactivate the corresponding option, activate/deactivate **Zoom Tool Standard Mode: Horizontal Zooming Only** in the **Preferences** dialog (**Editing—Tools** page).

Using Cut and Paste

You can use the **Cut**, **Copy**, and **Paste** options from the **Edit** menu to move or copy material within a part or between different parts.

- To insert note events at the project cursor position without affecting existing notes, select **Edit > Paste**.
- To insert note events at the project cursor position, move, and if necessary split the existing note events to make room for the pasted notes, select **Edit > Range > Paste Time**.

Handling Note Events

Event Colors Menu

You can select different color schemes for the note events in the MIDI editor.

- To open the **Event Colors** pop-up menu, click **Event Colors** on the toolbar.

The following options are available:

Velocity

The note events get different colors depending on their velocity values.

Pitch

The note events get different colors depending on their pitch.

Channel

The note events get different colors depending on their MIDI channel value.

Part

The note events get the same color as their corresponding part in the **Project** window. Use this option if you are working with 2 or more tracks in an editor, to see which note events belong to which track.

Grid Match

The note events get different colors depending on their time position. For example, this mode enables you to see if the notes of a chord start at the exact same beat.

Voice

The note events get different colors depending on their voice (soprano, alto, tenor, etc.).

Scale/Chords

The note events get different colors depending on whether they match the current chord, scale, or both.

For all of the options except **Part** and **Sound Slot**, the pop-up menu also contains a **Setup** option. This option opens a dialog in which you can specify the colors that are associated with velocities, pitches, or channels.

RELATED LINKS

[Selecting Note Events](#) on page 618

[Color Picker](#) on page 80

[Event Colors Setup Dialog](#) on page 616

Event Colors Setup Dialog

The event colors setup dialogs allow you to set up colors for event properties such as velocities, pitches, channels, or chords and scales.

- To open the event colors setup dialog for the selected color scheme option, open the **Event Colors** pop-up menu in the **Key Editor** or **Drum Editor** toolbar, and select **Setup**.

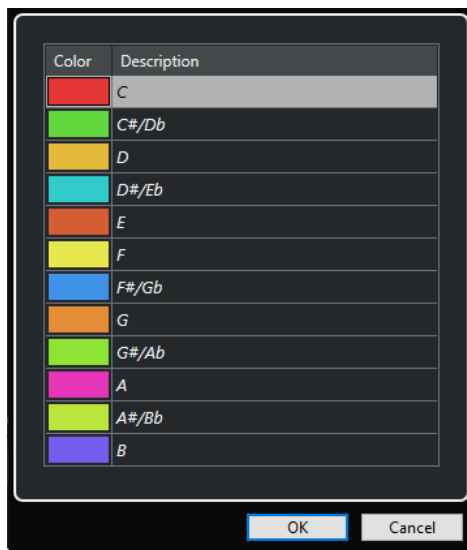

Pitch Color Setup dialog

The following options are available:

Color fields

Click a field to open the **Color Picker** that allows you to specify a new color.

Description

Shows further information about the usage of the color.

OK

Applies your changes and closes the dialog.

RELATED LINKS

[Event Colors Menu](#) on page 615

[Color Picker](#) on page 80

Pitch Colors Setup

You can set up Cubase to color events depending on their pitch. The color scheme is defined in the **Pitch Colors** setup dialog.

- To open the event **Pitch Colors** setup dialog, open the **Event Colors** pop-up menu in the **Key Editor** toolbar, activate **Pitch** and then select **Setup**.

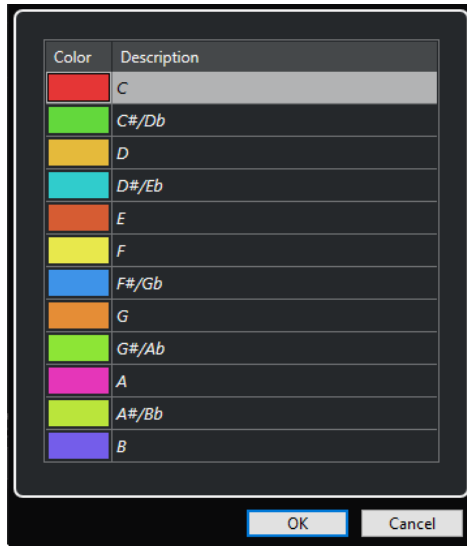

The following options are available:

Color fields

Click a field to open the **Color Picker** that allows you to specify a new color.

Description

Shows further information about the usage of the color.

OK

Applies your changes and closes the dialog.

RELATED LINKS





[Event Colors Menu](#) on page 615

[Color Picker](#) on page 80

Chord and Scale Colors Setup

You can set up Cubase to color events depending on whether they match the current chord, scale, or both. The color scheme is defined in the **Chord and Scale Colors** setup dialog.

- To open the event **Chord and Scale Colors** setup dialog, open the **Event Colors** pop-up menu in the **Key Editor** toolbar, activate **Scale/Chords** and then select **Setup**.

Color	Description
	<i>None: The pitch is not in the current chord or the current scale. This pitch adds a strong tension.</i>
	<i>Scale: The pitch is in the current scale but not in the current chord. A good pitch for melody that adds some tension.</i>
	<i>Chord: The pitch matches the current chord but is not in the current scale. Unusual - do the current chord and scale match?</i>
	<i>Chord & Scale: The pitch matches the current chord and scale. No added tension at all.</i>

The following options are available:

Color fields

Click a field to open the **Color Picker** that allows you to specify a new color.

Description

Shows further information about the usage of the color.

OK

Applies your changes and closes the dialog.

RELATED LINKS

[Event Colors Menu](#) on page 615

[Color Picker](#) on page 80

Selecting Note Events

The selected MIDI editor determines which of the following methods apply.

Do one of the following:

- Use the **Object Selection** tool to drag a selection rectangle around the note events that you want to select. You can also click individual events.
- Select **Edit > Select** and select one of the options.
- To select the previous or next note event, use the **Left Arrow / Right Arrow** key.
- To select several notes, press **Shift** and use the **Left Arrow / Right Arrow** key.
- To select all notes of a certain pitch, press **Ctrl/Cmd** and click on a key in the keyboard display to the left.
- To select all the following note events of the same pitch/staff, press **Shift** and double-click a note event.

NOTE

If you select the notes in the event display, the note event is shown in black and only its outline is shown in color. On the keyboard display, the keys that correspond to the note pitches of the selected notes are also shown in color.

RELATED LINKS

[Event Colors Menu](#) on page 615

[Select Submenu for Note Events](#) on page 619

[Editing](#) on page 828

Select Submenu for Note Events

The **Select** submenu offers you several options to select note events.

- To open the **Select** submenu for a note event, select the note event, and select **Edit > Select**.

All

Selects all note events in the edited part.

None

Deselects all note events.

Invert

Inverts the selection. All selected note events are deselected and all notes that were not selected are selected instead.

In Loop

Selects all note events that are partially or completely inside the boundaries of the left and right locators (only visible if locators are set).

From Start to Cursor

Selects all note events that begin to the left of the project cursor.

From Cursor to End

Selects all note events that end to the right of the project cursor.

Equal Pitch - all Octaves

Selects all note events of the highlighted part that have the same pitch (in any octave) as the selected note event.

NOTE

This function requires that a single note event is selected.

Equal Pitch - same Octave

Selects all note events of the highlighted part that have the same pitch (same octave) as the selected note event.

NOTE

This function requires that a single note event is selected.

Select Controllers in Note Range

Selects the MIDI controller data within the range of the selected note events.

RELATED LINKS

[Deleting Note Events](#) on page 620

Muting Note Events

You can mute individual note events in a MIDI editor. Muting individual notes allows you to exclude note events from playback.

Do one of the following:

- Click on a note event with the **Mute** tool.
- Drag a rectangle with the **Mute** tool, enclosing all note events that you want to mute.
- Select the note events and select **Edit > Mute**.
- To unmute a note event, click it or enclose it with the **Mute** tool. You can also select a note event and select **Edit > Unmute**.

Muted notes are dimmed in the note display.

Toggle Selections

- To toggle selected elements within a selection rectangle, press **Ctrl/Cmd** and enclose the same elements within a new selection rectangle.

Once you release the mouse button, the previous selection is deselected and vice versa.

Deleting Note Events

- To delete note events, click on them with the **Erase** tool or select them and press **Backspace**.

Delete Notes Dialog

The **Delete Notes** dialog allows you delete note events that do not match a specific length or velocity.

- To open the **Delete Notes** dialog, select a MIDI part in the **Project** window, and select **MIDI > Functions > Delete Notes**.

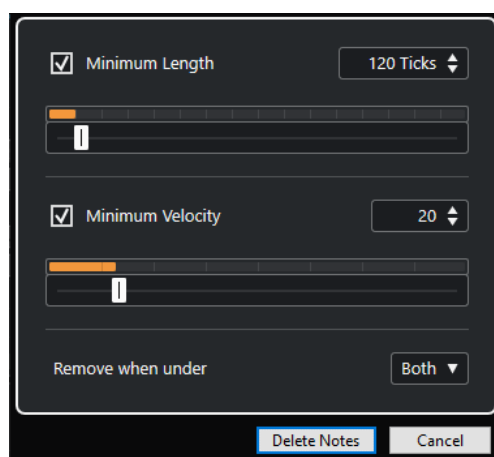

The following options are available:

Minimum Length

Allows you to set a minimum note length in ticks. Notes that are shorter than the set value are deleted. You can use the value field or the graphical length display. If

you click the field to the right of the graphical length display the scale for the display changes. You can set it to 1/4 bar, one bar, two bars or four bars.

Minimum Velocity

Allows you to set a minimum note velocity. Notes with a lower velocity than the set value are deleted.

Remove when under

This option is only available if **Minimum Velocity** and **Minimum Length** are both activated. It allows you to select if both or just one of the criteria must be met for notes to be deleted.

Trimming Note Events

The **Trim** tool allows you to cut off the end or the beginning of note events.

PROCEDURE

1. Select the **Trim** tool on the toolbar.
 2. Do one of the following:
 - To trim the end of a single note event, click on the note event.
 - To trim the beginning of a single note event, press **Alt** and click the note event.
 - To trim several note events, click and drag across the note events.
 - To set the same start and end time for all edited note events, press **Ctrl/Cmd** and vertically drag along the note events.
-

Editing Note Events on the Info Line

You can move, resize, or change the velocity of note events on the info line using regular value editing.

- To apply a value change to all selected note events, press **Ctrl/Cmd** and change a value on the info line.
- To adjust the pitch or velocity of note events via your MIDI keyboard, click in the **Pitch** or **Velocity** fields on the info line, and play a note on your MIDI keyboard.
If you have several note events selected and change a value, all selected events are changed by the set amount.

Duplicating and Repeating Note Events

You can duplicate and repeat note events in the same way as events in the **Project** window.

- To duplicate the selected note events, hold down **Alt/Opt** and drag the note events to a new position.
If **Snap** is activated, it determines to which positions you can copy notes.
- To copy the selected note events and place them directly behind the original, select **Edit > Functions > Duplicate**.
If several note events are selected, all of them are copied as one unit, maintaining the relative distance between the note events.
- To create a number of copies of the selected note events, select **Edit > Functions > Repeat**, specify the number, and click **OK**.

You can also press **Alt/Opt** and drag the right edge of the note events to the right to create copies of the note events.



Finding Exact Positions with Snap

The **Snap** function restricts horizontal movement and positioning to certain positions. This helps you find exact positions in the note display when editing note events in a MIDI editor. Affected operations include moving, duplicating, drawing, sizing, etc.

- To activate/deactivate snap, click **Snap**.
If you select the **Bars+Beats** display format, the snap grid is set by the quantize value on the toolbar. This makes it possible to snap to straight note values and to swing grids that have been set up in the **Quantize Panel**.
- If you select any of the other display formats, positioning is restricted to the displayed grid.

Setting Velocity Values

When you draw note events in the MIDI editor, the note events get the velocity value that is set in the **Note Insert Velocity** field on the toolbar. There are different methods to set the velocity.

- Use the **Edit Velocity** tool modifier. The cursor changes into a speaker, and next to the note, a field with the Note Velocity slider shows the value. Move the mouse pointer up or down to change the value.

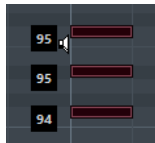

Value changes are applied to all selected notes.

For this, a tool modifier must be assigned for the **Edit Velocity** action. You can edit the tool modifier in the **Preferences** dialog (**Tool Modifiers** page).

- Open the **Note Insert Velocity** pop-up menu and select a velocity value.
On this menu, you can also select **Setup** and specify custom velocity values for the pop-up menu.
- Double-click the **Note Insert Velocity** field on the toolbar and enter a velocity value.
- Assign key commands to **Insert Velocity 1-5** and use them.
This allows you to quickly switch between different velocity values when you enter note events.

Handling Several MIDI Parts

- To activate a part for editing, open the **Activate Part for Editing** pop-up menu and select a part.
When you select a part from the list, it is automatically active and centered in the note display.
- To zoom in on an active part, select **Edit > Zoom > Zoom to Event**.
- To display defined borders for the active part, activate **Show Part Borders**.
If this option is activated, all parts, except the active part, are grayed out.

- To restrict editing operations to the active part, activate **Edit Active Part** in the **Part Editing Mode** pop-up menu.
- To change the size of the part, drag the part borders.
The part borders display the name of the active part.

NOTE

If the part that you open for editing is a shared copy, any editing that you perform affects all shared copies of this part. In the **Project** window, shared copies are indicated by an equal sign in the top right corner of the part.

Looping MIDI Parts

The **Independent Track Loop** function allows you to loop a MIDI part independent of the project playback.

When you activate the loop, the MIDI events within the loop are repeated continuously while other events on other tracks are played back as usual. Every time the cycle restarts, the independent track loop also restarts.

PROCEDURE

1. Activate **Independent Track Loop** on the toolbar.
If the button is not visible, right-click the toolbar and select **Independent Track Loop** from the context menu.
If you have set up a loop range in the **Project** window, it is hidden from the ruler in the MIDI editor.
 2. **Ctrl/Cmd**-click in the ruler to specify the start of the independent track loop.
 3. **Alt/Opt**-click in the ruler to specify the end of the independent track loop.
-

RESULT

The independent loop range is indicated in a different color.

The start and end of the loop range are displayed on the status line.

AFTER COMPLETING THIS TASK

To repeat the events of the loop range and fill up the active MIDI part, select **MIDI > Repeat Loop**.

Controller Display

The area at the bottom of the **Key Editor** and the **Drum Editor** is the controller display.

To show the controller display, do one of the following:

- Open the **Controller Lane Setup** pop-up menu in the **Key Editor**, or the **Drum Editor**, and select **Show/Hide Controller Lanes**.
- On the **Key Editor** or the **Drum Editor** toolbar, click **Set up Window Layout**, and activate **Controller Lanes**.

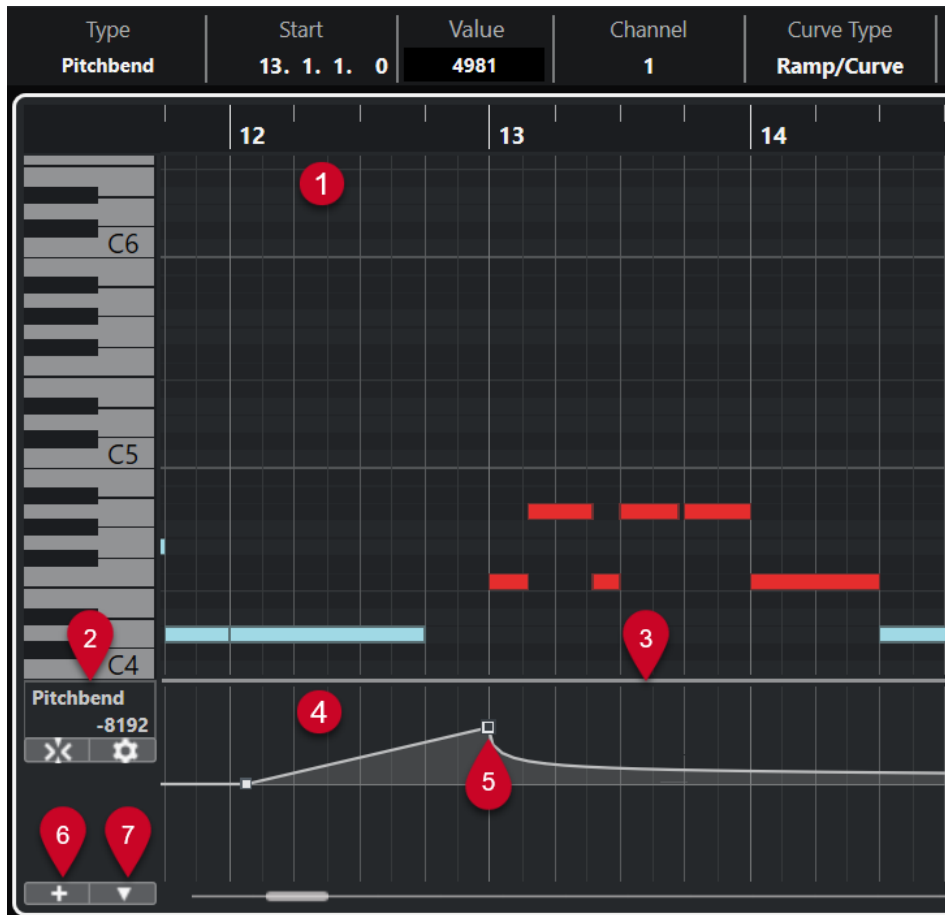

The following options are available:

1 Note display

Contains a grid in which MIDI notes are displayed as boxes.

2 Controller Selection and Functions menu

Allows you to select which controller type is displayed, and contains editing functions for controller lanes and events.

3 Divider

Drag the divider between the note display and the controller display to resize the display areas.

4 Controller display

Shows one or multiple controller lanes.

5 Controller events

The controller display shows the added controller events of the selected controller type and their current values. Controller events have no length. Their values are valid until the start of the next event.

Velocity values are shown as vertical bars, with higher bars corresponding to higher velocity values. Each velocity bar corresponds to a note in the note display.

All other controller events are shown as steps, with heights corresponding to the values of the events.

6 Create Controller Lane

Allows you to add controller lanes so that you can view and edit different controllers at the same time. Each controller lane can show one of the following properties or event types:

- Velocity
- Pitchbend
- Aftertouch
- Poly Pressure
- Program Change
- SysEx (System Exclusive) events
- Continuous Controllers

7 Controller Lane Setup

Contains setup functions for controller lanes, and allows you to add and organize presets.

Controller Lane Setup Menu

The **Controller Lane Setup** pop-up menu allows you to add lanes and select which event type is displayed.

- To open the **Controller Lane Setup** pop-up menu, click **Controller Lane Setup**  at the bottom left of the controller display.

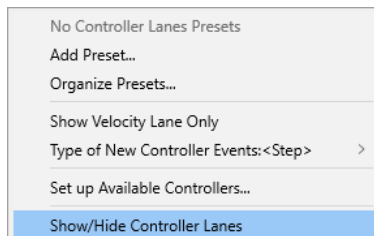

The following options are available:

Add Preset

Opens the **Type in Preset Name** dialog that allows you to save a preset and enter a name for it.

Organize Presets

Opens the **Organize Presets** dialog that allows you to rename and delete presets.

Show Velocity Lane Only

Resets the controller display to show only the velocity lane.

Type of New Controller Events

Allows you to specify whether new controller events should change gradually (**Ramp**) or instantly (**Step**) from the previous curve point to the new one.

NOTE

This only affects new events that you create manually. Recorded MIDI CC events are always added as steps. This setting is saved with the program.

Set up Available Controllers

Opens the **MIDI Controller Setup** dialog that allows you to specify which MIDI controllers are visible/hidden in the pop-up menu.

Show/Hide Controller Lanes

Shows/Hides the last displayed controller lanes.

Controller Lane Context Menu

- To open the controller lane context menu, right-click in the left area of the controller display.

Create Controller Lane	
Remove this Lane	
Select All Events on Lane	
Cut	Ctrl+X
Copy	Ctrl+C
Paste	Ctrl+V
Paste at Origin	Alt+V

The following options are available:

Create Controller Lane

Creates a controller lane.

Remove This Lane

Removes the current controller lane.

Select All Events on Lane

Selects all controller events on the current lane.

Cut

Cuts the selected events.

Copy

Copies the selected events to the clipboard.

Paste

Pastes the clipboard data at the cursor position.

Paste at Origin

Pastes the clipboard data back at its original position. Existing events are replaced.

NOTE

You can copy data between different CC lanes.

RELATED LINKS

[Controller Display](#) on page 623

Controller Selection and Functions Menu

The **Controller Selection and Functions** pop-up menu that is shown to the left of a controller lane allows you to select the displayed controller type. This pop-up menu is only available if at least one controller lane is shown. It also contains editing functions for controller lanes and events.

- To open the **Controller Selection and Functions** pop-up menu, click **Controller Selection and Functions** to the left of a controller lane.

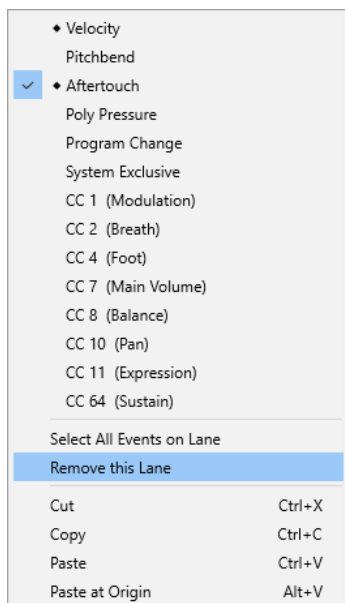
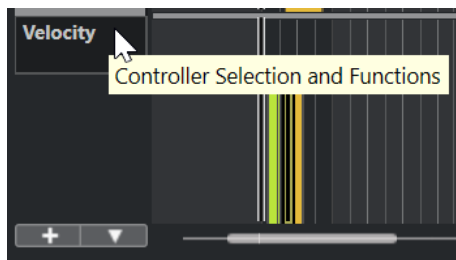

The following options are available:

Controller event types

Lists the event types that you can display on the controller lanes. If automation data already exists for a controller, this is indicated by a rhombus that is displayed to the left of the controller name.

Select All Events on Lane

Selects all controller events on the current lane.

Remove This Lane

Hides the current controller lane from view.

RELATED LINKS

[MIDI Controller Setup Dialog](#) on page 630

Create Controller Lane Menu

The **Create Controller Lane** pop-up menu allows you to create a new controller lane and select which controller type is displayed.

- To open the **Create Controller Lane** pop-up menu, click **Create Controller Lane**  to the left of the controller display.

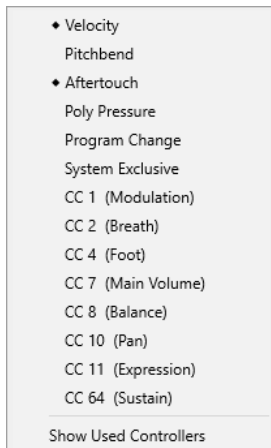

The following options are available:

Controller event types

Lists the event types that you can display on the controller lanes. If automation data already exists for a controller, this is indicated by a rhombus that is displayed to the left of the controller name.

Select an event type to add the corresponding controller lane to the controller display.

Show Used Controllers

Opens all controller lanes that have controller events.

Adding Controller Lanes

You can add controller lanes to the controller display. Controller lanes allow you to select a specific controller type for display, so that you can add and edit controller events of that type.

PROCEDURE

1. Click **Create Controller Lane** .
2. Select the controller event type from the pop-up menu.

NOTE

If the controller event type that you want to show is not available, open the **Controller Lane Setup** pop-up menu and select **Set up Available Controllers**. You can then set up the available controller event types in the **MIDI Controller Setup** dialog.

RESULT

A new controller lane is created.

NOTE

- To hide a controller lane from view, open the **Controller Selection and Functions** pop-up menu and select **Remove This Lane**. This does not affect the events in any way.
 - If you hide all lanes, the controller display is hidden. You can bring it back by clicking **Create Controller Lane** or by opening the **Controller Lane Setup** pop-up menu and selecting **Show/Hide Controller Lanes**.
-

RELATED LINKS

[Controller Selection and Functions Menu](#) on page 626

[Setting up Available Continuous Controllers](#) on page 629

Displaying a Different Controller Event Type

You can select which event type to display on a controller lane. Each controller lane shows one event type at a time.

PROCEDURE

- Open the **Controller Selection and Functions** pop-up menu and select a different event type.

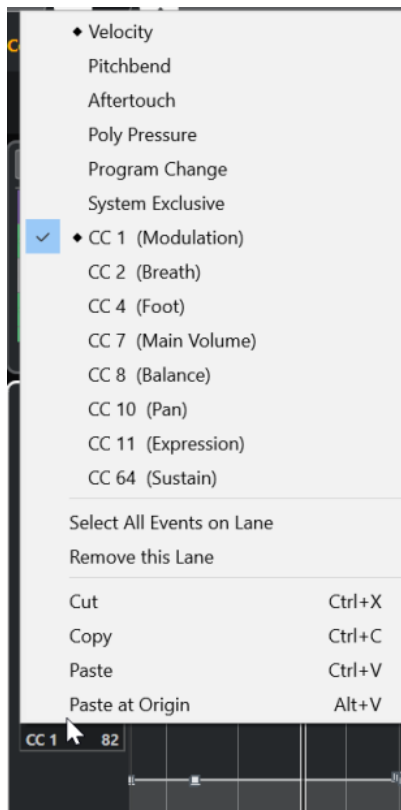

RELATED LINKS

[Controller Selection and Functions Menu](#) on page 626

Setting up Available Continuous Controllers

In the **MIDI Controller Setup** dialog, you can specify which continuous controllers are available for selection.

PROCEDURE

1. Select **Controller Lane Setup > Set up Available Controllers**.
 2. In the **MIDI Controller Setup** dialog, do one of the following:
 - In **Hidden** column, select all controllers that you want to show, and click **Add**.
 - In **Visible** column, select all controllers that you want to hide and click **Remove**.
 3. Click **OK**.
-

RESULT

The corresponding continuous controllers are now available for selection.

NOTE

The **MIDI Controller Setup** dialog is available in different areas of the program. The settings are global, that is, the setup you choose here affects all areas of the program where MIDI controllers can be selected.

RELATED LINKS

[Setting up Available Continuous Controllers](#) on page 629

MIDI Controller Setup Dialog

The **MIDI Controller Setup** dialog allows you to specify which MIDI controllers are visible/hidden.

- To open the **MIDI Controller Setup** dialog, click **Controller Lane Setup** to the left of the controller display, and select **Set up Available Controllers**.

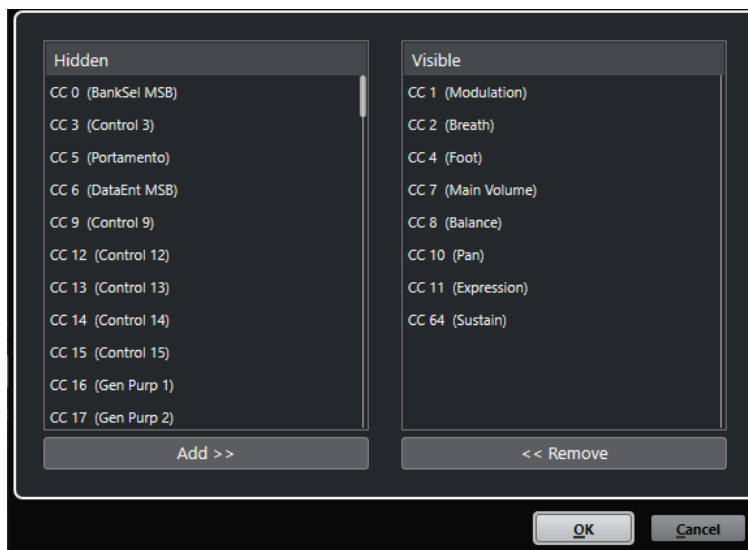

Visible

Lists the MIDI controllers that are visible.

Hidden

Lists the MIDI controllers that are hidden.

Add >>

Select an item in the **Hidden** list, and click **Add >>** to make it visible.

<< Remove

Select an item in the **Visible** list, and click **<< Remove** to hide it.

Saving Controller Lane Presets

You can save a controller lane setup as a controller lane preset. This way, you can have a preset with one velocity lane and another preset with a combination of several controller lanes, such as velocity, pitchbend, or modulation.

PREREQUISITE

You have added at least one controller lane and selected a controller event type for display.

PROCEDURE

1. Click **Controller Lane Setup**.
 2. Select **Add Preset**.
 3. In the **Type in Preset Name** dialog, enter a name for the preset.
 4. Click **OK**.
-

RESULT

Your controller lane setup is now available as a controller lane preset. The number of lanes and the displayed event types are saved in the preset.

To load, remove, or rename presets, open the **Controller Lane Setup** menu, and select **Organize Presets**.

RELATED LINKS

[Controller Lane Setup Menu](#) on page 625

Editing Velocity Events

Each note event automatically gets a velocity event. You can edit the velocity values of these events.

PREREQUISITE

You have added a controller lane and set it up to display velocity events. You have added velocity events for several notes.

PROCEDURE

1. Optional: On the toolbar, activate **Acoustic Feedback**.
This plays back the notes when you adjust the velocity so that you can audition your changes.
2. Do one of the following:
 - On the toolbar, select the **Object Selection** or the **Draw** tool and click a velocity bar in the controller display.
 - On the toolbar, select the **Object Selection** tool, press **Alt** and click a velocity bar in the controller display to select it. Change the **Velocity** value on the info line.
 - On the toolbar, select the **Line** tool and drag in the velocity display to change the velocity values of several notes.

The velocity value at the project cursor position is displayed below the **Controller Selection and Functions** pop-up menu.

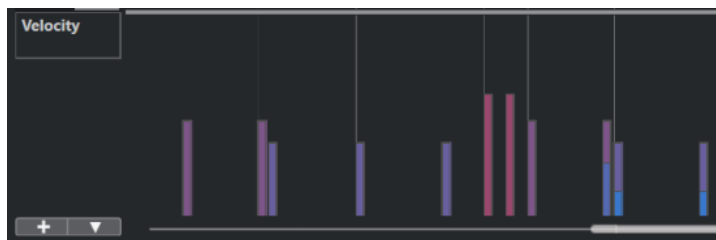

NOTE

If there is more than one note at the same position, their velocity bars overlap. To edit the velocity of only one of these notes, select the note in the note display. If no note is selected, all velocity events get the same velocity value.

RESULT

The velocity values change according to your edits.

RELATED LINKS

[Adding Velocity Events](#) on page 632

[Controller Selection and Functions Menu](#) on page 626

Adding Velocity Events

You can add velocity events by adding note events.

PREREQUISITE

You have added a controller lane.

PROCEDURE

1. Open the **Controller Selection and Functions** pop-up menu and select **Velocity**.
2. Select the **Draw** tool or the **Line** tool.
3. Click in the note display to add a note event.

This adds a note event and a velocity controller event that you can edit.

RESULT

The velocity values are shown as vertical bars in the controller display. Each velocity bar corresponds to a note event in the note display. Higher bars correspond to higher velocity values. The value is valid until the beginning of the next event.

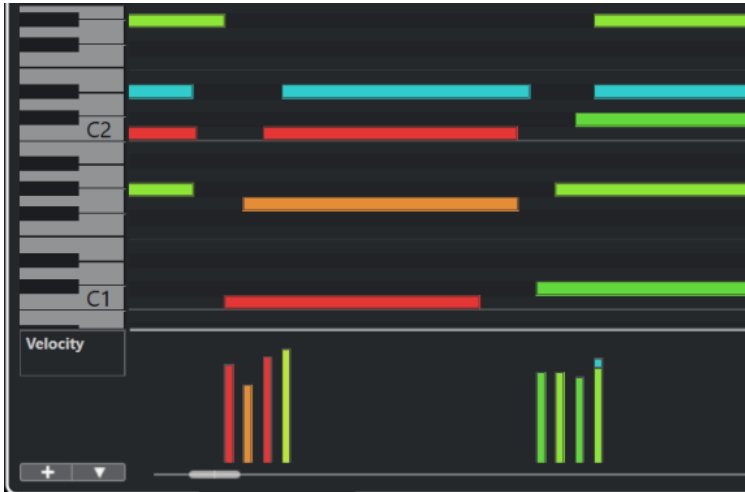

RELATED LINKS

[Adding Controller Lanes](#) on page 628

[Line Tool Modes](#) on page 640

[Controller Selection and Functions Menu](#) on page 626

Pitchbend Controller Lanes

Pitchbend controller lanes allow you to add and edit pitchbend controller events.

- To add a pitchbend controller lane, open the **Controller Selection and Functions** menu, and select **Pitchbend**.

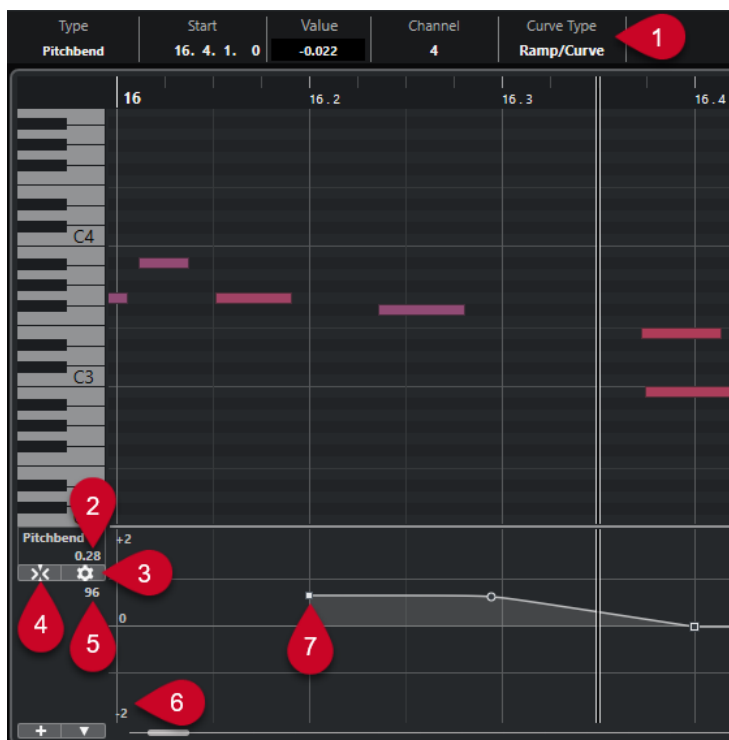

1 Curve Type field

Shows the controller curve type. You can set this to **Step** or to **Ramp/Curve**.

2 Value at project cursor

Displays the pitchbend value at the project cursor position. What exactly is shown depends on the **Show Semitones Grid** setting in the **Grid Settings** pane:

- If **Show Semitones Grid** is activated, this value shows the semitones value at the project cursor position. The range goes from +96 semitones to -96 semitones. The value is shown in semitones and cents.
- If **Show Semitones Grid** is deactivated, this value shows the pitchbend MIDI value at the project cursor position. The range goes from +8191 steps to -8192 steps.

3 Set up Grid

Opens the **Grid Settings** pane that allows you to set up the semitones grid for the pitchbend controller lane.

4 Snap Pitchbend Events

Restricts vertical movement and positioning of controller events to the semitones grid. By default, activating **Snap Pitchbend Events** also activates **Show Semitones Grid** to show the grid that the events are snapping to.

NOTE

Snap Pitchbend Events is not effective in the controller event editor.

5 Controller value from MIDI device

This value shows up if you input MIDI data for this controller lane from your MIDI device.

6 Semitones grid

The semitones grid shows the semitone values. The amount of grid lines and their width depends on the settings for **Pitchbend Range: Down** and **Pitchbend Range: Up**. By default, the range is set to +/- 2 semitones, that is, a major second.

NOTE

You can show the grid even if **Snap Pitchbend Events** is deactivated.

7 Controller curve

The pitchbend controller curve.

RELATED LINKS

[Controller Event Editor](#) on page 642

[Grid Settings](#) on page 634

Grid Settings

The **Grid Settings** pane allows you to set up a semitones grid for the pitchbend controller lane. As grid settings only affect the corresponding track, you can set up different grid settings for different MIDI or instrument tracks. All grid settings are saved with the project.

- To show the **Grid Settings** for pitchbend controller lanes, add a pitchbend controller lane, and click **Set up Grid**.

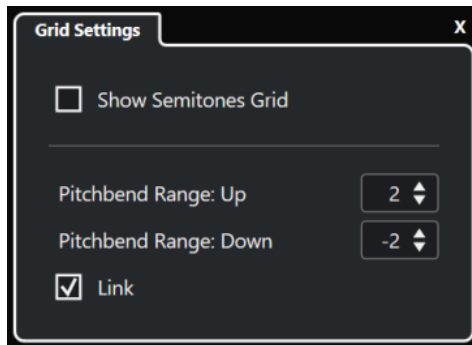

Show Semitones Grid

The semitones grid shows the semitone values that the events snap to. The amount of grid lines and their width depends on the settings for **Pitchbend Range: Down** and **Pitchbend Range: Up**.

NOTE

The grid is a visual help that allows you to find exact semitone positions for pitchbends easier. Changing the grid does not change the values of pitchbend events.

Pitchbend Range: Up

Allows you to specify a value between 1 and 96 semitones for the upper grid. By default, the upper pitchbend range for the grid is set to 2 semitones, allowing you to specify upward bends from 1 to up to 2 semitones.

Pitchbend Range: Down

Allows you to specify a value between 1 and -96 semitones for the lower grid. By default, the lower pitchbend range for the grid is set to -2 semitones, allowing you to specify downward bends from 1 to up to -2 semitones.

Link

Allows you to link the pitchbend ranges. You can deactivate this if you want to set up a higher value for the upper range than for the lower range, for example.

NOTE

The actual pitchbend range depends on the settings of the VST or MIDI instrument and the sound or preset that you are using. To make the most of this feature, make sure to adjust the pitchbend range settings of your instrument to the settings of the pitchbend controller lane, or vice versa.

RELATED LINKS

[Pitchbend Controller Lanes](#) on page 633

Adding Pitchbend Events

You can add pitchbend events to your note events.

PROCEDURE

1. Open the **Create Controller Lane** pop-up menu and select **Pitchbend**.
2. Optional: Click **Set up Grid** to open the **Grid Settings** pane, and set up the grid according to your needs.

3. Optional: Activate **Snap Pitchbend Events** to snap the pitchbend controller events to the set grid.
 4. Select the **Draw** tool and click in the controller display to enter as many pitchbend events as you need.
-

RESULT

The pitchbend controller events are added.

RELATED LINKS

- [Pitchbend Controller Lanes](#) on page 633
- [Create Controller Lane Menu](#) on page 627
- [Grid Settings](#) on page 634
- [Creating Smooth Transitions between Continuous Controller Events](#) on page 638
- [Editing Pitchbend Events](#) on page 636

Editing Pitchbend Events

PREREQUISITE

You have added a pitchbend controller lane and added pitchbend events.

PROCEDURE

1. On the toolbar, select the **Object Selection** tool.
2. Optional: Click **Set up Grid** to open the **Grid Settings** pane, and set up the grid according to your needs.
3. In the controller display move the mouse pointer over a pitchbend controller event.
The mouse pointer becomes a pointing hand symbol.

NOTE

You can create smooth transitions between the pitchbend controller events by selecting a pitchbend controller event and switching the **Curve Type** on the info line to **Ramp/Curve** and editing the curve handles.

4. Click the pitchbend controller event to select it and drag it to another position.
-

RELATED LINKS

- [Grid Settings](#) on page 634
- [Adding Pitchbend Events](#) on page 635
- [Pitchbend Controller Lanes](#) on page 633

Adding Poly Pressure Events

You can add poly pressure events to your note events. Poly pressure events are events that belong to a specific note number, that is, key. For each poly pressure event, you can edit the note number and the amount of pressure.

PROCEDURE

1. Click **Create Controller Lane** .
2. Select **Poly Pressure** from the menu.

A **Poly Pressure** controller lane is added. It shows a note number value field to the left of the controller display.

3. Do one of the following:

- Select a note event in the note display to set the note number for the corresponding pitch. This only works for the topmost of several poly pressure controller lanes.
- If you work with several poly pressure controller lanes, use the pop-up menu in the note number value field to the left of the controller display to select the note pitch for that controller lane.

The selected note number is displayed in the upper value field to the left of the controller display.

4. On the toolbar, select the **Draw** tool, and add a new poly pressure event.

You can determine the value by moving the mouse up or down in the controller display.

AFTER COMPLETING THIS TASK

Select a different note number and add poly pressure events for this.

RELATED LINKS

[Controller Selection and Functions Menu](#) on page 626

Editing Poly Pressure Events

PREREQUISITE

You have added a controller lane and set it up to display poly pressure events. You have added poly pressure events for several note numbers.

PROCEDURE

1. Click the arrow button next to the note number to the left of the controller lane.
A pop-up menu with a list of all note numbers for which you inserted poly pressure events opens.
 2. Select a note number from the pop-up menu.
The poly pressure events for the selected note number are shown in the controller lane.
 3. On the toolbar, select the **Draw** tool.
 4. Hold down **Ctrl/Cmd - Alt/Opt** and edit the events in the controller display.
-

RELATED LINKS

[Adding Poly Pressure Events](#) on page 636

Adding Continuous Controllers

You can add continuous controllers to your note events.

PREREQUISITE

You have added a controller lane.

PROCEDURE

1. Open the **Controller Selection and Functions** pop-up menu and select a continuous controller.

2. Select the **Draw** tool or the **Line** tool.
3. Do one of the following:
 - To add a single event, click in the controller display.
 - To add a multiple events, click and drag in the controller display.
 - To add a **Modulation (CC 1)** event, copy note events from the **Key Editor** note display and paste them on a controller lane in the controller display.

When you move the **Draw** tool on the controller lane, a tooltip shows the position and the controller value at the mouse position.

RESULT

The added events are added as steps that correspond to the event values. The beginning of an event is marked by a curve point. Controller events have no length. The value of a controller event in the display is valid until the beginning of the next controller event.

RELATED LINKS

[Adding Controller Lanes](#) on page 628

[Line Tool Modes](#) on page 640

[Controller Selection and Functions Menu](#) on page 626

Editing Continuous Controllers

You can edit the values of the continuous controller events that you added or recorded.

PREREQUISITE

You have added a controller lane and set it up to display controller events. You have added controller events for several notes.

PROCEDURE

1. On the toolbar, select the **Object Selection**, the **Draw**, or the **Line** tool.
 2. Do one of the following:
 - If you selected the **Draw**, or the **Line** tool, drag in the controller display.
 - If you selected the **Object Selection** tool, press **Alt** and drag in the controller display.
-

RESULT

The controller event is edited.

RELATED LINKS

[Line Tool Modes](#) on page 640

Creating Smooth Transitions between Continuous Controller Events

By default, when recording or drawing MIDI continuous controller events, these are inserted as steps. If this is not what you want, you can create smooth transitions between the events.

PREREQUISITE

You have recorded MIDI data with continuous controller events.

PROCEDURE

1. In the **Project** window, double-click the MIDI part.

2. In the **Key Editor**, open the **Create Controller Lane** menu, and select **Show Used Controllers**.

The controller lanes for all controller events that you have recorded are shown in the controller display.

3. Locate the controller lane of the continuous controller that you want to edit, and select a controller event.

The info line of the **Key Editor** displays information about the selected controller event, such as **Type**, **Start** position, **Value**, **Channel**, and **Curve Type**.

Type	Start	Value	Channel	Curve Type
CC 1 (Modulation)	25. 1. 1. 0	54	1	Ramp/Curve

4. Do one of the following:

- On the info line, change the option in the **Curve Type** field from **Step** to **Ramp/Curve**.

NOTE

You can change the curve type for several controller events by selecting them and then changing the value in the **Curve Type** field.

- In the controller display, move the mouse pointer between two controller events and double-click the handle that appears to change the curve type from **Step** to **Ramp/Curve**.

5. Move the mouse pointer over the ramp, click the handle, and move it upwards or downwards to change the ramp into a curve shape.

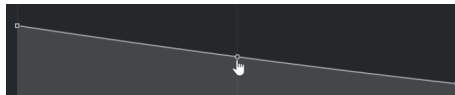

RESULT

The ramp changes into a curve.

When you play back ramps/curves, the data between two MIDI continuous controller events are interpolated to a suitable MIDI data resolution. You can visualize this by selecting **MIDI > Merge MIDI in Loop** or **MIDI > Freeze MIDI Modifiers**, or by exporting the part as a MIDI file.

NOTE

Ramp/Curve controller curves are more demanding on the performance of the application.

AFTER COMPLETING THIS TASK

You can use the controller lane context menu to cut, copy, and paste controller events.

RELATED LINKS

[Controller Lane Context Menu](#) on page 626

Continuous Controllers and MIDI Automation

You can not only record or enter MIDI controller data for a MIDI part in the controller lane, but also for an automation track in the **Project** window.

To show and edit MIDI controller data on the automation track, you must extract the MIDI automation from the MIDI part.

MIDI controller data from the automation track is also displayed on the controller lane. However, you cannot edit this data on the controller lane.

On the controller lane, you can also see the controller curve that is applied before the part starts. This tells you which controller value is being used at the starting point of the part so that you can choose the start value accordingly.

RELATED LINKS

[Extracting MIDI Automation](#) on page 612

MIDI Part Data vs. Track Automation

You can enter or record MIDI controller data as automation data on an automation track or as part data in the MIDI part.

- If **Read Automation** for a track is enabled, controller data is written as automation data on an automation track in the **Project** window.
- If **Read Automation** is disabled, the controller data is written in the MIDI part and can be viewed and edited for example in the **Key Editor**.

Nevertheless, you can end up with both kinds of controller data for a MIDI part if you recorded controller part data in one pass and automation data during another. In this case, these conflicting data types are combined during playback as follows:

- Part automation only begins when the first controller event within the part is reached. At the end of the part, the last controller value is kept until an automation breakpoint is reached on the automation track.

Line Tool Modes

You can use the different **Line** tool modes to edit controller events.

- To select a line mode, click the **Line** tool on the **Key Editor** or the **Drum Editor** toolbar, and click again to open a pop-up menu with the available modes.

The following modes are available:

Line

In this mode you can draw events in a straight line by clicking in the controller display and dragging the cursor to where you want the ramp to end.

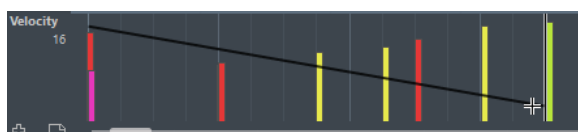

NOTE

If **Snap** is activated, the **Length Quantize** value determines the density of created controller curves. For very smooth curves, use a small **Length Quantize** value or deactivate **Snap**. Beware that very dense controller curves can cause MIDI playback to stutter.

Parabola

In this mode you can draw events on a parabola curve. This gives more natural curves and fades.

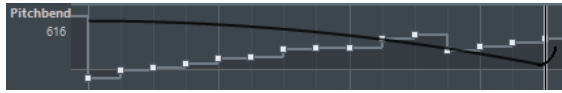

You can use modifier keys to determine the shape of the parabola curve.

- To reverse the parabola curve, press **Ctrl/Cmd**.
- To change the position of the whole curve, press **Alt/Opt**.
- To increase or decrease the exponent, press **Shift**.

NOTE

If **Snap** is activated, the **Length Quantize** value determines the density of created controller curves. For very smooth curves, use a small **Length Quantize** value or deactivate **Snap**. Beware that very dense controller curves can cause MIDI playback to stutter.

Sine, Triangle, and Square

These modes create different periodic waveform curves.

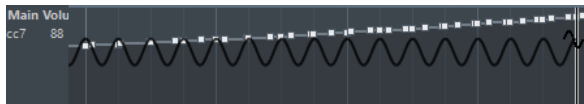

The quantize value determines the period of the curve that is the length of one curve cycle. The **Length Quantize** value determines the density of the events.

NOTE

If you set **Length Quantize** to **Quantize Link** and you enter data in **Sine, Triangle** or **Square** mode, the density of the events depends on the zoom factor.

You can use modifier keys to determine the shape of the curve.

- To change the phase of the beginning of the curve, press **Ctrl/Cmd**.
- To change the position of the whole curve, press **Alt/Opt - Ctrl/Cmd**.
- To change the maximum position of the triangle curve or the pulse of the square curve in **Triangle** and **Square** mode, press **Shift - Ctrl/Cmd**. This creates sawtooth curves.
- You can also set the curve period freely by holding down **Shift** when you insert events in **Sine, Triangle**, or **Square** mode. Activate **Snap**, **Shift**-click and drag to set the length of one period. The period length will be a multiple of the quantize value.

Paint

In this mode, you can draw in multiple notes.

NOTE

If **Snap** is activated, the **Length Quantize** value determines the density of created controller curves. For very smooth curves, use a small **Length Quantize** value or deactivate **Snap**. Beware that very dense controller curves can cause MIDI playback to stutter.

Controller Event Editor

The controller event editor allows you to perform additional scaling operations for selection ranges on existing controller curves.

- To open the controller event editor, activate the **Object Selection** tool and drag a selection rectangle on the controller lane.
- To open the controller event editor for velocity lanes, select multiple MIDI notes in the note display or activate the **Object Selection** tool, press **Alt** and drag a selection rectangle on the controller lane or to get the **Object Selection** tool.

The controller event editor features the following smart controls for specific editing modes:

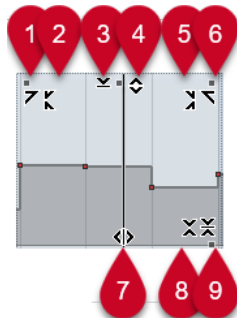

1 Tilt Left

If you click in the upper left corner of the editor, you can tilt the left part of the curve. This allows you to tilt the event values at the start of the curve upwards or downwards.

2 Compress Left

If you **Alt/Opt**-click in the upper left corner of the editor, you can compress or expand the left part of the curve. This allows you to compress or expand the event values at the start of the curve.

3 Scale Vertically

If you click in the middle of the upper border of the editor, you can scale the curve vertically. This allows you to raise or lower the event values of the curve in percent.

4 Move Vertically

If you click on the upper border of the editor, you can move the entire curve vertically. This allows you to raise or lower the values of the event values of the curve.

5 Compress Right

If you **Alt/Opt**-click in the upper right corner of the editor, you can compress or expand the right part of the curve. This allows you to compress or expand the event values at the end of the curve.

6 Tilt Right

If you click in the upper right corner of the editor, you can tilt the right part of the curve. This allows you to tilt the event values at the end of the curve upwards or downwards.

7 Stretch

If you click on the lower border of the editor, you can stretch the curve horizontally. This allows you to move the event values of the curve to the left or to the right.

8 Scale Around Absolute Center

If you click in the middle of the right corner of the editor, you can scale the curve absolute to its center. This allows you to raise or lower the event values horizontally around the center of the editor.

9 Scale Around Relative Center

If you **Alt/Opt**-click in the middle of the right border of the editor, you can scale the curve relative to its center. This allows you to raise or lower the event values horizontally around the center of the editor.

Auto Select Controllers

Auto Select Controllers automatically selects controller data of the selected MIDI notes. This is useful as selected controllers for notes will be moved when you move the corresponding notes.

- To show **Auto Select Controllers**, right-click the **Key Editor** or the **Drum Editor** toolbar, and select **Auto Select Controllers**.



If you activate **Auto Select Controllers**, controllers that belong to a note event are automatically selected when you select the note event.

RELATED LINKS

[Key Editor Toolbar](#) on page 645

Moving Events in the Controller Display

You can move events of a controller curve in the controller display. This only works for curve type controller events such as continuous controllers, pitchbend, aftertouch, poly pressure, and program change.

PROCEDURE

1. Do one of the following:
 - With the **Object Selection** tool, drag to create a selection rectangle that encompasses the events that you want to move.
 - On the toolbar, activate **Auto Select Controllers**. In the note display, select the notes whose controllers you want to move.
 - In the note display, select the notes whose controllers you want to move, and select **Edit > Select > Select Controllers in Note Range** to select the controllers within the range of the selected notes.
2. Move the note/controller events.

RESULT

The controller events are moved to the new position. Snap is taken into account.

RELATED LINKS

[Select Controllers in Note Range: Use Extended Note Context](#) on page 831

Key Editor

The **Key Editor** is the default MIDI editor. It displays notes graphically in a piano roll-style grid. The **Key Editor** allows for detailed editing of notes and non-note events, such as MIDI controllers.

You can open the **Key Editor** in a separate window or in a tab in the lower zone of the **Project** window. Opening the **Key Editor** in the lower zone of the **Project** window is useful if you want to access the **Key Editor** functions from within a fixed zone of the **Project** window.

To open a MIDI part in the **Key Editor**, do one of the following:

- Double-click a MIDI part in the **Project** window.
- Select a MIDI part in the **Project** window and press **Return** or **Ctrl/Cmd - E**.
- Select a MIDI part in the **Project** window and select **MIDI > Open Key Editor**.
- In the **Key Commands** dialog in the **Editors** category, assign a key command for **Open Key Editor**. Select a MIDI part in the **Project** window and use the key command.

NOTE

If you select **MIDI > Set up Editor Preferences**, the **Preferences** dialog opens on the **Editors** page. Make your changes to specify if you want the editors to open in a separate window or in the lower zone of the **Project** window.

The **Key Editor** window:

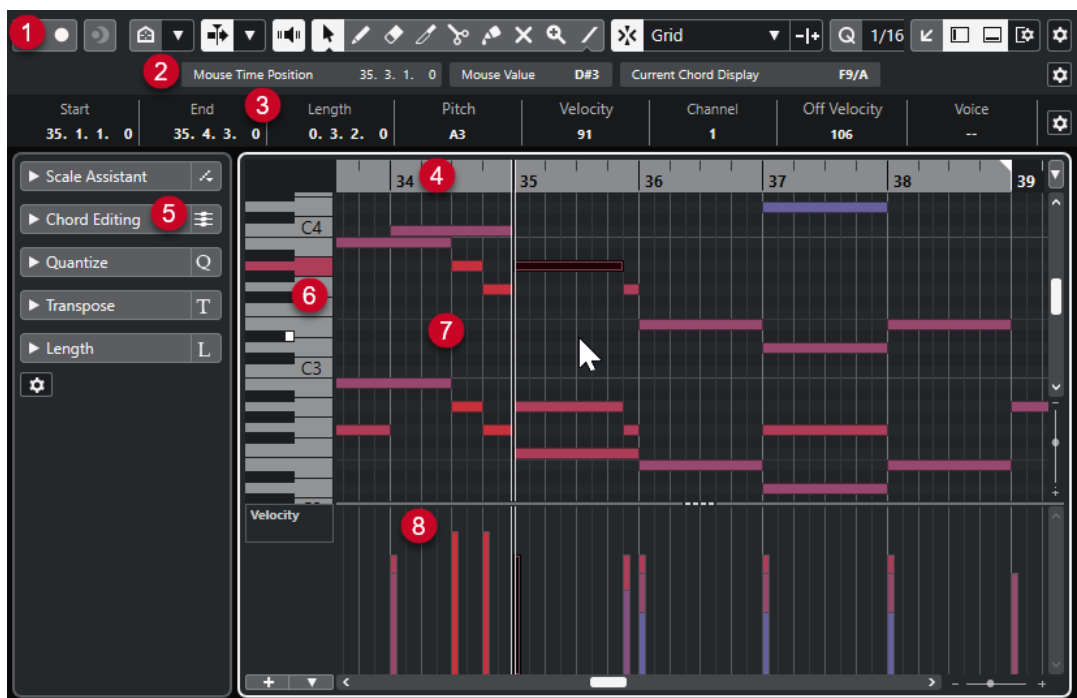

The **Key Editor** is divided into several sections:

- 1 Toolbar**
Contains tools and settings.
- 2 Status line**
Informs about the mouse time position, the mouse value, and the current chord.
- 3 Info line**
Displays note event information about a selected MIDI note.
- 4 Ruler**
Displays the timeline.
- 5 Key Editor Inspector**
Contains tools and functions for working with MIDI data.
- 6 Piano keyboard display**
Helps you to find the right note number.

7 Note display

Contains a grid in which MIDI notes are displayed as boxes.

8 Controller display

The area below the note display consists of one or multiple controller lanes.

NOTE

You can activate/deactivate the status line, the info line, and the controller lanes by clicking **Set up Window Layout** on the toolbar and activating/deactivating the corresponding options.

RELATED LINKS

[Key Editor Toolbar](#) on page 645

[Status Line](#) on page 651

[Key Editor Inspector](#) on page 652

[Note Display](#) on page 654

[Key Editor Piano Keyboard Display](#) on page 655

[Controller Display](#) on page 623

Key Editor Toolbar

The toolbar contains tools and settings for the **Key Editor**.

- To show or hide the toolbar elements, right-click the toolbar and activate or deactivate the elements.

Default Items

Solo Editor



Solos the editor during playback if the editor has the focus.

Record in Editor



Enables the recording of MIDI data in the editor if the editor has the focus.

NOTE

This only works if **MIDI Record Mode** is set to **Merge** or **Replace**.

Retrospective Record

Insert MIDI Retrospective Recording in Editor



Allows you to recover MIDI notes that you played in stop mode or during playback.

Left Divider

Left Divider

Allows you to use the left divider. Tools that are placed to the left of the divider are always shown.

Pitch Visibility

Pitch Visibility On/Off



Deactivate this to show all pitches in the note display. Activate this to reduce the pitches in the note display according to the selected pitch visibility option.

Select Pitch Visibility Options



Allows you to determine which pitches are displayed in the note display:

- **Show Pitches with Events** shows only the pitches for which events are available in the note display.
- **Show Pitches from Scale Assistant** shows only the pitches that match the musical scale that is selected in the **Scale Assistant** section of the **Inspector**.

Auto-Scroll

Auto-Scroll



Keeps the project cursor visible during playback.

Select Auto-Scroll Settings



Allows you to activate **Page Scroll** or **Stationary Cursor** and to activate **Suspend Auto-Scroll When Editing**.

Acoustic Feedback

Acoustic Feedback



Automatically plays back events when you move or transpose them, or when you create them by drawing.

Tool Buttons

Object Selection



Selects events and parts.

Draw



Draws events.

Erase



Deletes events.

Trim



Trims events.

Split



Splits events.

Glue



Glues together events of the same pitch.

Mute



Mutes events.

Zoom



Zooms in. Hold **Alt/Opt** and click to zoom out.

Line



Creates a series of contiguous events.

Auto Select Controllers

Auto Select Controllers



Automatically selects controller data of the selected MIDI notes.

Independent Track Loop

Independent Track Loop



Activates/Deactivates the independent track loop.

Insert Velocity

Note Insert Velocity



Allows you to specify a velocity value for new notes.

Nudge

Nudge Start Left



Increases the length of the selected event by moving its start to the left.

Nudge Start Right



Decreases the length of the selected event by moving its start to the right.

Move Left



Moves the selected event to the left.

Move Right



Moves the selected event to the right.

Nudge End Left



Decreases the length of the selected event by moving its end to the left.

Nudge End Right



Increases the length of the selected event by moving its end to the right.

Transpose Palette

Move Up



Transposes the selected event up by a half note.

Move Down



Transposes the selected event down by a half note.

Move Up More



Transposes the selected event up by an octave.

Move Down More



Transposes the selected event down by an octave.

Snap

Snap On/Off



Activates/Deactivates the **Snap** function.

Snap Type



Allows you to select one of the following snap types:

- **Grid** snaps events to the grid that is selected in the **Quantize Presets** pop-up menu.
- **Grid Relative** keeps the relative positions when snapping events to the grid.
- **Events** snaps events to the start or end of other events.
- **Shuffle** changes the order of events if you drag one event to the left or right of other events.
- **Cursor** snaps events to the cursor position.
- **Grid + Cursor** snaps events to the quantize grid that is selected in the **Quantize Presets** pop-up menu or to the cursor position.
- **Events + Cursor** snaps events to the start or end of other events, or to the cursor position.
- **Grid + Events + Cursor** snaps events to the quantize grid that is selected in the **Quantize Presets** pop-up menu, to the start or end of other events or to the cursor position.

Grid Type

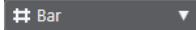

Allows you to select one of the following grid types:

- **Use Quantize** activates a grid where events snap to the value that is selected in the **Quantize Presets** pop-up menu.
- **Adapt to Zoom** activates a grid where events snap to the zoom level.

Quantize

Apply Quantize



Applies the quantize settings.

Quantize Presets



Allows you to select a quantize or a groove preset.

Soft Quantize On/Off



Activates/Deactivates soft quantize.

Open Quantize Panel



Opens the **Quantize Panel**.

Length Quantize

Length Quantize

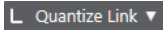

Allows you to set a value for quantizing event lengths.

Multiple Part Controls

Show Part Borders



Shows/Hides part borders for the active MIDI part within the left and right locators.

Part Editing Mode



Sets the editing mode for parts.

- **Edit All Parts** allows you to edit all parts that are opened in the **Editor** at the same time.
- **Edit Active Part** restricts editing operations to the part that is selected in the **Activate Part for Editing** pop-up menu.

Activate Part for Editing



Lists all parts that were selected when you opened the editor, and allows you to activate a part.

Step/MIDI Input

Step Input



Activates/Deactivates MIDI step input.

MIDI Input/Note Expression MIDI Input



Activates/Deactivates MIDI input and note expression MIDI input.

Move Insert Mode



Moves all note events to the right of the step input position to the right to make room for the inserted event when you insert notes.

NOTE

This only works if **Step Input** is activated.

Record Pitch



Includes the pitch when you insert notes.

Record NoteOn Velocity



Includes the NoteOn velocity when you insert notes.

Record NoteOff Velocity



Includes the NoteOff velocity when you insert notes.

Event Colors

Event Colors

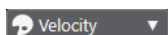

Allows you to select event colors.

Right Divider

Right Divider

Allows you to use the right divider. Tools that are placed to the right of the divider are always shown.

Window Zone Controls

Open in Separate Window



This button is available in the **Editor** tab in the lower zone. It opens the editor in a separate window.

Open in Lower Zone



This button is available in the editor window. It opens the **Editor** tab in the lower zone of the **Project** window.

Set up Window Layout



Allows you to set up the window layout.

Set up Toolbar



Opens a pop-up menu where you can set up which toolbar elements are visible.

RELATED LINKS

[Zooming in MIDI Editors](#) on page 614

Status Line

The status line shows information about the mouse time position, the mouse value, and the current chord.

- To show the status line, click **Set up Window Layout** on the toolbar, and activate **Status Line**.



The on/off status of the status line in the **Key Editor** window and in the **Editor** tab in the lower zone of the **Project** window are independent of each other.

Mouse Time Position

Displays the exact time position of the mouse pointer, depending on the selected ruler display format. This lets you edit or insert notes at exact positions.

Mouse Value

Displays the exact pitch of the mouse pointer position in the event display. This facilitates finding the right pitch when entering or transposing notes.

If you move the mouse in the controller display, the controller event value at the mouse cursor position is displayed.

Current Chord Display

When the project cursor is positioned over notes that form a chord, the chord is displayed here.

RELATED LINKS

[Looping MIDI Parts](#) on page 623

Info Line

The info line shows values and properties of the selected events. If several notes are selected, the values for the first note are displayed in color.

- To show the info line, click **Set up Window Layout** on the toolbar, and activate **Info Line**.

Start	End	Length	Pitch	Velocity	Channel	Off Velocity	Voice	Text
17. 2. 3. 0	17. 4. 1. 0	0. 1. 2. 0	A#2	100	1	64	--	

Length and position values are displayed in the selected ruler display format.

The on/off status of the info line in the **Key Editor** window and in the **Editor** tab in the lower zone of the **Project** window are independent of each other.

RELATED LINKS

[Editing Note Events on the Info Line](#) on page 621

[Changing the Ruler Display Format](#) on page 614

Key Editor Inspector

In a MIDI editor, the **Inspector** is located left of the note display. The **Key Editor Inspector** contains tools and functions for working with MIDI data.

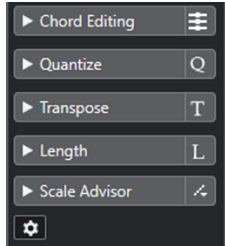

Chord Editing

Allows you to enter chords instead of single notes.

Quantize

Allows you to access the main quantize parameters. These are identical with the functions on the **Quantize** panel.

Transpose

Allows you to access the main parameters for transposing MIDI events.

Length

Contains length-related options, similar to the **Functions** submenu of the **MIDI** menu.

- To change the length of the selected MIDI events or all events of the active part if no events are selected, use the **Scale Length/Scale Legato** slider.
At the maximum value the notes reach the beginning of the next note.
- To make the new length settings permanent, click **Freeze MIDI Lengths**.
- To fine-tune the distance between consecutive notes, use the **Overlap** slider.
At **0 Ticks**, the **Scale Length/Scale Legato** slider extends each note so that it reaches the next note exactly. Positive values cause the notes to overlap and negative values allow you to define a small gap between the notes.
- To use the **Legato** function or slider to extend a note until the next selected note, activate **Extend to Next Selected**.
This is identical with activating the **Legato Mode: Between Selected Notes Only** option in the **Preferences** dialog.

Scale Assistant

Allows you to select a musical scale that highlights all note events whose pitches belong to this scale.

Set up Inspector

Allows you to open a dialog to edit the **Inspector** settings for the editor. Click **Set up Inspector**, and from the pop-up menu, select **Setup**.

NOTE

If you open the **Key Editor** in the lower zone, these sections are shown in the **Editor Inspector** in the left zone.

RELATED LINKS

[Quantize Panel](#) on page 243

[Opening the Editor Inspector](#) on page 50

[Scale Assistant in the Key Editor](#) on page 653

Scale Assistant in the Key Editor

The **Scale Assistant** section of the **Key Editor Inspector** helps you to match note events to a musical scale.

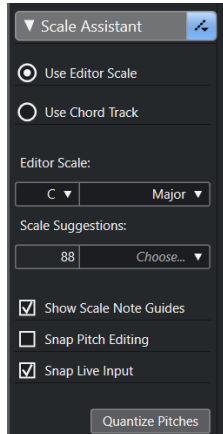

Scale Assistant Status Indicator

Shows the on/off status of the **Scale Assistant**.

Use Editor Scale

Allows you to select a scale for the notes in the **Key Editor** note display.

- **Editor Scale**
Allows you to select a scale.
- **Scale Suggestions**
Shows the number of scale suggestions that match the pitches of the MIDI notes. Open the pop-up menu to choose one of the suggestions. To get scale suggestions for specific notes, you must select them. If no note is selected, the scale suggestions are made for all notes in the note display.

Use Chord Track

Allows you to use the chord track data as a musical scale.

- **Chord Track Mode**
Allows you to select whether you want to use the scale events of the chord track, the chord events, or both as a musical scale.

Show Scale Note Guides

Changes the note event display background according to the selected scale. Pitches that do not belong to the selected scale are shown with a darker background.

Snap Pitch Editing

Snaps the pitches or the notes to the selected scale when you add, edit, or move them.

NOTE

Snap Pitch Editing does not apply when you change pitches using the **Pitch** value field on the info line or if you record notes via MIDI input.

Snap Live Input

Automatically corrects the pitches of incoming notes according to the selected scale.

NOTE

This only works if **Record in Editor** is activated.

Quantize Pitches

Quantizes the pitches of the selected notes to the nearest pitch of the selected scale.

RELATED LINKS

[Note Display](#) on page 654

[Using Live Input](#) on page 719

[Event Colors Menu](#) on page 615

[Musical Scale Setup Dialog](#) on page 713

[Matching Note Events to a Musical Scale](#) on page 659

[Using the Chord Track to Match Note Events to a Musical Scale](#) on page 660

[Quantizing MIDI Note Pitches to Musical Scales](#) on page 661

[Chord Track](#) on page 705

[Mapping Incoming MIDI Note Pitches to Musical Scales](#) on page 661

[Snapping MIDI Note Pitches to Musical Scales While Editing](#) on page 662

Note Display

The note display is the main zone in the **Key Editor**. It contains a grid in which note events are shown as boxes.



The width of a box corresponds to the note length. The vertical position of a box corresponds to the note number (pitch), with higher note events higher up in the grid.

Depending on the zoom factor, the note events show the note names.

NOTE

You can change the naming format and the note names of the pitches in the **Pitch Notation** section of the **Preferences** dialog (**Event Display—Chords&Pitches** page).

You can activate **Pitch Visibility On/Off** on the **Key Editor** toolbar to show only the pitches with events or the pitches suggested by the **Scale Assistant**. This hides the keyboard keys whose pitches are not used and shows note names on the remaining keys.

RELATED LINKS

[Key Editor Piano Keyboard Display](#) on page 655

[Zooming in MIDI Editors](#) on page 614

[Pitch Notation](#) on page 836

[Pitch Visibility Options](#) on page 657

Key Editor Piano Keyboard Display

The piano keyboard display is shown to the left of the note display in the **Key Editor**.

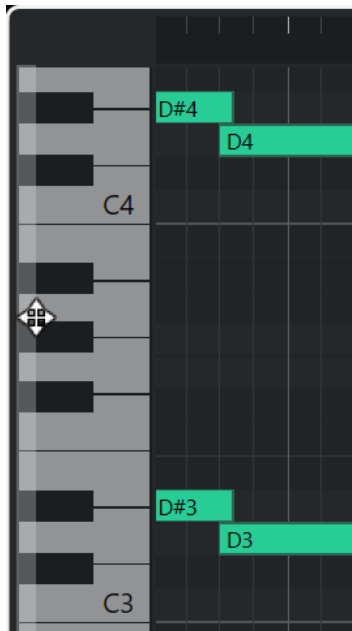

The piano keyboard gives you a visual orientation over the pitch positions in the note display, helping you to find specific note pitches.

You can click a key to listen to the pitch and the sound of the connected instrument.

If you move the mouse to the far left of the piano keyboard display, the mouse pointer changes, allowing you to scroll up and down and to zoom in and out of the keyboard display:

- Drag upwards/downwards to scroll up/down in the piano keyboard display.
- Drag to the right/left to zoom in on/out of the piano keyboard display.

The C keys show the note names of the corresponding pitches.

You can activate **Pitch Visibility On/Off** on the **Key Editor** toolbar to show only the pitches with events or the pitches suggested by the **Scale Assistant**. This hides the keyboard keys whose pitches are not used and shows note names on the remaining keys.

NOTE

You can change the naming format and the note names of the pitches in the **Pitch Notation** section of the **Preferences** dialog (**Event Display—Chords&Pitches** page).

If you select note events in the event display, the corresponding keys on the piano keyboard display are shown in the same color as the note event.

NOTE

You can use the **Event Colors** menu in the **Key Editor** toolbar to select a color scheme.

If you move the mouse pointer in the event display, the corresponding pitch position on the piano keyboard display is highlighted.

RELATED LINKS

- [Note Display](#) on page 654
- [Key Editor](#) on page 643
- [Pitch Notation](#) on page 836
- [Pitch Visibility Options](#) on page 657
- [Event Colors Menu](#) on page 615

Showing Specific Pitches in the Key Editor

You can define which pitches are visible in the event display and the piano keyboard display of the **Key Editor**. By hiding pitches that you do not need, you can save screen space. This is useful if you add note events that span more than one octave and you want to display all of them, for example.

PROCEDURE

1. On the **Key Editor** toolbar, open the **Select Pitch Visibility Options** pop-up menu.
2. Do one of the following:
 - To show only the pitches for which events are available in the note display, select **Show Pitches with Events**.

NOTE

If you edit multiple MIDI parts, the pitches of all note events in the different MIDI parts are taken into account. The visible pitches are updated according to the MIDI part selection in the **Project** window.

- To show only the pitches that match the musical scale that is selected in the **Scale Assistant** section of the **Key Editor Inspector**, select **Show Pitches from Scale Assistant**.
-

RESULT

The note display and the piano keyboard display are changed according to your settings.

EXAMPLE

If you selected **Show Pitches from Scale Assistant** in the **Select Pitch Visibility Options** pop-up menu and the **Scale Assistant** uses a specific scale, but some of the notes in the note display do not match the scale, this is indicated by the color of the note events, and by the exclamation mark on the corresponding keys on the keyboard display.



RELATED LINKS

- [Pitch Visibility Options](#) on page 657
- [Key Editor Toolbar](#) on page 645
- [Note Display](#) on page 654
- [Key Editor Piano Keyboard Display](#) on page 655

Pitch Visibility Options

The pitch visibility options allow you to show or hide specific pitches from the **Key Editor** event display and the piano keyboard display. Pitch visibility options are saved with the program. If a setting leads to a situation where no pitches would be shown, all pitches are shown instead.

- To open the pitch visibility options, click **Select Pitch Visibility Options** on the **Key Editor** toolbar.



The following options are available:

Show Pitches with Events

Allows you to show only the pitches for which events are available in the note display.

NOTE

If you edit multiple MIDI parts, the pitches of all note events in the different MIDI parts are taken into account. The visible pitches are updated according to the MIDI part selection in the **Project** window.

Show Pitches from Scale Assistant

Allows you to show only the pitches that match the musical scale that is selected in the **Scale Assistant** section of the **Key Editor Inspector**.

- Use Editor Scale**

Shows only notes that match the editor scale.

NOTE

If the note display contains note events on pitches that do not match the selected scale, the corresponding keys on the keyboard display are shown with

an exclamation mark. If you activate the **Scale/Chords** option in the **Event Colors** pop-up menu on the **Key Editor** toolbar, the non-matching note events are shown in a different color.

- **Use Chord Track**
Shows only notes that match the chord track. The **Chord Track Mode** that you selected for the **Scale Assistant** determines if the pitches of the scale, the chord, or both are visible.

RELATED LINKS

[Event Colors Menu](#) on page 615

[Key Editor Piano Keyboard Display](#) on page 655

[Note Display](#) on page 654

[Showing Specific Pitches in the Key Editor](#) on page 656

Pitch Editing with Reduced Pitch Visibility

If you edit pitches and you reduced the pitch visibility using one of the **Select Pitch Visibility Options**, you must consider some general program behavior.

As a general rule, you can only move note events to pitch positions that are visible. This applies to moving note events upwards/downwards with the mouse, using the corresponding key command, or using the cursor keys.

Exceptions

If you want to access specific pitch positions that are not displayed, you have the following possibilities:

- To move note events to pitch positions that are not visible, use the **Pitch** value field on the info line.
- To move note events by octaves, select the note event and press **Shift - Up Arrow** to move it up an octave or **Shift - Down Arrow** to move it down an octave.
- To move chord notes, open the **Chord Editing** section and activate an option in the **Inversions** or **Drop Notes** section.

In all these cases, the note display and the piano keyboard display extend to show the new pitches.

RELATED LINKS

[Pitch Visibility Options](#) on page 657

[Note Display](#) on page 654

[Key Editor Piano Keyboard Display](#) on page 655

Key Editor Operations

This section describes the principal editing operations within the **Key Editor**.

Matching Note Events to a Musical Scale

You can select a musical scale that is based on all or selected note events in the **Key Editor** and match note events to it.

PROCEDURE

1. Open a MIDI part in the **Key Editor**.
2. Open the **Scale Assistant** section of the **Inspector**, and activate **Use Editor Scale**.
3. Do one of the following:
 - Select some note events in the note display if you want to get suggestions of musical scales that match those notes.
 - Deselect all note events in the note display if you want to get suggestions of musical scales that match all notes of the MIDI part.
4. Activate **Show Scale Note Guides**.

This changes the background of the event display according to the selected scale so that pitches that do not belong to the scale are shown with a darker background.
5. On the **Key Editor** toolbar, set **Event Colors** to **Scale/Chords**.

This changes the colors of the note events in the event display according to whether or not the pitches match the selected musical scale.

NOTE

To view the color scheme of the selected color mode, open the **Event Colors** pop-up menu and select **Setup**.

6. Open the **Scale Suggestions** pop-up menu, and select one of the options.
7. Optional: On the **Key Editor** toolbar, open the **Select Pitch Visibility Options** pop-up menu, and select **Show Pitches from Scale Assistant**.

This filters the note display and the piano keyboard display so that they show only the pitches that match the selected musical scale.

RESULT

The coloring of the event display background and the note events gives you a visual guide for editing note pitches.

AFTER COMPLETING THIS TASK

If you need more assistance to match note events to the nearest pitches of the selected musical scale, you can click **Quantize Pitches** to quantize pitches of already existing MIDI notes, activate **Snap Pitch Editing** to snap the note pitches of MIDI notes while editing, or **Snap Live Input** to map the note pitches of incoming MIDI.

RELATED LINKS

[Using the Chord Track to Match Note Events to a Musical Scale](#) on page 660

[Scale Assistant in the Key Editor](#) on page 653

[Showing Specific Pitches in the Key Editor](#) on page 656

[Snapping MIDI Note Pitches to Musical Scales While Editing](#) on page 662

[Mapping Incoming MIDI Note Pitches to Musical Scales](#) on page 661
[Quantizing MIDI Note Pitches to Musical Scales](#) on page 661

Using the Chord Track to Match Note Events to a Musical Scale

You can select a musical scale that is defined by chords or scales on the chord track and match note events to it.

PREREQUISITE

You have added a chord track with chord events to your project.

PROCEDURE

1. Open a MIDI part in the **Key Editor**.
2. Open the **Scale Assistant** section of the **Inspector**, and activate **Use Chord Track**.
3. Open the **Chord Track Mode** pop-up menu and do one of the following:
 - Select **Scales** if you want to match note events to the scale events on the chord track.
 - Select **Chords** if you want to match note events to the chord events on the chord track.
 - Select **Chords & Scales** if you want to match note events to both scale and chord events on the chord track.
4. Activate **Show Scale Note Guides**.

This changes the background of the event display according to the selected scale so that pitches that do not belong to the scale are shown with a darker background.
5. On the **Key Editor** toolbar, set **Event Colors** to **Scale/Chords**.

This changes the colors of the note events in the event display according to whether or not the pitches match the selected musical scale.

NOTE

To view the color scheme of the selected color mode, open the **Event Colors** pop-up menu and select **Setup**.

6. Optional: On the **Key Editor** toolbar, open the **Select Pitch Visibility Options** pop-up menu, and select **Show Pitches from Scale Assistant**.

This filters the note display and the piano keyboard display so that they show only the pitches that match the selected musical scale.

RESULT

The coloring of the event display background and the note events gives you a visual guide for editing note pitches.

NOTE

As you might have added different scale/chord events at specific time positions, the scale indications in the event display background and on the note events change along the timeline.

AFTER COMPLETING THIS TASK

If you need more assistance to match note events to the nearest pitches of the selected musical scale, you can click **Quantize Pitches** to quantize pitches of already existing MIDI notes, activate **Snap Pitch Editing** to snap the note pitches of MIDI notes while editing, or activate **Snap Live Input** to map the note pitches of incoming MIDI.

RELATED LINKS

- [Event Colors Menu](#) on page 615
- [Matching Note Events to a Musical Scale](#) on page 659
- [Scale Assistant in the Key Editor](#) on page 653
- [Showing Specific Pitches in the Key Editor](#) on page 656
- [Chord Track](#) on page 705

Quantizing MIDI Note Pitches to Musical Scales

You can quantize MIDI note pitches to the nearest pitch of the selected scale.

PREREQUISITE

In the **Key Editor**, you have selected a scale for your MIDI notes or you have selected a **Chord Track Mode**.

PROCEDURE

1. Open the **Scale Assistant** section of the **Inspector**.
 2. Optional: Activate **Show Scale Note Guides**.
 3. Do one of the following:
 - Select the notes in the note event display whose pitches you want to quantize.
 - Deselect all notes in the note event display to quantize all note pitches of the MIDI part.
 4. Click **Quantize Pitches**.
-

RESULT

All note pitches that do not match the selected scale are quantized to the nearest pitches in the scale.

RELATED LINKS

- [Matching Note Events to a Musical Scale](#) on page 659
- [Using the Chord Track to Match Note Events to a Musical Scale](#) on page 660
- [Scale Assistant in the Key Editor](#) on page 653
- [Snapping MIDI Note Pitches to Musical Scales While Editing](#) on page 662
- [Mapping Incoming MIDI Note Pitches to Musical Scales](#) on page 661
- [Quantizing MIDI Note Pitches to Musical Scales](#) on page 661

Mapping Incoming MIDI Note Pitches to Musical Scales

When monitoring or recording in the **Key Editor**, you can map the note pitches of incoming MIDI to the nearest pitches of the selected scale.

PREREQUISITE

In the **Key Editor**, you have selected a scale for the MIDI notes or you have selected a **Chord Track Mode**.

PROCEDURE

1. Open the **Scale Assistant** section of the **Inspector**.
2. Activate **Show Scale Note Guides**.
3. On the **Key Editor** toolbar, activate **Record in Editor**.
4. Click **Start** on the **Transport** panel or in the **Transport Bar** to start playback.
5. Activate **Snap Live Input**.

6. Play or record some notes on your MIDI keyboard.
-

RESULT

The pitches of the played or recorded notes are automatically mapped to the selected scale.

RELATED LINKS

[Matching Note Events to a Musical Scale](#) on page 659

[Using the Chord Track to Match Note Events to a Musical Scale](#) on page 660

[Scale Assistant in the Key Editor](#) on page 653

[Using Live Input](#) on page 719

Snapping MIDI Note Pitches to Musical Scales While Editing

You can snap the note pitches of MIDI notes to the nearest pitches of the selected scale while editing in the **Key Editor**.

PREREQUISITE

In the **Key Editor**, you have selected a scale for your MIDI notes or you have selected a **Chord Track Mode**.

PROCEDURE

1. Open the **Scale Assistant** section of the **Inspector**.
 2. Activate **Show Scale Note Guides**.
 3. Activate **Snap Pitch Editing**.
 4. Do one of the following:
 - Insert a note event with the **Draw** tool, the **Object Selection** tool, or with the **Line** tool.
 - Drag a note event upwards or downwards with the mouse.
 - Select a note event and use the **Up Arrow**/**Down Arrow** keys.
-

RESULT

The notes snap to pitches of the selected scale. You cannot place notes on pitches outside of the scale. If you select multiple notes and move them to different pitches, all selected notes snap to the pitches of the selected scale.

NOTE

Snap Pitch Editing does not apply when you change pitches using the **Pitch** value field on the info line or if you record notes via MIDI input.

RELATED LINKS

[Matching Note Events to a Musical Scale](#) on page 659

[Using the Chord Track to Match Note Events to a Musical Scale](#) on page 660

[Scale Assistant in the Key Editor](#) on page 653

[Drawing Note Events with the Draw Tool](#) on page 663

[Inserting Note Events with the Object Selection Tool](#) on page 663

[Drawing Note Events with the Line Tool](#) on page 664

[Moving and Transposing Note Events](#) on page 665

[Modifying Note Values while Inserting Notes](#) on page 664

Inserting Note Events with the Object Selection Tool

You can insert note events with the **Object Selection** tool.

PREREQUISITE

You have set up the length for the note events quantize value in the **Length Quantize** pop-up menu of the toolbar.

PROCEDURE

- In the note display, double-click with the **Object Selection** tool at the position where you want to insert a note.

RESULT

A note is inserted at the position where you double-clicked with the length that you have set up in the **Length Quantize** pop-up menu.

Deleting Note Events

PROCEDURE

- Perform one of the following actions:
 - Select the **Erase** tool and click the event.
 - Select the **Object Selection** tool and double-click the event.

RESULT

The note event is deleted.

RELATED LINKS

[Key Editor Toolbar](#) on page 645

Drawing Note Events with the Draw Tool

The **Draw** tool allows you to insert single note events in the note display.

When you move the cursor inside the note display, its position is indicated on the status line. Its pitch is indicated both on the status line and on the piano keyboard to the left.

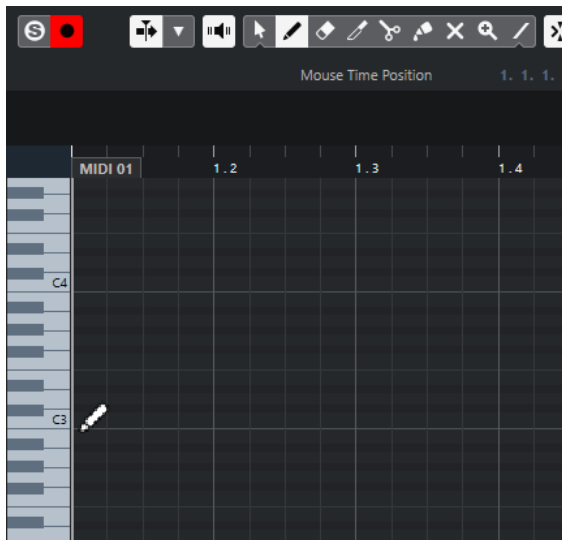

- To draw a note, click in the note display.
The note event has the length that is set on the **Length Quantize** pop-up menu.
- To draw longer note events, click and drag in the note display.
The length of the note event is a multiple of the Length Quantize value. If **Length Quantize** is set to **Quantize Link**, the note value is determined by the quantize grid. The **Snap** function is taken into account.

NOTE

To temporarily switch from the **Object Selection** tool to the **Draw** tool, hold down **Alt/Opt**.

Modifying Note Values while Inserting Notes

When inserting note events, you can modify specific note values on the fly.

- To edit the note velocity, drag upwards or downwards.
- To edit the note pitch, hold down **Alt/Opt** and drag upwards or downwards.
- To edit the note length, drag to the left or to the right.
- To edit the time position, hold down **Shift** and drag to the left or to the right.

NOTE

You can activate/deactivate **Snap** temporarily by holding down **Ctrl/Cmd**.

Drawing Note Events with the Line Tool

In the note display, the **Line** tool allows you to draw a series of contiguous note events along different line shapes.

- To create contiguous note events, click and drag in the note display.
- To restrict movement to horizontal, press **Ctrl/Cmd** and drag.
The notes have the same pitch.

If **Snap** is activated, the note events and controller events are positioned and sized according to the **Quantize** and **Length Quantize** values.

RELATED LINKS

[Line Tool Modes](#) on page 665

Line Tool Modes

The **Line** tool allows you to create a series of contiguous note events along different line shapes. You can also edit multiple controller events simultaneously.

- To open the **Line** tool modes, click **Line**.

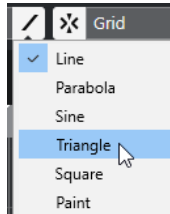

The following line modes are available:

Line

If this option is activated, you can click and drag to insert note events in the note display along a straight line in any angle. Use this option to edit controller data along a straight line in the controller display.

Parabola, Sine, Triangle, Square

These modes insert note events along different curve shapes.

Paint

This mode allows you to insert note events by painting in the note display.

Moving and Transposing Note Events

There are several options to move and transpose note events.

- To move note events in the editor, select the **Object Selection** tool and drag them to a new position.
All selected note events are moved, maintaining their relative positions. **Snap** is taken into account.
- To allow only horizontal or only vertical movement, hold down **Ctrl/Cmd** while dragging.
- To move note events via the buttons in the **Nudge** section on the toolbar, select the note events and click a button.
- To move note events to the project cursor position, select the note events and select **Edit > Move > Event Starts to Cursor**.
- To move a note event via the info line, select a note event and edit the **Position** or **Pitch** on the info line.
- To transpose note events, select the note events and use the **Up Arrow** / **Down Arrow** keys.
- To transpose note events via the **Transpose Setup** dialog, select the note events and select **MIDI > Transpose Setup**.
- To transpose note events in steps of one octave, press **Shift** and use the **Up Arrow** / **Down Arrow** keys.

NOTE

- When you move selected note events to a different position, any selected controllers for these note events move accordingly.

- You can also adjust the position of note events by quantizing.
-

RELATED LINKS

[Transpose Setup Dialog](#) on page 602

Resizing Note Events

Do one of the following:

- To resize the note event, position the **Object Selection** tool at the start or the end of a note event and drag the mouse cursor to the left or right.
- To move the start or end positions of the selected notes in steps according to the **Length Quantize** value on the toolbar, use the **Nudge Start Left**, **Nudge Start Right**, **Nudge End Left**, and **Nudge End Right** buttons in the **Nudge** section.
- Select the note and adjust its length on the info line.
- Select **Draw** and drag left or right within the note display to draw a note.
The resulting note event length is a multiple of the **Length Quantize** value on the toolbar.
- Select **Trim** and cut off the end or the beginning of note events.

RELATED LINKS

[Setup Options](#) on page 817

[Value Editing Rules on the Info Line](#) on page 46

[Using the Trim Tool](#) on page 666

[Resizing Events with the Object Selection Tool - Sizing Applies Time Stretch](#) on page 166

Using the Trim Tool

The **Trim** tool allows you to change the length of note events by cutting off the end or the beginning of notes. Using the **Trim** tool means moving the note-on or the note-off event for one or several notes to a position defined with the mouse.

PROCEDURE

1. Select **Trim** on the toolbar.
The mouse pointer changes to a knife symbol.
2. To edit a single note, click it.
The range between the mouse pointer and the end of the note is removed. Use the mouse note info on the status line to find the exact position for the trim operation.
3. To edit several notes, click and drag with the mouse across the notes.



By default, the **Trim** tool cuts off the end of notes. To trim the beginning of notes, press **Alt** while dragging. When dragged across several notes, a line is displayed. The notes are trimmed along this line. If you press **Ctrl/Cmd** while dragging, you get a vertical trim line, allowing you to set the same start or end time for all edited notes. You can change the **Trim** tool key commands in the **Preferences** dialog (**Editing—Tool Modifiers** page).

Splitting Note Events

- To split the note at the position that you point, select **Split**, and click on a note.
If several notes are selected, they are all split at the same position. The snap setting is taken into account.
- To split all notes that are intersected by the project cursor position, select **Edit > Functions > Split at Cursor**.
- To split all notes that are intersected by the left or right locator at the locator positions, select **Edit > Functions > Split Loop**.

Gluing Note Events

You can glue together note events of the same pitch.

- To glue note events, select **Glue** and click on a note event.
The note event is glued together with the next note event of the same pitch. The result is a long note event that spans from the start of the first note to the end of the second note. The properties (velocity, pitch, etc.) of the first note event apply.

Changing the Pitch of Chords

You can use the chord type buttons to change the pitch of chords.

PROCEDURE

1. In the **Key Editor Inspector**, open the **Chord Editing** section.
 2. In the note display, select the notes that you want to edit.
If the chord is recognized, the root note, chord type, and tensions are indicated in the **Chord Type** field. This also works with arpeggiated notes.
 3. In the **Chord Editing** section, activate one of the **3-Note Chords/Triads** buttons or **4-Note Chords** buttons.
The selected notes are transposed so that they fit the selected chord type.
 4. Use the **Up Arrow** / **Down Arrow** keys to change the pitch of the chord.
-

Changing the Voicing of Chords

PROCEDURE

1. In the **Key Editor Inspector**, open the **Chord Editing** section.
 2. In the note display, select the notes that you want to edit.
 3. In the **Chord Editing** section, use the **Inversions** buttons and the **Drop Notes** buttons to change the voicing.
-

RESULT

The selected notes are transposed so that they fit the selected chord type.

Chord Editing Section

The **Chord Editing** section in the **Key Editor Inspector** allows you to insert and edit chords, and change voicings.

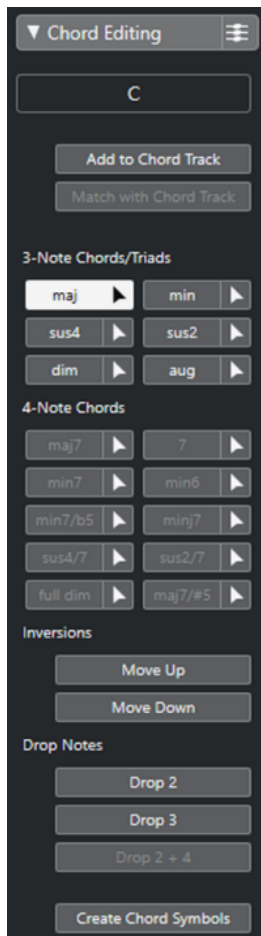

Chord type of selected notes

Shows the chord type of the selected chords.

Add to Chord Track

Adds the chord indicated in the **Chord type of selected notes** field to the chord track. The chord event is inserted at the position on the chord track that corresponds to the position of the MIDI notes. Any existing chord events at this position are overwritten.

Match with Chord Track

Applies the chord events from the chord track to the selected notes in the MIDI editor. The chord event that is effective at the position of the first selected note is applied to the selected notes, which are then transposed. Only the basic chord type is applied. Tensions are not taken into account.

Only the first effective chord event is applied.

3-Note Chords/Triads

Allows you to insert triads to the note display. You can also click one of the **3-Note Chords/Triads** buttons to transpose the selected notes so that they fit to the selected chord type.

4-Note Chords

Allows you to insert 4-note chords to the note display. You can also click one of the **4-Note Chords** buttons to transpose the selected notes so that they fit to the selected chord type.

Inversions - Move Up



Inverts the lowest note of a chord. The corresponding notes are transposed by as many octaves as needed.

Inversions - Move Down



Inverts the highest note of a chord. The corresponding notes are transposed by as many octaves as needed.

Drop Notes - Drop 2



Moves the second highest note of a chord down by one octave.

Drop Notes - Drop 3



Moves the third highest note of a chord down by one octave.

Drop Notes - Drop 2 + 4



Moves the second and fourth highest notes of a chord down by one octave.

Create Chord Events

Performs a chord analysis of the selected notes. If no note is selected, the whole MIDI part is analyzed.

RELATED LINKS

[Create Chord Events Dialog](#) on page 723

Inserting Chords

You can use the tools in the **Chord Editing** section of the **Key Editor Inspector** to insert and edit chords.

PROCEDURE

1. In the **Key Editor Inspector**, open the **Chord Editing** section.
 2. Select the **Insert** tool  to the right of the chord type that you want to insert.
 3. Click in the note display and drag to the left or right to determine the length of the chord. Drag up or down to determine its pitch.
To change the chord type while you insert chords, hold **Alt** and drag up or down.
If **Acoustic Feedback** is activated, you hear the chord while dragging. A tooltip indicates the root note and chord type of the inserted chord. **Snap** and **Length Quantize** are taken into account.
-

Applying Chord Events to Note Events

You can apply chord events from the chord track to notes in the MIDI editor.

PREREQUISITE

Create a chord track and add chord events.

PROCEDURE

1. Open the MIDI editor.
2. In the **Key Editor Inspector**, open the **Chord Editing** section.
3. Select **Match with Chord Track**.

RESULT

The first chord event of the chord track is applied to the selected notes. Only the basic chord type is applied. Tensions are not taken into account.

Drum Map Handling

When a drum map is assigned to a MIDI or instrument track, the **Key Editor** displays the drum sound names as defined by the drum map. This allows you to use the **Key Editor** for drum editing, for example, when editing drum note lengths or when editing several parts to identify drum events.

The name of the drum sound is displayed in the following locations:

- On the info line in the **Pitch** field.
- On the status line in the **Mouse Value** field.
- In the note event if the zoom factor is high enough.
- When dragging a note event.

Editing Note Events via MIDI Input

You can directly hear your editing results. Editing the properties of note events via MIDI can be a quick way to, for example, set the velocity value of a note event.

PROCEDURE

1. In the **Key Editor**, select the note event that you want to edit.
2. Click **MIDI Input** on the toolbar.
Editing via MIDI is enabled.
3. Use the note buttons on the toolbar to decide which properties are changed by the MIDI input.
You can enable editing of pitch, note-on and/or note-off velocity. For example, you can get the pitch and velocity values of the notes input via MIDI, but the note-off velocities remain as they are.
4. Play a note on your MIDI instrument.

RESULT

The selected note gets the pitch, note-on velocity and/or note-off velocity of the played note. The next note in the edited part is automatically selected to allow quick editing of a series of notes.

AFTER COMPLETING THIS TASK

To try another setting, select the note again and play a note on your MIDI instrument.

Step Input

Step input, or step recording, allows you to enter note events or chords one at a time without worrying about the exact timing. This is useful, for example, when you know the part that you want to record but are not able to play it exactly as you want it.

PROCEDURE

1. On the toolbar, activate **Step Input**.
2. Use the note buttons to the right to determine which properties are included when you insert the note events.
For example, you can include the note-on velocity and/or note-off velocity of the played notes. You can also deactivate the pitch property, in which case all notes get a pitch C3, no matter what you play.
3. Click anywhere in the note display to set the start position of the first note event or chord.
The step input position is shown as a vertical line in the note display.

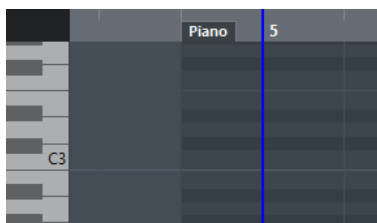

4. Specify the note event spacing and length with the **Quantize** and **Length Quantize** pop-up menus.
The note events that you insert are positioned according to the **Quantize** value and have the length of the **Length Quantize** value.

NOTE

If **Length Quantize** is set to **Quantize Link**, the note length is also determined by the **Quantize** value.

5. Play the first note event or chord on your MIDI instrument.
The note event or chord appears in the editor and the step input position advances by one quantize value step.

NOTE

If **Move Insert Mode** is activated, all note events to the right of the step input position are moved to make room for the inserted note event or chord.

6. Continue in the same way with the rest of the note events or chords.
You can adjust the **Quantize** or **Length Quantize** values to change the timing or note event lengths. You can also move the step input position manually by clicking anywhere in the note display.
To insert a rest, press the **Right Arrow** key. This advances the step input position by one step.
 7. When you are done, click **Step Input** again to deactivate step input.
-

Score Editor

The basic **Score Editor** shows MIDI notes as a musical score. This offers basic score editing and printing options.

You can open the **Score Editor** in a separate window or in the lower zone of the **Project** window. Opening the **Score Editor** in the lower zone of the **Project** window is useful if you want to access the **Score Editor** functions from within a fixed zone of the **Project** window.

To open a MIDI part in the **Score Editor**, do one of the following:

- Select a MIDI part in the **Project** window and select **MIDI > Scores > Open Score Editor**.
- Select a MIDI part in the **Project** window and press **Ctrl/Cmd - R**.

NOTE

If you select **MIDI > Set up Editor Preferences**, the **Preferences** dialog opens on the **Editors** page. Make your changes to specify if you want editors to open in a separate window or in the lower zone of the **Project** window.

The **Score Editor** window:

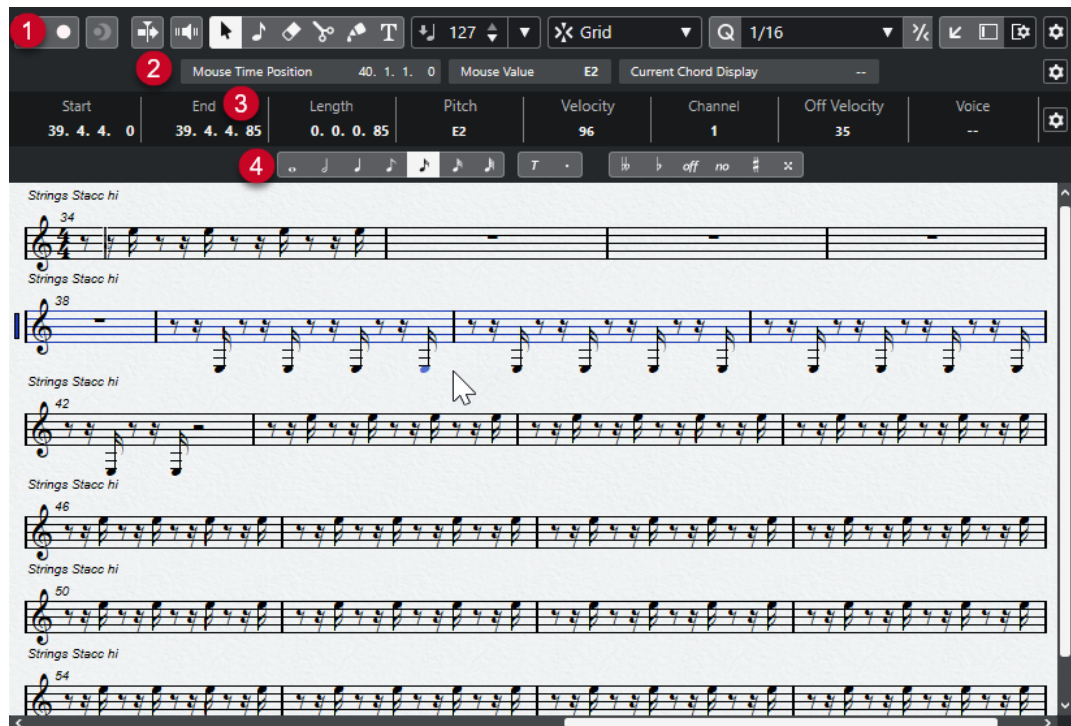

The **Score Editor** is divided into several sections:

- 1 Toolbar**
Contains tools and settings.
- 2 Status line**
Informs about the mouse time position, the mouse value, and the current chord.
- 3 Info line**
Displays note event information about a selected MIDI note.
- 4 Extended toolbar**
Contains note value buttons and enharmonic shift buttons.

- To open one or several parts in the **Score Editor**, select one or several tracks or any number of parts, and select **MIDI > Open Score Editor**.
If you have selected parts on several tracks, you get one staff for each track. The staves are tied together by barlines and placed in the order of the tracks in the **Project** window.
- To rearrange the staves, close the editor and in the **Project** window, rearrange the tracks. Then reopen the **Score Editor**.

NOTE

You can activate/deactivate the status line, the info line, the tools, and the filters by clicking **Set up Window Layout** on the toolbar and activating/deactivating the corresponding options.

Score Editor Toolbar

The toolbar contains tools and various settings for the **Score Editor**.

- To show or hide the toolbar elements, right-click the toolbar and activate or deactivate the elements.

Edit Solo

Solo Editor



Solos the editor during playback if the editor has the focus.

Record in Editor



Enables the recording of MIDI data in the editor if the editor has the focus.

NOTE

This only works if **MIDI Record Mode** is set to **Merge** or **Replace**.

Retrospective Record

Insert MIDI Retrospective Recording in Editor



Allows you to recover MIDI notes that you played in stop mode or during playback.

Left Divider

Left Divider

Tools that are placed to the left of the divider are always shown.

Auto-Scroll

Auto-Scroll



Keeps the project cursor visible during playback.

Acoustic Feedback

Acoustic Feedback



Automatically plays back events when you move or transpose them, or when you create them by drawing.

Tool Buttons

Object Selection



Selects events and parts.

Insert Note



Inserts notes.

Erase



Deletes events.

Split



Splits events.

Glue



Glues together events of the same pitch.

Insert Text



Inserts text.

Insert Velocity

Note Insert Velocity



Allows you to specify a velocity value for new notes.

Snap

Snap Type



Allows you to select one of the following snap types:

- **Grid** snaps events to the grid that is selected in the **Quantize Presets** pop-up menu.
- **Grid Relative** keeps the relative positions when snapping events to the grid.

Quantize

Apply Quantize



Applies the quantize settings.

Quantize Presets



Allows you to select a quantize or a groove preset.

Soft Quantize On/Off



Activates/Deactivates soft quantize.

Open Quantize Panel



Opens the **Quantize Panel**.

Length Quantize

Length Quantize

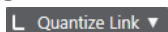

Allows you to set a value for quantizing event lengths.

Step/MIDI Input

Computer Keyboard Input



Activates/Deactivates computer keyboard input.

Step Input



Activates/Deactivates MIDI step input.

MIDI Input



Activates/Deactivates MIDI input and note expression MIDI input.

Move Insert Mode



Moves all note events to the right of the step input position to the right to make room for the inserted event when you insert notes.

NOTE

This only works if **Step Input** is activated.

Record Pitch



Includes the pitch when you insert notes.

Record NoteOn Velocity



Includes the NoteOn velocity when you insert notes.

Record NoteOff Velocity



Includes the NoteOff velocity when you insert notes.

Right Divider

Right Divider

Allows you to use the right divider. Tools that are placed to the right of the divider are always shown.

Window Zone Controls

Open in Separate Window



This button is available in the **Editor** tab in the lower zone. It opens the editor in a separate window.

Open in Lower Zone



This button is available in the editor window. It opens the **Editor** tab in the lower zone of the **Project** window.

Show/Hide Left Zone



Shows/Hides the left zone.

Set up Window Layout



Allows you to set up the window layout.

Set up Toolbar



Opens a pop-up menu where you can set up which toolbar elements are visible.

Status Line

The status line is displayed below the toolbar. It shows important information about the mouse position and the chord display. Select the notes that form (compose) the chord to make the status line appear in the **Current Chord Display**.

- To show or hide the status line, click **Set up Window Layout** on the toolbar, and activate or deactivate **Status Line**.



The on/off status of the status line in the **Score Editor** window and in the **Editor** tab in the lower zone of the **Project** window are independent of each other.

Mouse Time Position

Displays the exact time position of the mouse pointer, depending on the selected ruler display format. This lets you edit or insert notes at exact positions.

Mouse Value

Displays the exact pitch of the mouse pointer position in the event display. This facilitates finding the right pitch when entering or transposing notes.

Current Chord Display

When the project cursor is positioned over notes that form a chord, this chord is displayed here.

Info Line

The info line shows values and properties of the selected MIDI notes. If several notes are selected, the values for the first note are displayed in color.

- To show or hide the info line, click **Set up Window Layout** on the toolbar, and activate or deactivate **Info Line**.

Start	End	Length	Pitch	Velocity	Channel	Off Velocity	Release Length	Voice	Text
24. 4. 3. 40	25. 1. 1. 0	0. 0. 1. 80	F3	97	1	100	0. 0. 0. 0	--	

The on/off status of the info line in the **Score Editor** window and in the **Editor** tab in the lower zone of the **Project** window are independent of each other.

RELATED LINKS

[Changing the Ruler Display Format](#) on page 614

Score Editor Extended Toolbar

The extended toolbar contains note value buttons and enharmonic shift buttons.

- To show the extended toolbar, click **Set up Window Layout** on the toolbar, and activate **Tools**.

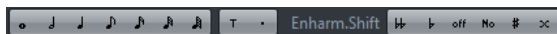

Note Value Buttons

Allows you to select a note value for input. The **tr** and **.** options are for triplet and dotted note values.

The selected note value is displayed in the **Length** value field on the info line.

To resize all selected notes to the same note value, press **Ctrl/Cmd** and click one of the note value buttons.

Enharmonic Shift

Allows you to manually select whether a note is displayed with flat or sharp accidentals.

The **Off** button resets the notes to original display. The other options are **double flats**, **flats**, **No** (no accidentals shown, regardless of pitch), **sharps**, and **double sharps**.

RELATED LINKS

[Enharmonic Shift](#) on page 683

Score Display

The main area of the **Score Editor** window shows the notes in the edited parts on one or several staves. Parts on different tracks are shown on different staves.



- If you are editing one or several parts on the same track, as much of them as possible is shown on several staves, comparable with a score on paper.
- If you are editing parts on several tracks, they are put on a grand staff. A grand staff is composed of multiple staves that are tied together by barlines.
- The number of bars that are displayed on the screen depends on the size of the window and the number of notes in each bar.
- The end of the last part is indicated by a double barline.

All MIDI input is directed to one of the tracks, which is called the active staff. The active staff is indicated by a rectangle to the left of the clef symbol.

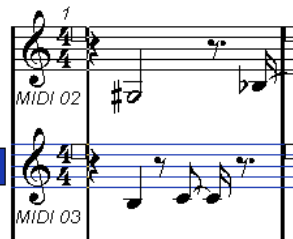

- To change the active staff, click on the staff that you want to activate.

Score Editor Operations

This section describes the principal editing operations within the **Score Editor**.

Improving the Score Display

When you open the **Score Editor** for a part that was recorded in real time, the score may not look as legible as you expect. The **Score Editor** can ignore the minor time variances in performance and make a neater score. To achieve this, the **Staff Settings** dialog provides settings that determine how the program displays the music.

Staff Settings Dialog

This dialog allows you to change how Cubase displays the music.

IMPORTANT

The settings that you make in this dialog are independent for each staff (track), but common for a piano staff that you have created with the **Split** option.

To open the **Staff Settings** dialog, do one of the following:

- Select a staff and select **MIDI > Scores > Staff Settings**.
- Double-click in the area to the left of the staff.

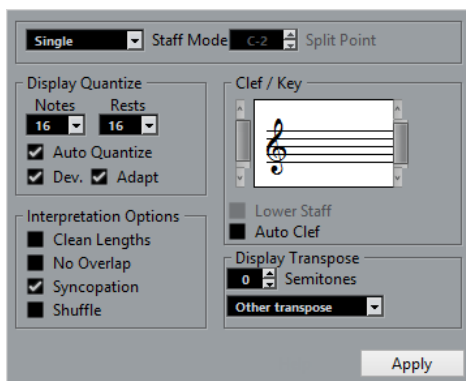

NOTE

The time signature follows the time signatures that are set in the **Tempo Track** editor. These settings are common to all tracks/staves in the score.

Staff Mode

The **Staff Mode** determines how the staff is shown.

- In **Single** mode, all notes in the part are shown in the same staff.
- In **Split** mode, the part is split on the screen into a bass and treble clef, as in a piano score. The **Split Point** value determines where you want the split to occur. Notes above and including the split note appear on the upper staff, and notes below the split note appear on the lower staff.

Display Quantize

This section allows you to change the way Cubase displays scores.

IMPORTANT

These display values are only used for the graphical display in the **Score Editor**. They do not affect the playback.

Notes

Determines the smallest note value to be displayed and the smallest position to be recognized and properly displayed. Set this to the smallest significant note position used in your music.

For example, if you have notes on odd 16th note positions, set this value to 16. The **T** values are for triplet note values. This setting is partly overridden by **Auto Quantize**.

Rests

This value is used as a recommendation. Cubase does not display rests smaller than this value, except where necessary. In effect, this setting also determines how the length of notes is displayed. Set this value according to the smallest note value (length) that you want to be displayed for a single note, positioned on a beat.

Auto Quantize

Allows you to make your score look as legible as possible. **Auto Quantize** allows you to mix straight notes with triplets (triplets) in a part. However, **Auto Quantize** also uses the (display) quantize value. If there is no appropriate note value for a certain note or group of notes, it uses the set quantize value is used to display it.

Generally, only activate this option if your music contains mixed triplets and straight notes. If the part is imprecisely played and/or complex, **Auto Quantize** may have a problem figuring out exactly what you mean.

Dev.

If this option is activated, triplets/straight notes are detected even if they are not exactly on the beat. However, if you know that your triplets/straight notes are perfectly recorded, either through quantizing or entered by hand, deactivate this option.

This option is only available if **Auto Quantize** is activated.

Adapt

If this option is activated, the program guesses that when one triplet is found, there are probably more triplets surrounding it. Activate this option if not all of your triplets are detected.

This option is only available if **Auto Quantize** is activated.

Clef/Key

In this section, you can set the correct clef and key.

Clef/Key display

Allows you to select the clef or key via the scrollbar.

Lower Staff

Sets the clef and key to the lower staff.

Auto Clef

If this option is activated, Cubase attempts to guess the correct clef, judging from the pitch of the music.

Display Transpose

In this section, you can specify a separate display transpose setting for each staff (track). This transposes the notes in the score without affecting how the notes are played back. This allows you to record and play back a multi staff arrangement and still score each instrument according to its own transposition.

Semitones

Allows you to manually set a display transpose value.

Instrument

Allows you to select the instrument for which you are scoring.

Interpretation Options

In this section, you can make additional settings on how the score is displayed.

Clean Lengths

If this option is activated, notes that are considered to be chords are shown with identical lengths. Longer notes are displayed shorter than they are. Notes with very short overlaps are also cut off. This is similar to the **No Overlap** option, but with a more subtle effect.

No Overlap

If this option is activated, one note is never shown as overlapping another, lengthwise. This allows long and short notes that start at the same point to be displayed without ties. The long notes are cut off in the display. This makes the music more legible.

A sample measure with **No Overlap** deactivated:

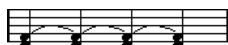

A sample measure with **No Overlap** activated:

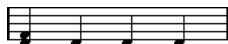

Syncopation

If this option is activated, syncopated notes are shown in a more legible way.

A dotted quarter note at the end of a bar when **Syncopation** is deactivated:

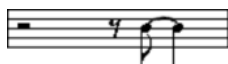

A dotted quarter note at the end of a bar when **Syncopation** is activated:

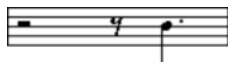

Shuffle

If this option is activated and you have played a shuffle beat, the beat is displayed as straight notes, not as triplets. This is very common in jazz notation.

Quantize Value

When you move the mouse pointer over the score, the **Mouse Time Position** field on the status line tracks your movement and shows the current position in bars, beats, 16th notes, and ticks.

The quantize value controls the positioning on screen. If you set the value to 1/8, you can only insert and move notes to 8th note positions, at quarter notes, at half bars, or at bar positions.

It is recommended to set the quantize value to the smallest note value in the piece. This does not stop you from inputting notes at coarser positions. However, if you set the quantize value to a too small note value, it is easier to make mistakes.



With the quantize value set to 1/8, you can only input notes at 8th note positions.

You can also use the **Quantize Panel** to create other quantize values, irregular grids, etc.

Creating Notes

In the score display, the **Insert Note** tool allows you to create notes.

PREREQUISITE

You have set the note value (length) and spacing.

PROCEDURE

1. Set the note value in one of the following ways:
 - Click the note symbols on the extended toolbar.
 - Select an option from the **Length Quantize** pop-up menu on the toolbar.
2. Select the **Insert Note** tool.

If you selected the note value via the extended toolbar buttons, the **Insert Note** tool is automatically selected.
3. Open the **Quantize Presets** pop-up menu on the toolbar and select a quantize value.
4. Move the mouse over the staff to find the correct position.

The **Mouse Value** display on the status line shows the pitch at the pointer position. The position is displayed on the **Mouse Time Position** display on the status line.
5. Click in the staff.

When you click and hold down the mouse button, the bars and beats positions are shown. This allows you to find the correct position.

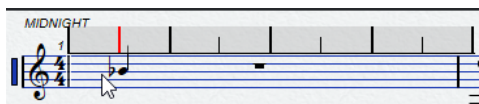

NOTE

The position snaps to the grid that is defined by the quantize value.

RESULT

The note appears in the score. The notes get the insert velocity value that is set in the **Note Insert Velocity** field on the toolbar.

NOTE

If the notes that you enter appear to have the wrong note value, you may have to adjust the **Display Quantize** settings. For example, if you entered a 1/32 note that is displayed as a 1/16 note.

RELATED LINKS

[Setting Velocity Values](#) on page 622

[Display Quantize](#) on page 679

Moving and Transposing Notes

PROCEDURE

1. Open the **Quantize Presets** pop-up menu on the toolbar and select a quantize value.
2. If you want to hear the pitch of the note while moving, activate **Acoustic Feedback** on the toolbar.
3. Select the notes that you want to move.
4. Click one of the selected notes and drag it to a new position and/or pitch.

The horizontal movement of the note snaps to the current quantize value. The position boxes on the toolbar show the position and pitch for the dragged note.

To restrict moving to one direction, press **Ctrl/Cmd** while dragging.

Duplicating Notes

PROCEDURE

1. Open the **Quantize Presets** pop-up menu on the toolbar and select a quantize value.
2. Select the notes that you want to duplicate.
3. Press **Alt/Opt** and drag the notes to their new position.

To restrict moving to one direction, press **Ctrl/Cmd** while dragging.

Changing the Note Length

The displayed note length is not necessarily the actual note length. It also depends on the note values and rest values for **Display Quantize** in the **Staff Settings** dialog. This is important to remember when you change the length of a note.

You can change the length of a note in the following ways:

- Select the notes that you want to change and **Ctrl/Cmd**-click on one of the note icons on the extended toolbar.
All the selected notes are assigned to the length of the clicked note.
- Select the notes that you want to change and edit the length values on the info line.

RELATED LINKS

- [Improving the Score Display](#) on page 678
- [Editing Note Events on the Info Line](#) on page 621

Splitting and Gluing Note Events

- To split 2 notes that are strung together by a tie, click on the tied note head with the **Split** tool.
- The note is split into 2, with the respective length of the main and the tied note.
- To glue a note to the next note with the same pitch, click on a note with the **Glue** tool.

Enharmonic Shift

You can perform an enharmonic shift on notes that are not displayed with the accidentals you wish.

PROCEDURE

1. Select the notes that you want to shift.
 2. Click one of the enharmonic shift buttons on the extended toolbar.
-

RELATED LINKS

- [Score Editor Extended Toolbar](#) on page 677

Flipping Stems

The direction of the note stems is automatically selected according to the note pitches. However, you can change this manually.

PROCEDURE

1. Select the notes for which you want to flip the stem direction.
 2. Select **MIDI > Scores > Flip Stems**.
-

Working with Text

You can use the **Text** tool to add comments, articulation, or instrumentation advice and other text strings anywhere in the score display.

Adding Text

PROCEDURE

1. On the toolbar, select the **Text** tool.
 2. Click anywhere in the score.
A blinking cursor indicates that you can enter text.
 3. Enter the text and press **Return**.
-

Editing Text

- To edit existing text, double-click it with the **Object Selection** tool.

This opens the text for editing. Use the **Up Arrow**, **Down Arrow**, **Left Arrow**, and **Right Arrow** keys to move the cursor, delete characters with the **Delete** or **Backspace** keys, press **Return** when you are finished.

- To delete text blocks, select them with the **Object Selection** tool and press **Backspace** or **Delete**.
- To move text blocks, drag them to a new position.
- To duplicate text blocks, press **Alt/Opt** and drag them to a new position.

Changing the Text Font, Size, and Style

You can change the font, size, and style of the text that you have added to the score display.

PROCEDURE

1. Do one of the following:
 - To change the settings for a specific text block, click on the text with the **Object Selection** tool.
 - To set the default settings for all new text blocks, unselect any selected text block and change the settings.
 2. Select **MIDI > Scores > Set Font**.
 3. In the **Font Settings** dialog, make your changes.
 4. Click **Apply**.
 5. Optional: Select another text block, adjust the settings, and click **Apply**.
-

Set Font Dialog

In this dialog, you can change the font, size, and style of the text that you have added to the score display.

- To open the **Set Font** dialog, select **MIDI > Scores > Set Font**.

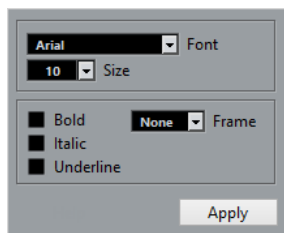

Font

Allows you to specify the font for the text. Which fonts are available on the pop-up menu depends on the fonts that you have installed on your computer.

IMPORTANT

Do not use the Steinberg fonts. These are special fonts used by the program, for example, for score symbols, and not suited for common text.

Size

Sets the size of the text.

Frame

Allows you to enclose the text in a rectangular (box) or oval frame.

Font options

Determine whether the text is formatted bold, italic, and/or underlined.

Printing the Score

PROCEDURE

1. Open the parts that you want to print in the **Score Editor**.
2. Select **File > Page Setup** and make sure that all your printer settings are correct.

IMPORTANT

If you change your setting for paper size, scale, and margins now, the score may change its look.

3. Click **OK**.
 4. Select **File > Print**.
 5. In the **Print** dialog, make your changes.
 6. Click **Print**.
-

Drum Editor

The **Drum Editor** is the editor to use when you are editing drum or percussion parts.

You can open the **Drum Editor** in a separate window or in the lower zone of the **Project** window. Opening the **Drum Editor** in the lower zone of the **Project** window is useful if you want to access the **Drum Editor** functions from within a fixed zone of the **Project** window.

To open a MIDI part in the **Drum Editor**, do one of the following:

- Select a MIDI part in the **Project** window and select **MIDI > Open Drum Editor**.

If the MIDI track has a drum map assigned and **Editor Content Follows Event Selection** and **Use Drum Editor when Drum Map is assigned** are activated in the **Preferences** dialog (**Editors** page), you can do the following to open a MIDI part in the **Drum Editor**:

- Double-click a MIDI part in the **Project** window.
- Select a MIDI part in the **Project** window and press **Return** or **Ctrl/Cmd - E**.
- Select a MIDI part in the **Project** window and select **MIDI > Open Drum Editor**.
- In the **Key Commands** dialog in the **Editors** category, assign a key command for **Open Drum Editor**. Select a MIDI part in the **Project** window and use the key command.

NOTE

If you select **MIDI > Set up Editor Preferences**, the **Preferences** dialog opens on the **Editors** page. Make your changes to specify if you want the **Drum Editor** to open in a separate window or in the lower zone of the **Project** window.

The **Drum Editor** window:

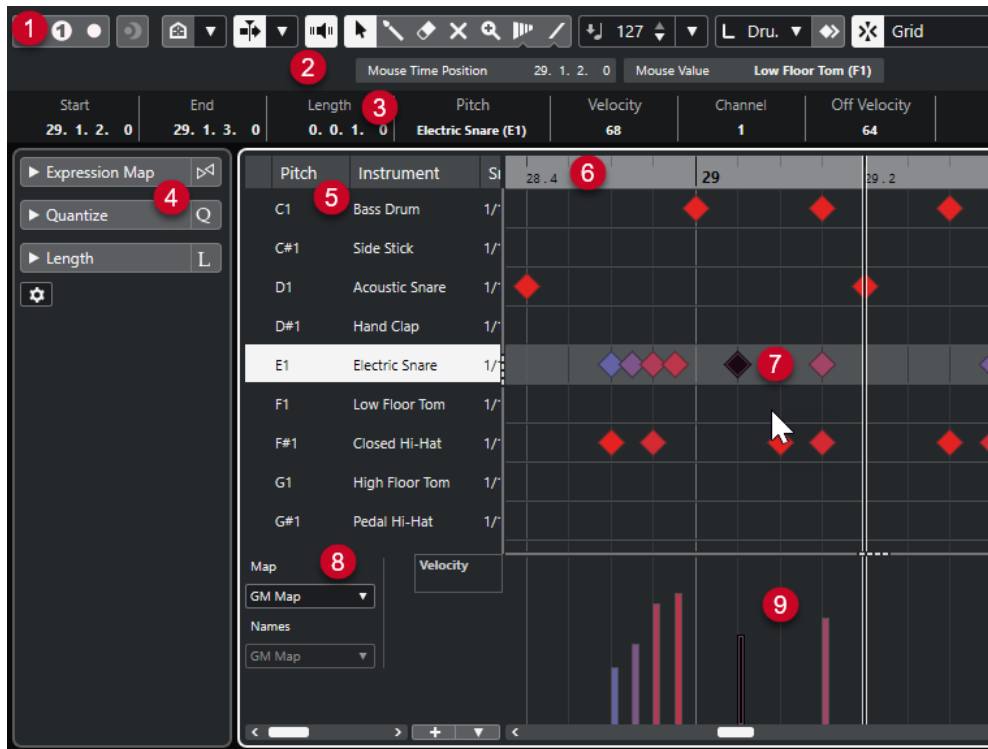

The **Drum Editor** is divided into several sections:

- 1 Toolbar**
Contains tools and settings.
- 2 Status line**
Informs about the mouse time position and the mouse value.
- 3 Info line**
Displays information about the selected event.
- 4 Drum Editor Inspector**
Contains tools and functions for working with MIDI data.
- 5 Drum sound list**
Lists all drum sounds.
- 6 Ruler**
Displays the time line.
- 7 Note display**
Contains a grid in which notes are displayed.
- 8 Drum map**
Lets you select the drum map for the edited track or a list of drum sound names.
- 9 Controller display**
The area below the note display consists of one or multiple controller lanes.

NOTE

You can activate/deactivate the status line, the info line, and the controller lanes by clicking **Set up Window Layout** on the toolbar and activating/deactivating the corresponding options.

Drum Editor Toolbar

The toolbar contains tools and various settings for the **Drum Editor**.

- To show or hide the toolbar elements, right-click the toolbar and activate or deactivate the elements.

Retrospective Record

Insert MIDI Retrospective Recording in Editor



Allows you to recover MIDI notes that you played in stop mode or during playback.

Left Divider

Left Divider

Allows you to use the left divider. Tools that are placed to the left of the divider are always shown.

Pitch Visibility

Pitch Visibility On/Off



Activates the selected pitch visibility option.

Select Pitch Visibility Options



Deactivate this to show all drum sounds in the note display. Activate this to reduce the drum sounds in the note display according to the selected pitch visibility option.

- **Show Drum Sounds with Events** shows only the drum sounds for which events are available in the note display.
- **Show Drum Sounds in Use by Instruments** shows the drum sounds for which a pad, etc. is in use for the instrument. This option is only available if the instrument can provide this information.
- **Reverse Drum Sound List** reverses the order of the sounds displayed in the drum sound list.

Auto-Scroll

Auto-Scroll



Keeps the project cursor visible during playback.

Select Auto-Scroll Settings



Allows you to activate **Page Scroll** or **Stationary Cursor** and to activate **Suspend Auto-Scroll When Editing**.

Acoustic Feedback

Acoustic Feedback



Automatically plays back events when you move or transpose them, or when you create them by drawing.

Tool Buttons

Object Selection



Selects events and parts.

Drumstick



Draws drum events.

Erase



Deletes events.

Mute



Mutes events.

Zoom



Zooms in. Hold **Alt/Opt** and click to zoom out.

Line



Creates a series of contiguous events.

Auto Select Controllers

Auto Select Controllers



Automatically selects controller data of the selected MIDI notes.

Independent Track Loop

Independent Track Loop



Activates/Deactivates the independent track loop.

Nudge

Nudge Start Left



Increases the length of the selected event by moving its start to the left.

Nudge Start Right



Decreases the length of the selected event by moving its start to the right.

Move Left



Moves the selected event to the left.

Move Right



Moves the selected event to the right.

Nudge End Left



Decreases the length of the selected event by moving its end to the left.

Nudge End Right



Increases the length of the selected event by moving its end to the right.

Transpose Palette

Move Up



Transposes the selected event up by a half note.

Move Down



Transposes the selected event down by a half note.

Move Up More



Transposes the selected event up by an octave.

Move Down More



Transposes the selected event down by an octave.

Insert Velocity

Note Insert Velocity



Allows you to specify a velocity value for new notes.

Notes Length

Insert Length

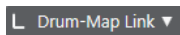

Allows you to determine a length for newly created notes.

Show Note Length On/Off



Shows drum notes as boxes that display the note length.

Snap

Snap On/Off



Activates/Deactivates the **Snap** function.

Snap Type



Allows you to select one of the following snap types:

- **Grid** snaps events to the grid that is selected in the **Quantize Presets** pop-up menu.
- **Grid Relative** keeps the relative positions when snapping events to the grid.
- **Events** snaps events to the start or end of other events.
- **Shuffle** changes the order of events if you drag one event to the left or right of other events.
- **Cursor** snaps events to the cursor position.
- **Grid + Cursor** snaps events to the quantize grid that is selected in the **Quantize Presets** pop-up menu or to the cursor position.
- **Events + Cursor** snaps events to the start or end of other events, or to the cursor position.
- **Grid + Events + Cursor** snaps events to the quantize grid that is selected in the **Quantize Presets** pop-up menu, to the start or end of other events or to the cursor position.

Grid Type



Allows you to select one of the following grid types:

- **Use Quantize** activates a grid where events snap to the value that is selected in the **Quantize Presets** pop-up menu.
- **Adapt to Zoom** activates a grid where events snap to the zoom level.
- **Use Snap from Drum Map** activates a grid where events snap to the **Snap** value that is selected in the drum map.

Quantize

Apply Quantize



Applies the quantize settings.

Quantize Presets



Allows you to select a quantize or a groove preset.

Soft Quantize On/Off



Activates/Deactivates soft quantize.

Open Quantize Panel



Opens the **Quantize Panel**.

Multiple Part Controls

Show Part Borders



Shows/Hides part borders for the active MIDI part within the left and right locators.

Part Editing Mode



Sets the editing mode for parts.

- **Edit All Parts** allows you to edit all parts that are opened in the **Editor** at the same time.
- **Edit Active Part** restricts editing operations to the part that is selected in the **Activate Part for Editing** pop-up menu.

Activate Part for Editing



Lists all parts that were selected when you opened the editor, and allows you to activate a part.

Event Colors

Event Colors

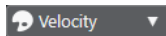

Allows you to select event colors.

Step/MIDI Input

Step Input



Activates/Deactivates MIDI step input.

MIDI Input/Note Expression MIDI Input



Activates/Deactivates MIDI input and note expression MIDI input.

Move Insert Mode



Moves all note events to the right of the step input position to the right to make room for the inserted event when you insert notes.

NOTE

This only works if **Step Input** is activated.

Record Pitch



Includes the pitch when you insert notes.

Record NoteOn Velocity



Includes the NoteOn velocity when you insert notes.

Record NoteOff Velocity



Includes the NoteOff velocity when you insert notes.

Right Divider

Right Divider

Allows you to use the right divider. Tools that are placed to the right of the divider are always shown.

Window Zone Controls

Open in Separate Window



This button is available in the **Editor** tab in the lower zone. It opens the editor in a separate window.

Open in Lower Zone



This button is available in the editor window. It opens the **Editor** tab in the lower zone of the **Project** window.

Show/Hide Left Zone



Shows/Hides the left zone.

Show/Hide Controller Lanes



Shows/Hides the controller lanes.

Set up Window Layout



Allows you to set up the window layout.

Set up Toolbar



Opens a pop-up menu where you can set up which toolbar elements are visible.

RELATED LINKS

[Zooming in MIDI Editors](#) on page 614

Status Line

The status line is displayed below the toolbar. It displays important mouse information.

- To show the status line, click **Set up Window Layout** on the toolbar, and activate **Status Line**.

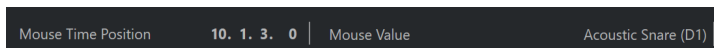

The on/off status of the status line in the **Drum Editor** window and in the **Editor** tab in the lower zone of the **Project** window are independent of each other.

Mouse Time Position

Displays the exact time position of the mouse pointer, depending on the selected ruler display format. This lets you edit or insert notes at exact positions.

Mouse Value

Displays the exact pitch of the mouse pointer position in the event display. This facilitates finding the right pitch when entering or transposing notes.

If you move the mouse in the controller display, the controller event value at the mouse cursor position is displayed.

Track Loop Start/Track Loop End

If **Independent Track Loop** is activated on the toolbar and you set up a loop, the start/end position is displayed.

RELATED LINKS

[Drum Editor Toolbar](#) on page 687

Info Line

The info line shows values and properties of the selected events. If several notes are selected, the values for the first note are displayed in color.

- To show the info line, click **Set up Window Layout** on the toolbar, and activate **Info Line**.

Start	End	Length	Pitch	Velocity
3. 1. 1. 0	3. 1. 2. 0	0. 0. 1. 0	Bass Drum (C1)	100
Channel	Off Velocity	Voice	Text	
9	64	--		

Length and position values are displayed in the selected ruler display format.

The on/off status of the info line in the **Drum Editor** window and in the **Editor** tab in the lower zone of the **Project** window are independent of each other.

RELATED LINKS

[Editing Note Events on the Info Line](#) on page 621

Drum Editor Inspector

The **Drum Editor Inspector** is located to the left of the note display. It contains tools and functions for working with MIDI data.



Quantize

Allows you to access the main quantize parameters. These are identical with the functions on the **Quantize Panel**.

Length

Contains length-related options, similar to the **Functions** submenu of the **MIDI** menu.

- To change the length of the selected MIDI events or all events of the active part if no events are selected, use the **Scale Length/Scale Legato** slider.
At the maximum value the notes reach the beginning of the next note.
- To make the new length settings permanent, click **Freeze MIDI Lengths**.
- To fine-tune the distance between consecutive notes, use the **Overlap** slider.
At **0 Ticks**, the **Scale Length/Scale Legato** slider extends each note so that it reaches the next note exactly. Positive values cause the notes to overlap and negative values allow you to define a small gap between the notes.

- To use the **Legato** function or slider to extend a note until the next selected note, activate **Extend to Next Selected**.

This is identical with activating the **Legato Mode: Between Selected Notes Only** option in the **Preferences** dialog.

Setup

Allows you to open a dialog to edit the **Drum Editor Inspector** settings. Click **Setup Inspector**, and from the pop-up menu, select **Setup**.

NOTE

If you open the **Drum Editor** in the lower zone, these sections are shown in the **Editor Inspector** in the left zone.

RELATED LINKS

[Quantize Panel](#) on page 243

[Opening the Editor Inspector](#) on page 50

Note Display

The note display of the **Drum Editor** contains a grid in which note events are shown.

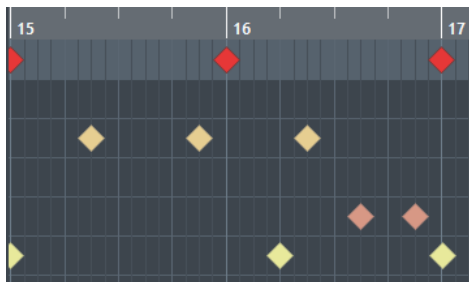

The notes are displayed as diamond symbols. If you activate **Show Note Length On/Off** on the toolbar, notes are displayed as boxes and show the note length.

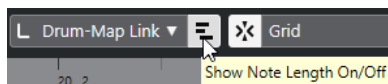

The vertical position of the notes corresponds to the drum sound list to the left, while the horizontal position corresponds to the note's position in time.

RELATED LINKS

[Drum Editor Toolbar](#) on page 687

Drum Sound List

The drum sound list lists all drum sounds by name and allows you to adjust and manipulate the drum sound setup in various ways.

	Pitch	Instrument	Snap	Mute	I-Note	O-Not	Chan	Output
	C1	Bass Drum	1/16		C1	C1	10	Track
	C#1	Side Stick	1/16		C#1	C#1	10	Track
	D1	Acoustic Snare	1/16	●	D1	D1	10	Track
	D#1	Hand Clap	1/16		D#1	D#1	10	Track
	E1	Electric Snare	1/16		E1	E1	10	Track
	F1	Low Floor Tom	1/16		F1	F1	10	Track
	F#1	Closed Hi-Hat	1/16		F#1	F#1	10	Track
	G1	High Floor Tom	1/16		G1	G1	10	Track
	G#1	Pedal Hi-Hat	1/16		G#1	G#1	10	Track
	A1	Low Tom	1/16		A1	A1	10	Track
Map	GM Map							Velocity

NOTE

The number of columns in the list depends on whether a drum map is selected for the track or not.

Pitch

Note number of the drum sound.

Instrument

Name of the drum sound.

Snap

This is used when entering and editing notes.

Mute

Allows you to mute drum sounds.

I-Note

Input note for the drum sound. When you play this note, it is mapped to the corresponding drum sound and automatically transposed according to the **Pitch** setting for the sound.

O-Note

The MIDI output note that is sent out every time the drum sound is played back.

Channel

The MIDI channel, on which the drum sound is played back.

Output

MIDI output on which the drum sound is played back.

RELATED LINKS

[Muting Notes and Drum Sounds](#) on page 699

[Drum Maps](#) on page 699

Select Pitch Visibility Options Menu

The **Select Pitch Visibility Options** pop-up menu on the drum editor toolbar allows you to determine which drum sounds are shown in the drum sound list.

- Activate **Pitch Visibility On/Off**, and click **Select Pitch Visibility Options** on the toolbar.

NOTE

If **Pitch Visibility On/Off** is deactivated, all drum sounds of the selected drum map are shown, and you can edit the order of the drum sound list manually.

Show Drum Sounds with Events

Shows only the drum sounds for which events are available in the selected MIDI part.

Show Drum Sounds in use by Instrument

Shows all drum sounds for which a pad, etc. is in use for the instrument. This option is only available if the instrument can provide this information.

Reverse Drum Sound List

Reverses the order of the sounds displayed in the drum sound list.

Drum Map and Names Menus

Below the drum sound list are pop-up menus that are used for selecting a drum map for the edited track or, if no drum map is selected, a list of drum sound names.

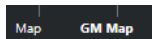

RELATED LINKS

[Drum Maps](#) on page 699

Drum Editor Operations

This section describes the general editing operations within the **Drum Editor**.

Inserting Drum Note Events

You can insert note events with the **Object Selection** tool or the **Drumstick** tool.

PREREQUISITE

You have set up the **Insert Length** on the toolbar to determine the length of the inserted note. If **Insert Length** is set to **Drum-Map Link**, the note gets the length of the **Snap** value set for the sound in the drum sound list. You have activated **Snap**.

NOTE

If you want to snap positions according to the **Quantize Presets** setting on the toolbar, activate **Use Quantize**.

PROCEDURE

- Perform one of the following actions:
 - Select the **Object Selection** tool and double-click in the event display.
 - Select the **Drumstick** tool and click in the event display.

NOTE

To temporarily switch from the **Object Selection** tool to the **Drumstick** tool, hold down **Alt/Opt**.

RESULT

A note event is inserted.

Inserting Multiple Drum Note Events

You can insert multiple note events of the same pitch with the **Object Selection** tool or the **Drumstick** tool.

PREREQUISITE

You have set up the **Insert Length** on the toolbar to determine the length of the inserted note. If **Insert Length** is set to **Drum-Map Link**, the note gets the length of the **Snap** value set for the sound in the drum sound list. You have activated **Snap**.

NOTE

If you want to snap positions according to the **Quantize Presets** setting on the toolbar, activate **Use Quantize**.

PROCEDURE

- Perform one of the following actions:
 - On the toolbar, select the **Object Selection** tool, double-click in the event display and drag to the right.
 - On the toolbar, select the **Drumstick** tool, click in the event display and drag to the right.
-

RESULT

The note events are inserted.

RELATED LINKS

[Drum Editor Toolbar](#) on page 687

Modifying Note Values While Inserting Notes

When inserting note events, you can modify specific note values on the fly.

- To edit the note velocity, drag upwards or downwards.
- To edit the note pitch, hold down **Alt/Opt** and drag upwards or downwards.
- To edit the note length, drag to the left or to the right.

NOTE

If you want to edit the note length in the **Drum Editor**, you must deactivate **Snap** and activate **Show Note Length On/Off**. Otherwise, the note is repeated.

- To edit the time position, hold down **Shift** and drag to the left or to the right.

NOTE

You can activate/deactivate **Snap** temporarily by holding down **Ctrl/Cmd**.

Changing the Note Length

You can change the note length in the drum editor with the **Object Selection** tool or with the **Drumstick** tool.

PREREQUISITE

You have activated **Show Note Length On/Off** on the drum editor toolbar.

PROCEDURE

1. Move the mouse pointer to the beginning or the end of the note that you want to edit.
The mouse pointer turns into a double arrow.
 2. Drag to the left or to the right to adjust the length.
An info box with the current length value is displayed.
 3. Release the mouse button.
-

RESULT

The note length is changed. **Snap** is taken into account.

Deleting Drum Note Events

PROCEDURE

- Perform one of the following actions:
 - Select the **Erase** tool and click the event.
 - Select the **Object Selection** tool and double-click the event.
 - Select the **Drumstick** tool and click the event.
-

RESULT

The note event is deleted.

Deleting Multiple Drum Note Events

You can delete multiple note events of the same pitch with the **Object Selection** tool or the **Drumstick** tool.

PREREQUISITE

To delete multiple note events with the **Object Selection** tool, **Snap** must be activated.

PROCEDURE

- Do one of the following:
 - On the toolbar, select the **Object Selection** tool, double-click the first event you want to delete, and drag to the right.
 - On the toolbar, select the **Drumstick** tool, click the first event you want to delete, and drag to the right.

RESULT

The note events are deleted.

Muting Notes and Drum Sounds

IMPORTANT

The mute state for drum sounds is part of the drum map. All other tracks using this map are affected.

- To mute individual notes, click or enclose them with the **Mute** tool, or select **Edit > Mute**.
- To mute a drum sound in a drum map, click in the **Mute** column for the drum sound.

Pitch	Instrument	Snap	Mute	I-Note	O-Not	Chan	Output
C1	Bass Drum	1/16	<input checked="" type="checkbox"/>	C1	C1	10	Track
C#1	Side Stick	1/16	<input type="checkbox"/>	C#1	C#1	10	Track
D1	Acoustic Snare	1/16	<input type="checkbox"/>	D1	D1	10	Track
D#1	Hand Clap	1/16	<input type="checkbox"/>	D#1	D#1	10	Track

- To mute all other drum sounds, click **Solo Instrument (Requires Drum Map)** on the toolbar.

RELATED LINKS

[Selecting a Drum Map for a Track](#) on page 702

Drum Maps

A drum kit in a MIDI instrument is most often a set of different drum sounds with each sound placed on a separate key. For example, the different sounds are assigned to different MIDI note numbers. One key plays a bass drum sound, another a snare, and so on.

Different MIDI instruments often use different key assignments. This can be troublesome if you have made a drum pattern using one MIDI device and then want to try it on another. When you switch devices, it is very likely that your snare drum becomes a ride cymbal or your hi-hat becomes a tom, etc., because the drum sounds are distributed differently in the instruments.

To solve this problem and to simplify several aspects of MIDI drum kits, such as using drum sounds from different instruments in the same drum kit, Cubase features drum maps. A drum map is a list of drum sounds with a number of settings for each sound. When you play back a MIDI track for which you have selected a drum map, the MIDI notes are filtered through the drum map before they are sent to the MIDI instrument. The map determines which MIDI note number is sent out for each drum sound and which sound is played on the receiving MIDI device.

When you want to try your drum pattern on another instrument, you simply switch to the corresponding drum map, and your snare drum sound remains a snare drum sound.

If you want to have the same drum maps included in your projects, you can load these into the template.

NOTE

Drum maps are saved with the project files. If you have created or modified a drum map, use the **Save** function to save it as a separate XML file to make it available for loading into other projects.

RELATED LINKS

[Saving a Project Template File](#) on page 87

Drum Map Setup Dialog

This dialog allows you to load, create, modify, and save drum maps.

- To open the **Drum Map Setup** dialog, select **Drum Map Setup** from the **Map** pop-up menu or the **MIDI** menu.

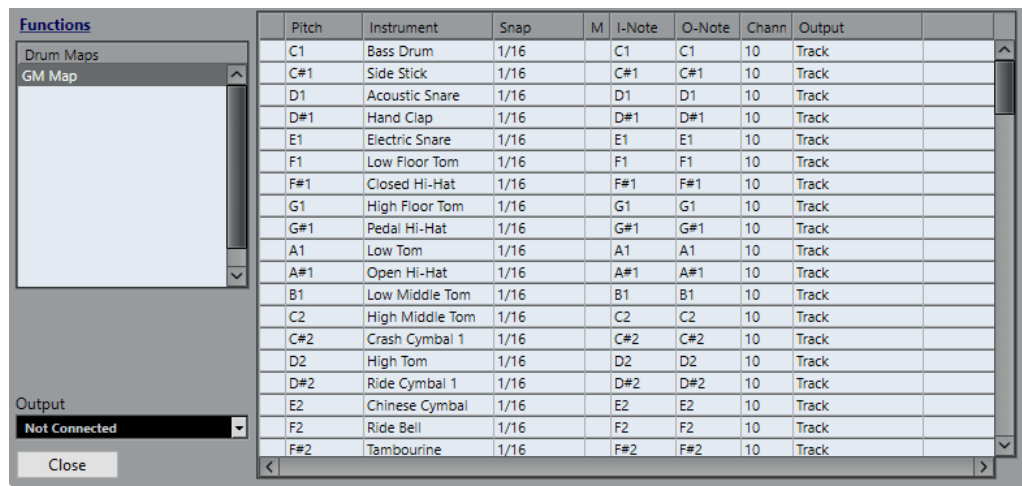

The list on the left shows the loaded drum maps. The sounds and settings of the selected drum map are displayed on the right.

NOTE

The settings for the drum sounds are the same as in the **Drum Editor**.

Output

Allows you to select the output for the drum map sounds.

Drum Sound list

Lists all drum sounds and their settings. To audition a drum sound, click the leftmost column.

NOTE

If you audition a sound in the **Drum Map Setup** dialog and the sound is set to MIDI output **Default**, the output that is selected on the **Output** pop-up menu in the lower left corner is used. When auditioning a default output sound in the **Drum Editor**, the MIDI output selected for the track is used.

The **Functions** pop-up menu contains the following options:

New Map

Adds a new drum map to the project. The drum sounds are named “Sound 1, Sound 2, etc.” and have all parameters set to default values. The map is named “Empty Map”.

To rename the drum map, click the name in the list and type in a new name.

New Copy

Adds a copy of the selected drum map to create a new drum map. You can then change the drum sound settings of the copy and rename the drum map in the list.

Remove

Removes the selected drum map from the project.

Load

Allows you to load drum maps into your project.

Save

Allows you to save the drum map that is selected in the list on disk. Drum map files have the extension .drm.

RELATED LINKS

[Drum Map Settings](#) on page 701

[Channel and Output Settings](#) on page 702

Drum Map Settings

A drum map consists of settings for 128 drum sounds, one for each MIDI note number.

- To get an overview of the drum map settings, open the **Drum Editor** and use the **Map** pop-up menu below the drum sound list to select the **GM Map** drum map.

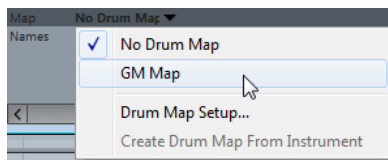

The GM map is set up according to the General MIDI standard.

You can change all drum map settings except the pitch directly in the drum sound list or in the **Drum Map Setup** dialog. These changes affect all tracks that use the drum map.

RELATED LINKS

[Drum Sound List](#) on page 695

[Drum Map Setup Dialog](#) on page 700

Importing Drum Maps from Virtual Instruments

You can import your drum map settings to an instrument track that is routed to Groove Agent SE.

PREREQUISITE

To import your drum map settings to an instrument track, the track has to be routed to Groove Agent SE or another drum instrument that supports drum maps.

PROCEDURE

1. Load a drum kit in Groove Agent SE.

2. In the **Inspector** for the track, open the **Drum Maps** pop-up menu and select **Create Drum Map from Instrument**.
The drum map is created for the kit that is assigned to the MIDI port and channel selected in the **Inspector**.
 3. Open the **Drum Maps** pop-up menu again and select **Drum Map Setup**.
 4. In the list on the left, select the kit that you have loaded in the instrument.
-

RESULT

The sounds and settings of the instrument are displayed in the **Drum Map Setup**.

NOTE

Instrument and pattern pads are both exported to the drum map. If they share keys, the pattern pads get priority, that is, their settings are included in the drum map.

Channel and Output Settings

You can set separate MIDI channels and/or MIDI outputs for each sound in a drum map. When a drum map is selected for a track, the MIDI channel settings in the drum map override the MIDI channel setting for the track.

You can select different channels and/or outputs for different sounds. This allows you to construct drum kits with sounds from several different MIDI devices, etc.

- To make a drum sound use the channel of the track, set the channel in the drum map to **Any**.
- To make the sound use the MIDI output that is selected for the track, set the MIDI output for a sound in a drum map to **Default**.
- To send the sound to a specific MIDI output, select any other option.
- To select the same MIDI channel or MIDI device for all sounds in a drum map, click in the **Channel** column, press **Ctrl/Cmd**, and select a channel or output.
- If you make specific MIDI channel and output settings for all sounds in a drum map, you can switch between drum maps to send your drum tracks to another MIDI instrument.

Selecting a Drum Map for a Track

- To select a drum map for a MIDI track, open the **Map** pop-up menu in the **Inspector** or in the **Drum Editor** and select a drum map.
- To deactivate the drum map functionality in the **Drum Editor**, open the **Map** pop-up menu in the **Inspector** or in the **Drum Editor** and select **No Drum Map**.
Even if you do not use a drum map, you can still separate sounds by name using a name list.

NOTE

Initially, the **Map** pop-up menu only contains **GM Map**.

I-Notes, O-Notes, and Pitches

Going through the following theory helps you make the most out of the drum map concept – especially if you want to create your own drum maps.

A drum map is a kind of filter that transforms notes according to the settings in the map. It does this transformation twice; once when it receives an incoming note, that is when you play a note

on your MIDI controller, and once when a note is sent from the program to the MIDI sound device.

The following example shows a modified drum map with a bass drum sound that has different pitch, I-note, and O-note values.

Pitch	Instrument	Snap	Mute	I-Note	O-Note	Channel	Output
C1	Bass Drum	1/16		A1	B0	10	Track
C#1	Side Stick	1/16		C#1	C#1	10	Track
D1	Acoustic Snare	1/16		D1	D1	10	Track
D#1	Hand Clap	1/16		D#1	D#1	10	Track

I-Notes (Input Notes)

When you play a note on your MIDI instrument, the program looks for this note number among the I-notes in the drum map. If you play the note A1, the program finds that this is the I-note of the bass drum sound.

This is where the first transformation happens: the note gets a new note number according to the pitch setting for the drum sound. In our case, the note is transformed to a C1 note, because that is the pitch of the bass drum sound. If you record the note, it is recorded as a C1 note.

For example, you can place drum sounds near each other on the keyboard so that they can be easily played together, move sounds so that the most important sounds can be played from a short keyboard, play a sound from a black key instead of a white. If you never play your drum parts from a MIDI controller but draw them in the editor, you do not need the I-note setting.

O-Notes (Output Notes)

The next step is the output. This is what happens when you play back the recorded note, or when the note you play is sent back out to a MIDI instrument in real time (MIDI Thru):

The program checks the drum map and finds the drum sound with the pitch of the note. In our case, this is a C1 note and the drum sound is the bass drum. Before the note is sent to the MIDI output, the second transformation takes place: the note number is changed to that of the O-note for the sound. In our example, the note sent to the MIDI instrument is a B0 note.

The O-note settings let you set things up so that the bass drum sound really plays a bass drum. If you are using a MIDI instrument in which the bass drum sound is on the C2 key, you set the O-note for the bass drum sound to C2. When you switch to another instrument (in which the bass drum is on C1) you want the bass drum O-note set to C1. Once you have set up drum maps for all your MIDI instruments, you can select another drum map when you want to use another MIDI instrument for drum sounds.

Setting Pitches of Notes According to their O-Note Settings

You can set the pitch of notes according to their O-note settings. This is useful if you want to convert a track to a regular MIDI track with no drum map and still have the notes play back the correct drum sound.

It is a typical use case to export your MIDI recording as a standard MIDI file. If you first perform an O-note conversion, you make sure that your drum tracks play back as intended when they are exported.

- To perform an O-note conversion, select **MIDI > O-Note Conversion**.

RELATED LINKS

[Exporting MIDI Tracks as Standard MIDI Files](#) on page 137

Chord Functions

The chord functions provide you with many possibilities for working with chords.

The chord functions allow you to:

- Build chord progressions by adding chord events to the chord track.
- Convert chord events to MIDI.
- Use the chord track to control MIDI playback.
- Use the chord track voicing to change the pitches of your MIDI.
- Extract chord events from MIDI data to get an overview of the harmonic structure of a MIDI file.
- Extract chord events from audio events.
- Record chord events with a MIDI keyboard.

RELATED LINKS

[Chord Editing Section](#) on page 668

Chord Track

The chord track allows you to add chord events and scale events.

RELATED LINKS

[Scale Events](#) on page 712

[Chord Events](#) on page 706

[Musical Scale Setup Dialog](#) on page 713

Adding the Chord Track

PROCEDURE

- Select **Project > Add Track > Chord**.

RESULT

The chord track is added to your project.



RELATED LINKS

[Chord Track](#) on page 131

Chord Events

Chord events are representations of chords that allow you to control or transpose playback on MIDI and instrument tracks.

Chord events alter the pitches of MIDI notes if their track is set up to follow the chord track.

Chord events have a specific start position. Their end, however, is determined by the start of the next chord event. They can have a root note, a type, a tension, and a bass note.

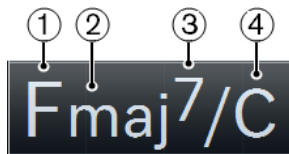

- 1 Root note
- 2 Type
- 3 Tension
- 4 Bass note

RELATED LINKS

[Controlling MIDI Playback Using the Chord Track](#) on page 718

Adding Chord Events

PREREQUISITE

You have added a chord track.

PROCEDURE

1. Select the **Draw** tool and click in the chord track.
An undefined chord event named X is added.
2. Select the **Object Selection** tool and double-click the chord event.
3. Open the **Editor** tab, and select a root note from the leftmost column.
The chord event on the chord track changes accordingly.

- Optional: Select a chord type, tension, and bass note.
 - Optional: Click **Add Chord** or press **Tab** to add a new undefined chord event on the chord track, and define it.
 - To close the **Editor**, click anywhere outside the **Editor**.
-

RELATED LINKS

[Adding the Chord Track](#) on page 705

Chord Editor

The **Chord Editor** allows you to define or change chord events, and to add new chord events.

- To open the **Chord Editor**, double-click a chord event.

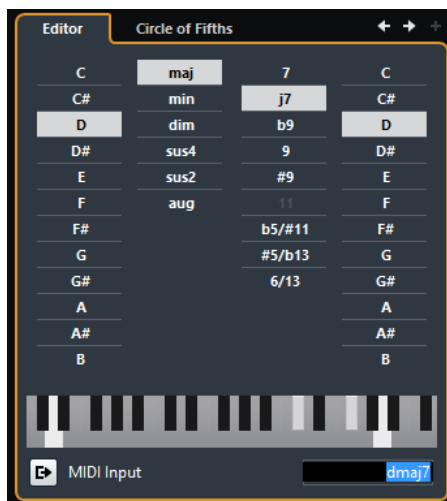

Go to Previous Chord/Go to Next Chord

Allow you to select the previous/next chord on the chord track for editing.

Add Chord

Adds a new undefined chord event on the chord track.

NOTE

This works only if the last chord event on the chord track is selected.

Chord definition buttons

Activate these buttons to define a root note, a chord type, a tension, and a bass note for your chord event.

NOTE

If you do not select a separate bass note, the setting is linked to the root note, so that no extra bass note is heard.

Keyboard display

Shows the notes of the chord event, considering the current voicing settings.

Activate MIDI Input

Allows you to define a chord by playing a chord on your MIDI keyboard. If the chord is recognized, it is reflected by the chord buttons and the keyboard display.

Define Chord by Text Input

Allows you to define a chord using the computer keyboard.

Defining Chords by Text Input

In the chord **Editor**, you can use the text input field to define a chord with the computer keyboard.

PROCEDURE

1. Double-click a chord event to open the chord **Editor**.
2. Click in the text input field at the bottom of the **Editor**.
3. Enter a chord by performing the following actions:
 - Define a root note, for example, C, D, E.
 - Define accidentals, for example, # or b.
 - Define the chord type, for example maj, min, dim, sus, or aug.
 - Define a chord extension, for example, 7, 9, or 13.

NOTE

If you have activated **Solfège** in the **Note Name** pop-up menu in the **Preferences** dialog (**Event Display—Chords&Pitches** page), you can also enter chords in this format. You must capitalize the first letter and write "Re" instead of "re", for example. Otherwise, the chord is not recognized.

4. Press **Tab** to add a new undefined chord and define it.

Chord Assistant

The **Chord Assistant** has two tabs. The **Circle of Fifths** tab helps you to find chords that you can apply to the selected chord event. The **Detected** tab is only available if you extracted chord events from audio events. It lists the extracted chord for the selected chord event together with alternative results.

- To open the **Circle of Fifths** tab, double-click a chord event, and click **Circle of Fifths**.

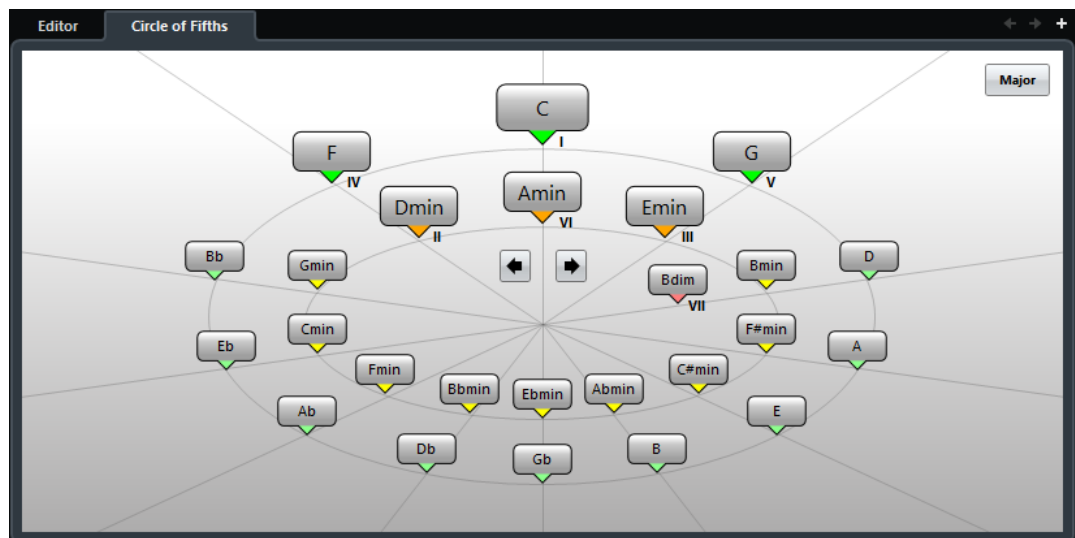

- To open the **Detected** tab, double-click a chord event that was extracted from an audio event, and click **Detected**.

NOTE

Chord events that were extracted from audio events are indicated by a symbol in the upper right corner of the event.

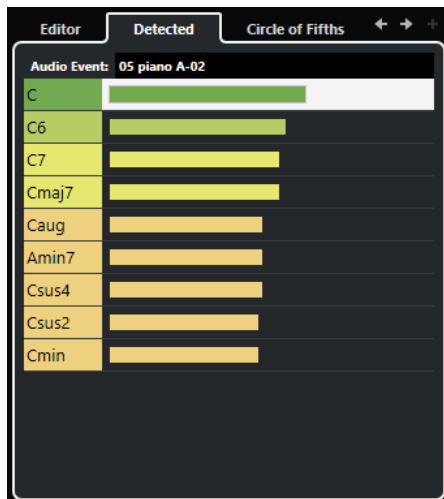

RELATED LINKS

[Chord Assistant – Circle of Fifths](#) on page 709

[Chord Assistant – Detected](#) on page 710

Chord Assistant – Circle of Fifths

The **Circle of Fifths** shows the chords in an interactive visualization of the circle of fifths.

- To open the **Circle of Fifths** tab of the **Chord Assistant**, double-click a chord event, and click **Circle of Fifths**.
- The origin chord that defines the current key is shown in the center of the **Chord Assistant** and is marked as tonic (I).
- The outer circle shows the twelve major chords ordered in intervals of fifths.
- The inner circle displays the corresponding parallel minor chords.
- The roman numerals mark the chords of the current key with their scale degree. You can use these chords to create typical chord progressions or you can use the other chords for more creative results.

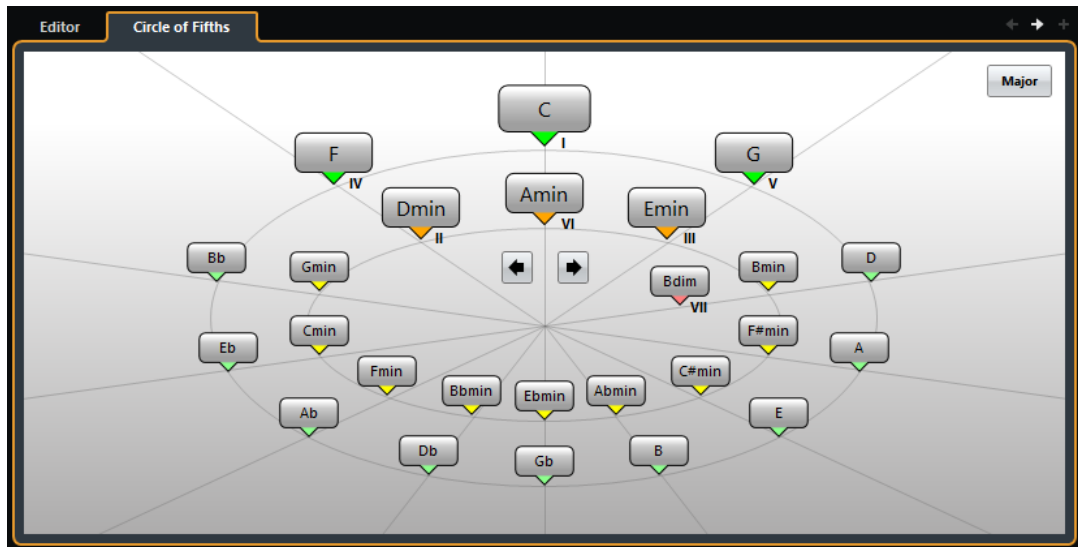

- To play a chord and assign it to the selected chord event, click it. The last 3 chords that you clicked are shown in bold.
- To define a new key, right-click the chord in the **Chord Assistant** and select **Use as Origin**, or use the **Rotate Left/Rotate Right** controls.
- To select the parallel minor chord and define it as key, click **Major/Minor**.

Chord Assistant – Detected

The **Detected** tab of the **Chord Assistant** is only available if you created chord events from audio events. It lists the detected chord for the selected chord event together with alternative results.

- To open the **Detected** tab of the **Chord Assistant**, double-click a chord event that was created from an audio event, and click **Detected**.



NOTE

Chord events that were created from audio events are indicated by a symbol in the upper right corner of the event.

Go to Previous Chord/Go to Next Chord

Allow you to select the previous/next chord on the chord track for editing.

Add Chord

Adds a new undefined chord event on the chord track.

NOTE

This works only if the last chord event on the chord track is selected.

Audio Event

The name of the audio event from which the chord events were detected.

Chord list

Shows the detected chord for the selected chord event on top, and alternative results further down the list. Click a chord to audition it and assign it to the selected chord event.

RELATED LINKS

[Chord Assistant](#) on page 708

[Creating Chord Events from Audio Events](#) on page 724

Auditioning Chord Events

To hear the chord events on the chord track, you must connect the chord track to the output of an instrument or a MIDI track.

PREREQUISITE

You have added a chord track and chord events.

PROCEDURE

1. In the global track controls area of the track list, click **Add Track** .
2. Click **Instrument**.
3. Open the **Instrument** pop-up menu and select a VST instrument.
4. Click **Add Track**.
The instrument track is added to the track list, and the control panel of the selected VST instrument is opened.
5. Select a sound.
6. In the chord track **Inspector**, activate **Acoustic Feedback**.
7. In the track list, open the **Select Track for Auditioning** pop-up menu, and select the track that you want to use for auditioning.



RESULT

The chord events on the chord track now trigger the sound of the assigned instrument on the MIDI or instrument track.

RELATED LINKS

[Chord Track](#) on page 131

[Add Track Dialog – Instrument](#) on page 108

Changing How Chord Events Are Displayed

You can change how chord events are displayed. This is useful if chord events overlap each other at low zoom levels or if you do not like the font type.

PROCEDURE

1. On the chord track, activate **Resolve Display Conflicts**.

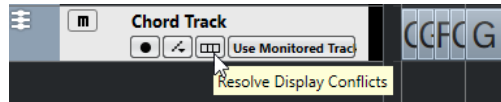

2. In the **Preferences** dialog, select **Event Display > Chords&Pitches**, and set up the chord font.

Here you can also determine the note name and naming format.

Scale Events

Scale events inform you which chord events fit in a specific sequence of notes that belong to a specific root note.

Cubase automatically creates scale events for your chord events.

- To show the scale events, activate **Show Scales** on the chord track.

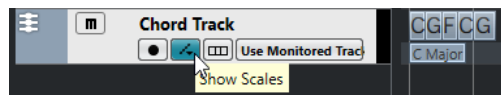

- To audition the notes that belong to a scale event, click it.

However, you can also add and edit scale events manually.

Scale events have a specific start position. Their end is determined by the start of the next scale event.

Editing Scale Events

PREREQUISITE

You have added a chord track and chord events. You have deactivated **Automatic Scales** in the chord track **Inspector**.

PROCEDURE

1. On the chord track, activate **Show Scales**.

The scale lane with scale events is displayed.

2. Select the chord event.

A scale event is shown on the scale lane.

3. Do one of the following:

- Click the first scale event on the chord track, and on the info line, select a **Root Key** and **Type**.

Start	Root Key	Type
1. 1. 1. 0	G	maj

- Double-click the scale event, and in the keyboard that appears, select a **Root Key** and **Type** of the scale.



The keys that correspond to the scale are highlighted.

RELATED LINKS

[Scale Assistant in the Key Editor](#) on page 653

Musical Scale Setup Dialog

The **Musical Scale Setup** dialog allows you to set up and manage musical scales.

- To open the **Musical Scale Setup** dialog, select **Project > Chord Track > Set up Musical Scales**.

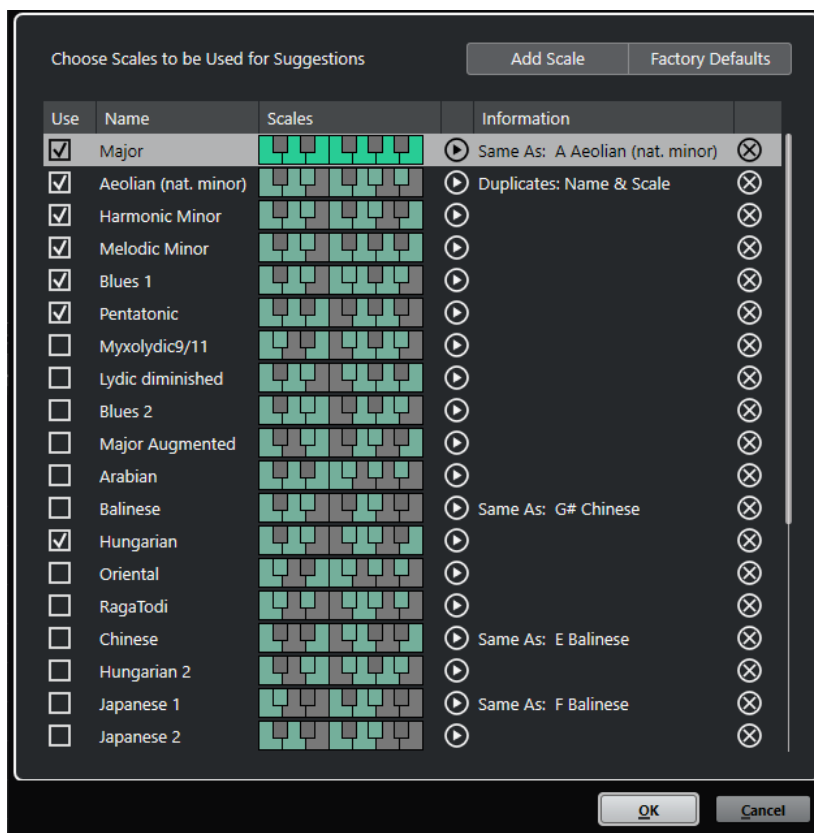

Add Scale

Adds a new scale to the list. Use the keyboard display to define the scale pitches. All scales start with C as a root note.

Factory Defaults

Resets all scales.

Use

Activates a scale.

NOTE

Activated musical scales are used in the chord track, in the **Scale Assistant** section of the **Key Editor Inspector**, in the **Transpose Setup** window, and in the **MIDI Modifiers** section of the **Inspector**.

Name

The name of the scale. Double-click to change it.

Scales

Shows a keyboard that allows you to define the scale pitches. Click a key to activate/deactivate a pitch for a scale. All scales start with C as a root note.

Preview Scale

Plays back the scale.

NOTE

For playback, the selected MIDI or instrument track must be record enabled and its output must be routed to an instrument.

Information

Informs you if the scale matches another scale or if it has the same name as another scale.

Remove Scale

Removes the corresponding scale from the scale suggestions.

NOTE

All changes apply to the entire application. This allows you to customize scales once and use them in all projects. However, if you remove or rename scales that are used in other projects, the scales cannot be retrieved.

RELATED LINKS

[Chord Track](#) on page 705

[Scale Assistant in the Key Editor](#) on page 653

[Transpose Setup Dialog](#) on page 602

[MIDI Modifiers Section](#) on page 590

Voicings

Voicings determine how chord events are set up. They define the vertical spacing and order of the pitches in a chord, but also the instrumentation and genre of a musical piece.

For example, a C chord can be spread over a wide range of pitches, and a pianist will choose different notes than a guitarist. The pianist may also play completely different pitches for different musical genres.

- You can set up voicing for the entire chord track in the chord track **Inspector**.
- You can set up voicings for individual chord events on the **Voicing** pop-up menu on the info line.

NOTE

If **Adaptive Voicings** is activated in the chord track **Inspector**, you can only change the voicings for the first chord event on the info line.

Inspector Settings for Voicings

To set up voicings for the entire chord track, you can use the chord track **Inspector**.

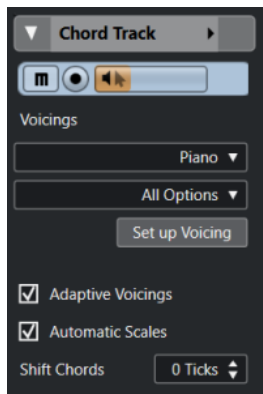

Voicing library

Allows you to select **Guitar**, **Piano**, or **Basic** as a voicing library.

Voicing library subset

NOTE

This is only available if **Guitar** or **Piano** is set as voicing library.

Allows you to select a preset voicing library subset.

Set up Voicing

Opens the **Custom Voicing** panel that allows you to configure your own voicing parameters for a specific voicing scheme.

Adaptive Voicings

Activate this to let Cubase set the voicings automatically. This prevents the individual voices from jumping too much.

Automatic Scales

Activate this to let Cubase set the scales automatically.

Shift Chords

If you enter a negative number of ticks, the chord events will affect the MIDI notes that have been triggered too early.

RELATED LINKS

[Custom Voicing Panel](#) on page 716

Custom Voicing Panel

If you click **Set up Voicing** in the **Chords** section of the **Inspector**, you can configure your own voicing parameters for a specific voicing scheme.

- To open the **Custom Voicing** panel, click **Set up Voicing** in the **Chords** section of the **Inspector**.

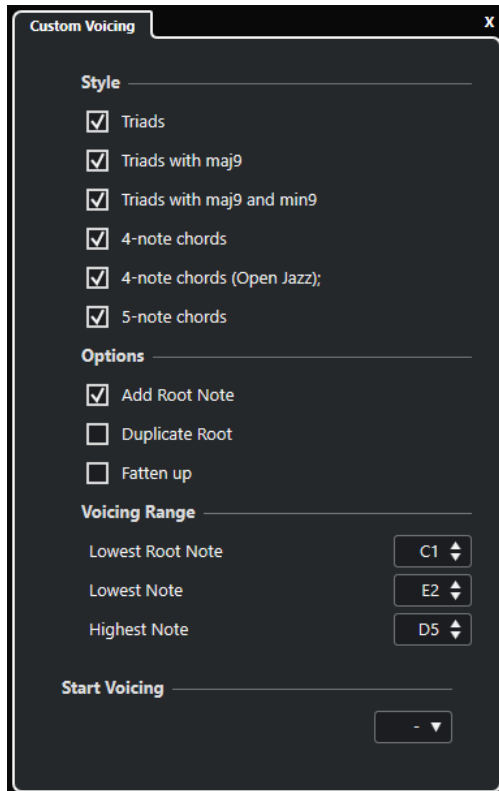

In the **Style** section for **Piano** voicings, you can set up the following parameters:

Triads

Sets a triad. Chords with more than 3 notes are not changed.

Triads with maj9

Sets a triad with a major ninth, but without root note. Chords with more than 3 notes are not changed.

Triads with maj9 and min9

Sets a triad with a major and a minor ninth, but without root note. Chords with more than 3 notes are not changed.

4-Note Chords

Sets a 4-note chord without root note. Chords with fewer than 3 notes are not changed.

4-Note Chords (Open Jazz)

Sets a 4-note chord without root note and without fifth. Chords with fewer than 3 notes are not changed.

5-Note Chords

Sets a 5-note chord with a ninth. Chords with fewer than 4 notes are not changed.

In the **Options** section for **Piano** voicings, you can set up the following parameters:

Add Root Note

Adds a root note.

Duplicate Root

Duplicates the root note.

Fatten up

Duplicates the tenor.

In the **Voicing Range** section for **Piano** voicings, you can set up the following parameters:

Lowest Root Note

Sets the limit for the lowest root note.

Lowest Note

Sets the limit for the lowest note, except the root note.

Highest Note

Sets the limit for the highest note, except the root note.

In the **Style** section for **Guitar** voicings, you can set up the following parameters:

Triads

Sets a triad with 4, 5 or 6 voices.

4-Note Chords

Sets a 4-note chord with 4, 5 or 6 voices without tensions.

3-String Triads

Sets a 3-string triad.

Modern Jazz

Sets 4-note, 5-note, and 6-note chords, partly without root note, but with tensions.

For **Basic** voicings, only **Octave Offset from C3** is available. This allows you to determine an offset value for the octave range.

In the **Start Voicing** section for **Piano**, **Guitar**, and **Basic** voicings, you can select a start voicing.

NOTE

This is only available for MIDI and instrument tracks, but not for the chord track, and only if you select **Voicings** in the **Follow Chord Track** pop-up menu.

Converting Chord Events to MIDI

You can convert chord events to MIDI for further editing or for printing a lead sheet in the **Score Editor**.

PROCEDURE

1. In the global track controls area of the track list, click **Add Track** .
2. Do one of the following to specify the destination track for your chord events:
 - Select an instrument or MIDI track.
 - Click **Instrument** to add an instrument track.
 - Click **MIDI** to add a MIDI track.
3. Click **Add Track**.

4. Do one of the following:

- To convert all chord events to MIDI, select **Project > Chord Track > Chords to MIDI**.
- To convert only selected chords to MIDI, select the chord events and drag them to the MIDI or instrument track.

RESULT

A new MIDI part is created on the selected instrument or MIDI track. It contains the chords as MIDI events.

RELATED LINKS

[Add Track Dialog – Instrument](#) on page 108

[Add Track Dialog – MIDI](#) on page 115

Assigning Chord Events to HALion Sonic SE Pads

PREREQUISITE

Create a chord progression on the chord track and add an instrument track with HALion Sonic SE as VST instrument to your project.

PROCEDURE

1. On the chord track, select the chord events and drag them to the HALion Sonic SE pads. The first chord event is mapped to the pad where you dropped it and all subsequent chord events are mapped to the following pads.
 2. Click the corresponding pads on the HALion Sonic SE keyboard to trigger the chords.
-

Controlling MIDI Playback Using the Chord Track

You can use the chord track to control MIDI playback.

Chords Section for MIDI Tracks

The **Chords** section in the MIDI track **Inspector** allows you to determine how the events on the MIDI track are mapped to the chord track.

- To open the **Chords** section for a MIDI track, select the track, and in the **Inspector**, click the **Chords** section.

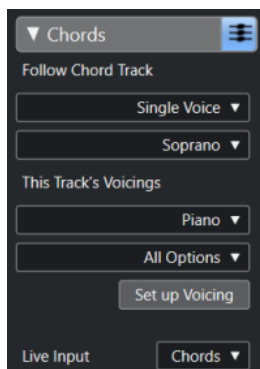

Follow Chord Track

Select an option to determine how the events on your track are mapped to the chord track.

This Track's Voicings

Allows you to select a voicing library or to use the voicings from the chord track. This is only available if you selected **Voicings** or **Single Voice** in the **Follow Chord Track** pop-up menu.

Live Input

Allows you to transpose the MIDI input live to a chord progression on the chord track.

RELATED LINKS

[Using Follow Chord Track](#) on page 719

[Follow Chord Track Modes](#) on page 720

[Using Live Input](#) on page 719

[Chord Pads Zone](#) on page 726

[Player Setup](#) on page 737

Using Live Input

Live Input allows you to transpose the MIDI input live to a chord progression on the chord track. This way, you do not have to worry about what key you hit on your MIDI keyboard as the MIDI input is transposed to match chords or scales on your chord track in real time.

PROCEDURE

1. Create a MIDI or an instrument track and activate **Record Enable**.
2. In the **Inspector**, open the **Chords** section.
3. Open the **Live Input** pop-up menu and do one of the following:
 - To map the MIDI input to chord events, select **Chords**.
 - To map the MIDI input to scale events, select **Scales**.
4. Hit some keys on your MIDI keyboard or on the **On-Screen Keyboard**.

RESULT

Any key that you hit is mapped in real time to the chord or scale events on the chord track.

RELATED LINKS

[Scale Assistant in the Key Editor](#) on page 653

[Mapping Incoming MIDI Note Pitches to Musical Scales](#) on page 661

Using Follow Chord Track

This allows you to match an existing recording to a chord progression on the chord track.

PROCEDURE

1. Select the track that you want to match to the chord track.
2. In the **Inspector**, click **Chords**.
3. Open the **Follow Chord Track** pop-up menu and select a mode.

NOTE

If this is the first time that you open this pop-up menu for the track, the **Follow Chord Track** dialog opens.

4. In the **Follow Chord Track** dialog, make your changes.
5. Click **OK**.

RESULT

The events on your track now match the chord progression on the chord track.

NOTE

If you matched your MIDI track to the chord track, some of the original MIDI notes may be muted. To hide these notes in the editors, activate **Hide Muted Notes in Editors** in the **Preferences** dialog (**Editing—Chords** page).

RELATED LINKS

[Follow Chord Track Dialog](#) on page 721

[Follow Chord Track Modes](#) on page 720

Follow Chord Track Modes

This section of the **Inspector** allows you to determine how your track follows the chord track.

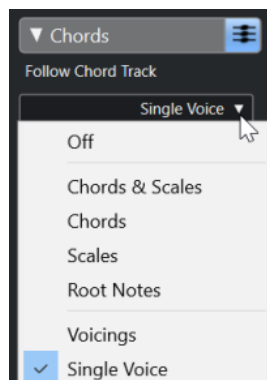

The following options are available on the **Follow Chord Track** pop-up menu:

Off

Follow Chord Track is deactivated.

Chords & Scales

This maintains the intervals of the original chord or scale as far as possible.

Chords

This transposes MIDI notes to match the key note and maps them to the current chord.

Scales

This transposes MIDI notes to match the current scale. This allows a bigger variety of notes and a more natural performance.

Root Notes

This transposes MIDI notes to match the root note of the chord event. The effect corresponds to using the transpose track. This option is suitable for bass tracks.

Voicings

This transposes MIDI notes to match the voices of the selected voicing library.

Single Voice

Maps MIDI notes to the notes of a single voice (soprano, tenor, bass, etc.) of the voicing. Use the pop-up menu below to select the desired voice.

NOTE

If you apply this mode to a selection of tracks that contain separate voices, you can set up one track as master and the others as voicing slaves. This way, you can change the voicing of the master, and the slaves will follow automatically.

RELATED LINKS

[Assigning Voices to Notes](#) on page 722

Follow Chord Track Dialog

This dialog opens the first time that you select an option from the **Follow Chord Track** pop-up menu on the **Chords** section of the **Inspector**.

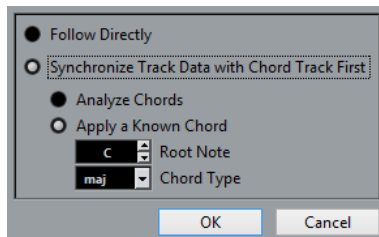

Follow Directly

Activate this if your MIDI notes are already in accordance with the chord track. This is the case if you extracted your chords from the MIDI events on the track by selecting **Project > Chord Track > Create Chord Events**, for example.

Synchronize Track Data with Chord Track First

Activate **Analyze Chords** if the track data has nothing in common with the chord events. This analyzes the MIDI events and matches the found chords to the chord track. This is only available for MIDI.

Activate **Apply a Known Chord** if the track data has nothing in common with the chord events and if there are no chord changes. Specify **Root Note** and **Chord Type** of your events.

RELATED LINKS

[Creating Chord Events from MIDI](#) on page 722

[Create Chord Events Dialog](#) on page 723

Using Map to Chord Track

This allows you to match individual parts or events to a chord progression on the chord track.

PROCEDURE

1. In the **Project** window, select the events or parts that you want to map to the chord track.
2. Select **Project > Chord Track > Map to Chord Track**.
3. From the **Mapping Mode** pop-up menu, select a mapping mode.

NOTE

If you select **Voicings** and no voices are found, **Auto** mode is used instead.

4. Click **OK**.
-

RESULT

The chords and scales of each event or part are analyzed and used for mapping. If no chords are found, Cubase assumes that the performance is in "C". The available mapping modes and voicings correspond to the **Follow Chord Track** parameters in the **Chords** section of the **Inspector**.

RELATED LINKS

[Follow Chord Track Modes](#) on page 720

Assigning Voices to Notes

You can transpose MIDI notes to match the voices of a selected voicing library.

PROCEDURE

- Select **Project > Chord Track > Assign Voices to Notes**.
-

RESULT

The note pitches now match the voicing of the chord track and you can still edit the MIDI notes. If you now select a note in the **Key Editor**, you see that **Voice** on the info line is assigned.

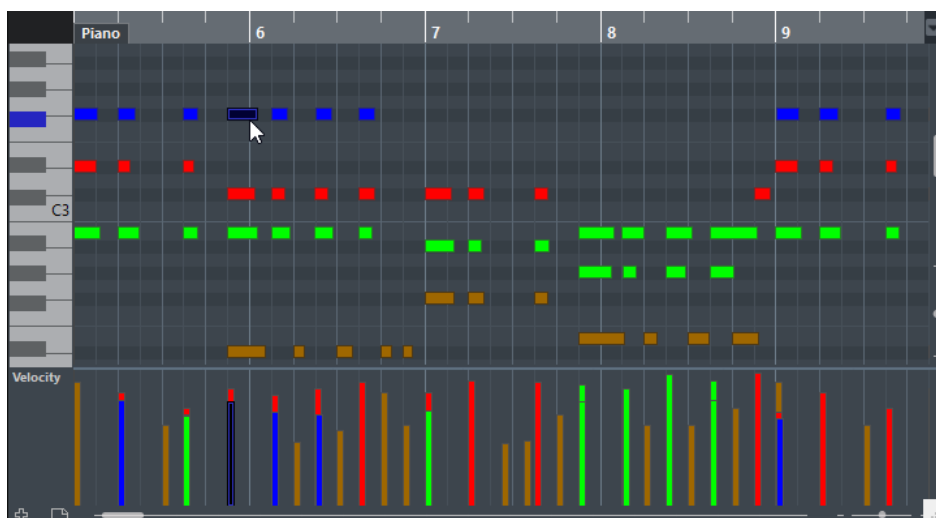

Creating Chord Events from MIDI

You can extract chords from MIDI notes, parts, or tracks. This is useful if you have a MIDI file and want to show its harmonic structure, and use this file as starting point for further experimenting.

PREREQUISITE

- You have added a chord track.
- On a MIDI track, you have created a MIDI part with MIDI events that can be interpreted as chords. Drums, monophonic bass, or lead tracks are not suitable.

PROCEDURE

1. In the **Project** window, select a part or one or several MIDI tracks.
You can also select the MIDI tracks, parts, or notes that you want to create in the **Key Editor**, **Score Editor**, or **In-Place Editor**.
 2. Do one of the following:
 - Drag the MIDI part and drop it on the chord track.
 - Right-click a MIDI part, and select **Create Chord Events** from the context menu.
 - Select **Project > Chord Track > Create Chord Events**.
 3. In the **Create Chord Events** dialog, make your changes and click **OK**.
-

RESULT

The chord events are added to the chord track.

RELATED LINKS

- [Create Chord Events Dialog](#) on page 723
- [Creating Chord Events from Audio Events](#) on page 724
- [Chord Editing Section](#) on page 668

Create Chord Events Dialog

This dialog allows you to determine, which MIDI data should be taken into account when creating chord events from MIDI.

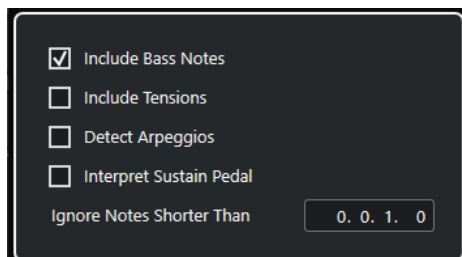

Include Bass Notes

Activate this if you want your chord events to contain a bass note.

Include Tensions

Activate this if you want your chord events to contain tensions.

Detect Arpeggios

Activate this if you want your chord events to contain arpeggiated chords, that is, chords whose notes are played one after another instead of all at once.

Interpret Sustain Pedal

Activate this if you want your chord events to contain sustain pedal chords, that is, notes that are played while the sustain pedal is held.

Ignore Notes Shorter Than

Allows you to determine the minimum length of the MIDI events that are taken into account.

RELATED LINKS

- [Chord Editing Section](#) on page 668
- [Creating Chord Events from MIDI](#) on page 722

Creating Chord Events from Audio Events

You can extract chords from audio events. This is useful if you have an audio file and want to show its harmonic structure, and use this file as starting point for further experimenting.

PREREQUISITE

- You have added a chord track.
- On an audio track, you have added an audio event with audio material that can be interpreted as chords, that is, with three or four different note pitches playing simultaneously. The audio material should contain western music with 12 pitches per octave, tuned in equal temperament.

PROCEDURE

1. In the **Project** window, select an audio event on an audio track.

NOTE

You cannot use audio parts.

2. Do one of the following:
 - Drag the audio event and drop it on the chord track.
 - Right-click an audio event, and select **Create Chord Events** from the context menu.
 - Select **Project > Chord Track > Create Chord Events**.
-

RESULT

- The chord events are added to the chord track. Depending on the length of the audio event, this may take a while.
- The chord events that you created from audio events are indicated by a symbol in the upper right corner.
- The created chord events match the positions and lengths of the corresponding chords in the audio event.
- If the chord track already contained chord events, these are replaced within the position and length of the audio event. Chord events outside that range will be kept.

RELATED LINKS

[Editing Chord Events That Were Detected from Audio Events](#) on page 724

[Chord Assistant – Detected](#) on page 710

[Creating Chord Events from MIDI](#) on page 722

Editing Chord Events That Were Detected from Audio Events

If you are not satisfied with the chord events that were detected from audio events, you can edit them. The algorithm normally provides several possible results for chord types.

PREREQUISITE

- You have detected chord events from audio events.
- You have connected the chord track to the output of an instrument or a MIDI track. This allows you to audition the chords.

PROCEDURE

1. Double-click the detected chord event that you want to edit.
 2. Open the **Detected** tab.
A list of the detected chords ranked from top to bottom is shown.
 3. Click one of the chords in the list to audition the chord and assign it to the chord event.
-

RESULT

The chord is assigned to the chord event on the chord track. If necessary, you can change the position of the chord events manually or by using the **Quantize** function on the **Edit** menu.

RELATED LINKS

[Auditioning Chord Events](#) on page 711

[Chord Assistant - Detected](#) on page 710

Recording Chord Events with a MIDI Keyboard

You can use a MIDI keyboard to record chord events on the chord track.

PREREQUISITE

Your project contains an instrument track with **Record Enable** or **Monitor** activated.

PROCEDURE

1. On the chord track, activate **Record Enable**.
 2. On the **Transport** panel, activate **Record**.
 3. Play some chords on your MIDI keyboard.
-

RESULT

All recognized chords are recorded as chord events on the chord track.

NOTE

The chord track uses its own voicing settings. The recorded chord events may therefore sound different.

RELATED LINKS

[Adding Chord Events](#) on page 706

Chord Pads

Chord pads allow you to play with chords, and to change their voicings and tensions. In terms of harmonies and rhythms, they allow for a more playful and spontaneous approach to composition than the chord track functions.

You can:

- Perform with chords in real time via a MIDI keyboard.
- Record your performance as MIDI events on a MIDI or instrument track or even on the chord track.

NOTE

We assume that you have a MIDI keyboard connected and set up.

RELATED LINKS

[Voicings](#) on page 714

Chord Pads Zone

The chord pads in the lower zone of the **Project** window hold all functions that you need to work with chord pads.

To open the **Chord Pads**, select **Project > Chord Pads > Show/Hide Chord Pads**.

The chord pads hold the following controls:

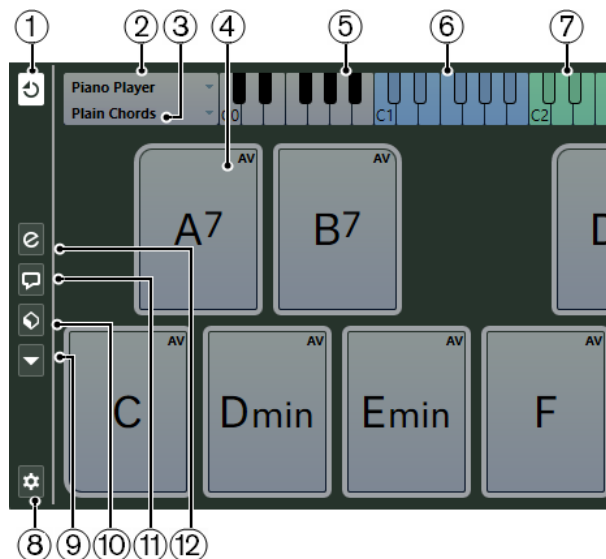

1 Chord Pad Output Mode

Activate this to send chord data to all tracks that are monitored or record-enabled.

Deactivate this to send chord data exclusively to tracks that are monitored or record-enabled and where **Input Routing** is set to **Chord Pads**.

NOTE

If **Record-Enable allows MIDI Thru** is deactivated in the **Preferences** dialog (**Record—MIDI** page), you must activate **Monitor** to use the chord pads.

2 Current Player

Shows the selected player and opens a pop-up menu where you can select another player.

3 Current Mode

Shows the selected player mode and opens a pop-up menu where you can select another player mode.

4 Chord Pad

Each chord pad can contain a chord symbol. Right-click a chord pad to open a context menu for that chord pad. To change the chord that is assigned to the chord pad, click **Open Editor** on the left edge of the chord pad.

5 Keyboard

Shows which keys are played when you trigger a chord pad. To zoom the keyboard, click a key and drag up or down. To scroll the keyboard, click and drag to the left or to the right.

6 Pads Remote Range

The keys highlighted in blue on the keyboard correspond to the keys on your MIDI keyboard that trigger the chord pads. You can define the remote range on the **Pad Remote Control** page of the **Chord Pads Setup** dialog.

7 Remote Range for Voicings/Tensions/Transpose

The keys highlighted in green on the keyboard display correspond to the keys on your MIDI keyboard that change the voicings, tensions, and transpose settings of the pads. You can activate and define these remote keys on the **Pad Remote Control** page of the **Chord Pads Setup** dialog.

8 Set up Chord Pads

Opens the **Chord Pads Setup** dialog.

9 Functions Menu

Opens a pop-up menu with specific functions and settings for the chord pads.

10 Chord Pads Presets

Allows you to save and load presets for chord pads and players.

11 Show/Hide Chord Assistant

Shows/Hides the **Chord Assistant** window that shows suggestions of chords that match the chord that you specified as the origin chord.

12 Show/Hide Player Setup

Shows/Hides the player setup options.

RELATED LINKS

[Chord Pads Setup Dialog](#) on page 741

[Playing Back and Recording Chords](#) on page 734

[Players and Voicings](#) on page 738

[Opening Chord Pads](#) on page 53

Chord Pad Controls

The chord pad controls allow you to edit the chord pads.

- To show the chord pad controls, move the mouse over a chord pad.

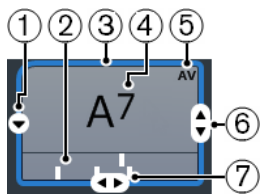

1 Open Editor

Opens the **Chord Editor** that allows you to select a chord for the chord pad.

2 Voicing indicators

Shows the voicing used for the chord. Voicing indicators can only be displayed if the horizontal zoom level for the chord pads is high enough.

3 Adaptive Voicing Reference/Use X as Origin for Chord Assistant

When the active chord pad is set as adaptive voicing reference, its borders are shown in yellow. All other chord pads follow its voicing and are set in a way that they do not get too far away from the reference.

If the chord pad is set as origin for the **Chord Assistant** window, its borders are shown in blue. This chord pad is used as a basis for the suggestions in the **Chord Assistant** window.

4 Assigned Chord

Shows the chord symbol that is assigned to the chord pad. Each chord pad can contain one chord symbol. If the name of the assigned chord is too long to display it on the chord pad, it is underlined, and the full chord name is shown in a tooltip.

5 AV (Adaptive Voicing)/L (Lock)

All chord pads follow the adaptive voicing. This is indicated by **AV**. If you change the voicing for a pad manually, however, adaptive voicing is deactivated.

An **L** indicates that the chord pad is locked for editing.

6 Voicing

Allows you to set another voicing for the chord pad.

7 Tensions

Allows you to add/remove tensions for the chord.

Chord Pad Context Menu

- To open the chord pad context menu, right-click a chord pad.

Use X as Origin for Chord Assistant

Sets the chord of the current pad as an origin chord for the chord assistant.

Assign Pad from MIDI Input

Allows you to assign a chord by pressing keys on your MIDI keyboard.

Lock

Allows you to lock a chord pad for editing.

Adaptive Voicing

All chord pads follow the adaptive voicing. This is indicated by a check mark. If you change the voicing for a pad manually, adaptive voicing is deactivated.

Adaptive Voicings Reference

Sets the current pad as adaptive voicing reference. If set, the automatic voicings for the following pads are set in a way that they do not get too far away from the reference voicing. Only one pad can be set as adaptive voicing reference.

Unassign Pad

Removes the chord assignment from the current pad.

Functions Menu

- To open the functions menu, click **Functions Menu**.



Show Voicing Indicators

Allows you to activate/deactivate the voicing indicators that can be displayed at the bottom of each chord pad.

Assign Pads from Chord Track

Assigns the chord events from the chord track to the chord pads in the same order as they appear on the chord track. Chord events that have more than one occurrence are only assigned once.

Snap Playback to Musical Grid

Allows you to delay the playback of a triggered chord pad to the next defined musical position. This is useful if you work with an arpeggiator or if you set the **Player Modes** to **Pattern**.

Transpose All Pads

Transposes all chord pads by a defined transpose value.

Lock All Pads

Locks all chord pads for editing.

Unlock All Pads

Unlocks all chord pads.

Unassign All Pads

Removes the chord assignment from all pads.

Chord Assistant

The **Chord Assistant** allows you to use a chord as a starting point for suggestions for the next chord. It assists you in finding the right chords for creating a chord progression for your song.

- Click **Show/Hide Chord Assistant** on the left side of the chord pads area to open the **Chord Assistant**.



You must define an origin chord as follows:

- Right-click the chord pad with the chord you want to use as origin and select **Use X as Origin for Chord Assistant**.

The **Chord Assistant** window shows suggestions for follow-on chords that you can assign to the chord pads.

Chord Assistant – Circle of Fifths

The **Circle of Fifths** shows the chords in an interactive visualization of the circle of fifths.

- The origin chord that defines the current key is shown in the center of the **Chord Assistant** and is marked as tonic (I).
- The outer circle shows the twelve major chords ordered in intervals of fifths.
- The inner circle displays the corresponding parallel minor chords.
- The roman numerals mark the chords of the current key with their scale degree. You can use these chords to create typical chord progressions or you can use the other chords for more creative results.

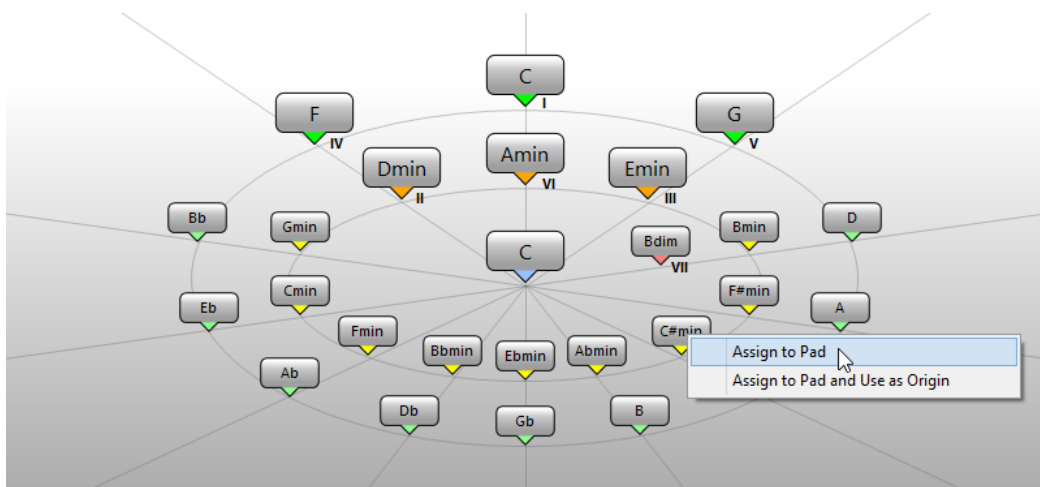

- To play a chord, click it.

The last 3 chords that you clicked are shown in bold.

- To assign a chord to the next unassigned chord pad, right-click the suggested chord and select **Assign to Pad**.
You can also drag the suggested chord and drop it on a chord pad.
- To assign a suggestion to the next unassigned chord pad and use this chord as origin, right-click the chord and select **Assign to Pad and Use as Origin**.

NOTE

The **Circle of Fifths** is also available in the **Chord Assistant** window for the chord track.

Chord Assignment

Some chords are preassigned to the chord pads. But you can also assign your own chords.

To assign chords to chord pads, you can use:

- The chord **Editor** window
- The **Chord Assistant – Circle of Fifths** window
- Your MIDI keyboard
- The chord events from the chord track

Unassigning Chord Pads

You can clear all chord assignments from the chord pads to start from scratch.

PROCEDURE

- To the left of the chord pads, open the **Functions Menu** and select **Unassign All Pads**.
-

Assigning Chords with the Chord Editor

If you know exactly which chord you want to assign to a specific chord pad, you can use the **Chord Editor**.

PROCEDURE

1. Move the mouse pointer to the left edge of the chord pad, and click **Open Editor**.
2. In the **Chord Editor** window, use the chord definition buttons to define a root note, a chord type, a tension, and a bass note.

The new chord is triggered automatically to give an acoustic feedback.

Assigning Chords with the Chord Assistant – Circle of Fifths Tab

If you have a chord that you want to use as a starting point for a chord progression, but you do not know how to create such a progression, you can use the **Chord Assistant – Circle of Fifths** window.

PROCEDURE

1. Right-click the chord pad that you want to use as a starting point and activate **Use X as Origin for Chord Assistant**.

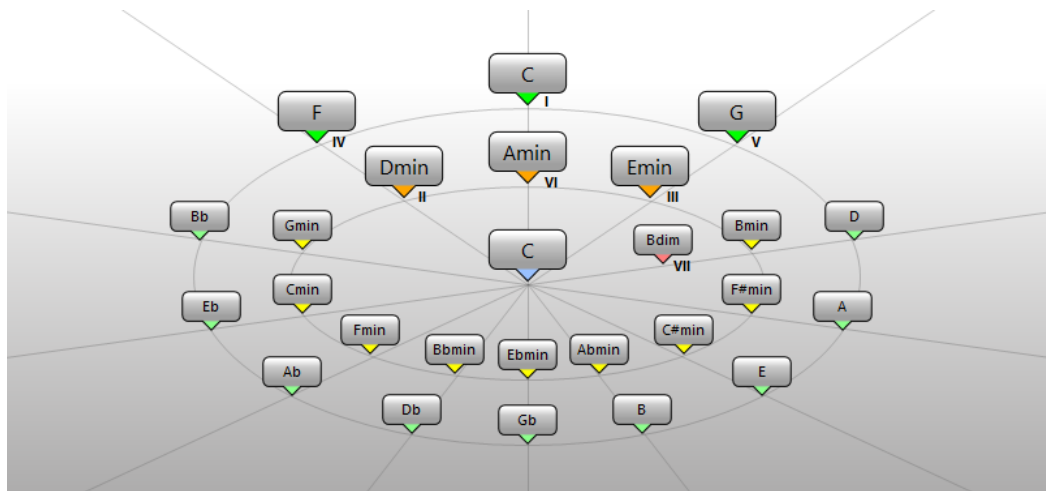

The **Chord Assistant** window opens, and the borders of the chord pad change their color to indicate that the assigned chord is now used as origin.

The origin chord is displayed in the center, and the chords that belong to the scale are shown above it. The numerals indicate the scale degree of the chords. These help you to create chord progressions.

2. In the **Chord Assistant** window, click the chord symbols to trigger the corresponding chords.
3. To assign a chord, drag it from the **Chord Assistant** window and drop it on the chord pad.

NOTE

If one of the next chord pads is free, you can also right-click the chord in the **Chord Assistant** window and select **Assign to Pad**. This assigns the chord to the next free pad.

Assigning Chords with the MIDI Keyboard

If you know which chord you want to assign to a specific chord pad, you can use a MIDI keyboard or the **On-Screen Keyboard**.

PREREQUISITE

You have selected a MIDI track or an instrument track.

PROCEDURE

1. Right-click the chord pad that you want to use for the new chord, and select **Assign Pad from MIDI Input**.
The borders of the chord pad change their color to indicate that it is now ready for recording.
2. On your MIDI keyboard or on the **On-Screen Keyboard**, press the keys for the chord that you want to assign.
The chord and its voicing are assigned to the chord pad, and you hear an acoustic feedback of the chord.

NOTE

The assigned voicing can be changed by the **Adaptive Voicing** setting. Therefore, if you want to keep the voicing for that specific pad, right-click the chord pad and select **Lock** from the context menu.

RELATED LINKS

[Adaptive Voicing](#) on page 738

Assigning Chords from the Chord Track

You can assign the chord events from the chord track to the chord pads.

PREREQUISITE

You have added a chord track with chord events to your project.

PROCEDURE

- To the left of the chord pads, click the **Functions Menu** button, and select **Assign Pads from Chord Track**.

If chords are already assigned to the chord pads, a warning message informs you that all previous assignments will be overwritten.

RESULT

The chord events are assigned to the chord pads in the same order as they appear on the chord track.

NOTE

Chord events that have more than one occurrence on the chord track are only assigned once.

RELATED LINKS

[Adding the Chord Track](#) on page 705

[Adding Chord Events](#) on page 706

Swapping Chord Assignments

You can swap the chord assignments of 2 pads.

PROCEDURE

- Click a chord pad and drag it to another chord pad.
While you drag, the border of the destination chord pad changes its color.

RESULT

When you drop the pad on another, the chord assignments are swapped together with their settings, except for the **Adaptive Voicing Reference**.

Copying Chord Assignments

You can copy the chord assignment of one pad and paste it on another pad.

PROCEDURE

- **Alt/Opt**-click a chord pad and drag it to another chord pad.
While you drag, the border of the destination chord pad changes its color.

RESULT

When you drop the pad on another, the first pad's assignment is copied to the destination chord pad together with its settings, except for the **Adaptive Voicing Reference**.

Playing Back and Recording Chords

You can play back and record chords that are assigned to chord pads using MIDI or instrument tracks.

There are two different **Chord Pad Output Modes** that determine if chords that are assigned to chord pads can be played back and recorded using any or using exclusive MIDI or instrument tracks:

- **Chord Pad Output Mode: On**
Allows you to play back and record chord pads using any MIDI or instrument track where **Record Enable** or **Monitor** is activated.
- **Chord Pad Output Mode: Off**
Allows you to play back and record chord pads using exclusive MIDI or instrument tracks where **Record Enable** or **Monitor** is activated, and where **Chord Pads** is selected as a MIDI input in the **Input Routing** pop-up menu.

NOTE

If **Record-Enable allows MIDI Thru** is deactivated in the **Preferences** dialog (**Record—MIDI** page), you must activate **Monitor** to use the chord pads.

RELATED LINKS

[Chord Pads Zone](#) on page 726

[Recording Chords on the Chord Track](#) on page 736

[Recording Chords on Instrument Tracks](#) on page 736

[Playing Back Chord Pads Using Any Instrument Track](#) on page 734

[Playing Back Chord Pads Using Exclusive Instrument Tracks](#) on page 735

Playing Back Chord Pads Using Any Instrument Track

You can play back chord pads using any MIDI or instrument track where **Record Enable** or **Monitor** is activated.

PREREQUISITE

You have connected and set up a MIDI keyboard.

PROCEDURE

1. In the global track controls area of the track list, click **Add Track** .
2. Click **Instrument**.
3. Open the **Instrument** pop-up menu and select a VST instrument.
4. Click **Add Track**.

The instrument track is added to the track list, and the control panel of the selected VST instrument is opened.

5. On the instrument track, click **Record Enable** or **Monitor**.

NOTE

If **Record-Enable allows MIDI Thru** is deactivated in the **Preferences** dialog (**Record—MIDI** page), you must activate **Monitor** to use the chord pads.

6. Select **Project > Chord Pads > Show/Hide Chord Pads** to open the **Chord Pads**.
 7. Activate **Chord Pad Output Mode**.
 8. Press some keys on your MIDI keyboard to trigger the chords that are assigned to the chord pads.
-

RELATED LINKS

[Add Track Dialog – Instrument](#) on page 108

[Chord Pads Setup Dialog](#) on page 741

[Changing the Pads Remote Range](#) on page 745

Playing Back Chord Pads Using Exclusive Instrument Tracks

You can play back chord pads using exclusive MIDI or instrument tracks where **Record Enable** or **Monitor** is activated, and where **Chord Pads** is selected as a MIDI input in the **Input Routing** pop-up menu.

PREREQUISITE

You have set up a MIDI keyboard.

PROCEDURE

1. In the global track controls area of the track list, click **Add Track** .
2. Click **Instrument**.
3. Open the **Instrument** pop-up menu and select a VST instrument.
4. Click **Add Track**.

The instrument track is added to the track list, and the control panel of the selected VST instrument is opened.

5. On the instrument track, click **Record Enable** or **Monitor**.

NOTE

If **Record-Enable allows MIDI Thru** is deactivated in the **Preferences** dialog (**Record—MIDI** page), you must activate **Monitor** to use the chord pads.

6. In the **Inspector** for the instrument track, open the **Input Routing** pop-up menu, and select **Chord Pads**.
 7. Select **Project > Chord Pads > Show/Hide Chord Pads** to open the **Chord Pads**.
 8. Deactivate **Chord Pad Output Mode**.
 9. Press some keys on your MIDI keyboard to trigger the chords that are assigned to the chord pads.
-

RESULT

The instrument track now receives MIDI data exclusively from the chord pad device. You can use a connected MIDI keyboard to trigger the chord pads. This still works if you hide the **Chord Pads** from view.

NOTE

On the **Chord Pads** page of the **Studio Setup** dialog, you can select your connected MIDI keyboard from the **MIDI Input** pop-up menu. This is useful if you want to use a specific MIDI keyboard exclusively for triggering the chord pads.

Recording Chords on Instrument Tracks

You can record chords that are triggered by chord pads on MIDI or instrument tracks.

PREREQUISITE

You have connected and set up a MIDI keyboard, you have opened and set up the chord pads, and you have added an instrument or a MIDI track for which a VST instrument is loaded.

PROCEDURE

1. On the instrument track, click **Record Enable** or **Monitor**.

NOTE

If **Record-Enable allows MIDI Thru** is deactivated in the **Preferences** dialog (**Record—MIDI** page), you must activate **Monitor** to use the chord pads.

2. On the **Transport** panel, activate **Record**.
 3. On your MIDI keyboard, press the keys that trigger the chord pads.
-

RESULT

The triggered chords are recorded on the track. The note events are automatically assigned to different MIDI channels according to their pitches. Note events that correspond to the soprano voice are assigned to MIDI channel 1, alto is assigned to MIDI channel 2, and so on.

AFTER COMPLETING THIS TASK

Open the **Key Editor** and fine-tune your recorded MIDI parts using the chord editing functions, for example. You can also use **MIDI > Dissolve Part** to dissolve the recorded chords by pitches/channels.

Recording Chords on the Chord Track

You can record chords that are triggered by chord pads on the chord track. This way, you can easily create chord events for a lead sheet, for example.

PREREQUISITE

You have connected and set up a MIDI keyboard, you have opened and set up the chord pads, and you have added an instrument or a MIDI track for which a VST instrument is loaded.

PROCEDURE

1. On the instrument track, click **Record Enable** or **Monitor**.

NOTE

If **Record-Enable allows MIDI Thru** is deactivated in the **Preferences** dialog (**Record—MIDI** page), you must activate **Monitor** to use the chord pads.

2. Select **Project > Add Track > Chord**.

The chord track is added to the track list.

3. In the **Inspector** for the chord track, click **Record Enable**.
4. On the **Transport** panel, activate **Record**.
5. On your MIDI keyboard, press the keys that trigger the chord pads.

RESULT

The chord events are recorded on the chord track.

NOTE

The recorded chord events may sound different from the chord pad playback. This is because the voicing settings for the chord track differ from the chord pad voicings.

RELATED LINKS

[Chord Track](#) on page 131

[Chord Functions](#) on page 705

[Voicings](#) on page 714

Player Setup

The **Player Setup** allows you to select a player and a voicing setting that is typical for that kind of player, and determine if the notes of a chord are played as plain chords or as a pattern.

- To open the **Player Setup**, click **Show/Hide Player Setup**.

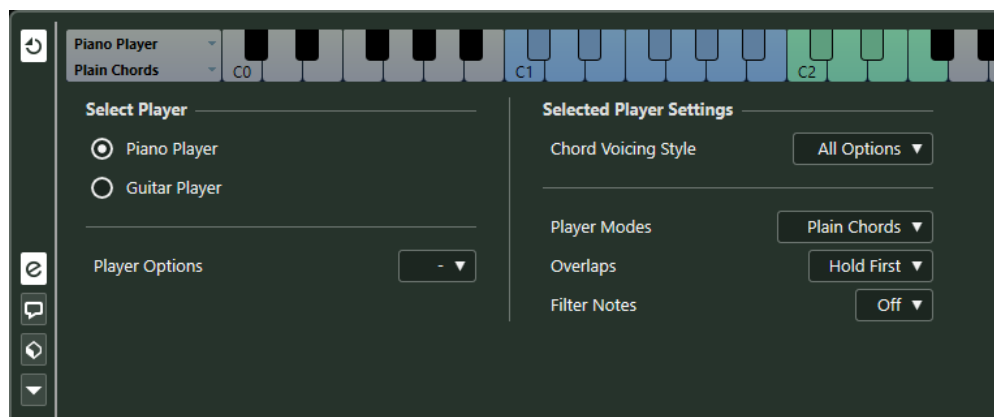

In the **Select Player** section, the following options are available:

List of Added Players

Shows the added players, and allows you to activate a player and use its voicing style and play mode for the chord pads.

Player Options

Allows you to add a player and to rename or remove the current player.

In the **Selected Player Settings** section, the following options are available:

Chord Voicing Style

Allows you to select a chord voicing style for the selected player. This determines how chords are played back, and what pitches are used.

Player Modes

- **Plain Chords** triggers all notes of a chord simultaneously.
- **Pattern** plays an arpeggio that is based on the notes of the pattern.

RELATED LINKS

[Players and Voicings](#) on page 738

[Voicings](#) on page 714

[Player Setup](#) on page 737

Players and Voicings

Different types of instruments and styles have different voicing libraries. These determine how the chords are played back, and which pitches are played. These voicings are referred to as players.

RELATED LINKS

[Voicings](#) on page 714

Adaptive Voicing

In Cubase, the adaptive voicing setting ensures that pitches in chord progressions do not change abruptly.

Adaptive voicing is activated and the voicings of the chord pads are determined automatically according to specific voice leading rules.

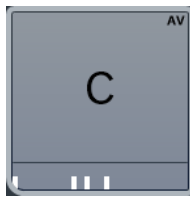

If you want to set the voicing of a specific chord pad manually, and do not want it changed automatically, you can use the voicing control to the right of a chord pad. When you assign your own voicing, adaptive voicing is deactivated for that chord pad, so that the pad does no longer follows the voice leading rules of the voicing reference. To activate adaptive voicing again, right-click the chord pad and activate **Adaptive Voicing**.

To lock the voicing for a chord pad, you can right-click the pad and activate **Lock**. This locks this pad for editing and remote control changes, and deactivates **Adaptive Voicing**. To unlock the chord pad again, right-click the pad and deactivate **Lock**.

Player Modes—Plain Chords

You can control the playback of plain chords.

- Click **Show/Hide Player Setup** to open the **Player Setup**, and in the **Player Modes** pop-up menu, select **Plain Chords**.

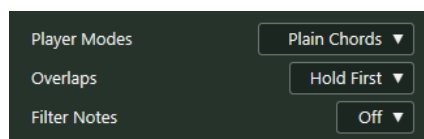

The following options are available:

Overlaps

Allows you to select what happens with the notes of the first chord when you play a chord without releasing the previous chord.

- **Hold First** holds the notes of the first chord. No note-off message is sent. If the chords have common notes, these are not triggered again.
- **Legato** releases the notes of the first chord, except for the common notes. These are held and not triggered again.
- **Stop First** releases the notes of the first chord including the common notes.

Filter Notes

Allows you to select which keys are filtered.

- **Off** filters nothing.
- **From MIDI Thru** filters unassigned keys, and keys that are assigned as remote keys for voicings, tensions, and transpose.

RELATED LINKS

[Chord Pads Setup Dialog](#) on page 741

Player Modes—Pattern

If you select **Pattern** in the **Player Modes** pop-up menu, this allows you to play the notes that make up the chord one after another as an arpeggio based on the notes of the pattern.

- Click **Show/Hide Player Setup** to open the **Player Setup**, and in the **Player Modes** pop-up menu, select **Pattern**.

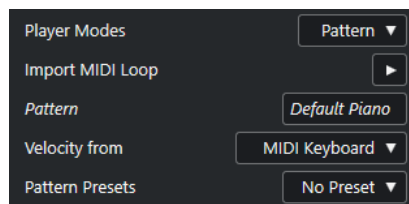

The following options are available:

In the **Selected Player Settings** section, the following options are available:

Import MIDI Loop

Allows you to select a MIDI loop that is used as a pattern.

Pattern

Allows you to drop a MIDI part from the event display that is used as a pattern. The name of the selected loop or part is shown.

Velocity from

- **Pattern** uses the velocity values from the MIDI loop or the MIDI part that is selected as a pattern.
- **MIDI Keyboard** allows you to determine the velocity values by pressing the keys on your MIDI keyboard harder or softer.

Pattern Presets

Allows you to save pattern presets.

Using the Pattern Player

You can play back the pattern of a MIDI loop or a MIDI part with chord pads. This plays back the pattern with the notes that make up the chord.

PROCEDURE

1. To the left of the chord pads, activate **Show/Hide Player Setup**.
2. In the **Selected Player Settings** section, open the **Player Modes** pop-up menu, and select **Pattern**.

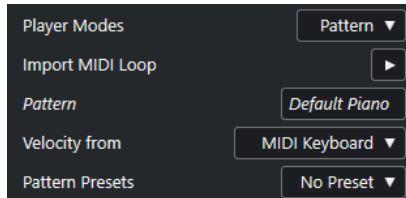

3. Perform one of the following actions:
 - Click **Import MIDI Loop** to select a MIDI loop that you want to use as a pattern.
 - Drag a MIDI part from the event display and drop it on the **Pattern** field.

NOTE

The loop or part must have between 3 and 5 voices. In the **MediaBay**, the number of voices is indicated in the **Voices** column of the **Result** list.

The loop or part is taken as a reference and defines how the chord is played.

4. In the **Velocity from** field, select a velocity source for the notes.
-

RELATED LINKS

- [Assigning Voices to Notes](#) on page 722
- [Setting up the Results List Columns](#) on page 483

Using Different Players on Multiple Tracks

You can set up different players with different sounds on different tracks. If you record-enable these tracks and play the chord pads, each track uses a dedicated player.

PROCEDURE

1. In the global track controls area of the track list, click **Add Track** .
2. Click **Instrument**.
3. In the **Count** value field, select the number of tracks that you want to add.
4. Open the **Instrument** pop-up menu and select a VST instrument.
5. Click **Add Track**.

The instrument tracks are added to the track list, and the control panels of the selected VST instrument are opened.
6. Select **Project > Chord Pads > Show/Hide Chord Pads** to open the **Chord Pads**.
7. Activate **Chord Pad Output Mode**.
8. Click **Show/Hide Player Setup**.
9. Select the first instrument track, select a sound for the VST instrument, and set up a player.

For example, select a piano sound and activate **Piano Player**.

NOTE

When setting up the player for a track, make sure that **Record Enable** or **Monitor** is only active for this particular track.

10. Select the second instrument track, select a sound for the VST instrument, and set up another player.

For example, select a guitar sound and activate **Guitar Player**.

11. Select the next instrument track, and proceed as for the other 2 tracks.

For example, select a string sound, click **Player Options**, and select **Add Basic Player**.

12. Select all instrument tracks, and click **Record Enable**.

RESULT

You can now play the chord pads and use the remote control parameters for tensions and transpose to change all chord symbols for each player simultaneously. However, if you change the **Voicing**, only the selected player is affected.

RELATED LINKS

[Add Track Dialog – Instrument](#) on page 108

Chord Pads Setup Dialog

The **Chord Pads Setup** dialog allows you to change the remote key assignments and the layout of the chord pads.

- To open the **Chord Pads Setup** dialog, click **Set up Chord Pads**.

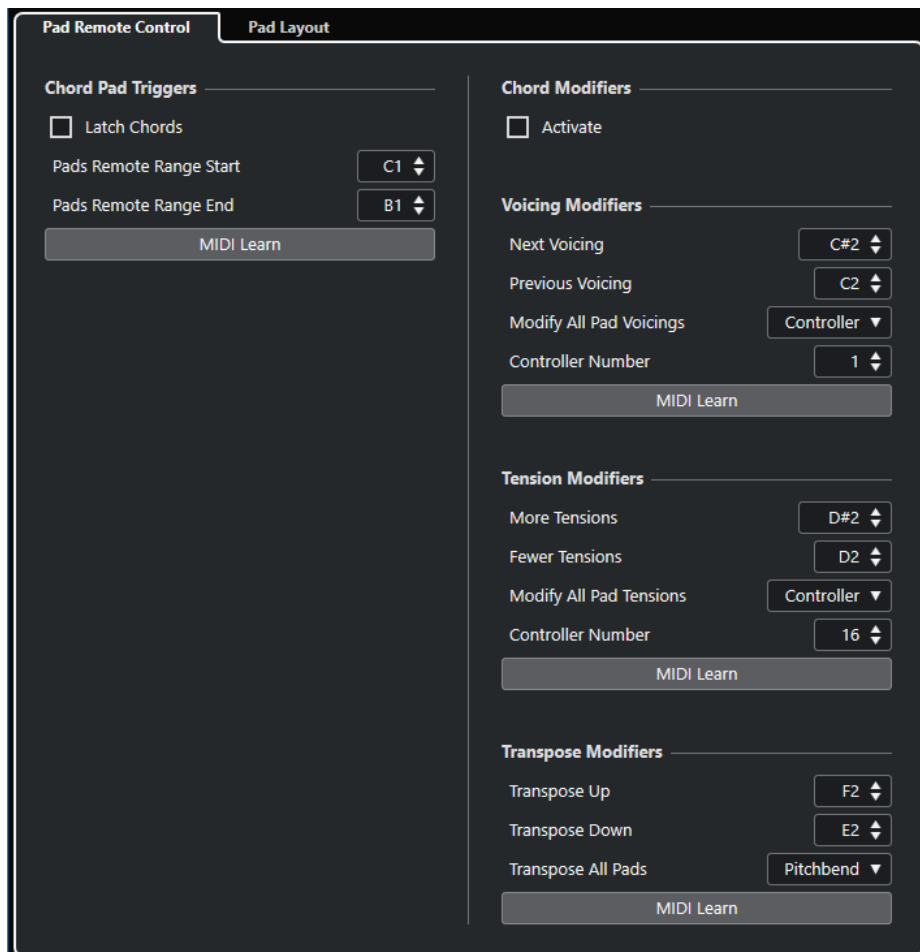

Pad Remote Control

Allows you to specify a range of remote keys that trigger the chords that are assigned to the chord pads. Here, you can also set up chord modifiers that allow you to specify how the chords are played back.

Pad Layout

Allows you to change the layout that is used for the chord pads.

RELATED LINKS

[Pad Remote Control Tab](#) on page 742

[Pad Layout Tab](#) on page 745

Pad Remote Control Tab

The **Pad Remote Control** tab in the **Chord Pads Setup** dialog allows you to specify a range of remote keys that trigger the chords that are assigned to the chord pads.

- To open the **Pad Remote Control** tab, click **Set up Chord Pads**, and in the **Chord Pads Setup** dialog, click **Pad Remote Control**.

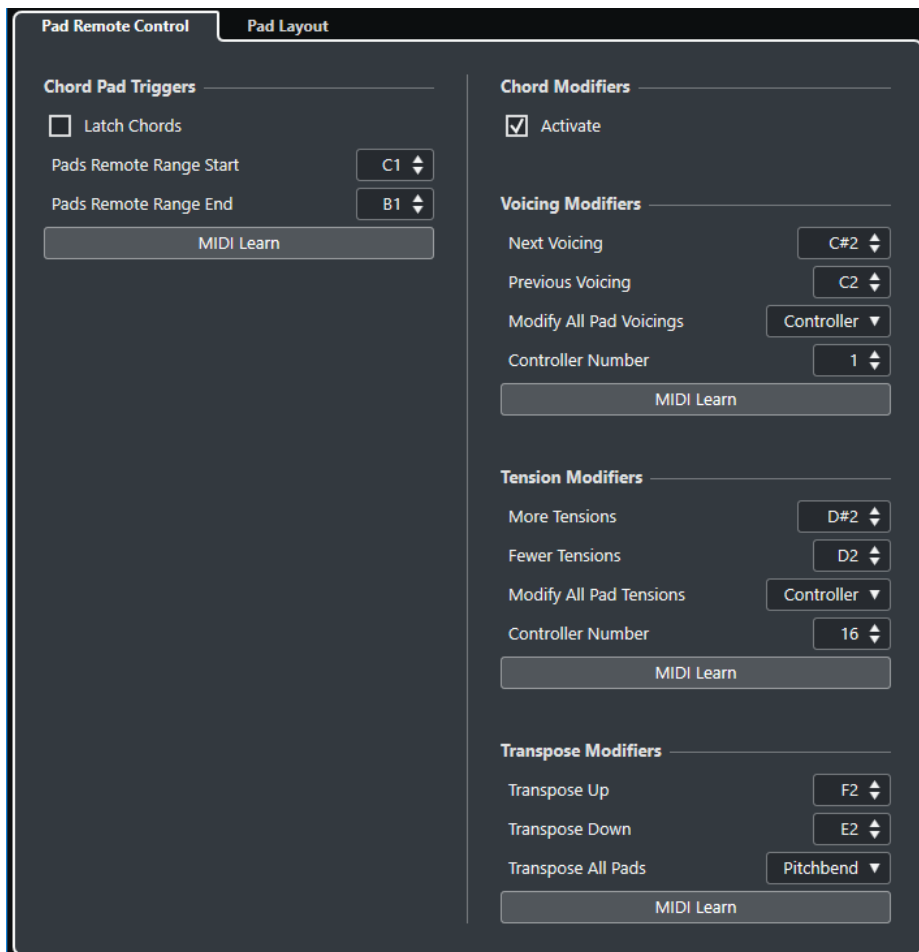

In the **Chord Pad Triggers** section, the following options are available:

Latch Chords

Activate this if you want the chord pad to play back until it is triggered again.

Pads Remote Range Start

Allows you to set the start note for the remote range. By default, this is set to C1.

Pads Remote Range End

Allows you to set the end note for the remote range. By default, this is set to B1.

MIDI Learn

Activates/Deactivates the **MIDI Learn** function to assign MIDI input to the pads remote range.

In the **Chord Modifiers** section, the following options are available:

Activate

Activates/Deactivates the remote key assignment for the parameters voicings, tensions, and transpose. If this option is deactivated, only the remote key assignment for the pads remote range is active.

NOTE

If you use the remote keys for voicings, tensions, or transposition after releasing the remote key for the chord pad, the chord pad that you last played is affected.

In the **Voicing Modifiers** section, the following options are available:

Next Voicing

Plays back the next voicing of the last played chord.

Previous Voicing

Plays back the previous voicing of the last played chord.

Modify All Pad Voicings

Allows you to set the voicings for all chord pads using one of the following modifiers:

- **No Modifier**
- **Aftertouch**
- **Pitchbend**
- **Controller**

If you select **Controller**, you can set the controller number in the **Controller Number** field.

MIDI Learn

Activates/Deactivates the **MIDI Learn** function to assign MIDI input to the parameters for changing voicings.

In the **Tension Modifiers** section, the following options are available:

More Tensions

Plays back the last played chord with more tensions.

Fewer Tensions

Plays back the last played chord with fewer tensions.

Modify All Pad Tensions

Allows you to set the tensions for all chord pads using one of the following modifiers:

- **No Modifier**
- **Aftertouch**
- **Pitchbend**
- **Controller**

If you select **Controller**, you can set the controller number in the **Controller Number** field.

MIDI Learn

Activates/Deactivates the **MIDI Learn** function to assign MIDI input to the parameters for changing tensions.

In the **Transpose Modifiers** section, the following options are available:

Transpose Up

Plays back the last played chord and transposes it upwards.

Transpose Down

Plays back the last played chord and transposes it downwards.

Transpose All Pads

Allows you to transpose all chord pads using one of the following modifiers:

- **No Modifier**
- **Aftertouch**
- **Pitchbend**
- **Controller**

If you select **Controller**, you can set the controller number in the **Controller Number** field.

MIDI Learn

Activates/Deactivates the **MIDI Learn** function to assign MIDI input to the parameters for changing transpose.

Changing the Pads Remote Range

You can widen the pads remote range to access more chord pads. If you want to use a wider key range on your MIDI keyboard for regular playing, you can narrow the pads remote range.

PROCEDURE

1. Click **Set up Chord Pads**.
2. Open the **Pad Remote Control** tab to open the remote control assignments.
3. Do one of the following:
 - Click **MIDI Learn** so that the button lights up, and on your MIDI keyboard, press the 2 keys that you want to assign as range start and range end.
 - Enter a new value in the **Pads Remote Range Start** and **Pads Remote Range End** fields.

RESULT

On the keyboard, the indication for pads remote range is changed.

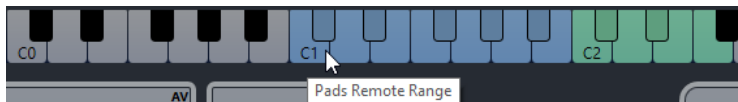

Pad Layout Tab

The **Pad Layout** tab in the **Chord Pads Setup** dialog allows you to change the layout that is used for the chord pads.

NOTE

By default, the keyboard layout is active, but you can change to a grid layout if you prefer. After changing the pad layout, you may need to adjust the remote setup.

- To open the **Pad Layout** tab, click **Set up Chord Pads**, and in the **Chord Pads Setup** dialog, click **Pad Layout**.

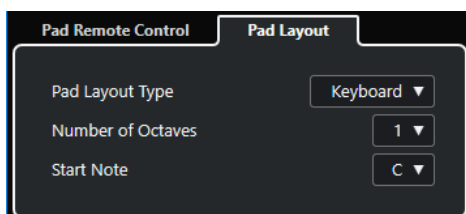

Pad Layout Type

Activate **Keyboard** to show the chord pads in a keyboard layout.

Activate **Grid** to show the chord pads in a grid layout.

Number of Octaves/Number of Rows

In **Keyboard** mode, you can select the number of octaves that you want to display.

In **Grid** mode, you can select the number of rows that you want to display.

Start Note

In **Keyboard** mode, you can select the start note for the first chord pad.

Number of Columns

In **Grid** mode, you can select the number of columns that you want to display.

Chord Pads Presets

Chord Pads Presets are templates that can be applied to newly created or to existing chord pads.

Chord Pads Presets contain the chords that are assigned to the chord pads, as well as the player configurations including any pattern data that you have imported via the **MediaBay** or by using drag and drop. **Chord Pads Presets** allow you to quickly load chords, or reuse player settings. The **Chord Pads Presets** pop-up menu is located to the left of the chord pads. **Chord Pads Presets** are organized in the **MediaBay**, and you can categorize them with attributes.

- To save/load a chord pads preset, click **Chord Pads Presets** and select **Save Chord Pads Preset/Load Chord Pads Preset**.

You can also load only the assigned chords from a preset, without loading the player configurations. This is useful if you want to use specific chords that you have saved as a preset, but do not want to alter your current player setting.

- To load only the chords of **Chord Pads Presets**, click **Chord Pads Presets** and select **Load Chords from Preset**.

In the same way, you can also load only the player configurations of **Chord Pads Presets**. This is useful if you have saved very complex player settings and want to reuse them on other chord pads without changing the assigned chords.

- To load only the player settings of **Chord Pads Presets**, click **Chord Pads Presets** and select **Load Players from Preset**.

Saving Chord Pads Presets

If you have set up the chord pads, you can save them as **Chord Pads Presets**.

PROCEDURE

1. To the left of the chord pads, click **Chord Pads Presets** and select **Save Chord Pads Preset**.
2. In the **New Preset** section, enter a name for the new preset.

NOTE

You can also define attributes for the preset.

-
3. Click **OK** to save the preset and exit the dialog.
-

Creating Chord Events from Chord Pads

You can use the chords assigned to the chord pads to create chord events in the **Project** window.

PROCEDURE

- Click a chord pad, and drag it on the chord track.
-

RESULT

A chord event is created.

RELATED LINKS

[Recording Chord Events with a MIDI Keyboard](#) on page 725

Creating MIDI Parts from Chord Pads

You can use the chords assigned to the chord pads to create MIDI parts in the **Project** window.

PROCEDURE

- Click a chord pad, and drag it on a MIDI or instrument track.
-

RESULT

A MIDI part is created. It contains the MIDI events that build up the chord and has a length of one bar.

Editing Tempo and Time Signature

You can set up a tempo and time signature for your project. By default, the tempo is set to 120 bpm, and the time signature to 4/4.

Project Tempo Modes

For every project you can set a tempo mode, depending on whether your music has a fixed tempo or if it changes throughout the project.

On the **Transport** panel, you can set the following tempo modes:

- **Fixed Tempo Mode**

If you want to work with one fixed tempo that does not change throughout the project, deactivate **Activate Tempo Track** on the **Transport** panel. You can change the tempo value to set a fixed rehearsal tempo.



- **Tempo Track Mode**

If the tempo of your music contains tempo changes, activate **Activate Tempo Track** on the **Transport** panel. You can change the tempo value to change the tempo at the cursor. If your project does not contain any tempo changes, the tempo is changed at the project start.

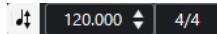

RELATED LINKS

[Setting up Projects for Tempo Changes](#) on page 751

Tempo Track Editor

The **Tempo Track Editor** provides an overview of the project tempo settings. It allows you to add and edit tempo events.

To open the **Tempo Track Editor**, do one of the following:

- Select **Project > Tempo Track**.
- Press **Ctrl/Cmd-T**.

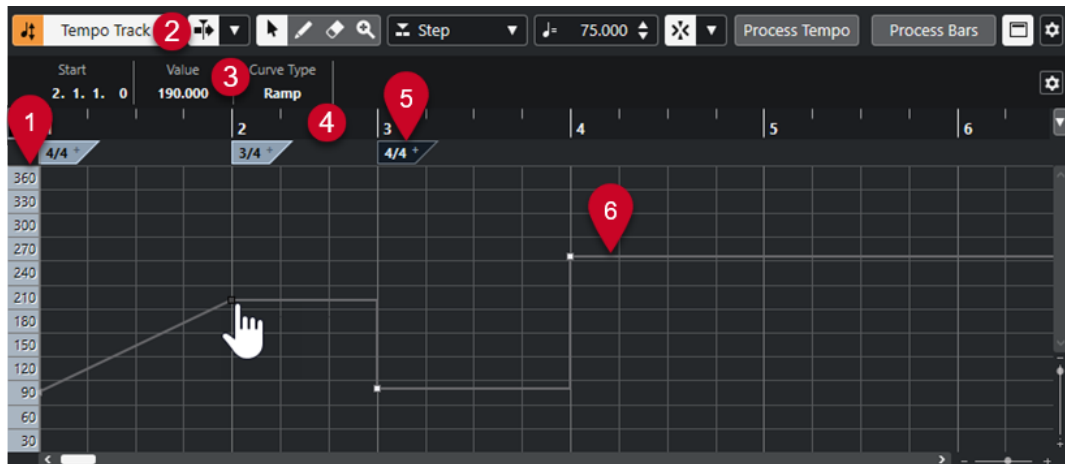

The **Tempo Track Editor** is divided into several sections:

1 Tempo scale

Shows the tempo scale in BPM.

2 Toolbar

Contains tools for selecting, adding, and changing tempo and time signature events.

3 Info line

Shows information about the selected tempo or time signature event.

4 Ruler

Shows the timeline and the display format of the project.

5 Time signature display

Shows the time signature events in the project.

6 Tempo curve display

If your project is set to a fixed tempo, only one tempo event and a fixed tempo is shown.

If your project is set to tempo track mode, the curve display shows the tempo curve with the tempo events in the project.

Tempo Track Editor Toolbar

The toolbar contains tools for selecting, adding, and changing tempo and time signature events.

The following tools are available:

Activate Tempo Track

Activate Tempo Track

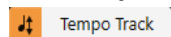

Switches the project tempo between fixed tempo mode and tempo track mode.

Left Divider

Left Divider

Tools that are placed to the left of the divider are always shown.

Auto-Scroll

Auto-Scroll



Keeps the project cursor visible during playback.

Select Auto-Scroll Settings



Allows you to activate **Page Scroll** or **Stationary Cursor** and to activate **Suspend Auto-Scroll When Editing**.

Tool Buttons

Object Selection



Selects events.

Draw



Draws events.

Erase



Deletes events.

Zoom



Zoom in. Hold **Alt/Opt** and click to zoom out.

New Tempo Type

Type of New Tempo Points

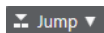

Allows you to select the type of new tempo points. Select **Ramp** if you want new tempo points to change gradually from the previous curve point to the new one. Select **Step** if you want new tempo points to change instantly. Select **Automatic** if new tempo points should have the same type as the previous curve point.

Current Tempo

Current Tempo



In fixed tempo mode, this allows you to change the current tempo.

Snap

Snap On/Off



Restricts horizontal movement and positioning to the positions specified by the **Snap Type**. Time signature events always snap to the beginning of bars.

Snap Type



Allows you to specify to what positions you want events to snap.

Right Divider

Right Divider

Tools that are placed to the right of the divider are always shown.

Show Info Line

Show/Hide Info



Opens/Closes the info line.

Set up Toolbar

Set up Toolbar



Opens a pop-up menu where you can set up which toolbar elements are visible.

Tempo Changes for Projects

If the tempo track is activated, you can set up tempo changes for your project.

NOTE

If you work in tempo track mode, make sure that the display format in the **Project** window ruler is set to **Bars+Beats**. Otherwise, you may get confusing results.

If you activate **Activate Tempo Track** on the **Transport** panel, the tempo track curve is displayed in the tempo curve display.

You can adjust the tempo value as follows:

- By adding tempo events in the **Tempo Track Editor**.

RELATED LINKS

[Setting up Projects for Tempo Changes](#) on page 751

Setting up Projects for Tempo Changes

When you create a new project, the project tempo is automatically set to fixed tempo mode. If your music contains tempo changes, you must set your project to tempo track mode.

PROCEDURE

- To set your project to tempo track mode, do one of the following:
 - On the **Transport** panel, activate **Activate Tempo Track**.
 - Select **Project > Tempo Track** and activate **Activate Tempo Track**.

RESULT

The project tempo is now set up to follow the tempo track.

RELATED LINKS

[Tempo Track Editor](#) on page 748

Setting up a Tempo Track by Adding Tempo Changes

PROCEDURE

1. Select **Project > Add Track > Tempo**.
The tempo track is added to the track list.
2. On the tempo track, open the **Type of New Tempo Points** pop-up menu and select an option.
3. Do one of the following:
 - On the toolbar, select the **Object Selection** tool and click the tempo curve.
 - On the toolbar, select the **Draw** tool, and click and draw in the tempo curve display.

NOTE

If **Snap** is activated, this determines at which time positions you can insert tempo curve points.

RESULT

The tempo event is added to the tempo curve.

Editing Tempo Events

In the **Tempo Track Editor**, you can edit selected tempo events.

Use the following methods:

- With the **Object Selection** tool, click and drag horizontally and/or vertically.
- On the info line, adjust the tempo value in the **Value** field.

NOTE

When editing tempo events on tempo curves, make sure that the display format in the **Project** window ruler is set to **Bars+Beats**. Otherwise, you may get confusing results.

Use the following methods to remove tempo events:

- With the **Erase** tool, click the tempo event.
- Select the tempo event and press **Backspace**.

NOTE

You cannot remove the first tempo event.

Use the following method to change the tempo curve type:

- On the info line, adjust the tempo curve type in the **Type** field.

Setting up a Fixed Project Tempo

If your music does not contain tempo changes, and the tempo track is deactivated, you can set up a fixed tempo for your project.

When the tempo track is deactivated, the tempo track curve is grayed out. The fixed tempo is displayed as a horizontal line in the tempo curve display.

If you know the tempo of your music, you can adjust the tempo value in the following areas:

- **Tempo** field on the **Transport** panel
- **Current Tempo** field on the **Tempo Track Editor** toolbar

If you do not know the tempo of your music, use one of the following tools to calculate and set it:

- **Beat Calculator**
- **Set Project Tempo from Loop**

RELATED LINKS

[Setting the Project Tempo from a Recording](#) on page 753

[Setting the Project Tempo from an Audio Loop](#) on page 754

Setting the Project Tempo from a Recording

You can calculate the tempo of freely recorded audio or MIDI material with the **Beat Calculator** and set it as the project tempo.

PREREQUISITE

The **Tempo Track** is deactivated, that is, the tempo mode is set to **Fixed**.

PROCEDURE

1. On the **Project** window toolbar, select the **Range Selection** tool.
 2. In the event display, make a selection that covers an exact number of beats of the recording.
 3. Select **Project > Beat Calculator**.
 4. In the **Beats** value field, enter the number of beats that the selection encompasses.
The calculated tempo is shown in the **BPM** field.
 5. In the **Insert Tempo into Tempo Track** section, click **At Tempo Track Start**.
-

RESULT

The project tempo is set to the tempo calculated from your recording.

RELATED LINKS

[Beat Calculator](#) on page 754

Setting the Project Tempo by Tapping

You can set the tempo of freely recorded audio or MIDI material by tapping.

PREREQUISITE

The tempo track is deactivated, that is, tempo mode is set to **Fixed**.

PROCEDURE

1. Activate playback.
2. Select **Project > Beat Calculator**.
3. Click **Tap Tempo**.
The **Tap Tempo** window opens.

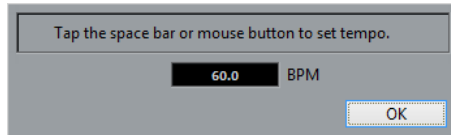

4. Use **Space** to tap the tempo of the recording that is played back.
In the **BPM** field, the calculated tempo is updated each time you tap.
 5. Click **OK** to close the window.
The tapped tempo is shown in the **BPM** field of the **Beat Calculator**.
 6. Click one of the buttons in the **Insert Tempo into Tempo Track** section to insert the calculated tempo into the tempo track.
-

RESULT

The project tempo is set to the tapped tempo.

RELATED LINKS

[Setting up a Fixed Project Tempo](#) on page 752

Setting the Project Tempo from an Audio Loop

You can set the project tempo from the tempo of an audio loop.

PREREQUISITE

Your project contains an audio loop that is not in **Musical Mode**.

PROCEDURE

1. In the **Project** window ruler, set the left locator to the beginning of the audio loop.
 2. Set the right locator to the end of the last bar.
This does not need to match the end of the audio loop, but its number of bars.
 3. Select the audio loop.
 4. Select **Audio > Advanced > Set Tempo from Event**.
You are asked if you want to set the global project tempo.
 5. Perform one of the following actions:
 - Click **Yes** to adjust the project tempo globally.
 - Click **No** to adjust the project tempo only in the section of the audio event.
-

RESULT

The project tempo is set to the tempo calculated for the audio loop.

Beat Calculator

The **Beat Calculator** is a tool for calculating the tempo of freely recorded audio or MIDI material. It also allows you to set the tempo by tapping.

- To open the **Beat Calculator** for an audio or MIDI recording, select **Project > Beat Calculator**.

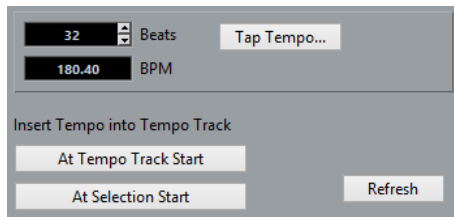

Beats

Allows you to enter the number of beats for the selected section of your recording.

BPM

Shows the tempo calculated for the selection.

Tap Tempo

Opens a window where you can specify a tempo by tapping.

At Tempo Track Start

If your project is in tempo track mode, the calculated tempo is set as the first tempo curve point. If your project is in fixed tempo mode, the calculated tempo is set for the entire project.

At Selection Start

If your project is in tempo track mode, the calculated tempo is set as a new tempo event at the start of the selection.

Refresh

Allows you to recalculate the tempo. This is useful if you adjust the selection, for example.

Set Definition from Tempo Dialog

The **Set Definition from Tempo** dialog allows you to set up freely recorded audio material to follow a specific tempo.

- To open the **Set Definition from Tempo** dialog for an audio recording, select **Audio > Advanced > Set Definition from Tempo**.

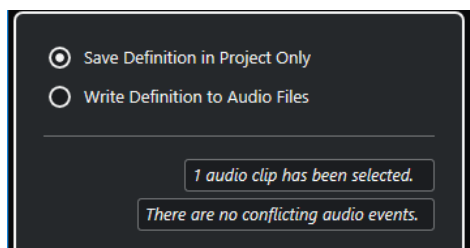

Save Definition in Project Only

Saves the tempo information in the project file only.

Write Definition to Audio Files

Writes the tempo information to the selected audio files. This is useful if you want to use them in other projects together with the tempo information.

Adjusting the Audio Tempo to the Project Tempo

You can adjust the tempo of freely recorded audio material to the project tempo.

PROCEDURE

1. Select the audio events that you want to adjust to the project tempo.
2. Select **Audio > Advanced > Set Definition from Tempo**.
3. Optional: Adjust the settings.
4. Click **OK**.

RESULT

The tempo information is copied to the audio and the tracks are set to musical time base. This is achieved by applying warping to the events. **Musical Mode** is activated for the audio events. The audio tracks now follow any tempo changes in the project.

Time Signature Events

You can set up one or more time signatures for a project.

You can set up the first time signature event of your project on the **Transport** panel. You can add further time signature events in the **Tempo Track Editor**.

RELATED LINKS

[Project Window Toolbar](#) on page 36

[Transport Bar](#) on page 47

[Adding Time Signature Events in the Tempo Track Editor](#) on page 756

Adding Time Signature Events in the Tempo Track Editor

PROCEDURE

1. Select **Project > Tempo Track** to open the **Tempo Track Editor**.
2. Select **Draw** on the toolbar, and in the time signature display, click at the time position where you want to insert the time signature event.
3. Edit the numerator and the denominator to change the value of the time signature event.

NOTE

You can also select the time signature event and edit the time signature value on the info line.

RESULT

The time signature event is added at the specified time position. The timeline and the event displays for the **Project** window and the editors reflect the changes.

Export Audio Mixdown

The **Export Audio Mixdown** function allows you to mix down and export all audio that is contained between the left and right locators of a project.

- To open the **Export Audio Mixdown** dialog, select **File > Export > Audio Mixdown**.

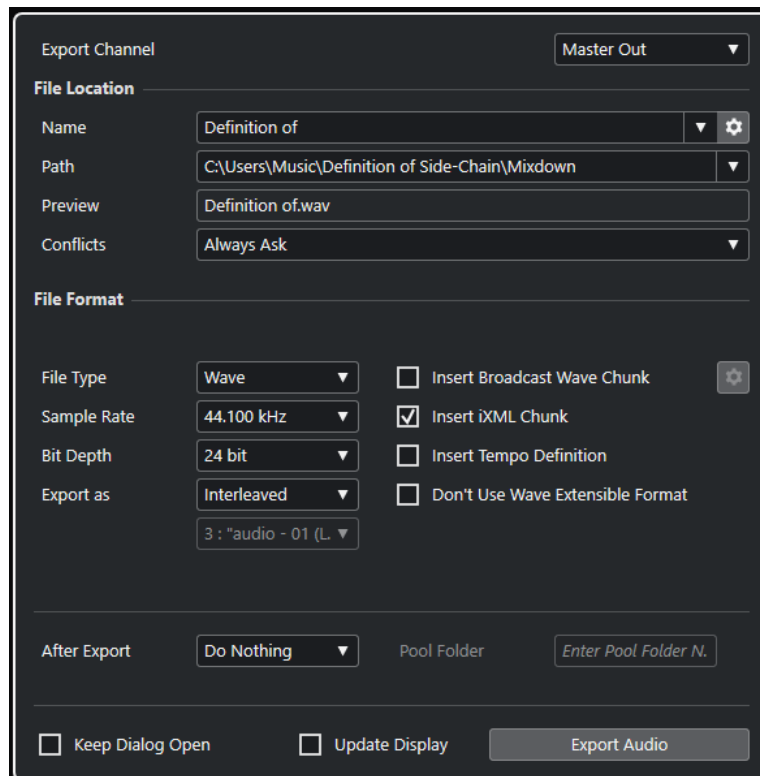

Export Audio Mixdown Dialog

The **Export Audio Mixdown** dialog allows you to set up how audio is mixed down and exported.

- To open the **Export Audio Mixdown** dialog, select **File > Export > Audio Mixdown**.

The **Export Audio Mixdown** dialog is divided into several sections.

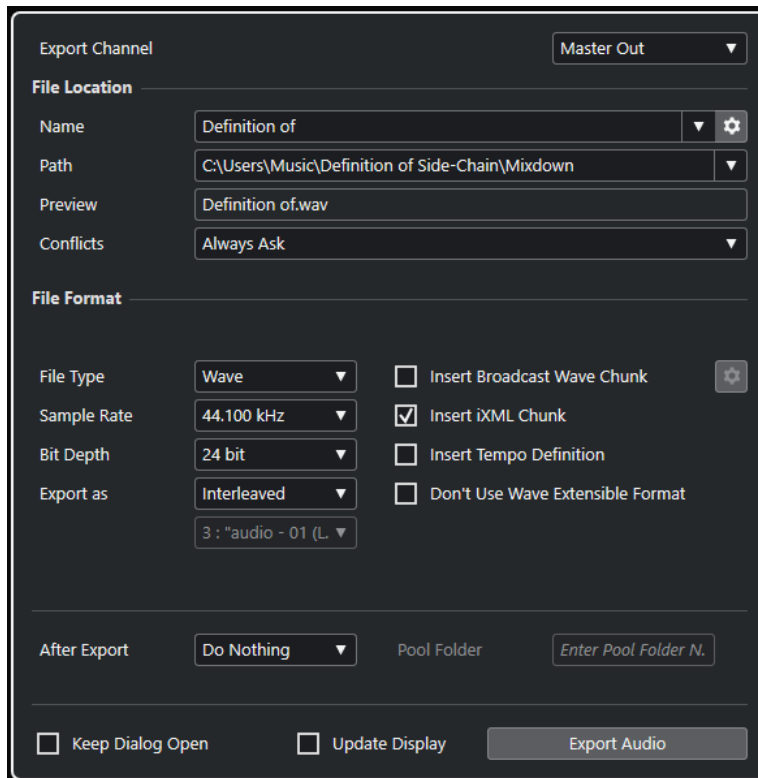

Export Channel

In the **Export Channel** pop-up menu, you can select an output channel for export.

File Location

In the **File Location** section, the following options are available:

Name

Allows you to specify the name of the mixdown file.

Click **File Name Options** to open a pop-up menu with naming options:

- **Set to Project Name** inserts the project name into the **Name** field.
- **Auto Update Name** adds a number to the file name and increments the number every time you export a file.

Click **Set up Naming Scheme** to open a dialog where you can specify a naming scheme.

Path

Allows you to specify the file path for the mixdown file.

Click **Path Options** to open a pop-up menu with file path options:

- **Choose** opens a dialog that allows you to browse for a file location.
- **Use Project Audio Folder** sets the path to the **Audio** folder of your project.
- **Project Mixdown Folder** sets the path to the **Mixdown** folder of your project.

NOTE

If you activate **Project Mixdown Folder**, the option **Use Project Audio Folder** is automatically disabled.

The **Mixdown** folder is automatically created in your project folder. It is used by default if no export path information is available, that is, if you create a new empty project, or if you load or create a project from a template.

- **Recent Paths** allows you to select recently selected file locations.
The **Mixdown** folder is not added to the list of **Recent Paths**.
- **Clear Recent Paths** allows you to delete all recently selected file locations.

Preview

Shows the file name with the naming scheme applied.

Conflicts

Exporting audio can cause naming conflicts with existing files that have the same name. You can define how file name conflicts are resolved:

- **Always Ask** opens a warning that allows you to choose if an existing file should be overwritten or if a new unique file name should be created by adding an incremental number.
- **Create Unique File Name** creates a unique file name by adding an incremental number.
- **Always Overwrite** always overwrites the existing file.

File Format

In the **File Format** section, the following options are available:

File Type

Allows you to select a file type for the mixdown file.

Sample Rate

Sets the sample rate for the mixdown file.

NOTE

- Wave, AIFF files only: If you set the value lower than the project sample rate, the audio quality degrades and the high-frequency content is reduced. If you set the value higher than the project sample rate, the file size increases without increasing the audio quality. For CD burning, select 44.100 kHz, because this is the sample rate used on audio CDs.

Bit Depth (Wave, AIFF, FLAC)

Allows you to select a bit depth for the mixdown file.

Bit Rate (MPEG 1 Layer 3)

Sets the bit rate for the MP3 file. The higher the bit rate, the better the audio quality and the larger the file. For stereo audio, 128 kBit/s is considered to be providing good audio quality results.

Export as

Allows you to select a channel mode for the mixdown file:

- **Interleaved**
Allows you to export to an interleaved file.
- **Split Channels**
Allows you to export the 2 channels of a stereo bus as separate mono files.
- **Mono Downmix**

Allows you to downmix the 2 channels of a stereo bus to a single mono file.

Insert Broadcast Wave Chunk (Wave, AIFF)

Activates the embedding of additional file information in Broadcast Wave format.

NOTE

By activating this option, you create a Broadcast Wave file. Some applications may not be able to handle these files. If you get problems using the file in another application, deactivate **Insert Broadcast Wave Chunk** and export the file again.

Set up Broadcast Wave Chunk (Wave, AIFF)

Opens the **Broadcast Wave Chunk** dialog where you can enter information.

Don't Use Wave Extensible Format (Wave)

Deactivates the Wave Extensible format that contains additional metadata, such as the speaker configuration.

Insert iXML Chunk (Wave, AIFF)

Includes additional project-related metadata, such as project name, author, and project frame rate.

Insert Tempo Definition (Wave, AIFF)

This option is only available if **Insert iXML Chunk** is activated. It allows you to include tempo information from the tempo track in the iXML chunk of the exported files.

High-Quality Mode (MPEG 1 Layer 3)

Sets the encoder to a different resampling mode. This may give better results depending on your settings. However, it does not allow you to select the **Sample Rate**.

Insert ID3 Tag (MPEG 1 Layer 3)

Includes ID3 Tag information in the exported file.

Edit ID3 Tag (MPEG 1 Layer 3)

Opens the **Setup ID3 Tag** dialog that allows you to enter information about the file. This information is embedded in the file and can be displayed by most MP3 playback applications.

Compression Level (FLAC)

Sets the compression level for the FLAC file. Since FLAC is a lossless format, the level has more influence on the encoding speed than on the file size.

Quality (OggVorbis)

Sets the quality for the variable bit rate encoding. This setting determines between which limits the bit rate will vary. The higher the value, the higher the sound quality but also the larger the files.

After Export

- **Do Nothing** does nothing after export.
- **Open in WaveLab** opens your mixdown file in a WaveLab version after export. This requires that a WaveLab version is installed on your computer.
- **Create New Project**

NOTE

This option is only available for uncompressed file formats, and if **Use Project Audio Folder** is deactivated.

Creates a new project that contains an audio track for each of the exported channels, as well as the signature and tempo track of the original project. The tracks will have the corresponding mixdown file as audio event. The track names will be identical with the export channel names. The new project will be the active project.

Activating this option disables the **Insert to Pool** and **Create Audio Track** options.

- **Create Audio Track**

Creates an audio event that plays the clip on a new audio track, starting at the left locator. Activating this option also activates the **Pool** option.

- **Insert to Pool**

Imports the resulting audio file automatically back into the **Pool** as a clip. Deactivating this option also deactivates the **Create Audio Track** option.

Pool Folder

Allows you to specify a **Pool** folder for the clip.

General Options

In the bottom section, the following options are available:

Keep Dialog Open

Activate this to keep the dialog open after clicking **Export Audio**.

Update Display

Updates the meters during the export process. This allows you to check for clipping, for example.

Export Audio

Allows you to export your audio as specified.

RELATED LINKS

[File Formats](#) on page 764

Naming Scheme Dialog

The **Naming Scheme** dialog allows you to define naming schemes for the file name of the audio material that you want to export.

The naming attributes that are available in this dialog depend on the channel that you selected for export.

- To open the **Naming Scheme** dialog, open the **Export Audio Mixdown** dialog, and in the **File Location** section, to the right of the **Name** field, click **Set up Naming Scheme**.

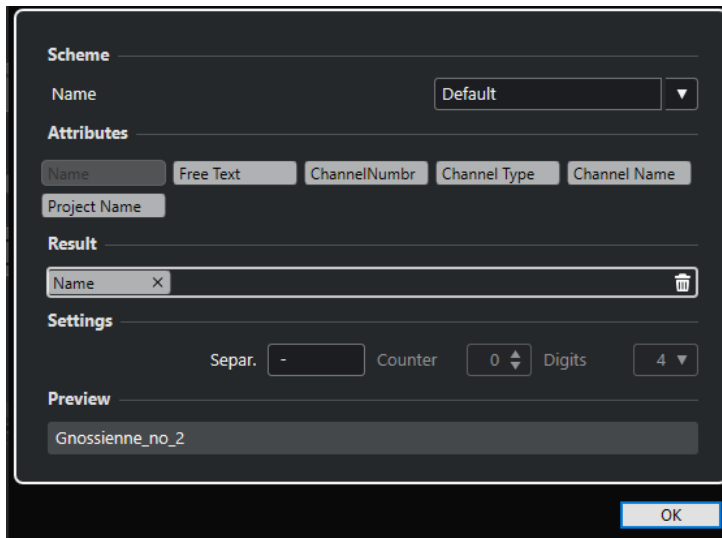

Scheme

Allows you to save and delete naming schemes.

Attributes

Holds the following naming scheme attributes:

- **Name**
Adds the name to the resulting file name.
- **Free Text**
Allows you to enter free text.
- **Channel Number**
Adds the channel number to the resulting file name.
- **Channel Type**
Adds the channel type to the resulting file name.
- **Channel Name**
Adds the channel name to the resulting file name.
- **Project Name**
Adds the project name to the resulting file name.

Result

Allows you to drop attributes for the file name and to rearrange them by dragging.

Settings

Allows you to select separator and counter settings.

- **Separator**
Divides attributes from each other.

Preview

Displays a preview of your current settings.

Defining Naming Schemes

You can define a naming scheme by combining attributes that determine the structure of the file names for the exported audio files.

PROCEDURE

1. In the **Naming Scheme** dialog, drag up to 5 attributes into the **Result** section.
You can also double-click an attribute to add it to the **Result** section.
2. Optional: In the **Settings** section, double-click the **Separator** text field to change the separator.
The **Preview** section displays the file name scheme according to your settings.
3. Optional: Click the **Name** value field in the **Scheme** section and enter a preset name. Press **Return** to save your settings as a preset.

NOTE

The preset is only available for the channels that are selected in the **Channel Selection** section.

4. Click **OK**.
-

Entering Free Text

You can enter free text that is added to the file name of the exported audio files.

PROCEDURE

1. In the **File Location** section of the **Export Audio Mixdown** dialog, click **Set up Naming Scheme**.

The **Naming Scheme** dialog opens.

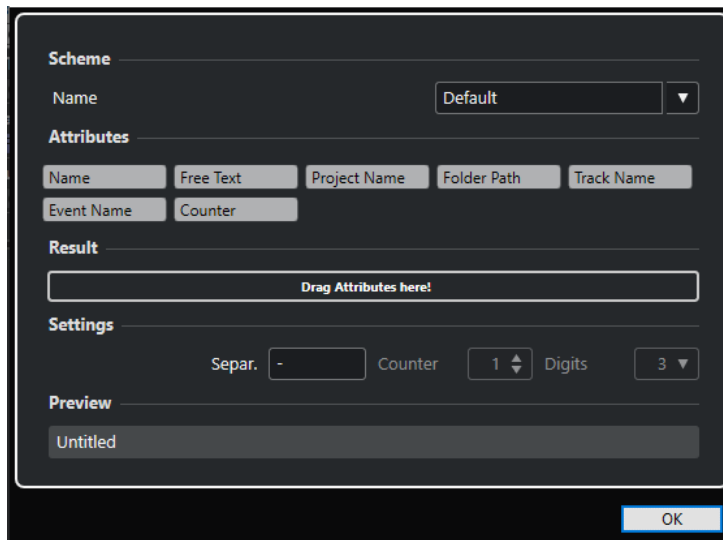

2. Open the **Scheme** pop-up menu and select **New Scheme**.
3. Double-click the **Free Text** attribute to add it to the **Result** field.
4. In the **Result** field, double-click the **Free Text** label and enter the text that you want to add.
5. Press **Return** to confirm your changes.

6. Click **OK**.

RESULT

The text that you entered is added to the file name scheme and will be applied on export.

Mixing Down to Audio Files

You can mix selected channels down to audio files.

PREREQUISITE

- You have set up the left and right locators so that they encompass the range that you want to mix down.
- You have set up your tracks so that they play back the way you want.
This includes muting unwanted tracks or parts, making manual **MixConsole** settings, and/or activating the **R** (Read) automation buttons for **MixConsole** channels.

IMPORTANT

The setting of the **Output Routing** in the corresponding track **Inspector** determines the channel width of the **Export Audio Mixdown** export. This means if no main output bus is selected, the exported audio file only contains silence.

PROCEDURE

1. Select **File > Export > Audio Mixdown**.
2. In the **File Location** section, set up a valid export path.
3. Set up the file name.

NOTE

You can define a naming scheme in the **Naming Scheme** dialog.

4. In the **File Format** section, set up the settings according to your needs.
 5. Click **Export Audio**.
-

RESULT

The audio is exported.

File Formats

The **File Type** pop-up menu in the **File Format** section allows you to select a format and make additional settings for the mixdown file.

Wave file

This is the most common file format on the PC platform. Wave files have the extension **.wav**.

AIFF file

This is an audio file format standard defined by Apple Inc. AIFF files are used on most computer platforms. The files can contain embedded text strings. AIFF files have the extension **.aif**.

MPEG 1 Layer 3 file

This is a family of standards used for encoding audio-visual information, such as movies, video, and music in a digital compressed format. Cubase can read MPEG Layer 2 and MPEG Layer 3. MP3 files are highly compressed files that still provide good audio quality. The file extension is **.mp3**.

FLAC file

This is an open source format that reduces the size of audio files by 50 % to 60 %, compared to regular Wave files. The file extension is **.flac**.

Ogg Vorbis file

This is an open source, patent-free audio encoding and streaming technology. The Ogg Vorbis encoder uses variable bit rate encoding. It offers small, compressed audio files of comparatively high audio quality. The file extension is **.ogg**.

RELATED LINKS

[Wave Files](#) on page 765

[AIFF Files](#) on page 766

[MP3 \(MPEG 1 Layer 3\) Files](#) on page 767

[FLAC Files](#) on page 768

[Ogg Vorbis Files](#) on page 769

[File Format](#) on page 759

Wave Files

Wave files have the extension **.wav** and are the most common file format on the PC platform.

- To open the settings for wave files, select **Wave** in the **File Type** pop-up menu.

Sample Rate

Sets the sample rate for the mixdown file.

NOTE

If you set the value lower than the project sample rate, the audio quality degrades and the high-frequency content is reduced. If you set the value higher than the project sample rate, the file size increases without increasing the audio quality. For CD burning, select 44.100 kHz, because this is the sample rate used on audio CDs.

Bit Depth

Allows you to select a bit depth for the mixdown file. You can select **8 bit**, **16 bit**, **24 bit**, **32 bit**, **32 bit float**, or **64 bit float**. If you plan to re-import the mixdown file into Cubase, select **32 bit float**. This is the resolution used for audio processing in Cubase. 32 bit (float) files are twice the size of 16 bit files. For CD burning, use the **16 bit** option, as CD audio is always 16 bit. In this case, we recommend dithering.

Activating the **UV-22HR** dithering plug-in reduces the effects of quantization noise and artifacts when converting the audio to 16 bit. A resolution of 8 bit results in limited audio quality and should only be used if required.

Export as

Allows you to select a channel mode for the mixdown file:

- **Interleaved**
Allows you to export to an interleaved file.
- **Split Channels**

Allows you to export the 2 channels of a stereo bus as separate mono files.

- **Mono Downmix**

Allows you to downmix the 2 channels of a stereo bus to a single mono file.

Insert Broadcast Wave Chunk

Activates the embedding of additional file information in Broadcast Wave format.

NOTE

By activating this option, you create a Broadcast Wave file. Some applications may not be able to handle these files. If you get problems using the file in another application, deactivate **Insert Broadcast Wave Chunk** and export the file again.

Set up Broadcast Wave Chunk

Opens the **Broadcast Wave Chunk** dialog where you can enter information.

Insert iXML Chunk

Includes additional project-related metadata, such as project name, author, and project frame rate.

Insert Tempo Definition

This option is only available if **Insert iXML Chunk** is activated. It allows you to include tempo information from the tempo track in the iXML chunk of the exported files.

Don't Use Wave Extensible Format

Deactivates the Wave Extensible format that contains additional metadata, such as the speaker configuration.

AIFF Files

AIFF stands for Audio Interchange File Format, a standard defined by Apple Inc. AIFF files have the extension **.aif** and are used on most computer platforms.

- To open the settings for AIFF files, select **AIFF** in the **File Type** pop-up menu.

Sample Rate

Sets the sample rate for the mixdown file.

NOTE

If you set the value lower than the project sample rate, the audio quality degrades and the high-frequency content is reduced. If you set the value higher than the project sample rate, the file size increases without increasing the audio quality. For CD burning, select 44.100 kHz, because this is the sample rate used on audio CDs.

Bit Depth

Allows you to select a bit depth for the mixdown file. You can select **8 bit**, **16 bit**, **24 bit**, **32 bit**, **32 bit float**, or **64 bit float**. If you plan to re-import the mixdown file into Cubase, select **32 bit float**. This is the resolution used for audio processing in Cubase. 32 bit (float) files are twice the size of 16 bit files. For CD burning, use the **16 bit** option, as CD audio is always 16 bit. In this case, we recommend dithering.

Activating the **UV-22HR** dithering plug-in reduces the effects of quantization noise and artifacts when converting the audio to 16 bit. A resolution of 8 bit results in limited audio quality and should only be used if required.

Export as

Allows you to select a channel mode for the mixdown file:

- **Interleaved**
Allows you to export to an interleaved file.
- **Split Channels**
Allows you to export the 2 channels of a stereo bus as separate mono files.
- **Mono Downmix**
Allows you to downmix the 2 channels of a stereo bus to a single mono file.

Insert Broadcast Wave Chunk

Activates the embedding of additional file information in Broadcast Wave format.

NOTE

By activating this option, you create a Broadcast Wave file. Some applications may not be able to handle these files. If you get problems using the file in another application, deactivate **Insert Broadcast Wave Chunk** and export the file again.

Set up Broadcast Wave Chunk

Opens the **Broadcast Wave Chunk** dialog where you can enter information.

Insert iXML Chunk

Includes additional project-related metadata, such as project name, author, and project frame rate.

Insert Tempo Definition

This option is only available if **Insert iXML Chunk** is activated. It allows you to include tempo information from the tempo track in the iXML chunk of the exported files.

MP3 (MPEG 1 Layer 3) Files

MP3 files are highly compressed files that still provide good audio quality. They have the extension **.mp3**.

- To open the settings for MP3 files, select **MPEG 1 Layer 3** in the **File Type** pop-up menu.

Sample Rate

Sets the sample rate for the mixdown file.

Bit Rate

Sets the bit rate for the MP3 file. The higher the bit rate, the better the audio quality and the larger the file. For stereo audio, 128 kBit/s is considered to be providing good audio quality results.

Export as

Allows you to select a channel mode for the mixdown file:

- **Interleaved**
Allows you to export to an interleaved file.
- **Split Channels**
Allows you to export the 2 channels of a stereo bus as separate mono files.
- **Mono Downmix**
Allows you to downmix the 2 channels of a stereo bus to a single mono file.

High-Quality Mode

Sets the encoder to a different resampling mode. This may give better results depending on your settings. However, it does not allow you to select the **Sample Rate**.

Insert ID3 Tag

Includes ID3 Tag information in the exported file.

Edit ID3 Tag

Opens the **Setup ID3 Tag** dialog that allows you to enter information about the file. This information is embedded in the file and can be displayed by most MP3 playback applications.

FLAC Files

Free Lossless Audio Codec files are audio files that are typically 50 % to 60 % smaller than regular Wave files.

- To open the settings for FLAC files, select **FLAC** in the **File Type** pop-up menu.

Sample Rate

Sets the sample rate for the mixdown file.

NOTE

If you set the value lower than the project sample rate, the audio quality degrades and the high-frequency content is reduced. If you set the value higher than the project sample rate, the file size increases without increasing the audio quality. For CD burning, select 44.100 kHz, because this is the sample rate used on audio CDs.

Bit Depth

Allows you to select a bit depth for the mixdown file. You can select **8 bit**, **16 bit**, **24 bit**, **32 bit**, **32 bit float**, or **64 bit float**. If you plan to re-import the mixdown file into Cubase, select **32 bit float**. This is the resolution used for audio processing in Cubase. 32 bit (float) files are twice the size of 16 bit files. For CD burning, use the **16 bit** option, as CD audio is always 16 bit. In this case, we recommend dithering.

Activating the **UV-22HR** dithering plug-in reduces the effects of quantization noise and artifacts when converting the audio to 16 bit. A resolution of 8 bit results in limited audio quality and should only be used if required.

Export as

Allows you to select a channel mode for the mixdown file:

- **Interleaved**
Allows you to export to an interleaved file.
- **Split Channels**
Allows you to export the 2 channels of a stereo bus as separate mono files.
- **Mono Downmix**
Allows you to downmix the 2 channels of a stereo bus to a single mono file.

Compression Level

Sets the compression level for the FLAC file. Since FLAC is a lossless format, the level has more influence on the encoding speed than on the file size.

Ogg Vorbis Files

Ogg Vorbis is an open source, patent-free audio encoding and streaming technology, offering compressed audio files of small size, but with comparatively high audio quality. Ogg Vorbis files have the extension **.ogg**.

- To open the settings for Ogg Vorbis files, select **OggVorbis** in the **File Type** pop-up menu.

Quality

Sets the quality for the variable bit rate encoding. This setting determines between which limits the bit rate will vary. The higher the value, the higher the sound quality but also the larger the files.

Export as

Allows you to select a channel mode for the mixdown file:

- **Interleaved**
Allows you to export to an interleaved file.
- **Split Channels**
Allows you to export the 2 channels of a stereo bus as separate mono files.
- **Mono Downmix**
Allows you to downmix the 2 channels of a stereo bus to a single mono file.

Synchronization

Synchronization is the process of getting 2 or more devices to play back together at the same speed, position, and phase. These devices can range from audio and video tape machines to digital audio workstations, MIDI sequencers, synchronization controllers, and digital video devices.

If you know the position and speed for the master device, you can resolve the speed and position of the slave device to it, so that the 2 devices play in perfect sync with one another.

Position (Time)

The following clock signals are used to specify time positions:

- **Audio word clock**
Specifies time positions in samples.
- **Timecode**
Specifies time positions in video frames.
- **MIDI clock**
Specifies time positions in musical bars and beats.

Speed (Clock)

The following clock signals measure the speed of a device:

- **Audio word clock**
Measures the sample rate.
- **Timecode**
Measures the frame rate.
- **MIDI clock**
Measures the tempo.

Phase

Phase is the alignment of the position and speed components to each other. Each pulse of the speed component should be aligned with each measurement of the position for the most accuracy. Each frame of timecode should be perfectly lined up with the correct sample of audio. Put simply, phase is the very precise position of a synchronized device relative to the master (sample accuracy).

Master and Slave

Calling one device the master and another one the slave can lead to confusion. Therefore, the timecode relationship and the machine control relationship must be differentiated in this regard.

- **Timecode Master**
The device generating position information or timecode.
- **Timecode Slave**

Any device receiving the timecode and synchronizing or locking to it.

Timecode Formats

The position of any device is most often described using timecode. Timecode represents time using hours, minutes, seconds, and frames to provide a location for each device. Each frame represents a visual film or video frame.

The following timecode formats are supported:

- **LTC**
Longitudinal timecode or LTC is an analog signal that can be recorded on tape. It should be used for positional information primarily. It can also be used for speed and phase information as a last resort if no other clock source is available.
- **VITC**
Vertical interval timecode or VITC is contained within a composite video signal. It is recorded onto video tape and is physically tied to each video frame.
- **MTC**
MIDI timecode or MTC is identical to LTC except that it is a digital signal transmitted via MIDI.

Timecode Standards

Timecode has several standards. The subject of the various timecode formats can be very confusing due to the use and misuse of the shorthand names for specific timecode standards and frame rates. The timecode format can be divided into 2 variables: frame count and frame rate.

Frame count (frames per second)

The frame count of timecode defines the standard with which it is labeled. There are 4 timecode standards:

24 fps Film (F)

This frame count is the traditional count for film. It is also used for HD video formats and commonly referred to as 24 p. However, with HD video, the actual frame rate or speed of the video sync reference is slower, 23.976 frames per second, so timecode does not reflect the actual real time on the clock for 24 p HD video.

25 fps PAL (P)

This is the broadcast video standard frame count for European (and other PAL countries) television broadcast.

30 fps non-drop SMPTE (N)

This is the frame count of NTSC broadcast video. However, the actual frame rate or speed of the video format runs at 29.97 fps. This timecode clock does not run in real time. It is slightly slower by 0.1 %.

30 fps drop-frame SMPTE (D)

The 30 fps drop-frame count is an adaptation that allows a timecode display running at 29.97 fps to actually show the clock-on-the-wall-time of the timeline by dropping or skipping specific frame numbers in order to catch the clock up to real time.

NOTE

Remember to keep the timecode standard (or frame count) and frame rate (or speed) separate.

Frame rate (speed)

Regardless of the frame counting system, the actual speed at which frames of video go by in real time is the true frame rate.

Cubase supports the following frame rates:

24 fps

This is the true speed of standard film cameras.

25 fps

This is the frame rate of PAL video.

29.97 fps/29.97 dfps

This is the frame rate of NTSC video. The count can be either non-drop or drop-frame.

30 fps/30 dfps

This frame rate is not a video standard anymore but has been commonly used in music recording. Many years ago, it was the black and white NTSC broadcast standard. It is equal to NTSC video being pulled up to film speed after a 2-3 telecine transfer. The count can be either non-drop or drop-frame.

IMPORTANT

Video formats with a variable frame rate (VFR) are not supported.

Frame count vs. frame rate

Part of the confusion in timecode stems from the use of frames per second in both the timecode standard and the actual frame rate. When used to describe a timecode standard, frames per second defines how many frames of timecode are counted before one second on the counter increments. When describing frame rates, frames per second define how many frames are played back during the span of one second of real time. In other words: Regardless of how many frames of video there are per second of timecode (frame count), those frames can be moving at different rates depending on the speed (frame rate) of the video format. For example, NTSC timecode (SMPTE) has a frame count of 30 fps. However, NTSC video runs at a rate of 29.97 fps. So the NTSC timecode standard known as SMPTE is a 30 fps standard that runs at 29.97 fps real time.

Clock Sources

Once the position is established, the next essential factor for synchronization is the playback speed. Once 2 devices start playing from the same position, they must run at exactly the same speed in order to remain in sync. Therefore, a single speed reference must be used and all devices in the system must follow that reference. With digital audio, the speed is determined by the audio clock rate. With video, the speed is determined by the video sync signal.

Audio clock

Audio clock signals run at the speed of the sample rate used by a digital audio device and are transmitted in several ways:

Word clock

Word clock is a dedicated signal running at the current sample rate that is fed over BNC coaxial cables between devices. It is the most reliable form of audio clock and is relatively easy to connect and use.

AES/SPDIF Digital Audio

An audio clock source is embedded within AES and SPDIF digital audio signals. This clock source can be used as a speed reference. Preferably, the signal itself does not contain any actual audio (digital black), but any digital audio source can be used if necessary.

ADAT Lightpipe

ADAT Lightpipe, the 8-channel digital audio protocol developed by Alesis, also contains audio clock and can be used as a speed reference. It is transmitted via optical cables between devices.

NOTE

Do not confuse the audio clock embedded in the Lightpipe protocol with ADAT Sync, which has timecode and machine control running over a proprietary DIN plug connection.

MIDI clock

MIDI clock is a signal that uses position and timing data based on musical bars and beats to determine location and speed (tempo). It can perform the same function as a positional reference and a speed reference for other MIDI devices. Cubase supports sending MIDI clock to external devices but cannot slave to incoming MIDI clock.

IMPORTANT

MIDI clock cannot be used to synchronize digital audio. It is only used for MIDI devices to play in musical sync with one another. Cubase does not support being a MIDI clock slave.

Project Synchronization Setup Dialog

The **Project Synchronization Setup** dialog provides a central place to configure a complex synchronized system. In addition to settings for timecode sources, basic transport controls are available for testing the system.

To open the **Project Synchronization Setup** dialog, do one of the following:

- Select **Transport > Project Synchronization Setup**.
- In the **Transport Bar**, **Ctrl/Cmd**-click **Sync**.

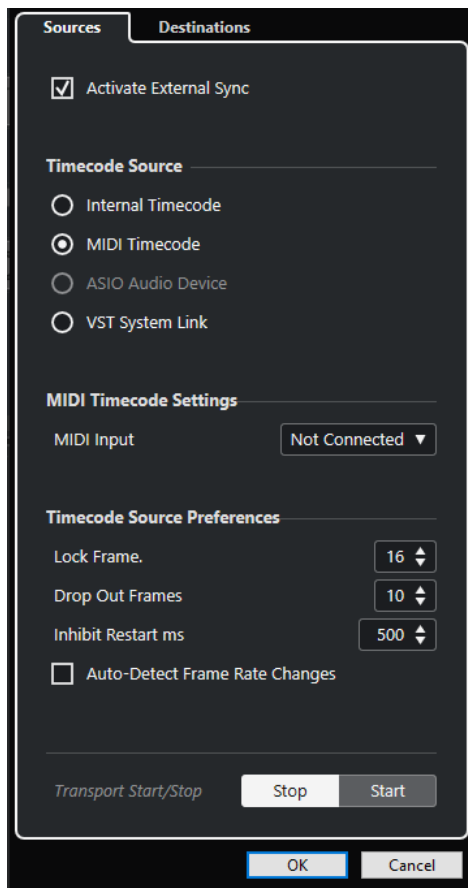

RELATED LINKS

[Sources Page](#) on page 775

[Destinations Page](#) on page 777

Sources Page

The **Sources** page allows you to set up the synchronization inputs, and to determine which external signals enter the application.

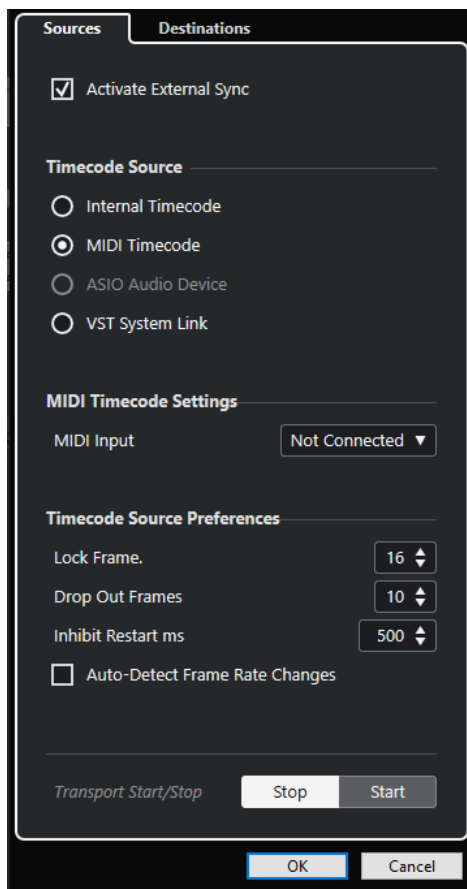

In the topmost section, the following options are available:

Activate External Sync

Activates/Deactivates the external synchronization.

Timecode Source

The **Timecode Source** section allows you to determine whether Cubase is acting as timecode master or slave. The following options are available:

Internal Timecode

Sets Cubase as timecode master that generates all position references for any other device in the system based on the project timeline and the **Project Setup** settings.

MIDI Timecode

If **Activate External Sync** is activated, this sets Cubase as timecode slave to any incoming MIDI timecode. You can select the **MIDI Input** ports in the **MIDI Timecode Settings** section.

ASIO Audio Device (Windows only)

Only available for audio cards that support the ASIO positioning protocol. These cards have an integrated LTC reader or ADAT sync port and can perform a phase alignment of timecode and audio clock.

VST System Link

Sets **VST System Link** as timecode source. This allows for all aspects of sample-accurate synchronization between different computers that are connected via **VST System Link**.

NOTE

Discrepancies between the **Project Frame Rate** and the incoming timecode can cause problems during postproduction, even if Cubase is able to lock to that timecode.

MIDI Timecode Settings

The **MIDI Timecode Settings** become available if you activate **MIDI Timecode** as a **Timecode Source**.

MIDI Input

Allows you to select the MIDI input ports. To allow Cubase to synchronize to MIDI timecode from any MIDI connection, select **All MIDI Inputs**.

Timecode Source Preferences

If you activate **MIDI Timecode** as a **Timecode Source**, you can set up **Timecode Source Preferences** for working with external timecode. The following options are available:

Lock Frames

Determines how many full frames of timecode it takes for Cubase to lock, that is, establish synchronization.

NOTE

If you have an external tape transport with a very short start-up time, set **Lock Frames** to a low value to make lock-up even faster.

Drop Out Frames

Sets the number of timecode frames that must be missed until Cubase stops. Using LTC on an analog tape machine can increase the number of drop outs.

Inhibit Restart ms

Some synchronizers still transmit MTC for a short period after an external tapemachine has been stopped. These extra frames of timecode sometimes cause Cubase to restart suddenly. **Inhibit Restart ms** allows you to control the amount of time in milliseconds that Cubase waits before restart (ignoring incoming MTC) once it has stopped.

Auto-Detect Frame Rate Changes

Notifies you about frame rate or timecode changes and interrupts playback or recording. Activate this if you want to diagnose problems with timecode and external devices.

Transport Start/Stop

Starts/Stops playback in Cubase.

RELATED LINKS

[Activating VST System Link](#) on page 784

[Project Setup Dialog](#) on page 88

Destinations Page

The **Destinations** page allows you to set up the synchronization outputs, and to determine which external signals leave the application.

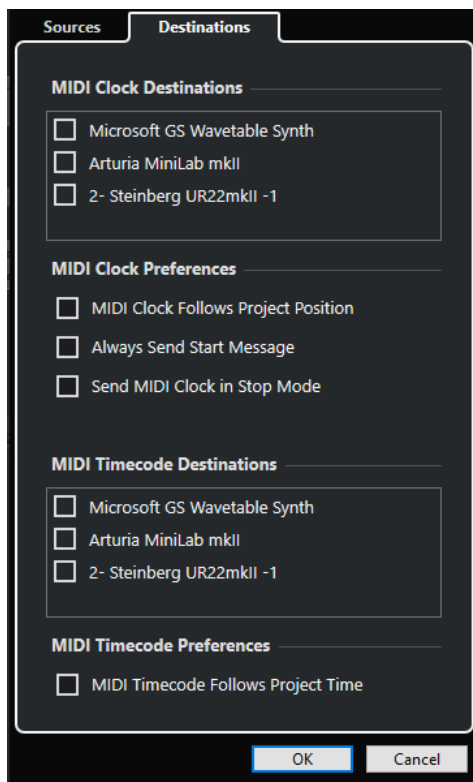

MIDI Clock Destinations

In the **MIDI Clock Destinations** section, you can select any MIDI ports that you want to output MIDI clock. Some MIDI devices, such as drum machines, can match their tempo and location to incoming MIDI clock.

MIDI Clock Preferences

In the **MIDI Clock Preferences** section, the following options are available:

MIDI Clock Follows Project Position

Ensures that the MIDI clock follows Cubase.

Always Send Start Message

MIDI clock transport commands include start, stop, and continue. Activate this if a MIDI device does not recognize the continue command.

Send MIDI Clock in Stop Mode

Activate this if a MIDI device needs MIDI clock to run continuously in order to operate arpeggiators and loop generators.

MIDI Timecode Destinations

In the **MIDI Timecode Destinations** section, you can specify the MIDI ports to which MTC is routed.

NOTE

Some MIDI interfaces send MTC over all ports by default. If this is the case, only select one port of the interface for the MTC.

MIDI Timecode Preferences

In the **MIDI Timecode Preferences** section, the following options are available:

MIDI Timecode Follows Project Time

Ensures that the MIDI output always follows the time position of Cubase.

External Synchronization

To activate external synchronization, do one of the following:

- Select **Transport > Activate External Sync**.
- Select **Transport > Project Synchronization Setup**, and on the **Sources** page, activate **Activate External Sync**.
- Cubase awaits incoming timecode from the chosen timecode source defined in the **Project Synchronization Setup** dialog in order to play.

Cubase will detect incoming timecode, locate to its current position, and start playback in sync with the incoming timecode.

VST System Link

VST System Link is a digital audio network system that allows you to link several computers using digital audio hardware and cables.

Linking up 2 or more computers allows you to split different tasks and different tracks between different computers. You can run CPU-intensive processes, such as send effect plug-ins or VST instruments on one computer, and record audio tracks on another one.

VST System Link supplies transport and sync control, as well as up to 16 MIDI ports, with 16 channels each.

With **VST System Link** the signal is passed from one machine to the next, and eventually returns to the first machine.

For this to work, you need 2 or more computers that use the same or different operating systems, and for each computer in the network, the following:

- Audio hardware with digital inputs and outputs and a specific ASIO driver.
The same digital formats and connection types.
- At least one digital audio cable, such as S/PDIF, ADAT, TDIF, or AES.
- A **VST System Link** host application.

NOTE

You might want to invest in a KVM (Keyboard, Video, Mouse) switchbox. This allows you to use the same keyboard, monitor, and mouse to control each computer in the system, and to switch between computers very rapidly.

Setting up VST System Link

To be able to work with **VST System Link**, you must first set up the network, configure the audio hardware, and set up the digital audio connections.

VST System Link Section

The **VST System Link** section allows you to set up **VST System Link**.

- To open the **VST System Link** section, select **Studio > Studio Setup** and select **VST System Link** in the **Devices** list.

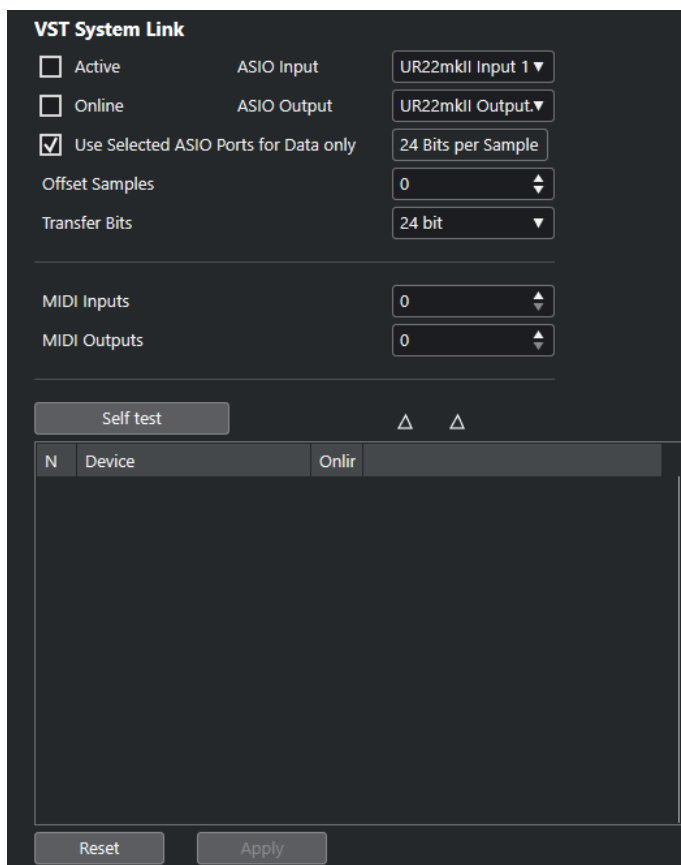

Active

Activates **VST System Link**.

Online

Puts the computer online.

ASIO Input

Allows you to define the networking input channel.

ASIO Output

Allows you to define the networking output channel.

Use Selected ASIO Ports for Data only

Activate this if you want to devote more bandwidth to MIDI, and send **VST System Link** information on the entire channel. This channel is then no longer available for audio transfer.

Offset Samples

Allows you to set an offset for the computer, so that it plays slightly ahead or behind the rest.

Transfer Bits

Allows you to specify whether you want to transfer 24 or 16 bits. This allows you to use older audio cards which do not support transfer of 24 bits.

MIDI Inputs

Allows you to set the number of MIDI input ports.

MIDI Outputs

Allows you to set the number of MIDI output ports.

Self test

Allows you to test the network.

Receiving

Lights up if the computer is active.

Sending

Lights up if the computer is active.

List

Shows the name of each computer.

Setting up a Network

You can set up a network by connecting computers.

PROCEDURE

1. Use a digital audio cable to connect the digital output of computer 1 to the digital input of computer 2.

If you have more than 2 computers, add the others one by one.

2. Use a cable to connect the digital output of computer 2 to the digital input of computer 1.

VST System Link is a daisy chain system, that means, that the output of computer 1 goes to the input of computer 2, the output of computer 2 goes to the input of computer 3, and so on around the chain. The output of the last computer in the chain must always go back into the input of computer 1, to complete the ring.

NOTE

If a card has more than one set of inputs and outputs, choose whichever one that suits you – for simplicity usually the first set is best.

Configuring the Audio Clock

To be able to use **VST System Link**, the clock signals on your ASIO cards must be synchronized correctly.

PREREQUISITE

For each computer in the network, the following must apply:

- The correct audio driver is selected in the **Studio Setup** dialog.
- The clock mode or sync mode is set up in the ASIO control panel of the audio hardware.

PROCEDURE

1. Select **Studio > Studio Setup**.
2. In the **Devices** list, select the your audio hardware.
3. Click **Control Panel**.
4. Set one audio hardware to be the clock master and all other cards to be clock slaves. Consult the documentation if required.

IMPORTANT

If you set up more than one card as clock master, the network cannot function correctly.

However, if you use an external clock from a digital mixing desk or a special word clock synchronizer, for example, you must leave all your ASIO cards in clock slave or **AutoSync** mode and make sure that each of them is listening for the signal coming from the synchronizer. This signal is usually passed through your ADAT cables or word clock connectors in a daisy chain fashion.

RESULT

Typically, the ASIO control panel for an audio card contains some indication of whether or not the card receives a proper sync signal, including the sample rate of that signal. This is a good indication that you have connected the cards and set up clock sync properly. Check the documentation of your audio hardware for details.

RELATED LINKS

[Selecting an Audio Driver](#) on page 15

[ASIO Driver Setup Page](#) on page 18

Adjusting the Buffer Size

In a **VST System Link** network, adjusting the buffer size to minimize latency is extra important. This is due to the fact that the latency of a **VST System Link** network is the total latency of all the ASIO cards in the system added together.

PROCEDURE

1. Select **Studio > Studio Setup**.
2. In the **Devices** list, select your audio hardware.
3. Click **Control Panel**.
4. Lower the size of the buffers.

The lower the buffer size, the lower the latency. It is best to keep to fairly low buffer sizes if your system can handle it. About 12 ms or less is usually a good idea.

IMPORTANT

Latency does not affect the synchronization, but it can affect the time it takes to send and receive MIDI and audio signals, or make the system seem sluggish.

Audio Hardware Settings that Affect VST System Link

Specific audio hardware settings might change the digital information in a way that the correct functioning of **VST System Link** is affected.

You can find these settings in the control panel or additional application for your audio hardware. Make sure that the following conditions are met:

- Any additional format settings for digital ports that you use for **VST System Link** data must be turned off.

If you use an S/PDIF connection for **VST System Link**, for example, turn off **Professional format, Emphasis, and Dithering**.

- Any mixer application of your audio hardware that allows for level adjustments of digital inputs and outputs must be disabled.

Alternatively, you can set the levels for the **VST System Link** channels to ± 0 dB.

- Digital signal processing, such as pan or effects, must be turned off for the **VST System Link** signal.
- For RME Audio Hammerfall DSP audio hardware, select the default or plain preset for the **Totalmix** function.
Otherwise signal loops might occur and **VST System Link** cannot work.

Setting up Sample Rates

All projects on all computer must be set up to the same sample rate.

PROCEDURE

1. Select **Project > Project Setup**.
 2. In the **Project Time Displays** section, open the **Sample Rate** pop-up menu and select a sample rate.
-

Setting up Digital Audio Connections

PROCEDURE

1. Select **Studio > Audio Connections**.
 2. Click the **Inputs** tab, and click **Add Bus**.
 3. In the **Add Input Bus** dialog, configure the bus.
 4. Click **Add Bus**.
 5. Click the **Outputs** tab, and click **Add Bus**.
 6. In the **Add Output Bus** dialog, configure the bus.
 7. Click **Add Bus**.
 8. Repeat these steps for all applications.
Set up the same configuration in all applications. If you have 4 stereo output busses on computer 1, you want 4 stereo input busses on computer 2, etc.
 9. Route the applications to the digital inputs and outputs.
-

RELATED LINKS

[Audio Bus Setup](#) on page 22

[Audio Connections Window](#) on page 28

Verifying the Digital Connection

PROCEDURE

1. Connect an audio source to your audio interface.
2. Start recording, playing back, and mixing.
3. On computer 1, play back some audio.
4. Select **Studio > MixConsole**, and route the channel that contains the audio material to one of the digital output busses.
5. On computer 2, select **Studio > MixConsole**, and locate the corresponding digital input bus.

The audio that is played back should now appear in the application running on computer 2, and the input bus level meters should move.

RESULT

You have now verified that the digital connection works as it should. You can reverse this procedure so that computer 2 plays back and computer 1 listens.

Activating VST System Link

You must activate **VST System Link** on all network computers to be able to work with **VST System Link**.

PROCEDURE

1. Select **Transport > Project Synchronization Setup**, and on the **Sources** tab, activate **VST System Link** as the timecode source.
2. Select **Studio > Studio Setup**.
3. In the **Devices** list, select **VST System Link**.

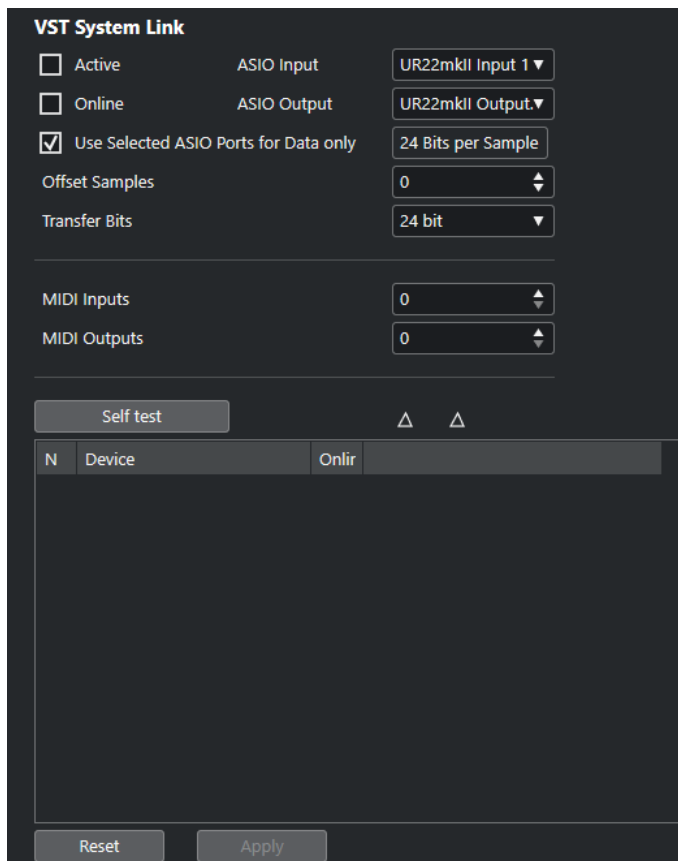

4. Use the **ASIO Input** and **ASIO Output** pop-up menus to define which channel is the networking channel that carries the **VST System Link** information.

NOTE

The networking signal is carried on only one bit of one channel. For an ADAT-based system 7 channels of 24-bit audio and 1 channel of 23-bit audio will be used for networking. You will still have around 138 dB headroom on this channel.

5. Activate **Active** at the top left of the **VST System Link** setup.
 6. Repeat the steps for each computer in the network.
-

RESULT

The sending and receiving indicators on each active computer flash, and the name of each computer appears in the list in the **Self test** section of the dialog. Each computer is assigned a random number.

The name will be shown in the **VST System Link** window of every computer on the network. You can double-click the name of the computer and enter another name.

NOTE

If you do not see the name of each computer, go through the procedure above again and make sure that all ASIO cards are listening to the digital clock signals correctly, and that each computer has the correct inputs and outputs assigned to the **VST System Link** network.

RELATED LINKS

[Sources Page](#) on page 775

Putting Network Computers Online

You must put the network computers online so that they can send and receive transport and timecode signals, and that their sequencer applications can be started and stopped.

PREREQUISITE

All computers have their tempos set to the same value.

PROCEDURE

1. Select **Studio > Studio Setup**.
 2. In the **Devices** list, select **VST System Link**.
 3. Activate **Online**.
 4. Repeat this for each computer in the network.
-

RESULT

The computers are online now.

AFTER COMPLETING THIS TASK

Start playback on one computer to check if the system is working, and if all computers start and play perfectly in time.

VST System Link sends and understands all transport commands. This allows you to control the entire network from one computer. However, any computer can control any and all of the others. This is due to the fact that **VST System Link** is a peer-to-peer network, and that there is no absolute master computer.

Activating MIDI Ports for VST System Link

You can activate MIDI input and output ports for **VST System Link**. This allows you to route MIDI tracks to VST instruments running on another computer.

PROCEDURE

1. Select **Studio > Studio Setup**.
 2. In the **Devices** list, select **VST System Link**.
 3. Specify the number of MIDI ports you need using the **MIDI Inputs** and **MIDI Outputs** value fields.
 4. Create a MIDI track.
-

RESULT

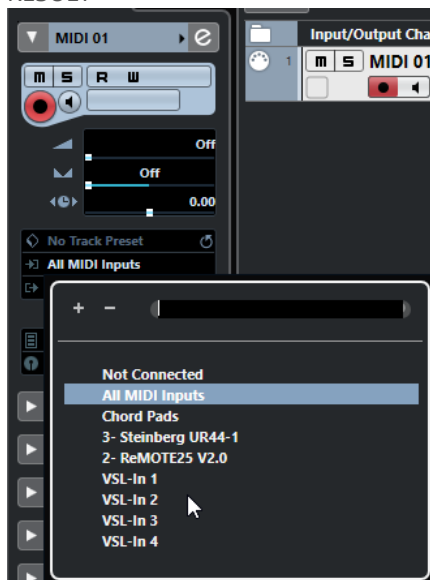

In the top section of the MIDI track **Inspector**, the **Input Routing** and **Output Routing** pop-up menu now show the specified **VST System Link** ports.

This allows you to route MIDI tracks to VST instruments running on another computer.

Application Examples

VST System Link allows you to split different tasks between 2 or more computers. The following application examples should give you an idea of what is possible.

Configuring a Main Mix Computer

Configuring one computer as a main mix computer that receives the audio from your other computers allows you to mix internally in the computer.

In the following example, we assume you are using 2 computers: computer 1 as your main mix computer and computer 2 for 2 additional stereo audio tracks, an FX channel track with a reverb plug-in and a VST instrument plug-in with stereo outputs.

PROCEDURE

1. On computer 1, use an unused set of outputs, such as an analog stereo output, connected to your monitoring equipment to listen to the audio playback.

2. On computer 2, route each of the 2 audio tracks to a separate output bus connected to the digital outputs, bus 1 and 2, for example.
 3. Route the FX channel track to another **VST System Link** bus, bus 3, for example.
 4. Route the VST instrument channel to yet another bus, bus 4, for example.
 5. On computer 1, check the corresponding 4 **VST System Link** input busses.
If you start playback on computer 2, the audio should appear on the input busses on computer 1. However, to mix these audio sources you need actual mixer channels.
 6. Add 4 new stereo audio tracks on computer 1 and route these to the output bus you use for listening, such as the analog stereo outputs.
 7. For each of the audio tracks, select one of the 4 input busses.
Now, each computer 2 bus is routed to a separate audio channel on computer 1.
 8. Activate monitoring for the 4 tracks.
-

RESULT

If you now start playback, the audio from computer 2 will be sent live to the new tracks on computer 1, allowing you to hear them together with any tracks you play back on computer 1.

AFTER COMPLETING THIS TASK

If you notice a processing delay while you listen to signals coming from your other computers while monitoring, try the following to compensate for latency issues:

- If your audio hardware supports this, activate **ASIO Direct Monitoring** on the **Audio System** device panel for your hardware.
- Alternatively, open the **Studio Setup** dialog, and on the **VST System Link** page, change the **Offset Samples** value.

Configuring a Computer as Submixer

If you have more audio tracks than you have **VST System Link** busses, you can use a computer mixer as a submixer.

PROCEDURE

- Route several audio channels to the same output bus and adjust the output bus level if needed.

NOTE

If your audio cards have multiple sets of input and output connections, you can link up multiple ADAT cables and send audio via any of the busses on any of the cables.

Routing MIDI Tracks to VSTis on Other Computers

You can route MIDI tracks from one computer to VST instruments on another computer. This allows you to use one computer for playback and recording and the other one as a VSTi rack.

PROCEDURE

1. Record a MIDI track into computer 1.
2. Once you have finished recording, route the MIDI output of that track to **VST System Link** MIDI port 1.

3. On computer 2, open the **VST Instruments** window and assign an instrument to the first slot in the rack.
 4. Route the VST instrument channel to the desired output bus.
If you are using computer 1 as your main mixing computer, this would be one of the **VST System Link** output busses, connected to computer 1.
 5. Create a new MIDI track in the **Project** window of computer 2 and assign the MIDI output of the track to the VST instrument you created.
 6. Assign the MIDI input of the track to be **VST System Link** port 1.
Now, the MIDI track on computer 1 is routed to the MIDI track on computer 2, which in turn is routed to the VST instrument.
 7. Now activate monitoring for the MIDI track on computer 2, so that it will listen and respond to any MIDI commands coming in.
In Cubase, click the **Monitor** button in the track list or **Inspector**.
 8. Start playback on computer 1.
It will now send the MIDI information on the track to the VST instrument loaded on computer 2.
-

RESULT

Even with a slow computer you should be able to stack many extra VST instruments this way, expanding your sound palette considerably. **VST System Link** MIDI is also sample-accurate, and thus has much tighter timing than other hardware MIDI interface.

Routing Audio Sends to Other Computers

The effect sends for an audio channel in Cubase can either be routed to an FX channel track or to any activated group or output bus. This allows you to use a separate computer as a virtual effect rack.

PROCEDURE

1. On computer 2, the machine you will use as effect rack, add a new stereo audio track.
 2. Add the desired effect as an insert effect for the track.
 3. In the **Inspector**, select one of the **VST System Link** busses as input for the audio track.
 4. Route the channel to one of the **VST System Link** output busses connected to computer 1.
 5. Activate monitoring for the track.
 6. Go back to computer 1 and select a track to which you want to add some reverb.
 7. Open the **Sends** rack for the track in the **Inspector** or the **MixConsole**.
 8. Open the **Send Routing** pop-up menu for one of the sends and select the **VST System Link** bus assigned to the effect.
 9. Use the **Send** slider to adjust the amount of effect as usual.
-

RESULT

The signal will be sent to the track on computer 2 and processed through its insert effect, without using any processor power on computer 1.

You can repeat the steps above to add more effects to the virtual effect rack. The number of effects available this way is only limited by the number of ports used in the **VST System Link** connection, and by the performance of computer 2.

Recording Tracks on Other Computers

You can record tracks on another computer. This is useful if the hard drive on one computer is not fast enough to run as many audio tracks as you need.

PROCEDURE

- Add tracks on another computer and record on them.

RESULT

This creates a virtual RAID system, with several disks all operating together. All tracks will remain locked together just as tightly as if they were all running on the same machine.

Playing Back Video on Other Computers

You can play back video on another computer to free up resources for audio and MIDI processing on your main CPU. This is useful as playback of high-resolution video can be quite demanding on the CPU.

PROCEDURE

- Move video tracks to another computer.

RESULT

Since all transport commands respond on the **VST System Link** computers, scrubbing video is possible even when it is coming from another computer.

When scrubbing, the playback on the linked systems may not be perfectly in sync. Also, there are some further restrictions when scrubbing via **VST System Link**:

- Always use the system where you started scrubbing to control the scrubbing.
Changing the scrub speed on a remote system will only change the speed on the local system.
- You can start playback on all systems.
This stops scrubbing and enters playback on all systems in sync.

Video

Cubase allows you to work with video content.

You can play back video files in various formats and via different output devices from within Cubase, extract the audio material from a video file, and edit your music to the video.

The video export function allows you to share your videos with clients or other users.

IMPORTANT

Videos are exported with a resolution of 1920 x 1080 px (Full HD). Video files with a lower or higher resolution than Full HD are upscaled or downscaled on export.

RELATED LINKS

[Video File Compatibility](#) on page 790

[Importing Video Files](#) on page 792

[Preparations for Video Playback](#) on page 794

[Export Video](#) on page 797

[Extracting Audio from Video](#) on page 800

Video File Compatibility

When working on a project involving a video file, you must make sure that the video file type works on your Cubase system.

NOTE

If you are not able to play back a specific video file, use an external application to convert the file into a compatible format.

To find out which video files are supported, refer to the support area at steinberg.net.

RELATED LINKS

[Codecs](#) on page 791

Video Container Formats

Video and other multimedia files come in a container format.

This container holds various streams of information including video and audio, but also metadata such as synchronization information required to play back audio and video together. Data regarding creation dates, authors, chapter markings, and more can also be held within the container format.

The following container formats are supported by Cubase:

MOV

This is a QuickTime movie.

MPEG-4

This format can contain various metadata for streaming, editing, local playback, and interchange of content. Its file extension is .mp4.

AVI

This is a multimedia container format introduced by Microsoft.

Codecs

Codecs are methods of data compression used to make video and audio files smaller and more manageable for computers.

For further details, refer to the support area at steinberg.net.

Frame Rates

Cubase supports different video and film frame rates.

Frame rate (speed)

Regardless of the frame counting system, the actual speed at which frames of video go by in real time is the true frame rate.

Cubase supports the following frame rates:

24 fps

This is the true speed of standard film cameras.

25 fps

This is the frame rate of PAL video.

29.97 fps/29.97 dfps

This is the frame rate of NTSC video. The count can be either non-drop or drop-frame.

30 fps/30 dfps

This frame rate is not a video standard anymore but has been commonly used in music recording. Many years ago, it was the black and white NTSC broadcast standard. It is equal to NTSC video being pulled up to film speed after a 2-3 telecine transfer. The count can be either non-drop or drop-frame.

IMPORTANT

Video formats with a variable frame rate (VFR) are not supported.

Video Output Devices

Cubase supports several video output devices.

Viewing video files onscreen in the **Video Player** window may work just fine for many applications, but often it is necessary to display video in a large format for viewing small details and so others involved in the session can also see the video. Cubase provides the ability to use several types of video output devices to accomplish this.

Dedicated Video Cards

You can use a dedicated video card. Video is sent directly to the output of this video device.

The following video cards are supported:

- Blackmagic Design video output devices

IMPORTANT

- You must install the appropriate driver for the video device and set the video card output to the video file resolution used in your project.
 - Video output via FireWire is not supported.
-

RELATED LINKS

[Video Player Page](#) on page 794

Preparations for Creating Video Projects

Before you can start working with video in Cubase, some basic preparations must be made.

In Cubase, you may work with multiple video files of different formats on the same video track.

NOTE

For proper synchronization of audio and video events, make sure that the project frame rate matches the frame rate of the video file.

RELATED LINKS

[Project Setup Dialog](#) on page 88

Importing Video Files

If you have a compatible video file, you can import it into your project.

PROCEDURE

1. Select **File > Import > Video File**.
 2. In the **Import Video** dialog, select the video file that you want to import.
 3. Optional: Activate **Extract Audio from Video** to import any embedded audio streams.
 4. Click **Open**.
-

RESULT

Cubase creates a video track with a video event. If **Extract Audio from Video** was activated, an audio track with an audio event is positioned below the video track. The corresponding audio clip is saved in the **Pool Record** folder.

NOTE

You can also import video files by dragging them from the **MediaBay**, the File Explorer/macOS Finder and dropping them in your project. If you want Cubase to automatically extract the audio, activate **Extract Audio on Import Video File** in the **Preferences** dialog (**Video** page).

RELATED LINKS

[Pool](#) on page 446

[Extracting Audio from Video](#) on page 800

Adopting the Project Frame Rate

To ensure that the time display of Cubase corresponds to the actual frames in the video, you must set the project frame rate to the frame rate of the imported video file.

PREREQUISITE

The frame rate of the imported video file differs from the project frame rate.

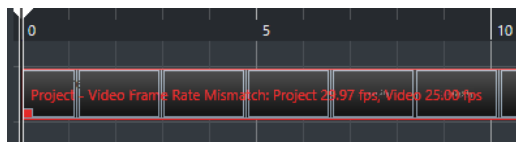

PROCEDURE

1. Select **Project > Project Setup**.
2. In the **Project Setup** dialog, click **Get Frame Rate from Video**.
3. Click **OK**.

RESULT

- If Cubase supports the frame rate of the video, the project frame rate is adopted to it. If needed, the project start time is automatically adjusted to reflect the change in frame rate. For example, if the project frame rate is switched from 30 fps to 29.97 fps, the project start time is adopted so that all the events in the project remain at the same positions in relation to real time.

NOTE

If you want the project start time to remain the same, you must manually change it back. In this case, you must snap the video event to the timeline to ensure proper positioning and synchronization within the project.

Thumbnail Cache Files

For every imported video file, Cubase automatically creates a thumbnail cache file.

RELATED LINKS

[Manually Generating Thumbnail Cache Files](#) on page 793

Manually Generating Thumbnail Cache Files

You can manually generate thumbnail cache files. This is necessary if a thumbnail cache file could not be generated during import because the folder is write-protected, or because you have edited the file with an external video editing application.

PROCEDURE

- Do one of the following:
 - In the **Pool**, right-click the video file and select **Generate Thumbnail Cache**.

- In the **Project** window, select the video event and select **Media > Generate Thumbnail Cache**.

NOTE

You can only refresh already existing thumbnail cache files from within the **Pool**.

RESULT

The thumbnail cache file is generated in the background so that you can continue working with Cubase.

Preparations for Video Playback

You can play back imported video files from within Cubase by using the transport controls.

For this to work, you must activate and set up a video output device.

IMPORTANT

Your graphics card must support OpenGL 2.0 or higher.

Video Player Page

The **Video Player** setup page in the **Studio Setup** dialog allows you to set up your video player, and to check if your video equipment allows for video playback from within Cubase.

- To open the **Video Player** page, select **Studio > Studio Setup** and activate **Video Player** in the **Devices** list.

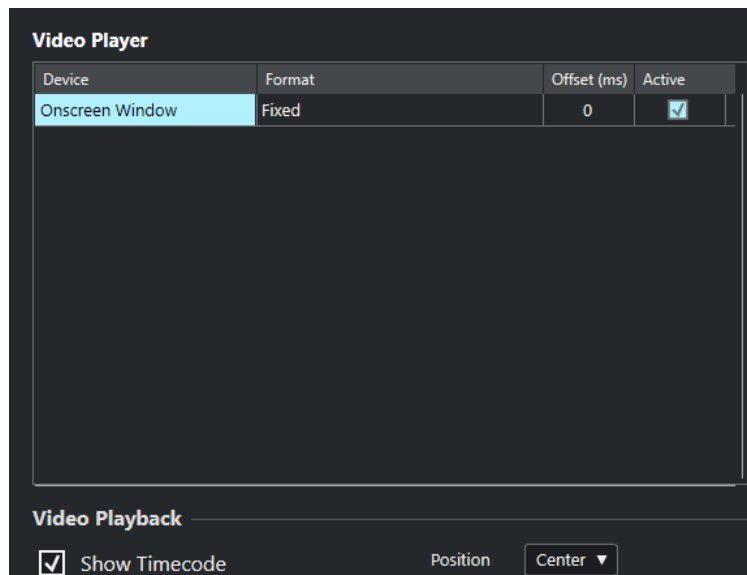

The following options are displayed:

Device

Lists the video output devices that are available on your system.

Format

Allows you to select an output format.

NOTE

The **Onscreen Window** device only supports a fixed format.

Offset

If the video image does not match the audio, you can enter an offset value in milliseconds to specify how much earlier the video should be delivered. This compensates for the display delay. The offset is only used during playback. It is saved globally for each output device and is independent of the project.

Active

Allows you to activate the device that you want to use for playing back video.

Show Timecode

Allows you to show the timecode.

Position

Allows you to determine the position for the timecode display.

Activating a Video Output Device

PROCEDURE

1. Select **Studio > Studio Setup**.
2. In the **Devices** list, activate **Video Player**.
The available video output devices are listed in the **Device** column.
3. In the **Active** column, activate the checkbox for the device that you want to use for playing back video.

NOTE

If you have no external device connected, you can use the **Onscreen Window** device that allows you to play back the video file on your computer monitor.

RELATED LINKS

[Video Output Devices](#) on page 791

Video Player Window

The **Video Player** window provides different size options for video playback on your computer screen. However, the larger the size of the window and the higher the resolution of your video, the more processor load is needed.

- To open the **Video Player** window, select **Studio > Video Player**.



Fullscreen Mode

Sets the window to full screen mode. To exit full screen mode, open the context menu and select **Exit Fullscreen Mode** or press **Esc**.

Quarter Size

Reduces the window to a quarter of the actual size.

Half Size

Reduces the window to half the actual size.

Actual Size

Sets the window to the size of the video.

Double Size

Enlarges the window to twice the actual size.

Aspect Ratio

You can also drag the borders of the **Video Player** window to resize it. However, this might lead to a distorted image. To prevent this, you can set an option from the **Aspect Ratio** pop-up menu.

- If you select **None**, the aspect ratio of the video is not kept when you resize the window. The image is enlarged/reduced to occupy the whole Video Player window.
- **Internal** allows you to resize the window freely while keeping the aspect ratio of the video. Borders might be displayed around the video image to fill the window.
- **External** allows you to resize the window within some limits so that the video image always fills the full window and its aspect ratio is kept.

- **NOTE**

In full screen mode, the aspect ratio of the video is always kept.

Scrubbing Video

You can scrub video events, that is, play them back forwards or backwards.

PROCEDURE

1. Select **Studio > Video Player**.
 2. Do one of the following:
 - Click in the **Video Player** window and move the mouse to the left or to the right.
 - Use a jog wheel on a remote controller.
-

Editing Video

Video events are created automatically when you import a video file.

When working with video events, the following applies:

- You can view and edit video events in the **Project** window. A video event triggers the playback of the corresponding video clip.
- You can copy and trim video events.
- You cannot draw, glue, and mute video events, or apply fades or crossfades.

Export Video

You can export a video file from your project. This allows you, for example, to share sections of intermediate results or finished videos with clients or other users.

The **Export Video** function exports the video and a stereo audio signal that are enclosed between the left and right locators. This allows you to export a specific range or your whole project by setting the locators accordingly.

Videos are exported in the following format:

- Container format: MP4
- Video compression codec: H.264 without long group of pictures (Long GOP) sequences
- Resolution: 1920 x 1080 px (Full HD)

IMPORTANT

Video with a lower or higher resolution than Full HD is upscaled or downscaled on export.

- Frame rate: Same as the project frame rate
- Audio compression codec: AAC
- Sample rate: Same as the project sample rate

IMPORTANT

Video export supports sample rates of 44.1 kHz and 48 kHz only.

- Bit depth: 16 bit

You can only add a stereo output channel to the exported video file. We recommend that you route all mono, stereo, or multi-channel channels that you want to export to a stereo output channel via send, and select this output channel in the **Export Video** dialog.

RELATED LINKS

- [Export Video Dialog](#) on page 798
- [Exporting Video Files](#) on page 799

Export Video Dialog

The **Export Video** dialog provides settings for exporting a video file from your project.

- To open the **Export Video** dialog, select **File > Export > Video**.

The **Export Video** dialog is divided into several sections.

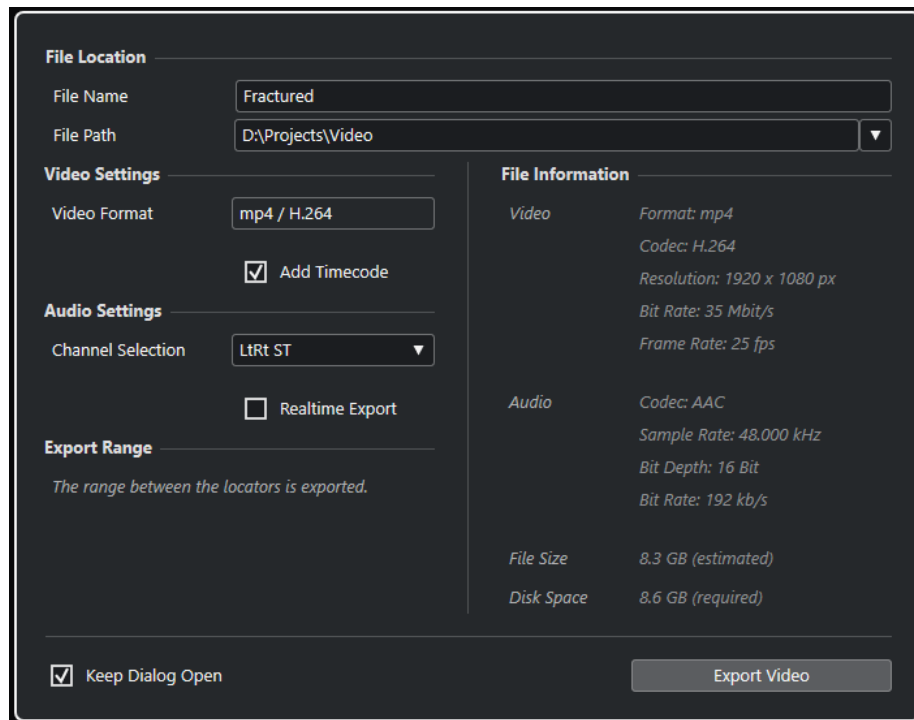

File Location

File Name

Allows you to specify the name of the exported video file.

File Path

Allows you to specify the file path of the exported video file.

Click **Path Options** to open a pop-up menu with file path options:

- Choose** opens the File Explorer/macOS Finder allowing you to browse for a file location.
- Recent Paths** allows you to select a recently selected file locations.
- Clear Recent Paths** allows you to delete all recently selected file locations.

Video Settings

Video Format

Shows the format of the exported video file.

Add Timecode

Adds the project timecode to the exported video file.

Audio Settings

Channel Selection

Allows you to select a stereo output channel for export. **MixConsole** settings and insert effects are taken into account.

Realtime Export

Allows you to export the audio mixdown in real time. Realtime export takes at least the same time as regular playback. Activate this if you use external effects or instruments, or if you use VST plug-ins that require time to update correctly during the mixdown. For further information, refer to the documentation of the respective plug-ins.

NOTE

- If you export external effects or instruments in real time, you must also activate **Monitor** for the respective audio channels.
 - **Realtime Export** affects only the audio export. Video is processed as usual.
-

Export Range

This section provides information about the exported locator range.

File Information

This section provides detailed information about the exported video file.

General Options

In the bottom section, the following options are available:

Keep Dialog Open

Activate this to keep the dialog open after clicking **Export Video**.

Export Video

Allows you to export your video as specified.

RELATED LINKS

[Export Video](#) on page 797

Exporting Video Files

You can export a video including a stereo audio signal of your whole project or of a specific range as an MP4 video file.

PREREQUISITE

- Your project sample rate is set to 44.1 kHz or 48 kHz.
- If you want to export external audio signals, you have activated **Monitor** for the corresponding channel.

PROCEDURE

1. Set up the left and right locators to encompass the section that you want to export.
2. Set up the audio in your project so that it plays back the way you want.

NOTE

You can only add a stereo output channel to the exported video file. We recommend that you route all mono, stereo, or multi-channel channels that you want to export to a stereo output channel via send.

3. Select **File > Export > Video**.
4. In the **Export Video** dialog, select the stereo output channel that you want to export.

NOTE

Make sure that the selected output channel contains all audio that you want to use for the exported file. For example, solo the channels that you want to export, or mute the channels that you do not want to export.

5. Make any further export settings.
 6. Click **Export Video**.
-

RESULT

The video file is exported.

RELATED LINKS

[Export Video Dialog](#) on page 798

Extracting Audio from Video

You can extract the audio stream of a video file on import.

PROCEDURE

1. Do one of the following:
 - Select **File > Import > Audio from Video File**.
This creates an audio clip in the **Pool**, but does not add any events to the **Project** window.
 - Select **Media > Extract Audio from Video File**.
 2. In the dialog, select the video file, and click **Open**.
 3. In the **Import Options** dialog, select the desired import options.
-

RESULT

The extracted audio stream is added to the project on a new audio track and can be edited like all other audio material.

RELATED LINKS

[Pool](#) on page 446

[On Import Audio Files Settings](#) on page 232

[Importing Video Files](#) on page 792

Key Commands

Key commands are assigned to most main menus and functions in Cubase. They are stored as **Preferences** that are used for all your projects.

You can view and add key commands in the **Key Commands** dialog. Key command assignments are also shown in the tooltips.



Tooltips that show an exclamation mark at the end have no key command assigned yet.

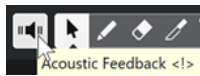

You can save key commands settings as a key commands file, which is stored separately and can be imported into any project. This way you can quickly and easily recall customized settings when moving projects between different computers, for example. The settings are saved in an XML file on the hard disk.

RELATED LINKS

[Saving Key Commands Presets](#) on page 804

Key Commands Dialog

The **Key Commands** dialog allows you to view and edit key commands for the main menus and functions in Cubase.

- To open the **Key Commands** dialog, select **Edit > Key Commands**.

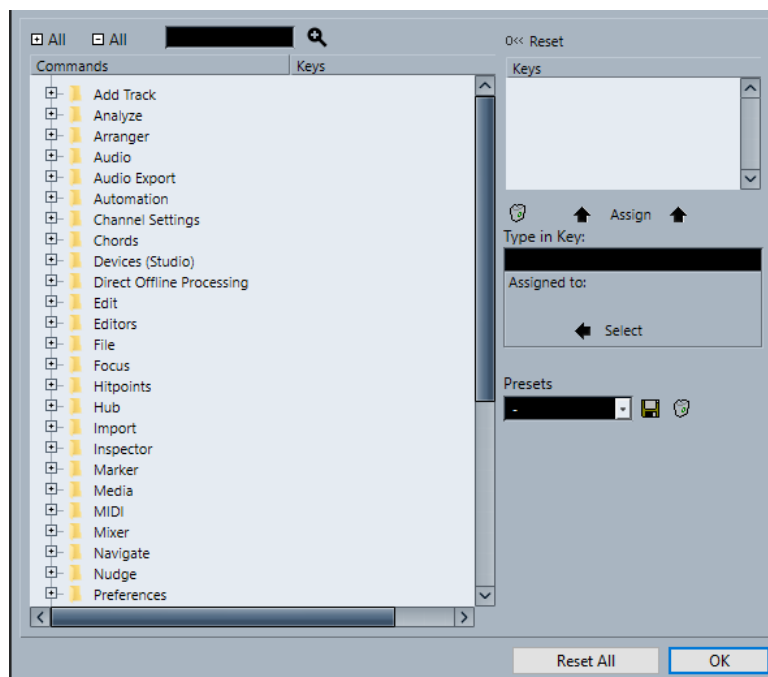

The following options are available:

+ All

Expands all folders.

- All

Reduces all folders.

Search

Allows you to search for Cubase functions. This is useful if you want to know which key command is assigned to a specific function.

Reset Current Key Command

Allows you to reset the selected key command back to the default setting.

Commands list

Shows the Cubase functions for that you can assign key commands arranged in category folders.

Keys

This is where the assigned key command is shown for the function that is selected in the **Commands** list.

Delete Selected Key Command

Removes the key command assignment from the function that is selected in the **Commands** list.

Assign Key

Assigns the key from the **Type in Key** value field to the function that is selected in the **Commands** list.

Type in Key

This is where you can enter a key that is assigned to a function that is selected in the **Commands** list.

Assigned to:

Shows the function that the key in the **Type in Key** value field is assigned to. Click the **Select** button, to select this function in the **Commands** list.

Select Preset

Opens a menu with the stored key commands presets.

Store

Opens a dialog that allows you to store a key commands preset.

Delete

Deletes the selected key commands preset.

Reset All

Resets all key commands to their default settings.

RELATED LINKS

[Assigning Key Commands](#) on page 803

[Searching for Key Commands](#) on page 803

[Resetting Key Commands](#) on page 804

[Removing Key Commands](#) on page 804

[Loading Key Command Presets](#) on page 804

[Saving Key Commands Presets](#) on page 804

Assigning Key Commands

You can add key commands in the **Key Commands** dialog.

PROCEDURE

1. Select **Edit > Key Commands**.
2. Do one of the following:
 - In the **Commands** list, click the plus sign to open a category folder, and select the function to which you want to assign a key command.
 - In the search field, enter the name of the function to which you want to assign a key command.

Assigned key commands are shown in the **Keys** column as well as in the **Keys** list to the right.

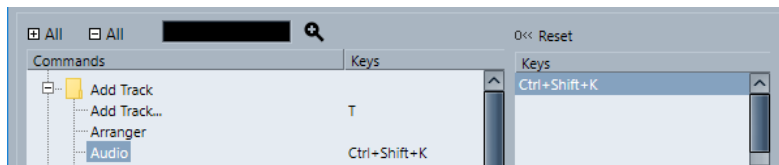

3. Click the **Type in Key** field and press the keys you want to use as a key command.
You can press individual keys or a combination of one or several modifier keys (**Ctrl/Cmd**, **Alt/Opt**, **Shift**) plus any key.
4. Click **Assign**.
The key command is shown in the **Keys** section.
5. Click **OK**.

NOTE

You can set up several different key commands for the same function. Adding a key command to a function that already has another key command does not replace the key command previously defined for the function.

Searching for Key Commands

You can search for Cubase functions in the **Key Commands** dialog. This is useful if you want to know which key command is assigned to a specific function.

PROCEDURE

1. Select **Edit > Key Commands**.
2. In the search field, enter the name of the function for which you want to know the key command.
3. Click **Start/Continue Search**.

RESULT

The first matching command is selected and displayed in the **Commands** list. The **Keys** column and the **Keys** list show the assigned key commands, if any.

Removing Key Commands

PROCEDURE

1. Select **Edit > Key Commands**.
 2. In the **Commands** list, click the plus sign to open a category folder, and select the function for which you want to remove a key command.
 3. Select the key command in the **Keys** list and click **Delete selected key command**.
 4. Click **Remove** to remove the selected key command.
 5. Click **OK**.
-

Saving Key Commands Presets

You can save key commands settings as presets.

PREREQUISITE

You have set up the key commands to your liking.

PROCEDURE

1. In the **Presets** section, click **Save**.
 2. Enter a name for the preset and click **OK**.
-

RESULT

Your key commands settings are now available as a preset on the **Presets** pop-up menu.

Loading Key Command Presets

You can load key commands presets.

PROCEDURE

- In the **Presets** section, open the pop-up menu and select the preset.
-

RESULT

The key command preset replaces the current key command settings and macros.

Resetting Key Commands

PROCEDURE

1. Select **Edit > Key Commands**.
2. Do one of the following:
 - In the **Commands** list, select the key command that you want to restore and click **Reset**.

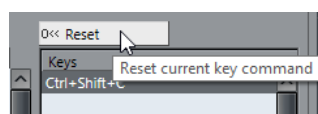

- Click **Reset All**.

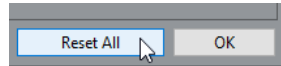

RESULT

The key commands are reset.

IMPORTANT

Any changes made to the default key commands are lost. If you want to be able to revert to these settings again, make sure to save them first.

Default Key Commands

The default key commands are arranged in categories.

NOTE

When the **On-Screen Keyboard** is displayed, the usual key commands are blocked because they are reserved for the **On-Screen Keyboard**. The only exceptions are: **Ctrl/Cmd - S** (Save), **Num *** (Start/Stop Record), **Space** (Start/Stop Playback), **Num 1** (Jump to Left Locator), **Delete** or **Backspace** (Delete), **Num /** (Cycle on/off), **F2** (Show/Hide Transport panel), and **Alt/Opt - K** (Show/Hide On-Screen Keyboard).

Add Track Category

Option	Key command
Add Track	T

Audio Category

Option	Key command
Adjust Fades to Range	A
Crossfade	X

Automation Category

Option	Key command
Read Automation for All Tracks On/Off	Alt/Opt - R
Write Automation for All Tracks On/Off	Alt/Opt - W

Chords Category

Option	Key command
Show/Hide Chord Pads	Ctrl/Cmd - Shift - C

Devices (Studio) Category

Option	Key command
Audio Connections	F4
Audio Performance	F12
MixConsole	F3
MixConsole in Project Window	Alt/Opt - F3
On-Screen Keyboard	Alt/Opt - K
Video Player	F8
VST Instruments	F11

Direct Offline Processing Category

Option	Key command
Direct Offline Processing	F7

Edit Category

Option	Key command
Activate/Deactivate Focused Object	Alt/Opt - A
Auto-Scroll On/Off	F
Copy	Ctrl/Cmd - C
Cut	Ctrl/Cmd - X
Cut Time	Ctrl/Cmd - Shift - X

Option	Key command
Delete	Delete or Backspace
Delete Time	Shift - Backspace
Duplicate	Ctrl/Cmd - D
Expand/Reduce	Alt/Opt - E
Insert Silence	Ctrl/Cmd - Shift - E
Invert	Alt/Opt - F
Invert Selection	Ctrl/Cmd - Alt/Opt - I
Left Selection Side to Cursor	E
Move Event Starts to Cursor	Ctrl/Cmd - L
Move Events to Front	U
Mute	M
Mute Events	Shift - M
Mute/Unmute Objects	Alt/Opt - M
Open	Ctrl/Cmd - E
Paste	Ctrl/Cmd - V
Paste at Origin	Alt/Opt - V
Paste Relative to Cursor	Shift - V
Paste Time	Ctrl/Cmd - Shift - V
Primary Parameter: Decrease	Ctrl/Cmd - Shift - Down Arrow
Primary Parameter: Increase	Ctrl/Cmd - Shift - Up Arrow
Record Enable	R
Redo	Ctrl/Cmd - Shift - Z
Repeat	Ctrl/Cmd - K
Right Selection Side to Cursor	D

Option	Key command
Secondary Parameter: Decrease	Ctrl/Cmd - Shift - Left Arrow
Secondary Parameter: Increase	Ctrl/Cmd - Shift - Right Arrow
Select All	Ctrl/Cmd - A
Select None	Ctrl/Cmd - Shift - A
Snap On/Off	J
Solo	S
Split At Cursor	Alt/Opt - X
Split Range	Shift - X
Stationary Cursor	Alt/Opt - C
Undo	Ctrl/Cmd - Z
Unmute Events	Shift - U
Write	W

Editors Category

Option	Key command
Open Score Editor	Ctrl/Cmd - R
Open/Close Editor	Return

File Category

Option	Key command
Close	Ctrl/Cmd - W
New	Ctrl/Cmd - N
Open	Ctrl/Cmd - O
Quit	Ctrl/Cmd - Q
Save	Ctrl/Cmd - S

Option	Key command
Save As	Ctrl/Cmd - Shift - S
Save New Version	Ctrl/Cmd - Alt/Opt - S

Media Category

Option	Key command
Open MediaBay	F5
Open/Close Favorites	Ctrl - Alt/Opt - Num 8
Open/Close File Browser	Ctrl - Alt/Opt - Num 4
Open/Close Filters	Ctrl - Alt/Opt - Num 5
Open/Close Previewer	Ctrl - Alt/Opt - Num 2
Preview Cycle On/Off	Shift - Num /
Preview Start	Shift - Enter
Preview Stop	Shift - Num 0
Search MediaBay	Shift - F5

MIDI Category

Option	Key command
Show/Hide Controller Lanes	Alt/Opt - L

Navigate Category

Option	Key command
Add Down: Expand/Undo selection in the Project window to the bottom/Move selected event in the Key Editor down 1 octave	Shift - Down Arrow

Option	Key command
Add Left: Expand/Undo selection in the Project window/Key Editor to the left	Shift - Left Arrow
Add Right: Expand/Undo selection in the Project window/Key Editor to the right	Shift - Right Arrow
Add Up: Expand/Undo selection in the Project window to the top/Move selected event in the Key Editor up one octave	Shift - Up Arrow
Bottom: Select bottom track in the track list	End
Down: Select next in the Project window/Move selected event in the Key Editor one semitone down	Down Arrow
Left: Select previous in the Project window/Key Editor	Left Arrow
Right: Select next in the Project window/Key Editor	Right Arrow
Toggle Selection	Ctrl/Cmd - Space
Top: Select top track in the track list	Home
Up: Select next in the Project window/ Move selected event in the Key Editor one semitone up	Up Arrow

Nudge Category

Option	Key command
Left	Ctrl/Cmd - Left Arrow

Option	Key command
Right	Ctrl/Cmd - Right Arrow
Nudge Bottom Down	Alt/Opt - Down Arrow
Nudge Bottom Up	Alt/Opt - Shift - Up Arrow
Nudge End Left	Alt/Opt - Shift - Left Arrow
Nudge End Right	Alt/Opt - Right Arrow
Nudge Start Left	Alt/Opt - Left Arrow
Nudge Start Right	Alt/Opt - Shift - Right Arrow
Nudge Top Down	Alt/Opt - Shift - Down Arrow
Nudge Top Up	Alt/Opt - Up Arrow

Project Category

Option	Key command
Colors	Alt/Opt - Shift - S
Open Markers	Ctrl/Cmd - M
Open Pool	Ctrl/Cmd - P
Open Tempo Track	Ctrl/Cmd - T
Remove Selected Tracks	Shift - Delete
Set Track/Event Color	Alt/Opt - Shift - C
Setup	Shift - S

Quantize Category

Option	Key command
Quantize	Q

Set Insert Length Category

Option	Key command
1/1	Alt/Opt - 1
1/2	Alt/Opt - 2
1/4	Alt/Opt - 3
1/8	Alt/Opt - 4
1/16	Alt/Opt - 5
1/32	Alt/Opt - 6
1/64	Alt/Opt - 7
1/128	Alt/Opt - 8
Toggle Dotted	Alt/Opt - .
Toggle Triplet	Alt/Opt - ,

Tool Category

Option	Key command
Draw Tool	8
Drumstick Tool	0
Erase Tool	5
Glue Tool	4
Mute Tool	7
Next Tool	F10
Object Selection Tool	1
Play Tool	9
Previous Tool	F9
Range Selection Tool	2

Option	Key command
Split Tool	3
Zoom Tool	6

Transport Category

Option	Key command
Activate External Sync	Alt/Opt - Shift - T
Activate Metronome	C
Activate Punch In	I
Activate Punch Out	O
Cycle	Num /
Enter Left Locator	Shift - L
Enter Locator Range Duration	Shift - D
Enter Project Cursor Position	Shift - P
Enter Right Locator	Shift - R
Enter Tempo	Shift - T
Enter Time Signature	Shift - C
Exchange Time Formats	.
Fast Forward	Shift - Num +
Fast Rewind	Shift - Num -
Forward	Num +
Go to Left Locator	Num 1
Go to Project Start	Num . or Num , or Num ;
Go to Right Locator	Num 2
Insert Marker (Windows only)	Insert

Option	Key command
Locate Next Event	N
Locate Next Hitpoint	Alt/Opt - N
Locate Next Marker	Shift - N
Locate Previous Event	B
Locate Previous Hitpoint	Alt/Opt - B
Locate Previous Marker	Shift - B
Locate Selection Start	L
Locators to Selection	P
Loop Selection	Alt/Opt - P
MIDI Retrospective Record: Insert from All MIDI Inputs	Shift - Num - - *
Nudge Cursor Left	Ctrl/Cmd - Num -
Nudge Cursor Right	Ctrl/Cmd - Num +
Panel (Transport panel)	F2
Play Selection Range	Alt/Opt - Space
Recall Cycle Marker 1 to 9	Shift - Num 1 to Num 9
Record	Num *
Rewind	Num -
Set Left Locator to Project Cursor Position	Ctrl/Cmd - Num 1
Set Marker 1	Ctrl/Cmd - 1
Set Marker 2	Ctrl/Cmd - 2
Set Marker 3 to 9	Ctrl/Cmd - Num 3 to Num 9 or Ctrl/Cmd - 3 to 9
Set Right Locator to Project Cursor Position	Ctrl/Cmd - Num 2
Start	Enter

Option	Key command
Start/Stop	Space
Stop	Num 0
To Marker 1	Shift - 1
To Marker 2	Shift - 2
To Marker 3 to 9	Num 3 to Num 9 or Shift - 3 to 9

Window Zones Category

Option	Key command
Show/Hide Left Zone	Ctrl/Cmd - Alt/Opt - L ; Alt/Opt - I
Show/Hide Right Zone	Ctrl/Cmd - Alt/Opt - R
Show/Hide Upper Zone	Ctrl/Cmd - Alt/Opt - U
Show/Hide Lower Zone	Ctrl/Cmd - Alt/Opt - E or Ctrl/Cmd - Alt/Opt - B
Show/Hide Transport Bar	Ctrl/Cmd - Alt/Opt - T
Show Previous Tab	Ctrl/Cmd - Alt/Opt - Left Arrow
Show Next Tab	Ctrl/Cmd - Alt/Opt - Right Arrow
Show Previous Page	Ctrl/Cmd - Alt/Opt - Up Arrow or Page Up
Show Next Page	Ctrl/Cmd - Alt/Opt - Down Arrow or Page Down
Show/Hide Info Line	Ctrl/Cmd - I
Show/Hide Overview	Alt/Opt - O

Zoom Category

Option	Key command
Zoom Full	Shift - F
Zoom In	H

Option	Key command
Zoom In On Waveform Vertically	Alt/Opt - H
Zoom In Tracks	Ctrl/Cmd - Down Arrow
Zoom In Vertically	Shift - H
Zoom Out	G
Zoom Out Of Waveform Vertically	Alt/Opt - G
Zoom Out Tracks	Ctrl/Cmd - Up Arrow
Zoom Out Vertically	Shift - G
Zoom to Event	Shift - E
Zoom to Selection	Alt/Opt - S
Zoom Tracks Exclusive	Z

Setting up Tool Modifier Keys

You can set up tool modifier keys that allow you to get an alternative function when using a tool.

PROCEDURE

1. In the **Preferences** dialog, select **Editing > Tool Modifiers**.

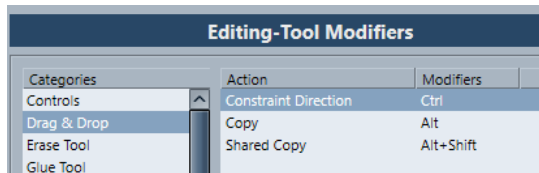

2. Select an option in the **Categories** list, and locate the action for which you want to edit the modifier key.
3. In the **Action** list, select the action.
4. Hold down the desired modifier keys and click **Assign**.

NOTE

If the modifier keys you pressed are already assigned to another tool, you will be asked whether you want to overwrite them. If you do, this leaves the other tool without any modifier keys assigned.

5. Click **OK**.
-

RESULT

The modifier keys for the action are replaced.

Customizing

In Cubase you can set up the appearance of specific elements.

RELATED LINKS

[Setup Options](#) on page 817

Setup Options

You can customize the appearance of the following elements:

- **Transport** panel
- Status line
- Info line
- Toolbars
- **Inspector**

Setup Context Menus

Setup context menus are available for the **Transport** panel, the toolbars, the info lines, or the **Inspector**.

- To open the setup context menus, right-click the corresponding element.

- **NOTE**

You can also click the corresponding setup buttons to open the context menu.

The following general options are available on the setup context menus:

- **Show All** makes all items visible.
- **Reset All** resets the interface to the default setting.
- **Setup** opens the setup dialog.

If presets are available, they can be selected on the lower half of the menu.

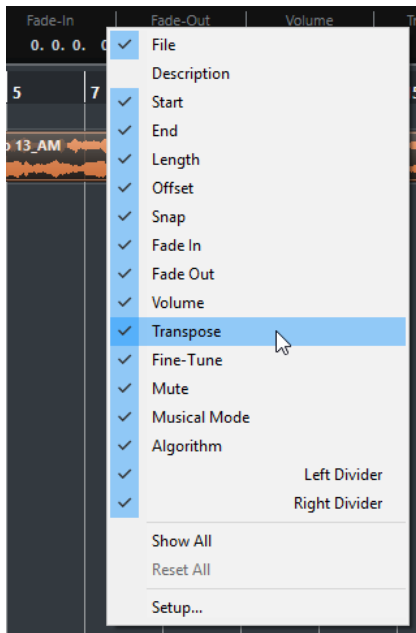

The info line setup context menu

Setup Dialog

The setup dialog allows you to specify which elements are visible/hidden and in what order they are shown. You can save and recall setup presets.

- To open a setup dialog, right-click the element that you want to set up, and select **Setup**.

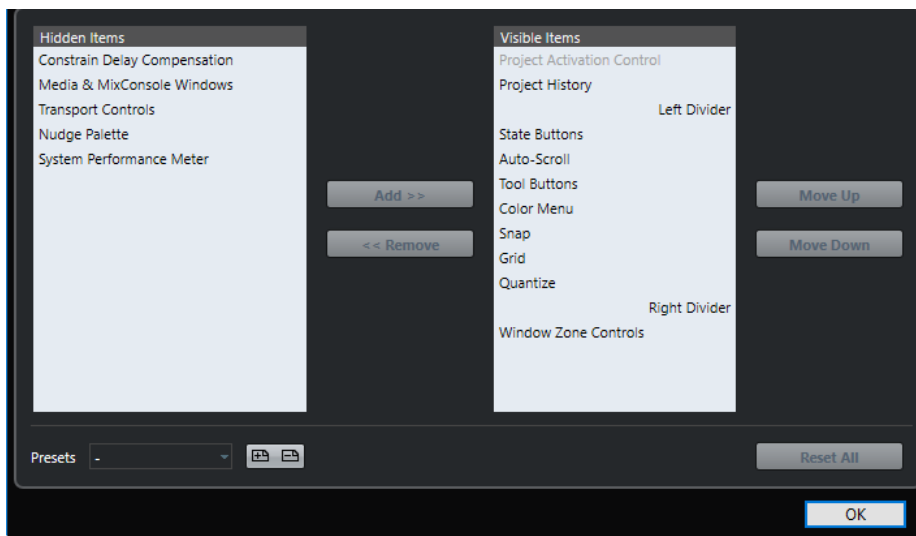

Hidden Items

Lists the elements that are hidden.

Visible Items

Lists the elements that are visible.

Add

Select an item in the list of **Hidden Items**, and click **Add** to make it visible.

Remove

Select an item in the list of **Visible Items**, and click **Remove** to hide it.

Move Up

Select an item in the list of **Visible Items**, and click **Move Up** to reorder the items.

Move Down

Select an item in the list of **Visible Items**, and click **Move Down** to reorder the items.

Store

Allows you to name the current configuration and save it as a preset.

Delete

Remove a selected preset.

Reset All

Reverts to the default configuration.

Windows Dialog

The **Windows** dialog allows you to manage open windows in Cubase.

- To open the **Windows** dialog, select **Window > Windows**.

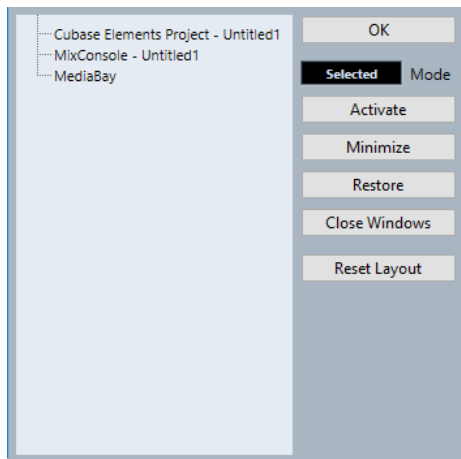

The dialog lists all open dialogs, windows, and editors. The following options are available:

OK

Closes the dialog.

Mode

Allows you to select a mode that affects the function.

- **Selected**
Affects the selected window only.
- **Cascaded**
Affects also the associated windows, such as the editors of a project window, for example.
- **All**
Affects all windows.

Activate

Activates the selected window.

Minimize

Minimizes the selected or all windows.

Restore

Restores the selected or all windows.

Close Windows

Closes the selected or all windows.

Reset Layout

Resets the layout of the selected window.

Where are the Settings Stored?

There is a large number of ways in which you can customize Cubase. While some of the settings you make are stored with each project, others are stored in separate preference files.

If you need to transfer your projects to another computer in another studio, for example, you can bring all your settings along by copying the desired preference files and installing them on the other computer.

NOTE

It is a good idea to make a backup copy of your preference files once you have set things up the way you want! This way, if another Cubase user wants to use his or her personal settings when working on your computer, you can restore your own preferences afterwards.

- On Windows, preference files are stored in the following location: `\Users\\AppData\Roaming\Steinberg\\`.
On the Start menu, you will find a shortcut to this folder for easy access.
- On macOS, preference files are stored in the following location: `/Library/Preferences/<program name>/` under your home directory.
The full path is: `/Users/<user name>/Library/Preferences/<program name>/`.

NOTE

The `RAMpresets.xml` file, which contains various presets settings, is saved when exiting the program.

NOTE

Program functions, such as crossfade, or configurations, such as panels, not used in the project will not be stored.

Updating from a Previous Version of Cubase

When you are updating from Cubase 6 or higher, most of the customized settings of your previous installation are used for the new Cubase version.

When your previous Cubase version is older than Cubase 6, its settings are discarded, and the default settings of the new version of Cubase are used.

Safe Mode Dialog

The **Safe Mode** dialog contains troubleshooting options.

- To open the **Safe Mode** dialog, launch Cubase, and hold down **Ctrl/Cmd - Shift - Alt/Opt**.

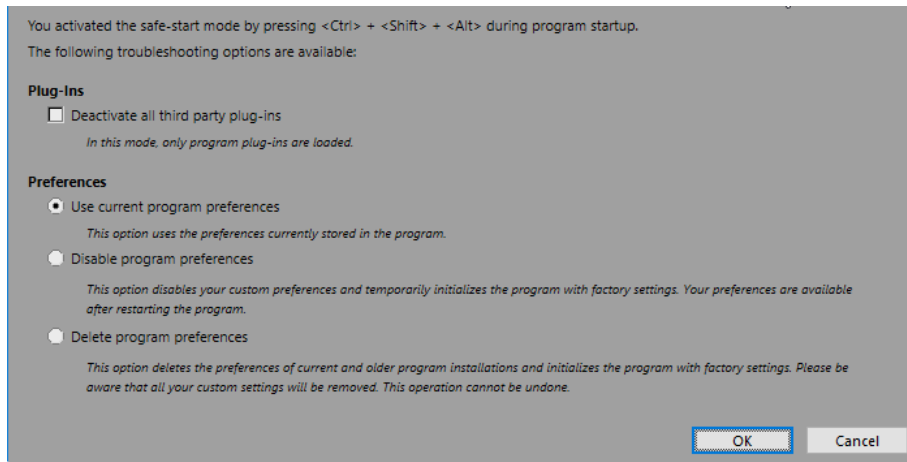

The following options are available in the **Plug-Ins** section:

Deactivate all third-party plug-ins

Temporarily disables all third-party plug-ins. After startup, only Steinberg plug-ins are available.

The following options are available in the **Preferences** section:

Use current program preferences

Opens the program with the current preference settings.

Disable program preferences

Disables the current preferences and opens the program with the factory default settings instead.

Delete program preferences

Deletes the preferences and opens the program with the factory default settings instead. This process cannot be undone. This affects all versions of Cubase installed on your computer.

RELATED LINKS

[Disabling Third-Party Plug-ins](#) on page 822

[Disabling the Preferences](#) on page 821

Disabling the Preferences

Sometimes you might experience odd program behavior that can be due to inconsistent preferences settings. In such a case, you should save your project and relaunch Cubase. You can disable or delete the current preferences settings, and load the factory defaults instead.

PROCEDURE

1. Quit Cubase.
2. Launch Cubase, and hold down **Ctrl/Cmd - Alt/Opt - Shift**.
3. In the **Preferences** section of the **Safe Start Mode** dialog, activate one of the troubleshooting options.
 - **Use current program preferences**
Opens the program with the current preference settings.
 - **Disable program preferences**

Disables the current preferences, and opens the program with the factory default settings instead.

- **Delete program preferences**

Deletes the preferences and opens the program with the factory default settings instead. This process cannot be undone. Note that this affects all versions of Cubase installed on your computer.

4. Click **OK**.

AFTER COMPLETING THIS TASK

If the program works fine with disabled preferences, consider deleting and re-initializing the preferences.

RELATED LINKS

[Safe Mode Dialog](#) on page 820

[Preferences](#) on page 827

Disabling Third-Party Plug-ins

If Cubase does not start or if a project does not load, chances are, that this is due to a third-party plug-in. In such a case, you can disable third-party plug-ins on startup to identify, if the plug-in is the reason.

PROCEDURE

1. Quit Cubase.
 2. Launch Cubase, and hold down **Ctrl/Cmd - Alt/Opt - Shift**.
 3. In the **Plug-Ins** section of the **Safe Start Mode** dialog, activate **Deactivate all third-party plug-ins**.
 4. Click **OK**.
-

RESULT

Only Steinberg plug-ins are available after startup, and third-party plug-ins are temporarily disabled.

RELATED LINKS

[Safe Mode Dialog](#) on page 820

Optimizing Audio Performance

To get the most out of your Cubase system, performance-wise, you can optimize specific settings.

NOTE

For details and current information on system requirements and hardware properties refer to the Steinberg web site.

Performance Aspects

Tracks and Effects

The faster your computer, the more tracks, effects, and EQs you are able to play. Exactly what constitutes a fast computer is almost a science in itself, but some hints are given below.

Short Response Times (Latency)

One aspect of performance is response time. The term “latency” refers to the buffering, that is, the temporary storing of small chunks of audio data during various steps of the recording and playback process on a computer. The larger those chunks, and the more there are, the higher the latency.

High latency is most irritating when playing VST instruments and when monitoring through the computer, that is, when listening to a live audio source via the Cubase **MixConsole** and effects. However, very long latency times (several hundred milliseconds) can also affect other processes like mixing, for example, when the effect of a fader movement is heard only after a noticeable delay.

While Direct Monitoring and other techniques reduce the problems associated with very long latency times, a system that responds fast will always be more convenient to work with.

- Depending on your audio hardware, it may be possible to trim your latency times, usually by lowering the size and the number of buffers.
- For details, refer to the audio hardware documentation.

Audio Hardware and Driver

The hardware and its driver can have some effect on regular performance. A badly written driver can reduce the performance of your computer. But where the hardware driver design makes the most difference is with latency.

NOTE

We recommend that you use audio hardware for which there is a specific ASIO driver.

This is especially true when using Cubase for Windows:

- Under Windows, ASIO drivers written specifically for the hardware are more efficient than the Generic Low Latency ASIO Driver and produce shorter latency times.

- Under macOS, audio hardware with properly written macOS (Core Audio) drivers can be very efficient and produce very low latency times.

However, there are additional features only available with ASIO drivers, such as the ASIO Positioning Protocol.

Settings That Affect Performance

Audio Buffer Settings

Audio buffers affect how audio is sent to and from the audio hardware. The size of the audio buffers affects both the latency and the audio performance.

Generally, the smaller the buffer size, the lower the latency. On the other hand, working with small buffers can be demanding for the computer. If the audio buffers are too small, you may get clicks, pops or other audio playback problems.

Adjusting the Buffer Size

To lower the latency, you can reduce the buffer size.

PROCEDURE

1. Select **Studio > Studio Setup**.
 2. In the **Devices** list, select your audio hardware driver.
 3. Click **Control Panel**.
 4. Do one of the following:
 - Windows: Adjust the buffer size in the dialog that opens.
 - macOS: Adjust the buffer size in the **CoreAudio Device Settings** dialog.
-

Multi Processing

Multi processing distributes the processing load evenly to all available CPUs, allowing Cubase to make full use of the combined power of the multiple processors.

Multi processing is activated by default. You can find the setting in the **Studio Setup** dialog (**Audio System** page).

Audio Performance Window

The **Audio Performance** window shows the audio processing load and the hard disk transfer rate. This allows you to verify that you do not run into performance problems when adding effects or plug-ins, for example.

- To open the **Audio Performance** window, select **Studio > Audio Performance**.



Realtime

Shows the average load of all audio realtime processes.

ASIO-Guard

Shows the average load of processes that can be preprocessed.

NOTE

Preprocessing only takes place if you activate **Activate ASIO-Guard** on the **Audio System** page of the **Studio Setup** dialog.

Peak

Shows the processing load in the real-time path of the audio engine. The higher this value, the higher the risk that dropouts occur.

Processing Overload

The overload indicator on the top right indicates dropouts. These occur if the processing load exceeds 100 % or if the audio engine is restarted due to the internal detection of too high processing delay. This might for example occur if the preprocessing buffer runs empty due to too high real-time load.

If it lights up, decrease the number of EQ modules, active effects, and audio channels that play back simultaneously. You can also activate the ASIO-Guard.

Disk Cache

Shows the hard disk transfer load.

Disk Cache Overload

The overload indicator to the right of the disk indicator lights up if the hard disk does not supply data fast enough.

If it lights up, use **Disable Selected Tracks** to reduce the number of tracks playing back. If this does not help, you need a faster hard disk. To reset the overload indicator, click its display. In the **Audio Performance** category of the **Key Commands** you can also assign a key command for this.

NOTE

You can show a simple view of the performance meter on the **Transport** panel and on the **Project** window toolbar. These meters only feature the average and the disk indicator.

RELATED LINKS

[Audio System Page](#) on page 16

[ASIO-Guard](#) on page 825

[Audio Performance Meter](#) on page 40

[Transport Panel Sections](#) on page 181

ASIO-Guard

The ASIO-Guard allows you to shift as much processing as possible from the ASIO real time path to the ASIO-Guard processing path. This results in a more stable system.

The ASIO-Guard allows you to preprocess all channels as well as VST instruments that do not need to be calculated in real time. This leads to fewer dropouts, the ability to process more tracks or plug-ins, and the ability to use smaller buffer sizes.

ASIO-Guard Latency

High ASIO-Guard levels lead to an increased ASIO-Guard latency. When you adjust a volume fader, for example, you will hear the parameter changes with a slight delay. The ASIO-Guard latency, in contrast to the latency of the audio hardware, is independent from live input.

Restrictions

The ASIO-Guard cannot be used for:

- Real time-dependent signals
- External effects and instruments

NOTE

If you select **Studio > VST Plug-in Manager** and click **Show VST Plug-in Information**, you can deactivate the ASIO-Guard option for selected plug-ins.

If you activate the monitoring for an input channel, a MIDI instrument, or a VST instrument channel, the audio channel and all dependent channels are automatically switched from ASIO-Guard to real time processing and vice versa. This results in a gentle fade out and fade in of the audio channel.

RELATED LINKS

[VST 2 Plug-in Path Settings](#) on page 531

[Audio Performance Window](#) on page 824

Activating the ASIO-Guard

PROCEDURE

1. Select **Studio > Studio Setup**.
2. In the **Devices** list, select **Audio System**.
3. Activate the **Activate ASIO-Guard** option.

NOTE

This option is only available if you activate **Activate Multi Processing**.

4. Select an **ASIO-Guard Level**.

The higher the level, the higher the processing stability and audio processing performance. However, higher levels also lead to an increased ASIO-Guard latency and memory usage.

Preferences

The **Preferences** dialog provides options and settings that control the global behavior of the program.

Preferences Dialog

The **Preferences** dialog is divided into a navigation list and a settings page. Clicking one of the entries in the navigation list opens a settings page.

- To open the **Preferences** dialog, select **Edit > Preferences**.

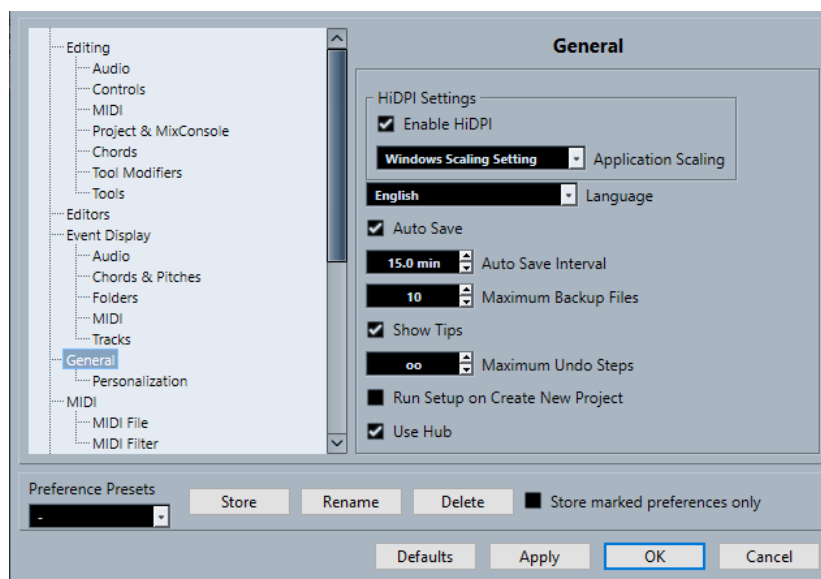

In addition to the settings, the dialog provides the following options:

Preference Presets

Allows you to select a saved preference preset.

Store

Allows you to save the current preferences as a preset.

Rename

Allows you to rename a preset.

Delete

Allows you to delete a preset.

Store marked preferences only

Allows you to select which pages are included in the preset.

Defaults

Resets the options on the active page to their default settings.

Apply

Applies any changes that you have made without closing the dialog.

OK

Applies any changes that you have made and closes the dialog.

Cancel

Closes the dialog without saving any changes.

Saving Preference Presets

You can save complete or partial preference settings as presets.

PROCEDURE

1. In the **Preferences** dialog, make your changes.
 2. Click **Store** in the lower left section of the dialog.
 3. Enter a preset name and click **OK**.
-

RESULT

Your settings are now available on the **Preference Presets** pop-up menu.

Saving Partial Preference Settings

You can save partial preference settings. This is useful when you have made settings that only relate to a certain project or situation, for example. When you apply a saved partial preference preset, you only change the saved settings. All other preferences are left unchanged.

PROCEDURE

1. In the **Preferences** dialog, make your changes.
2. Activate **Store marked preferences only**.
In the preferences list, the **Store** column is shown.

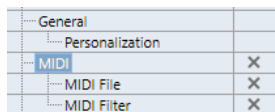

General	
Personalization	
MIDI	X
MIDI File	X
MIDI Filter	X

3. Click in the **Store** column of the preference pages that you want to save.
 4. Click **Store** in the lower left section of the dialog.
 5. Enter a preset name and click **OK**.
-

RESULT

Your settings are now available from the **Preference Presets** pop-up menu.

Editing

'Edit Solo'/'Record in MIDI Editors' Follow Focus

Suspends **Record in Editor** and **Solo Editor** in the MIDI editor if the **Project** window gets the focus.

Display Warning before Deleting Non-Empty Tracks

Shows a warning if you delete tracks that are not empty.

Select Track on Background Click

Allows you to select a track by clicking in the event display background.

Auto Select Events under Cursor

Automatically selects all events in the **Project** window or in an editor that are under the project cursor.

Cycle Follows Range Selection

Sets the left locator to the range start position and the right locator to the range end position of a range selection.

Delete Overlaps

Deletes overlapped, that is, hidden, sections of overlapping events. Hold **Shift** while moving events to override this setting.

Parts Get Track Names

Automatically changes event names to the name of the track they are moved to.

Quick Zoom

Only redraws the contents of parts and events once you have stopped changing the zoom. This is useful if screen redraws are slow on your system.

Use Up/Down Navigation Commands for Selecting Tracks only

Uses the **Up Arrow** / **Down Arrow** keys for track selection, not for event/part selection.

Track Selection Follows Event Selection

Automatically selects the corresponding track if you select an event in the **Project** window.

Automation Reduction Level

Allows you to remove all superfluous automation events. A reduction level value of 0% removes repeated automation points only. A reduction level value between 1 to 100 % smoothens the automation curve. The default value of 50 % should reduce the automation data amount significantly without touching the sound result of the existing automation.

Show Automation Track in Project on Writing Parameter

Reveals the automation track on writing automation parameters. This is useful if you want to have a visual control of all parameters changed on writing.

Automation Follows Events

Lets automation events automatically follow when you move, duplicate, copy, or paste an event or part on the track. This facilitates setting up automation that is related to a specific event or part, instead of a specific position in the project.

Drag Delay

Allows you to set up a delay in ms that is used when you move events. This is useful to avoid accidentally moving events when you click on them in the **Project** window.

Editing - Audio

Treat Muted Audio Events like Deleted

Allows you to play the hidden event of 2 overlapping audio events when you mute the top event.

Use Mouse Wheel for Event Volume and Fades

Allows you to use the mouse wheel to move event volume and fades.

- Moving the mouse wheel moves the event volume curve up or down.
- Holding down **Shift** while moving the mouse wheel moves the fade curves.

- Positioning the mouse in the left half of the event moves the end point of the fade in.
- Positioning the mouse in the right half of the event moves the start point of the fade out.

On Import Audio Files

Determines what happens when you import an audio file.

- **Open Options Dialog**
Opens a dialog where you can select whether you want to copy the file to the audio folder and/or convert it to the project settings.
- **Use Settings**
Uses the default settings for importing audio.

Remove Regions/Hitpoints on all Offline Processes

Removes regions/hitpoints of audio ranges when you perform offline processing.

On Processing Shared Clips

Determines what happens when you apply processing to a shared clip that is used by more than one event in the project.

- **Open Options Dialog**
Opens the **Options** dialog that allows you to select whether you want to create a new version of the clip or apply the processing to the existing clip.
- **Create New Version**
Creates a new editing version of the clip, and applies the processing to that version leaving the original clip unaffected.
- **Process Existing Clip**
Applies the processing to the existing clip. All events playing that clip are affected.

Enable Automatic Hitpoint Detection

Enables the automatic hitpoint detection for imported or newly recorded audio files.

Default Warping Algorithm

Sets the warp algorithm for new audio clips in the project.

Editing - Chords

'X' Chords Mute Notes on Tracks That are in Follow Chord Track Mode

Mutes playback when you play back a track that follows the chord track and the cursor reaches an undefined chord event (X chord).

Disable 'Acoustic Feedback' during Playback

Disables **Acoustic Feedback** during playback. This ensures that chord events are not triggered twice.

Hide Muted Notes in Editors

Hides notes that get muted due to their MIDI track following the chord track.

Editing - Controls

Value Box/Time Control Mode

Allows you to select your preferred way of controlling value fields.

- **Text Input on Left-Click**

Clicking opens a value box for editing.

- **Increment/Decrement on Left/Right-Click**

Clicking decreases the value, right-clicking increases the value. Double-clicking allows you to enter values manually.

- **Increment/Decrement on Left-Click and Drag**

Clicking and dragging up or down adjusts the value. Double-clicking allows you to enter values manually.

Knob Mode

Allows you to select your preferred way of controlling knobs.

- **Circular**

Clicking and dragging in a circular motion changes the setting. Clicking anywhere along the encoder's edge immediately changes the setting.

- **Relative Circular**

Clicking anywhere on an encoder and dragging changes the current setting. There is no need to click on the exact current position.

- **Linear**

Clicking on an encoder and dragging up or down, or left or right changes the setting.

Slider Mode

Allows you to select your preferred way of controlling value sliders.

- **Jump**

Clicking anywhere on a slider instantly moves the slider handle to that position.

- **Touch**

Clicking and dragging the actual slider handle adjusts the setting.

- **Ramp**

Clicking and dragging a slider causes the handle to move smoothly to the new position.

- **Relative**

Clicking and dragging up or down changes the setting according to how far you drag, not according to where you click.

Editing - MIDI

Select Controllers in Note Range: Use Extended Note Context

Takes into account the extended note context when you move notes together with their controllers. This means that controllers between the last selected note and the following note or the end of the part are also moved.

Legato Overlap

Allows you to set an overlap for the **Legato** function. **Legato** allows you to extend MIDI notes so that they reach the next notes.

An overlap setting of 0 ticks causes each selected note to extend so that it reaches the next note exactly. A positive value causes the notes to overlap by the specified number of ticks. A negative value causes a slight gap between the notes.

Legato Mode: Between Selected Notes Only

Adjusts the length of selected notes so that they reach the next selected note.

Split MIDI Events

Splits MIDI events when you split a MIDI part in the **Project** window, and the split position intersects the MIDI events. This also creates new notes at the beginning of the second part.

Split MIDI Controllers

Splits MIDI controllers when you split a MIDI part in the **Project** window, and the part contains a controller. If the controller value at the split position is not zero, a new controller event of the same type and value is inserted at the split position at the start of the second part.

NOTE

If you just split a part and play back the result, it will sound the same regardless of this setting. However, if you split a part and delete the first half or move the second half to a different position in the project, you may want to activate **Split MIDI Controllers** to make sure all controllers have the correct value at the beginning of the second part.

Editing - Project & MixConsole

Select Channel/Track on Solo

Selects channels/tracks when you click their **Solo** button.

Select Channel/Track on Edit Settings

Selects channels/tracks when you click their **Edit Channel Settings** button.

Scroll to Selected Track

Scrolls the track list when you select a **MixConsole** channel and the respective track is out of view.

Enable Record on Selected MIDI Track

Record-enables MIDI tracks when you select them.

Enable Record on Selected Audio Track

Record-enables audio tracks when you select them.

Enable Solo on Selected Track

Solos tracks when you select them.

Enlarge Selected Track

Enlarges a track when you select it. If you select a different track, this track is enlarged, and the previously selected track is displayed in its original size.

Editing - Tool Modifiers

The default tool modifiers are arranged in categories.

Categories	Action	Modifiers
Controls	Reset to Default Value	Ctrl/Cmd

Categories	Action	Modifiers
Drag & Drop	Constraint Direction	Ctrl/Cmd
	Copy	Alt/Opt
	Shared Copy	Alt/Opt - Shift
Erase Tool	Delete later events	Alt/Opt
Glue Tool	Glue All Following Events	Alt/Opt
Info Line	All Events Same Value	Ctrl/Cmd
Range Tool	Exclude Row	Ctrl/Cmd
	Select Full Vertical	Ctrl/Cmd - Shift
Select Tool	Edit Velocity	Ctrl/Cmd - Shift
	Set Cursor Position	Alt/Opt - Shift
	Slip Event Content	Ctrl/Cmd - Alt/Opt
	Split Event	Alt/Opt
Size Objects	All Events Same Value	no default assignment
	Disable Snapping	Ctrl/Cmd
	Repeat Event	Alt/Opt
	Size with Fade	Ctrl/Cmd - Alt/Opt
	Time Stretch	no default assignment
Split Tool	Split repeated	Alt/Opt
Trim Tool	Constrain Direction	Ctrl/Cmd
	Trim Start	Alt/Opt

Editing Tool Modifiers

You can edit the default tool modifier keys.

PROCEDURE

1. Select an option in the **Categories** list.
2. Select the action for which you want to edit the modifier keys in the **Action** list.
3. On your computer keyboard, hold down the modifier keys and click **Assign**.

RESULT

The current modifier keys for the action are replaced. If this tool already has assigned modifier keys, you are prompted to replace them.

Editing - Tools

Show Toolbox on Right-Click

Opens a toolbox when you right-click in the event display and editors. To open the context menu instead of the toolbox, press any modifier key when right-clicking.

Cross-Hair Cursor

Allows you to set up the colors for the line and the mask of the cross-hair cursor, as well as its width.

Zoom Tool Standard Mode: Horizontal Zooming Only

Zooms the window horizontally without changing the track height when you zoom with the **Zoom** tool.

Select Tool: Show Extra Info

Displays the current pointer position and the name of the track and event at which you are pointing when you use the **Object Selection** tool in the **Project** window event display.

Show Notification when Switching Tool Mode with Key Command

Shows a notification when you switch the tool mode by using a key command.

Editors

Use Drum Editor when Drum Map is assigned

Shows drum note symbols in parts on MIDI tracks to which drum maps are assigned. The parts automatically open in the **Drum Editor** on double-click. This overwrites the **Default MIDI Editor** setting.

Default MIDI Editor

Determines which editor is opened when you double-click a MIDI part or when you select it and press **Ctrl/Cmd - E**. This setting is overwritten for tracks with drum maps if **Use Drum Editor when Drum Map is assigned** is activated.

Editor Content Follows Event Selection

Open editors show the events that are selected in the **Project** window.

Double-click opens Editor in a Window/in Lower Zone

Determines where an editor is opened when you double-click an audio event or a MIDI part, or when you use the key command assigned to **Open/Close Editor**.

Open Editor Commands open Editors in a Window/in Lower Zone

Determines where an editor is opened when you use an open command from the **Audio** or **MIDI** menu or the corresponding key commands.

Event Display

The **Event Display** section contains several settings for customizing the display in the **Project** window.

Show Event Names

Shows the names on parts and events.

Hide Truncated Event Names

Hides event names if they are too long.

Show Overlaps

Determines how overlapping events are displayed.

Grid Overlay Intensity

Sets the overlay intensity of the displayed grid lines.

Event Handling Opacity

Sets the opacity of overlying events when you move them.

Event Opacity

Sets the opacity of the event background.

NOTE

- If you reduce the event opacity, it might be helpful to increase the **Waveform Brightness** for audio events or the **Note Brightness** for MIDI events.
- Reducing the opacity may result in a less responsive user interface.

Smallest Track Height to Show Data

Determines from which track height the track contents are displayed.

Smallest Track Height to Show Name

Determines from which track height the track names are displayed.

RELATED LINKS

[Waveform Brightness](#) on page 835

[Note Brightness](#) on page 837

Event Display - Audio

Append Clip Name to Event Name

Appends the clip name in brackets to the displayed event name.

Interpolate Audio Waveforms

Interpolates sample values to form curves when you zoom in to one sample per pixel or less.

Show Event Volume Curves Always

Shows event volume curves, regardless of whether the event is selected.

Show Waveforms

Shows waveforms for audio events.

Show Hitpoints on Selected Events

Shows hitpoints for selected audio events.

Waveform Brightness

Sets the brightness of the waveform.

Waveform Outline Intensity

Sets the intensity of the waveform outline.

Fade Handle Brightness

Sets the brightness of the fade lines for audio events.

Background Color Modulation

Reflects the waveform dynamics in the background of audio waveforms.

Event Display - Chords & Pitches

Pitch Notation

- **Note Name**
Allows you to select how chord symbols are displayed. You can choose **English**, **German**, or **Solfège**.
- **Naming Format**
Allows you to determine how MIDI note names are displayed in editors, etc.
- **Display 'Bb' as 'B'**
Displays 'B' as a pitch name. This is only available if you selected **English** in the **Note Name** pop-up menu.
- **Display 'B' as 'H'**
Displays 'H' as a pitch name. This is only available if you selected **English** in the **Note Name** pop-up menu.
- **Enharmonics from Chord Track**
Uses the chord events on the chord track to determine if enharmonically equivalent notes in the **Key Editor** and in the **List Editor** are displayed as sharp or flat.

Chord Font

Allows you to specify a font for all chord symbols.

Chord Symbols

Allows you to select your preferred display method for major 7th chords, minor chords, half-diminished chords, diminished chords, and augmented chords.

Custom Chord Symbols

Allows you to modify the default chord symbols that are used on the chord track, for the chord pads, and in the **Score Editor**.

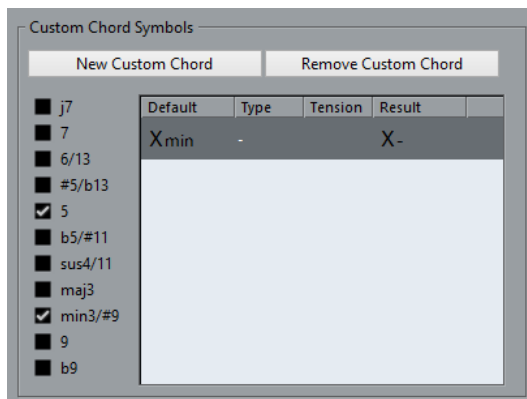

- **New Custom Chord** allows you to add a new custom chord symbol.
- The options to the left allow you to specify the chord for which you want to change the chord symbol.
- Click the **Type** and **Tension** column and enter your custom symbol.

NOTE

You must define custom symbols for each set of tensions.

- The **Result** column shows how the chord will be displayed.

- The **Remove Custom Chord** button allows you to remove the custom chord symbol that is selected in the list.

EXAMPLE

To change the appearance of all minor chords from **Xmin** to **X-**, click **New Custom Chord**, activate **5** and **min3/#9** to define the chord type, and change the symbol in the **Type** column from **min** to **-**.

Event Display - Folders

Show Event Details

Displays event details instead of data blocks.

This setting depends on the **Show Data on Folder Tracks** setting.

Show Data on Folder Tracks

Determines in which case data blocks or event details are displayed on folder tracks.

- **Always Show Data**
Always displays data blocks or event details.
- **Never Show Data**
Displays nothing.
- **Hide Data When Expanded**
Hides the display of events when you open folder tracks.

Event Display - MIDI

Part Data Mode

Determines if and how events in MIDI parts are shown. This setting is overwritten for tracks with drum maps if **Use Drum Editor when Drum Map is assigned** is activated.

Show Controllers

Shows non-note events such as controllers, etc. in MIDI parts.

Note Brightness

Sets the brightness of note events.

Controller Brightness

Sets the brightness of controller events.

RELATED LINKS

[Use Drum Editor when Drum Map is assigned](#) on page 834

Event Display - Tracks

Default Track Name Width

Sets the default name width for all track types.

General

The **General** page contains general settings that affect the program user interface. Set these according to your preferred work methods.

Enable HiDPI (Windows only)

Enables the appropriate resolution to render Cubase user interface sharp and precise on high resolution displays with supported scaling factors of 100 %, 125 %, 150 %, 175 %, and 200 %.

NOTE

Other scaling factors, such as 133 %, are not supported.

The **Application Scaling** menu allows you to scale the Cubase user interface relatively to the Windows system scaling setting.

NOTE

On macOS, you can disable HiDPI support in the Cubase application folder by invoking **Get Info** and checking **Open in Low Resolution**.

Usage Logger Options

If you activate this option, Cubase gathers usage information and writes it in a log file that you can find in the following location:

- On Windows: \Users\\AppData\Local\Steinberg\usagelogger
On macOS: /Users/<user name>/Library/Logs/Steinberg/usagelogger

Activating this option to write such a file, and then sending the file to the Steinberg support team can be useful if Cubase crashes, and the crash dump files do not reveal enough information.

By default, **Enable Usage Logging** is deactivated. We recommend that you deactivate it when you no longer need it.

Language

Allows you to select which language is used in the program. After switching the language, you must restart the program for the change to take effect.

Auto Save

Automatically saves backup copies of all open projects with unsaved changes. These are named Name.bak, where name is the name of the project, and are saved in the project folder. Backup copies of unsaved projects are named #UntitledX.bak, where X is an incremental number, to allow multiple backup copies in the same project folder.

Auto Save Interval

Allows you to specify how often a backup copy is created.

Maximum Backup Files

Allows you to specify how many backup files are created. When the maximum number of backup files is reached, the existing files is overwritten starting with the oldest file.

Show Tips

Displays an explanatory tooltip when you position the mouse pointer over an icon or button in Cubase.

Maximum Undo Steps

Allows you to specify the number of undo steps.

Run Setup on Create New Project

Opens the **Project Setup** dialog every time you create a new project.

Use Hub

Opens the **Hub** when you start Cubase or create a new project using the **File** menu.

RELATED LINKS

[VST Instrument Context Menu](#) on page 517

General - Personalization

Default Author Name

Allows you to specify an author name that is used by default for new projects. This is included as metadata when exporting audio files with an iXML chunk.

Default Company Name

Allows you to specify a company name that is used by default for new projects. This is included as metadata when exporting audio files with an iXML chunk.

MIDI

This page contains settings that affect MIDI recording and playback.

MIDI Thru Active

Sets all MIDI tracks that are record-enabled or have monitoring activated to echo incoming MIDI data, sending it back out on their respective MIDI outputs and channels. This allows you to hear the correct sound from your MIDI instrument during recording.

NOTE

If you use MIDI Thru, select **Local Off** mode on your MIDI instrument to prevent each note from sounding twice.

Reset on Stop

Sets Cubase to send out MIDI reset messages, including note-off and controller resets, on stop.

Never Reset Chased Controllers

Never resets controllers to 0 when you stop playback or move to a new position in the project.

Length Adjustment

Allows you to enter a length adjustment value in ticks by which the notes that have the same pitch and MIDI channel are adjusted. This ensures that there is always a short time between the end of one note and the start of another. By default, there are 120 ticks per 1/16 note, but you can adjust this with the **MIDI Display Resolution** setting.

Chase Events

Chases event types for which one of the chase options is activated when you locate to a new position and start playback. This makes your MIDI instruments sound as they should when you locate to a new position and start playback.

If **Chase not limited to Part Boundaries** is activated, MIDI controllers are also chased outside the part boundaries, and the chase is performed on the part under the cursor

as well as on all the parts to the left of it. Deactivate this for very large projects, as it slows down processes such as positioning and soloing.

MIDI Display Resolution

Allows you to set the display resolution for viewing and editing MIDI data.

Extend Playback Range of Notes that start before the Part

Extends the playback range of MIDI notes that start before the part in ticks. This is useful if MIDI events start shortly before the start of the MIDI part. If you do not extend the playback range, these events are not played. This setting is also taken into account during cycle playback.

Insert Reset Events after Record

Inserts a reset event at the end of each recorded part. This resets controller data, such as **Sustain**, **Aftertouch**, **Pitchbend**, **Modulation**, or **Breath Control**. This is useful if you stop recording before the note-off command is sent, for example.

MIDI Latency Mode

Allows you to specify the latency of the MIDI playback engine.

Low lowers the latency and increases the responsiveness of the MIDI playback engine. However, this setting might also decrease your computer performance if your project contains lots of MIDI data.

Normal is the default mode and the recommended setting for most workflows.

High increases the latency and the playback buffer. Use this if you work with complex VST instrument libraries or with projects that have a very high performance level.

MIDI Max. Feedback in ms

Allows you to set the maximum length of the notes when using **Acoustic Feedback** in MIDI editors.

MIDI - MIDI File

Export Options

These options allow you to specify what data is included in exported MIDI files.

Export Inspector Patch

Includes MIDI patch settings in the **Inspector** as MIDI bank select and program change events in the MIDI file.

Export Inspector Volume/Pan

Includes volume and pan settings in the **Inspector** as MIDI volume and pan events in the MIDI file.

Export Automation

Includes automation as MIDI controller events in the MIDI file.

Export Inserts

Includes MIDI modifiers and MIDI inserts in the MIDI file.

Includes MIDI modifiers in the MIDI file.

Export Markers

Includes markers as standard MIDI file marker events in the MIDI file.

Export as Type 0

Exports a type 0 MIDI file with all data on a single track, but on different MIDI channels. If you deactivate this option, a type 1 MIDI file with data on separate tracks is exported.

Export Resolution

Allows you to set a MIDI resolution between 24 and 960 for the MIDI file. The resolution is the number of pulses, or ticks, per quarter note (PPQ) and determines the precision with which you will be able to view and edit the MIDI data. The higher the resolution, the higher the precision. Choose the resolution based on the application or sequencer to be used, because certain applications and sequencers may not be able to handle certain resolutions.

Export Locator Range

Exports only the range between the left and the right locator.

Export includes Delay

Includes delay settings you have made in the MIDI file via the **Inspector**.

Import Options

The **Import Options** for MIDI files allow you to specify what data to include in imported MIDI files.

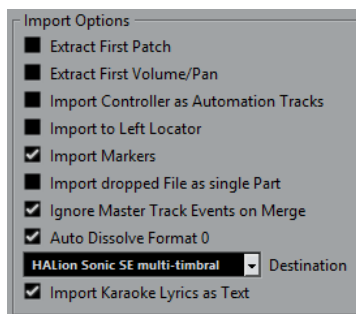

Extract First Patch

Converts the first **Program Change** and **Bank Select** events for each track to **Inspector** settings for the track.

Extract First Volume/Pan

Converts the first **MIDI Volume** and **Pan** events for each track to **Inspector** settings for the track.

Import Controller as Automation Tracks

Converts **MIDI Controller** events in the MIDI file to automation data for the MIDI tracks.

Import to Left Locator

Aligns the imported MIDI file to the position of the left locator.

Import Markers

Imports any markers that have been added.

Import Dropped File as Single Part

Places the file on one track if you drag a MIDI file into the project.

Ignore Master Track Events on Merge

Ignores tempo track data if you import a MIDI file into the current project. The imported MIDI file adapts to the current tempo track in the project.

Auto Dissolve Format 0

Automatically dissolves imported MIDI files of type 0. Each embedded MIDI channel in the file is placed on a separate track in the **Project** window.

Destination

Allows you to specify what happens when you drag a MIDI file into the project.

- **MIDI Tracks** creates MIDI tracks for the imported file.
- **Instrument Tracks** creates instrument tracks for each MIDI channel in the MIDI file and causes the program to automatically load appropriate presets.
- **HALion Sonic SE multi-timbral** creates several MIDI tracks, each routed to a separate instance of HALion Sonic SE in the **VST Instruments** window, and loads the appropriate presets.

Import Karaoke Lyrics as Text

Converts karaoke lyrics in the MIDI file to text that can be displayed in the **Score Editor**. If this option is deactivated, lyrics are only shown in the **List Editor**.

MIDI - MIDI Filter

This page allows you to prevent certain MIDI messages from being recorded and/or echoed by the MIDI thru function (thruput).

The page is divided into 4 sections:

Record

Prevents the corresponding type of MIDI message from being recorded. It will, however, be thruput, and if already recorded, play back normally.

Thru

Prevents the corresponding type of MIDI message from being thruput. It will, however, be recorded and played back normally.

Channels

Prevents MIDI messages on that MIDI channel from being recorded or thruput. Already recorded messages are, however, played back normally.

Controller

Prevents certain MIDI controller types from being recorded or thruput.

To filter out a controller type, select it from the list at the top of the section and click **Add**. It is shown in the list below.

To remove a controller type from the list (allow it to be recorded and thruput), select it in the lower list and click **Remove**.

MediaBay

Maximum Items in Results List

Sets the maximum number of files that are displayed in the **Results** list.

Show File Extensions in Results List

Displays file name extensions in the **Results** list.

Scan Folders Only When MediaBay Is Open

Scans for media files when the **MediaBay** window is open.

NOTE

During playback or recording no folder scans are performed.

Scan Unknown File Types

Scans all file types.

Metering

Map Input Bus Metering to Audio Track (in Direct Monitoring)

Maps the input bus metering to monitor-enabled audio tracks, giving you the opportunity to watch the input levels of your audio tracks when working in the **Project** window. For this to work, activate **Direct Monitoring** in the **Studio Setup** dialog.

Note that the tracks are mirroring the input bus signal, that is, you will see the same signal in both places. When using mapped metering, any functions, such as trimming, that you apply to the audio track are not reflected in its meters.

Meters' Peak Hold Time

Allows you to specify for how long the peak levels are held in the meters. For this to work, deactivate **Meters - Hold Forever** in the **MixConsole**.

Meters' Fallback

Allows you to specify how quickly the meters in the **MixConsole** return to lower values after signal peaks.

Metering - Appearance

This page allows you to assign colors to level meter values to quickly identify what levels are reached.

Add

Adds a color handle to the top of the meter.

Remove

Removes the selected color handle.

RELATED LINKS

[Setting up Meter Colors](#) on page 296

Record

This page contains settings related to audio and MIDI recording.

Deactivate Punch In on Stop

Deactivates **Punch In** on the **Transport** panel whenever you enter stop mode.

Stop after Automatic Punch Out

Stops playback after automatic **Punch Out**. If the post-roll value on the **Transport** panel is set to a value other than zero, playback will continue for the set time before stopping.

Record - Audio

Audio Pre-Record Seconds

Sets for how many seconds any incoming audio you play is captured in buffer memory during playback or in stop mode.

When Recording Wave Files Larger than 4 GB

Determines what happens if you record wave files that are larger than 4 GB.

- To split the wave file, select **Split Files**.
Use this if you work on a FAT32 file system that supports only file sizes up to 4 GB.
- To save the wave file as an RF64 file, select **Use RF64 Format**.
RF64 files use the .wav extension. However, they can only be opened with an application that supports the RF64 standard.

Create Audio Images during Record

Creates and displays a waveform image during the recording process.

NOTE

This real-time calculation uses some extra processing power.

Record - Audio - Broadcast Wave

This page allows you to specify the **Description**, **Author**, and **Reference Value** text strings that are embedded in recorded Broadcast Wave files. The settings you make here also appear as default strings in the **Broadcast Wave Chunk** dialog when you export files to certain formats. Not only Broadcast Wave files can contain embedded information, but also Wave, and AIFF files.

Record - MIDI

Record-Enable allows MIDI Thru

Prevents record-enabled MIDI or instrument tracks from echoing incoming MIDI data. This way record-enabled tracks to which a VST instrument is assigned do not play doubled notes.

Snap MIDI Parts to Bars

Lengthens recorded MIDI parts so that they start and end at whole bar positions. If you are working in a context that is based on bars and beats, this can make editing, such as moving, duplicating, and repeating, easier.

MIDI Record Catch Range in ms

Ensures that the very start of a recording that starts at the left locator is included.

Retrospective Record Buffer Size in Events

You can capture MIDI data that you played in **Stop** mode or during playback and turn them into a MIDI part. **Retrospective Record Buffer Size** determines how much MIDI data can be captured in the buffer.

ASIO Latency Compensation Active by Default

Determines the initial state of the **ASIO Latency Compensation** button in the track list for MIDI or instrument tracks.

If you record live on a VST instrument, you usually compensate the latency of your audio card by playing too early. In consequence, the timestamps are recorded too

early. By activating this option, all recorded events are moved by the current latency, and playback sounds like during the recording situation.

Add Latency to MIDI-Thru Processing

If you set the audio buffer size to a high value, and you play an arpeggiator in real time, for example, the MIDI notes are output with an increased latency.

If you consequently adapt your playing to the output latency, the notes are recorded even later. To minimize this effect, you can activate **Add Latency to MIDI-Thru Processing**. This adds a regular latency to each note that is played in real time.

Replace Recording in Editors

Affects the result of recording in a MIDI editor when **Replace** mode is selected as a record mode:

- **None**
Nothing is replaced.
- **Controller**
Only controller data is replaced, not notes.
- **All**
Replace mode works as usual. Notes and controllers are replaced when recording.

Transport

This page contains options related to playback, recording, and positioning.

Playback Toggle Triggers Local Preview

Allows you to use **Space** on your keyboard to start/stop local playback of the selected file in the **Sample Editor** or the **Pool**.

When the **Sample Editor** is not open or when there is no audio file selected in the **Pool**, **Space** still toggles the global project playback.

Show Timecode Subframes

Shows subframes for all frame-based display formats.

Return to Start Position on Stop

Automatically sets the project cursor to the position where recording or playback last started when you stop playback.

Stop Playback while Winding

Stops playback when you click **Rewind** or **Fast Forward** on the **Transport** panel.

Wind Speed Options

These options affect the fast forward/rewind speed.

- **Adjust to Zoom** adapts the wind speed to the horizontal zoom factor.
If you zoom in very close for detailed editing, you probably do not want to have a high fast forward/rewind speed. Because of this, the **Speed Factor** does not have any effect in this mode. The **Fast Wind Factor** still applies.
- **Fixed** keeps a fixed wind speed regardless of the horizontal zoom factor.
- **Speed Factor** allows you to set the wind speed. You can set a value between 2 and 50. The higher the value, the faster the wind speed will be.
If **Adjust to Zoom** is activated, this has no effect.
- **Fast Wind Factor** allows you to set the winding speed to a multiple for fast winding.

If you press **Shift** while fast forwarding or rewinding, the wind speed will increase. The increase in speed is a multiple of the **Speed Factor**. Meaning that if you set the **Fast Wind Factor** to 2, the wind speed will be twice as fast. If you set it to 4, the wind speed will be 4 times as fast, etc. You can set a value between 2 and 50.

Cursor Width

Adjusts the width of the project cursor line.

Zoom while Locating in Time Scale

Allows you to zoom in or out by clicking in the ruler and dragging down or up.

Clicking Locator Range in Upper Part of the Ruler Activates Cycle

Allows you to activate/deactivate cycle mode when you click the locator range in the upper part of the ruler.

Locate when Clicked in Empty Space

Allows you to move the project cursor by clicking in an empty area of the **Project** window.

Transport - Scrub

Scrub Tool Volume

Sets the playback volume for the **Scrub** tool in the **Project** window and audio editors.

NOTE

This does not affect the scrub volume controlled by any connected hardware.

Use High Quality Scrub Mode

Enables effects for scrubbing and uses a higher resampling quality. However, scrubbing will be more demanding on the processor.

Use Inserts While Scrubbing

Allows you to activate insert effects for scrubbing with the shuttle speed control. By default, insert effects are bypassed.

User Interface

This page contains options that allow you to adjust the default user interface colors.

Color Schemes

Allows you to adjust the color scheme for the application and the desktop cover.

- Click the **Custom Color Scheme** field to open the **Color Picker**, and select one of the colors in the **Default Colors** section to apply a pre-defined color.
- Click the color field for a specific item to open the **Color Picker** and select a custom color for it.

Track & MixConsole Channel Colors

Allows you to set the **Auto Track/Channel Color Mode**, to colorize track controls and **MixConsole** channel controls, and to determine the brightness of selected channels.

Track Type Default Colors

Allows you to set the colors for the different track types.

Customizing the User Interface Colors

You can change the color of the Cubase desktop, the track types, the **Project** window, and the editor elements.

PROCEDURE

1. In the **Preferences** dialog, select **User Interface > Color Schemes**.
2. Do one of the following:
 - Activate a default color scheme by clicking on it.
 - Click **Custom Color Scheme** and in the **Color Picker**, select a new color.

RESULT

The color scheme is instantly applied.

User Interface - Track & MixConsole Channel Colors

Allows you to set the **Auto Track/Channel Color Mode** to colorize track controls and channel faders, and to determine the brightness of selected channels.

Auto Track/Channel Color Mode

Allows you to set an automatic color assignment mode for new tracks or new channels.

Use Track's Default Color

New tracks get the default event color.

Use Previous Track Color

New tracks get the same color as the track above them in the track list.

Use Previous Track Color +1

This is similar to **Use Previous Track Color**, except that new tracks get the next color in the color palette.

Use Last Applied Color

New tracks get the color that you last applied to an event/part.

Use Random Track Color

New tracks get random track colors.

Colorize Tracks and MixConsole Channels

Applies the track/channel color to track/channel controls.

Tracks

Enables the application of the track color to the track controls.

Folder Tracks

Enables the application of the folder track color to the track controls.

MixConsole Channels

Enables the application of the **MixConsole** channel color to the channel controls.

Color Strength

Allows you to adjust the intensity of the color.

Selected Channel Brightness

Allows you to adjust the brightness of the selected **MixConsole** channel.

Show Color for Selected Channel

Colorizes the selected channel and gives it more color strength instead of displaying it in gray.

VST

This page contains settings for the VST audio engine.

Warn if realtime mixdown is required in order to include external plug-in

Shows a warning if a realtime mixdown is required.

Connect Sends Automatically for Each Newly Created Channel

Automatically connects the send routing for existing FX channels when you create a new audio or group channel.

Instruments use Automation Read All and Write All

If you activate this, the **Read** and **Write** automation status in control panels for VST instruments is affected by **Activate/Deactivate Read for All Tracks** and **Activate/Deactivate Write for All Tracks**.

Mute Pre-Send when Mute

Mutes pre-fader sends when you mute their channels.

Default Send Level

Allows you to specify a default level for your send effects.

Group Channels: Mute Sources as well

Mutes channels that are directly routed to a group channel when you mute the group channel. Channels that were muted prior to the group channel being muted will not remember their mute status and will be unmuted when the group channel is unmuted.

NOTE

This does not affect how mute automation is written.

Delay Compensation Threshold (for Recording)

Minimizes the latency effects of the delay compensation while maintaining the sound of the mix as far as possible. Only plug-ins with a delay higher than this threshold setting are affected by the **Constrain Delay Compensation** function. By default, this is set to 0.0 ms, which means that all plug-ins will be affected. If you feel that a little latency is acceptable, you can raise this threshold value.

NOTE

Cubase features full delay compensation—any delay inherent in the VST plug-ins you use will automatically be compensated for during playback. However, when you play a VST instrument in real time or record live audio (with monitoring through Cubase activated), this delay compensation may result in added latency.

Do Not Connect Input/Output Busses When Loading External Projects

Prevents connecting input and output busses to the ASIO ports of your system when loading external projects.

Auto Monitoring

Determines how Cubase handles monitoring. The following options are available:

- **Manual**
Turns input monitoring on or off when you click **Monitor**.
- **While Record-Enabled**
Connects the audio source to the channel input when you click **Record Enable**.
- **While Record Running**
Switches to input monitoring only during recording.
- **Tapemachine Style**
Activates input monitoring in stop mode and during recording, but not during playback.

NOTE

The automatic monitoring options apply when you monitor through Cubase, or when you use ASIO Direct Monitoring. If you monitor externally (listen to the input signal from an external mixer, for example), select **Manual** mode and keep all audio **Monitor** buttons turned off in Cubase.

Warn on Processing Overloads

Shows a warning if the **Processing Overload** indicator on the **Transport** panel lights up during recording.

VST - Plug-ins

Warn before Removing Modified Effects

Shows a warning if you remove an effect plug-in for which you have made parameter changes.

Open Effect Editor after Loading It

Opens the effect control panel when you load VST effects or VST instruments.

Create MIDI Track when Loading VSTi

Allows you to determine if a MIDI track is created when you add a rack instrument.

- **Always**
A MIDI track is always created.
- **Do not**
No MIDI track is created.
- **Always ask to**
You are asked whether a corresponding MIDI track should be created.

Synchronize Plug-in Program Selection to Track Selection

Synchronizes track and plug-in program selection if you route multiple MIDI tracks to multitimbral instruments.

Suspend VST 3 plug-in processing when no audio signals are received

Suspends VST plug-in processing in passages where no audio is passing through the plug-in. This can improve system performance noticeably.

NOTE

We recommend to leave this option deactivated.

Plug-in Editors “Always on Top”

Always shows the control panels for effect plug-ins and VST instruments on top of other windows.

Video

Extract Audio on Import Video File

Extracts and saves the audio data of imported video files as a separate audio clip.

Thumbnail Memory Cache Size

Allows you to set the size of the thumbnail cache.

Index

A

- ACID® loops [410](#)
- Activate Extend Process Range
 - Direct Offline Processing [362](#)
- Activate Project [91](#)
- Activate tempo track [749](#)
- Adapt to Zoom [64](#)
 - Grid type [70](#)
- ADAT Lightpipe
 - Synchronization [772](#)
- Add Cycle Marker
 - Track Control [101](#)
- Add Latency to MIDI-Thru Processing [844](#)
- Add Marker
 - Track Control [101](#)
- Add Track dialog [104](#)
 - Audio tracks [105](#)
 - Folder tracks [126](#)
 - FX channel tracks [121](#)
 - Group channel tracks [118](#)
 - Instrument tracks [108](#)
 - MIDI tracks [115](#)
 - Ruler tracks [124](#)
 - Sampler tracks [112](#)
- Adding chords [706](#)
- AES/SPDIF Digital Audio
 - Synchronization [772](#)
- AIFF files [766](#)
- Algorithms
 - Limitations [371](#)
 - Time-stretching [370](#)
- All MIDI Inputs [23](#)
- Appearance
 - Colors [846](#)
 - Metering [843](#)
- Append Clip Name to Event Name [835](#)
- Archive
 - Prepare [94](#)
- Arranger track
 - Flattening [264](#), [267](#)
 - Inspector [129](#)
 - Track controls [131](#)
- ASIO Direct Monitoring [22](#), [216](#)
- ASIO Latency Compensation
 - Track Control [101](#)
- ASIO Latency Compensation Active by Default [844](#)
- ASIO-Guard [825](#)
- Aspect ratio
 - Video Player window [795](#)
- Assigning chords to Chord Pads [731](#)
- Assigning chords with the Chord Editor [731](#)
- Attribute Filter
 - Applying in the MediaBay [492](#)
 - Context menu search [492](#)
 - MediaBay [491](#)
- Attributes
 - MediaBay [491](#)
- Audio
 - Handling [154](#)
 - Zooming [65](#)
- Audio clock
 - Synchronization [772](#)
- Audio Connections [28](#)
 - Editing [32](#)
 - Presets [31](#)
- Audio events [153](#)
 - Auditioning [158](#)
- Audio Events
 - Inverting phase [173](#)
- Audio files
 - Previewing in MediaBay [487](#)
- Audio Files
 - Inverting phase [173](#)
- Audio Functions [372](#)
 - Detect Silence [372](#)
 - Spectrum Analyzer [376](#)
 - Statistics [378](#)
- Audio hardware
 - Connections [14](#)
 - Externally clocked [20](#)
- Audio Part Editor
 - Lower zone [55](#)
 - Toolbar [412](#)
- Audio parts
 - Auditioning [158](#)
 - Creating [157](#)
- Audio performance
 - Optimizing [823](#)
- Audio Pre-Record Seconds [844](#)
- Audio processing
 - Pool [462](#)
- Audio Processing
 - Direct Offline Processing [358](#)
- Audio Recording [219](#)
 - Pre-Record Time [221](#)
 - Preparations [218](#)
 - RAM Requirements [218](#)
 - Record File Format [217](#)
 - Record Folder [218](#)
 - Record Modes [219](#)
 - Recovering [221](#)
 - Recovering recordings [220](#)
 - Undo [220](#)
 - With Effects [220](#)
- Audio regions [155](#)
- Audio System [15](#)
- Audio tracks [105](#)
 - Add Track dialog [105](#)
 - Freezing [145](#), [336](#)
 - Inspector [107](#)
- Audition chords [711](#)

- Auditioning
 - Audio events 158
 - Audio parts 158
 - Using key commands 458
- Auto fades
 - Global settings 260
 - Track settings 260
- Auto Monitoring
 - Manual 848
 - Tapemachine Style 848
- Auto Save 93, 838
- Auto Save Internal 838
- Auto Select Controllers 643
- Auto Select Events under Cursor 828
- Auto Track/Channel Color Mode 847
- Auto-Scroll 200, 201
 - Crossfades 256
 - Suspend 201
- Automatable parameters
 - Controlling with Quick Controls 538
- Automatic Hitpoint Detection
 - Enabling 829
- Automatic scales 712
- Automatic voicings 715
- Automatically generating new audio clips
 - Pool 464
- Automation 500
 - Bézier curves 504
 - Data 640
 - Quick scaling 507
 - Ramp curves 500
 - Read 501
 - Recording actions 500
 - Smooth transitions 504
 - Static value line 501
 - Step curves 500
 - Write 500, 501
- Automation data
 - Editing 504
 - Removing 508
 - Selecting 505
- Automation Event Editor
 - Compress Left 505
 - Compress Right 505
 - Move Vertically 505
 - Scale Around Absolute Center 505
 - Scale Around Relative Center 505
 - Scale Vertically 505
 - Stretch 505
 - Tilt Left 505
 - Tilt Right 505
- Automation Follows Events 828
- Automation parameter
 - Track Control 101
- Automation Reduction Level 828
- Automation tracks 508
 - Assigning parameters 509
 - Hiding 508
 - Muting 509
 - Removing 508
 - Showing 508

B

- Back up Project 94
- Background Color Modulation 835
- Bank assignments 596
- Beat Calculator 753, 754
- Bézier curves
 - Automation 504
 - Continuous controllers 638
- Bounce Selection 154
- Broadcast Wave files 765
- Broadcast Wave Files
 - Embedded information 844
- Buffer
 - Settings 824
- Busses
 - Adding 30
 - Removing 32
- Bypass EQs
 - Track Control 101
- Bypass Inserts
 - Track Control 101
- Bypass Sends
 - Track Control 101

C

- Channel
 - Track Control 101
- Channel Configuration
 - Track Control 101
- Channel latency
 - MixConsole 314
- Channel racks 289, 298
 - EQ 303
 - Filters 301
 - Gain 301
 - Inserts 302
 - Phase 301
 - Pre 300
 - Routing 299
 - Sends 312
 - Strips 306
- Channel settings 315
 - Channel Faders 327
 - Channel Inserts 319
 - Channel Sends 326
 - Channel Strip 319–323
 - Copying 298
 - Equalizer 325
- Channel Settings
 - Toolbar 317
- Channel strip rack 306
 - Compressor 306
 - EQ position 306
 - Gate 306
 - Limiter 306
 - Presets 312
 - Saturation 306
 - Transformer 306
- Channel types
 - MixConsole 288

- Channels
 - Color 140
 - Linking 291
- Chase Events 208, 839
- Chord Assistant 708, 729
 - Assigning chords 731
 - Circle of Fifths 709, 729, 730
 - Detected 710
- Chord Editor 707
 - Assigning chords 731
 - MIDI Input 708
- Chord events 706
 - Adding 706
 - Adding chords 706
 - Auditioning 711
 - Chord type 706
 - Converting to MIDI 717
 - Creating from Audio Events 724
 - Creating from MIDI 722
 - Editing 706
 - Resolving Display Conflicts 712
 - Tension 706
 - Voicings 714
- Chord Font 836
- Chord Pad Controls 727
- Chord Pads 726–729
 - Adaptive voicing 738
 - Assigning chords 731–733
 - Context menu 728
 - Controls 729
 - Copying Assignments 733
 - Creating chord events 747
 - Creating MIDI parts 747
 - Functions menu 729
 - Multiple tracks 740
 - Pad Remote Control 742
 - Pads remote range 745
 - Pattern player 740
 - Player Modes 737–739
 - Player Setup 737
 - Players 738
 - Playing back 734
 - Presets 746
 - Recording chords 736
 - Saving presets 746
 - Setting up 729
 - Swapping Assignments 733
 - Voicings 738
 - Zone 729
- Chord Pads Setup
 - Pad layout 745
 - Remote Control 741
- Chord Pads Zone 726
- Chord symbols 836
- Chord track 131, 705
 - Assign Pads 733
 - Controlling MIDI or audio playback 719
 - Inspector 132
 - Live input 719
 - Track controls 133
- Chord voicing
 - Changing 667
- Chords
 - Changing pitch 667
 - Changing voicing 667
 - Editing 668
 - Inserting 669
- Circle of Fifths 709
- Click Sounds
 - Custom Sounds 207
- Clip editing
 - Pool 458
- Clips
 - Renaming 452
- Color
 - Auto Track/Channel Color Mode 140
- Color Picker 80
- Color Set 78
- Colorize Track Controls 847
- Colorizing
 - Events 76
 - Note events 615
 - Select Color for Selected Tracks or Events 74, 76
 - Single Tracks 75
 - Tracks 74
- Colors
 - MixConsole Channels 313
 - Preferences 846
 - Tracks 76, 77
 - User Interface 847
- Colors Setup Dialog
 - Events 616
 - Project 77
- Compress Left
 - Automation Event Editor 505
- Compress Right
 - Automation Event Editor 505
- Compressor
 - Strip module 306
- Connect Sends automatically for each newly created Channel 848
- Connecting
 - Audio 14
 - MIDI 22
- Constrain Delay Compensation 523
- Continuous controllers
 - Adding in controller display 637
 - Controller display 629
 - Controller lane 638
 - Ramp/Step 638
 - Smooth transitions 638
- Control link 291
- Controller Brightness 837
- Controller curves
 - Smart controls for scaling 642
- Controller Data
 - Thinning Out 612
- Controller display 623
 - Adding events 632, 637
 - Continuous controllers 629
 - Editing events with Line tool 640
 - Moving events 643
- Controller Event Editor 642

- Controller lane
 - Adding [628](#)
 - Continuous controllers [638](#)
 - Presets [631](#)
 - Removing [628](#)
 - Selecting event types [629](#)
 - Setting up as preset [631](#)
 - Controller lanes [626](#)
 - Setup [625](#)
 - Controller Selection and Functions [626](#)
 - Controllers
 - Selecting [643](#)
 - Showing [837](#)
 - Convert to Real Copy [172](#)
 - Converting chord events to MIDI [717](#)
 - Create Audio Images during Record [844](#)
 - Create Chord Events [722](#), [724](#)
 - Create MIDI track when loading VSTi [849](#)
 - Creating chord events from Audio Events [724](#)
 - Creating chord events from MIDI [722](#)
 - Cross-hair cursor [72](#), [834](#)
 - Crossfades
 - Auto Zoom [256](#)
 - Auto-Scroll [256](#)
 - Creating [255](#)
 - Editing in dialog [256](#)
 - Equal Gain [256](#)
 - Equal Power [256](#)
 - Presets [256](#)
 - Simple Crossfade Editor [256](#)
 - Symmetric Fades [256](#)
 - Cursor Width [845](#)
 - Custom Chord Symbols [836](#)
 - Customizing
 - Colors [80](#)
 - Info line [817](#)
 - Inspector [817](#)
 - Meter Colors [296](#)
 - Toolbars [817](#)
 - Transport panel [817](#)
 - User Interface Colors [847](#)
 - Cycle
 - Track Control [101](#)
 - Cycle Follows Range Selection [828](#)
 - Cycle markers [270](#)
 - Editing with tools [271](#)
 - Using [271](#)
 - Zooming [67](#), [271](#)
 - Cycle recording [213](#)
- D**
- Data on Folder Tracks
 - Showing [837](#)
 - DC Offset
 - Removing [365](#)
 - Default MIDI Editor [834](#)
 - Delay compensation
 - Constraining [523](#)
 - Threshold for Recording [848](#)
 - Delete Notes
 - Dialog [620](#)
 - Delete Overlaps [828](#)
 - Deleting
 - Continuous Controllers [611](#)
 - Controllers [611](#)
 - Doubles [610](#)
 - MIDI controllers [611](#)
 - Deleting Overlaps
 - Poly (MIDI) [609](#)
 - Poly (Mono) [609](#)
 - Designating a new pool record folder
 - Pool [461](#)
 - Detect Silence
 - Audio Functions [372](#)
 - With current settings [375](#)
 - Device ports
 - Selecting for busses [30](#)
 - Direct Offline Processing [358](#)
 - Applying [361](#)
 - Applying to multiple events [362](#)
 - Deleting [362](#)
 - Envelope [363](#)
 - Extend Process Range [362](#)
 - Fade In [364](#)
 - Fade Out [364](#)
 - Gain [364](#)
 - Invert Phase [365](#)
 - Key Commands [368](#)
 - Modifying [362](#)
 - Normalize [365](#)
 - Pool [462](#)
 - Remove DC Offset [365](#)
 - Resample [366](#)
 - Resetting [362](#)
 - Reverse [366](#)
 - Silence [366](#)
 - Stereo Flip [366](#)
 - Time Stretch [367](#)
 - Toolbar [360](#)
 - Window [359](#)
 - Workflow [359](#)
 - Disable Acoustic Feedback during Playback [830](#)
 - Display format
 - Ruler [44](#)
 - Dithering
 - Applying [346](#)
 - Effects [346](#)
 - Divider
 - Project window toolbar [42](#)
 - Drag Delay [828](#)
 - Draw tool
 - Drawing note events [663](#)
 - Drum Editor [685](#)
 - Info line [693](#)
 - Lower zone [55](#)
 - Note display [694](#)
 - Status line [692](#)
 - Toolbar [687](#)
 - Drum Map
 - Track Control [101](#)
 - Drum maps [699](#), [702](#)
 - Key Editor [670](#)
 - Selecting [696](#)
 - Setting up [700](#), [701](#)

- Drum notes
 - Deleting [698](#)
- Drum sounds [695](#)
 - Changing the Note Length [698](#)
 - Setup [695](#)
 - Visibility [696](#)
- Drum Sounds
 - Settings [701](#)
- Drum Visibility Agents [687](#)
- Duplicating
 - Events [171](#)
- E**
- Edit Channel Settings
 - Track Control [101](#)
- Edit History dialog [73](#)
- Edit Instrument
 - Track Control [101](#)
- Editing
 - Project window info line [46](#)
- Editor Content Follows Event Selection [834](#)
- Effect parameters
 - Track Quick Controls [536](#)
- Effect Plug-in Presets
 - Loading in MediaBay [495](#)
- Effects [329](#)
 - Comparing settings [349](#)
 - Context menu [348](#)
 - Control panel [347](#)
 - Direct Offline Processing [358](#)
 - Dithering [346](#)
 - Functions menu [348](#)
 - Insert effects [329](#), [331](#)
 - Plug-in delay compensation [331](#)
 - Pre/Post fader sends [341](#)
 - Presets [350](#)
 - Presets browser [351](#)
 - Routing [340](#)
 - Saving presets [352](#)
 - Selecting presets [351](#)
 - Send effects [329](#), [337](#)
 - Side-chain inputs [342](#)
 - Side-chain routing [344](#)
 - System component information [355](#), [357](#)
 - Tempo sync [331](#)
 - Track presets [355](#)
 - VST 3 [330](#)
- Enable Record on Selected Audio Track [832](#)
- Enable Record on Selected MIDI Track [832](#)
- Enable Solo on Selected Track [832](#)
- Enharmonic shift [683](#)
- Enlarge Selected Track [142](#), [832](#)
- Envelope
 - Direct Offline Processing [363](#)
- Envelope editor
 - Sampler Control [433](#)
- EQ
 - Channel racks [303](#)
 - Presets [305](#)
- EQ position
 - Strip module [306](#)
- Equal Gain
 - Crossfades [256](#)
- Equal Power
 - Crossfades [256](#)
- Equalizer settings [325](#)
- Event Details
 - Showing [837](#)
- Event display [43](#)
 - Folder tracks [147](#)
 - Modifying on folder tracks [147](#)
- Event Handling Opacity [834](#)
- Event lengths
 - Changing with Trim tool [666](#)
- Event name
 - Showing [834](#)
- Event Opacity [834](#)
- Event Volume Curves
 - Showing [835](#)
- Events [153](#)
 - Copying and Pasting [170](#)
 - Creating new files from events [154](#)
 - Displaying on folder tracks [147](#)
 - Duplicating [171](#)
 - Editing [158](#)
 - Gluing [170](#)
 - Move [164](#)
 - Moving [161](#)
 - Moving the contents [173](#)
 - Moving via info line [165](#)
 - Moving with Nudge [162](#)
 - Moving with Object Selection [161](#)
 - Muting [174](#)
 - Normal resizing [165](#)
 - Pasting [170](#)
 - Removing [161](#)
 - Renaming [165](#)
 - Repeating [171](#)
 - Resizing [165](#), [167](#)
 - Resizing with Object Selection [165](#), [166](#)
 - Resizing with Scrub [168](#)
 - Size with Fade [165](#)
 - Sizing Applies Time Stretch [166](#)
 - Sizing Moves Contents [166](#)
 - Splitting [169](#)
 - Splitting repeatedly [170](#)
- Export Audio Mixdown [757](#), [764](#)
 - AIFF files [766](#)
 - Broadcast Wave files [765](#)
 - File Formats [764](#)
 - Flac files [768](#)
 - MP3 files [767](#)
 - Ogg Vorbis files [769](#)
 - Wave files [765](#)
- Export Video [797](#)
- Export Video dialog [798](#)
- Exporting
 - MIDI files [137](#)
 - Video files [799](#)
- Extending the Process Range
 - Direct Offline Processing [362](#)
- External monitoring [215](#)
- Extract Audio on Import Video File [850](#)

- Extracting
 - Audio from video [236](#), [800](#)
 - MIDI Automation [612](#)
- F**
- Fade Handle Brightness [835](#)
- Fade In
 - Direct Offline Processing [364](#)
- Fade In dialog [252](#)
- Fade Out
 - Direct Offline Processing [364](#)
- Fade Out dialog [252](#)
- Fader section (MixConsole) [293](#)
- Fades
 - Auto fades [258](#)
 - Editing in dialog [252](#)
 - Presets [252](#)
 - With Range Selection tool [252](#)
- Favorites
 - Adding [475](#), [476](#), [481](#)
 - Media rack [474](#)
- File Browser
 - Media rack [474](#)
- File Extensions
 - Showing in Results list [842](#)
- Fill Loop [173](#)
- Fixed lengths [607](#)
- Fixed tempo
 - Mode [748](#)
- Fixed Tempo
 - Mode [752](#)
 - Setting up [752](#)
- Fixed velocity [607](#)
- Flac files [768](#)
- FLAC files
 - Importing [233](#)
- Flattening
 - Arranger track [264](#), [267](#)
- Focus Quick Controls
 - Focus lock [564](#)
 - Focus setup [563](#)
 - Setting up [563](#)
- Folder parts [158](#)
- Folder tracks [126](#)
 - Add Track dialog [126](#)
 - Displaying events [147](#)
 - Inspector [128](#)
 - Modifying event display [147](#)
 - Track controls [128](#)
- Follow Chord Track [720](#)
 - Auto [720](#)
 - Chords [720](#)
 - Directly [721](#)
 - Scale events [721](#)
 - Single Voice [720](#)
 - Synchronizing Track Data [721](#)
 - Using [719](#)
- Frame count [771](#)
- Frame rates
 - Mismatch [793](#)
 - Synchronization [771](#)
 - Video [793](#)
- Freeze
 - Multiple tracks [145](#)
 - Sampler tracks [442](#)
 - VST instruments [520](#)
- Freeze Channel
 - Track Control [101](#)
- Freeze Channel Options
 - Sampler tracks [442](#)
 - VST instruments [521](#)
- Freeze MIDI Modifiers [594](#)
- FX chain presets [302](#)
- FX Chain Presets
 - Loading in MediaBay [495](#)
- FX channel tracks [121](#)
 - Add Track dialog [121](#)
 - Adding [338](#), [339](#)
 - Inspector [123](#)
- FX Plug-in Presets
 - Loading in MediaBay [495](#)
- G**
- Gain
 - Direct Offline Processing [364](#)
- Gate
 - Strip module [306](#)
- Generic Remote [583](#)
- Global Meter Settings [295](#)
- Global track controls [43](#)
- Gluing
 - Events [170](#)
- Grid Overlay Intensity [834](#)
- Grid type
 - Project window [70](#), [71](#)
- Groove quantizing [245](#)
- Group channel tracks [118](#)
 - Add Track dialog [118](#)
 - Inspector [120](#)
- Group channels
 - Adding insert effects [333](#)
 - Adding to selected channels [333](#)
- Group Channels - Mute Sources as well [848](#)
- H**
- Hardware controls
 - Activating pick-up mode [582](#)
- Hardware setup
 - Control panel [15](#)
- Hermod tuning [592](#)
- Hide muted Notes in Editors [830](#)
- Hide Truncated Event Names [834](#)
- High Quality Scrub Mode [846](#)
- History
 - Edit History [73](#)
 - Project window [36](#)
- Hitpoints [398](#)
 - Showing [835](#)
- HMT Type
 - Hermod tuning [593](#)
- Horizontal zoom
 - Sample Editor [390](#)

- Hub [82](#)
 - Deactivating [83](#)
 - Using [838](#)
- I**
- I-notes (Input notes) [702](#)
- Importing
 - Audio files [233](#)
 - Audio from video files [236](#)
 - Compressed audio files [233](#)
 - FLAC files [233](#)
 - MIDI files [137](#), [238](#)
 - MP3 files [233](#)
 - MPEG files [233](#)
 - Ogg Vorbis files [233](#)
 - REX/REX2 files [237](#)
 - Video files [792](#)
 - WMA files [233](#)
- Independent track loop
 - Audio Part Editor [418](#)
- Independent Track Loop
 - MIDI [623](#)
- Info line
 - Project window [46](#)
 - Score Editor [676](#)
- Input busses
 - Adding [30](#)
 - Removing [32](#)
 - Renaming [29](#)
 - Routing [300](#)
- Input gain
 - MixConsole [301](#)
- Input levels [14](#)
- Input ports [21](#)
- Inputs
 - Meter position options [295](#)
- Insert effects [329](#), [331](#)
 - Adding to busses [332](#)
 - Adding to group channels [333](#)
 - Freezing [336](#)
 - Routing [332](#)
- Insert MIDI Retrospective Recording in Editor [229](#)
- Insert presets
 - Copying [353](#)
 - Pasting [353](#)
 - Saving [354](#)
- Insert Reset Events after Record [839](#)
- Inserts
 - FX chain presets [302](#)
 - MixConsole [302](#)
 - Using while scrubbing [846](#)
- Inspector [48](#)
 - Editor [50](#)
 - Sections [98](#)
 - Track Inspector [49](#)
- Inspector Sections
 - Showing/Hiding [51](#)
- Instrument
 - Track Control [101](#)
- Instrument Freeze [520](#)
- Instrument parameters
 - Track Quick Controls [536](#)
- Instrument presets
 - Applying [149](#)
- Instrument Presets
 - Loading in MediaBay [494](#)
 - Results [519](#)
- Instrument tracks [108](#)
 - Add Track dialog [108](#)
 - Freezing [145](#)
 - Inspector [110](#)
 - Unfreeze Channel Options Dialog [522](#)
- Instruments use Automation Read All and Write All [848](#)
- Interpolate Audio Waveforms [835](#)
- Invert Phase
 - Direct Offline Processing [365](#)
 - Info line [173](#)
 - MixConsole [301](#)
- K**
- Key commands [801](#)
 - Default [805](#)
 - Dialog [801](#)
 - Loading [804](#)
 - Modifying [803](#)
 - Removing [804](#)
 - Resetting [804](#)
 - Saving [804](#)
 - Searching for [803](#)
- Key Editor [643](#)
 - Fold keyboard [656](#)
 - Info line [651](#)
 - Inspector [652](#)
 - Lower zone [55](#)
 - Note display [654](#)
 - Piano keyboard display [655](#)
 - Pitch Visibility [657](#)
 - Scales [653](#)
 - Status line [651](#)
 - Toolbar [645](#)
 - Visible Pitches [656](#)
- Keyboard focus
 - Activating for a zone [63](#)
 - Zones [63](#)
- Keyboard navigation
 - MixConsole [327](#)
- Knob Mode [830](#)
- L**
- Lanes
 - Audio Part Editor [417](#)
- Language (Preferences) [838](#)
- Latency
 - MixConsole [314](#)
 - Optimizing [823](#)
 - VST System Link [782](#)
- Left locator
 - Setting [198](#)
- Left Locator [197](#)
- Left zone [47](#)
 - Inspector [48](#)
 - MixConsole [283](#)

- Legato [607](#)
 - Legato Mode - Between Selected Notes Only [831](#)
 - Legato Overlap [831](#)
 - Length Adjustment [839](#)
 - Level meters (MixConsole) [297](#)
 - Limiter
 - Strip module [306](#)
 - Line tool [665](#)
 - Drawing note events [664](#)
 - Editing controller display events [640](#)
 - Link groups [291](#)
 - Q-Link [291](#)
 - Link to Grid
 - Nudge Settings [163](#)
 - Link to Primary Time Format
 - Nudge Settings [163](#)
 - Live input
 - Chord track [719](#)
 - Loading Multi-Track Presets [151](#)
 - Locate
 - Track Control [101](#)
 - Locate When Clicked in Empty Space [845](#)
 - Locator Range Duration [199](#)
 - Locators [197](#)
 - Setting ranges [199](#)
 - Lock Record [230](#)
 - Looping
 - Audio Part Editor [418](#)
 - Loops and Samples
 - Loading in MediaBay [493](#)
 - Loudness
 - Statistics [378](#)
 - Lower zone [52](#)
 - Chord Pads [53](#)
 - Editor [55](#)
 - MIDI Remote [57](#), [540](#)
 - MixConsole [54](#)
 - Sampler Control [54](#)
 - Selecting a MIDI editor [56](#)
 - Setting up [52](#)
- ## M
- macOS
 - Port activation [30](#)
 - Port selection [30](#)
 - Main mix
 - Setting up [30](#)
 - Managing media files
 - Pool [446](#)
 - Map Input Bus Metering to Audio Track [843](#)
 - Mapping Assistant
 - MIDI Remote [556](#)
 - Mapping Pages
 - MIDI Remote [561](#)
 - Mapping Scopes
 - MIDI Remote [561](#)
 - Marker lines [270](#)
 - Marker track [134](#), [275](#)
 - Inspector [134](#)
 - Track controls [135](#)
 - Markers [270](#)
 - Attributes [274](#)
 - Cycle markers [270](#)
 - Exporting [277](#)
 - Exporting via MIDI [278](#)
 - IDs [275](#)
 - Importing [277](#)
 - Importing via MIDI [277](#)
 - Markers window [271](#)
 - Position markers [270](#)
 - Reassigning IDs [275](#)
 - Sync to selection in Project window [271](#)
 - Markers window [271](#)
 - Adding markers [273](#)
 - Editing markers [273](#)
 - Marker list [273](#)
 - Max. Record Time Display [230](#)
 - Maximizer
 - Details view [323](#)
 - Edit Module [323](#)
 - Maximum Backup Files [838](#)
 - Maximum Items in Results List [842](#)
 - Maximum Undo Steps [838](#)
 - Media rack
 - Adding Favorites [475](#), [476](#)
 - Adding VST plug-in pictures [476](#), [477](#)
 - Favorites [468](#), [474](#)
 - File Browser [469](#), [474](#)
 - Home [466](#)
 - Results [468](#)
 - Right zone [60](#), [62](#)
 - Right Zone [466](#), [468](#)
 - Track Presets [475](#)
 - VST Effects [472](#), [474](#)
 - VST Instruments [471](#), [474](#)
 - MediaBay [466](#)
 - Adding Favorites [481](#)
 - Attribute Filter [491](#), [492](#)
 - Attributes [491](#)
 - File Browser [480](#)
 - Filters [491](#)
 - Finding file locations [484](#)
 - Hiding sections [480](#)
 - Instrument Presets [519](#)
 - Media Type Filter [484](#)
 - Media Types [485](#)
 - Previewer [487](#)
 - Rating filter [486](#)
 - Refresh Views [482](#)
 - Reset Filter [493](#)
 - Results [482](#), [483](#), [487](#)
 - Scanning [481](#)
 - Select Media Type [484](#)
 - Settings [498](#)
 - Show in Explorer/Reveal in Finder [484](#)
 - Showing sections [480](#)
 - Shuffle Results [484](#)
 - Text search [486](#)
 - Toolbar [478](#)
 - Using Media Files [493](#)
 - Volume databases [496](#), [498](#)
 - Window [477](#)

- MediaBay results
 - Managing media files [483](#)
 - Resetting [487](#)
 - Setting up [483](#)
 - Shuffling [484](#)
- Merge MIDI in Loop [603](#), [604](#)
- Metadata
 - Author Name [839](#)
 - Company Name [839](#)
- Meter Colors [296](#)
- Meter peak options [295](#)
 - Hold forever [295](#)
 - Hold peaks [295](#)
- Meter position options [295](#)
 - Input [295](#)
 - Post-Fader [295](#)
 - Post-Panner [295](#)
- Meters
 - Settings [295](#)
- Meters' Fallback [843](#)
- Meters' Peak Hold Time [843](#)
- Metronome [203](#), [205](#), [206](#)
 - Setup window [203](#)
- Metronome Setup [203](#)
 - Click Sounds [206](#)
 - General [205](#)
- MIDI
 - Delete notes [620](#)
- MIDI channels
 - Separating for drum map sounds [702](#)
- MIDI clock
 - Synchronization [772](#)
- MIDI Controller Scripts
 - MIDI Remote [547](#)
- MIDI Controller Settings
 - MIDI Remote [556](#)
- MIDI Controller Surface
 - Adding [550](#)
 - Editing [553](#)
 - MIDI Remote [546](#), [549](#), [551](#)
- MIDI controllers [540](#)
 - MIDI Remote Manager [566](#)
 - Using with MIDI Remote [545](#)
- MIDI Controllers
 - Pitchbend [633](#)
- MIDI devices
 - Defining new for patch selection [601](#)
 - Device Manager [596](#)
 - Editing patches [601](#)
 - Installing [600](#)
 - Selecting patches [600](#)
- MIDI Display Resolution [839](#)
- MIDI editors
 - Cutting and pasting [615](#)
- MIDI events [156](#)
- MIDI Export Options [840](#)
- MIDI files [137](#), [238](#)
 - Previewing in MediaBay [488](#)
- MIDI Filter [842](#)
- MIDI Import Options [840](#), [841](#)
- MIDI Input
 - Chord Editor [708](#)
- MIDI Inputs
 - Setting up [223](#)
- MIDI interface
 - Connecting [22](#)
- MIDI Latency Mode [839](#)
- MIDI Loops
 - Previewing in MediaBay [489](#)
- MIDI Max. Feedback in ms [839](#)
- MIDI Merge Options [604](#)
- MIDI modifiers [589](#)
 - Hermode tuning [592](#), [593](#)
 - Random variations [591](#)
 - Range [592](#)
- MIDI note numbers [701](#)
- MIDI notes
 - Transpose (function) [602](#)
- MIDI pan
 - MIDI track parameters [589](#)
- MIDI part data
 - Automation [640](#)
- MIDI parts
 - Creating [157](#)
 - Handling several [622](#)
 - Independent Track Loop [623](#)
 - Processing [614](#)
- MIDI Port Setup [222](#)
- MIDI ports
 - Setting up [23](#)
- MIDI Record Catch Range in ms [844](#)
- MIDI Record Mode [226](#)
- MIDI Recording
 - Channel and Output [223](#)
 - Continuous messages [225](#)
 - Different types of messages [225](#)
 - Instruments and channels [222](#)
 - MIDI Input setting [223](#)
 - Naming MIDI ports [222](#)
 - Notes [225](#)
 - Preparations [222](#)
 - Program Change Messages [225](#)
 - Record mode [226](#)
 - Recovering [228](#)
 - Recovering in Editor [229](#)
 - Recovering recordings [227](#)
 - Reset [226](#)
 - Sound selection [223](#)
 - SysEx Messages [226](#)
- MIDI recordings
 - Exporting to MIDI file [703](#)
- MIDI Remote [540](#)
 - Adding MIDI Controller Surfaces [546](#), [550](#)
 - API [571](#)
 - Deleting Scripts [569](#)
 - Disabling Scripts [569](#)
 - Editing MIDI Controller Surfaces [546](#), [549](#)
 - Focus Quick Controls [562](#), [563](#)
 - Importing MIDI Controller Scripts [547](#)
 - Info line [541](#)
 - Lower zone [57](#)
 - Mapping Assistant [556](#)
 - Mapping Pages [561](#)
 - MIDI Controller Settings [556](#)
 - MIDI Controller Surface Editor [551](#), [553](#), [554](#)

- MIDI Remote (*continued*)
 - Parameter Mapping 548
 - Quick Control Focus 563, 564
 - Script files 547
 - Scripting 571
 - Using Other MIDI Controllers 545
 - Using Supported MIDI Controllers 545
 - MIDI Remote Manager 564
 - MIDI controllers 566
 - Scripts 567
 - MIDI Remote Mapping Assistant 548
 - MIDI Remote Script Console 570
 - MIDI Retrospective Recording 227
 - MIDI Thru Active 839
 - Monitoring 217
 - MIDI track delay
 - MIDI track parameters 589
 - MIDI track parameters 589
 - MIDI tracks 115
 - Add Track dialog 115
 - Freezing MIDI Modifiers 594
 - Inspector 116
 - MIDI Velocity
 - Editing 609
 - MIDI volume
 - MIDI track parameters 589
 - Mirror
 - MIDI 613
 - Missing ports
 - Re-routing 92
 - MixConsole 279
 - Channel linking 291
 - Channel racks 289
 - Channel types 288
 - EQ presets 305
 - Fader section 293
 - FX chain presets 302
 - Left zone 283
 - Left Zone 283
 - Level meters 297
 - Lower zone 54
 - Mute 294
 - Notepad 313
 - Opening 279
 - Panning 294
 - Pictures 313
 - Pre rack 300
 - Racks 298
 - Setting volume 295
 - Solo 294
 - Solo Defeat 294
 - Strip presets 312
 - Toolbar 284
 - Visibility 283
 - MixConsole in Project Window 54
 - Mixing down to audio files 764
 - Modifier keys 816
 - Monitor
 - Track Control 101
 - Monitoring 22, 215
 - ASIO Direct Monitoring 216
 - External 215
 - Monitoring (*continued*)
 - MIDI 217
 - Via Cubase 215
 - Mouse Wheel for Event Volume and Fades 829
 - Move Vertically
 - Automation Event Editor 505
 - Moving
 - Events 161
 - Moving tracks 139
 - MP3 files 767
 - Importing 233
 - MPEG files
 - Importing 233
 - Multi processing 824
 - Musical Mode 410
 - Musical Scales
 - Finding 659, 660
 - Key Editor 653
 - Live Input 661
 - Quantize Pitches 661
 - Setup 713
 - Snap Pitch Editing 662
 - Mute
 - MixConsole 294
 - Track Control 101
 - Mute Automation
 - Track Control 101
 - Mute Pre-Send when Mute 848
 - Muting events 174
- ## N
- Name
 - Track Control 101
 - Naming schemes
 - Export Audio Mixdown 761, 763
 - Navigating
 - MixConsole 327
 - Never Reset Chased Controllers 839
 - Normalize
 - Direct Offline Processing 365
 - Maximum peak level 365
 - Note Brightness 837
 - Note display
 - Drum Editor 694
 - Enharmonic Shift 683
 - Key Editor 654
 - Note events
 - Colorizing 615
 - Creating in Score Editor 681
 - Deleting 620, 663
 - Drawing with Draw tool 663
 - Drawing with Line tool 664
 - Duplicating 621, 682
 - Editing 621
 - Editing via MIDI 670
 - Excluding from playback 620
 - Gluing 667, 683
 - Inserting 663
 - Moving 665
 - Muting 620
 - Repeating 621
 - Resizing 666

Note events (*continued*)

- Selecting 618
- Setting values 681
- Setting velocity values 622
- Setting with Snap 622
- Splitting 667, 683
- Transposing 665
- Trimming 621

Note lengths

- Changing 682

Note stems

- Flipping the direction 683

Note values

- Setting 681

Notepad

- MixConsole 313

Nudge

- Move Left 162
- Move Right 162
- Nudge Settings 162, 163, 168
- Resizing Events 167, 168
- Resizing Selection Ranges 176
- Snap Grid 163

O

O-notes (Output notes) 702

Object Selection tool

- Inserting note events 663

Ogg Vorbis files 769

- Importing 233

On Import Audio Files 829

On Processing Shared Clips 829

On-Screen Keyboard 209

- Computer keyboard 210
- Modulation 210
- Note velocity level 210
- Octave offset 210
- Options 210
- Piano keyboard 210
- Pitchbend 210
- Recording MIDI 209

Open Effect Editor after Loading it 849

Open/Close Sampler

- Track Control 101

Organizing files in subfolders

- Pool 462

Output

- Track Control 101

Output busses

- Adding 30
- Default 30
- Removing 32
- Renaming 29
- Routing 300

Output ports 21

Overlapping Audio 146

Overlaps

- Showing 834

Overview line

- Project window 47

P

Panning

- Bypass 294
- MixConsole 294

Part Data Mode 837

Parts 153, 157

- Editing 158
- Folder 158
- Moving the contents 173

Parts Get Track Names 828

Paste at Origin 170

Paste Relative to Cursor 170

Patch Banks 596

Pattern

- Chord Pads 737

Pedals

- To note length 608

Performance

- Aspects 823
- Audio performance 824
- Optimizing 823

Phase

- MixConsole 301

Piano keyboard display

- Key Editor 655

Piano voicings 715

Pick-up Mode 582

Pictures 141

- MixConsole 313
- Track list 140

Pitch

- Changing for chords 667

Pitch Notation 836

Pitch Visibility

- Key Editor 656
- Options 657

Pitchbend

- Controller lanes 633

Plain Chords

- Chord Pads 737

Playback

- Disable Acoustic Feedback 830
- Excluding note events 620

Playback Toggle triggers Local Preview 368, 845

Player Modes

- Pattern 739
- Plain Chords 738

Plug-in delay compensation 331

Plug-in Editors Always on Top 849

Plug-in latency

- MixConsole 314

Plug-in processing

- Suspending 330

Poly Pressure events

- Adding 636
- Editing 637

Polyphony

- Restricting 611

Pool

- Applying different processing methods 452
- Audio processing 462
- Automatically generating new audio clips 464

- Pool (*continued*)
 - Clip editing 458
 - Designating a new pool record folder 461
 - Key commands 458
 - Managing large sound databases 456
 - Managing media files 446
 - Organizing files in subfolders 462
 - Reducing the project size 462
 - Reference file 446
 - Renaming clips and regions 452
 - Resolve missing files dialog 457
 - Sampler tracks 446
 - Toolbar 449
 - Position markers 270
 - Post fader sends 341
 - Post-roll
 - Transport panel 202
 - Pre fader sends 341
 - Pre-Record time
 - Audio recording 221
 - Pre-roll
 - Transport panel 202
 - Preferences
 - Colors 846
 - Dialog 827
 - Disabling 821, 822
 - Saving presets 828
 - Store marked preferences only 828
 - Presets
 - Previewing in MediaBay 490, 491
 - Previewing using a MIDI file 490
 - Previewing using the Memo Recorder 490
 - Previewing via MIDI Input 490
 - Previewing via the Computer Keyboard 491
 - Presets browser
 - Effects 351
 - Primary Time Format
 - Selecting 201
 - Programs
 - Track Control 101
 - Project Assistant 83
 - Project Colors Setup
 - Color Set 78
 - Options 80
 - Presets 79
 - Project Colors Setup Dialog 77-80
 - Project Setup Dialog 88
 - Project Synchronization Setup 773
 - Destinations 777
 - Sources 775
 - Project window
 - Event display 43
 - Global track controls 43
 - History 36
 - Info line 46
 - Inspector 48
 - Keyboard focus 63
 - Left zone 47
 - Lower zone 52-55, 57
 - Overview 34
 - Overview line 47
 - Project zone 35
 - Right zone 58
 - Project window (*continued*)
 - Ruler 44
 - Showing/Hiding Zones 35
 - Snap 68
 - Snap to zero crossing 68
 - Status line 46
 - Toolbar 36
 - Toolbox 42
 - Track list 42
 - Transport Bar 47, 190
 - Transport pop-up window 195
 - Zoom presets 66
 - Zoom submenu 65
 - Zooming 64
 - Project zone 35
 - Event display 43
 - Global track controls 43
 - Ruler 44
 - Toolbar 36
 - Track list 42
 - Projects
 - Activating 91
 - Back up 94
 - Creating new 82, 83
 - Hub 82
 - Location 93
 - Missing ports 92
 - Opening 91
 - Opening recent 92
 - Prepare archive 94
 - Project Assistant 83
 - Project files 84
 - Revert 93
 - Saving 92
 - Saving templates 87
 - Setting up 88
 - Template files 85
 - Templates 85
 - Punch In 203
 - On Stop 843
 - Punch In/Out
 - Common Record Modes 214
 - Punch Out 203, 213
 - Stop after automatic 843
 - Punch Points 203
- ## Q
- Q-Link 291
 - QC Learn Mode
 - Track Quick Controls 536
 - Quantize Panel 243
 - Quantizing to a grid 245
 - Quantizing to a groove 247
 - Quantize value 681
 - Quantizing 240
 - Catch Range 245
 - Original position 247
 - Pre-Quantize 247
 - Swing 245
 - Tuplets 245
 - Using groove presets 245

- Quick Controls
 - Focus lock [564](#)
 - Focus setup [563](#)
 - MIDI Remote [562](#)
- Quick Zoom [828](#)

- R**
- Rack settings [290](#)
 - Copying [298](#)
- Racks
 - MixConsole [298](#)
- RAM
 - Recording [218](#)
- Ramp/Step
 - Continuous controllers [638](#)
- Range Editing [175](#)
- Range Selection tool [175](#)
 - Creating fades [252](#)
- Re-Record
 - Activating [214](#)
 - Common Record Modes [214](#)
- Read automation [501](#)
- Read Automation
 - Track Control [101](#)
- Recent projects [92](#)
- Record Enable
 - Track Control [101](#)
- Record File Format
 - Audio [217](#)
- Record Folder
 - Audio [218](#)
- Record-Enable allows MIDI Thru [844](#)
- Recording [211](#)
 - Common Record Modes [214](#)
 - Cycle [213](#)
 - Levels [14](#)
 - Lock Record [230](#)
 - Remaining Record Time [230](#)
 - Stopping [213](#)
 - Stopping automatically [213](#)
 - With Effects [220](#)
- Recovering recordings
 - Audio [220](#)
 - MIDI [227](#)
- ReCycle files [237](#)
- Reducing the project size
 - Pool [462](#)
- Reference file
 - Pool [446](#)
- Refresh Views
 - MediaBay [482](#)
- Regions
 - Creating with Detect Silence [375](#)
 - Event or Range as Region [156](#)
 - Events from Regions [156](#)
 - Renaming [452](#)
- Remote control [572](#)
 - Assigning commands [576](#)
 - Automation [575](#)
 - Connections [572](#)
 - Control Assignment [586](#)
 - Generic Remote [583](#)
- Remote control (*continued*)
 - Global Options [575](#)
 - MIDI Port Setup [572](#)
 - MIDI remote control configuration [584](#)
 - Remote Control Editor [577](#)
 - Resetting [574](#)
 - Setting up [573](#)
- Remote Control Editor [577](#)
 - Control settings [578](#)
 - Layout [580](#)
 - Parameter assignment [580](#)
 - Toolbar [578](#)
- Remote Controllers
 - Connecting Track Quick Controls [581](#)
- Remove DC Offset
 - Direct Offline Processing [365](#)
- Remove Regions/Hitpoints on all Offline Processes [829](#)
- Removing
 - Events [161](#)
 - Silence [375](#)
- Renaming
 - Clips [452](#)
 - Events [165](#)
 - Regions [452](#)
 - Tracks [140](#)
- Repeat Events [171](#)
- Repeat Loop [606](#)
- Replace Recording in Editors [844](#)
- Resample
 - Direct Offline Processing [366](#)
- Reset on Stop [839](#)
- Resizing events [165](#)
- Resolve Display Conflicts
 - Track Control [101](#)
- Retrospective MIDI Recording [228](#), [229](#)
 - Empty Buffer [230](#)
 - Insert from All MIDI Inputs [228](#)
- Retrospective Record [844](#)
- Retrospective Record Buffer [227](#)
- Retrospective Recording
 - Buffer [227](#)
 - MIDI [227](#)
- Return to Start Position on Stop [845](#)
- Reverse
 - Audio [366](#)
 - Direct Offline Processing [366](#)
 - MIDI [612](#)
- REX/REX2 files
 - Importing [237](#)
 - Loading into Sampler Control [421](#)
- Right locator
 - Setting [199](#)
- Right Locator [197](#)
- Right zone [58](#)
 - Media rack [60](#), [62](#), [466](#), [469](#), [471](#), [472](#)
 - VSTi rack [59](#)
- Root Key
 - Sampler Control [439](#)
- Routing
 - Input busses [300](#)
 - Insert effects [332](#)
 - MixConsole [299](#)
 - Output busses [300](#)

- Ruler
 - Display format [44](#)
 - Project window [44](#)
 - Timeline [614](#)
- Ruler track [124](#)
 - Track controls [125](#)
- Ruler tracks
 - Add Track dialog [124](#)
- Run Setup on Create New Project [838](#)

- S**
- Safe Mode
 - Dialog [820](#)
- Sample editing
 - Sampler Control [438](#)
- Sample Editor [380](#), [389](#), [390](#)
 - Info Line [386](#)
 - Inspector [387](#)
 - Lower zone [55](#)
 - Overview Line [387](#)
 - Regions [393](#)
 - Ruler [389](#)
 - Showing multiple waveforms [389](#)
 - Snap [396](#)
 - Toolbar [381](#)
 - Undo zoom operations [390](#)
- Sample rate
 - Externally clocked [20](#)
- Sampler Control [423](#)
 - Adjusting the sample gain [441](#)
 - Amp section [432](#)
 - AudioWarp mode [428](#)
 - Envelope editor [433](#)
 - Filter section [432](#)
 - Keyboard section [437](#)
 - Loading Audio Samples [421](#)
 - Lower zone [54](#)
 - Normalizing samples [441](#)
 - Pitch section [431](#)
 - Playback and sound parameters [428](#)
 - Playback quality [428](#)
 - Playback section [428](#)
 - Playing back samples [440](#)
 - REX/REX2 files [421](#)
 - Root Key [439](#)
 - Sample editing [438](#)
 - Slice playback [428](#)
 - Slicing [441](#)
 - Toolbar [423](#)
 - Transferring samples to VST instruments [444](#)
 - Waveform display [427](#)
- Sampler tracks [112](#)
 - Add Track dialog [112](#)
 - Creating [422](#)
 - Freeze Channel Options Dialog [442](#)
 - Freezing [145](#), [442](#)
 - Inspector [113](#)
 - Loading Audio Samples [421](#)
 - Loading MIDI Parts [422](#)
 - Pool [446](#)
 - Sampler Control [421](#)
- Sampler tracks (*continued*)
 - Transferring Samples to Instruments [444](#)
 - Unfreeze Channel Options Dialog [443](#)
- Saturation
 - Strip module [306](#)
- Save as Template [87](#)
- Save partial preferences settings [828](#)
- Save Track Preset [149](#), [152](#)
- Scale Around Absolute Center
 - Automation Event Editor [505](#)
- Scale Around Relative Center
 - Automation Event Editor [505](#)
- Scale Assistant
 - Key Editor [653](#)
 - Scale Suggestions [659](#), [660](#)
- Scale events [712](#)
 - Adding [712](#)
 - Auditioning [712](#)
 - Automatic scales [712](#)
 - Changing [712](#)
 - Follow Chord Track [721](#)
 - Showing [712](#)
- Scale Vertically
 - Automation Event Editor [505](#)
- Scaling of the application [838](#)
- Scan Folders only when MediaBay is open [842](#)
- Scan unknown File Types [842](#)
- Scanning
 - MediaBay [481](#)
- Score display [678](#)
- Score Editor [672](#)
 - Display [677](#)
 - Info line [676](#)
 - Lower zone [55](#)
 - Staff settings [678](#)
 - Status line [676](#)
 - Toolbar [673](#)
- Score font
 - Setting [684](#)
- Score text
 - Adding [683](#)
 - Editing [683](#)
- Scores
 - Printing [685](#)
- Script files
 - MIDI Remote [547](#)
- Scripts
 - MIDI Remote Manager [567](#)
 - MIDI Remote Script Console [570](#)
- Scroll to selected Track [832](#)
- Scrub Tool [159](#)
- Scrub Volume [846](#)
- Scrubbing
 - Scrub tool [159](#)
- Secondary Time Format
 - Selecting [201](#)
- Select Channel/Track on Edit Settings [832](#)
- Select Channel/Track on Solo [832](#)
- Select Controllers in Note Range [643](#)
- Select Controllers in Note Range - Use Extended Note Context [831](#)
- Select Media Type
 - MediaBay [484](#)

- Select Tool - Show Extra Info [834](#)
 - Select Track for Auditioning [711](#)
 - Track Control [101](#)
 - Select Track on Background Click [828](#)
 - Selection Ranges
 - Creating [175](#)
 - Editing [176](#)
 - Resizing [176](#)
 - Send effects [329](#), [337](#)
 - Adding FX channel tracks [338](#)
 - Adding to selected channels [339](#)
 - Setting level [341](#)
 - Send Level [848](#)
 - Sends
 - MixConsole [312](#)
 - Setting Event Colors to Track Colors [77](#)
 - Shared Copies
 - Convert to Real Copy [172](#)
 - Creating [172](#)
 - Show Scales [712](#)
 - Track Control [101](#)
 - Side-chain [342](#), [344](#)
 - Ducking delay [343](#)
 - Effect inputs [330](#)
 - Inserts rack [302](#)
 - Trigger signals [344](#)
 - Side-chain inputs [330](#)
 - Silence
 - Detecting [372](#)
 - Direct Offline Processing [366](#)
 - Inserting [180](#)
 - Removing [375](#)
 - Simple Crossfade Editor [256](#)
 - Single Voice
 - Follow Chord Track [720](#)
 - Size with Fade [165](#)
 - Slices [398](#)
 - Close gaps [404](#)
 - Delete overlaps [405](#)
 - Slider Mode [830](#)
 - Slip Event Content [173](#)
 - Smallest Track Height To Show Data [834](#)
 - Smallest Track Height To Show Name [834](#)
 - Snap [68](#)
 - Sample Editor [396](#)
 - Snap MIDI Parts to Bars [844](#)
 - Snap point
 - Setting [68](#)
 - Snap Point
 - Sample Editor [397](#)
 - Snap Point To Cursor [68](#)
 - Snap to zero crossing [68](#)
 - Snap type
 - Project window [68](#), [71](#)
 - Solo
 - MixConsole [294](#)
 - Track Control [101](#)
 - Solo Defeat
 - MixConsole [294](#)
 - Solo Record in MIDI Editors [844](#)
 - Spectrum Analyzer [377](#)
 - Audio Functions [376](#)
 - Comparing level values [377](#)
 - Split MIDI Controllers [831](#)
 - Split MIDI Events [831](#)
 - Splitting
 - Events [169](#)
 - Into equal events [170](#)
 - Ranges [179](#)
 - Standard algorithm [370](#)
 - Standard Compressor
 - Details view [320](#)
 - Edit Module [320](#)
 - Start Recording at Cursor
 - Common Record Modes [214](#)
 - Start Recording at Left Locator
 - Common Record Modes [214](#)
 - Static value line
 - Automation [501](#)
 - Stationary Cursors [845](#)
 - Statistics
 - Audio Functions [378](#)
 - Status line
 - Project window [46](#)
 - Score Editor [676](#)
 - Step recording [671](#)
 - Stereo Flip
 - Direct Offline Processing [366](#)
 - Stop playback while winding [845](#)
 - Stretch
 - Automation Event Editor [505](#)
 - Strip presets [312](#)
 - Strip Presets
 - Loading in MediaBay [495](#)
 - Studio Setup
 - Dialog [12](#)
 - Suspend Auto-Scroll when Editing [201](#)
 - Suspend VST 3 plug-in processing when no audio signals are received [849](#)
 - Swing
 - Quantizing [245](#)
 - Sync Selection
 - Markers window [271](#)
 - Synchronization [770](#)
 - Audio clock [772](#)
 - External Sync [778](#)
 - MIDI clock [772](#)
 - Setup dialog [773](#)
 - Speed references [772](#)
 - Timecode [771](#)
 - Synchronize Plug-in Program Selection to Track Selection [849](#)
 - Synchronizing Track Data
 - Follow Chord Track [721](#)
 - System component information [355](#)
 - Exporting [357](#)
- ## T
- Tap Tempo [753](#)
 - Tapemachine Style
 - Monitoring [848](#)
 - Template projects [85](#)
 - Templates [85](#)
 - Renaming [87](#)

- Tempo
 - Set Definition from Tempo 755
- Tempo Editor
 - Toolbar 749
- Tempo Events
 - Editing 752
- Tempo modes
 - Fixed Tempo 748
 - Tempo track 748
- Tempo track 748
 - Activate 749
 - Editor 748
 - Mode 748
 - Tempo changes 751
- Thumbnail Memory Cache Size 850
- Thumbnails 793
 - Thumbnail cache files 793
- Tilt Left
 - Automation Event Editor 505
- Tilt Right
 - Automation Event Editor 505
- Time display 201
- Time Display Window 196
- Time Format 201
- Time Signature Events
 - Adding 756
 - Setting up 756
- Time Stretch
 - Algorithms 370
 - Direct Offline Processing 367
 - Limitations 371
- Timecode
 - Standards 771
 - Synchronization 771
- Timecode Subframes
 - Showing 845
- Timeline
 - Ruler 614
- Tips
 - Showing 838
- Tool modifier keys 816, 833
- Toolbar
 - Pool 449
 - Project window 36
 - Score Editor 673
- Toolbar Divider
 - Project window 42
- Toolbox
 - Project window 42
- Toolbox on Right-Click 834
- Track automation data
 - Automation 640
- Track Color
 - Resetting 76
- Track Controls 101
- Track Controls Settings 99
- Track Height 142
- Track Inspector
 - Opening 49
- Track list 42
 - Dividing 42
- Track parameters
 - Track Quick Controls 535
- Track pictures
 - Browser 141
 - MixConsole 313
 - Track list 140
- Track presets
 - Quick Control assignment 537
- Track Presets 148
 - Applying 148, 149
 - Audio 148
 - Creating 149
 - Extracting sounds 150
 - Instrument 150
 - Loading 152
 - Loading in MediaBay 494
 - MIDI 148
 - Multi-Track 151
 - Previewing in MediaBay 489
 - Sampler tracks 152
 - VST Presets 150
- Track Quick Controls 534, 581, 583
 - Assigning effect parameters 536
 - Assigning instrument parameters 536
 - Assigning parameters 535
 - Automatable Parameters 538
 - Connecting with Remote Controllers 581
 - Inspector 535
 - Loading presets 537
 - Parameter assignment 535
 - QC Learn Mode 536
 - Removing assignments 537
 - Saving assignments as presets 537
 - Showing automated assignments 538
- Track Selection follows Event Selection 828
- Track Versions
 - Inspector Section 98
- Tracks 97
 - Add Track dialog 136
 - Adding 136, 137
 - Audio 105
 - Chord 131
 - Color 140
 - Colorizing 75
 - Customizing track controls 99
 - Deselecting 144
 - Disabling 144
 - Duplicating 144
 - Enabling 144
 - Folder 126
 - FX channel 121
 - Group Channel 118
 - Inspector 98
 - Instrument 108
 - Marker 134
 - MIDI 115
 - Moving 139
 - Removing 139
 - Renaming 140
 - Ruler 124
 - Sampler 112
 - Selecting 143
 - Using Track Presets 136
 - Video 133
 - Zooming 142

Transformer
Strip module 306

Transport
Overview 191
Sections 191

Transport Bar 190

Transport menu
Functions 185

Transport panel 181
Display format 201
Overview 181
Post-roll 202
Pre-roll 202
Sections 181

Transport pop-up window 195

Transport Zone
Project window 47

Transpose
MIDI function 602

Treat Muted Audio Events like Deleted 829

Trim tool
Changing event lengths 666

Tube Compressor
Details view 321
Edit Module 321

Tuplets
Quantizing 245

Type of New Tempo Points 749

U

Undoing
Edit History 73
Maximum undo steps 74
Maximum Undo Steps 838
Offline processing 362
Project window 36
Recording audio 220
Zoom operations 390

Unfreeze Channel Options
Instrument tracks 522
Sampler tracks 443

Use Drum Editor when Drum Map is assigned 834

Use Up/Down Navigation Commands for Selecting Tracks only 828

V

Value Box/Time Control Mode 830

Velocity
MIDI function 609

Velocity events
Adding in controller display 632
Editing 631

Vertical zoom
Sample Editor 390

Video
Codecs 791
Editing 797
Exporting 799
Extracting audio from 800
Formats 790
Importing 792

Video (*continued*)
Output devices 791
Playback 794
Scrubbing 797
Studio Setup 794
Thumbnails 793

Video Player window 795
Aspect ratio 795
Setting window size 795

Video track 133
Inspector 134
Track controls 134

Vintage Compressor
Details view 322
Edit Module 322

Visibility
MixConsole 283

Voicings 714
Automatic voicings 715
Configuring parameters 715
Library 715
Library subset 715
Octave offset 715
Piano 715
Range 715

Volume
MixConsole 295

Volume databases
Creating in the MediaBay 496
Mounting in the MediaBay 498
Removing from the MediaBay 498
Unmounting in the MediaBay 498

VST
Input ports 21
Output ports 21
VST 2 330
VST 3 330

VST 3
Suspend plug-in processing 520

VST effect selector 336

VST instrument selector 513

VST instruments
Context menu 517
Control panel 511
Freeze Channel Options Dialog 521
Freezing 145, 520
Functions menu 517
Presets 518
Saving presets 518
Setting up 510

VST Plug-in collection
Adding 531

VST Plug-in control panels
Closing 350, 513
Hiding 350, 512
Showing 350, 512

VST Plug-in Manager 528
Collections 529
Window 529

VST plug-in pictures
Adding 476, 477

- VST Plug-ins
 - Adding collections [531](#)
 - Blocklist [533](#)
 - Hiding [532](#)
 - Installing [528](#)
 - Managing [528](#)
 - Reactivating [533](#)
 - Showing [532](#)
- VST Presets
 - Loading [152](#)
 - Previewing in MediaBay [489](#)
- VST System Link [779](#)
 - Activating [784](#)
 - Connections [781](#)
 - Latency [782](#)
 - Putting computers online [785](#)
 - Setting up sync [781](#)
- VSTi rack
 - Right zone [59](#)
- Zoom history
 - Project window [67](#)
- Zoom presets
 - Project window [66](#)
- Zoom Tool Standard Mode - Horizontal Zooming Only [834](#)
- Zoom while Locating in Time Scale [845](#)
- Zooming
 - To cycle markers [271](#)
- Zooming horizontally [390](#)
- Zooming tracks [142](#)
- Zooming vertically [390](#)

W

- Warn before removing modified effects [849](#)
- Warn on Processing Overloads [848](#)
- Warping Algorithm [829](#)
- Wave files [765](#)
- Waveform Brightness [835](#)
- Waveform display [389](#)
 - Sample Editor [389](#)
- Waveform Outline Intensity [835](#)
- Waveforms
 - Showing [835](#)
- When Recording Wave Files larger than 4 GB [844](#)
- Wind Speed Options [845](#)
- Windows
 - Dialog [819](#)
- Windows Media Audio files
 - Importing [233](#)
- Word clock
 - Synchronization [772](#)
- Working with MIDI data
 - Tools and functions for [693](#)
- Write Automation
 - Track Control [101](#)
- Writing automation [501](#)
 - Automatically [501](#), [502](#)
 - Manually [501](#), [502](#)
 - Tools [503](#)

Z

- Zones
 - Keyboard focus [63](#)
 - Lower zone [52](#)
 - Project zone [35](#)
 - Right zone [58](#)
- Zoom
 - Adapt Grid to Zoom [64](#)
 - Audio Contents [65](#)
 - Cycle Markers [67](#)
 - Project window [64](#)
 - Track Control [101](#)