

Operation Manual



NUENDO 11

Premium Media Production System

The Steinberg Documentation Team: Cristina Bachmann, Heiko Bischoff, Lillie Harris, Christina Kaboth, Insa Mingers, Matthias Obrecht, Sabine Pfeifer, Benjamin Schütte, Marita Sladek

Translation: Ability InterBusiness Solutions (AIBS), Moon Chen, Jérémie Dal Santo, Rosa Freitag, Josep Llodra Grimalt, Vadim Kupriianov, Filippo Manfredi, Roland Münchow, Boris Rogowski, Sergey Tamarovsky

This document provides improved access for people who are blind or have low vision. Please note that due to the complexity and number of images in this document, it is not possible to include text descriptions of images.

The information in this document is subject to change without notice and does not represent a commitment on the part of Steinberg Media Technologies GmbH. The software described by this document is subject to a License Agreement and may not be copied to other media except as specifically allowed in the License Agreement.

No part of this publication may be copied, reproduced, or otherwise transmitted or recorded, for any purpose, without prior written permission by Steinberg Media Technologies GmbH. Registered licensees of the product described herein may print one copy of this document for their personal use.

All product and company names are ™ or ® trademarks of their respective owners. For more information, please visit www.steinberg.net/trademarks.

© Steinberg Media Technologies GmbH, 2021.

All rights reserved.

Nuendo_11.0.0_en-US_2020-12-09

Table of Contents

9	New Features	
13	Introduction	
13	Platform-Independent Documentation	
13	PDF Documents and Online Documentation	
14	Conventions	
15	Key Commands	
16	Setting up Your System	
16	Studio Setup Dialog	
17	Setting up Audio	
24	Setting up MIDI	
27	Synchronizers	
28	Audio Connections	
28	Audio Connections Window	
34	Renaming the Hardware Inputs and Outputs	
35	Adding Input and Output Busses	
35	Adding Child Busses	
36	Presets for Input and Output Busses	
37	Adding Group and FX Channels	
37	Monitoring Bus	
37	External Instruments and Effects	
44	Bus Configurations	
46	Project Window	
47	Showing/Hiding Zones	
47	Project Zone	
63	Left Zone	
72	Lower Zone	
78	Right Zone	
84	Keyboard Focus in the Project Window	
86	Zooming in the Project Window	
89	Snap Function	
92	Cross-Hair Cursor	
92	Edit History Dialog	
94	Color Handling	
103	Project Handling	
103	Creating New Projects	
103	Hub	
105	New Project Dialog	
105	Project Files	
105	Template Files	
108	Project Setup Dialog	
111	Opening Project Files	
113	Saving Project Files	
114	Reverting to the Last Saved Version	
114	Choosing a Project Location	
115	Self-Contained Projects	
118	Tracks	
118	Track Inspector Settings Dialog	
121	Track Controls Settings Dialog	
127	Add Track Dialog	
128	Audio Tracks	
132	Instrument Tracks	
136	Sampler Tracks	
139	MIDI Tracks	
		142
		145
		148
		150
		152
		154
		157
		170
		Track Handling
		170
		170
		171
		171
		176
		177
		179
		180
		182
		182
		182
		182
		183
		183
		185
		186
		186
		187
		187
		187
		188
		188
		189
		189
		190
		193
		194
		201
		208
		Parts and Events
		208
		212
		213
		248
		Range Editing
		248
		250
		250
		254
		Playback and Transport
		254
		259
		264
		269
		270
		271
		273

274	Auto-Scroll Settings Menu	391	ADR Statuses
275	Time Formats	391	ADR Modes
275	Pre-Roll and Post-Roll	392	ADR Panel
276	Punch In and Punch Out	393	ADR Setup
277	Metronome Click	396	Setting Up ADR Tracks
287	Chase	397	Setting Up the ADR Environment
288	On-Screen Keyboard	399	Rehearsing Takes
288	Recording MIDI With the On-Screen Keyboard	400	Recording Takes
288	On-Screen Keyboard Options	400	Reviewing Takes
290	Recording	402	MixConsole
290	Basic Recording Methods	402	MixConsole in Lower Zone
295	Monitoring	405	MixConsole Window
297	Audio Recording Specifics	474	VCA Faders
302	MIDI Recording Specifics	474	VCA Fader Settings
310	Remaining Record Time	475	Creating VCA Faders in the MixConsole
310	Lock Record	476	Nested VCA Faders
311	Importing Audio and MIDI Files	476	VCA Fader Automation
311	Audio File Import	476	VCA Rack
319	MIDI File Import	479	Control Room
321	Quantizing MIDI and Audio	479	Adding Channels to the Control Room
321	Quantize Functions	480	Output Routing
322	Quantizing MIDI Event Starts	480	Exclusive Assignment of Monitor Channels
323	Quantizing MIDI Event Lengths	480	Control Room Channels
323	Quantizing MIDI Event Ends	482	Control Room - Main Tab
323	Quantizing Audio Event Starts	489	Control Room - Inserts Tab
324	Quantizing Audio Event Lengths (AudioWarp Quantizing)	491	Setting up a Cue Mix
324	Quantizing Multiple Audio Tracks	492	Adjusting the Overall Cue Send Level
326	Quantize Panel	493	Metering and Loudness
335	Fades, Crossfades, and Envelopes	493	Metering
335	Event-Based Fades	499	Loudness Track
339	Creating Clip-Based Fades	500	Normalizing Loudness on Export
340	Crossfades	502	Audio Effects
347	Auto Fades and Crossfades	502	Insert Effects and Send Effects
349	Event Envelopes	504	Insert Effects
351	Arranger Track	512	VST Effect Selector
351	Adding Arranger Events on the Arranger Track	513	Send Effects
352	Arranger Editor	519	Side-Chaining
355	Setting up an Arranger Chain and Adding Events	523	Dither Effects
357	Jump Mode	523	External Effects
358	Arranging Music to Video	523	Effect Control Panel
360	Transpose Functions	527	Effect Presets
360	Project Root Key	532	System Component Information Window
363	Transpose Track	534	Direct Offline Processing
365	Keep Transpose in Octave Range	535	Direct Offline Processing Workflow
366	Transpose on the Info Line	536	Direct Offline Processing Window
367	Excluding Individual Parts or Events from Global Transpose	548	Built-In Audio Processes
368	Markers	557	Key Commands for Direct Offline Processing
368	Position Markers	559	Time Stretch and Pitch Shift Algorithms
368	Cycle Markers	559	élastique
369	Showing/Hiding Marker Lines in the Project Window	559	MPEX
370	Showing/Hiding Marker Lines in the Key Editor	560	Standard
371	Markers Window	561	Limitations
377	Marker Track	562	Audio Functions
381	Importing and Exporting Markers	562	Detect Silence Dialog
390	ADR	565	Spectrum Analyzer Window
390	ADR and Marker Selection	567	Statistics Window
		569	Game Audio Connect
		569	Game Audio Connect Window
		570	Game Audio Connect Settings Dialog

571	Setting Up Game Audio Connect for Network Communication	651	Activating the Extension for Further Audio Events
572	Rearrange Audio Assets for Editing	651	Deactivating the Extension for Audio Events
572	Rename Audio Assets	652	Audio Event Editing
572	Export Audio Assets to a Game Audio Engine	653	Sampler Tracks
574	Sample Editor	653	Loading Audio Samples into Sampler Control
576	Sample Editor Toolbar	654	Loading MIDI Parts into Sampler Control
580	Info Line	654	Creating Sampler Tracks
581	Overview Line	654	Sampler Control
581	Sample Editor Inspector	669	Sample Editing and Playback Functions
584	Ruler	673	Transferring Samples from Sampler Control to VST Instruments
585	Waveform Display	675	Pool
587	Range Editing	675	Pool Window
591	Regions List	680	Working with the Pool
593	Snap Point	697	MediaBay and Media Rack
596	Hitpoints	697	Media Rack in Right Zone
596	Calculating Hitpoints	708	MediaBay Window
599	Locating to Hitpoints in the Project Window	736	MediaBay Aspects
599	Slices	736	Working with Volume Databases
602	Creating a Groove Quantize Map	739	MediaBay Settings
602	Creating Markers	740	Surround Sound
602	Creating Regions	741	Deliverables
603	Creating Events	741	Available Surround Channel Configurations
603	Creating Warp Markers	744	Preparations for Creating Surround Mixes
603	Creating MIDI Notes	747	VST MultiPanner
605	Tempo Matching Audio	764	MixConvert V6
605	Algorithm Presets	769	Surround Mix Export
606	Stretching Audio Events to the Project Tempo	769	Object Audio in Nuendo
606	Musical Mode	792	Ambisonics Mixes
608	Auto Adjust	805	Automation
609	Manual Adjust	805	Automation Curves
610	Free Warp	805	Static Value Line
612	Flattening Realtime Processing	805	Write/Read Automation
613	Flatten Realtime Processing Dialog	806	Writing Automation Data
613	Unstretching Audio Files	808	Editing Automation Events
614	Pitch Editing and Time Correction with VariAudio	813	Cleaning Automation
614	VariAudio and Offline Processes	814	Automation Tracks
615	VariAudio Inspector Section	815	Virgin Territory vs. Initial Value
616	Smart Controls	816	Automation Panel
618	Segmenting Monophonic Audio	835	VST Instruments
619	Segments and Gaps	835	Adding VST Instruments
620	Auditioning	835	VST Instrument Control Panel
620	Navigation and Zoom	837	VST Instrument Selector
621	Segment Editing	838	Creating Instrument Tracks
623	Pitch Changes	838	VST Instruments in the Right Zone
630	Timing Modifications	839	VST Instruments Window
631	Showing MIDI Reference Tracks	839	VST Instruments Window Toolbar
632	Formant Shifting	840	VST Instrument Controls
633	Editing Volume	842	Presets for Instruments
633	Functions Menu	844	Playing Back VST Instruments
637	Harmony Voices for Audio	846	Latency
639	Audio Part Editor	847	Import and Export Options
640	Audio Part Editor Toolbar	848	VST Quick Controls
645	Info Line	850	Side-Chaining for VST Instruments
645	Ruler	851	External Instruments
645	Lanes	852	Installing and Managing VST Plug-ins
646	Operations	852	Plug-ins and Collections
649	Extensions in Nuendo	855	Adding New Plug-in Collections
649	Activating an Extension in Nuendo	856	Hiding Plug-ins
650	Editor for Extensions	857	Reactivating Plug-ins from the Blocklist

858	Track Quick Controls	1015	Expression Maps
859	Parameter Assignment	1016	Articulations
862	Controlling Automatable Parameters	1016	Expression Map Setup Window
863	Connecting Track Quick Controls with Remote Controllers	1018	Creating and Editing Expression Maps
865	Remote Controlling Nuendo	1024	Inserting Articulations
865	Connecting Remote Devices	1027	Note Expression
865	Removing the Remote Input from All MIDI Inputs	1028	VST Note Expressions
866	Setting up Remote Devices	1029	MIDI Controllers
868	Remote Devices and Automation	1033	Note Expression Inspector Section
868	Assigning Commands to Remote Devices	1037	Note Expression Tools
869	Generic Remote Page	1037	Controller Mapping
874	Remote Control Editor	1039	Recording
879	Joysticks	1042	Note Expression Event Editor
879	Track Quick Controls	1047	Trimming Note Expression Data
879	VST Quick Controls	1048	Removing All Note Expression Data
880	MIDI Realtime Parameters and MIDI Effects	1048	Note Expression MIDI Setup Dialog
880	MIDI Track Parameters	1052	Chord Functions
882	MIDI Modifiers	1052	Chord Track
887	MIDI Effects	1053	Chord Events
890	Transpose and Velocity on the Info Line	1060	Scale Events
891	Using MIDI Devices	1062	Voicings
891	Program Change Messages and Bank Select Messages	1065	Converting Chord Events to MIDI
892	Patch Banks	1066	Controlling MIDI or Audio Playback Using the Chord Track
892	MIDI Device Manager	1071	Assigning Voices to Notes
897	Device Panels	1071	Extracting Chord Events from MIDI
901	MIDI Functions	1072	Recording Chord Events with a MIDI Keyboard
901	Transpose Setup Dialog	1073	Chord Pads
902	Merging MIDI Events into a New Part	1073	Chord Pads Zone
904	Dissolve Part Dialog	1076	Functions Menu
905	Bouncing MIDI Parts	1076	Chord Assistant
906	Repeating MIDI Events of Independent Track Loops	1080	Chord Assignment
906	Extending MIDI Notes	1083	Swapping Chord Assignments
906	Fixing MIDI Note Lengths	1084	Copying Chord Assignments
907	Fixing MIDI Note Velocities	1084	Playing Back and Recording Chords
907	Rendering Sustain Pedal Data to Note Lengths	1087	Player Setup
908	Deleting Overlaps	1094	Chord Pads Setup Dialog
908	Editing Velocity	1099	Chord Pads Presets
909	Deleting Double Notes	1100	Creating Chord Events from Chord Pads
909	Deleting Controller Data	1100	Creating MIDI Parts from Chord Pads
909	Deleting Continuous Controller Data	1101	Logical Editor
910	Restricting Polyphonic Voices	1101	Window Overview
910	Thinning Out Controller Data	1102	Filter Conditions
910	Extracting MIDI Automation	1111	Selecting a Function
911	Reversing the Playback Order of MIDI Events	1112	Specifying Actions
911	Inverting the Order of Selected MIDI Events	1114	Applying the Defined Actions
911	Creating a Tempo Track from Tapping	1115	Presets
913	MIDI Editors	1116	Project Logical Editor
913	Common MIDI Editor Functions	1116	Project Logical Editor Window Overview
921	Controller Display	1117	Filter Conditions
945	Key Editor	1126	Specifying Actions
963	Key Editor Operations	1129	Selecting a Function
979	Drum Editor	1130	Applying Macros
990	Drum Editor Operations	1130	Applying the Defined Actions
993	Drum Maps	1130	Presets
998	List Editor	1132	Editing Tempo and Time Signature
1007	List Editor Operations	1132	Project Tempo Modes
1012	In-Place Editor	1132	Track Time Base
		1133	Tempo Track Editor
		1135	Tempo Track
		1137	Tempo Changes for Projects

1141	Setting up a Fixed Project Tempo	1234	Video
1143	Beat Calculator	1234	Video File Compatibility
1144	Tempo Detection	1235	Frame Rates
1145	Exporting a Tempo Track	1236	Video Output Devices
1145	Importing a Tempo Track	1236	Preparations for Creating Video Projects
1146	Process Tempo Dialog	1238	Preparations for Video Playback
1147	Process Bars Dialog	1241	Editing Video
1147	Time Warp	1241	Export Video
1149	Set Definition from Tempo Dialog	1244	Extracting Audio from Video
1149	Time Signature Events		
1152	Project Browser	1246	Audio Editing to Picture
1152	Project Browser Toolbar	1246	Video Timeline and the Grid
1153	Project Structure	1247	Import Production Audio
1153	Event Display	1255	Video Cut Detection
1156	Rendering Audio and MIDI	1258	Use Video Follows Edit Mode
1156	Render Tracks Dialog	1259	Event-Based Fades and Volume Envelopes
1159	Render Selection Dialog	1259	Placing Audio to Picture
		1262	Adjusting and Editing Audio
1162	Export Audio Mixdown	1265	Film Transfers
1162	Export Audio Mixdown Dialog	1265	Pull-Down and Speed Changes
1171	Mixing Down to Audio Files	1265	Telecine Process
1173	Mixing Down to Audio Files Using Job Queues	1268	Compensating for Speed Changes
1176	Available Channels for Export	1271	Working with Video Tape Recorders
1177	File Formats	1272	Tips
1184	Saving File Format Presets		
1185	Networking	1273	ReConform
1185	Networking Protocol and Ports	1273	Prerequisites
1186	Network Requirements	1273	ReConform Workflow
1188	Changing Your User Name	1274	ReConform Dialog
1189	Permissions	1274	EDLs
1191	Project Folder Location	1281	ReConform Settings
1192	Sharing Projects	1287	Video Preview
1193	Joining Projects		
1194	Working with Shared Projects	1290	Exchanging Files with Other Applications
1197	Resolving Network Communication Problems	1290	AES31 Files
1197	Chatting	1292	Cue Sheets
1198	User Manager Dialog	1295	OMF Files
1199	Shared Projects Dialog	1299	AAF Files
1199	Project Sharing and Permissions Dialog	1304	ADM Files
1201	Network Inspector Section	1306	MXF Files
1202	Network Controls on the Toolbar		
1202	Network Track Controls	1308	ReWire
		1308	Enabling ReWire Applications
1204	Synchronization	1309	Launching and quitting
1204	Master and Slave	1310	Activating ReWire channels
1205	Timecode Formats	1310	Using the transport and tempo controls
1207	Clock Sources	1311	How the ReWire channels are handled
1209	Frame Edge Alignment	1312	Routing MIDI via ReWire
1209	Project Synchronization Setup Dialog	1312	Considerations and limitations
1216	MMC Master Panel		
1217	External Synchronization	1313	Key Commands
1218	9-Pin Auto Edit	1313	Key Commands Dialog
1218	Setting up Synchronization for a Personal Music Studio	1316	Assigning Key Commands
1219	Setting up Synchronization for a Postproduction Suite	1316	Searching for Key Commands
1221	Setting up Synchronization for a Theatrical Mixing Stage	1317	Removing Key Commands
		1317	Setting up Macros
1223	VST System Link	1317	Saving Complete Key Commands Settings as Presets
1223	Setting up VST System Link	1318	Saving Partial Key Commands Settings
1228	Activating VST System Link	1318	Loading Key Command Presets
1230	Application Examples	1319	Resetting Key Commands
		1319	Key Sets
		1321	Default Key Commands
		1333	Setting up Tool Modifier Keys
		1334	Disabling Key Commands

1335	Customizing
1335	Workspaces
1338	Setup Options
1340	Configuring the Main Menu Items
1342	Profiles
1346	Windows Dialog
1347	Where are the Settings Stored?
1347	Safe Mode Dialog
1350	Optimizing Audio Performance
1350	Performance Aspects
1351	Settings That Affect Performance
1351	Audio Performance Window
1352	ASIO-Guard
1354	Preferences
1354	Preferences Dialog
1356	Configuration
1356	Editing
1361	Editors
1362	Event Display
1365	General
1367	MIDI
1370	MediaBay
1371	Metering
1371	Record
1373	Scores
1375	Transport
1376	User Interface
1378	VST
1381	VariAudio
1381	Video
1382	Index

New Features

The following list informs you about the most important improvements in Nuendo and provides links to the corresponding descriptions.

New Features in Version 11.0.0

Highlights

MultiTap Delay Surround Support

- Now supporting surround sound, the **MultiTap Delay** plug-in has all the creative options you need to create otherworldly and spatial atmospheres. You can quickly and easily create up to eight delay taps, harness the sound of digital delays or vintage echo units, and add effects to the complete output, the delay loop, or even each individual tap. This plug-in is described in the separate document **Plug-in Reference**. See [MultiTap Delay](#).

SuperVision

- This plug-in is a fully customizable multimeter audio analyzer for professional productions. **SuperVision** lets you choose from several different modules for signal, spectral, phase, spatial, and waveform analysis. It provides a dedicated loudness module for Netflix content, calibrated to Netflix's official Sound Mix Specifications and Best Practices, measuring the overall dialogue-gated loudness of a mix at a standard reference of -27.0 LUFS. The **Intelligibility** module evaluates the intelligibility of the spoken word in a mix, based on artificial intelligence algorithms developed by the Fraunhofer IDMT. This helps audio engineers to deliver an optimal, clearly understandable dialogue mix. The **SuperVision** plug-in suite allows you to create your own custom layout with up to nine module slots with individual display settings for each module to give you a supremely accurate visual picture of your sound. It is described in the separate document **Plug-in Reference**. See [SuperVision](#).

SpectraLayers One

- This compact version of the acclaimed visual audio editing tool allows you to visualize and accurately clean up your audio. Thanks to the state-of-the-art source separation engine, you can separate the vocal part from any kinds of audio tracks. Its advanced ARA technology allows a spectrogram view of audio tracks with the ideal balance of selection, editing, and display tools for surgical editing tasks like improving dialogue and location sounds straight from a field recorder, with no need for any third-party application. The tool is described in the separate document **SpectraLayers One**. See [SpectraLayers One](#).

Authoring for Dolby Atmos

- The new ADM authoring features for Dolby Atmos® allow you to create, mix, and export fully compliant Dolby Atmos content without any additional software or hardware. See [Authoring and Mixing for Dolby Atmos®](#).
- The **Renderer for Dolby Atmos** plug-in is a VST renderer that is compliant with Dolby Atmos® specifications. It allows for real-time monitoring, downmixing, and re-rendering of object-based mixes without requiring external software or hardware. Additionally, Nuendo supports the Dolby Atmos Production Suite, Dolby Atmos Mastering Suite, and Cinema RMU. See [Setup for Dolby Atmos Mixes](#).
- In the ADM authoring window, you can configure objects and beds from existing tracks in the project and customize the object structure. See [ADM Authoring for Dolby Atmos Window](#).
- You can import ADM Broadcast Wave files, such as those exported from the Dolby Atmos Production Suite or the Dolby Atmos Mastering Suite rendering software. These files contain all audio objects and beds, the dynamic panning metadata, program-level static

metadata, and group structure, with audio from ADM extracted to tracks in the Nuendo project. See [ADM Files](#).

Job Queue Management

- In most DAWs, exporting multiple files is a repetitive and time-consuming task. Nuendo makes this job much faster, less prone to errors, and way more convenient. Sync your export selection to the selection in your project and export the full signal path, including master bus effects, to truly replicate the mix. See [Export Audio Mixdown Dialog](#).
- Nuendo lets you collect your export jobs to export the whole job queue in one go while you grab a coffee. See [Mixing Down to Audio Files Using Job Queues](#).

More New Features

New Score Editor Features and Fonts

- The **Score Editor** was enhanced with lots of great additions and improvements. The new **Properties** tab lets you instantly access the options and settings for specific elements that you select in your notation, and with the **Note Editing Overlay**, you can edit notes as conveniently as in the **Key Editor**. There are more workflow improvements, and the **Score Editor** now also supports the SMuFL font format, which brings Dorico's beautiful Bravura and Petaluma fonts to Nuendo. See [Score Layout and Printing](#).

Imager

- This new plug-in helps you to get a better, cleaner mix. You can place audio tracks in the stereo field independently in up to four bands, allowing you to expand or reduce the stereo width of your sound. The individual scope and correlation displays help you to get your panning absolutely perfect. The plug-in is described in the separate document **Plug-in Reference**. See [Imager](#).

Squasher

- This dynamic plug-in combines up and down compression for up to three bands. Use it to help your lead sounds cut through the mix, tame aggressive bass lines, or enhance subtle, spacey reverberation. The plug-in is described in the separate document **Plug-in Reference**. See [Squasher](#).

Frequency 2

- The **Frequency 2** equalizer provides eight bands, each of which can be individually set to dynamic filtering for a more dynamic mix. You can also find mid/side channel support and **Linear Phase** mode for each band, **Auto Listen** to hear the adjustments you have made, a spectrum display and even a musical keyboard to help you find the right tone. The plug-in is described in the separate document **Plug-in Reference**. See [Frequency 2](#).

Range Editing Improvements for Combine Selection Tools mode

- If **Combine Selection Tools** is activated and you split a selection range, the newly created events are automatically selected. See [Splitting Selection Ranges](#).

Marker Lines

- You can activate/deactivate the display of vertical marker lines to indicate marker positions on all tracks throughout the entire project. You can decide if marker lines are shown for the active marker track only or for all marker tracks. See [Markers](#).

Enhanced Direct Offline Processing

- The **Direct Offline Processing** window now allows you to pin processes, which eases the usage of plug-ins with a learning function. See [Direct Offline Processing Workflow](#).

Revised ARA 2.0 Support

- A bounce is no longer needed when committing an audio event to the selected ARA extension. See [Extensions in Nuendo](#).

Sampler Track Improvements

- The sampler track comes with a number of great new features. The new slicing mode chops up your loops so they're ready-to-play with just a click. There are now two global LFOs available to add motion and interesting effects. You can go for a vintage feel or the highest fidelity with the sample engine's new quality modes. And the new mono legato glide is perfect for typical 808 basslines and more. See [Sampler Tracks](#).

Support for several new 2D and 3D channel configurations.

- Nuendo now supports several additional 3D formats for Dolby Atmos productions, for example, 5.1.4 and 7.1.4. For 2D surround mixes, you can now also choose larger speaker setups of up to 10.1 configurations. See [Available Surround Channel Configurations](#).

OSC Support for Immersive Sound Live Productions

- You can create and mix object-based content using the OSC network protocol to control a renderer. Nuendo can play back and record object-based audio at live performances when connected to an OSC network environment, and also allows for live position tracking via the OSC protocol. See [Authoring and Mixing Object-Based Productions Using Open Sound Control \(OSC\)](#).

Pitchbend and Controller Editing Improvements

- You can select whether you want ramps or steps as the default type for new controller events. See [Controller Lane Setup Menu](#).
- You can copy all of your CC edits to another track. See [Controller Lane Context Menu](#).
- You can set your pitchbend steps to semitones to always be perfectly in tune. See [Pitchbend Controller Lanes](#).
- You can create ramps and curves in the CC and pitchbend lanes, just like you are used to with automation. See [Creating Smooth Transitions between Continuous Controller Events](#).
- You can delete MIDI notes with a simple, fast double-click. See [Deleting Note Events](#).

Global Tracks in the Key Editor

- Staying in sync with tempo changes or markers is crucial when composing any kind of music. Nuendo makes your life easier with **Global Tracks** that can now be displayed in the **Key Editor**. With no need to leave the **Key Editor** anymore, this great visual reference will keep your compositions moving along quickly and creatively. See [Global Tracks in the Key Editor](#).

Scale Assistant in the Key Editor

- The **Scale Assistant** is a superb addition to your songwriting toolkit. You can set your song's scale in the **Key Editor** and follow its lead, quantize a solo to scale or play live in perfect tune. You can change the view to only see the notes of the set scale. You can even let the **Scale Assistant** analyze your MIDI recording and suggest the right scale. Now there are no more excuses for wrong notes. See [Scale Assistant in the Key Editor](#).

File Format Presets

- Create and restore file format presets from your favorite or most used file format settings. See [Saving File Format Presets](#).

Last but Not Least

Keyboard Focus Indication for Divided Track Lists

- When working with the **Divide Track List** feature, it is now clearly indicated which of the track lists has the keyboard focus. See [Keyboard Focus in the Project Window](#).

Show Version Name in Track List

- The version name of a track version can be shown/hidden in the track list. See [Track Version Names](#).

Details View for Maximizer Channel Strip Module

- The **Maximizer** channel strip module now offers a details view in the **Channel Settings** window. See [Maximizer – Details View](#).

Support of Multiple Side-Chain Inputs

- For plug-ins that support multiple side-chain inputs, for example, the new **Frequency 2** and **Squasher**, you can now set up an individual side-chain routing for any of these inputs. This allows you to control each plug-in side-chain input with a different side-chain source. See [Side-Chain Routing](#).

Poly Pressure Lane Handling Improvements

- Selecting and editing poly pressure events on the controller lane is much more intuitive now. See [Adding Poly Pressure Events](#).

Define the Visible Pitches in the Key Editor

- You can define which pitches are visible in the event display and the piano keyboard display of the **Key Editor**. See [Showing Specific Pitches in the Key Editor](#).

Search for Notes in Chords

- The new context variables in the **Logical Editor** allow you to search for the highest or lowest note in a progression of chords (**Highest in Chord from at Least n Notes** and **Lowest in Chord from at Least n Notes**), and to operate on those notes. See [Chords Filter](#).

Variable DPI on Windows 10

- Nuendo now supports more scaling settings for Windows 10, such as 125 %, 150 %, and 200 %. Even plug-ins that do not support HiDPI can now be scaled based on the scaling factor of Windows. See [General](#).

Introduction

This is the **Operation Manual** for Steinberg's Nuendo. Here you will find detailed information about all the features and functions in the program.

Platform-Independent Documentation

The documentation applies to the operating systems Windows and macOS.

Features and settings that are specific to one of these platforms are clearly indicated. In all other cases, the descriptions and procedures in the documentation are valid for Windows and macOS.

Some points to consider:

- The screenshots are taken from Windows.
- Some functions that are available on the **File** menu on Windows can be found in the program name menu on macOS.

PDF Documents and Online Documentation

The documentation consists of several documents. You can read them online or download them from steinberg.help.

You can reach steinberg.help from the program by selecting **Help > Nuendo Help**.

Operation Manual

The main Nuendo reference documentation, with detailed descriptions of operations, parameters, functions, and techniques.

Score Layout and Printing

Describes the professional music notation, score editing, and printing features included in the **Score Editor**.

Plug-in Reference

Describes the features and parameters of the included VST plug-ins, VST instruments, and MIDI effects.

Remote Control Devices

Lists the supported MIDI remote control devices.

MIDI Devices

Describes how to manage MIDI devices and device panels.

Groove Agent SE

Describes the features and parameters of the included VST instrument Groove Agent SE.

HALion Sonic SE

Describes the features and parameters of the included VST instrument HALion Sonic SE.

Retrologue

Describes the features and parameters of the included VST instrument Retrologue.

Padshop

Describes the features and parameters of the included VST instrument Padshop.

Steinberg Library Manager

Describes how you can register and manage your VST Sound libraries.

Conventions

In our documentation, we use typographical and markup elements to structure information.

Typographical Elements

The following typographical elements mark the following purposes.

Prerequisite

Requires you to complete an action or to fulfill a condition before starting a procedure.

Procedure

Lists the steps that you must take to achieve a specific result.

Important

Informs you about issues that might affect the system, the connected hardware, or that might bring a risk of data loss.

Note

Informs you about issues that you should consider.

Tip

Adds further information or useful suggestions.

Example

Provides you with an example.

Result

Shows the result of the procedure.

After Completing This Task

Informs you about actions or tasks that you can perform after completing the procedure.

Related Links

Lists related topics that you can find in this documentation.

Markup

Bold text indicates the name of a menu, option, function, dialog, window, etc.

EXAMPLE

To open the **Functions** menu, click **Functions Menu** in the top right corner of the **MixConsole**.

If bold text is separated by a greater-than symbol, this indicates a sequence of different menus to open.

EXAMPLE

Select **Project > Add Track**.

Key Commands

Many of the default key commands, also known as keyboard shortcuts, use modifier keys, some of which are different depending on the operating system.

When key commands with modifier keys are described in this manual, they are indicated with the Windows modifier key first, followed by the macOS modifier key and the key.

EXAMPLE

Ctrl/Cmd - Z means: press **Ctrl** on Windows or **Cmd** on macOS, then press **Z**.

Setting up Your System

To use Nuendo, you must set up your audio, and if required, your MIDI system.

Studio Setup Dialog

The **Studio Setup** dialog allows you to set up your connected audio, MIDI, and remote control devices.

- To open the **Studio Setup** dialog, select **Studio > Studio Setup**.

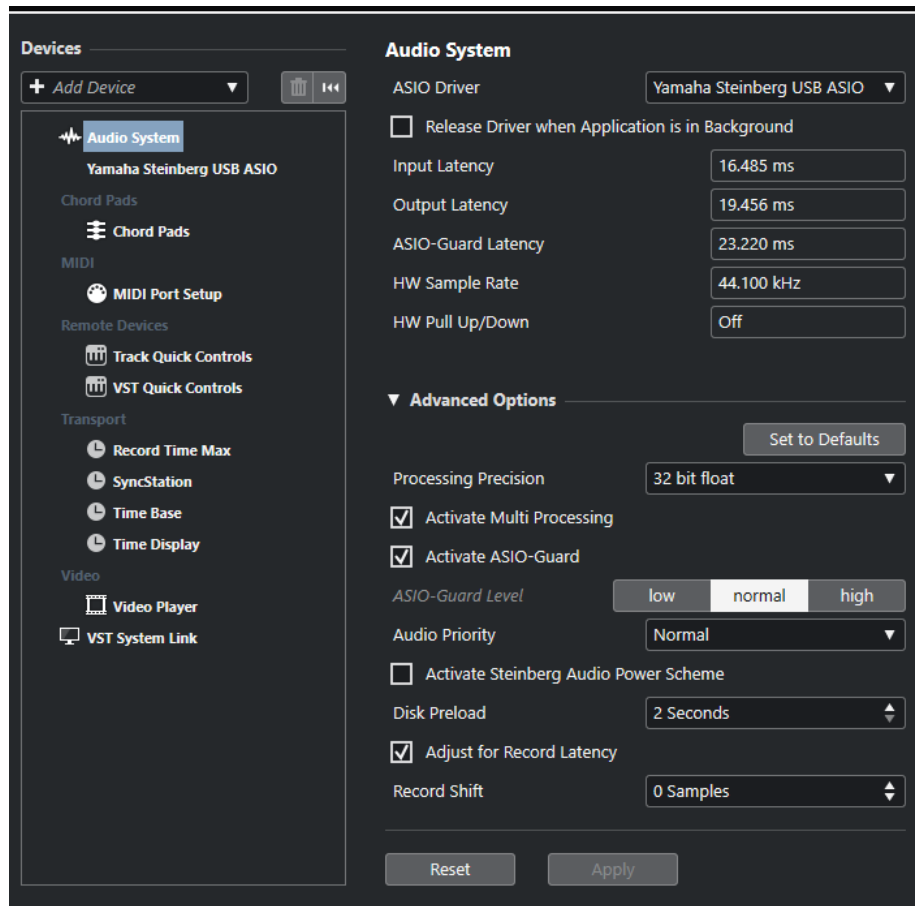

The following options are available:

Add Device

Allows you to manually add devices such as a **Note Expression Input Device**, an additional **Time Display** device, or specific remote control devices.

Remove

Allows you to remove manually added devices.

Reset

Resets all remote control devices in the **Devices** list.

Devices list

Select a device in the **Devices** list to show its settings in the right section.

Setting up Audio

You must set up your audio equipment before you can use it in Nuendo.

IMPORTANT

Make sure that all equipment is turned off before making any connections.

Simple Stereo Input and Output Setup

If you only use a stereo input and output from Nuendo, you can connect your audio hardware, for example, the inputs of your audio card or your audio interface, directly to the input source and the outputs to a power amplifier and speaker.

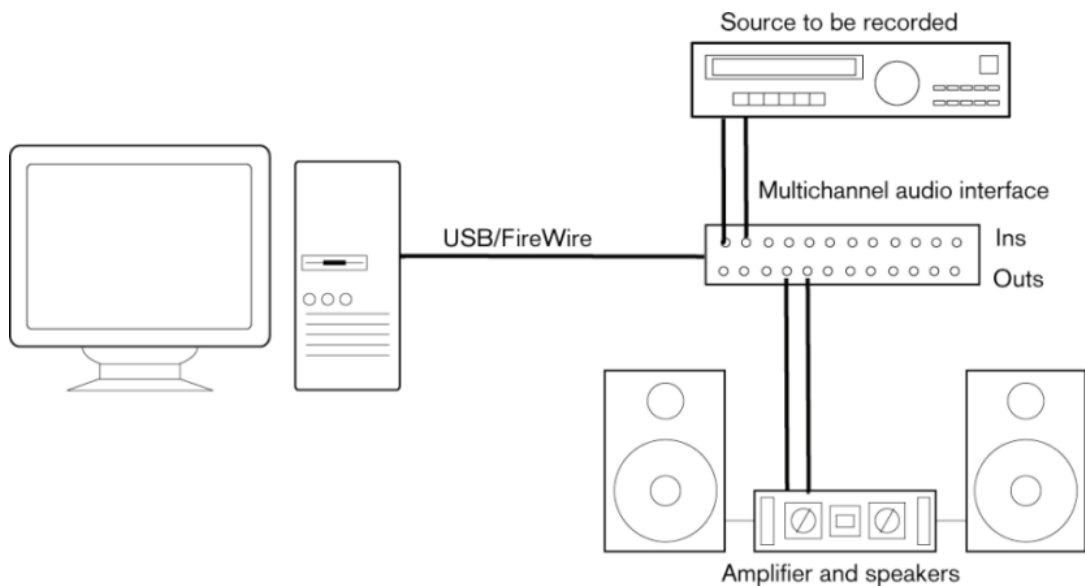

Audio Connections

Your system setup depends on many different factors, for example, on the kind of project that you want to create, on the external equipment that you want to use, or on the computer hardware that is available to you. Therefore, the following sections can only serve as examples.

How to connect your equipment, that is, whether to use digital or analog connections also depends on your setup.

Recording Levels and Inputs

When you connect your equipment, make sure that the impedance and levels of the audio sources and inputs are matched. Using the correct type of input is important to avoid distortion or noisy recordings. For example, different inputs can be used, such as consumer line level (-10 dBV) or professional line level (+4 dBu).

Sometimes, you can adjust input characteristics on the audio interface or on its control panel. For details, refer to the documentation that came with the audio hardware.

IMPORTANT

Nuendo does not provide any input level adjustments for the signals that are coming into your audio hardware, since these are handled differently for each card. Adjusting input levels is either done in a special application that is included with the hardware or its control panel.

Word Clock Connections

If you are using a digital audio connection, you may also need a word clock connection between the audio hardware and external devices. For details, refer to the documentation that came with the audio hardware.

IMPORTANT

Set up word clock synchronization correctly, or you may experience clicks and crackles in your recordings.

Selecting an Audio Driver

By selecting an audio driver, you allow Nuendo to communicate with the audio hardware. Normally, when you start Nuendo, a dialog opens that prompts you to select a driver, but you can also select your audio hardware driver as described below.

NOTE

On Windows operating systems, we recommend that you access your hardware via an ASIO driver developed specifically for the hardware. If no ASIO driver is installed, contact the manufacturer of your audio hardware for information on available ASIO drivers. If no specific ASIO driver is available, you can use the Generic Low Latency ASIO driver.

PROCEDURE

1. Select **Studio > Studio Setup**.
 2. In the **Devices** list, select **Audio System**.
 3. Open the **ASIO Driver** pop-up menu and select your audio hardware driver.
 4. Click **OK**.
-

Setting up Audio Hardware

You must select and set up your audio hardware in the **Studio Setup** dialog before you can use it.

PREREQUISITE

You have selected a driver for your audio hardware.

PROCEDURE

1. Select **Studio > Studio Setup**.
2. In the **Devices** list, select your audio hardware driver.
3. Do one of the following to open the control panel for your audio hardware:
 - On Windows, click **Control Panel**.
 - On macOS, click **Open Config App**.
This button is available only for some hardware products. If it is not available in your setup, refer to the documentation of your audio hardware.

NOTE

The control panel is provided by the manufacturer of your audio hardware and is different for each audio interface brand and model. However, control panels for the Generic Low Latency ASIO Driver (Windows only) are provided by Steinberg.

4. Set up your audio hardware as recommended by the manufacturer.

Audio System Page

On the **Audio System** page you can select an ASIO driver for your audio hardware.

- To open the **Audio System** page, select **Studio > Studio Setup** and select **Audio System** in the **Devices** list.

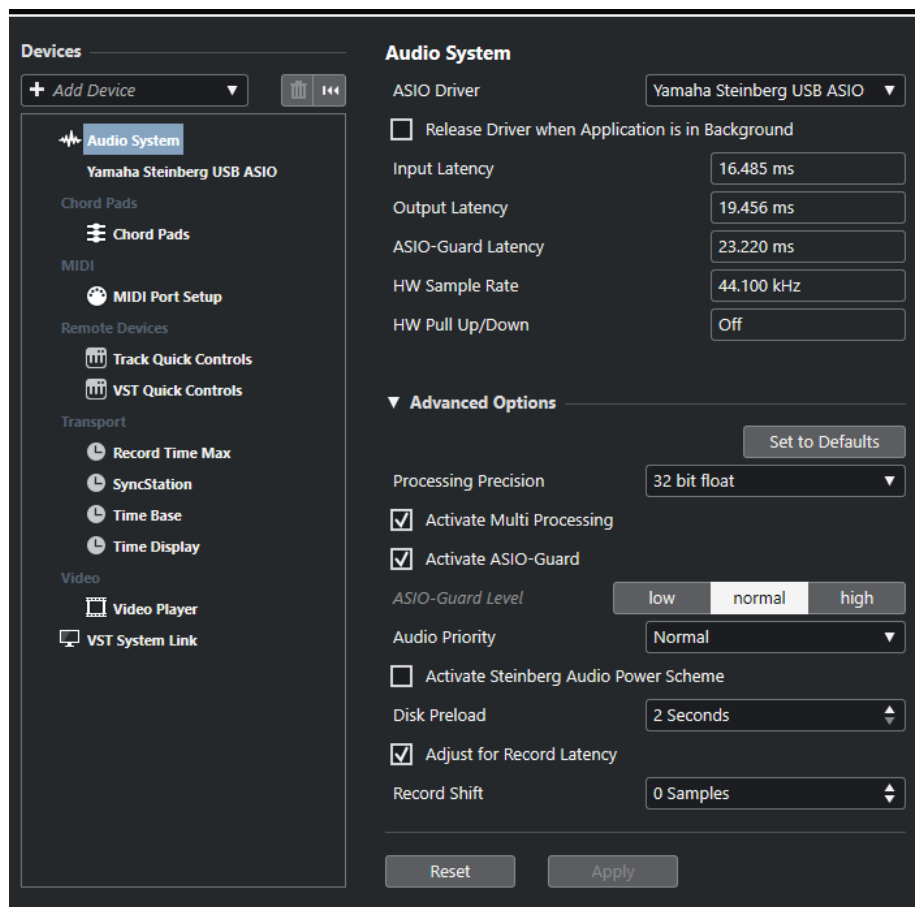

The following options are available:

ASIO Driver

Allows you to select a driver.

Release Driver when Application is in Background

Releases the driver and allows other applications to play back via your audio hardware even though Nuendo is running.

Input Latency

Shows the input latency of the audio hardware.

Output Latency

Shows the output latency of the audio hardware.

ASIO-Guard Latency

Shows the ASIO-Guard latency.

HW Sample Rate

Shows the sample rate of your audio hardware.

HW Pull Up/Down

Shows the pull up/down status of the audio hardware.

In the **Advanced Options** section, the following options are available:

Set to Defaults

Allows you to restore the default settings.

Processing Precision

Allows you to set the audio processing precision to 32 bit float or 64 bit float. Depending on this setting, all channels are processed and mixed in 32-bit floating-point or 64-bit floating-point format.

NOTE

A processing precision of 64 bit float can increase CPU load and memory consumption.

To show all plug-ins that support 64-bit float processing, open the **VST Plug-in Manager** and activate **Show Plug-ins That Support 64-Bit Float Processing** in the **Display Options** pop-up menu.

NOTE

VST 2 plug-ins and instruments are always processed with 32-bit precision.

Activate Multi Processing

Allows you to distribute the processing load evenly to all available CPUs. This way, Nuendo can make full use of the combined power of multiple processors.

Activate ASIO-Guard

Activates the ASIO-Guard. This is only available if **Activate Multi Processing** is activated.

ASIO-Guard Level

Allows you to set the ASIO-Guard level. The higher the level, the higher the processing stability and audio processing performance. However, higher levels also lead to an increased ASIO-Guard latency and memory usage.

Audio Priority (Windows only)

This setting should be set to **Normal** if you work with audio and MIDI. If you do not use MIDI at all, you can set this to **Boost**.

Activate Steinberg Audio Power Scheme

If this option is activated, all power safe modes that have an impact on real time processing are deactivated. Note that this is only effective for very low latencies, and that it increases the power consumption.

Disk Preload

Allows you to specify how many seconds of audio are preloaded into RAM prior to starting playback. This allows for smooth playback.

Adjust for Record Latency

If this is activated, the plug-in latencies are taken into account during recording.

Record Shift

Allows you to shift the recordings by the specified value.

In the general section, the following options are available:

Reset

Resets the selected remote device.

Apply

Applies the settings.

RELATED LINKS

[VST Plug-in Manager Window](#) on page 853

ASIO Driver Setup Page

This page allows you to set up your ASIO driver.

- To open the page where you can set up the ASIO driver, select **Studio > Studio Setup** and select the audio driver in the **Devices** list.

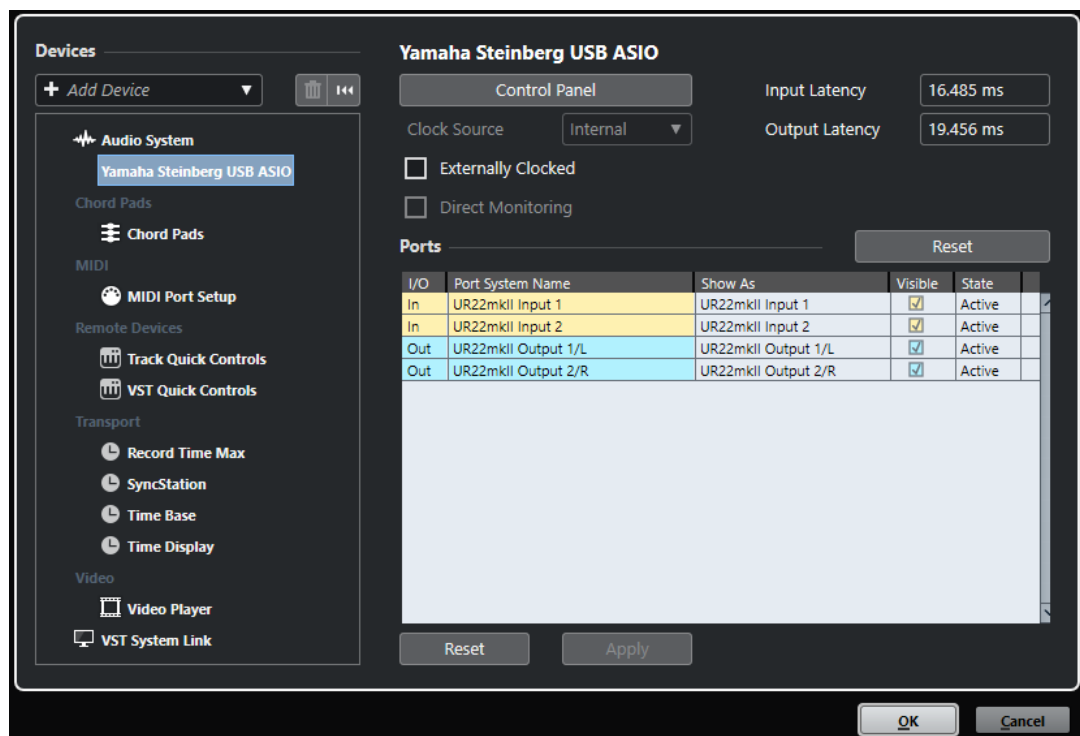

The following options are available:

Control Panel

Opens the control panel for the audio hardware.

Input Latency

Shows the input latency of the audio driver.

Output Latency

Shows the output latency of the audio driver.

Clock Source

Allows you to select a clock source.

Externally Clocked

Activate this option if you use an external clock source.

Direct Monitoring

Activate this option to monitor via your audio hardware and to control it from Nuendo.

In the **Ports** section, the following options are available:

Reset

Allows you to reset all port names and visibilities.

I/O

The port input/output status.

Port System Name

The system name of the port.

Show As

Allows you to rename the port. This name is used in the **Input Routing** and **Output Routing** pop-up menus.

Visible

Allows you to activate/deactivate audio ports.

State

The state of the audio port.

In the general section, the following options are available:

Reset

Resets the selected remote device.

Apply

Applies the settings.

Using External Clock Sources

If you are using an external clock source, Nuendo must be notified that it receives external clock signals and derives its speed from that source.

PROCEDURE

1. Select **Studio > Studio Setup**.
2. In the **Devices** list, select your audio hardware driver.
3. Activate **Externally Clocked**.

RESULT

Nuendo now derives its speed from the external source.

NOTE

For proper audio playback and recording, you must set the sample rate of the project to the sample rate of the incoming clock signals.

When a sample rate mismatch occurs, the **Record Format** field on the **Project** window status line is highlighted in a different color. Nuendo accepts a sample rate mismatch, and playback is therefore faster or slower.

Using Several Audio Applications Simultaneously

You can allow other applications to play back via your audio hardware even though Nuendo is running.

PREREQUISITE

Other audio applications accessing the audio hardware are set to release the audio driver.

PROCEDURE

1. Select **Studio > Studio Setup**.
 2. In the **Devices** list, select **Audio System**.
 3. Activate **Release Driver when Application is in Background**.
-

RESULT

The application that has the focus gets access to the audio hardware.

Audio Hardware Configuration

Most audio cards provide one or more small applications that allow you to customize your hardware.

The settings are normally gathered on a control panel that can be opened from within Nuendo or separately, when Nuendo is not running. For details, refer to the audio hardware documentation.

Settings include:

- Selecting which inputs/outputs are active.
- Setting up word clock synchronization.
- Turning on/off monitoring via the hardware.
- Setting levels for each input.
- Setting levels for the outputs so that they match the equipment that you use for monitoring.
- Selecting digital input and output formats.
- Making settings for the audio buffers.

Setting up Input and Output Ports

Once you have selected the driver for your audio hardware and have set it up, you must specify which inputs and outputs to use.

PREREQUISITE

You have selected a driver for your audio hardware.

PROCEDURE

1. Select **Studio > Studio Setup**.
 2. In the **Devices** list, select your audio hardware driver.
 3. Make your changes.
 4. Click **OK**.
-

RELATED LINKS

[ASIO Driver Setup Page](#) on page 21

Audio Bus Setup

Nuendo uses a system of input and output busses to transfer audio between the program and the audio hardware.

- Input busses let you route audio from the inputs of your audio hardware into Nuendo. This means that audio is always recorded through one or several input busses.
- Output busses let you route audio from Nuendo to the outputs of your audio hardware. This means that audio is always played back through one or several output busses.

Once you have set up the internal input and output busses, you can connect your audio source, for example, a microphone, to your audio interface and start recording, playing back, and mixing.

RELATED LINKS

[Audio Connections](#) on page 28

Monitoring

In Nuendo, monitoring means listening to the input signal while recording.

The following ways of monitoring are available:

- Externally by listening to the signal before it reaches Nuendo.
- Via Nuendo.
- By using ASIO Direct Monitoring.

This is a combination of the other methods.

RELATED LINKS

[External Monitoring](#) on page 295

[Monitoring via Nuendo](#) on page 295

[ASIO Direct Monitoring](#) on page 296

Setting up MIDI

You must set up your MIDI equipment before you can use it in Nuendo.

IMPORTANT

Turn off all equipment before making any connections.

PROCEDURE

1. Connect your MIDI equipment (keyboard, MIDI interface, etc.) to your computer.
 2. Install the drivers for your MIDI equipment.
-

RESULT

You can use your MIDI equipment in Nuendo.

MIDI Connections

To play back and record MIDI data from your MIDI device, for example, a MIDI keyboard, you need to connect the MIDI ports.

Connect the MIDI output port of your MIDI device to the MIDI input port of your audio hardware. This way, the MIDI device sends MIDI data to be played back or recorded inside your computer.

Connect the MIDI input port of your MIDI device to the MIDI output port of your audio hardware. This way, you can send MIDI data from Nuendo to the MIDI device. For example, you can record your own playing, edit the MIDI data in Nuendo, and then play it back on the keyboard and record the audio that is coming out of the keyboard for a better edited performance.

Showing or Hiding MIDI Ports

You can show the MIDI ports that you want to use and hide those that you do not use on the MIDI pop-up menus in the program.

PROCEDURE

1. Select **Studio > Studio Setup**.
 2. In the **Devices** list, select **MIDI Port Setup**.
 3. To hide a MIDI port, deactivate its **Visible** column.
 4. Click **OK**.
-

Setting up All MIDI Inputs

When you record MIDI, you can specify which MIDI input each recording MIDI track should use. However, you can also record any MIDI data from any MIDI input. You can specify which inputs are included when you select **All MIDI Inputs** for a MIDI track.

PROCEDURE

1. Select **Studio > Studio Setup**.
2. In the **Devices** list, select **MIDI Port Setup**.
3. Activate **In 'All MIDI Inputs'** for a port.

NOTE

If you have a MIDI remote control unit connected, make sure to deactivate the **In 'All MIDI Inputs'** option for that MIDI input. This avoids accidental recording of data from the remote control when **All MIDI Inputs** is selected as input for a MIDI track.

4. Click **OK**.
-

RESULT

When you select **All MIDI Inputs** on the **Input Routing** pop-up menu of a MIDI track in the **Inspector**, the MIDI track uses all MIDI inputs that you specified in the **MIDI Port Setup**.

MIDI Port Setup Page

The **MIDI Port Setup** page in the **Studio Setup** dialog displays the connected MIDI devices and allows you to set up their ports.

- To open the **MIDI Port Setup** page, select **Studio > Studio Setup** and activate **MIDI Port Setup** in the **Devices** list.

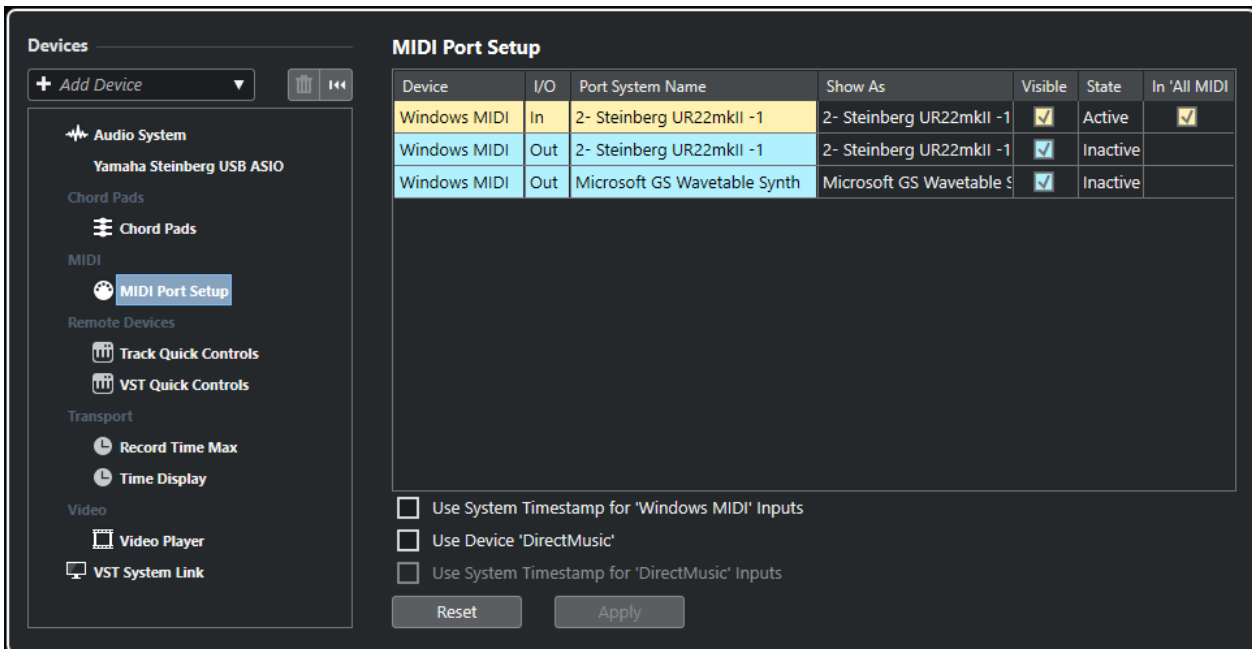

The following columns are displayed:

Device

The connected MIDI devices.

I/O

The port input/output status.

Port System Name

The system name of the port.

Show As

Allows you to rename the port. This name is used in the **Input Routing** and **Output Routing** pop-up menus.

Visible

Allows you to activate/deactivate MIDI ports.

State

The state of the MIDI port.

In 'All MIDI Inputs'

Allows you to record MIDI data from all MIDI inputs.

NOTE

Deactivate this option if you use remote control devices.

The following options are available:

Use System Timestamp for 'Windows MIDI' Inputs

Activate this option if you have persistent timing problems such as shifted notes. If this is activated, the system timestamp is used as a time reference.

Use Device 'DirectMusic'

This option is activated by default. This allows you to use devices with a DirectMusic device driver.

Use System Timestamp for 'DirectMusic' Inputs

Activate this option if you have persistent timing problems such as shifted notes. If this is activated, the system timestamp is used as a time reference.

In the general section, the following options are available:

Reset

Resets the selected remote device.

Apply

Applies the settings.

Plug and Play Support for USB MIDI Devices

Nuendo supports plug and play of USB MIDI devices. These devices can be plugged in and switched on while the application is running.

Synchronizers

When using Nuendo with external tape transports, you most likely must add a synchronizer to your system.

IMPORTANT

Make sure that all equipment is turned off before making any connections.

For information on how to connect and set up your synchronizer, refer to the documentation of your synchronizer.

RELATED LINKS

[Synchronization](#) on page 1204

Audio Connections

To play back and record in Nuendo, you must set up input and output busses in the **Audio Connections** window. Here, you can also set up group and FX channels, external effects, external instruments, and the **Control Room**.

The bus types that you need depend on your audio hardware, on your general audio setup, for example your surround speaker setup, and on the projects that you use.

Audio Connections Window

The **Audio Connections** window allows you to set up input and output busses, group and FX channels, external effects, and external instruments. Furthermore, you can use this window to access and configure the **Control Room**.

- To open the **Audio Connections** window, select **Studio > Audio Connections**.

Inputs/Outputs Tab

The **Inputs** and **Outputs** tabs allow you to set up and configure input and output busses.

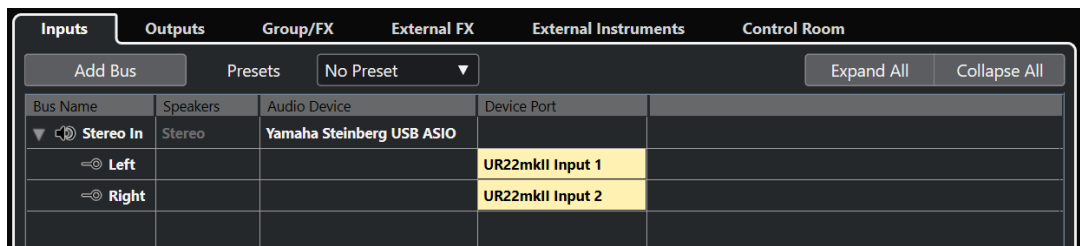

The following options are available above the bus list:

Add Bus

Opens the **Add Input Bus** dialog, where you can create a new bus configuration.

Presets

Opens the **Presets** pop-up menu, where you can select bus configuration presets. **Store** allows you to save a bus configuration as preset. **Delete** deletes the selected preset.

Expand All/Collapse

Expands/Collapses all busses in the bus list.

The following columns are available for the bus list:

Bus Name

Lists the busses. Click the name of a bus to select or rename it.

Speakers

Indicates the speaker configuration (mono, stereo, surround formats) of each bus.

Audio Device

Shows the selected ASIO driver.

Device Port

Shows which physical inputs/outputs on your audio hardware are used by the bus. Expand the bus entry to show all speaker channels. If the bus entry is collapsed, only the first port that is used by this bus is visible.

The **Device Port** pop-up menu displays how many busses are connected to a given port. The busses are shown in square brackets next to the port name.

Up to 3 bus assignments can be displayed in this way. If more connections have been made, this is indicated by a number at the end of the port name.

For example, "Adat 1 [Stereo1] [Stereo2] [Stereo3] (+2)" means that the Adat1 port is already assigned to 3 stereo busses plus 2 additional busses.

Group/FX Tab

This tab allows you to create group and FX channels/tracks and to make output assignments for these.

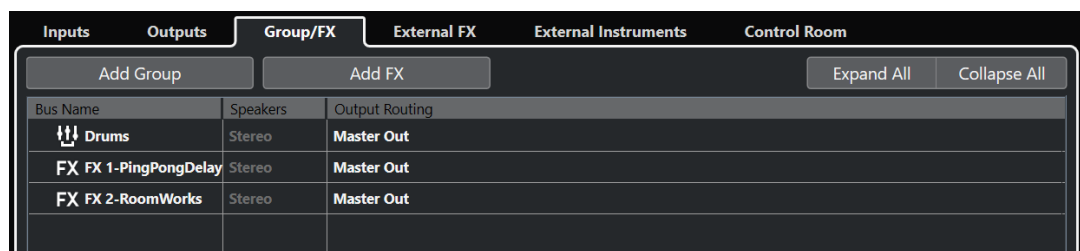

The following options are available above the bus list:

Add Group

Opens the **Add Group Channel Track** dialog, where you can create a new group channel track.

Add FX

Opens the **Add FX Channel Track** dialog, where you can create a new FX channel track.

Expand All/Collapse

Expands/Collapses all busses in the bus list.

The following columns are available for the bus list:

Bus Name

Lists the busses. Click the name of a bus to select or rename it.

Speakers

Indicates the speaker configuration (mono, stereo, surround formats) of each bus.

Output Routing

Lets you select the output routing for the corresponding bus.

External FX Tab

This tab allows you to create send effect or return busses. You can use these to connect external effects which can then be selected via the effect pop-up menus from inside the program.

The following options are available above the bus list:

Add External FX

Opens the **Add External FX** dialog, where you can configure a new external FX.

Favorites

Lets you store external effect configurations as favorites that you can recall.

Expand All/Collapse

Expands/Collapses all busses in the bus list.

The following columns are available for the bus list:

Bus Name

Lists the busses. Click the name of a bus to select or rename it.

Speakers

Indicates the speaker configuration (mono, stereo, surround formats) of each bus.

Audio Device

Shows the selected ASIO driver.

Device Port

Shows which physical inputs/outputs on your audio hardware are used by the bus. Expand the bus entry to show all speaker channels. If the bus entry is collapsed, only the first port that is used by this bus is visible.

The **Device Port** pop-up menu displays how many busses are connected to a given port. The busses are shown in square brackets next to the port name.

Up to 3 bus assignments can be displayed in this way. If more connections have been made, this is indicated by a number at the end of the port name.

For example, "Adat 1 [Stereo1] [Stereo2] [Stereo3] (+2)" means that the Adat1 port is already assigned to 3 stereo busses plus 2 additional busses.

Delay

Allows you to enter a value to compensate for an inherent delay (latency) of your hardware effect device during playback. You can right-click the **Delay** column for the effect and select **Check User Delay** to automatically determine the delay value.

NOTE

The latency of the audio hardware is handled automatically by Nuendo.

Send Gain

Allows you to adjust the level of the signal that is sent to the external effect.

Return Gain

Allows you to adjust the level of the signal that the external effect sends.

NOTE

Excessive output levels from an external effect device can cause clipping in the audio hardware. You cannot use the **Return Gain** setting to compensate for this. You must lower the output level on the effect device instead.

MIDI Device

When you click in this column, a pop-up menu opens where you can disconnect the effect from the associated MIDI device, select a MIDI device, create a new device, or open the **MIDI Device Manager** to edit the MIDI device.

Used

Whenever you insert an external effect into an audio track, this column shows a checkmark (x) to indicate that the effect is being used.

External Instruments Tab

This tab allows you to create input/output busses that can be used to connect external instruments.

Bus Name	Speakers	Audio Device	Device Port	Delay	Return Gain	MIDI Device	Used
External Instrument	1 Return(s)			0.00 ms (0)	0.00 dB	No Link	
Return Bus 1	Stereo	Yamaha Steinberg USB A					
Left			UR22mkII Input 1				
Right			UR22mkII Input 2				

The following options are available above the bus list:

Add External Instrument

Opens the **Add External Instrument** dialog, where you can configure a new external instrument.

Favorites

Lets you store external instrument configurations as favorites that you can recall.

Expand All/Collapse

Expands/Collapses all busses in the bus list.

The following columns are available for the bus list:

Bus Name

Lists the busses. Click the name of a bus to select or rename it.

Speakers

Indicates the speaker configuration (mono, stereo, surround formats) of each bus.

Audio Device

Shows the selected ASIO driver.

Device Port

Shows which physical inputs/outputs on your audio hardware are used by the bus. Expand the bus entry to show all speaker channels. If the bus entry is collapsed, only the first port that is used by this bus is visible.

The **Device Port** pop-up menu displays how many busses are connected to a given port. The busses are shown in square brackets next to the port name.

Up to 3 bus assignments can be displayed in this way. If more connections have been made, this is indicated by a number at the end of the port name.

For example, "Adat 1 [Stereo1] [Stereo2] [Stereo3] (+2)" means that the Adat1 port is already assigned to 3 stereo busses plus 2 additional busses.

Delay

Allows you to enter a value to compensate for an inherent delay (latency) of your hardware effect device during playback. You can right-click the **Delay** column for the instrument and select **Check User Delay** to automatically determine the delay value that is used for delay compensation.

NOTE

The latency of the audio hardware is handled automatically by Nuendo.

Return Gain

Allows you to adjust the level of the signal coming in from the external instrument.

NOTE

Excessive output levels from an external effect device can cause clipping in the audio hardware. The **Return Gain** setting cannot be used to compensate for this. You must lower the output level on the effect device instead.

MIDI Device

When you click in this column, a pop-up menu opens where you can disconnect the instrument from the associated MIDI device, select a MIDI device, create a new device, or open the **MIDI Device Manager** to edit the MIDI device.

Used

Whenever you insert the external instrument into a VST instrument slot, this column shows a checkmark (x) to indicate that the instrument is being used.

Control Room Tab

This tab allows you to enable and configure the **Control Room**.

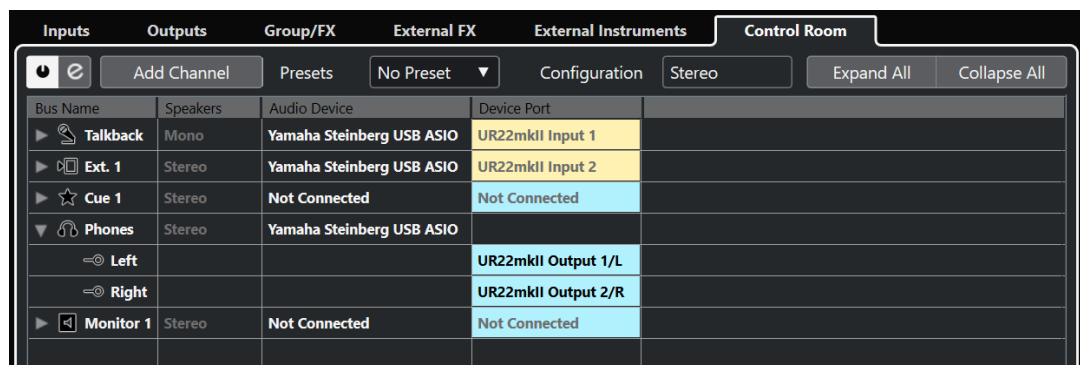

The following options are available above the bus list:

Enable/Disable Control Room

Enables/Disables the **Control Room**.

Open Control Room

Opens the **Control Room** window.

Add Channel

Opens a pop-up menu where you can select the type of channel that you want to add. You can add the following channels:

- External Input
- Talkback
- Cue
- Headphone
- Monitor
- Monitor Source

Presets

Opens the **Presets** pop-up menu, where you can select bus configuration presets. **Store** allows you to save a bus configuration as preset. **Delete** deletes the selected preset.

NOTE

You can save the insert slots for **Cue**, **Monitor** and **Control Room** channels in the presets. This is useful, as they are not saved with the project.

Configuration

Displays the selected channel configuration.

Expand All/Collapse

Expands/Collapses all busses in the bus list.

The following columns are available for the bus list:

Bus Name

Lists the busses. Click the name of a bus to select or rename it.

Speakers

Indicates the speaker configuration (mono, stereo, surround formats) of each bus.

Audio Device

Shows the selected ASIO driver.

Device Port

Shows which physical inputs/outputs on your audio hardware are used by the bus. Expand the bus entry to show all speaker channels. If the bus entry is collapsed, only the first port that is used by this bus is visible.

The **Device Port** pop-up menu displays how many busses are connected to a given port. The busses are shown in square brackets next to the port name.

Up to 3 bus assignments can be displayed in this way. If more connections have been made, this is indicated by a number at the end of the port name.

For example, "Adat 1 [Stereo1] [Stereo2] [Stereo3] (+2)" means that the Adat1 port is already assigned to 3 stereo busses plus 2 additional busses.

RELATED LINKS

[Control Room](#) on page 479

Renaming the Hardware Inputs and Outputs

Before you set up busses, you should rename the default inputs and outputs of your audio hardware. This allows transferring projects between different computers and setups.

For example, if you move your project to another studio, the audio hardware may be of a different model. But if you and the other studio owner have agreed on identical names for your inputs and outputs, Nuendo corrects inputs and outputs for your busses.

NOTE

If you open a project that was created on another computer and the port names do not match or the port configuration is not the same, the **Missing Ports** dialog appears. This allows you to manually re-route ports that are used in the project to ports that are available on your computer.

PROCEDURE

1. Select **Studio > Studio Setup**.
 2. In the **Devices** list, select **Audio System**.
 3. Open the **ASIO Driver** pop-up menu and select your audio hardware driver.
 4. In the **Devices** list, select your audio hardware driver.
 5. In the **Show As** column, click on a port name and enter a new name.
 6. Repeat the previous step until you have renamed all required ports.
 7. Click **OK**.
-

RELATED LINKS

[Re-Routing Missing Ports](#) on page 113

Hiding Ports

You can hide ports that you are not using. Hidden ports are not displayed in the **Audio Connections** window.

PROCEDURE

1. Select **Studio > Studio Setup**.
 2. In the **Devices** list, select your audio hardware driver.
 3. In the **Visible** column, deactivate the ports that you want to hide.
 4. Click **OK**.
-

Activating and Deactivating Ports (macOS only)

On macOS you can specify which input and output ports are active. This allows you to use the microphone input instead of the line input or to deactivate the audio card input or output.

NOTE

This function is only available for built-in audio, standard USB audio devices, and a certain number of other audio cards.

PROCEDURE

1. Select **Studio > Studio Setup**.

2. In the **Devices** list, select your audio hardware driver.
 3. Click **Control Panel**.
 4. Activate/Deactivate ports.
 5. Click **OK**.
-

Adding Input and Output Busses

You must add input and output busses to establish the connection between your audio hardware and Nuendo.

PROCEDURE

1. In the **Audio Connections** dialog, click the **Inputs** or **Outputs** tab.
 2. Click **Add Bus**.
 3. In the **Add Input Bus** dialog, configure the bus.
 4. Optional: Enter a name for the bus.
If you do not specify a name, the bus is named according to the channel configuration.
 5. Click **Add Bus**.
The new bus is added to the bus list.
 6. For each of the speaker channels in the bus, click in the **Device Port** column and select a port of your audio hardware.
-

Setting the Default Output Bus (Main Mix)

The **Main Mix** is the default output bus to which each new audio, group, or FX channel is automatically routed. If only one bus is available, this bus is automatically used as the default output bus.

PREREQUISITE

Add an output bus.

PROCEDURE

1. In the **Audio Connections** dialog, right-click the output bus that you want to use as default output bus.
 2. Select **Set <bus name> as Main Mix**.
-

RESULT

The selected bus is used as default bus. The **Main Mix** is indicated by a speaker icon next to its name.

RELATED LINKS

[Inputs/Outputs Tab](#) on page 28

Adding Child Busses

Child busses allow you to route tracks to particular channels within a bus.

For example, you can route a stereo track to a stereo channel pair within a surround bus. Or you can record a stereo channel pair in the surround bus to a separate stereo track.

PROCEDURE

1. On the **Inputs** tab, **Outputs** tab, or **Group/FX** tab, right-click a surround bus.
 2. Click **Add Child Bus** and select a channel configuration.
-

RESULT

The child bus is created and can be used for routing.

Presets for Input and Output Busses

For input and output bus configurations, you can use different kinds of presets.

- A number of standard bus configurations.
- Automatically created presets tailored to your specific hardware configuration.
On startup, Nuendo analyzes the physical inputs and outputs that are provided by your audio hardware and creates a number of hardware-dependent presets.
- Your own presets.

NOTE

You can create default presets for input and output bus configurations. If you create a new empty project, these default presets are applied. To create default presets, save your preferred input and output bus configurations under the name **Default**. If you have not defined default presets, the last used input and output bus configuration is applied when creating a new empty project.

Saving a Bus Configuration Preset

You can save your own input and output bus configuration and the studio configuration as presets.

PROCEDURE

1. Select **Studio > Audio Connections**.
 2. Click the **Inputs** or **Outputs** tab, and set up your bus configuration.
 3. Click **Store**.
 4. In the **Type in Preset Name** dialog, enter a name.
 5. Click **OK**.
-

RESULT

The preset is available in the **Presets** menu.

Deleting a Bus Configuration Preset

You can delete bus configuration presets that you no longer need.

PROCEDURE

1. Select **Studio > Audio Connections**.
 2. Click the **Inputs** or **Outputs** tab, and from the **Presets** menu, select the preset that you want to delete.
 3. Click **Delete**.
-

RESULT

The preset is deleted.

Adding Group and FX Channels

Group channels and FX channels allow you to group bus configurations.

Adding group and FX channels in the **Audio Connections** window is identical to creating group channel tracks or FX channel tracks in the **Project** window.

PROCEDURE

1. In the **Audio Connections** dialog, click the **Group/FX** tab.
 2. Do one of the following:
 - To create a group channel, click **Add Group**.
 - To create an FX channel, click **Add FX**.
 3. Configure the channel.
 4. Optional: Enter a name for the group channel track.
 5. Click **OK**.
The group channel or FX channel is added to the bus list.
 6. For each of the speaker channels in the bus, click in the **Output Routing** column and select a port of your audio hardware.
-

RELATED LINKS

[Audio Effects](#) on page 502

Monitoring Bus

In the **Audio Connections** window, you can set up the busses that are used for monitoring, activate/deactivate and open the **Control Room**.

When the **Control Room** is disabled on the **Control Room** tab of the **Audio Connections** window, the **Main Mix** bus is used for monitoring. In this case, you can adjust the monitoring level in the **MixConsole**.

RELATED LINKS

[Setting the Default Output Bus \(Main Mix\)](#) on page 35

[Control Room](#) on page 479

[MixConsole](#) on page 402

External Instruments and Effects

You can integrate external effect devices and external instruments, for example, hardware synthesizers, into the sequencer signal flow.

Requirements

- To use external effects, you need audio hardware with multiple inputs and outputs.
An external effect requires at least one input and one output or input/output pairs for stereo effects in addition to the input/output ports that you use for recording and monitoring.
- To use external instruments, a MIDI interface must be connected to your computer.

- Audio hardware with low-latency drivers.
Nuendo compensates for the input/output latency and ensures that the audio that is processed through external effects is not shifted in time.

Connecting an External Instrument/Effect

You can connect external instruments/effects to the audio hardware of your computer.

PREREQUISITE

The hardware device has stereo inputs and outputs.

PROCEDURE

1. Connect an unused output pair on your audio hardware to the input pair on your external hardware device.
2. Connect an unused input pair on your audio hardware to the output pair on your hardware device.

IMPORTANT

If you select input/output ports for external instruments/effects that are already used, the existing port assignment breaks without warning.

AFTER COMPLETING THIS TASK

Once the external device is connected to the audio hardware of your computer, you must set up the external input/output busses, as well as the external effects/instruments in Nuendo.

RELATED LINKS

[Setting up Input and Output Ports](#) on page 23

[Setting up External Effects](#) on page 38

[Setting up External Instruments](#) on page 41

Setting up External Effects

You must set up external effects in Nuendo before you can use them.

PROCEDURE

1. In the **Audio Connections** window, click the **External FX** tab.
2. Click **Add External FX**.
3. In the **Add External FX** dialog, enter a name for the external effect and specify the send and return configurations.
Depending on the type of effect, you can specify mono, stereo, or surround configurations.
4. Click **Associate MIDI Device** and select a MIDI device.

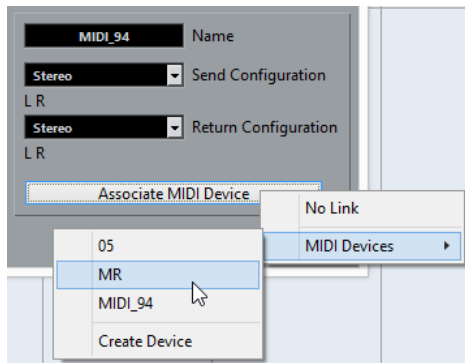

You can also select **MIDI Devices > Create Device** and create a new MIDI device association.

NOTE

Delay compensation is only applied for the effect when you use MIDI devices.

5. Click **OK**.
This adds a new external FX bus.
6. Click in the **Device Port** column for the left and right ports of the send bus and select the outputs of your audio hardware that you want to use.
7. Click in the **Device Port** column for the left and right ports of the return bus and select the inputs of your audio hardware that you want to use.
8. Make additional settings for the bus.
You can also adjust the settings while using the external effect. This allows you to hear the result.

RELATED LINKS

[Using MIDI Devices](#) on page 891

[Delay Compensation](#) on page 846

Adding External Effects

You can use the external FX bus as an insert effect or as a send effect, which is an insert effect on an FX channel track.

PREREQUISITE

Set up your external effects in the **Audio Connections** window.

PROCEDURE

1. In the **Inspector**, open the **Inserts** panel.
2. Open the **Select Insert** menu.

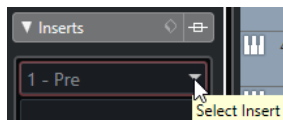

3. Select an external effect from the **External Plug-ins** submenu.
External effects are indicated by an **x** icon in the list next to their names in the **Select Insert** pop-up menu.

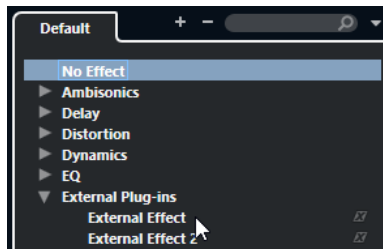

RESULT

The external FX bus is loaded into the effect slot.

A parameter window opens, showing the Delay, Send Gain, and Return Gain settings for the external FX bus. You can adjust these settings while playing back.

The audio signal from the channel is sent to the outputs on the audio hardware, through your external effect device, and back to the program via the inputs on the audio hardware.

RELATED LINKS

[Setting up External Effects](#) on page 38

External Effect Parameter Window

This window allows you to make delay and gain settings for the selected external effect.

- To open the **External Effect Parameter** window, select an external effect from the **Select Insert** pop-up menu in the **Inspector**.

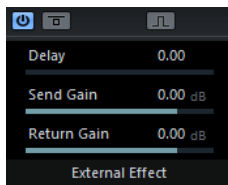

Activate Effect



Activates/Deactivates the external effect.

Bypass Effect



Allows you to bypass the external effect.

Measure Effect's Loop Delay for Delay Compensation



If this option is activated, Nuendo automatically determines the delay value that is used for delay compensation. This is the same function as the **Check User Delay** option in the **Audio Connections** window.

When you have defined a MIDI device for the effect, the corresponding device window opens.

Delay

Allows you to adjust the delay for the external effect.

Send Gain

Allows you to adjust the send gain for the external effect.

Return Gain

Allows you to adjust the return gain for the external effect.

Setting up External Instruments

You must set up external instruments in Nuendo before you can use them.

PROCEDURE

1. In the **Audio Connections** window, click the **External Instruments** tab.
 2. Click **Add External Instrument**.
 3. In the **Add External Instrument** dialog, enter a name for the external instrument and specify the number of required mono and/or stereo returns.
Depending on the type of instrument, a specific number of mono and/or stereo return channels is required.
 4. Click **Associate MIDI Device** and select a MIDI device.
 5. Click **OK**.
This adds a new external instrument bus.
 6. Click in the **Device Port** column for the left and right ports of the return bus and select the inputs of your audio hardware to which you connected the external instrument.
 7. Make additional settings for the bus.
You can also adjust the settings while using the external instrument. This allows you to hear the result.
-

RELATED LINKS

[Using MIDI Devices](#) on page 891

Adding External Instruments

You can add external instruments to the VST instruments list.

PREREQUISITE

Set up your external instruments in the **Audio Connections** window.

PROCEDURE

1. Select **Studio > VST Instruments**.
2. Click **Add Track Instrument**.
3. Select an external instrument from the **Instrument** pop-up menu.
External instruments are indicated by an **x** icon in the list next to their names in the **Instrument** pop-up menu.

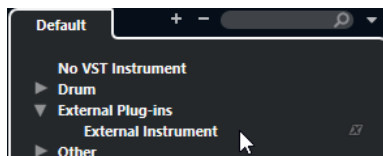

4. Click **OK**.
-

RESULT

The external instrument is added to the VST instruments list.

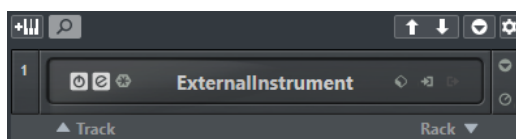

A parameter window for the external instrument opens. This can either be the device window that allows you to create a generic device panel, an OPT editor window, or a default editor.

RELATED LINKS

[VST Instruments Window](#) on page 839

External Instruments Parameter Window

This window allows you to make delay and gain settings for the selected external instrument.

- To open the **External Instrument Parameter** window, select an external instrument in the **VST Instruments** window.

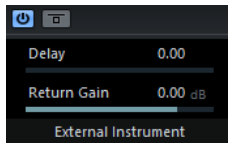

Activate External Instrument



Activates/Deactivates the external instrument.

Bypass External Instrument



Allows you to bypass the external instrument.

Delay

Allows you to adjust the delay for the external instrument.

Return Gain

Allows you to adjust the return gain for the external instrument.

Sending MIDI Notes to External Instruments

You can send MIDI notes from a MIDI track to an external instrument.

PREREQUISITE

Set up your external instruments in the **Audio Connections** window and add a MIDI track.

PROCEDURE

1. In the **Inspector**, open the **Output Routing** pop-up menu for the corresponding MIDI track.
2. Select the MIDI device to which the external instrument is connected.

RESULT

The instrument plays any MIDI notes that it receives from the track and returns them to Nuendo through the return channels that you have set up. Delay compensation is used.

The external instrument behaves like any other VST instrument in Nuendo.

RELATED LINKS

[Delay Compensation](#) on page 846

Saving External Instrument and Effect Configurations as Favorites

You can save external instruments and external effects as favorites. Favorites are device configurations that you can recall. They also allow you to save different configurations for the

same device, for example, a multi-effect board or an effect that provides both a mono and a stereo mode.

PROCEDURE

1. Select **Studio > Audio Connections**.
2. Open the **External Instruments** or the **External FX** tab.
3. Select the bus in the list, and click **Favorites**.
4. Select **Add Selected Instrument/Effect to Favorites**.

RESULT

The external instrument or effect configuration is saved as a favorite. You can recall a favorite by clicking **Favorites** and selecting the configuration that you want to recall.

Freezing External Instruments/Effects

You can freeze external instruments or effects to save processing power.

PROCEDURE

1. Select the audio track that uses the external effect or the instrument track that uses the external instrument.
2. In the **Inspector**, click **Freeze Audio Channel** or **Freeze Instrument Channel**.
3. In the dialog, adjust the **Tail Size** value.
When the **Tail Size** is set to 0 s, freezing only takes into account the data within the part boundaries.

RESULT

The freeze function is performed in real time to ensure that external effects are taken into account.

RELATED LINKS

- [VST Instruments](#) on page 835
- [Audio Effects](#) on page 502
- [Freezing Instruments](#) on page 845
- [Freezing Insert Effects](#) on page 508

Missing Plug-ins

This happens in the following situations:

- When you remove an external device from the **Audio Connections** window although it is used in a saved project.
- When you transfer a project to another computer on which the external device is not defined.
- When you open a project that is created with an earlier version of Nuendo.

In the **Audio Connections** window, the broken connection to the external device is indicated by an icon in the **Bus Name** column.

- To reestablish the broken connection to the external device, right-click the entry for the device in the **Bus Name** column and select **Connect External Effect**.

NOTE

Busses that are set up for external instruments or external effects are saved globally, that is, for your particular computer setup.

Bus Configurations

After you have set up all the required busses for a project you can edit the names and change port assignments. The bus configuration is saved with the project.

Removing Busses

You can remove busses that you no longer need.

PROCEDURE

- In the **Audio Connections** window, do one of the following:
 - To remove a single bus, right-click the bus in the list and select **Remove Bus**. Alternatively, you can select the bus and press **Backspace**.
 - To remove multiple input or output busses at the same time, use **Shift** or **Ctrl/Cmd** to select them in the list, right-click them, and select **Remove Selected Busses**.
-

Changing Port Assignments

You can change the port assignment of busses.

PROCEDURE

1. Select **Studio > Audio Connections**.
2. Do one of the following:
 - To change the assignment of a single bus, open the **Device Port** pop-up menu, and select a new port.
 - To assign subsequent busses to several selected busses, open the **Device Port** pop-up menu for the first selected entry, press **Shift**, and select a device port.

NOTE

Exclusive ports, for example, ports that are already assigned to **Control Room** channels, are skipped.

- To assign the same port to several selected busses, open the **Device Port** pop-up menu for the first selected entry, press **Shift - Alt/Opt**, and select a device port.
-

Renaming Multiple Busses

You can rename all the selected busses at once using incrementing numbers or letters.

PROCEDURE

1. Select **Studio > Audio Connections**.
2. Select the busses that you want to rename.
3. Do one of the following:
 - Enter a new name for one of the busses, followed by a number.

- Enter a new name for one of the busses, followed by a space and a capital letter.

4. Press **Return**.

RESULT

The busses are renamed automatically using either incrementing numbers or letters.

NOTE

The renaming starts from the bus where you edit the name until the bottom, and then continues from the top until all selected busses have been renamed.

Exclusive Port Assignments

For certain channel types, the port assignment is exclusive.

Once a port has been assigned to such a bus or channel, it must not be assigned to another bus, otherwise the connection to the first bus will be broken.

The corresponding ports are marked in the **Audio Connections** window on the **Device Port** pop-up menu.

Project Window

The **Project** window provides an overview of the project, and allows you to navigate and perform large scale editing.

Each project has one **Project** window. The **Project** window is displayed whenever you open or create a new project.

- To open a project, select **File > Open**.
- To create a new project, select **File > New Project**.



The **Project** window is divided into several zones:

1 Left Zone

The left zone shows the **Inspector** that features two tabs:

- The **Track** tab shows the settings for the track that is selected in the track list.

NOTE

In this documentation we use **Inspector** to refer to the **Track** tab of the **Inspector**.

- The **Editor** tab shows the settings for the editor that is open in the lower zone.

You can also open the **Visibility** tab that features the following tabs:

- The **Track** tab allows you to show/hide individual tracks from the track list.
- The **Zones** tab allows you to determine and lock the position of certain **MixConsole** channels in the lower zone.

2 Project Zone

The project zone shows the toolbar, the track list with the tracks, the event display with the parts and events of the project, and the **Project** window ruler.

On the toolbar, you can activate/deactivate the status line, the info line, the overview line, and the **Transport Bar**.

3 Lower Zone

The lower zone shows the **Chord Pads**, the **Editor**, the **Sampler Control**, and the **MixConsole**.

4 Right Zone

The right zone shows the **VSTi** rack, the **Media** rack, the **Control Room** rack, and the **Meter** rack.

RELATED LINKS

[Project Zone](#) on page 47

[Left Zone](#) on page 63

[Lower Zone](#) on page 72

[Right Zone](#) on page 78

[Project Window Toolbar](#) on page 48

Showing/Hiding Zones

You can show/hide the zones in the **Project** window according to your needs.

PROCEDURE

- Do one of the following:
 - To show/hide the left zone, click **Show/Hide Left Zone** on the **Project** window toolbar.
 - To show/hide the lower zone, click **Show/Hide Lower Zone** on the **Project** window toolbar.
 - To show/hide the right zone, click **Show/Hide Right Zone** on the **Project** window toolbar.

NOTE

The project zone is always shown.

RELATED LINKS

[Project Window Toolbar](#) on page 48

Project Zone

The project zone is the heart of the **Project** window and cannot be hidden.

The project zone features the track list and the event display with the ruler. Furthermore, you can activate/deactivate the status line, the info line, the overview line, and the **Transport Bar** for the project zone.

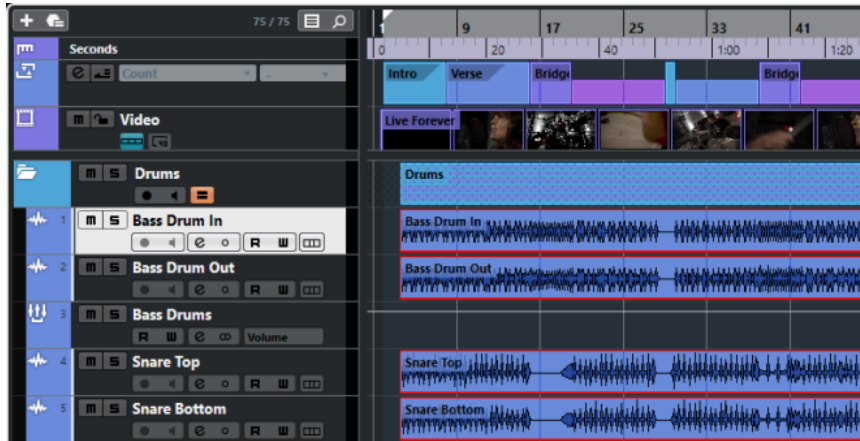

RELATED LINKS

- [Track List](#) on page 56
- [Event Display](#) on page 58
- [Global Track Controls](#) on page 58
- [Ruler](#) on page 60
- [Status Line](#) on page 61
- [Info Line](#) on page 62
- [Overview Line](#) on page 62
- [Transport Bar](#) on page 63

Project Window Toolbar

The toolbar contains tools and shortcuts for opening other windows and various project settings and functions.

- To show/hide tools, open the toolbar context menu by right-clicking in an empty area of the toolbar and activate the tools that you want to display. To show all tools, select **Show All**.

NOTE

The number of elements that are shown also depends on the size of the **Project** window and the screen resolution.

The following options are available:

Activate Project



NOTE

Only available if more than one project is open.

Activates a project.

Project History

Undo/Redo



Undoes/Redoes actions in the **Project** window.

Constrain Delay Compensation

Constrain Delay Compensation



Minimizes the latency effects of the delay compensation.

Left Divider

Left Divider

Tools that are placed to the left of the divider are always shown.

Media & MixConsole Windows

Open MediaBay



Opens/Closes the **MediaBay**.

Open Pool Window



Opens/Closes the **Pool** window.

Open MixConsole



Opens/Closes the **MixConsole**.

Open Control Room



Opens/Closes the **Control Room**.

Open Direct Offline Processing Window



Opens/Closes the **Direct Offline Processing** window.

Track Visibility Configurations

Track Visibility Configurations

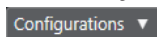

Allows you to create configurations that are useful for switching between different visibility setups.

Set Track Visibility Agents



Allows you to set a visibility agent to filter the tracks.

Set Track Type Filter



Allows you to filter the tracks by track type. **Alt/Opt**-click to reset the track type filter.

State Buttons

Deactivate All Mute States



Deactivates all mute states.

Deactivate All Solo States



Deactivates all solo states.

Deactivate All Listen States



Deactivates all listen states.

Activate/Deactivate Read for All Tracks



Activates/Deactivates read automation for all tracks.

Activate/Deactivate Write for All Tracks



Activates/Deactivates write automation for all tracks.

Suspend All Read/Write Automation



Suspends all read/write automation.

Network Controls

Share Project



Shares your project.

Sync Project to Network State



Syncs your project to the network state.

Commit Changes



Commits your changes.

Automation Mode

Automation Follows Events



Lets your automation events follow automatically when you move an event or part on a track.

Global Automation Mode

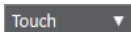

Allows you to select the global automation mode.

Open Automation Panel



Opens the **Automation Panel**.

Auto-Scroll

Auto-Scroll



Keeps the project cursor visible during playback.

Select Auto-Scroll Settings



Allows you to activate **Page Scroll** or **Stationary Cursor** and to activate **Suspend Auto-Scroll When Editing**.

Locators

Go to Left Locator Position



Allows you to go to the left locator position.

Left Locator Position

1. 5. 1. 0

Shows the left locator position.

Go to Right Locator Position



Allows you to go to the right locator position.

Right Locator Position

4. 8. 1. 0

Shows the right locator position.

Locator Range Duration

Locators to Selection



Allows you to set the locators to the selection.

Locator Range Duration

4. 8. 1. 0

Shows the duration of the locator range.

Transport Controls

Go to Previous Marker/Zero



Moves the project cursor to the previous marker/zero position on the timeline.

Go to Next Marker/Project End



Moves the project cursor to the next marker/project end.

Rewind



Moves backward.

Forward



Moves forward.

Activate Cycle



Activates/Deactivates cycle mode.

Stop



Stops playback.

Start



Starts playback.

Transport Record



Activates/Deactivates record mode.

Time Displays

Select Primary Time Format



Allows you to select a time format for the primary time display.

Primary Time Display

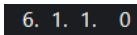

Shows the position of the project cursor in the selected time format.

Select Secondary Time Format



Allows you to select a time format for the secondary time display.

Secondary Time Display

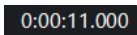

Shows the position of the project cursor in the selected time format.

Markers

Jump to Marker



Allows you to set and locate marker positions.

Open Markers Window



Opens the **Markers** window.

Tool Buttons

Combine Selection Tools



Combines the **Object Selection** tool and the **Range Selection** tool.

Object Selection



Selects events and parts.

Range Selection



Selects ranges.

Draw



Draws events.

Erase



Erases events.

Split



Splits events.

Glue



Glues events together.

Mute



Mutes events.

Zoom



Zooms in. Hold **Alt/Opt** and click to zoom out.

Comp



Assembles takes.

Time Warp



Adjusts musical positions of events to time positions.

Line



Creates a series of contiguous events.

Play



Allows you to play back events.

Color



Allows you to colorize events.

Color Menu

Select Color for Selected Tracks or Events



Opens the **Colorize** pane that allows you to colorize the selected tracks or events.

Nudge Palette

Trim Start Left



Increases the length of the selected event by moving its start to the left.

Trim Start Right



Decreases the length of the selected event by moving its start to the right.

Move Left



Moves the selected event to the left.

Move Right



Moves the selected event to the right.

Trim End Left



Decreases the length of the selected event by moving its end to the left.

Trim End Right



Increases the length of the selected event by moving its end to the right.

Project Root Key

Project Root Key



Changes the root key of the project.

Snap

Snap to Zero Crossing



Restricts editing to zero crossings, that is, positions where the amplitude is zero.

Snap On/Off



Restricts horizontal movement and positioning to the positions specified by the **Snap Type**.

Snap Type



Allows you to specify to what positions you want events to snap.

Grid Type

Grid Type



Allows you to specify a grid type for the **Snap** function. This setting only has effect if **Snap Type** is set to one of the grid options.

Quantize

Apply Quantize



Applies the quantize settings.

Quantize Presets



Allows you to select a quantize preset.

Soft Quantize On/Off



Activates/Deactivates soft quantize.

AudioWarp Quantize On/Off



Activates/Deactivates **AudioWarp** quantize.

Open Quantize Panel



Opens the **Quantize Panel**.

Audio Alignment

Open Audio Alignment Panel



Opens the **Audio Alignment Panel**.

System Performance Meter

System Performance Meter



Shows the meters for average audio processing load and the disk cache load.

Right Divider

Right Divider

Tools that are placed to the right of the divider are always shown.

Window Zone Controls

Show/Hide Left Zone



Shows/Hides the left zone of the window.

Show/Hide Lower Zone



Shows/Hides the lower zone of the window.

Show/Hide Right Zone



Shows/Hides the right zone of the window.

Set up Window Layout



Allows you to set up the window layout.

Set up Toolbar

Set up Toolbar



Opens a pop-up menu where you can set up which toolbar elements are visible.

RELATED LINKS

[Left/Right Toolbar Divider](#) on page 56

[Snap Types Menu](#) on page 90

[Markers](#) on page 368

[Automation](#) on page 805

[Synchronization](#) on page 1204

[Audio Alignment](#) on page 220

Left/Right Toolbar Divider

The left and right toolbar dividers allow you to lock the position of specific tools at the left or at the right side of the toolbar, so that they are always shown.

All other items are shown in the center of the toolbar. When you reduce the width of the **Project** window, these toolbar items are hidden successively. When you increase the width, they are shown again.

Toolbox

The toolbox makes the editing tools from the toolbar available at the mouse pointer position. It can be opened instead of the standard context menus in the event display and editors.



- To activate the toolbox function, activate **Show Toolbox on Right-Click** in the **Preferences** dialog (**Editing—Tools** page).
- To open the toolbox, right-click in the event display or editor.
If **Show Toolbox on Right-Click** is deactivated, the context menu opens.
- To open the context menu instead of the toolbox, press any modifier key and right-click in the event display or editor.
If **Show Toolbox on Right-Click** is deactivated, press any modifier key to open the toolbox instead of the context menu.

Track List

The track list shows the tracks that are used in the project. When a track is added and selected, it contains name fields and settings for this track.

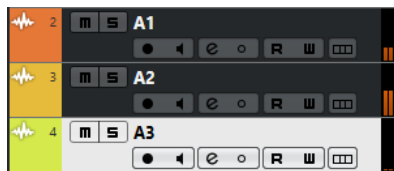

- To decide which controls are visible for each track type, right-click the track list and open the **Track Controls Settings** dialog.

RELATED LINKS

[Track Controls Settings Dialog](#) on page 121

Dividing the Track List

You can divide the track list into an upper track list and a lower track list. These track lists can have independent zoom and scroll controls. Dividing the track list is useful if you are working with a video track and multi-track audio, for example. It allows you to place the video track in the upper track list and to scroll the audio tracks separately in the lower track list, so that they can be arranged with the video.

PROCEDURE

- Do one of the following:
 - Select **Project > Divide Track List**.
 - Click **Divide Track List** in the top right corner of the **Project** window below the ruler.

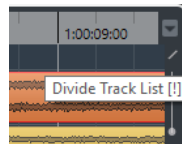

RESULT

The track list is divided and video, marker, or arranger tracks are automatically moved to the upper track list. All other track types are moved to the lower track list.

NOTE

The area of the project zone that has the focus, is indicated by a highlighted and solid focus frame, whereas the non-active area is shown with a dashed frame.

AFTER COMPLETING THIS TASK

- To move any type of track from the lower track list to the upper and vice versa, right-click it in the track list and select **Toggle Track List** from the context menu.
- To resize the upper part of the track list, click and drag the divider between the track list sections.
- To revert to a single track list, click **Divide Track List** again.

RELATED LINKS

[Keyboard Focus in the Project Window](#) on page 84

Event Display

The event display shows the parts and events that are used in the project. They are positioned along the timeline.

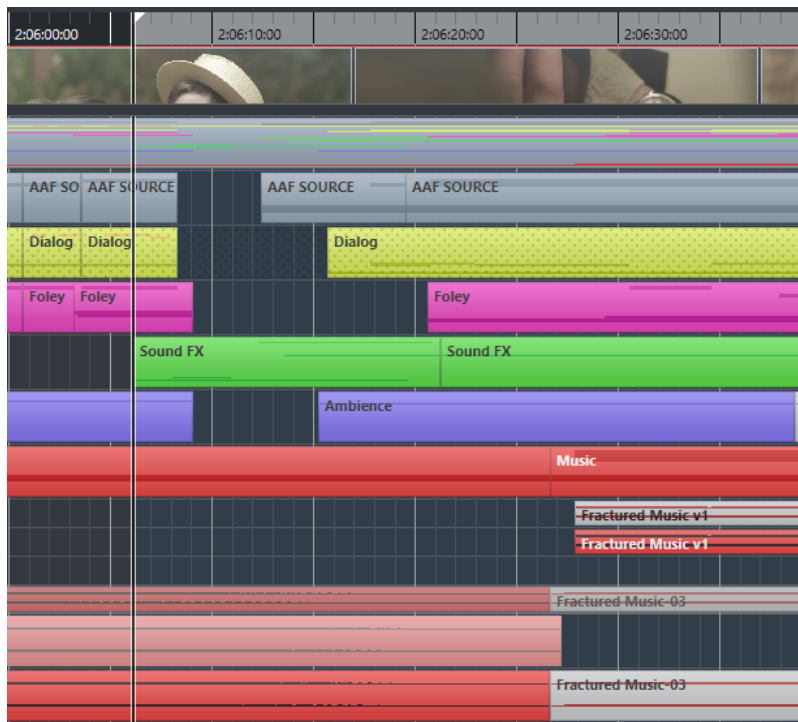

Global Track Controls

The global track controls allow you to manage the tracks in the track list.

- The global track controls are shown above the track list.

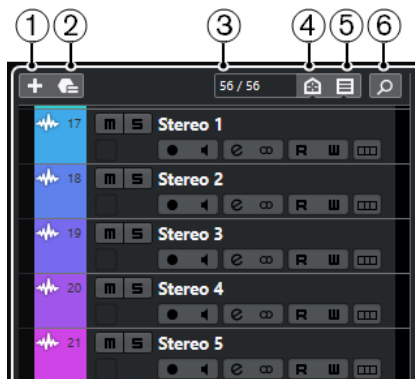

- 1 Add Track**
Opens the **Add Track** dialog.
- 2 Use Track Preset**
Allows you to add a track using a track preset.
- 3 Number of Visible Tracks**
Displays how many tracks are hidden. Click this to show all tracks that are filtered out by the **Visibility** tab.

NOTE

If the track was outside the view or hidden, it is now shown. Tracks that are hidden using **Set Track Type Filter** are not shown.

- 4 Set Track Type Filter**
Determines which track types are shown in the track list.
- 5 Set Track Visibility Agents**
Allows you to set a visibility agent to filter the tracks.
- 6 Find Tracks**
Finds and selects specific tracks in the track list.

RELATED LINKS

[Opening the Visibility](#) on page 69

Filtering Track Types

You can filter tracks by their track type.

PROCEDURE

1. Click **Set Track Type Filter** above the track list.
This opens the track types filter.

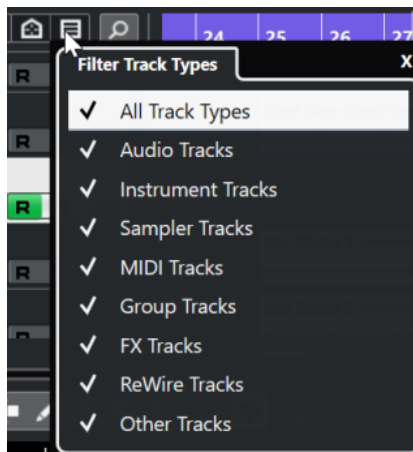

2. Uncheck a track type to hide it.
-

RESULT

Tracks of the filtered type are removed from the track list and the color of the **Set Track Type Filter** button changes to indicate that a track type is hidden.

Finding Tracks

The **Find Tracks** function allows you to find specific tracks. This is useful if you have a large project with many tracks or if you have hidden tracks using the **Visibility** tab.

PROCEDURE

1. Click **Find Tracks** above the track list to open a selector that lists all tracks.
 2. In the search field, enter the name of the track.
As you type, the selector updates automatically.
 3. In the selector, select the track and press **Return**.
-

RESULT

The selector closes and the track is selected in the track list.

NOTE

If the track was outside the view or hidden, it is now shown. Tracks that are hidden using **Set Track Type Filter** are not shown.

Ruler

The ruler shows the timeline and the display format of the project.

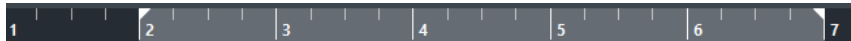

Initially, the **Project** window ruler uses the display format that is specified in the **Project Setup** dialog.

- To select an independent display format for the ruler, click the arrow button to the right of the ruler and select an option from the pop-up menu.
- To set the display format globally for all windows, use **Select Primary Time Format** pop-up menu on the **Transport** panel, or hold down **Ctrl/Cmd** and select a format in any ruler.

RELATED LINKS

[Project Setup Dialog](#) on page 108

Ruler Display Format Menu

You can select a display format for the ruler.

- To show the ruler display formats, click the arrow button to the right of the ruler.

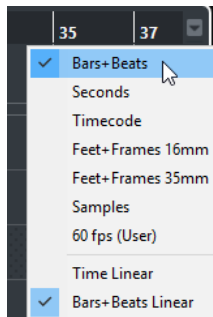

The selection that you make affects the time display formats in the following areas:

- Ruler
- Info line
- Tooltip position values

The following options are available:

Bars+Beats

Sets the ruler to display bars, beats, sixteenth notes, and ticks. By default, there are 120 ticks per sixteenth note. To change this, adjust the **MIDI Display Resolution** setting in the **Preferences** dialog (**MIDI** page).

Seconds

Sets the ruler to display hours, minutes, seconds, and milliseconds.

Timecode

Sets the ruler to display hours, minutes, seconds, and frames. The number of frames per second (fps) is set in the **Project Setup** dialog with the **Project Frame Rate** pop-up menu. To display subframes, activate **Show Timecode Subframes** in the **Preferences** dialog (**Transport** page).

Feet+Frames 16 mm

Sets the ruler to display feet and frames, with 40 frames per foot. To let the beginning of a project always start at 0'00, regardless of any **Start** offset settings in the **Project Setup** dialog, activate **Feet'n'Frames Count from Project Start** in the **Preferences** dialog (**Transport** page).

Feet+Frames 35 mm

Sets the ruler to display feet, frames, and 1/4 frames, with 16 frames per foot. To let the beginning of a project always start at 0'00, regardless of any **Start** offset settings in the **Project Setup** dialog, activate **Feet'n'Frames Count from Project Start** in the **Preferences** dialog (**Transport** page).

Samples

Sets the ruler to display samples.

fps (User)

Sets the ruler to display hours, minutes, seconds, and frames, with a user-definable number of frames per second. To display subframes, activate **Show Timecode Subframes** in the **Preferences** dialog (**Transport** page). You can also set the number of frames per second.

Time Linear

Sets the ruler linear to time.

Bars+Beats Linear

Sets the ruler linear to bars and beats.

Status Line

The status line shows the most important project settings.

- To activate the status line, click **Set up Window Layout** on the toolbar and activate **Status Line**.

The following information is shown on the status line:

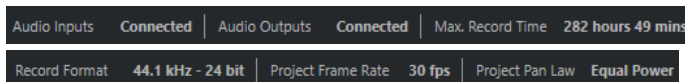

Audio Inputs/Audio Outputs

These fields are shown if the audio device ports are not connected. Click to open the **Audio Connections** dialog and connect the ports.

Max. Record Time

Displays the remaining time for recording, depending on your project settings and the available hard disk space. Click in this field to display the remaining record time in a separate window.

Record Format

Displays the sample rate and the bit depth used for recording. Click in this field to open the **Project Setup** dialog.

Project Frame Rate

Displays the frame rate used in the project. Click in this field to open the **Project Setup** dialog.

Project Audio Pull

Displays the audio pull setting used in the project. Click in this field to open the **Project Setup** dialog.

Project Pan Law

Displays the current pan law setting. Click in this field to open the **Project Setup** dialog.

RELATED LINKS

[Project Window Toolbar](#) on page 48

Info Line

The info line shows information about the event or part that you selected in the project zone.

Name	Start	End	Length	Offset
MIDI 01	1. 1. 1. 0	2. 2. 1. 0	1. 1. 0. 0	0. 0. 0. 0

Mute	Lock	Transpose	Global Transpose	Velocity	Root Key
-	-	0	Follow	0	-

To activate the info line, click **Set up Window Layout** on the toolbar and activate **Info Line**.

RELATED LINKS

[Project Window Toolbar](#) on page 48

Value Editing Rules on the Info Line

You can edit almost all event or part data on the info line using regular value editing.

If you select several events or parts, the info line is shown in another color and only the information about the first item in the selection is displayed. The following rules apply:

- Value changes are applied to all selected elements, relative to the current values.
For example, you have selected two audio events. The first event has a length of 1 bar, the second of 2 bars. If you change the info line value to 3, the first event is resized to 3 bars and the second event to 4 bars.
- Value changes are applied absolutely to the current values if you press **Ctrl/Cmd** while modifying the value on the info line.

In the example above, both events are resized to 3 bars.

NOTE

To change the modifier, select a new modifier in the **Info Line** category of the **Preferences** dialog (**Editing—Tool Modifiers** page).

Overview Line

The overview line allows you to zoom and navigate to other sections in the project.



To activate the overview line, click **Set up Window Layout** on the toolbar and activate **Overview**.

In the overview line, events and parts are displayed as boxes. A rectangle indicates the section of the project that is displayed in the event display.

- To zoom the event display in or out horizontally, resize the rectangle by dragging the edges.
- To navigate to another section of the event display, drag the rectangle to the left or right, or click in the upper part of the overview.

RELATED LINKS

[Project Window Toolbar](#) on page 48

Transport Bar

The **Transport Bar** allows displaying the transport functions in an integrated and fixed zone of the **Project** window.

- To activate the **Transport Bar**, click **Set up Window Layout** on the **Project** window toolbar and activate **Transport Bar**.
- To show/hide tools, open the **Transport Bar** context menu by right-clicking in an empty area of the **Transport Bar** and activate the tools that you want to display. To show all tools, select **Show All**.

RELATED LINKS

[Common Record Modes Menu](#) on page 294

[Audio Record Modes](#) on page 299

[MIDI Record Modes](#) on page 306

[Left/Right Toolbar Divider](#) on page 56

[Project Window Toolbar](#) on page 48

Left Zone

The left zone of the **Project** window allows you to display the **Inspector** and the **Visibility** tab.

To show/hide the left zone, click **Show/Hide Left Zone** on the **Project** window toolbar.

The top of the left zone features the following tabs:

- **Inspector**
- **Visibility**

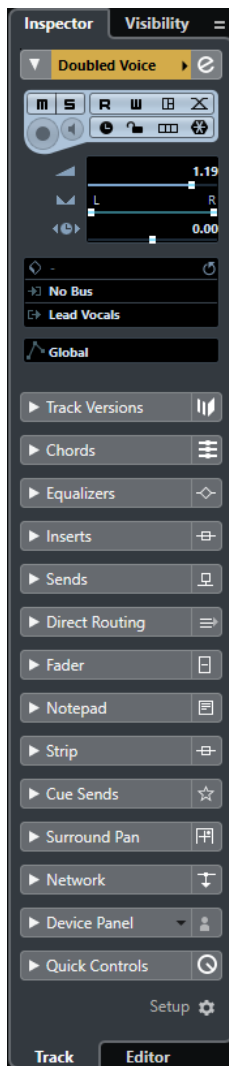

RELATED LINKS

[Inspector](#) on page 64

[Visibility](#) on page 68

[Project Window Toolbar](#) on page 48

Inspector

The **Inspector** allows you to show controls and parameters for either the selected track in the track list or the event or part that is shown in the editor in the lower zone.

- To show/hide the **Inspector**, click **Show/Hide Left Zone** in the **Project** window toolbar.

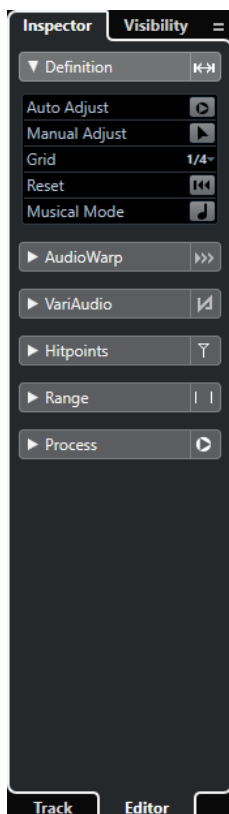

The following tabs are available:

Track

Opens the **Track Inspector** for the selected track.

Editor

Opens the **Editor Inspector** for the event or part that is shown in the editor in the lower zone.

RELATED LINKS

[Opening the Track Inspector](#) on page 65

[Opening the Editor Inspector](#) on page 66

[Opening the Editor in the Lower Zone](#) on page 75

Opening the Track Inspector

The **Track Inspector** shows controls and parameters for the selected track in the track list.

PROCEDURE

1. Click **Show/Hide Left Zone** on the **Project** window toolbar to activate the **Left Zone**.
2. At the bottom of the left zone, click the **Track** tab.

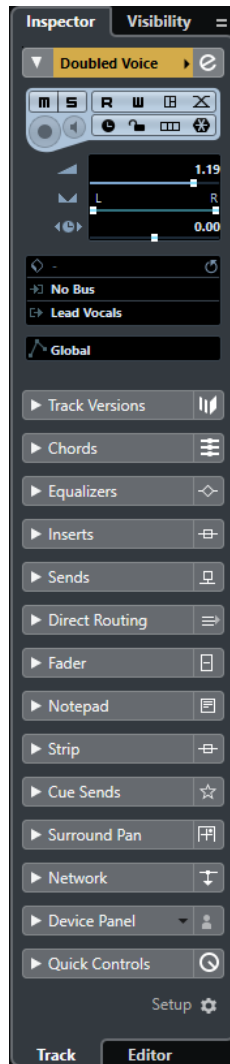

RESULT

The **Track Inspector** for the selected track opens. If more than one track is selected in the track list, the controls and parameters for the topmost selected track are shown.

NOTE

In this documentation we use **Inspector** to refer to the **Track** tab of the **Inspector**.

Opening the Editor Inspector

The **Editor Inspector** shows controls and parameters for the event or part that is shown in the editor in the lower zone.

PREREQUISITE

The **Sample Editor**, the **Audio Part Editor**, the **Key Editor**, the **Drum Editor**, or the **Score Editor** is shown in the lower zone.

PROCEDURE

1. Click **Show/Hide Left Zone** on the **Project** window toolbar to activate the **Left Zone**.
2. At the bottom of the left zone, click the **Editor** tab.

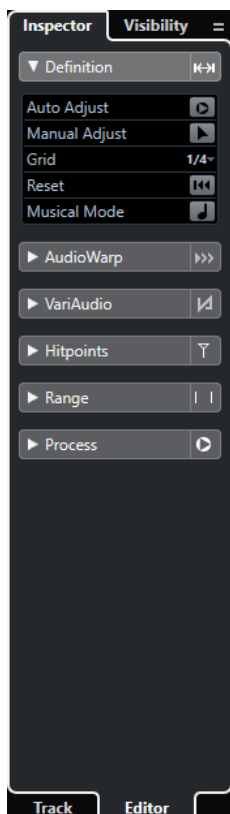

RESULT

The **Editor Inspector** for the event or part opens.

NOTE

The **Editor Inspector** only contains information if the lower zone shows an editor. Otherwise, it is empty.

RELATED LINKS

[Opening the Editor in the Lower Zone](#) on page 75

Opening the Symbols Tab for the Score Editor

The **Score Editor Inspector** allows you to select the following tabs: **Inspector** and **Symbols**.

PREREQUISITE

The **Score Editor** is shown in the lower zone.

PROCEDURE

1. At the bottom of the left zone, click the **Editor** tab.
2. Select an option from the **Switch Score Editor Inspector Content** pop-up menu.

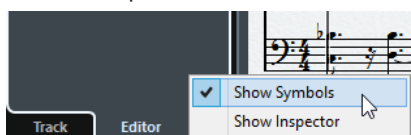

RESULT

The **Symbols** tab is shown.

RELATED LINKS

[Key Editor Inspector](#) on page 955

Inspector Sections

The **Track** tab and the **Editor** tab of the **Inspector** are divided into a number of sections that each contain different controls for the track, event or part.

Not all **Inspector** sections are shown by default. The available sections depend on the type of the selected track, event, or part, and on the settings in the setup dialog for the **Track** tab and the **Editor** tab of the **Inspector**.

- To open/close sections, click their names.
Opening one section closes the other sections.
- To open a section without closing the other sections, **Ctrl/Cmd**-click the section name.

RELATED LINKS

[Track Inspector Settings Dialog](#) on page 118

[Inspector Sections](#) on page 119

[Audio Track Inspector](#) on page 130

[Instrument Track Inspector](#) on page 134

[MIDI Track Inspector](#) on page 140

[Sampler Track Inspector](#) on page 137

[Arranger Track Inspector](#) on page 158

[Marker Track Inspector](#) on page 152

[Signature Track Inspector](#) on page 162

[Tempo Track Inspector](#) on page 163

[Transpose Track Inspector](#) on page 164

[VCA Fader Track Inspector](#) on page 150

[Video Track Inspector](#) on page 165

[Loudness Track Inspector](#) on page 167

[Key Editor Inspector](#) on page 955

[Drum Editor Inspector](#) on page 987

[Sample Editor Inspector](#) on page 581

Visibility

The **Visibility** tab allows you to show or hide individual tracks from the track list and to determine the position of certain **MixConsole** channels in the lower zone.

- To open the **Visibility** tab, click **Visibility**.

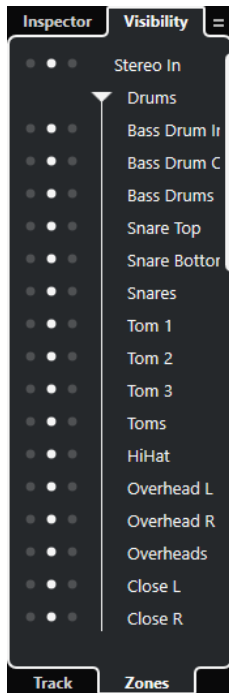

The following tabs are available:

Track

Allows you to show or hide individual tracks from the track list.

Zones

Allows you to determine and lock the position of certain **MixConsole** channels in the lower zone.

RELATED LINKS

[Opening the MixConsole in the Lower Zone](#) on page 74

Opening the Visibility

The **Visibility** tab allows you to show or hide individual tracks from the track list.

PROCEDURE

1. Click **Show/Hide Left Zone** on the **Project** window toolbar to activate the **Left Zone**.
2. At the top of the left zone, click the **Visibility** tab.
3. At the bottom of the left zone, click the **Track** tab.

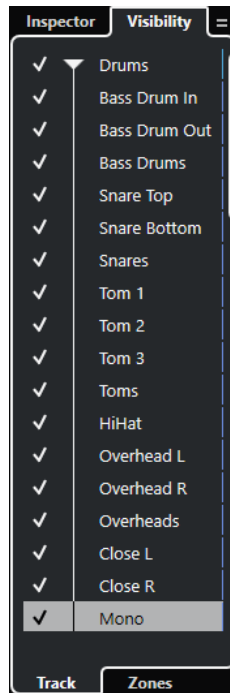

RELATED LINKS

[Showing/Hiding Individual Tracks](#) on page 70

Showing/Hiding Individual Tracks

The **Visibility** tab shows a list of all tracks of your project. This list allows you to show and hide individual tracks.

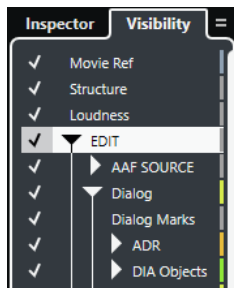

- To show/hide a track in the track list, check/uncheck it by clicking to the left of the track name.
- To activate/deactivate several tracks at the same time, select them and press **Return**.
- To show a hidden track exclusively, check it by **Shift**-clicking to the left of the track name.
- To expand or collapse a folder, click the triangle to the left of a folder track.

NOTE

- The channels of the **MixConsole** in the lower zone are updated accordingly. This means that if you hide a track using the **Visibility** tab, the channel corresponding to that track is also hidden in the **MixConsole** in the lower zone.
 - If you want to synchronize the track and the channel visibility in a separate **MixConsole** window, you must use the **Sync Visibility of Project and MixConsole** function.
-

RELATED LINKS

[Synchronizing Track and Channel Visibility](#) on page 71

Synchronizing Track and Channel Visibility

You can synchronize the track visibility in the **Project** window with the channel visibility in a separate **MixConsole** window.

PROCEDURE

1. At the top of the left zone, select the **Visibility** tab.
2. At the bottom of the left zone, select the **Track** tab.
3. Click the equals sign to open the **Sync Visibility of Project and MixConsole: On/Off** menu.

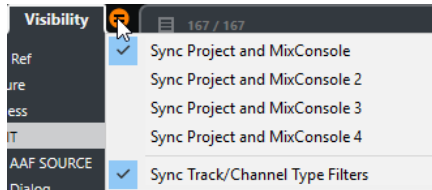

4. Select **Sync Project and MixConsole** to synchronize the track visibility with the channel visibility.
-

RESULT

The track and channel visibility are synchronized.

NOTE

- You can only synchronize the track visibility in the **Project** window with the channel visibility of one **MixConsole**. If you enable **Sync Visibility of Project and MixConsole: On/Off** for a second **MixConsole**, the first link is lost.
 - If you divide the track list, the top part of the list is not affected. Likewise, channels in the left or right zones of the **MixConsole** are not synchronized.
-

RELATED LINKS

[Synchronizing Channel and Track Visibility](#) on page 408

Opening the Zones

The **Zones** tab allows you to determine and lock the position of certain **MixConsole** channels in the lower zone.

PROCEDURE

1. At the top of the left zone, click the **Visibility** tab.
2. At the bottom of the left zone, click the **Zones** tab.



RESULT

The **MixConsole** opens in the lower zone.

RELATED LINKS

[Opening the MixConsole in the Lower Zone](#) on page 74

Lower Zone

The lower zone of the **Project** window allows you to display specific windows and editors in an integrated and fixed zone of the **Project** window. This is useful if you work on single screen systems and notebooks, for example.

To show/hide the lower zone, click **Show/Hide Lower Zone** on the **Project** window toolbar.

The lower zone features the following tabs: **Chord Pads**, **MixConsole**, **Sampler Control**, and **Editor**.



To close the lower zone, click **Close Lower Zone**  to the left of the tabs.

RELATED LINKS

- [Opening Chord Pads](#) on page 73
- [Opening the MixConsole in the Lower Zone](#) on page 74
- [Opening Sampler Control](#) on page 75
- [Opening the Editor in the Lower Zone](#) on page 75
- [Project Window Toolbar](#) on page 48

Setting up the Lower Zone

In the lower zone, the **MixConsole**, **Editor**, **Sampler Control**, and **Chord Pads** tabs are shown. You can change their order, and you can hide tabs that you do not need.

PROCEDURE

1. Click **Set up Lower Zone** in the bottom right of the lower zone.

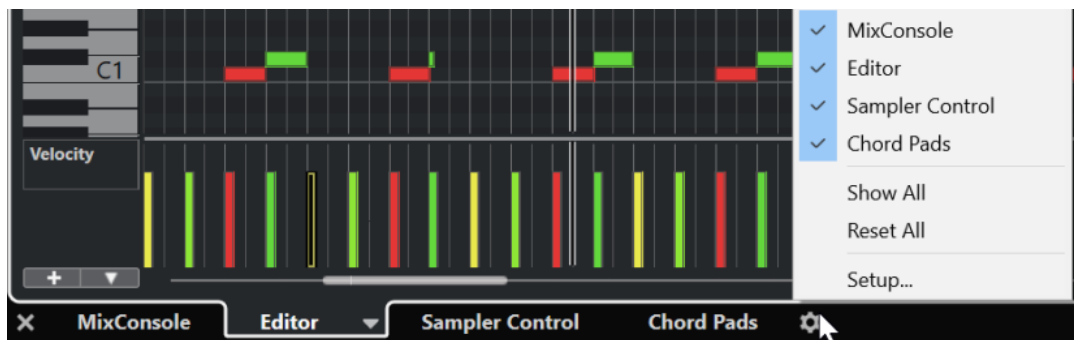

2. Do one of the following:
 - Activate/Deactivate the options in the pop-up menu to show/hide tabs in the lower zone.
 - Select **Setup** to open a dialog where you can activate/deactivate the tabs and change their position.

NOTE

In the **Presets** section of this dialog you can also save a preset of your configuration.

RESULT

The tabs in the lower zone are shown according to your configuration.

RELATED LINKS

- [Setup Dialog](#) on page 1339

Opening Chord Pads

Chord Pads allow you to play with chords, and to change their voicings and tensions.

PROCEDURE

1. Click **Show/Hide Lower Zone** on the **Project** window toolbar to activate the lower zone.
2. At the bottom of the lower zone, click the **Chord Pads** tab.

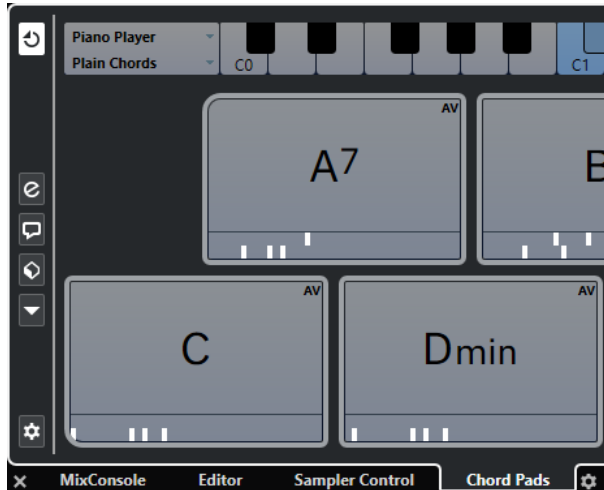

RESULT

The **Chord Pads** are opened.

RELATED LINKS

- [Chord Pads](#) on page 1073
- [Setting up the Lower Zone](#) on page 73
- [Project Window Toolbar](#) on page 48

Opening the MixConsole in the Lower Zone

The **MixConsole** in the lower zone allows you to perform all basic mixing procedures from within the lower zone of the **Project** window, and at the same time to see the context of your tracks and events.

PROCEDURE

1. Click **Show/Hide Lower Zone** on the **Project** window toolbar to activate the lower zone.
2. At the bottom of the lower zone, click the **MixConsole** tab.



RESULT

The **MixConsole** is opened in the lower zone.

RELATED LINKS

[MixConsole in Lower Zone](#) on page 402

[Project Window Toolbar](#) on page 48

Opening Sampler Control

Sampler Control allows you to display and edit the waveform of an audio sample on a sampler track.

PROCEDURE

1. Click **Show/Hide Lower Zone** on the **Project** window toolbar to activate the lower zone.
2. At the bottom of the lower zone, click the **Sampler Control** tab.



RESULT

Sampler Control is opened.

RELATED LINKS

[Sampler Tracks](#) on page 653

[Project Window Toolbar](#) on page 48

Opening the Editor in the Lower Zone

The **Editor** in the lower zone allows you to perform event editing procedures from within the lower zone of the **Project** window, and at the same time to see the context of your tracks and events.

NOTE

By default, double-clicking an audio event/part or a MIDI part in the event display or selecting it and pressing **Return** opens the corresponding editor in the lower zone of the **Project** window. Using a menu command opens a separate editor window. You can change this in the **Preferences** dialog (**Editors** page).

PROCEDURE

1. Click **Show/Hide Lower Zone** on the **Project** window toolbar to activate the lower zone.

2. At the bottom of the lower zone, click the **Editor** tab.
3. In the event display, do one of the following:
 - Select a MIDI part.
 - Select an audio event.
 - Select an audio part.



RESULT

Depending on your event or part selection, the lower zone shows either the **Audio Part Editor**, the **Sample Editor**, or one of the MIDI editors.

NOTE

To change the default MIDI editor, select **MIDI > Set up Editor Preferences**, and select an option from the **Default MIDI Editor** pop-up menu.

NOTE

If you open the editor and no event or part is selected, the editor in the lower zone is empty.

RELATED LINKS

[Selecting a different MIDI Editor](#) on page 76

[Project Window Toolbar](#) on page 48

Selecting a different MIDI Editor

You can display the MIDI part that is opened in the editor in the lower zone in a different MIDI editor. You can do this without changing the default MIDI editor.

PROCEDURE

1. On the **Editor** tab in the editor in the lower zone, click **Select MIDI Editor**.
2. Select an editor from the pop-up menu.



RESULT

The MIDI part is displayed in the selected editor.

NOTE

This selection is temporary. Next time you open the MIDI part, the default MIDI editor is used.

Link Project and Lower Zone Editor Cursors

You can link cursors and zoom factors of the project zone and the **Key Editor**, **Drum Editor**, and the **Audio Part Editor** in the lower zone.

NOTE

Link Project and Lower Zone Editor Cursors is not available in the **Sample Editor**.

NOTE

The ruler display format setting is not affected by this function. You can still select different ruler display formats for the project zone and the editor in the lower zone.



If you activate **Link Project and Lower Zone Editor Cursors** , the cursors and zoom factors are linked in the event displays of the project zone and the lower zone. This is useful if you edit in both zones and you want to keep the same position in view.

NOTE

In the **Key Commands** dialog in the **Edit** category, you can assign a key command for this.

RELATED LINKS

- [Ruler](#) on page 60
- [Ruler Display Format Menu](#) on page 60
- [Zooming in the Project Window](#) on page 86

Right Zone

The right zone of the **Project** window allows you to display the **VSTi** rack, the **Media** rack, the **Control Room** rack, and the **Meter** rack.

To show/hide the right zone, click **Show/Hide Right Zone** on the **Project** window toolbar.

The top of the right zone features the following tabs: **VSTi**, **Media**, **CR**, and **Meter**.

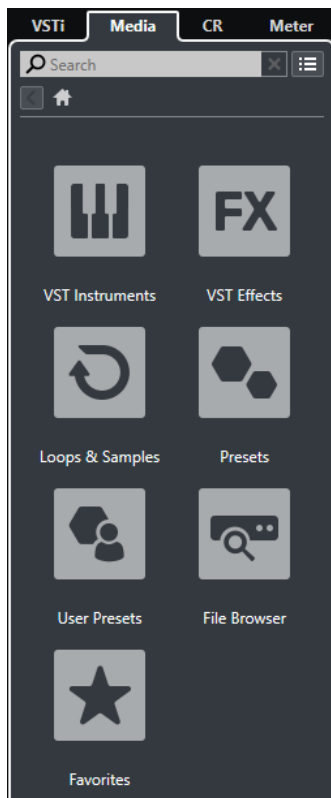

NOTE

You can show/hide specific tabs in the right zone by right-clicking a tab and activating/deactivating the options in the context menu.

RELATED LINKS

[VSTi Rack in the Right Zone](#) on page 80

[Media Rack in the Right Zone](#) on page 82

[Project Window Toolbar](#) on page 48

Opening the VSTi Rack in the Right Zone

You can show the **VSTi** rack in the right zone of the **Project** window. This allows you to add and edit VST instruments, and at the same time to see the context of your tracks and events.

PROCEDURE

1. Click **Show/Hide Right Zone** on the **Project** window toolbar to activate the **Right Zone**.
2. At the top of the right zone, click the **VSTi** tab.



RESULT

The **VSTi** rack is opened in the right zone of the **Project** window.

RELATED LINKS

[VSTi Rack in the Right Zone](#) on page 80

[VST Instruments](#) on page 835

[Project Window Toolbar](#) on page 48

VSTi Rack in the Right Zone

The **VSTi** rack in the right zone of the **Project** window allows you to add and edit VST instruments in the context of the **Project** window.

The following sections are available:

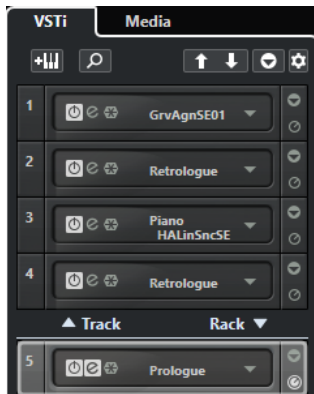

- **Track**
Shows the associated VST instrument for an instrument track.
- **Rack**
Shows a VST instrument.

The following controls are available:

Add Track Instrument



Opens the **Add Track** dialog that allows you to select an instrument and add an instrument track that is associated to this instrument.

Find Instruments



Opens a selector that allows you to find a loaded instrument.

Set Remote-Control Focus for VST Quick Controls to Previous Instrument



Allows you to set the remote-control focus to the previous instrument.

Set Remote-Control Focus for VST Quick Controls to Next Instrument



Allows you to set the remote-control focus to the next instrument.

Show/Hide all VST Quick Controls



Shows/Hides the default quick controls for all loaded instruments.

Settings



Opens the **Settings** pop-up menu where you can activate/deactivate the following modes:

- **Show VST Quick Controls for One Slot Only** shows the **VST Quick Controls** exclusively for the selected instrument.
- **MIDI Channel follows track selection** ensures that the **Channel** selector follows the MIDI track selection in the **Project** window. Use this mode if you work with multitimbral instruments.
- **Remote-Control Focus for VST Quick Controls follows track selection** ensures that the **VST Quick Controls** remote-control focus follows the track selection.

RELATED LINKS

[VST Instruments Window](#) on page 839

Opening the Media Rack in the Right Zone

You can show the **Media** rack in the right zone of the **Project** window. This allows you to see the context of your tracks and events when you drag audio events, MIDI parts, presets, or instruments into the **Project** window.

PROCEDURE

1. Click **Show/Hide Right Zone** on the **Project** window toolbar to activate the **Right Zone**.
2. At the top of the right zone, click the **Media** tab.

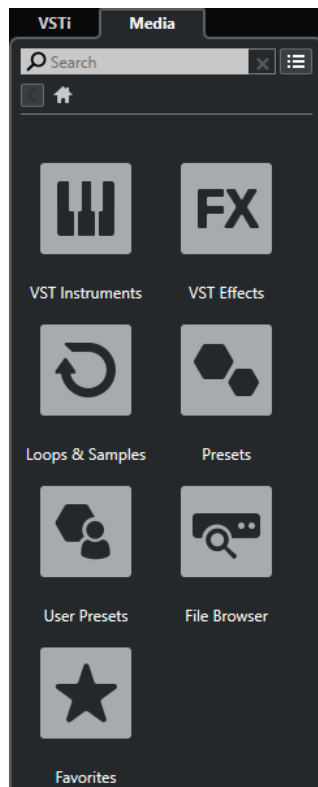

RESULT

The **Media** rack is opened in the right zone of the **Project** window.

RELATED LINKS

[Media Rack in the Right Zone](#) on page 82

[MediaBay and Media Rack](#) on page 697

[Project Window Toolbar](#) on page 48

Media Rack in the Right Zone

The **Media** rack in the right zone of the **Project** window allows you to drag audio events, MIDI parts, or instrument presets into the event display. It lists Steinberg factory content and any installed Steinberg content sets.

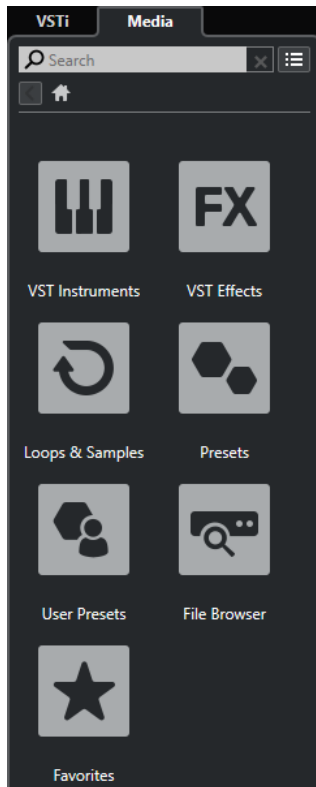

The **Media** rack **Home** tab shows the following tiles:

VST Instruments

Shows all included VST instruments.

VST Effects

Shows all included VST effects.

Loops & Samples

Shows audio loops, MIDI loops, or instrument sounds ordered by content set.

Presets

Shows track presets, strip presets, pattern banks, FX chain presets, and VST FX presets.

User Presets

Shows track presets, strip presets, pattern banks, FX chain presets, VST FX presets, and instrument presets that are listed in the **User** folder.

Favorites

Shows your favorite folders and allows you to add new favorites. The folder content is automatically added to the **MediaBay** database.

File Browser

Shows your file system and the pre-defined folders **Favorites**, **This Computer**, **VST Sound**, **Factory Content**, and **User Content** where you can search for media files and access them immediately.

RELATED LINKS

[Media Rack in Right Zone](#) on page 697

[MediaBay and Media Rack](#) on page 697

Opening the Control Room in the Right Zone

You can show the **Control Room** in the right zone of the **Project** window.

PROCEDURE

1. Click **Show/Hide Right Zone** on the **Project** window toolbar to activate the **Right Zone**.
2. At the top of the right zone, click the **CR** tab.



RESULT

The **Control Room** is opened in the right zone of the **Project** window. It has exactly the same features as the **Control Room** that you open from the **Studio** menu as a separate window.

RELATED LINKS

[Control Room](#) on page 479

[Project Window Toolbar](#) on page 48

Opening the Meter in the Right Zone

You can show the **Meter** in the right zone of the **Project** window.

PROCEDURE

1. Click **Show/Hide Right Zone** on the **Project** window toolbar to activate the **Right Zone**.
2. At the top of the right zone, click the **Meter** tab.

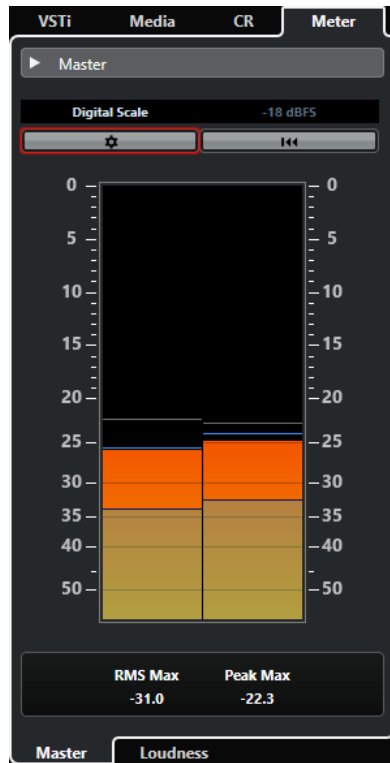

RESULT

The **Meter** is opened in the right zone of the **Project** window. It has exactly the same features as the **Meter** that you open in the right zone of the **MixConsole**.

RELATED LINKS

- [Metering and Loudness](#) on page 493
- [Project Window Toolbar](#) on page 48

Keyboard Focus in the Project Window

The different zones in the **Project** window can be controlled by using key commands. To make sure that a key command has effect on a specific zone, you must make sure that this zone has the keyboard focus.

The following **Project** window zones can have the keyboard focus:

- Project zone

NOTE

If you activate **Divide Track List**, the area of the project zone that has the focus is indicated by a highlighted and solid focus frame, whereas the non-active area is shown with a dashed frame.

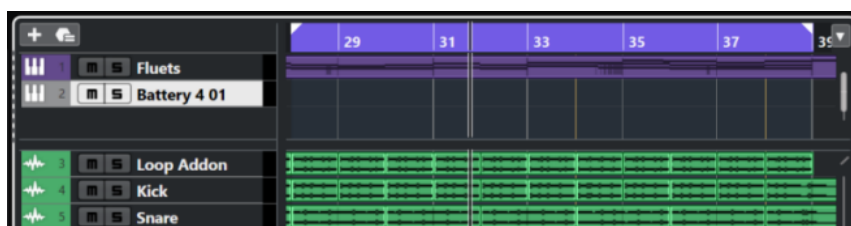

- Left zone
- Lower zone
- Right zone

If a zone has the keyboard focus, the border that surrounds it is highlighted in a specific color.

NOTE

You can change the focus color in the **Preferences** dialog (**User Interface—Color Schemes** page).

RELATED LINKS

- [Project Zone](#) on page 47
- [Left Zone](#) on page 63
- [Lower Zone](#) on page 72
- [Right Zone](#) on page 78
- [Project Window](#) on page 46
- [Dividing the Track List](#) on page 57
- [Keyboard Focus in the Key Editor](#) on page 965

Activating Keyboard Focus for a Zone

You can activate the keyboard focus for a zone by clicking with the mouse and by using key commands.

PROCEDURE

- Do one of the following:
 - To activate any zone, click in it.
 - To activate the next zone, press **Tab**. This allows you to cycle forward through the zones.
 - To activate the previous zone, press **Shift - Tab**.

NOTE

The editor in the lower zone automatically gets the keyboard focus if you double-click an event or part in the event display, if you select an event or part and press **Return**, or if you use key commands to open the zone.

RESULT

The keyboard focus is activated for this zone and the border of the zone is highlighted.

NOTE

The project zone and the lower zone have separate toolbars and info lines. If you use the toolbar or the info line for one of these zones, the corresponding zone automatically gets the focus.

RELATED LINKS

- [Keyboard Focus in the Project Window](#) on page 84
- [Keyboard Focus in the Key Editor](#) on page 965

Zooming in the Project Window

You can zoom in the **Project** window according to the standard zoom techniques.

NOTE

If screen redraws are slow on your system, consider activating **Quick Zoom** in the **Preferences** dialog (**Editing** page).

Zooming Horizontally

- Select the **Zoom** tool and click in the event display to zoom in. To zoom out, hold down **Alt/Opt** and click.
- Use the horizontal zoom sliders to zoom in and out.
- Click the lower half of the ruler and drag down to zoom in horizontally. Click the lower half of the ruler and drag up to zoom out horizontally.
- Click **H** to zoom in horizontally. Click **G** to zoom out horizontally.

NOTE

If the **Grid Type** in the **Project** window toolbar is set to **Adapt to Zoom**, the horizontal zoom level affects the grid and snap resolution in the event display.

Zooming Vertically

- Select the **Zoom** tool, click in the event display, and drag a selection rectangle to zoom in vertically and horizontally.

NOTE

For this to work, you must deactivate the **Zoom Tool Standard Mode: Horizontal Zooming Only** option in the **Preferences** dialog (**Editing—Tools** page).

- Use the vertical zoom sliders to zoom in and out. If you have made any individual track height adjustments, the relative height differences are maintained.
- Click **Shift - H** to zoom in vertically. Click **Shift - G** to zoom out vertically.

RELATED LINKS

[Zoom Submenu](#) on page 87

[Zoom Presets](#) on page 87

[Zooming in on Cycle Markers](#) on page 88

[Zoom History](#) on page 89

[Link Project and Lower Zone Editor Cursors](#) on page 77

[Grid Type Menu](#) on page 91

Zooming in on Audio Contents

You can zoom in vertically on the contents of audio parts and events. This is useful when viewing quiet audio passages.

PROCEDURE

- Click the waveform zoom slider in the top right corner of the event display and drag up.

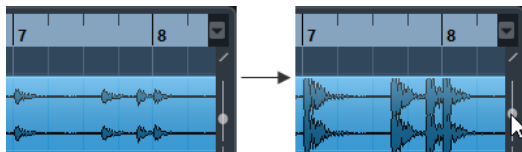

RESULT

The contents of audio parts and events in your project are zoomed in vertically.

AFTER COMPLETING THIS TASK

To get an approximate reading on the level of the audio events by viewing the waveforms, zoom out by dragging the slider all the way down again. Otherwise, zoomed waveforms may be mistaken for clipped audio.

Zoom Submenu

The **Zoom** submenu contains options for zooming in the **Project** window.

- To open the **Zoom** submenu, select **Edit > Zoom**.

The following options are available:

Zoom In/Zoom Out

Zooms in/out one step, centering on the project cursor.

Zoom Full

Zooms out so that the whole project is visible. The whole project means the timeline from the project start to the length set in the **Project Setup** dialog.

Zoom to Selection

Zooms in horizontally and vertically so that the current selection fills the screen.

Zoom to Selection (Horiz.)

Zooms in horizontally so that the current selection fills the screen.

Zoom to Event

Zooms in to show the currently selected event. This option is available in the **Sample Editor** and in some MIDI editors.

Zoom In Vertically/Zoom Out Vertically

Zooms in/out one step vertically.

Zoom In Tracks/Zoom Out Tracks

Zooms the selected tracks in/out one step vertically.

Zoom Selected Tracks

Zooms in vertically on the selected tracks and minimizes the height of all other tracks.

Undo Zoom/Redo Zoom

These options allow you to undo/redo the last zoom operation.

RELATED LINKS

[Zoom Submenu](#) on page 586

Zoom Presets

You can create zoom presets that allow you to set up different zoom settings. For example, one where the whole project is displayed in the **Project** window and another with a high zoom factor

for detailed editing. The **Zoom Presets** pop-up menu allows you to select, create, and organize zoom presets.

- To open the **Zoom Presets** pop-up menu, click the button to the left of the horizontal zoom control.

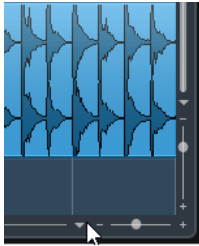

The upper part of the menu lists the zoom presets.

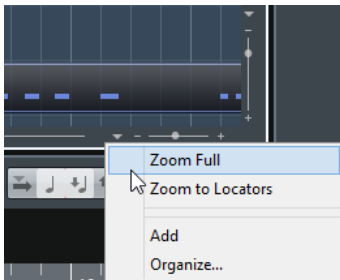

- To save the current zoom setting as a preset, open the **Zoom Presets** pop-up menu and select **Add**. In the **Type in Preset Name** dialog that opens, type in a name for the preset and click **OK**.
- To select and apply a preset, select it from the **Zoom Presets** pop-up menu.
- To zoom out so that the whole project is visible, open the **Zoom Presets** pop-up menu and select **Zoom Full**.

This displays the project from the **Project Start Time** to the **Project Length** that is set in the **Project Setup** dialog.

- To delete a preset, open the **Zoom Presets** pop-up menu and select **Organize**. In the dialog that opens, select the preset in the list and click **Delete**.
- To rename a preset, open the **Zoom Presets** pop-up menu and select **Organize**. In the dialog that opens, select a preset in the list and click **Rename**. In the dialog that opens, type in a new name for the preset. Click **OK** to close the dialogs.

IMPORTANT

Zoom presets are global for all projects. They are available in all projects that you open or create.

Zooming in on Cycle Markers

You can zoom in on the area between cycle markers in the project.

PREREQUISITE

You have created at least one cycle marker for the project.

PROCEDURE

- Click the button to the left of the horizontal zoom control to open the **Zoom Presets** pop-up menu, and select a cycle marker.

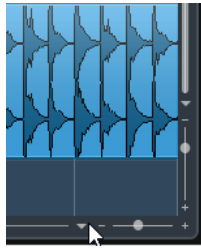

The middle part of the pop-up menu lists any cycle markers that you have added to the project.

RESULT

The event display is zoomed in to encompass the marker area.

RELATED LINKS

[Markers Window](#) on page 371

Zoom History

You can undo and redo zoom operations. This way, you can zoom in several steps and then easily go back to the zoom stage at which you started.

You can undo and redo zoom operations in the following ways:

- To undo zoom, select **Edit > Zoom > Undo Zoom** or double-click with the zoom tool.
- To redo zoom, select **Edit > Zoom > Redo Zoom** or press **Alt/Opt** and double-click with the zoom tool.

Snap Function

The **Snap** function helps you to find exact positions when editing in the **Project** window. It does this by restricting horizontal movement and positioning to certain positions. Operations affected by **Snap** include moving, copying, drawing, sizing, splitting, range selection, etc.

- To activate/deactivate **Snap**, activate/deactivate **Snap**  on the toolbar.

Setting the Snap Point

You can set the snap point at any position of the audio event.

PROCEDURE

1. Select an event.
 2. Place the project cursor at a position within the selected audio event.
 3. Select **Audio > Snap Point to Cursor**.
-

RESULT

The snap point is set at the cursor position. The snap point for an event is displayed as a vertical line in the **Project** window.

NOTE

You can also set the snap point in the **Sample Editor**.

RELATED LINKS

[Adjusting the Snap Point](#) on page 594

Snap to Zero Crossing

When splitting and sizing audio events, sudden amplitude changes can cause pops and clicks. To avoid this, you can activate **Snap to Zero Crossing** to snap to points where the amplitude is zero.

- To activate **Snap to Zero Crossing**, activate **Snap to Zero Crossing**  on the toolbar.

Snap Types Menu

You can select between different snap types to determine the snap point.

- To open the **Snap Type** pop-up menu, click **Snap Type**  on the toolbar.

The following snap types are available:

Grid

If this option is activated, the snap points are set with the **Grid Type** pop-up menu. The options depend on the display format that is selected for the ruler.

If you select **Seconds** as ruler format, time-based grid options are available.

If you select **Bars+Beats** as ruler format, musical grid options are available.

Grid Relative

If this option is activated, events and parts are not magnetic to the grid. Rather, the grid determines the step size for moving the events. This means that a moved event keeps its original position relative to the grid.

For example, if an event starts at the position 3.04.01, **Snap** is set to **Grid Relative**, and **Grid Type** is set to **Bar**, you can move the event in steps of one bar to the positions 4.04.01, 5.04.01, and so on.

NOTE

This only applies when dragging existing events or parts. When you create new events or parts, this **Snap Type** works like **Grid**.

Events

If this option is activated, the start and end positions of other events and parts become magnetic. This means that if you drag an event to a position near the start or end of another event, it is automatically aligned with the start or end of the other event.

For audio events, the position of the snap point is also magnetic. This includes marker events on the marker track.

Shuffle

Shuffle is useful when you want to change the order of adjacent events. If you have two adjacent events and drag the first one to the right, past the second event, the two events change places.



The same principle works when changing the order of more than two events.

Cursor

This grid type lets the project cursor become magnetic. Dragging an event near the cursor causes the event to be aligned with the cursor position.

Grid + Cursor

This is a combination of **Grid** and **Cursor**.

Events + Cursor

This is a combination of **Events** and **Cursor**.

Events + Grid + Cursor

This is a combination of **Events**, **Grid**, and **Cursor**.

Grid Type Menu

Allows you to specify a grid type that determines the grid and snap resolution in the event display.

NOTE

This setting only has an effect if **Snap Type** is set to one of the grid options.

- To open the **Grid Type** pop-up menu, click **Grid Type**  **Bar** on the toolbar.

If you select **Bars+Beats** as ruler format, the following grid types are available:

Bar

Sets the grid and snap resolution to bars.

Beat

Sets the grid and snap resolution to beats.

Use Quantize

Sets the grid and snap resolution to the value that is activated in the **Quantize Presets** pop-up menu.

Adapt to Zoom

Sets the grid and snap resolution to the horizontal zoom level. The more you zoom in on the event display, the finer the resolution. High zoom levels allow you to snap to 64th notes, low zoom levels allow you to snap to bars.

NOTE

Adapt to Zoom is only available if **Bars+Beats** is set as ruler display format.

NOTE

You can assign key commands to the grid types in the **Key Commands** dialog in the **Edit** category.

If you activate **Time Linear** in the ruler context menu, the distances between the grid lines are still constant but based on musical values such as bars and beats.

If you select **Seconds** as ruler format, the following grid types are available:

1 ms

Sets the grid and snap resolution to 1 ms.

10 ms

Sets the grid and snap resolution to 10 ms.

100 ms

Sets the grid and snap resolution to 100 ms.

1000 ms

Sets the grid and snap resolution to 1000 ms.

RELATED LINKS

[Snap Types Menu](#) on page 90

[Zooming in the Project Window](#) on page 86

[Ruler Display Format Menu](#) on page 60

Cross-Hair Cursor

The cross-hair cursor is displayed when working in the **Project** window and in the editors, facilitating navigation and editing, especially when arranging large projects.

- You can set up the cross-hair cursor in the **Preferences** dialog (**Editing—Tools** page). You can set up the colors for the line and the mask of the cross-hair cursor, and define its width.

The cross-hair cursor works as follows:

- When the **Object Selection** tool or one of its subtools is selected, the cross-hair cursor appears when you start moving/copying a part/event, or when using the event trim handles.



Cross-hair cursor when moving an event.

- When the **Object Selection** tool, the **Split** tool, or any other tool that makes use of this function is selected, the cross-hair cursor appears as soon as you move the mouse over the event display.
- The cross-hair cursor is only available for tools where such a function is of any use. The **Mute** tool, for example, does not use a cross-hair cursor, as you have to click directly on an event to mute it.

NOTE

If the **Key Editor**, **Drum Editor** or the **Audio Part Editor** is open in the lower zone of the **Project** window and **Link Project and Lower Zone Cursors** is activated, the cross-hair cursor is shown in the editor in the lower zone and in the **Project** window.

Edit History Dialog

The **Edit History** dialog contains a list of all your edits. This allows you to undo all actions in the **Project** window as well as in the editors.

- To open the **Edit History** dialog, select **Edit > History**.

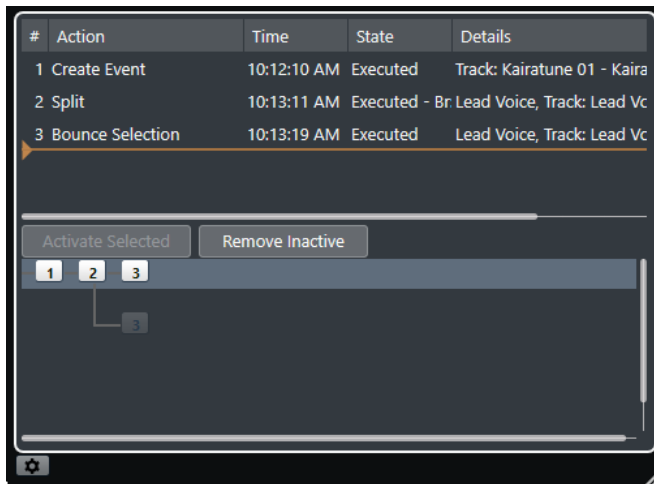

Action

Shows the name of the action.

Time

Shows the time when this action was performed.

State

Shows the state of the action.

Details

Shows further details, and allows you to enter new text.

Separator

Move the separator upwards to undo your actions. To redo an action again, move the separator down.

NOTE

- You can also undo applied plug-in effects or audio processes. However, we recommend to modify or delete these using the **Direct Offline Processing** window.
- All offline processing that you have applied permanently to the audio using the **Make Direct Offline Processing Permanent** function cannot be undone. Therefore, it is not shown in the **Edit History** dialog.

RELATED LINKS

[Direct Offline Processing](#) on page 534

[Applying Offline Processing Permanently](#) on page 547

Setting the Number of Maximum Undo Steps

You can limit the number of maximum undo steps. This is useful if you run out of memory, for example.

PROCEDURE

1. In the **Preferences** dialog, select **General**.
2. Set the number in the **Maximum Undo Steps** field.

Branches

You can gather actions in branches. This way you can undo whole branches instead of every single action that you performed.

A branch is created when you have undone at least one action. All following actions you perform are then gathered in a new branch.

- To activate branches, activate **Use Undo Branches** in the **Preferences** dialog (**General** page).
- To see and edit the branches, select **Edit > Edit History**.

Undoing Edits of Separate Branches

If you have two or more branches, you can choose to undo edits of the separate branches.

PROCEDURE

1. Select **Edit > History**.
2. In the lower part of the **Edit History** dialog, click on a branch to select it.
The corresponding actions are listed in the upper part of the dialog.
3. Click **Activate Selected** or click a second time on the branch to activate it.

RESULT

All actions from the subsequent branches are undone while all actions of the now active branch are redone.

If you undo some of the actions and then perform new edit operations, a new child branch is created at that position in the tree.

Removing Branches

You can remove inactivate branches that you no longer need.

IMPORTANT

Removing inactive branches cannot be undone.

PROCEDURE

1. Select **Edit > History**.
2. In the lower part of the **Edit History** dialog, click **Remove Inactive**.

RESULT

All inactive branches are removed, leaving only the active actions on a single, linear branch.

AFTER COMPLETING THIS TASK

You can now undo separate actions of the branch as usual in the upper part of the dialog.

Color Handling

You can colorize events and tracks in Nuendo. This allows for an easier overview in the **Project** window.

RELATED LINKS

[Color Picker](#) on page 101

- [Project Colors Setup Dialog](#) on page 98
- [Event Colors Menu](#) on page 914
- [Setting Event Colors to Track Colors](#) on page 98
- [Colorizing Events on the Fly](#) on page 97
- [Colorizing Selected Events or Parts](#) on page 96
- [Resetting the Track Color](#) on page 96
- [Colorizing Single Tracks](#) on page 95
- [Colorizing Selected Tracks](#) on page 95
- [Color Handling](#) on page 94
- [User Interface - Track & MixConsole Channel Colors](#) on page 1377
- [Automatically Assigning Colors to New Tracks/Channels](#) on page 183

Colorizing Selected Tracks

You can colorize selected tracks.

PROCEDURE

1. In the **Project** window, deselect all events or parts.
2. Select the tracks that you want to colorize.
3. On the **Project** window toolbar, select **Select Color for Selected Tracks or Events**. The **Colorize** pane opens.

NOTE

If you want to select colors by names instead, activate the **Select Colors by Name** option in the **Project Colors Setup** dialog (**Options** page).

-
4. Select a color.

RESULT

The selected tracks are colorized, and the events and parts get the track color.

NOTE

If you assign a different color to individual events or parts with the **Color** tool, events or parts no longer follow color changes of the track.

RELATED LINKS

- [Colorizing Events on the Fly](#) on page 97
- [Options Tab](#) on page 100

Colorizing Single Tracks

You can colorize single tracks via the **Inspector** or the track list. This is useful if you want to ensure that no other tracks, events, or parts are colorized accidentally.

PROCEDURE

1. Do one of the following:
 - Select the track that you want to colorize, and in the **Inspector**, click **Colorize Selected Track**.



- **Ctrl/Cmd**-click the left area of the track list.

The **Colorize** pane opens.

NOTE

If you want to select colors by names instead, activate the **Select Colors by Name** option in the **Project Colors Setup** dialog (**Options** page).

2. Select a color.
-

RESULT

The track is colored, and any events or parts on that track get the same color.

NOTE

If you assign a different color to individual events or parts with the **Color** tool, they no longer follow color changes of the track.

RELATED LINKS

[Colorizing Events on the Fly](#) on page 97

[Options Tab](#) on page 100

Resetting the Track Color

You can reset the color of a track to the default color.

PROCEDURE

1. In the **Project** window, select the track that you want to reset to the default color, and deselect all events or parts.
 2. On the **Project** window toolbar, select **Select Color for Selected Tracks or Events**.
 3. In the **Colorize** pane, click **Set Track Color to Default**.
-

RESULT

The default color is assigned to the selected track.

Colorizing Selected Events or Parts

You can colorize selected events or parts with **Select Color for Selected Tracks or Events**. By default, events or parts follow the color of the corresponding track. However, you can overwrite this setting and, for example, select the same color for events or parts that reside on different tracks.

PROCEDURE

1. In the **Project** window, select all events or parts that you want to colorize.
2. On the **Project** window toolbar, select **Select Color for Selected Tracks or Events**.
The **Colorize** pane opens.

NOTE

If you want to select colors by names, activate the **Select Colors by Name** option in the **Project Colors Setup** dialog (**Options** page).

3. Select a color.
-

RESULT

The selected events are colorized and no longer follow the color changes of the track.

RELATED LINKS

[Colorizing Events on the Fly](#) on page 97

[Options Tab](#) on page 100

[Event Colors Menu](#) on page 914

Colorizing Events on the Fly

You can colorize events or parts with the **Color** tool. By default, events or parts follow the color of the corresponding track. However, you can overwrite this setting and, for example, select the same color for events or parts that reside on different tracks.

PROCEDURE

1. In the **Project** window toolbar, select the **Color** tool.
 2. Do one of the following to select a tool color:
 - **Alt/Opt**-click an event or part to copy its color.
 - Move the mouse pointer over the **Color** tool, and use the mouse wheel to step through the colors of the current color set.
 3. Optional: Select the events or parts that you want to colorize with the **Object Selection** tool. This is only necessary if you want to colorize multiple events or parts.
 4. On the **Project** window toolbar, select the **Color** tool.
 5. Click the events or parts that you want to colorize.
-

RESULT

The events or parts are colorized and no longer follow color changes of the track.

NOTE

You can also **Ctrl/Cmd**-click an event or part with the **Color** tool to open the **Colorize** pane or to select colors by names.

RELATED LINKS

[Colorizing Selected Events or Parts](#) on page 96

[Options Tab](#) on page 100

[Event Colors Menu](#) on page 914

Setting Event Colors to Track Colors

You can set the color of events or parts to the track color. This is useful if you colorized events or parts with the **Color** tool and you want them to follow the track color again.

PROCEDURE

1. In the **Project** window, select the event or part that you want to set to the track color.
 2. On the **Project** window toolbar, click **Select Color for Selected Tracks or Events**.
 3. In the **Colorize** pane, click **Set Event Color to Track**.
-

RESULT

The track color is assigned to the selected event or part.

RELATED LINKS

- [Colorizing Events on the Fly](#) on page 97
- [Event Colors Menu](#) on page 914

Project Colors Setup Dialog

The **Project Colors Setup** dialog allows you to set up colors for your project.

- To open the **Project Colors Setup** dialog, select **Project > Project Colors Setup**.



RELATED LINKS

- [Color Picker](#) on page 101
- [Color Set Tab](#) on page 99
- [Presets Tab](#) on page 100
- [Options Tab](#) on page 100

Color Set Tab

The **Color Set** tab allows you to change the color set that is used in the project.

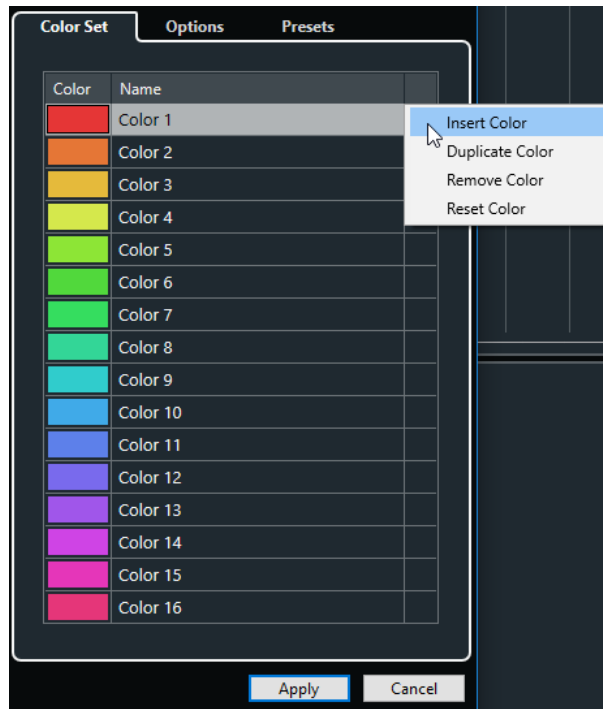

The following options are available:

Color fields

Click a field to open the **Color Picker** that allows you to specify a new color.

Name

Shows the name of the color. Double-click to change it.

Set up

Allows you to add or remove color fields.

- **Insert Color**
Adds a new color field.
- **Duplicate Color**
Duplicates the selected color field.
- **Remove Color**
Removes the selected color field.
- **Reset Color**
Resets the selected color field to the factory settings.

Apply

Applies your changes and closes the dialog.

RELATED LINKS

[Color Picker](#) on page 101

Presets Tab

The **Presets** tab allows you to expand the color set to 24 or even 32 colors or reduce it to 8 colors. You can add tints, and you can sort colors according to their color tint or their basic color.

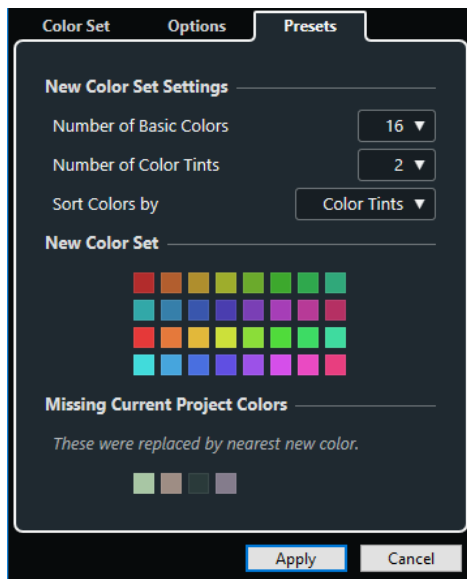

In the **New Color Set Settings** section, the following options are available:

Number of Basic Colors

You can set up 8, 16, 24, or 32 basic colors.

Number of Color Tints

You can set up 1, 2, or 4 color tints.

Sort Colors by

Allows you to sort the colors of the color set by their basic color or by their color tint.

The **New Color Set** section displays the current colors of the new color set.

The **Missing Current Project Colors** section shows which missing colors will be replaced. Move the mouse pointer over the color field of a color that is missing to highlight the color that is used to replace it in the **New Color Set** section.

Apply

Applies your changes and closes the dialog.

Options Tab

The **Options** tab allows you to access the color set options.

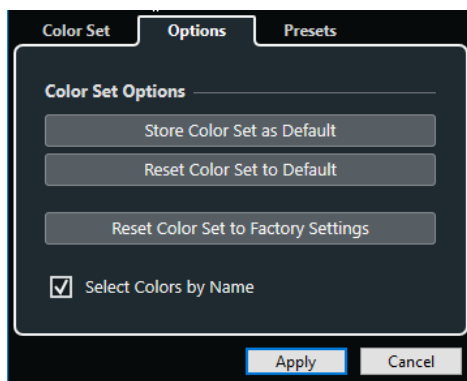

In the **Color Set Options** section, the following options are available:

Store Color Set as Default

Saves the current set of colors as default.

Reset Color Set to Default

Applies the default set of colors.

Reset Color Set to Factory Settings

Returns to the standard color palette.

Select Colors by Name

Allows you to select the colors by name.

Apply

Applies your changes and closes the dialog.

Color Picker

The **Color Picker** allows you to define new custom colors.

To open the **Color Picker**, do one of the following:

- Select **Project > Project Colors Setup**, and in the **Project Colors Setup** dialog on the **Color Set** tab, click a color field.
This allows you to define custom project colors.
- Select **Edit > Preferences**, select one of the **User Interface** entries, and click a color field.
This allows you to define custom user interface colors.

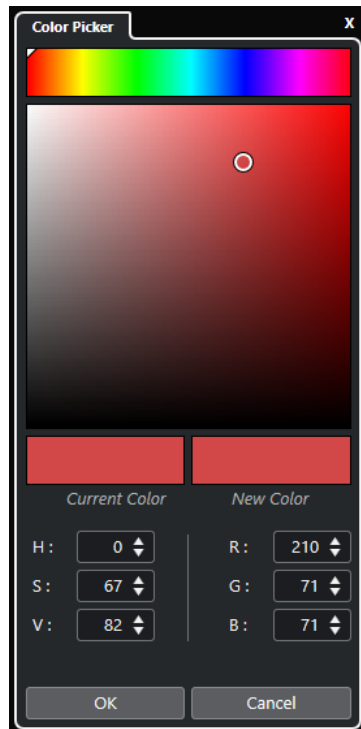

Color selectors

Allow you to select a color shade and the nuance of the shade.

Context menu

Allows you to copy, paste, or reset colors.

Current Color/New Color

Shows the current color and the new color.

Hue/Saturation/Value

Allow you to edit the colors numerically.

Red/Green/Blue

Allow you to edit the colors numerically.

OK

Confirms the color changes.

NOTE

You must restart the application for some changes to take effect.

Project Handling

In Nuendo, projects are the central documents. You must create and set up a project to work with the program.

Creating New Projects

You can create empty projects or projects that are based on a template.

PROCEDURE

1. Select **File > New Project.**

Depending on your settings, either the **Hub** or the **New Project** dialog opens.

2. Hub only: In the location options section, select where to store the new project.

- To use the default location, select **Use default location.**
- To choose another location, select **Prompt for project location.**

3. Do one of the following:

- To create an empty new project via the **Hub**, click **Create Empty.**
- To create an empty new project via the **New Project** dialog, select **Empty** and click **OK.**
- To create a new project from a template via the **Hub**, select a template and click **Create.**
- To create a new project from a template via the **New Project** dialog, select a template and click **OK.**

RESULT

A new, untitled project is created. If you selected a template, the new project is based on this template and includes the corresponding tracks, events, and settings.

NOTE

If you create an empty project, your default presets for the input and output bus configurations are applied. If you have not defined default presets, the last used configurations are applied.

RELATED LINKS

[Presets for Input and Output Busses](#) on page 36

Hub

Hub keeps you up to date with the latest information and assists you with organizing your projects.

To open the **Hub**, do one of the following:

- Select **Hub > Open Hub.**
- Select **File > New Project.**

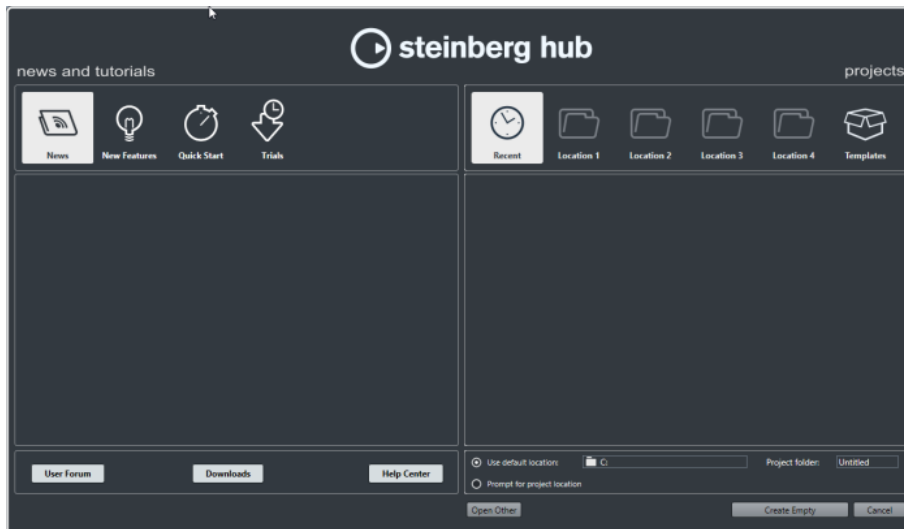

News and Tutorials Section

The **News and Tutorials** section displays Steinberg news, tutorial videos as well as links to the user forum, downloads, and the Help Center.

NOTE

Ensure that you have an active Internet connection to access this material.

Projects Section

The **Projects** section lets you create new projects, which can either be empty or based on a template. It lets you specify where to save the projects. It also allows you to access recently opened projects or projects that are stored in other locations.

Category bar

The **Recent** category contains a list of the recently opened projects.

The **Location** categories are user defined locations that contain projects.

The **Templates** category contains the available factory templates.

Template list

When you click on one of the category items, the list below the category bar shows the available templates for this category. Any new templates that you create are added at the top of the corresponding list.

Location options

This section allows you to specify where the project is stored.

Open Other

This button allows you to open any project file on your system. This is identical to using the **Open** command on the **File** menu.

Deactivating the Hub

To start Nuendo or to create new projects without the **Hub**, you can deactivate it.

PROCEDURE

1. In the **Preferences** dialog, select **General**.

2. Deactivate **Use Hub**.

RESULT

Nuendo starts without opening a project and opens the **New Project** dialog when you create a new project using the **File** menu. However, you can still open the **Hub** through the **Hub** menu.

New Project Dialog

When you deactivate the **Hub** and create new projects, the **New Project** dialog opens. This dialog allows you to create new projects which can either be empty or based on a template.

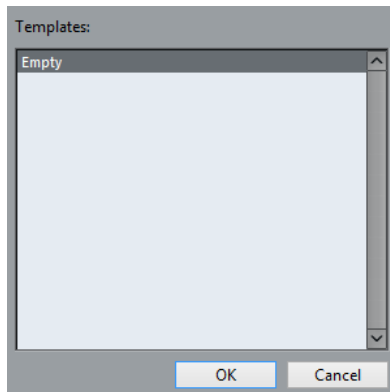

Project Files

A project file (extension *.npr) is the central document in Nuendo. A project file contains references to media data that can be saved in the project folder.

NOTE

We recommend to save files only in the project folder, even though you can save them in any other location to which you have access.

The project folder contains the project file and the following folders that Nuendo automatically creates when necessary:

- Audio
- Clip Packages
- Edits
- Images
- Network
- Track Pictures

Template Files

Templates can be a good starting point for new projects. Templates are projects where you can save all settings that you regularly use, such as bus configurations, sample rates, record formats, basic track layouts, VSTi setups, drum map setups, etc.

Template projects are not saved in project folders and therefore contain no subfolders and no media files.

- To open the location of a specific template, right-click a template in the template list and select **Show in Explorer** (Windows only) or **Reveal in Finder** (macOS only).

Save As Template Dialog

The **Save As Template** dialog allows you to save projects as templates.

- To open the **Save As Template** dialog, select **File > Save As Template**.

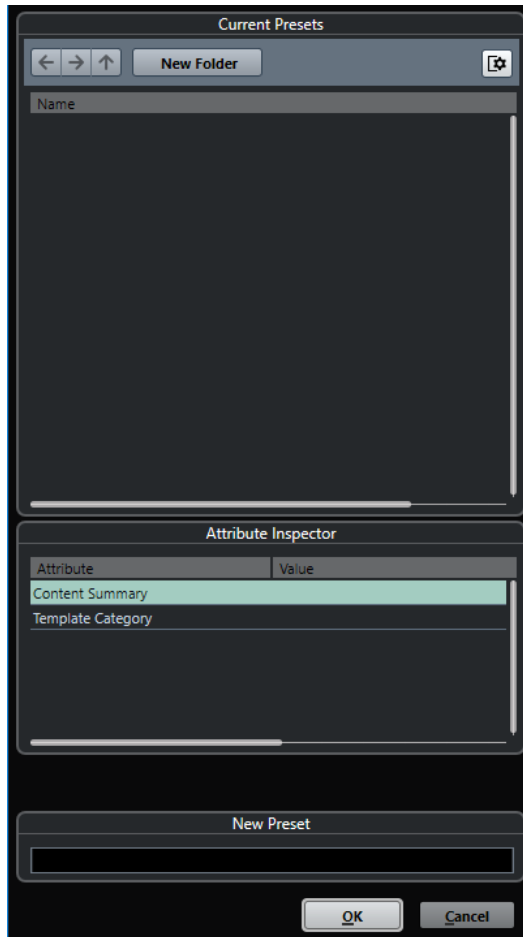

The following options are available in the **Current Presets** section:

New Folder

Allows you to add and name a folder to the template list.

Template list

Lists the templates and the folders.

The following options are available in the **Attribute Inspector** section:

Value

Click this field to enter a description for the **Content Summary** attribute, or to select a template category for **Template Category** attribute.

The following options are available in the **New Preset** section:

New Preset

Allows you to enter a name for the new project template.

Show Attribute Inspector

Allows you to show/hide the **Attribute Inspector**.

Saving a Project Template File

You can save the current project as a template. When you create a new project, you can select this template as a starting point for your new project.

PREREQUISITE

You have removed all clips from the **Pool**. This ensures that references to media data from the original project folder are deleted.

PROCEDURE

1. Set up a project.
2. Select **File > Save as Template**.
3. In the **New Preset** section of the **Save as Template** dialog, enter a name for the new project template.

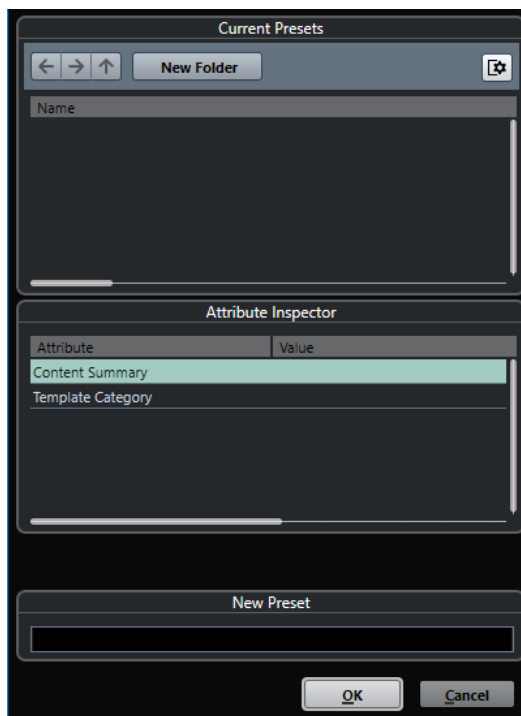

4. In the **Attribute Inspector** section, double-click the **Value** field of the **Content Summary** attribute to enter a description for the template.
 5. Click the **Value** field of the **Template Category** attribute and select a template category from the pop-up menu.
If you do not select a category, the new template will be listed in the **Hub** in the **Templates** category.
 6. Click **OK** to save the template.
-

Renaming Templates

You can rename template files from within the **Hub**.

PROCEDURE

1. In the **Hub**, right-click a template and select **Rename**.
 2. In the **Rename** dialog, enter a new name and click **OK**.
-

Project Setup Dialog

The **Project Setup** dialog allows you to make general settings for your project.

- To open the **Project Setup** dialog, select **Project > Project Setup**.
- To open the **Project Setup** dialog automatically when you create a new project, activate the **Run Setup on Create New Project** option in the **Preferences** dialog (**General** page).

The screenshot shows the Project Setup dialog with the following sections and settings:

- Project Duration**: Project Start Time (00:00:00:00), Project Length (00:05:10:17)
- Project Frame Rate**: Project Frame Rate (25 fps), Get Frame Rate from Video (button), Audio Pull-up/Pull-down (Off)
- Project Time Displays**: Display Format (Feet+Frames 16mm), Use Film Pull Factor (- 0.1%) (On), Display Time Offset (00:00:00:00), Display Bar Offset (0)
- Record File Format**: Sample Rate (44.100 kHz), Bit Depth (24 bit), Record File Type (Wave File)
- Project Ownership**: Author (Enter Name), Company (Enter Company)
- Other Project Settings**: Stereo Pan Law (Equal Power), Volume Max (+6 dB)
- Hermodne Tuning**: HMT Type (None), HMT Depth (100 %)

IMPORTANT

While most **Project Setup** settings can be changed at any time, you must set the sample rate directly after creating a new project. If you change the sample rate at a later stage, you must convert all audio files in the project to the new sample rate to make them play back properly.

In the **Project Duration** section, the following options are available:

Project Start Time

Allows you to specify the start time of the project in timecode format. This also determines the sync start position when synchronizing to external devices.

Project Length

Allows you to specify the length of the project.

Project Frame Rate

In the **Project Frame Rate** section, the following options are available:

Project Frame Rate

Allows you to specify the timecode standard and frame rate for the project. When synchronizing to an external device, this setting must correspond to the frame rate of any incoming timecode.

Get Frame Rate From Video

Allows you to set the project frame rate to the frame rate of an imported video file.

Project Time Displays

In the **Project Time Displays** section, the following options are available:

Display Format

Allows you to specify the global display format that is used for all rulers and position displays in the program, except the ruler tracks. However, you can make independent display format selections for the individual rulers and displays.

Use Film Pull Factor (-0.1%)

Adjusts audio playback speed to match the video.

Display Time Offset

Allows you to specify an offset for the time positions that are displayed in the rulers and position displays to compensate for the **Project Start Time** setting.

Display Bar Offset

This setting is only used if you select the **Bars+Beats** display format. Allows you to specify an offset for the time positions that are displayed in the rulers and position displays to compensate for the **Project Start Time** setting.

Record File Format

In the **Record File Format** section, the following options are available:

Sample Rate

Allows you to specify the sample rate at which Nuendo records and plays back audio.

- If your audio hardware generates the sample rate internally and you select a non-supported sample rate, this is indicated by a different color. In this case, you must set a different sample rate to make your audio files play back properly.
- If you select a sample rate that your audio hardware supports, but that differs from its current sample rate setting, it is automatically changed to the project sample rate.
- If your audio hardware is externally clocked and receives external clock signals, sample rate mismatches are accepted.

Bit Depth

Allows you to specify the bit depth of the audio files that you record in Nuendo. Select the record format according to the bit depth that is delivered by your audio hardware. The available options are 16 bit, 24 bit, 32 bit, 32 bit float, and 64 bit float.

NOTE

- If your audio interface supports a bit depth of 32 bit, and you want to maintain this precision in your recordings, you must select a **Processing Precision** of 64 bit float in the **Studio Setup** dialog.
- When you record with effects, consider setting the bit depth to 32 bit float or 64 bit float. This prevents clipping (digital distortion) in the recorded files and keeps the audio quality very high. Effect processing and level or EQ changes in the input channel are done in 32-bit float or 64-bit float format, depending on the **Processing Precision** setting in the **Studio Setup** dialog. If you record at 16 bit or 24 bit, the audio will be converted to this lower bit depth when it is written to a file. As a result, the signal may degrade. This is independent of the actual bit depth of your audio hardware. Even if the signal from the audio hardware has a bit depth of 16 bit, the signal will be 32 bit float or 64 bit float after the effects are added to the input channel.

- The higher the bit depth value, the larger the files and the more strain is put on the disk system. If this is an issue, you can lower the record format setting.

Record File Type

Allows you to specify the file type of the audio files that you record in Nuendo.

NOTE

- For wave file recordings larger than 4 GB, the EBU RIFF standard is used. If a FAT 32 disk is used (not recommended), audio files are split automatically. In the **Preferences** dialog, you can specify what happens if your recorded Wave file is larger than 4 GB.
- You can set up embedded strings in the **Preferences** dialog.

Project Ownership

In the **Project Ownership** section, the following options are available:

Author

Allows you to specify a project author that is written into the file, when you export audio files and activate the **Insert iXML chunk** option. You can specify a default author in the **Default Author Name** field in the **Preferences** dialog (**General—Personalization** page).

Company

Allows you to specify a company name that is written into the file, when you export audio files and activate the **Insert iXML chunk** option. You can specify a default company in the **Default Company Name** field in the **Preferences** dialog (**General—Personalization** page).

Other Project Settings

In the **Other Project Settings** section, the following options are available:

Stereo Pan Law

If you pan a channel left or right, the sum of the left and right side is higher (louder), than if this channel is panned center. These modes allow you to attenuate signals panned center. **0 dB** turns off constant-power panning. **Equal Power** means that the power of the signal remains the same regardless of the pan setting.

Volume Max

Allows you to specify the maximum fader level. By default, this is set to +12 dB. If you load projects that were created with Nuendo versions older than 5.5, this value is set to the old default value of +6 dB.

Hermoder Tuning

In the **Hermoder Tuning** section, the following options are available:

HMT Type (MIDI only)

Allows you to specify a mode for Hermoder tuning of MIDI notes.

HMT Depth (MIDI only)

Allows you to specify the overall degree of retuning.

Project Location

In the **Project Location** section, the following options are available:

Project Location information

Displays the project location.

Show in Explorer/Reveal in Finder

Opens a file dialog that shows the location of the project file.

RELATED LINKS

[Audio System Page](#) on page 19

[Record - Audio](#) on page 1372

Opening Project Files

You can open one or several saved project files at the same time.

IMPORTANT

If you open a project saved with a different program version that contains data for functions that are not available in your version, this data may be lost when you save the project with your version.

NOTE

- If you open an external project, the last used view that was saved on your computer is used. You can change this setting in the **Preferences** dialog (**General** page).
- External projects are automatically connected to the input and output busses. If you open a project that was created on a computer with an ASIO port configuration different from the configuration of your computer, this can result in unwanted audio connections. You can deactivate the automatic connection of input and output busses in the **Preferences** dialog (**VST** page).

PROCEDURE

1. Select **File > Open**.
2. In the **Hub**, click **Recent** or select a **Location**.
3. Select the project from the projects list, and click **Open**.
4. If there already is an open project, you are asked if you want to activate the new project. Do one of the following:
 - To activate the project, click **Activate**.
 - To open the project without activating it, click **No**.
This reduces load times for projects.

RELATED LINKS

[Workspaces for External Projects](#) on page 1336

[Do Not Connect Input/Output Busses When Loading External Projects](#) on page 1379

[Activating Projects](#) on page 112

Activating Projects

If you have several projects opened at the same time in Nuendo, only one project can be active. The active project is indicated by the lit **Activate Project** button in the upper left corner of the **Project** window. If you want to work on another project, you have to activate the other project.

PROCEDURE

- To activate a project, click **Activate Project** .

NOTE

If you close the active project, you must activate another open project manually as Nuendo can not automatically activate one of the other open projects.

Opening Project Files from Locations

You can open project files from specific locations. This is especially useful in situations where different users work on different projects on the same computer.

PROCEDURE

1. Do one of the following:
 - Select **File > Open**.
 - Select **Hub > Open Hub**.
2. In the **Hub**, click a **Location** icon on the category bar, and click again to open the **Locations** pop-up menu.
3. In the **Locations** pop-up menu, select **Assign User Location**.
4. In the file dialog, select a location and click **OK**.

All projects that are saved in this location are listed in the projects list. Depending on the size of the files, this may take a while.

NOTE

You can add the location to the **MediaBay** to speed up the displaying of results.

5. In the projects list, select the project that you want to open.
 6. Click **Open**.
-

Locations Menu

The **Locations** pop-up menu allows you to manage the user locations.

- To open the **Locations** pop-up menu, open the **Hub**, click a **Location** icon on the category bar, and click again to open the pop-up menu.

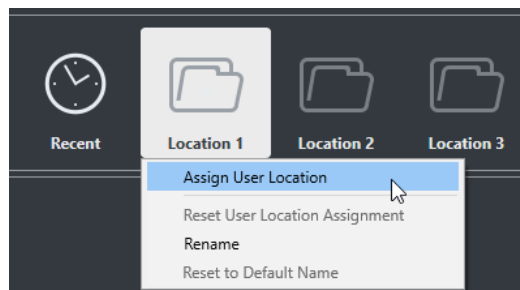

The following options are available:

Assign User Location

Allows you to select a location on your computer.

Reset User Location Assignment

Deletes the assignment.

Rename

Allows you to rename the name of the location in the **Hub**. The name of the original location will not be changed.

Reset to Default Name

Resets the name of the location in the **Hub** to the original location name.

RELATED LINKS

[Hub](#) on page 103

Opening Recent Projects

You can open recent projects directly from the recent projects list.

PROCEDURE

- Do one of the following:
 - In the category bar of the **Hub**, click **Recent**, select a project from the projects list, and click **Open**.
 - Select **File > Recent Projects** and select a recently opened project.
-

Re-Routing Missing Ports

If you open a Nuendo project that was created on a different system with other audio hardware, Nuendo tries to find matching audio inputs and outputs for the input/output busses. If Nuendo cannot resolve all audio/MIDI inputs and outputs that are used in the project, the **Missing Ports** dialog opens.

This allows you to manually re-route any ports specified in the project to ports that are available in your system.

NOTE

To improve the search for matching audio inputs and outputs for the input/output busses, you should use descriptive, generic names for your input and output ports.

RELATED LINKS

[Renaming the Hardware Inputs and Outputs](#) on page 34

Saving Project Files

You can save the active project as a project file. To keep your projects as manageable as possible, make sure that you save project files and all related files in the respective project folders.

- To save the project and specify a file name and location, open the **File** menu and select **Save As**.
- To save the project with its current name and location, open the **File** menu and select **Save**.

Auto Save

Nuendo can automatically save backup copies of all open project files with unsaved changes.

NOTE

Only the project files are backed up. If you want to include the files from the **Pool** and save your project in a different location, you must use the **Back up Project** function.

Nuendo can automatically save backup copies of all open projects with unsaved changes. To set this up, activate the **Auto Save** option in the **Preferences** dialog (**General** page). The backup copies are named “<project name>-xx.bak” where xx is an incremental number. Unsaved projects are backed up in a similar way as “UntitledX-xx.bak”, with X being the incremental number for unsaved projects. All backup files are saved in the project folder.

- To specify the time intervals in which a backup copy is created, use the **Auto Save Interval** setting.
- To specify how many backup files are created with the **Auto Save** function, use the **Maximum Backup Files** option. When the maximum number of backup files is reached, the existing files are overwritten, starting with the oldest file.

Saving Project Files As a New Version

You can create and activate a new version of an active project file. This is useful if you are experimenting with edits and arrangements and want to be able to go back to a previous version at any time.

PROCEDURE

- Do one of the following:
 - Select **File > Save New Version**.
 - Press **Ctrl/Cmd - Alt/Opt - S**.
-

RESULT

The new file is saved with the same name as the original project and an attached incremental number. For example, if your project is called “My Project”, new versions are called “My Project-01”, “My Project-02”, and so on.

Reverting to the Last Saved Version

You can return to the last saved version and discard all changes that have been introduced.

PROCEDURE

1. Select **File > Revert**.
 2. In the warning message, click **Revert**.
If you have recorded or created new audio files since the last version was saved, you are prompted to delete or keep the files.
-

Choosing a Project Location

You can specify a project location for saving projects in the **Hub**.

PROCEDURE

1. Do one of the following:
 - Select **Use default location** to create a project in the default project location, and in the **Project folder** field, specify a name for the project folder. If you do not specify a project folder here, the project is saved in a folder named `Untitled`.

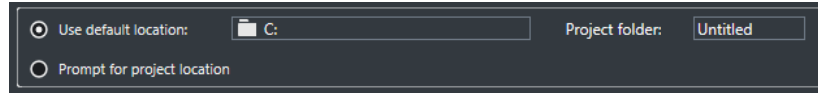

- Click in the path field to change the default project location, and specify the new default location in the file dialog that opens.
 - Activate **Prompt for project location** to open a file dialog where you can specify the project folder location.
2. Do one of the following:
 - Click **Create Empty** to create a new empty project.
 - Select one of the template projects and click **Create** to create a project based on a template.

RESULT

The project is created and saved in the specified location.

Self-Contained Projects

If you want to share your work or transfer it to another computer, your project must be self-contained.

The following functions facilitate this task:

- Select **Media > Prepare Archive** to verify that every clip that is referenced in the project is located in the project folder, and to take actions if that is not the case.
- Select **File > Back up Project** to create a new project folder where you can save the project file and the necessary work data. The original project remains unchanged.

RELATED LINKS

[Preparing Archives](#) on page 115

[Backing up Projects](#) on page 116

Preparing Archives

The **Prepare Archive** function allows you to gather all files that are referenced by your project to ensure that these are in the project folder. This is useful if you want to move or archive your project.

PROCEDURE

1. Select **Media > Prepare Archive**.

If your project references external files, you are prompted if you want to copy them to your working directory. If any processing has been applied, you must decide if you want to flatten edits.
2. Click **Proceed**.

RESULT

Your project is ready to be archived. You can move or copy the project folder to another location.

AFTER COMPLETING THIS TASK

You must copy audio files that reside within the project folder to the **Audio** folder or save them separately. You must also move your video clips manually, as videos are only referenced and not saved in the project folder.

Backing up Projects

You can create a backup copy of your project. Backups only contain the necessary work data. All media files except the files from VST Sound archives are included as a copy.

PROCEDURE

1. Select **File > Back up Project**.
 2. Select an empty folder or create a new one.
 3. Make your changes in the **Back up Project Options** dialog and click **OK**.
-

RESULT

A copy of the project is saved in the new folder. The original project remains unaffected.

NOTE

VST Sound content provided by Steinberg is copy-protected and is not included in the backup project. If you want to use a backup copy that uses VST Sound content on a different computer, make sure that the corresponding content is also available on that computer.

Back up Project Options Dialog

The **Back up Project Options** dialog allows you to create a backup copy of your project.

- To open the **Back up Project Options** dialog, select **File > Back up Project**.

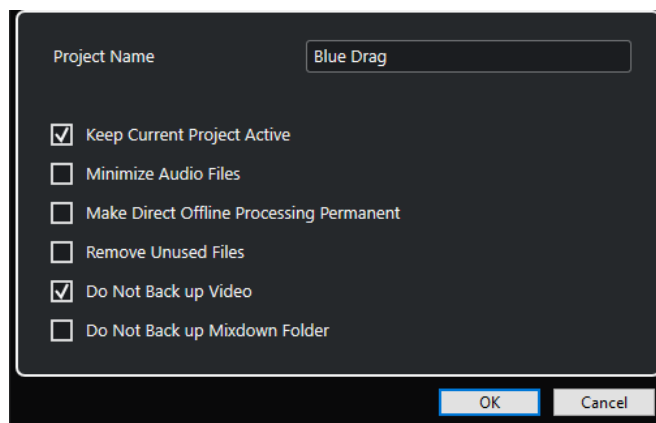

Project Name

Allows you to change the name of the backed up project.

Keep Current Project Active

Allows you to keep the current project active after clicking **OK**.

Minimize Audio Files

Allows you to include only the audio file portions that are actually used in the project. This can significantly reduce the size of the project folder if you are using small sections of large files. It also means that you cannot use other parts of the audio files if you continue working with the project in its new folder.

Make Direct Offline Processing Permanent

Allows you to flatten all edits and make all processing and applied effects permanent to each clip in the **Pool**.

Remove Unused Files

Allows you to remove unused files and to back up only the files that are actually used.

Do Not Back up Video

Allows you to exclude video clips on the video track or in the **Pool** of the current project.

Do Not Back up Mixdown Folder

Allows you to exclude the **Mixdown** folder of your project from the backup.

RELATED LINKS

[Export Audio Mixdown Dialog](#) on page 1162

Tracks

Tracks are the building blocks of your project. They allow you to import, add, record, and edit parts and events. Tracks are listed from top to bottom in the track list and extend horizontally across the **Project** window. Each track is assigned to a particular channel strip in the **MixConsole**.

If you select a track in the **Project** window, the controls, settings, and parameters displayed in the **Inspector** and the track list allow you to control the track.



Track Inspector Settings Dialog

The **Track Inspector Settings** dialog allows you to configure for each track type which **Inspector** sections are shown. You can also specify the order of the sections.

- To open the **Track Inspector Settings** dialog, click **Set up Inspector**, and select **Setup** from the pop-up menu.

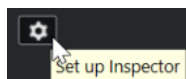

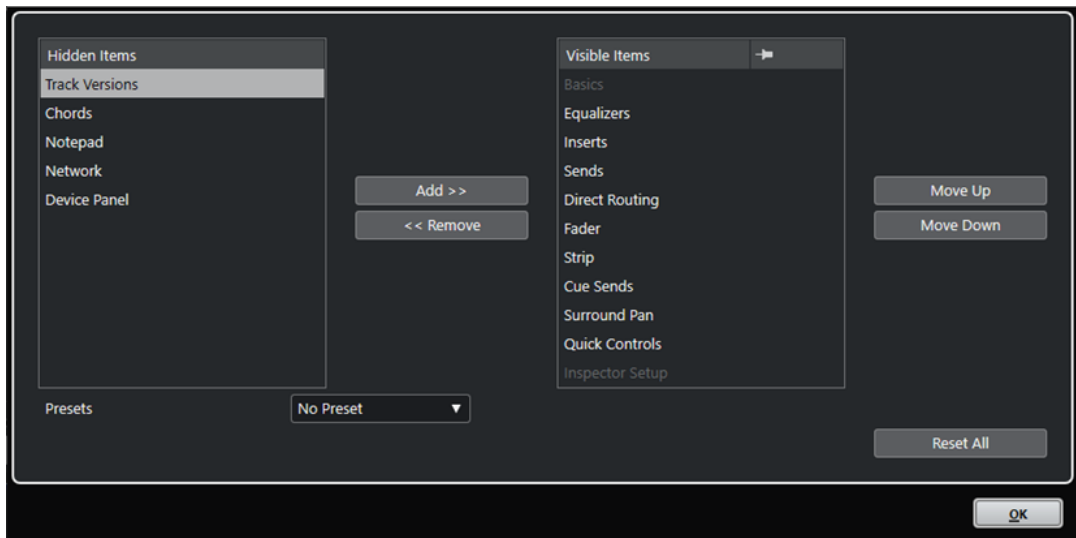

Hidden Items

Displays sections that are hidden in the **Inspector**.

Visible Items

Displays sections that are visible in the **Inspector**.

Pin

Activate **Pin** by clicking the column for a section to exclude this section from being closed automatically.

Add

Allows you to move an item selected in the hidden sections list to the list of visible sections.

Remove

Allows you to move an item selected in the visible sections list to the list of hidden sections.

Move Up/Move Down

Allows you to change the position of an item in the list of visible sections.

Presets

Allows you to save **Inspector** settings as presets.

Reset All

Allows you to restore the default **Inspector** settings.

Inspector Sections

Each track type has its basic track settings that are always shown. Apart from these, you can set up other track-specific **Inspector** sections in the **Track Inspector Settings** dialog.

Depending on the track type, you can set up the following **Inspector** sections:

Track Versions

Allows you to create and edit **Track Versions**.

Chords

Allows you to specify how the track follows the chord track.

Inserts

Allows you to add audio insert effects to the track.

Equalizers

Allows you to adjust the EQs for the track. You can have up to four bands of EQs for each track.

Sends

Allows you to route the track to one or several FX channels.

Cue Sends

Allows you to route cue mixes to **Control Room** cues.

Strip

Allows you to set up the channel strip modules.

Direct Routing

Allows you to set up direct routing.

Surround Pan

Shows the panner for a track.

Fader

Shows a duplicate of the corresponding **MixConsole** channel.

Notepad

Allows you to enter notes about the track.

Device Panel

Allows you to display and use device panels.

Quick Controls

Allows you to configure quick controls to use remote devices, for example.

Network

Shows the network connection of the track.

Expression Map

Allows you to work with the **Expression Map** features.

Note Expression

Allows you to work with the **Note Expression** features.

MIDI Modifiers

Allows you to transpose or adjust the velocity of the MIDI track events in real time during playback.

MIDI Inserts

Allows you to add MIDI insert effects.

Instrument

Shows the audio-related controls for the sampler track.

MIDI Sends

Allows you to add MIDI send effects.

MIDI Fader

Shows a duplicate of the corresponding **MixConsole** channel.

RELATED LINKS

[Inspector Sections](#) on page 68

[Track Inspector Settings Dialog](#) on page 118

[Track Versions Section](#) on page 195

[Insert Effects](#) on page 504

[Send Effects](#) on page 513
[Equalizers \(EQ\)](#) on page 442
[Chords Section for MIDI Tracks](#) on page 1067
[Chords Section for Audio Tracks](#) on page 1066
[Cue Sends](#) on page 453
[Channel Strips](#) on page 445
[Direct Routing](#) on page 454
[Miniature Views](#) on page 752
[Device Panels](#) on page 897
[Track Quick Controls](#) on page 858
[Networking](#) on page 1185
[Expression Maps](#) on page 1015
[Note Expression](#) on page 1027
[MIDI Modifiers Section](#) on page 883
[MIDI Inserts](#) on page 887
[MIDI Sends](#) on page 889

Track Controls Settings Dialog

The **Track Controls Settings** dialog allows you to configure which track controls are shown in the track list. You can also specify the order of controls and group controls so that they are always shown adjacent to each other.

NOTE

The **Track Controls Settings** dialog is available for the main track types. Track types that can only be added once have their fixed set of track-specific controls. In the global **Add Track** dialog, these tracks are shown in the **More Tracks** section. An exception to this are the chord track and the video track.

- To open the **Track Controls Settings** dialog, right-click a track in the track list and select **Track Controls Settings** from the context menu, or click **Open Track Controls Settings Dialog** in the bottom right corner of the track list.

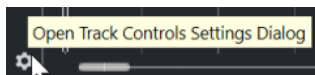

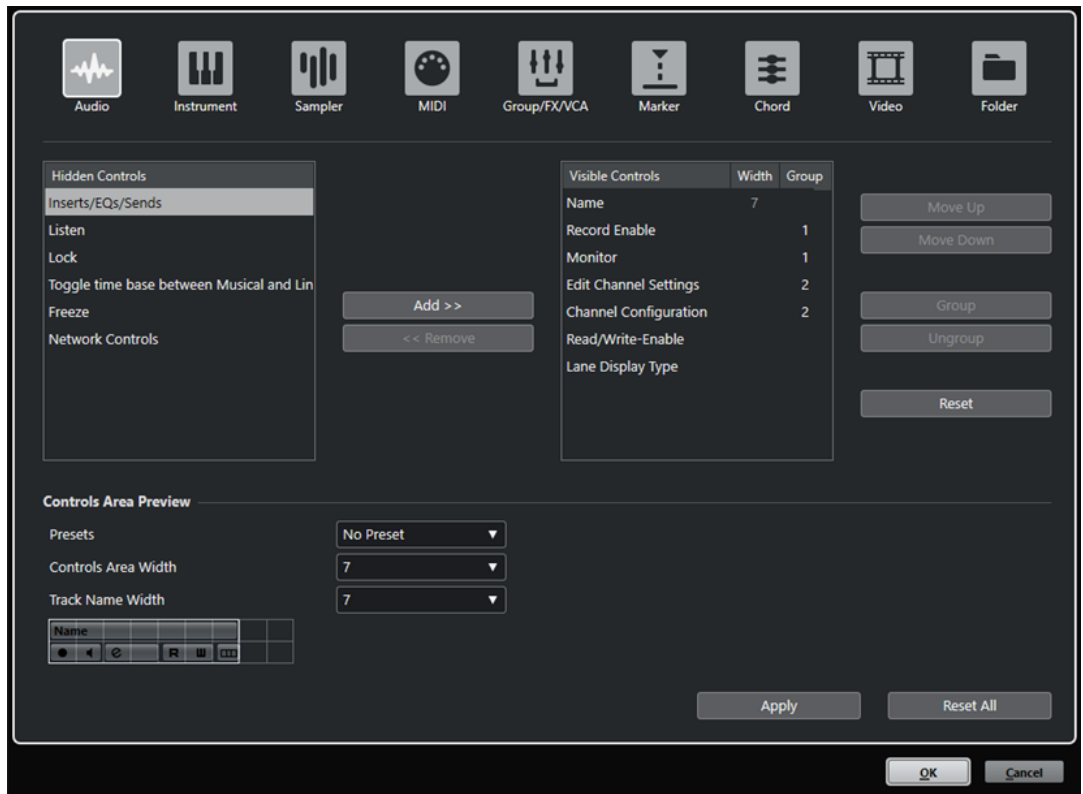

Track type

Allows you to select the track type to which your settings are applied.

Hidden Controls

Displays controls that are hidden in the track list.

Visible Controls

Displays controls that are visible in the track list.

Width

If you click in this column, you can set the maximum length for the track name.

Group

Displays the group number.

Add

Allows you to move an item selected in the hidden controls list to the list of visible controls.

Remove

Allows you to move an item selected in the visible controls list to the list of hidden controls. All controls can be removed except **Mute** and **Solo**.

Move Up/Move Down

Allows you to change the order of an item in the list of visible controls.

Group

Allows you to group two or more controls selected in the visible controls list that are adjacent to each other. This ensures that they are always positioned side by side in the track list.

Ungroup

Allows you to ungroup grouped controls in the visible controls list. To remove an entire group, select the first (topmost) element belonging to this group and click **Ungroup**.

Reset

Allows you to restore all default track controls settings for the selected track type.

Controls Area Preview

Shows a preview of the customized track controls.

Presets

Allows you to save track controls settings as presets. To recall a preset, click **Switch Presets** in the bottom right corner of the track list. The name of the selected preset is shown in the left corner.

Controls Area Width

Allows you to determine the width of the track controls area for the selected track type. In the **Controls Area Preview**, this area is shown with a frame.

Track Name Width (global)

Allows you to determine the global name width for all track types.

Apply

Applies your settings.

Reset All

Allows you to restore all default track controls settings for all track types.

RELATED LINKS

[More Tracks](#) on page 157

Track Controls

You can configure which track controls are shown in the track list.

NOTE

You can only configure track controls for the main track types. Track types that can only be added once have their fixed set of track-specific controls. In the global **Add Track** dialog, these tracks are shown in the **More Tracks** section. An exception to this are the chord track and the video track.

The following track controls are always shown:

Mute



Mutes the track.

Solo



Solos the track.

The track name control is available for all track types:

Name



Shows the name of the track. Double-click to rename the track.

Audio-Related Tracks

The following track controls are specific to audio-related tracks, that is, audio tracks, instrument tracks, sampler tracks, group channel tracks, FX channel tracks:

Bypass Inserts



Bypasses the inserts for the track.

Bypass EQs



Bypasses the equalizers for the track.

Bypass Sends



Bypasses the sends for the track.

Freeze Channel



Opens a dialog that allows you to set the **Tail Size** time in seconds.

Channel Configuration



Shows the channel configuration of the track.

Listen



The listen indicator is lit if the track is in listen mode.

MIDI-Related Tracks

The following controls are specific to MIDI-related tracks, that is, MIDI tracks, sampler tracks, and instrument tracks:

ASIO Latency Compensation



Moves all recorded events on the track by the current latency.

Programs

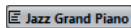

Allows you to select a program.

Edit In-Place



Allows you to edit MIDI events and parts on the track in the **Project** window.

Drum Map



Allows you to select a drum map for the track.

Audio- and MIDI-Related Tracks

The following track controls are specific to audio- and MIDI-related tracks:

Record Enable



Activates the track for recording.

Monitor



For audio-related tracks, this routes incoming signals to the selected output.
For MIDI and instrument-related tracks, this allows you to route incoming MIDI signals to the selected MIDI output. For this to work, activate **MIDI Thru Active** in the **Preferences** dialog (**MIDI** page).

Edit Channel Settings



Opens the **Channel Settings** window for the track.

Show Lanes



Divides the tracks in lanes.

Lock



Disables all editing of all events on the track.

Read Automation



Allows you to read track automation.

Write Automation



Allows you to write track automation.

Instrument Tracks

The following controls are specific to instrument tracks:

Edit Instrument



Allows you to open the instrument panel.

Instrument

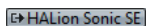

Allows you to select an instrument.

Sampler Tracks

The following controls are specific to sampler tracks:

Open/Close Sampler

Opens/Closes the **Sampler Control** in the lower zone.

MIDI Tracks

The following controls are specific to MIDI tracks:

Channel



Allows you to specify the MIDI channel.

Output

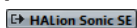

Allows you to specify the output for the track.

Bypass Inserts



Bypasses the inserts for the track.

Bypass Sends



Bypasses the sends for the track.

Group/FX/VCA Tracks

The following track controls are specific to group/FX/VCA tracks:

Mute Automation



Deactivates the automation read function for the selected parameter.

Lock Automation



Disables all editing of all events on the track.

Automation parameter

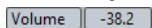

Allows you to select a parameter for automation.

Parameter



Allows you to select a parameter value for automation.

Marker Tracks

The following controls are specific to marker tracks:

Add Marker



Allows you to add a position marker at the project cursor position. This track control is always shown.

Add Cycle Marker



Allows you to add a cycle marker at the project cursor position. This track control is always shown.

Locate



Allows you to move the project cursor to the selected marker position.

Cycle



Allows you to select a cycle marker.

Zoom



Allows you to zoom in a cycle marker.

Activate this Track



Activates this marker track.

Folder Tracks

The following controls are specific to folder tracks:

Group Editing



Allows you to activate the group editing mode.

Expand/Collapse Folder

Shows/Hides the tracks in the folder. Hidden tracks are played back as usual.

Networking Controls

The following track controls are specific to all track types that allow for networking:

Load available update



This button lights up when other users have made changes to a track and committed them over the network to indicate that you can load the changes and update the project.

Automatically apply updates



If this button is activated, all changes that are committed to the tracks by other users are automatically applied.

Get exclusive access



If this button is activated, you have exclusive access to the track. To unlock a track, click the **Get exclusive access** button again.

Commit changes on this track



Commits the changes on this track to the network.

Add Track Dialog

The **Add Track** dialog allows you to set up and add tracks.

To open the **Add Track** dialog, click **Add Track** in the global track controls area of the track list.

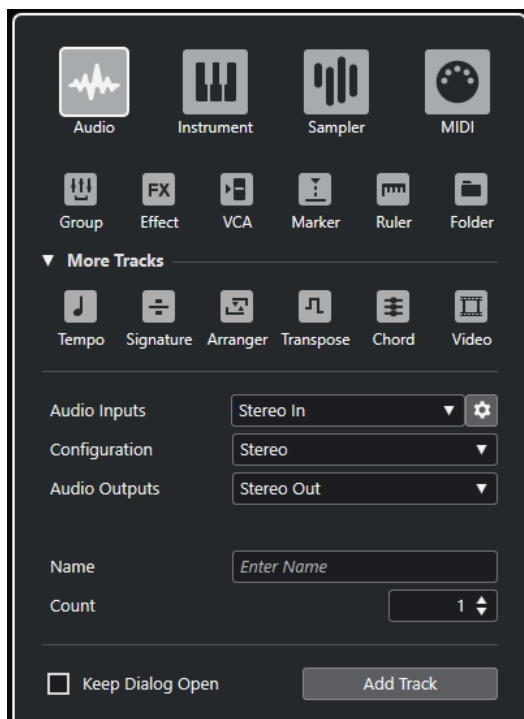

The **More Tracks** section shows track types that can only be added once.

RELATED LINKS

[Add Track Dialog – Audio](#) on page 128

[Add Track Dialog – Instrument](#) on page 132

[Add Track Dialog – Sampler](#) on page 136
[Add Track Dialog – MIDI](#) on page 139
[Add Track Dialog – Group Channel](#) on page 143
[Add Track Dialog – Effect](#) on page 146
[Add Track Dialog – VCA](#) on page 148
[Add Track Dialog – Marker](#) on page 150
[Add Track Dialog – Ruler](#) on page 152
[Add Track Dialog – Folder](#) on page 155
[More Tracks](#) on page 157
[Tempo Track](#) on page 163
[Signature Track](#) on page 162
[Arranger Track](#) on page 158
[Transpose Track](#) on page 164
[Chord Track](#) on page 159
[Video Track](#) on page 165

Audio Tracks

You can use audio tracks for recording and playing back audio events and audio parts. Each audio track has a corresponding audio channel in the **MixConsole**. An audio track can have any number of automation tracks for automating channel parameters, effect settings, etc.

You can add audio tracks via the **Add Track** dialog.

RELATED LINKS

[Add Track Dialog – Audio](#) on page 128

Add Track Dialog – Audio

The **Audio** page of the **Add Track** dialog allows you to set up and add audio tracks.

To open the **Audio** page of the **Add Track** dialog, do one of the following:

- Click **Add Track**  in the global track controls area of the track list, and click **Audio**. This opens the global **Add Track** dialog on the **Audio** page.

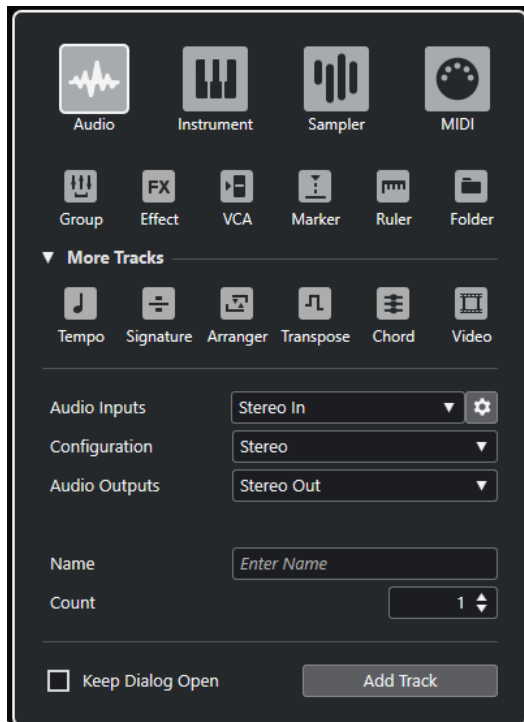

- Select **Project > Add Track > Audio** or right-click in an empty area of the track list, and select **Add Audio Track**.

This opens only the **Audio** page of the **Add Track** dialog.

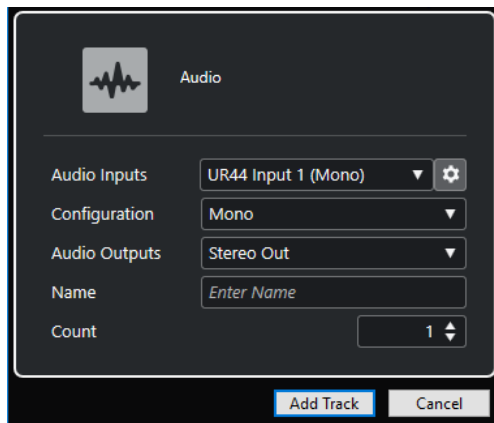

The following settings are available:

Audio Inputs

Opens a window where you can select an input of your connected audio hardware.

If you have added an input bus in the **Audio Connections** window, you can connect to that input bus.

The **Open Audio Connections** button opens the **Audio Connections** window.

Configuration

Allows you to set the channel configuration. Audio-related tracks can be configured as mono, stereo, or surround tracks, with almost any combination of channels.

Audio Outputs

Allows you to set the output routing.

Name

Allows you to specify a track name.

Count

Allows you to enter the number of tracks that you want to add.

NOTE

You can add an unlimited number of tracks. However, you can only add 100 tracks at a time.

Keep Dialog Open

Activate this to keep the dialog open after clicking **Add Track**. This allows you to click the page of another track type to set up and add more tracks.

NOTE

This is only available if you open the **Add Track** dialog from the global track controls.

Add Track

Adds one or more tracks, according to the track type and settings of the active page, and closes the dialog.

RELATED LINKS

[Audio Connections Window](#) on page 28

Audio Track Inspector

The **Inspector** for audio tracks contains controls and parameters that allow you to edit your audio track.

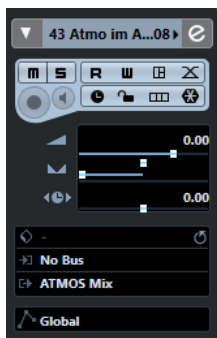

The top section of the audio track **Inspector** contains the following basic track settings:

Track name

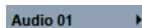

Click once to show/hide the basic track settings section. Double-click to rename the track.

Colorize Selected Track



Allows you to colorize the selected track.

Edit Channel Settings



Opens the **Channel Settings** window for the track.

Mute



Mutes the track.

Solo



Solos the track.

Read Automation



Allows you to read track automation.

Write Automation



Allows you to write track automation.

Open Device Panels



Allows you to create a device panel for the plug-in and device parameters of your track.

Auto Fades Settings



Opens a dialog where you can make separate fade settings for the track.

Record Enable



Activates the track for recording.

Monitor



Routes incoming signals to the selected output.

Toggle Time Base



Switches between musical (tempo-related) and linear (time-related) time base for the track.

Lock



Disables all editing of all events on the track.

Show Lanes



Divides the tracks in lanes.

Freeze Audio Channel



Allows you to freeze the audio channel.

Volume



Allows you to adjust the level of the track.

Pan



Allows you to adjust the panning of the track.

Delay



Allows you to adjust the playback timing of the track.

Load/Save/Reload Track Preset



Loads or saves a track preset or reverts the default presets.

Input Routing

- Allows you to specify the input bus for the track.

Output Routing

- Allows you to specify the output bus for the track.

Track Automation Mode

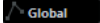
-  Allows you to set the automation mode of the track.

RELATED LINKS

[Inspector Sections](#) on page 119

Instrument Tracks

You can use instrument tracks for dedicated VST instruments. Each instrument track has a corresponding instrument channel in the **MixConsole**. An instrument track can have any number of automation tracks.

You can add instrument tracks via the **Add Track** dialog.

RELATED LINKS

[Add Track Dialog – Instrument](#) on page 132

Add Track Dialog – Instrument

The **Instrument** page of the **Add Track** dialog allows you to set up and add instrument tracks.

To open the **Instrument** page of the **Add Track** dialog, do one of the following:

- Click **Add Track**  in the global track controls area of the track list, and click **Instrument**. This opens the global **Add Track** dialog on the **Instrument** page.

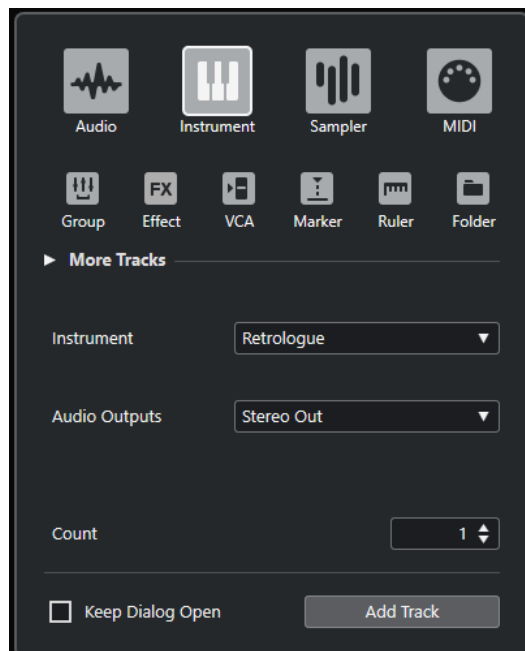

- Select **Project > Add Track > Instrument** or right-click in an empty area of the track list, and select **Add Instrument Track**.

This opens only the **Instrument** page of the **Add Track** dialog.

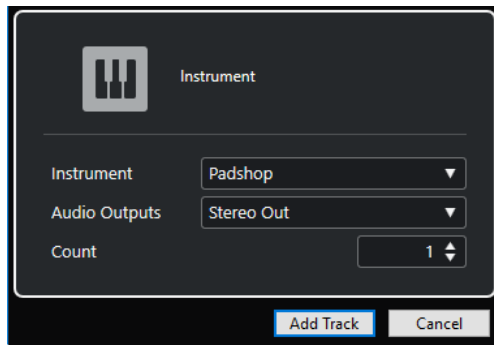

The following settings are available:

Instrument

Allows you to select an instrument.

Audio Outputs

Allows you to set the output routing.

Count

Allows you to enter the number of tracks that you want to add.

NOTE

You can add an unlimited number of tracks. However, you can only add 100 tracks at a time.

Keep Dialog Open

Activate this to keep the dialog open after clicking **Add Track**. This allows you to click the page of another track type to set up and add more tracks.

NOTE

This is only available if you open the **Add Track** dialog from the global track controls.

Add Track

Adds one or more tracks, according to the track type and settings of the active page, and closes the dialog.

Instrument Track Inspector

The **Inspector** for instrument tracks contains controls and parameters that allow you to control your instrument track. It shows some of the sections from VST instrument channels and MIDI tracks.

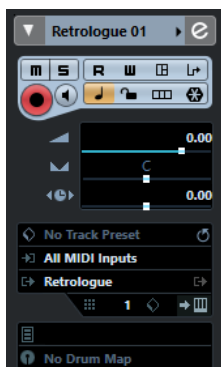

The top section of the instrument track **Inspector** contains the following basic track settings:

Track name

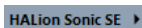

Click once to show/hide the basic track settings section. Double-click to rename the track.

Colorize Selected Track



Allows you to colorize the selected track.

Edit Channel Settings



Opens the **Channel Settings** window for the track.

Mute



Mutes the track.

Solo



Solos the track.

Read Automation



Allows you to read track automation.

Write Automation



Allows you to write track automation.

Open Device Panels



Allows you to open the instrument panel.

Input Transformer



Opens a pop-up menu that allows you to transform incoming MIDI events in real time.

Record Enable



Activates the track for recording.

Monitor



Routes incoming MIDI to the selected MIDI output. For this to work, activate **MIDI Thru Active** in the **Preferences** dialog (**MIDI** page).

Toggle Time Base



Switches between musical (tempo-related) and linear (time-related) time base for the track.

Lock



Disables all editing of all events on the track.

Freeze Instrument Channel



Allows you to freeze the instrument.

Volume



Allows you to adjust the level of the track.

Pan



Allows you to adjust the panning of the track.

Delay



Allows you to adjust the playback timing of the track.

Show Lanes



Divides the tracks in lanes.

Load/Save/Reload Track Preset



Loads or saves a track preset or reverts the default presets.

Input Routing



Allows you to specify the input bus for the track.

Activate Outputs



This control is only available if the instrument provides more than one output. It allows you to activate one or more outputs for the instrument.

Edit Instrument



Allows you to open the instrument panel.

Programs

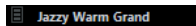

Allows you to select a program.

Drum Maps

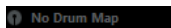

Allows you to select a drum map for the track.

RELATED LINKS

[Inspector Sections](#) on page 119

Sampler Tracks

You can use sampler tracks for controlling the playback of audio samples via MIDI. Each sampler track has a corresponding channel in the **MixConsole**. A sampler track can have any number of automation tracks.

You can add sampler tracks via the **Add Track** dialog.

RELATED LINKS

[Add Track Dialog – Sampler](#) on page 136

[Creating Sampler Tracks](#) on page 654

[Sampler Control](#) on page 654

Add Track Dialog – Sampler

The **Sampler** page of the **Add Track** dialog allows you to set up and add sampler tracks.

To open the **Sampler** page of the **Add Track** dialog, do one of the following:

- Click **Add Track**  in the global track controls area of the track list, and click **Sampler**. This opens the global **Add Track** dialog on the **Sampler** page.

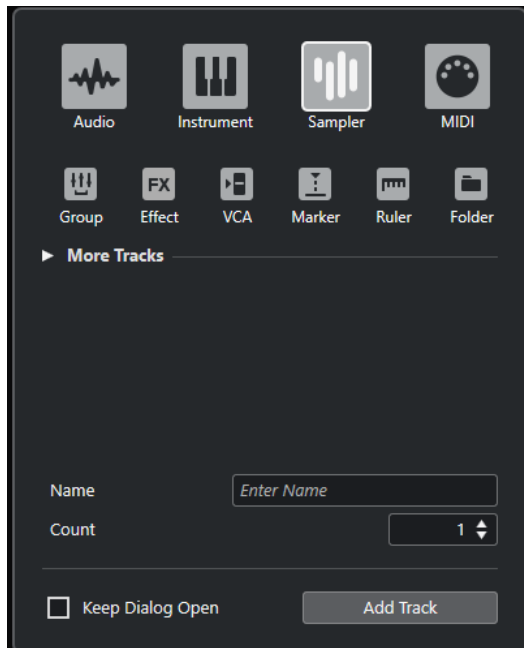

- Select **Project > Add Track > Sampler** or right-click in an empty area of the track list, and select **Add Sampler Track**.

This opens only the **Sampler** page of the **Add Track** dialog.

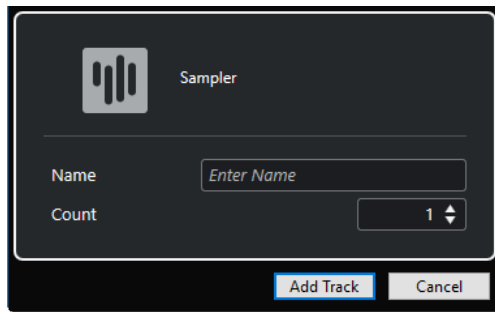

The following settings are available:

Name

Allows you to specify a track name.

Count

Allows you to enter the number of tracks that you want to add.

Keep Dialog Open

Activate this to keep the dialog open after clicking **Add Track**. This allows you to click the page of another track type to set up and add more tracks.

NOTE

This is only available if you open the **Add Track** dialog from the global track controls.

Add Track

Adds one or more tracks, according to the track type and settings of the active page, and closes the dialog.

Sampler Track Inspector

The **Inspector** for sampler tracks contains controls and parameters that allow you to edit your sampler track.

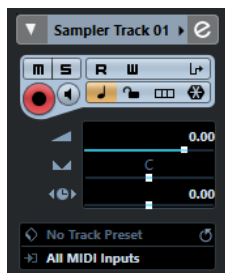

The top section of the sampler track **Inspector** contains the following basic track settings:

Track name

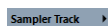

Click once to show/hide the basic track settings section. Double-click to rename the track.

Colorize Selected Track



Allows you to colorize the selected track.

Edit Channel Settings



Opens the **Channel Settings** window for the track.

Mute



Mutes the track.

Solo



Solos the track.

Read Automation



Allows you to read track automation.

Write Automation



Allows you to write track automation.

Input Transformer



Opens a pop-up menu that allows you to transform incoming MIDI events in real time.

Record Enable



Activates the track for recording.

Monitor



Routes incoming MIDI to the selected MIDI output. For this to work, activate **MIDI Thru Active** in the **Preferences** dialog (**MIDI** page).

Toggle Time Base



Switches between musical (tempo-related) and linear (time-related) time base for the track.

Lock



Disables all editing of all events on the track.

Show Lanes



Divides the tracks in lanes.

Freeze Sampler Channel



Allows you to freeze the sampler track.

Volume



Allows you to adjust the level of the track.

Pan



Allows you to adjust the panning of the track.

Delay



Allows you to adjust the playback timing of the track.

Load/Save/Reload Track Preset



Loads or saves a track preset or reverts the default presets.

Input Routing



Allows you to specify the input bus for the track.

RELATED LINKS

[Inspector Sections](#) on page 119

MIDI Tracks

You can use MIDI tracks for recording and playing back MIDI parts. Each MIDI track has a corresponding MIDI channel in the **MixConsole**. A MIDI track can have any number of automation tracks.

You can add MIDI tracks via the **Add Track** dialog.

RELATED LINKS

[Add Track Dialog – MIDI](#) on page 139

Add Track Dialog – MIDI

The **MIDI** page of the **Add Track** dialog allows you to set up and add MIDI tracks.

To open the **MIDI** page of the **Add Track** dialog, do one of the following:

- Click **Add Track**  in the global track controls area of the track list, and click **MIDI**. This opens the global **Add Track** dialog on the **MIDI** page.

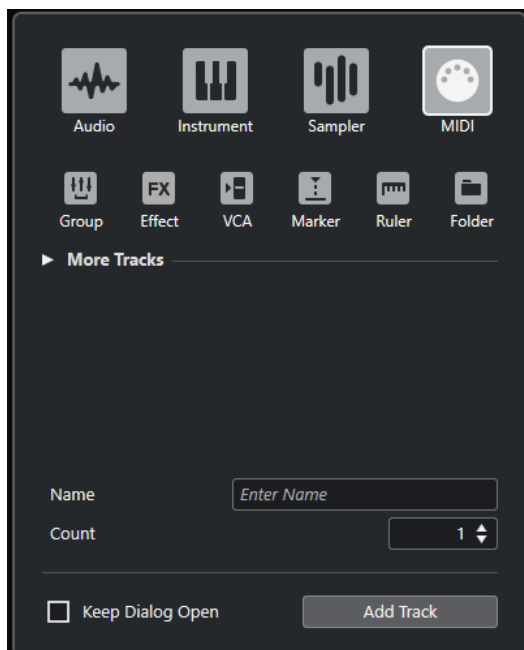

- Select **Project > Add Track > MIDI** or right-click in an empty area of the track list, and select **Add MIDI Track**.

This opens only the **MIDI** page of the **Add Track** dialog.

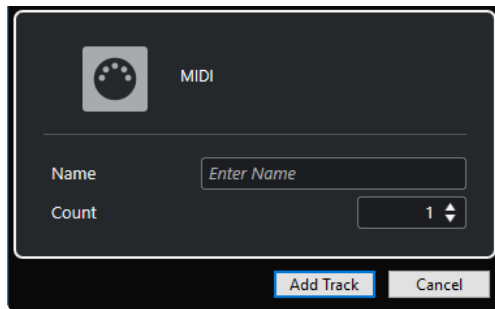

The following settings are available:

Name

Allows you to specify a track name.

Count

Allows you to enter the number of tracks that you want to add.

NOTE

You can add an unlimited number of tracks. However, you can only add 100 tracks at a time.

Keep Dialog Open

Activate this to keep the dialog open after clicking **Add Track**. This allows you to click the page of another track type to set up and add more tracks.

NOTE

This is only available if you open the **Add Track** dialog from the global track controls.

Add Track

Adds one or more tracks, according to the track type and settings of the active page, and closes the dialog.

MIDI Track Inspector

The **Inspector** for MIDI tracks contains controls and parameters that allow you to control your MIDI track. These affect MIDI events in real time, on playback, for example.



The top section of the MIDI track **Inspector** contains the following basic track settings:

Track name

MIDI 01 ▶

Click once to show/hide the basic track settings section. Double-click to rename the track.

Colorize Selected Track



Allows you to colorize the selected track.

Edit Channel Settings



Opens the **Channel Settings** window for the track.

Mute



Mutes the track.

Solo



Solos the track.

Read Automation



Allows you to read track automation.

Write Automation



Allows you to write track automation.

Open Device Panels



Allows you to open the instrument panel.

Input Transformer



Opens a pop-up menu that allows you to transform incoming MIDI events in real time.

Record Enable



Activates the track for recording.

Monitor



Routes incoming MIDI to the selected MIDI output. For this to work, activate **MIDI Thru Active** in the **Preferences** dialog (**MIDI** page).

Toggle Time Base



Switches between musical (tempo-related) and linear (time-related) time base for the track.

Lock



Disables all editing of all events on the track.

Show Lanes



Divides the tracks in lanes.

Volume



Allows you to adjust the level of the track.

MIDI Pan



Allows you to adjust the MIDI panning of the track.

Delay



Allows you to adjust the playback timing of the track.

Load/Save/Reload Track Preset



Loads or saves a track preset or reverts the default presets.

Input Routing



Allows you to specify the input bus for the track.

Output Routing



Allows you to specify the output bus for the track.

Channel



Allows you to specify the MIDI channel.

Edit Instrument



Allows you to open the instrument panel.

Bank Selector



Allows you to set a bank select message that is sent to your MIDI device.

Programs

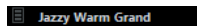

Allows you to select a program.

Program Selector



Allows you to set a program change message that is sent to your MIDI device.

Drum Maps

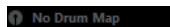

Allows you to select a drum map for the track.

RELATED LINKS

[Inspector Sections](#) on page 119

Group Channel Tracks

You can use group channel tracks to create a submix of several audio channels and apply the same effects to them. A group channel track contains no events as such, but displays settings and automation for the corresponding group channel.

All group channel tracks are automatically placed in a special group track folder in the track list for easy management. Each group channel track has a corresponding channel in the **MixConsole**. A group channel track can have any number of automation tracks.

You can add group channel tracks via the **Add Track** dialog.

RELATED LINKS

[Add Track Dialog – Group Channel](#) on page 143

Add Track Dialog – Group Channel

The **Group** page of the **Add Track** dialog allows you to set up and add group channel tracks.

To open the **Group** page of the **Add Track** dialog, do one of the following:

- Click **Add Track**  in the global track controls area of the track list, and click **Group**.

This opens the global **Add Track** dialog on the **Group** page.

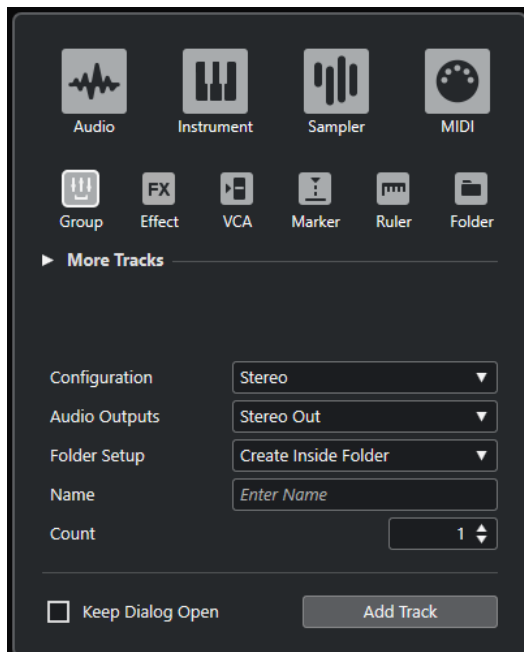

- Select **Project > Add Track > Group**.

This opens only the **Group** page of the **Add Track** dialog.

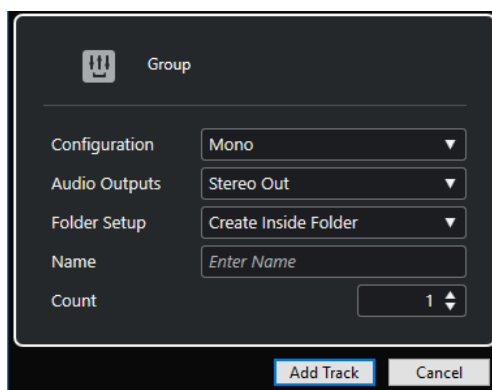

The following settings are available:

Configuration

Allows you to set the channel configuration. Audio-related tracks can be configured as mono, stereo, or surround tracks, with almost any combination of channels.

Audio Outputs

Allows you to set the output routing.

Folder Setup

Allows you to select whether you want to create the effect inside or outside a dedicated folder.

Name

Allows you to specify a track name.

Count

Allows you to enter the number of tracks that you want to add.

Keep Dialog Open

Activate this to keep the dialog open after clicking **Add Track**. This allows you to click the page of another track type to set up and add more tracks.

NOTE

This is only available if you open the **Add Track** dialog from the global track controls.

Add Track

Adds one or more tracks, according to the track type and settings of the active page, and closes the dialog.

Group Channel Track Inspector

The **Inspector** for group channel tracks shows the settings for the group channel.



Track name



Click once to show/hide the basic track settings section. Double-click to rename the track.

Colorize Selected Track



Allows you to colorize the selected track.

Edit Channel Settings



Opens the **Channel Settings** window for the track.

Mute



Mutes the track.

Solo



Solos the track.

Read Automation



Allows you to read track automation.

Write Automation



Allows you to write track automation.

Toggle Time Base



Switches between musical (tempo-related) and linear (time-related) time base for the track.

Lock



Disables all editing of all events on the track.

Volume



Allows you to adjust the level of the track.

Pan



Allows you to adjust the panning of the track.

Output Routing



Allows you to specify the output bus for the track.

NOTE

When you select the group folder track instead, the **Inspector** shows the folder and the group channels it contains. You can click one of the group channels shown in the folder to have the **Inspector** show the settings for that group channel.

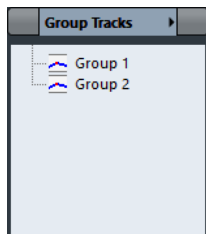

RELATED LINKS

[Inspector Sections](#) on page 119

FX Channel Tracks

You can use FX channel tracks for adding send effects. Each FX channel can contain up to eight effect processors. By routing sends from an audio channel to an FX channel, you send audio from the audio channel to the effects on the FX channel. You can place FX channel tracks in a special FX channel folder, or in the track list, outside an FX channel folder. Each FX channel has a corresponding channel in the **MixConsole**. An FX channel track can have any number of automation tracks.

You can add FX channel tracks via the **Add Track** dialog.

RELATED LINKS

[Add Track Dialog – Effect](#) on page 146

Add Track Dialog – Effect

The **Effect** page of the **Add Track** dialog allows you to set up and add FX channel tracks.

To open the **Effect** page of the **Add Track** dialog, do one of the following:

- Click **Add Track**  in the global track controls area of the track list, and click **Effect**. This opens the global **Add Track** dialog on the **Effect** page.

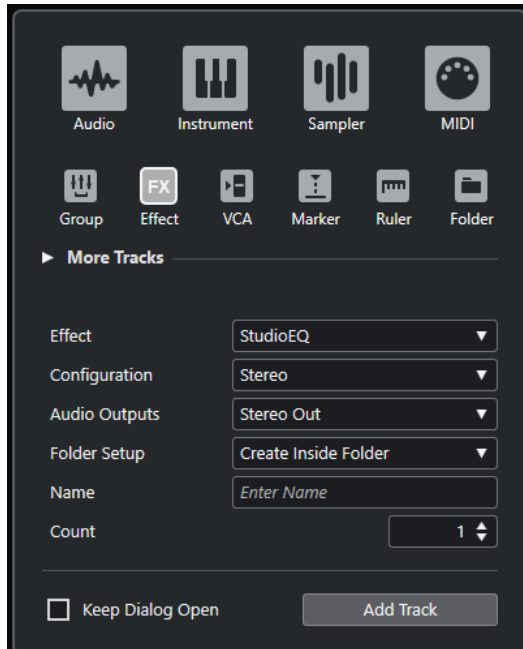

- Select **Project > Add Track > Effect**. This opens only the **Effect** page of the **Add Track** dialog.

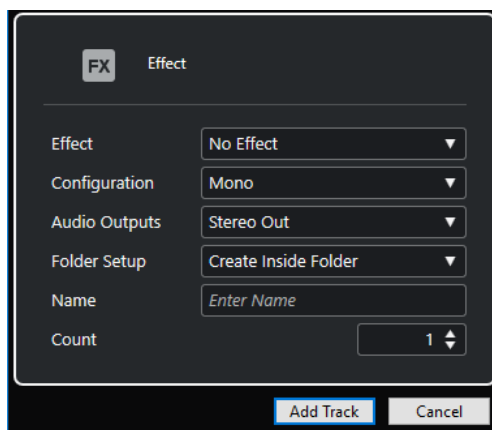

The following settings are available:

Effect

Allows you to select an effect.

Configuration

Allows you to set the channel configuration. Audio-related tracks can be configured as mono, stereo, or surround tracks, with almost any combination of channels.

Audio Outputs

Allows you to set the output routing.

Folder Setup

Allows you to select whether you want to create the effect inside or outside a dedicated folder.

Name

Allows you to specify a track name.

Count

Allows you to enter the number of tracks that you want to add.

Keep Dialog Open

Activate this to keep the dialog open after clicking **Add Track**. This allows you to click the page of another track type to set up and add more tracks.

NOTE

This is only available if you open the **Add Track** dialog from the global track controls.

Add Track

Adds one or more tracks, according to the track type and settings of the active page, and closes the dialog.

RELATED LINKS

[Adding FX Channel Tracks](#) on page 514

[Adding FX Channels to Selected Channels](#) on page 515

FX Channel Track Inspector

The **Inspector** for FX channel tracks shows the settings for the FX channel. When you select the folder track instead, the **Inspector** shows the folder and the FX channels it contains. You can click one of the FX channels shown in the folder to have the **Inspector** show the settings for that FX channel.



Track name

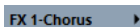

Click once to show/hide the basic track settings section. Double-click to rename the track.

Colorize Selected Track



Allows you to colorize the selected track.

Edit Channel Settings



Opens the **Channel Settings** window for the track.

Mute



Mutes the track.

Solo



Solos the track.

Read Automation



Allows you to read track automation.

Write Automation



Allows you to write track automation.

Toggle Time Base



Switches between musical (tempo-related) and linear (time-related) time base for the track.

Lock



Disables all editing of all events on the track.

Volume



Allows you to adjust the level of the track.

Pan



Allows you to adjust the panning of the track.

Output Routing



Allows you to specify the output bus for the track.

RELATED LINKS

[Inspector Sections](#) on page 119

VCA Fader Track

You can use a VCA fader track to add VCA faders to your project.

You can add VCA fader tracks via the **Add Track** dialog.

RELATED LINKS

[Add Track Dialog – VCA](#) on page 148

[VCA Faders](#) on page 474

[VCA Fader Automation](#) on page 476

[Automation](#) on page 805

Add Track Dialog – VCA

The **VCA** page of the **Add Track** dialog allows you to set up and add VCA fader tracks.

To open the **VCA** page of the **Add Track** dialog, do one of the following:

- Click **Add Track**  in the global track controls area of the track list, and click **VCA**. This opens the global **Add Track** dialog on the **VCA** page.

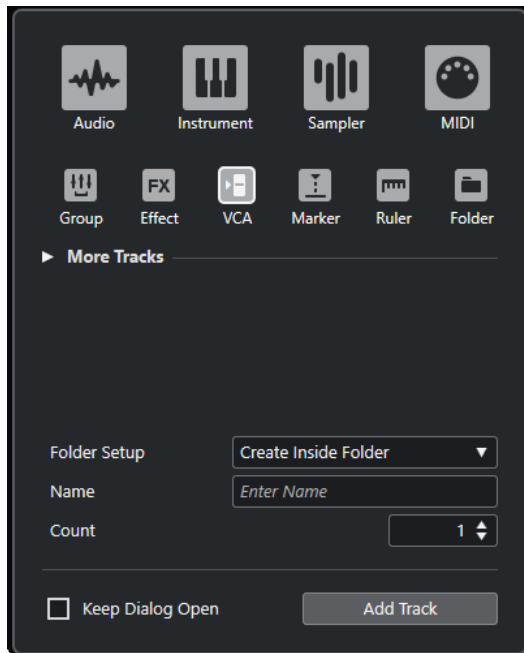

- Select **Project > Add Track > VCA**.
This opens only the **VCA** page of the **Add Track** dialog.

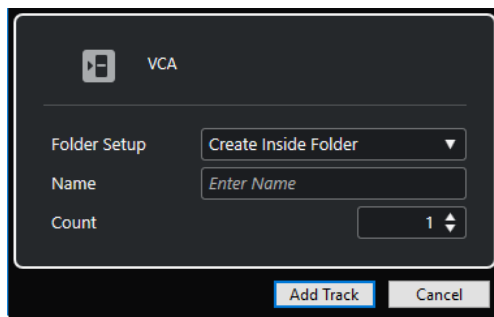

The following settings are available:

Folder Setup

Allows you to select whether you want to create the effect inside or outside a dedicated folder.

Name

Allows you to specify a track name.

Count

Allows you to enter the number of tracks that you want to add.

Keep Dialog Open

Activate this to keep the dialog open after clicking **Add Track**. This allows you to click the page of another track type to set up and add more tracks.

NOTE

This is only available if you open the **Add Track** dialog from the global track controls.

Add Track

Adds one or more tracks, according to the track type and settings of the active page, and closes the dialog.

VCA Fader Track Inspector

The **Inspector** for VCA fader tracks shows the settings for the VCA faders.



Track name



Click once to show/hide the basic track settings section. Double-click to rename the track.

Colorize Selected Track



Allows you to colorize the selected track.

Read Automation



Allows you to read track automation.

Write Automation



Allows you to write track automation.

Toggle Time Base



Switches between musical (tempo-related) and linear (time-related) time base for the track.

Lock



Disables all editing of all events on the track.

Volume



Allows you to adjust the level of the track.

RELATED LINKS

[Inspector Sections](#) on page 119

Marker Track

You can use marker tracks to add and edit markers that help you locate certain positions quickly.

You can add marker tracks via the **Add Track** dialog.

You can add up to 32 marker tracks to a project.

RELATED LINKS

[Add Track Dialog – Marker](#) on page 150

Add Track Dialog – Marker

The **Marker** page of the **Add Track** dialog allows you to set up and add marker tracks.

To open the **Marker** page of the **Add Track** dialog, do one of the following:

- Click **Add Track**  in the global track controls area of the track list, and click **Marker**. This opens the global **Add Track** dialog on the **Marker** page.

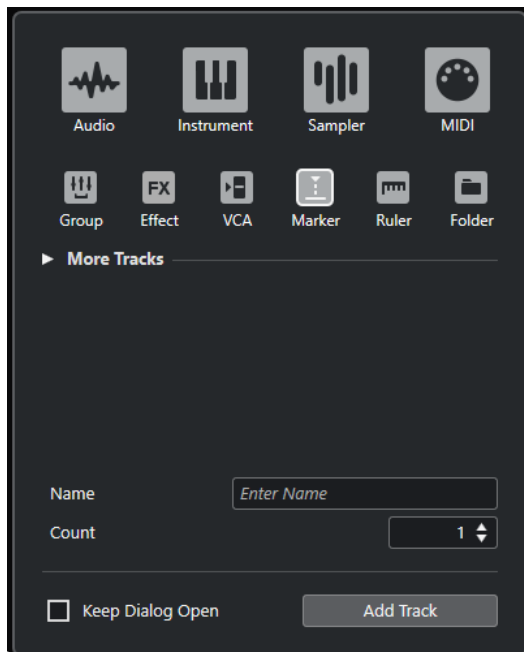

- Select **Project > Add Track > Marker**. This opens only the **Marker** page of the **Add Track** dialog.

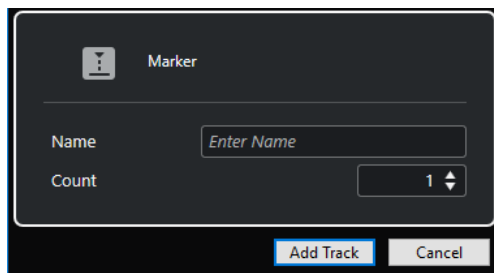

The following settings are available:

Name

Allows you to specify a track name.

Count

Allows you to enter the number of tracks that you want to add.

Keep Dialog Open

Activate this to keep the dialog open after clicking **Add Track**. This allows you to click the page of another track type to set up and add more tracks.

NOTE

This is only available if you open the **Add Track** dialog from the global track controls.

Add Track

Adds one or more tracks, according to the track type and settings of the active page, and closes the dialog.

RELATED LINKS

[Marker Track](#) on page 150

Marker Track Inspector

The marker track **Inspector** displays the marker list.

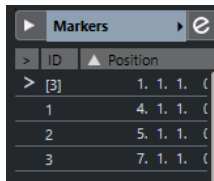

Track name

Markers 01

Double-click to rename the track.

Colorize Selected Track



Allows you to colorize the selected track.

Open Marker Window



Opens the **Markers** window.

Marker attributes

ID Position

Shows the markers, their IDs, and their time positions. Click in the leftmost column for a marker to move the project cursor to the marker position.

RELATED LINKS

[Inspector Sections](#) on page 119

Ruler Track

You can use ruler tracks to show several rulers with different display formats for the timeline. This is completely independent from the main ruler, as well as rulers and position displays in other windows.

You can add ruler tracks via the **Add Track** dialog.

RELATED LINKS

[Add Track Dialog – Ruler](#) on page 152

Add Track Dialog – Ruler

The **Ruler** page of the **Add Track** dialog allows you to set up and add ruler tracks.

To open the **Ruler** page of the **Add Track** dialog, do one of the following:

- Click **Add Track**  in the global track controls area of the track list, and click **Ruler**. This opens the global **Add Track** dialog on the **Ruler** page.

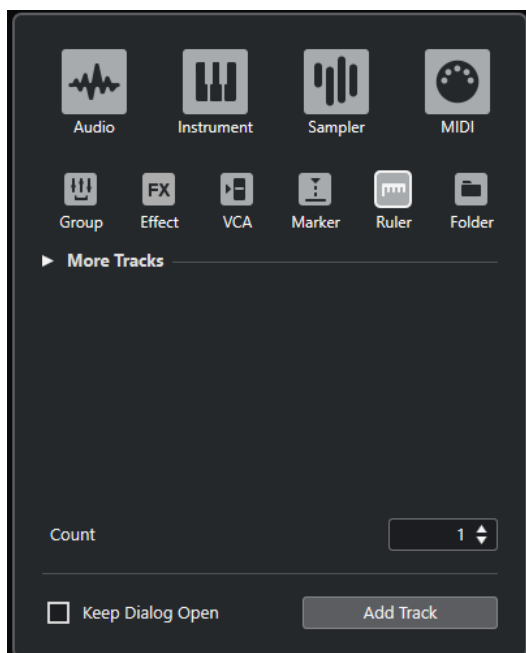

- Select **Project > Add Track > Ruler**.
This opens only the **Ruler** page of the **Add Track** dialog.

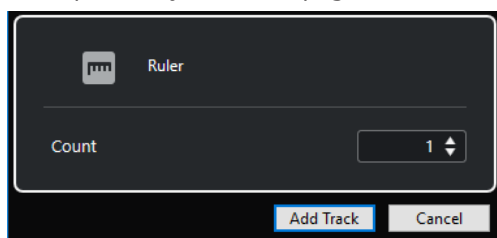

The following settings are available:

Count

Allows you to enter the number of tracks that you want to add.

Keep Dialog Open

Activate this to keep the dialog open after clicking **Add Track**. This allows you to click the page of another track type to set up and add more tracks.

NOTE

This is only available if you open the **Add Track** dialog from the global track controls.

Add Track

Adds one or more tracks, according to the track type and settings of the active page, and closes the dialog.

Ruler Track Controls

In the track list for ruler tracks, you can change the display format for the ruler.

Click the display format to open a pop-up menu.

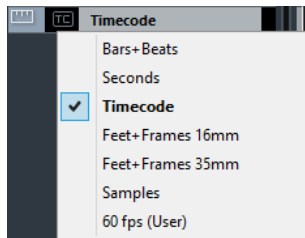

The following display formats are available:

Bars+Beats

Activates a display format of bars, beats, sixteenth notes, and ticks. By default there are 120 ticks per sixteenth note. To adjust this, change the **MIDI Display Resolution** in the **Preferences** dialog (**MIDI** page).

Seconds

Activates a display format of hours, minutes, seconds, and milliseconds.

Timecode

Activates a display format of hours, minutes, seconds, and frames. The number of frames per second (fps) is set in the **Project Setup** dialog with the **Project Frame Rate** pop-up menu. To display subframes, activate **Show Timecode Subframes** in the **Preferences** dialog (**Transport** page).

Feet+Frames 16 mm

Sets the ruler to display feet and frames, with 40 frames per foot. To let the beginning of a project always start at 0'00, regardless of any **Start** offset settings in the **Project Setup** dialog, activate **Feet'n'Frames Count from Project Start** in the **Preferences** dialog (**Transport** page).

Feet+Frames 35 mm

Sets the ruler to display feet, frames, and 1/4 frames, with 16 frames per foot. To let the beginning of a project always start at 0'00, regardless of any **Start** offset settings in the **Project Setup** dialog, activate **Feet'n'Frames Count from Project Start** in the **Preferences** dialog (**Transport** page).

Samples

Activates a display format of samples.

fps (User)

Activates a display format of hours, minutes, seconds, and frames, with a user-definable number of frames per second. To display subframes, activate **Show Timecode Subframes** in the **Preferences** dialog (**Transport** page). On the **Transport** page, you can also set the frame rate.

NOTE

Ruler tracks are not affected by the display format setting in the **Project Setup** dialog.

Folder Tracks

Folder tracks function as containers for other tracks, making it easier to organize and manage the track structure. They also allow you to edit several tracks at the same time.

You can add folder tracks via the **Add Track** dialog.

RELATED LINKS

[Add Track Dialog – Folder](#) on page 155

Add Track Dialog – Folder

The **Folder** page of the **Add Track** dialog allows you to set up and add folder tracks.

To open the **Folder** page of the **Add Track** dialog, do one of the following:

- Click **Add Track**  in the global track controls area of the track list, and click **Folder**. This opens the global **Add Track** dialog on the **Folder** page.

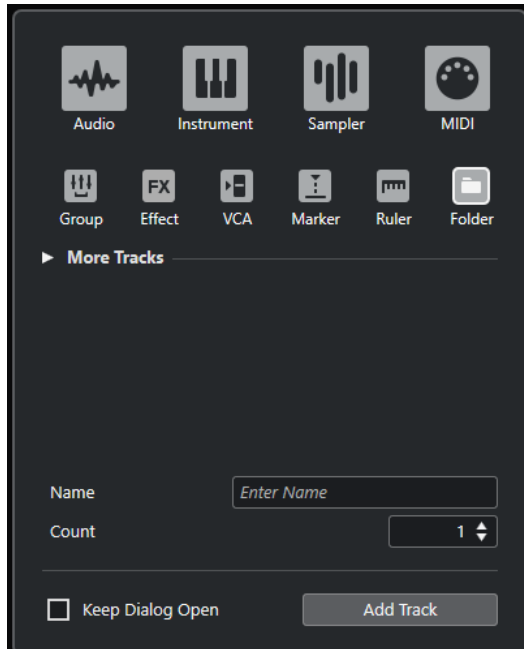

- Select **Project > Add Track > Folder**. This opens only the **Folder** page of the **Add Track** dialog.

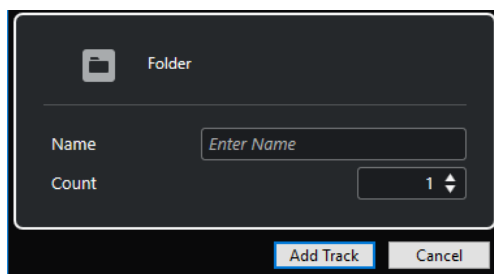

The following settings are available:

Name

Allows you to specify a track name.

Count

Allows you to enter the number of tracks that you want to add.

Keep Dialog Open

Activate this to keep the dialog open after clicking **Add Track**. This allows you to click the page of another track type to set up and add more tracks.

NOTE

This is only available if you open the **Add Track** dialog from the global track controls.

Add Track

Adds one or more tracks, according to the track type and settings of the active page, and closes the dialog.

Folder Track Inspector

The **Inspector** for folder tracks shows the folder and its underlying track, much like a folder structure in the File Explorer/macOS Finder. When you select one of the tracks shown under the folder, the **Inspector** shows the settings for that track.

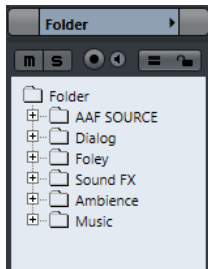

Track name



Double-click to rename the track.

Colorize Selected Track



Allows you to colorize the selected track.

Mute



Mutes the track.

Solo



Solos the track.

Record Enable



Activates the track for recording.

Monitor



For audio-related tracks, this routes incoming signals to the selected output.

For MIDI and instrument-related tracks, this allows you to route incoming MIDI signals to the selected MIDI output. For this to work, activate **MIDI Thru Active** in the **Preferences** dialog (**MIDI** page).

Group Editing



Allows you to activate the group editing mode.

Lock



Disables all editing of all events on the track.

RELATED LINKS

[Inspector Sections](#) on page 119

Folder Track Controls

The track list for folder tracks contains controls and parameters that allow you to edit all tracks in the folder.



Expand/Collapse Folder

Shows/Hides the tracks in the folder. Hidden tracks are played back as usual.

Track name



Double-click to rename the track.

Mute



Mutes the track.

Solo



Solos the track.

Record Enable



Activates the track for recording.

Monitor



For audio-related tracks, this routes incoming signals to the selected output.

For MIDI and instrument-related tracks, this allows you to route incoming MIDI signals to the selected MIDI output. For this to work, activate **MIDI Thru Active** in the **Preferences** dialog (**MIDI** page).

Group Editing



Allows you to activate the group editing mode.

Lock



Disables all editing of all events on the track.

More Tracks

Some track types can only be added once.

- Tempo track
- Signature track
- Arranger track
- Transpose track
- Chord track
- Video track

NOTE

You can add 2 video tracks.

- Loudness track

Arranger Track

You can use the arranger track for arranging your project by marking out sections and determining in which order they are to be played back.

- To add the arranger track to your project, select **Project > Add Track > Arranger**.

Arranger Track Inspector

The arranger track **Inspector** displays the lists of available arranger chains and arranger events.

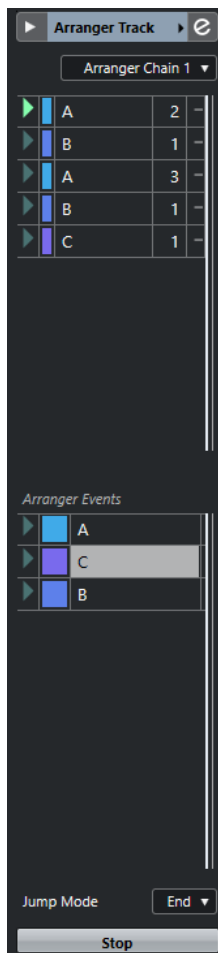

The arranger track **Inspector** contains the following settings:

Track name

Arranger Track

Double-click to rename the track.

Colorize Selected Track

Allows you to colorize the selected track.

Open Arranger Editor

Opens the **Arranger Editor**.

Select Active Arranger Chain + Functions

Arranger Chain 1

Allows you to select the active arranger chain, to rename it, to create a new one, to duplicate, or to flatten it.

Current Arranger Chain

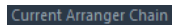

Shows the active arranger chain.

Arranger Events

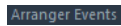

Lists all arranger events in your project. Click the arrow of an arranger event to play it back and start the live mode.

Stop



Allows you to stop the live mode.

Jump Mode

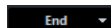

Allows you to define how long the active arranger event is played before jumping to the next one.

Arranger Track Controls

The track list for the arranger track contains controls and parameters that allow you to edit the arranger track.

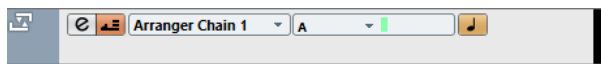

Select Active Arranger Chain

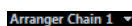

Allows you to select the active arranger chain.

Current Item/Current Repeat



Displays which arranger event and which repeat is active.

Activate Arranger Mode



Allows you to activate and deactivate the arranger mode.

Toggle Time Base



Switches between musical (tempo-related) and linear (time-related) time base for the track.

Open Arranger Editor



Opens the **Arranger Editor** for the track.

Chord Track

You can use the chord track for adding chord and scale events to your project. These can transform the pitches of other events.

- To add the chord track to your project, select **Project > Add Track > Chord**.

Chord Track Inspector

The chord track **Inspector** contains settings for the chord events.

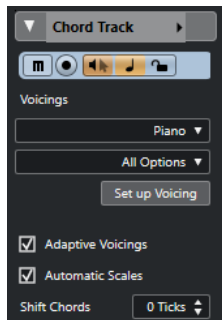

The top section of the chord track **Inspector** contains the following settings:

Track name

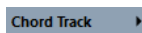

Click to show/hide the basic track settings section.

Colorize Selected Track



Allows you to colorize the selected track.

Mute Chord Track



Mutes the track.

Record Enable



Activates the track for recording.

Acoustic Feedback



Allows you to audition the events on the chord track. For this to work, you need to select a track for auditioning in the track list.

Toggle Time Base



Switches between musical (tempo-related) and linear (time-related) time base for the track.

Lock



Disables all editing of all events on the track.

Voicing library



Allows you to set up a voicing library for the track.

Voicing library subset

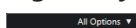

Allows you to select a library subset.

Set up Voicing



Allows you to configure your own voicing parameters for a specific voicing scheme.

Adaptive Voicings



If this option is activated, the voicings are set automatically.

Automatic Scales



If this option is activated, the program creates scale events automatically.

Shift Chords



Allows you to specify an offset value to make sure that chord events also affect the MIDI notes that have been triggered too early (enter a negative value) or too late (enter a positive value).

RELATED LINKS

[Inspector Sections](#) on page 119

Chord Track Controls

The track list for the chord track contains controls and parameters that allow you to edit the chord track.

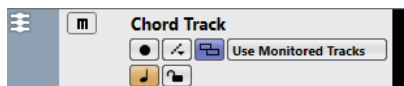

The track list for the chord track contains the following controls:

Name



Shows the name of the track. Double-click to rename the track.

Record Enable



Activates the track for recording.

Mute Chord Track



Mutes the track.

Select Track for Auditioning

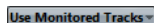

Allows you to select a track for auditioning the chord events.

Resolve Display Conflicts



Allows you to show all chord events on the track properly, even at low horizontal zoom levels.

Show Scales



Allows you to show the scale lane in the lower part of the chord track.

Lock



Disables all editing of all events on the track.

Toggle Time Base



Switches between musical (tempo-related) and linear (time-related) time base for the track.

Signature Track

You can use the signature track to add and edit signature events, and to set up click patterns for them. The signature track's background always shows bars. This is independent of the ruler display format setting.

- To add the signature track to your project, select **Project > Add Track > Signature**.

RELATED LINKS

[Time Signature Events](#) on page 1149

[Click Patterns Tab](#) on page 284

Signature Track Inspector

The signature track **Inspector** displays a list of all time signature events.

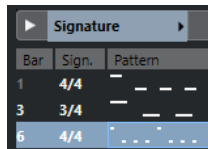

Bar	Sign.	Pattern
1	4/4	— — — —
3	3/4	— — —
6	4/4	— — — —

Colorize Selected Track



Allows you to colorize the selected track.

Bar

Shows the number of the bar where the signature event is positioned. Double-click the field and enter a new value to change the position of the signature event.

NOTE

The first signature event is always positioned at bar 1. You cannot change this.

Sign.

Shows the value of the signature event. Double-click the field and enter a new value to change the time signature.

Pattern

Shows the click pattern that is used. Double-click the field to open the **Click Pattern Editor** where you can change the pattern.

RELATED LINKS

[Click Pattern Editor](#) on page 278

Signature Track Controls

The track list for the signature track contains controls and parameters that allow you to edit the signature track.



Lock



Disables all editing of all events on the track.

Signature Track Options

- **Copy Click Pattern to Clipboard**
Copies the click pattern of the selected signature event to the clipboard.
- **Paste Click Pattern to Selected Signatures**
Pastes the click pattern from the clipboard to selected signature events.

NOTE

This only works if the selected signature events are equal.

- **Apply Click Pattern to Equal Signatures**
Pastes the click pattern from the clipboard to signature events that are equal.

NOTE

For this you do not have to select the signature events first.

- **Reset Click Pattern to Default**
Sets the click pattern of the selected signature event to default. If no signature event is selected, the click patterns of all signature events are set to default.
- **Show Click Patterns**
Allows you to show/hide the click patterns for the signature events.
- **Render MIDI Click between Locators**
Adds a MIDI track to your project and creates a MIDI part containing the click pattern between the left and right locator.
- **Render Audio Click between Locators**
Adds an audio track to your project and creates an audio event containing the click pattern between the left and right locator.
- **Process Bars Dialog**
Opens the **Process Bars** dialog.

RELATED LINKS

[Click Patterns Tab](#) on page 284

[Process Bars Dialog](#) on page 1147

Tempo Track

You can use the tempo track to create tempo changes within a project.

- To add a tempo track to your project, select **Project > Add Track > Tempo**.

Tempo Track Inspector

The tempo track **Inspector** displays a list of all tempo events.



Position	Tempo	Ty
1. 1. 1. 0	105.000	Ju
3. 1. 1.102	100.000	Ju
3. 3. 3. 66	65.000	Ju
7. 2. 1. 85	150.000	Ra

Colorize Selected Track



Allows you to colorize the selected track.

Open Tempo Track Editor



Opens the **Tempo Track Editor**.

Tempo event list



Shows a list of all tempo events that allows you to edit tempo events and their positions.

Tempo Track Controls

The track list for the tempo track contains controls and parameters that allow you to edit the tempo track.

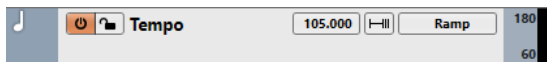

Activate Tempo Track



Allows you to activate the tempo track. In this mode, the tempo cannot be changed on the **Transport** panel.

Lock



Disables all editing of all events on the track.

Current Tempo



Allows you to change the tempo at the project cursor position.

Open Process Tempo Dialog



Allows you to open the **Process Tempo** dialog.

New Tempo Points Type



Allows you to specify whether the tempo should change gradually (**Ramp**) or instantly (**Step**) from the previous curve point to the new one.

Visible Tempo Upper Limit/Visible Tempo Lower Limit



Allows you to specify the display range. This changes the display scale of the tempo track, but not the tempo setting.

Transpose Track

You can use the transpose track to set global key changes.

- To add the transpose track to your project, select **Project > Add Track > Transpose**.

Transpose Track Inspector

The transpose track **Inspector** contains parameters to control the transpose track.

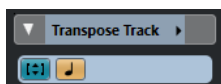

Colorize Selected Track



Allows you to colorize the selected track.

Keep Transpose in Octave Range



Allows you to keep the transposition in the octave range and ensures that nothing is transposed by more than seven semitones.

Toggle Time Base



Switches between musical (tempo-related) and linear (time-related) time base for the track.

Transpose Track Controls

The track list for the transpose track contains parameters that allow you to control the transpose track.

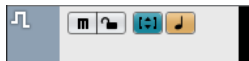

Mute Transpose Events



Mutes the track.

Keep Transpose in Octave Range



Allows you to keep the transposition in the octave range and ensures that nothing is transposed by more than seven semitones.

Toggle Time Base



Switches between musical (tempo-related) and linear (time-related) time base for the track.

Lock



Disables all editing of all events on the track.

Video Track

You can use video tracks to play back video events. Video files are displayed as events/clips on the video track, with thumbnails representing the frames in the film.

You can add up to 2 video tracks to a project.

- To add a video track, select **Project > Add Track > Video**.

Video Track Inspector

The video track **Inspector** contains parameters to control the video track.



Colorize Selected Track



Allows you to colorize the selected track.

Reveal Video Window



Opens the **Video Player** window.

Mute Video Track



Mutes the track.

Lock



Disables all editing of all events on the track.

Show Frame Numbers



Allows you to show each thumbnail with the corresponding video frame number.

Show Thumbnails



Allows you to activate/deactivate the thumbnails of the video track.

RELATED LINKS

[Inspector Sections](#) on page 119

Video Track Controls

The track list for the video track contains parameters to control the video track.



Mute Video Track



Mutes the track.

Name



Shows the name of the track. Double-click to rename the track.

Lock



Disables all editing of all events on the track.

Show Thumbnails



Allows you to activate/deactivate the thumbnails of a video track.

Show Frame Numbers



Allows you to show each thumbnail with the corresponding video frame number.

Loudness Track

You can use the loudness track to record and display the loudness of your whole project or of specific sections.

- To add the loudness track to your project, select **Project > Add Track > Loudness**.

Loudness Track Inspector

The loudness track **Inspector** shows the most important loudness meter displays.

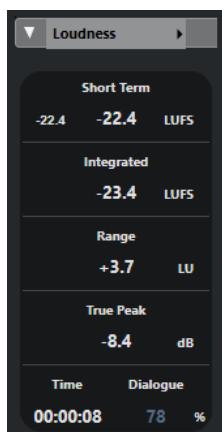

The loudness track **Inspector** shows the following values:

Colorize Selected Track



Allows you to colorize the selected track.

Short-Term

Shows the maximum value of all short-term loudness values, based on a time window of 3 s. The measurement is not gated.

Integrated

Shows the average loudness measured from start to stop. The period of measurement is shown in the **Time** display. The recommended value for the integrated loudness is -23 LUFS. This absolute value is the reference point for the relative LU scale where -23 LUFS equals 0 LU.

Range

Shows the dynamic range of the audio measured from start to stop. This value helps you to decide how much dynamic compression you can apply. The recommended range for highly dynamic audio, such as film music, is 20 LU.

True Peak

Shows the true peak level of the audio. The maximum permitted true peak level in production is -1 dB.

Dialogue

Shows the percentage of speech that is detected in the audio.

NOTE

This value is only available if dialogue-gated loudness measurement is activated.

You can switch the gating mode in the **Loudness** tab at the bottom of the meter display in the right zone of the **Project** window or the **MixConsole**, or in the **Control Room**.

RELATED LINKS

[Loudness Meter](#) on page 495

Loudness Track Controls

The track list for the loudness track contains parameters to control the loudness track.

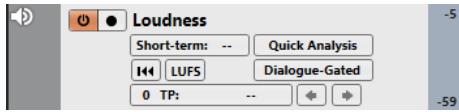

The track list for the loudness track contains the following settings:

Activate Loudness Calculation



Activates the loudness calculation.

Enable Recording of Loudness Curve



Enables the creation of a loudness curve in real time at the cursor position during playback.

Short Term

Short-term: -29.0

Shows the loudness measured over a duration of 3 s.

LUFS/LU

LUFS

Allows you to switch the loudness unit from LUFS (Loudness Unit, absolute values) to LU (relative values).

Clear Loudness Curve



Allows you to clear the loudness curve on the loudness track.

Quick Analysis

Quick Analysis

Enables the creation of a loudness curve for a defined section in off-line processing.

Program-Gated/Dialogue-Gated

Indicates if the loudness measurement is program-gated or dialogue-gated.

NOTE

You can switch the gating mode in the **Loudness** tab at the bottom of the meter display in the right zone of the **Project** window or the **MixConsole**, or in the **Control Room**.

Count of true peak values exceeding reference level

56 TP:

Shows the count of true peak values that are exceeding the reference level.

True peak level at cursor

-0.5 (3ms)

Shows the true peak level at the cursor position.

Jump to previous/next true peak value exceeding reference level



Moves the cursor to the previous/next true peak position that exceeds the reference level.

Visible Loudness - Upper limit/Lower limit

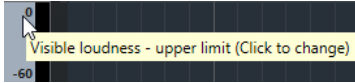

Allows you to specify the display range. Note that this does not change the measured loudness, but changes the display scale of the loudness track.

RELATED LINKS

[Loudness Meter](#) on page 495

Track Handling

Tracks are the building blocks of your project. In Nuendo, events and parts are placed on tracks.

Adding Tracks via the Add Track Dialog

You can add tracks via the **Add Track** dialog.

PROCEDURE

1. In the global track controls area of the track list, click **Add Track** .
2. Do one of the following:
 - Click the track type and set up the options according to your needs.
 - To add track types that can only be added once, open the **More Tracks** section and click the track type.
3. Click **Add Track**.

RESULT

The new track is added to the project below the selected track.

RELATED LINKS

- [Add Track Dialog – Audio](#) on page 128
- [Add Track Dialog – Instrument](#) on page 132
- [Add Track Dialog – Sampler](#) on page 136
- [Add Track Dialog – MIDI](#) on page 139
- [Add Track Dialog – Effect](#) on page 146
- [Add Track Dialog – Group Channel](#) on page 143
- [Add Track Dialog – VCA](#) on page 148
- [Add Track Dialog – Marker](#) on page 150
- [Add Track Dialog – Ruler](#) on page 152
- [Add Track Dialog – Folder](#) on page 155
- [Arranger Track](#) on page 158
- [Chord Track](#) on page 159
- [Signature Track](#) on page 162
- [Tempo Track](#) on page 163
- [Transpose Track](#) on page 164
- [Video Track](#) on page 165
- [Loudness Track](#) on page 166

Adding Tracks Using Track Presets

You can add tracks based on track presets. Track presets contain sound and channel settings.

PROCEDURE

1. In the global track controls area of the track list, click **Use Track Preset** .
2. Select **Using Track Preset**.
3. In the **Choose Track Preset** dialog, select a track preset.

The number and type of the added tracks depend on the selected track preset.

4. Click **OK**.
-

RESULT

The new tracks are added to the project below the selected track.

RELATED LINKS

[Track Presets](#) on page 201

Adding Tracks by Dragging Files from the MediaBay

You can add tracks by dragging files from the **MediaBay**.

PREREQUISITE

One of the following prerequisites must apply:

- The **MediaBay** is open. To open the **MediaBay**, press **F5**.
 - The **Media** rack in the right zone of the **Project** window is open. Click **Show/Hide Right Zone** and click the **Media** tab to open it.
-

PROCEDURE

1. In the **MediaBay**, select the files for which you want to add tracks.
 2. Drag the files into the track list.
 - The indicator highlights the position at which the new tracks will be added.
 - If you drag multiple audio files into the track list, choose if you want to place all files on one track or on different tracks.
 - If you drag multiple audio files into the track list, the **Import Options** dialog opens that allows you to edit the import options.
-

RESULT

The new tracks are added at the position that was highlighted by the indicator in the track list. The audio files are inserted at the cursor position.

RELATED LINKS

[MediaBay and Media Rack](#) on page 697

[Media Rack in Right Zone](#) on page 697

[Import Options Dialog for Audio Files](#) on page 312

Track Import

You can import tracks from other Nuendo or Cubase projects or track archives. This allows you, for example, to import premixed tracks or stems to your active project, or to reuse the mix settings of a previous project for a new song.

You can decide for each individual track whether to create a new track in your active project or to replace data on an existing track. If you use identical track names in both the imported and the active project, you can automatically select matching tracks as the import destination. You can choose to import the track events only, the track settings only, include or exclude automation data, or import all track data.

NOTE

The track settings for read/write automation status, record enable, monitor, muting/soloing, and visibility are not imported.

When importing multiple tracks that are related to each other via sends, output routing, quick link, or VCA fader within the source project, these relations are retained in your active project.

NOTE

If your active project contains routing targets with identical names as in the source project, imported tracks are connected accordingly.

Depending on the track type, the following import rules apply:

Audio, instrument, MIDI, sampler, VCA, group, effect, and folder tracks

- If **New Track** is selected as destination, a new track is created in the active project. This track contains all imported track data, including track versions.
- If an existing track is selected as destination, the imported track data is applied to this track.

If events or parts are imported to an existing track, existing track versions in the active project are kept, track versions from the source project are added, and a new track version is created.

If a folder track is imported to an existing track, the content of this track is entirely replaced by the tracks of the imported folder track.

Marker tracks

- If **New Track** is selected as destination, a new marker track is created. If your project already contains 32 marker tracks, you cannot import marker tracks from another project. In this case, you must remove an existing marker track first.
- If an existing marker track is selected as destination, the imported track data replaces the existing track data.

Chord tracks

- If **New Track** is selected as destination, a chord track is created. If your project already contains a chord track, it is replaced by the imported chord track.
- If an existing chord track is selected as destination, the imported track data replaces the existing track data.

Video tracks

- If **New Track** is selected as destination, a new video track is created. If your project already contains 2 video tracks, you cannot import a video track from another project. In this case, you must remove an existing video track first.
- If an existing video track is selected as destination, the imported track data replaces the existing track data.

RELATED LINKS

[Import Options Dialog for Tracks](#) on page 173

Importing Tracks from Projects

You can import tracks from other Nuendo or Cubase projects.

PROCEDURE

1. Select **File > Import > Tracks from Project**.

2. In the File Explorer/macOS Finder, select the project file that contains the tracks that you want to import, and click **Open**.
 3. In the **Import Options** dialog, select the tracks that you want to import and make any further settings.
 4. Click **OK**.
-

RESULT

The tracks are imported into your active project.

RELATED LINKS

[Import Options Dialog for Tracks](#) on page 173
[Track Versions](#) on page 194

Importing Tracks from Track Archives

You can import tracks from track archives.

PREREQUISITE

You have created at least one track archive by exporting selected tracks from a project.

PROCEDURE

1. Select **File > Import > Track Archive**.
 2. In the File Explorer/macOS Finder, select the .xml file of the track archive, and click **Open**.
 3. In the **Import Options** dialog, select the tracks that you want to import and make any further settings.
 4. Click **OK**.
-

RESULT

The tracks are imported into the active project.

RELATED LINKS

[Import Options Dialog for Tracks](#) on page 173
[Track Versions](#) on page 194

Import Options Dialog for Tracks

The **Import Options** dialog allows you to activate tracks for import, to specify the destination in the active project and the track data that is to be imported, and to set up further import options.

- To open the **Import Options** dialog, select **File > Import > Track Archive** or **File > Import > Tracks from Project**, and open the project file from which you want to import tracks.

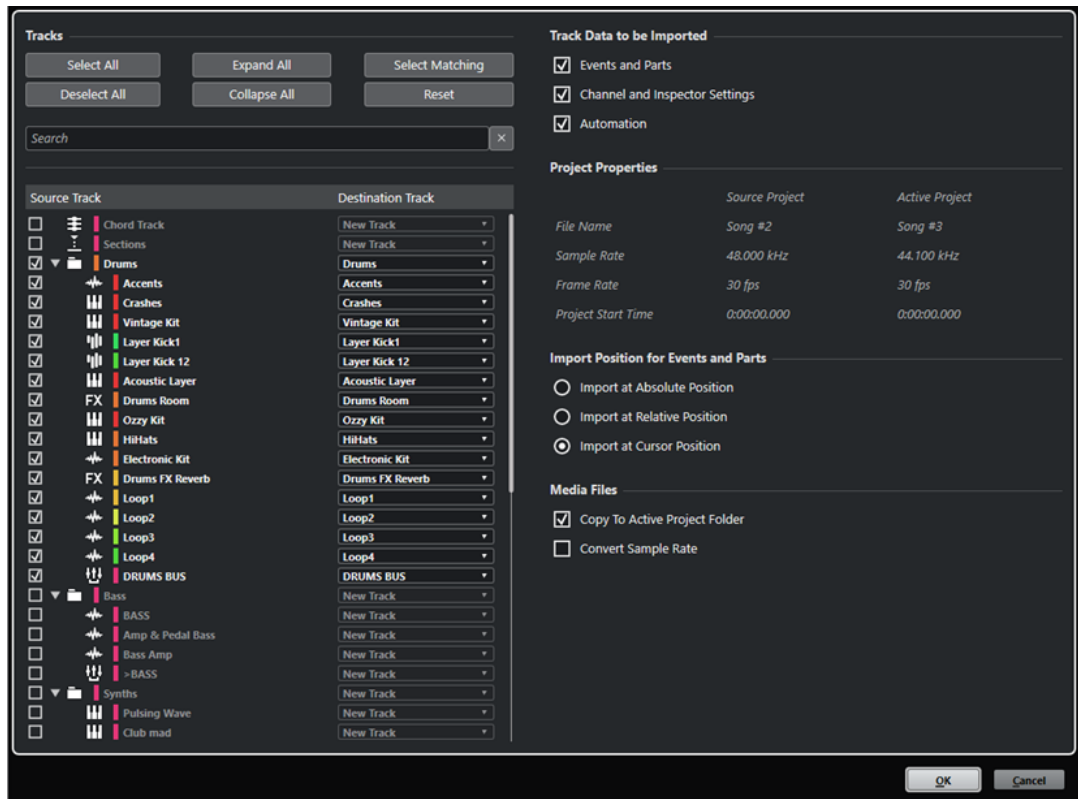

Tracks

Select All

Selects all tracks.

Deselect All

Deselects all tracks.

Expand All

Expands the track list.

Collapse All

Collapses the track list.

Select Matching

Sets tracks with identical names as the corresponding destination for all selected tracks in the track list.

Reset

Sets **New Track** as destination for all selected tracks in the track list.

Search field

Allows you to filter the track list. **Clear Search** resets the filter.

Track list

Shows the tracks that are selected in the project. The **Source Track** column allows you to select the tracks that you want to import into your project. The **Destination Track** column allows you to choose a destination for the corresponding track.

Track Data to be Imported

Events and Parts

Imports only events and parts.

NOTE

- If the imported track contains track versions, these are also imported.
 - If events or parts are imported to an existing track, a new track version is created.
-

Channel and Inspector Settings

Imports all track settings, for example, volume, panning, EQ, channel strip and **Inspector** settings, output routing, sends, cues, VCA connections, and plug-ins.

NOTE

The track settings for read/write automation status, record enable, monitor, muting/soloing, and visibility are not imported from other projects.

Automation

Imports all automation data that is related to the imported track data.

NOTE

If this option is deactivated when importing events or settings to an existing track, its automation data is reset.

Project Settings

Source Project/Active Project

Shows the file name, the sample rate, the frame rate, and the project start time for both the imported tracks and your active project.

NOTE

Imported tracks may contain media files with a sample rate that differs from the sample rate of your destination project. Files with a sample rate different from the one of the destination project play back at the wrong speed and pitch.

Import Position for Events and Parts

Import at Absolute Position

Places imported track data at its original timecode position in your active project.

Import at Relative Position

Places imported track data relative to the start time of your active project, taking the source project start time into account. For example, if the source project starts at timecode 01:00:00:00 with an event located at 02:00:00:00, and if the active project starts at 02:00:00:00, the imported event is placed at timecode 03:00:00:00.

Import at Cursor Position

Places imported track data relative to the cursor position in your active project, taking the source project start time into account. For example, if the source project starts at timecode 01:00:00:00 with an event located at 02:00:00:00, and if the cursor in your active project is located at 02:00:00:00, the imported event is placed at timecode 03:00:00:00.

NOTE

- If the start time of your active project is later than the position of imported track data in the source project, the imported data is not visible in the active project after import. In this case, adjust the start time of the active project accordingly.

- If the end time your active project is earlier than the end time of the imported track data, the end time of your project is modified accordingly.
-

Media Files

Copy to Active Project Folder

Copies the media files of the imported tracks to your active project folder. If this option is deactivated, the media file path of the original project is referenced.

Convert Sample Rate

Converts the sample rate of the imported tracks to the sample rate of your active project.

NOTE

This option is only available if the sample rates of the imported tracks and your active project differ and **Copy to Active Project Folder** is activated.

RELATED LINKS

[Track Versions](#) on page 194

Track Export

You can export selected tracks as track archives. This is useful if you want to use specific tracks in other projects, for example.

Track archives contain information that is associated with the tracks such as channel settings, parts and events, and automation.

NOTE

Project-specific settings, such as the tempo, are not exported to track archives.

Track archives are saved as `.xml` files.

When exporting audio and video tracks, you can either reference the media files or copy them to a separate folder.

RELATED LINKS

[Track Presets](#) on page 201

[Exporting Audio or Video Tracks as Track Archives](#) on page 177

Exporting Tracks as Track Archives

You can export selected tracks as track archives.

PROCEDURE

1. Select the tracks you want to export.
 2. Select **File > Export > Selected Tracks**.
 3. In the file dialog that opens, select or create a folder for saving the track archive as a single `.xml` file.
 4. Enter a file name and click **Save**.
-

RELATED LINKS

[Exporting Audio or Video Tracks as Track Archives](#) on page 177

Exporting Audio or Video Tracks as Track Archives

You can export audio or video tracks as track archives.

PROCEDURE

1. Select the audio or video tracks and any other tracks that you want to export.
 2. Select **File > Export > Selected Tracks**.
 3. In the file dialog that opens, choose between the following options:
 - Click **Copy** to include copies of the media files in the export.
In the file dialog that opens, select an empty folder or create a new folder for saving the track archive as an `.xml` file and its media subfolder.
Click **OK** to save the track archive.
 - Click **Reference** to include a reference to the files in the export.
In the file dialog that opens, select or create a folder for saving the track archive as a single `.xml` file.
 4. Enter a name for the track archive and click **Save**.
-

Exporting MIDI Tracks as Standard MIDI Files

You can export MIDI tracks as standard MIDI files. This allows you to transfer MIDI material to virtually any MIDI application on any platform.

PROCEDURE

1. Select **File > Export > MIDI File**.
 2. In the file dialog that opens, specify a location and name for the file.
 3. Click **Save**.
 4. In the **Export Options** dialog, activate the options for the settings that you want to export, and click **OK**.
-

RESULT

The MIDI file is exported. It includes the tempo and time signature events of the **Tempo Track Editor** or, if the tempo track is deactivated on the **Transport** panel, the current tempo and time signature.

NOTE

If you want to include other **Inspector** settings than those specified in the **Export Options**, use **Merge MIDI in Loop** to convert these settings to real MIDI events.

RELATED LINKS

[Export Options Dialog for MIDI Files](#) on page 178

[Merging MIDI Events into a New Part](#) on page 902

Export Options Dialog for MIDI Files

The **Export Options** for MIDI files allow you to specify what data is included in the exported MIDI files.

- To open the **Export Options** for MIDI files, select **File > Export > MIDI File**.

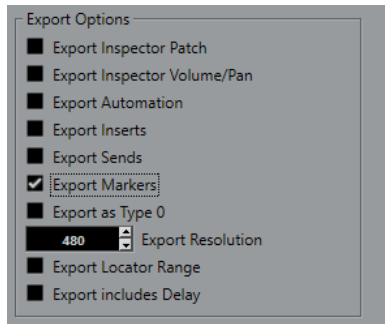

Export Inspector Patch

Includes MIDI patch settings in the **Inspector** as MIDI bank select and program change events in the MIDI file.

Export Inspector Volume/Pan

Includes volume and pan settings in the **Inspector** as MIDI volume and pan events in the MIDI file.

Export Automation

Includes automation as MIDI controller events in the MIDI file. This also includes automation recorded with the **MIDI Control** plug-in.

If you record a continuous controller (CC7, for example) and deactivate **Read Automation** for the automation track, only the part data for this controller is exported.

Export Inserts

Includes MIDI modifiers and MIDI inserts in the MIDI file.

Export Sends

Includes MIDI sends in the MIDI file.

Export Markers

Includes markers as standard MIDI file marker events in the MIDI file.

Export as Type 0

Exports a type 0 MIDI file with all data on a single track, but on different MIDI channels. If you deactivate this option, a type 1 MIDI file with data on separate tracks is exported.

Export Resolution

Allows you to set a MIDI resolution between 24 and 960 for the MIDI file. The resolution is the number of pulses, or ticks, per quarter note (PPQ) and determines the precision with which you will be able to view and edit the MIDI data. The higher the resolution, the higher the precision. The resolution should be chosen depending on the application or sequencer with which the MIDI file will be used, because certain applications and sequencers may not be able to handle certain resolutions.

Export Locator Range

Exports only the range between the left and right locator.

Export includes Delay

Includes delay settings you have made in the **Inspector** in the MIDI file.

RELATED LINKS

- [Automation](#) on page 805
- [Markers](#) on page 368
- [MIDI Track Parameters](#) on page 880
- [Merging MIDI Events into a New Part](#) on page 902
- [Export Options](#) on page 1368

Splitting Multi-Channel Audio Tracks

You can split multi-channel tracks, such as stereo or surround, into several mono tracks. This is useful if you want to use the tracks in an application that only supports mono tracks or if you want to edit individual channels of a multi-channel file.

PROCEDURE

1. In the **Project** window, select the track that you want to split.
2. Select **Project > Convert Tracks > Multi-Channel to Mono**.
3. In the **Split Multi-Channel to Mono** dialog, make your changes and click **OK**.

RESULT

- The tracks are split into as many mono tracks as corresponds to the channel configuration of the source track.
- All channel settings of the source tracks are copied to the tracks created by the split operation.
- The multi-channel audio material of the source track is split into mono events, which are inserted on the new tracks.
- In the **Audio** folder of the project, a subfolder called **Split** is created, which contains the new mono files.

NOTE

- If you split a stereo track, the resulting mono tracks are panned hard left and hard right, using the standard stereo panner.
- If you split a multi-channel track and this track is routed to an output bus, a group channel, or an FX channel with corresponding child busses, all resulting mono tracks are routed to their assigned channels. Otherwise, the resulting mono tracks are panned to center.
- If the channel configurations of the source track and the source file do not match because the multi-channel source track contains a mono file, for example, this mono file is copied onto the first 2 destination tracks. However, since panning information is not considered during the split, the volume of the new mono file may not correspond to that of the file on the original track.

Split Multi-Channel to Mono Dialog

The **Split Multi-Channel to Mono** dialog allows you to specify how multi-channel tracks are converted to mono tracks.

- To open the **Split Multi-Channel to Mono** dialog, select **Project > Convert Tracks > Multi-Channel to Mono**.

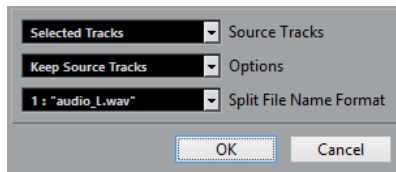

Source Tracks

Allows you to select whether you want to split all multi-channel tracks or only the selected.

Options

Allows you to specify what happens when the multi-channel file is split:

- **Keep Source Tracks**
Inserts new tracks below the source tracks.
- **Mute Source Tracks**
Inserts new tracks below the source tracks and mutes the source tracks.
- **Delete Source Tracks**
Inserts new tracks and deletes the source tracks.
- **Create New Project**
Creates a new project containing only the resulting tracks.

Split File Name Format

This pop-up menu allows you to specify how the split tracks and files are named.

Merging Mono Audio Tracks to Multi-Channel Tracks

You can convert mono tracks into multi-channel tracks to make editing and mixing more convenient.

PREREQUISITE

- Your project contains tracks with audio events that are not in **Musical Mode**.
- The tracks fit evenly into a number of multi-channel files of the destination format.
- The tracks reside on the same level in the track list, that is, either on the top level or within the same folder track.
- The tracks match in terms of channel settings and automation.
If the settings differ, the settings of the topmost track of each group are used.
If the separate audio events have different volume envelopes, these are calculated into the new clip.
- The level of the source events should not exceed 0 dB, otherwise clipping occurs in the created files. The only exception to this are files in 32-bit float format.

PROCEDURE

1. Optional: Select the tracks that you want to convert in the **Project** window.
 2. Select **Project > Convert Tracks > Mono to Multi-Channel**.
 3. In the **Merge Mono to Multi-Channel** dialog, make your changes and click **OK**.
-

RESULT

- The tracks are converted into as many multi-channel tracks as corresponds to the destination format.
- The names of the multi-channel tracks derive from the mono source tracks.

NOTE

The following naming rules apply:

- If the track names of the source tracks end with a suffix separated by a space or a special character that indicates the corresponding speaker channel, for example, “_L” or “(L)” for the left channel, this suffix is removed for the multi-channel track name.
 - If the track names of the source tracks do not end with a channel suffix, the channel configuration of the multi-channel track is added to its name.
-
- Events that have the same timeline position are converted into a multi-channel event on the new track.
 - If the lengths of the source events do not match exactly, the overlap is included in the new events.
 - In the **Audio** folder of the project, a subfolder called **Merge** is created which contains the new multi-channel files.

NOTE

If the outputs of the mono tracks are routed to separate channels within one output bus, this bus is selected as output for the multi-channel track.

RELATED LINKS

[Merge Mono to Multi-Channel Dialog](#) on page 181

[Export Audio Mixdown](#) on page 1162

Merge Mono to Multi-Channel Dialog

The **Merge Mono to Multi-Channel** dialog allows you to specify how mono tracks are converted to multi-channel tracks.

- To open the **Merge Mono to Multi-Channel** dialog, select **Project > Convert Tracks > Mono to Multi-Channel**.

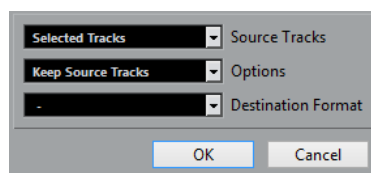

Source Tracks

Allows you to select whether you want to merge all mono tracks or only the selected.

Options

Allows you to specify what happens when the mono files are merged:

- **Keep Source Tracks**
Inserts new tracks below the source tracks.
- **Mute Source Tracks**
Inserts new tracks below the source tracks and mutes the source tracks.
- **Delete Source Tracks**
Inserts new tracks and deletes the source tracks.
- **Create New Project**
Creates a new project containing only the resulting tracks.

Destination Format

Allows you to select the format for the multi-channel file.

NOTE

The number of selected tracks must match this format. The tracks are combined according to their order in the track list.

Removing Selected Tracks

You can remove selected tracks from the track list.

PROCEDURE

- Select **Project > Remove Selected Tracks**.
If you delete tracks that are not empty, a warning message is displayed.

NOTE

You can deactivate this message. To reactivate the message, activate **Display Warning before Deleting Non-Empty Tracks** in the **Preferences** dialog (**Editing** page).

Removing Empty Tracks

You can remove empty tracks from the track list.

PROCEDURE

- Select **Project > Remove Empty Tracks**.
-

Moving Tracks in the Track List

You can move tracks up or down in the track list.

PROCEDURE

- Select a track and drag it up or down in the track list.
-

Renaming Tracks

You can rename tracks.

PROCEDURE

1. Double-click the track name and type in a new name for the track.
 2. Press **Return**.
If you want all events on the track to get the same name, hold down any modifier key and press **Return**.
-

AFTER COMPLETING THIS TASK

If the **Parts Get Track Names** option is activated in the **Preferences** dialog (**Editing** page), and you move an event from one track to another, the moved event will automatically be named according to its new track.

Automatically Assigning Colors to New Tracks/Channels

You can automatically assign colors to newly added tracks or channels.

PROCEDURE

1. Select **Edit > Preferences**.
2. Open the **User Interface** page, and select **Track & MixConsole Channel Colors**.
3. Open the **Auto Track/Channel Color Mode** pop-up menu and select an option.
4. Click **OK**.

RESULT

Any tracks/channels that you added by using **Add Track**, or by dragging files from the **Media** rack to the event display are automatically colored according to your settings.

RELATED LINKS

[User Interface - Track & MixConsole Channel Colors](#) on page 1377

Showing Track Pictures

You can add pictures to tracks to recognize your tracks easily. Track pictures are available for audio, instrument, MIDI, FX channel and group channel tracks.

PREREQUISITE

Adjust the track height to at least 2 rows.

PROCEDURE

1. Right-click any track in the track list.
2. From the track list context menu, select **Show Track Pictures**.

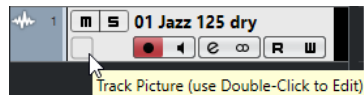

If you move the mouse to the left on a track, a highlighted rectangle appears.

AFTER COMPLETING THIS TASK

Double-click the rectangle to open the **Track Pictures Browser** and set up a track picture.

RELATED LINKS

[Track Pictures Browser](#) on page 183

Track Pictures Browser

The **Track Pictures Browser** allows you to set up and select pictures that can be shown in the track list and in the **MixConsole**. Track pictures are useful to recognize tracks and channels easily. You can select pictures from the factory content or add new ones to the user library.

- To open the **Track Pictures Browser** for a track, double-click in the lower left side of the track list.

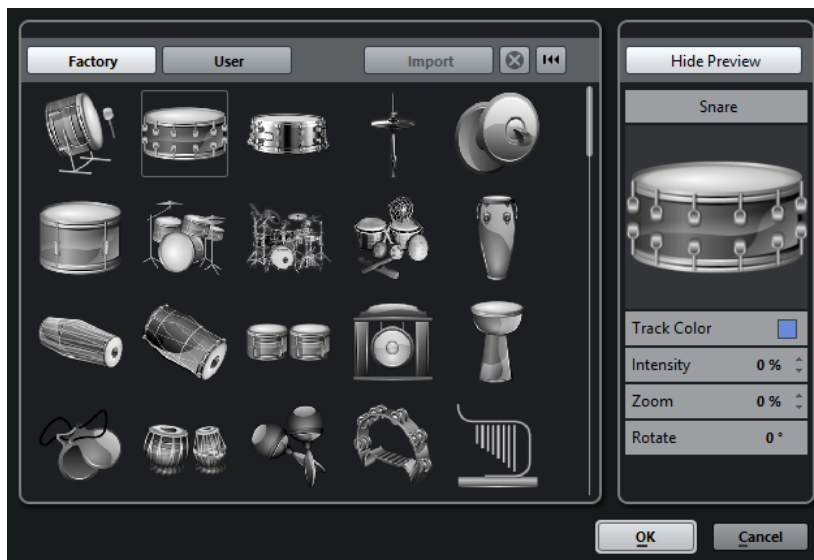

Factory

Shows the factory content in the pictures browser.

Pictures browser

Shows the pictures that you can assign to the selected track/channel.

User

Shows your user content in the pictures browser.

Import

Opens a file dialog that allows you to select pictures in bmp, jpeg, or png format and add them to the user library.

Remove Selected Pictures from User Library

Removes the selected pictures from the user library.

Reset Current Picture

Removes the picture from the selected track/channel.

Show Preview/Hide Preview

Opens/Closes a section with further color and zoom settings.

Track Picture Preview

Shows the current track picture. When you zoom in the picture, you can drag it with the mouse to change its visible part.

Track Color

Opens the **Color Picker** that allows you to select a track color.

Intensity

Allows you to apply the track color to the track picture and set the color intensity.

Zoom

Allows you to change the size of the track picture.

Rotate

Allows you to rotate the track picture.

Setting the Track Height

You can enlarge the track height to show the events on the track in detail, or you can decrease the height of several tracks to get a better overview of your project.

- To change the height of an individual track, click its lower border in the track list and drag up or down.
- To change the height of all tracks simultaneously, hold down **Ctrl/Cmd**, click the lower border of one track, and drag up or down.
- To set the number of tracks to view in the **Project** window, use the track zoom menu.
- To set the track height automatically when you select a track, click **Edit > Enlarge Selected Track**.

RELATED LINKS

[Track Zoom Menu](#) on page 185

[Track Controls Settings Dialog](#) on page 121

Track Zoom Menu

The track zoom pop-up menu allows you to set the number of tracks and the track height in the **Project** window.

- To open the track zoom pop-up menu in the lower right of the **Project** window, click the arrow button above the vertical zoom control.

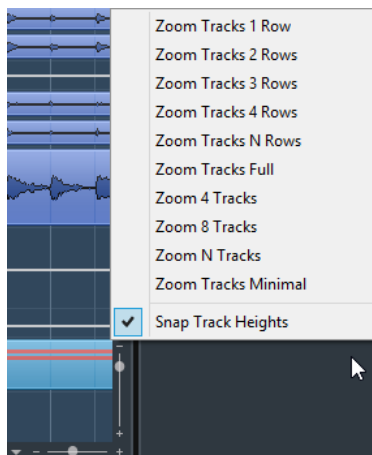

The following options are available:

Zoom Tracks x Rows

Zooms all track heights to show the specified number of rows.

Zoom Tracks Full

Zooms all tracks to fit in the active **Project** window.

Zoom Tracks N Rows

Allows you to set the number of rows to fit in the active **Project** window.

Zoom x Tracks

Zooms the specified number of tracks to fit in the active **Project** window.

Zoom N Tracks

Allows you to set the number of tracks to fit in the active **Project** window.

Zoom Tracks Minimal

Zooms all track heights to the minimum size.

Snap Track Heights

Changes the track height in fixed increments when you resize it.

Selecting Tracks

You can select one or multiple tracks in the track list.

- To select a track, click on it in the track list.
- To select several tracks, **Ctrl/Cmd**-click several tracks.
- To select a continuous range of tracks, **Shift**-click the first and last track in a continuous range of tracks.

Selected tracks are highlighted in the track list.

RELATED LINKS

[Track Selection Follows Event Selection](#) on page 1357

[Scroll to Selected Track](#) on page 1360

[Select Channel/Track on Solo](#) on page 1360

[Select Channel/Track on Edit Settings](#) on page 1360

Selecting Tracks with Arrow Keys

You can select tracks and events with the **Up Arrow** key or the **Down Arrow** key on the computer keyboard. However, you can make the **Up Arrow** key and the **Down Arrow** key exclusively available for selecting tracks.

- To make the **Up Arrow** key and the **Down Arrow** key exclusively available for selecting tracks, activate **Use Up/Down Navigation Commands for Selecting Tracks Only** in the **Preferences** dialog (**Editing** page).

The following applies:

- If this option is deactivated and no event/part is selected in the **Project** window, the **Up Arrow** key and the **Down Arrow** key are used to step through the tracks in the track list.
- If this option is deactivated and an event/part is selected in the **Project** window, the **Up Arrow** key and the **Down Arrow** key still step through the tracks in the track list – but on the selected track, the first event/part will automatically be selected as well.
- If this option is activated, the **Up Arrow** key and the **Down Arrow** key are only used to change the track selection – the current event/part selection in the **Project** window is not altered.

Deselecting Tracks

You can deselect tracks that are selected in the track list.

PROCEDURE

- **Shift**-click a selected track.
-

RESULT

The track is deselected.

Duplicating Tracks

You can duplicate a track with all contents and channel settings.

PROCEDURE

- Select **Project > Duplicate Tracks**.

RESULT

The duplicated track appears below the original track.

Disabling Tracks

You can disable audio, instrument, MIDI, and sampler tracks that you do not want to play back or process at the moment. Disabling a track zeroes its output volume and shuts down all disk activity and processing for the track.

PROCEDURE

- Right-click in the track list and select **Disable Track** from the context menu.

RESULT

The track color changes and the corresponding channel in the **MixConsole** is hidden.

To enable a disabled track and restore all channel settings, right-click in the track list and select **Enable Track**.

Organizing Tracks in Folder Tracks

You can organize your tracks in folders by moving tracks into folder tracks. This allows you to perform editing on several tracks as one entity. Folder tracks can contain any type of track including other folder tracks.

- To add a folder track, click **Add Track** in the global track controls area of the track list, and click **Folder**.
- To add a folder track and move all selected tracks into it, open the **Project** menu and from the **Track Folding** submenu select **Move Selected Tracks to New Folder**.
- To move tracks into a folder, select them and drag them into the folder track.
- To remove tracks from a folder, select them and drag them out of the folder.
- To hide/show tracks in a folder, click the **Expand/Collapse Folder** button of the folder track.
- To hide/show data on a folder track, open the context menu for the folder track and select an option from the **Show Data on Folder Tracks** submenu.
- To mute/solo all tracks in a folder track, click the **Mute** or **Solo** button for the folder track.

NOTE

Hidden tracks are played back as usual.

RELATED LINKS

[Group Editing Mode](#) on page 238

Moving Tracks to Folder Tracks

You can move your tracks to folder tracks to organize them and to perform editing on several tracks as one entity. You can move any type of track including other folder tracks to folder tracks.

PROCEDURE

- Select **Project > Track Folding > Move Selected Tracks to New Folder**.

RESULT

This creates a new folder and moves all selected tracks into it.

NOTE

You can also drag and drop tracks into or out of a folder track.

RELATED LINKS

[Folder Tracks](#) on page 154

Handling Overlapping Audio

The basic rule for audio tracks is that each track can only play back a single audio event at a time. If two or more events overlap, only the one that is in front is played back. You can, however, select the event/region that you want to play back.

PROCEDURE

- Do one of the following:
 - Right-click the audio event in the event display and select the desired event or region from the **To Front** or **Set to Region** submenu.

NOTE

The available options depend on whether you performed a linear or a cycle recording and the record mode you used. When recording audio in cycle mode, the recorded event is divided in regions, one for each take.

-
- Click the middle handle on the lower border of a stacked event and select an entry from the pop-up menu.
 - In the track list, activate **Show Lanes** and select the desired take.
-

RELATED LINKS

[Lanes, Takes and Overlapping Events](#) on page 190

Track Folding Menu

You can show, hide, or invert tracks that are displayed in the **Project** window event display. This allows you to divide the project into several parts by creating several folder tracks for the different project elements and showing/hiding their contents by selecting a menu function or using a key command. You can also fold in automation tracks this way.

- To open the **Track Folding** submenu, select **Project > Track Folding**.

The following options are available:

Toggle Selected Track

Reverses the fold state of the selected track.

Fold Tracks

Folds in all open folder tracks in the **Project** window.

NOTE

The behavior of this function depends on the **Deep Track Folding** setting in the **Preferences** dialog.

Unfold Tracks

Unfolds all folder tracks in the **Project** window.

NOTE

The behavior of this function depends on the **Deep Track Folding** setting in the **Preferences** dialog.

Flip Fold States

Flips the fold states of the tracks in the **Project** window. This means that all tracks that were folded in will be unfolded and all unfolded tracks will be folded in.

Move Selected Tracks to New Folder

Moves all selected tracks to the folder track. This menu option is available if at least one folder track is available.

NOTE

- You can assign key commands for these menu options in the **Key Commands** dialog in the **Project** category.
 - If you activate **Deep Track Folding** in the **Preferences** dialog (**Editing—Project & MixConsole** page), track folding is applied to all subelements of the tracks.
-

Events Display on Folder Tracks

Closed folder tracks can display data of the contained audio, MIDI, and instrument tracks as data blocks or as events.

When you close folder tracks, the contents of the contained tracks are displayed as data blocks or events. Depending on the folder track height, the display of the events can be more or less detailed.

Modifying Event Display on Folder Tracks

You can modify the event display on folder tracks.

PROCEDURE

1. Right-click the folder track.
2. On the context menu, select **Show Data on Folder Tracks**.

You have the following options:

- **Always Show Data**
Displays data blocks or event details always.
- **Never Show Data**

Displays nothing.

- **Hide Data When Expanded**
Hides the display of events when you open folder tracks.
- **Show Event Details**
Displays event details instead of data blocks.

NOTE

You can change these settings in the **Preferences** dialog (**Event Display—Folders** page).

RELATED LINKS

[Event Display - Folders](#) on page 1364

Lanes, Takes and Overlapping Events

In the following, we focus on cycle recordings with takes. However, you can also apply lane operations and comping methods on overlapping events or parts that you assemble on one track.

If you perform a cycle recording in the **Keep History** or **Cycle History + Replace** modes (audio) or in the **Stacked** or **Mix-Stacked** modes (MIDI), the recorded cycle laps are shown on the track with the last recorded take active and on top.

The **Show Lanes** mode gives you a good overview of all your takes. If you activate the **Show Lanes** button, the recorded takes are shown on separate lanes.

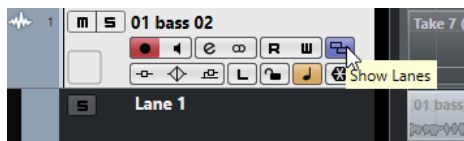

Lanes are handled differently, depending on whether you work with audio or MIDI:

Audio

As each audio track can only play back one single audio event at a time, you only hear the take that is activated for playback, for example, the last lap of a cycle recording.

MIDI

Overlapping MIDI takes (parts) can be played back simultaneously. If you recorded in **Mix-Stacked** mode, you hear all takes from all cycle laps.

Lanes can be reordered, sized, and zoomed like regular tracks.

To solo a lane, you can activate the **Solo** button for it. This allows you to hear the lane in the project context. If you want to hear the take without the project context, you also have to activate the main track's **Solo** button.

Assembling a Perfect Take

You can play back, split, and activate takes to combine the best parts of your recording in a final take.

PROCEDURE

1. Select the **Comp** tool or the **Object Selection** tool.
2. Bring a take to the front to select it for playback, and listen to it.
3. Audition different takes to compare them in more detail.

4. If necessary, split your takes into smaller sections, create new ranges, and bring them to the front.
 5. Proceed until you are satisfied with the result.
-

AFTER COMPLETING THIS TASK

After assembling your perfect take, you can improve your take.

- To automatically resolve overlaps and remove empty lanes, right-click the track and select **Clean Up Lanes**.

For audio, proceed as follows:

- Apply auto fades and crossfades to the comped takes.
- To put all takes on a single lane, and remove all takes in the background, select all takes and select **Audio > Advanced > Delete Overlaps**.
- To create a new and continuous event of all selected takes, select **Audio > Bounce Selection**.

For MIDI, proceed as follows:

- Open your takes in a MIDI editor to perform fine adjustments like removing or editing notes.
- To create a new and continuous part of all selected takes that is placed on a single lane, select all takes and select **MIDI > Bounce MIDI**.
- To create a new part and place it on a new track, select **MIDI > Merge MIDI in Loop**.

Finally, clean up the lanes as follows:

- Right-click a track and select **Create Tracks from Lanes**.
The lane is converted into a new track.

Assembling Operations

Unless otherwise stated, all operations can be performed in the **Project** window and in the **Audio Part Editor**. **Snap** is taken into account, and all operations can be undone.

To assemble a perfect take, you can use the **Comp** tool, the **Object Selection** tool, or the **Range Selection** tool.

- The **Comp** tool modifies all takes on all lanes simultaneously.
This is useful if the recorded takes have the same start and end positions.
- The **Object Selection** tool and the **Range Selection** tool affect single takes on individual lanes.
If this is not what you want, you can either perform your edits on the main track or use the **Comp** tool.

NOTE

If you assemble stacked events on an audio track, deactivate **Treat Muted Audio Events like Deleted** in the **Preferences** dialog (**Editing—Audio** page).

You can perform the following operations:

Assembling Operations

Operation	Comp tool	Object Selection/Range Selection tool
Select (Project window only)	Hold down Shift and click on a take.	Click on a take.
Bring to front	Click on a take. Click twice to toggle.	Position the mouse pointer over the middle of the lower border of a take until it changes to a Comp symbol, and click. Click twice to toggle. For MIDI this mutes/unmutes a take.
Comping (create a new range and bring it to front, Project window only)	Click and drag on a lane. All takes are split at the range start and end. If the audio takes are adjacent without gaps or fades and the material itself matches, the takes are merged within the range.	-
Audition	Press Ctrl/Cmd to activate the Speaker tool and click at the position where you want playback to start.	See left.
Move	Click and drag on the main track.	Click and drag on any lane.
Resize	Drag the resize handles. All takes with the same start and end positions are affected. Resizing is constrained to the end or start of the adjacent takes. This ensures that you do not create overlaps accidentally.	Drag the resize handles.
Correct timing (Slip Event)	Select a take, hold down Alt/Opt-Shift (the tool modifier for Slip Event) and drag with the mouse.	See left.

Defining the Default Track Time Base

You can specify the default track time type for new tracks (audio, group/FX, MIDI, and marker tracks).

PROCEDURE

1. In the **Preferences** dialog, select **Editing**.
2. Open the **Default Track Time Type** pop-up menu and select a default track time type.

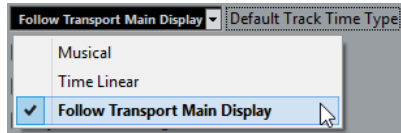

RESULT

If you selected **Follow Transport Main Display**, the primary time format setting on the **Transport** panel is used. When this is set to **Bars+Beats**, tracks with musical time base are added. When this is set to any of the other options (Seconds, Timecode, Samples, etc.), all new tracks use linear time base.

RELATED LINKS

[Default Track Time Type](#) on page 1356

Track Versions

Track versions allow you to create and manage multiple versions of events and parts on the same track.

Track versions are available for audio, MIDI, and instrument tracks. You can also have track versions of the chord track, the signature track, and the tempo track.

Track versions are useful for the following tasks:

- Starting new recordings from scratch.
- Comparing different takes and comps.
- Managing takes that were recorded in a multi-track recording.

NOTE

Track versions are not available for automation tracks.

Track versions are included in track archives and project backups. When you work with the networking feature, only the active track version is committed.

The track version key commands can be found in the **Track Versions** category of the **Key Commands** dialog.

Track Versions Pop-Up Menu

The **Track Versions** pop-up menu is available for all track types that support track versions. It contains the most important functions for managing track versions and a track versions list.

- To open the **Track Versions** pop-up menu for a track, click the arrow to the right of the track name.

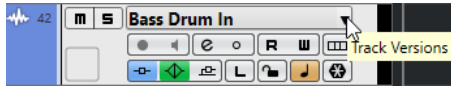

The following options are available:

Track Version list

Lists all track versions of the track for which you opened the **Track Versions** pop-up menu and allows you to activate a track version.

New Version

Creates a new, empty track version for all selected tracks.

Duplicate Version

Creates a copy of the active track version for all selected tracks.

Rename Version

Opens a dialog that allows you to change the track version name for the selected tracks.

Delete Version

Deletes the active track version for all selected tracks. This is only available if the track has more than one track version.

Select Tracks with Same Version ID

Selects all tracks that have a track version with the same ID.

Show Version Name in Track List

Shows/Hides the version name next to the track name in the track list.

Track Versions Section

The **Track Versions** section in the **Inspector** allows you to view and manage track versions for a selected track. It is available for audio tracks, MIDI tracks, instrument tracks, the sampler track and the chord track.

- To open the **Track Versions** section for a track, select the track, and in the **Inspector**, click the **Track Versions** section.

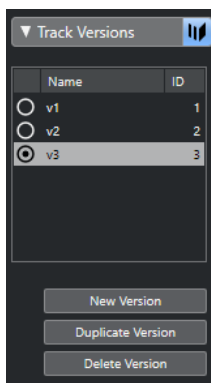

Track Version Indicator

Indicates that more than one track version exists.

Name

Shows the version name. Double-click to change it. The name will be changed for all selected tracks.

ID

Shows the track version ID.

Track Version list

Lists all track versions and allows you to activate one of them for all selected tracks.

New Version

Creates a new, empty track version for all selected tracks.

Duplicate Version

Creates a copy of the active track version for all selected tracks.

Delete Version

Deletes the active track version for all selected tracks. This function is only available if the track has more than one track version.

Creating New Track Versions

You can create new, empty track versions for selected tracks.

PROCEDURE

1. In the track list, select the tracks for which you want to create a new track version.
2. Select **Project > Track Versions > New Version**.

NOTE

You can also use the **Track Versions** section in the **Inspector** (only available for audio tracks, MIDI tracks, instrument tracks, and the chord track) or the **Track Versions** pop-up menu in the track list to create a new track version.

RESULT

The event display shows a new, empty track version. Events of previous track versions are hidden. The track list shows a default version name.

Track Version IDs

All track versions are automatically assigned an ID. Track versions that are created together get the same track version ID and can be selected together.

In the **Track Versions** section in the **Inspector**, the track version ID is shown in the **ID** column of the track version list.

In the track list, you can open the **Track Versions** pop-up menu to see the track version ID.

Selecting Tracks by Track Version ID

You can simultaneously select all tracks that share the same track version ID.

PROCEDURE

1. Activate the track version.
 2. Select **Project > Track Versions > Select Tracks with Same Version ID**.
-

RESULT

All tracks that have track versions with the same ID are selected.

Assigning a Common ID

Track versions on different tracks that were not created together have different track version IDs. Track versions with different IDs cannot be activated together. To do this, you must assign a new version ID to these tracks.

PROCEDURE

1. Select the tracks and activate the track versions to which you want to assign a common version ID.
 2. Select **Project > Track Versions > Assign Common Version ID**.
-

RESULT

A new ID is assigned to all active track versions on the selected tracks. The tracks are now marked as belonging together. You can now activate them together.

Active Track Version

If you created more than one track version for a track, you can show the events of a specific track version in the event display. This process is referred to as activating track versions.

Activating Track Versions

You can activate one of your track versions. This also shows its events in the event display.

PROCEDURE

1. Click the arrow to the right of the track name to open the **Track Versions** pop-up menu.

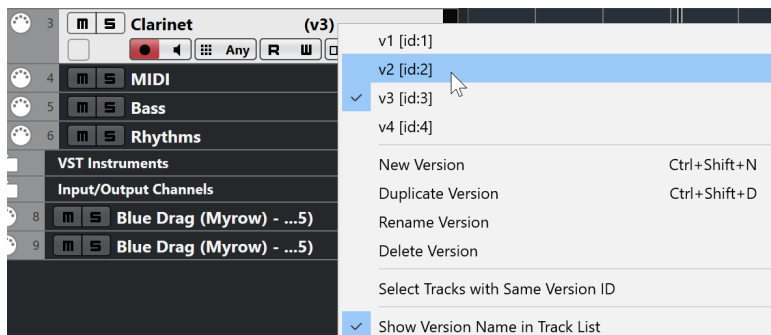

2. Select the track version that you want to activate.
 3. Optional: Activate **Show Version Name in Track List**.
This shows the version name next to the track name in the track list.
-

RESULT

The selected version is activated and its events are shown in the event display.

NOTE

If you work with audio tracks, MIDI tracks, instrument tracks, the sampler track or the chord track, you can also use the **Track Versions** section of the **Inspector** to activate a track version.

RELATED LINKS

- [Track Versions Pop-Up Menu](#) on page 194
- [Track Version Names](#) on page 199

Activating Track Versions on Multiple Tracks

You can simultaneously activate track versions on multiple tracks if these track versions share the same ID.

PROCEDURE

1. Select all tracks for which you want to activate a specific track version.
2. Click the arrow to the right of a track name to open the **Track Versions** pop-up menu.
3. Select the track version that you want to activate from the list.

RESULT

The selected track version is activated for all selected tracks, and the corresponding events are shown in the event display.

NOTE

If you work with audio tracks, MIDI tracks, instrument tracks, or the chord track, you can also use the **Track Versions** section of the **Inspector** to activate a track version.

Duplicating Track Versions

You can duplicate a track version by creating a new track version that contains a copy of the active track version.

PROCEDURE

1. In the track list, select the tracks and activate the track version that you want to duplicate.
2. Select **Project > Track Versions > Duplicate Version**.

In the event display, a duplicate track version is displayed. In the track list, a default version name for the duplicate is shown.

NOTE

You can also use the **Track Versions** section of the **Inspector** for audio tracks, MIDI tracks, instrument tracks, and chord tracks or the **Track Versions** pop-up menu in the track list to duplicate a track version.

Deleting Track Versions

You can delete track versions that you no longer need.

PROCEDURE

1. Select the tracks and activate the track versions that you want to delete.
2. Select **Project > Track Versions > Delete Version**.

NOTE

You can also use the **Track Versions** section of the **Inspector** for audio tracks, MIDI tracks, instrument tracks, and chord tracks or the **Track Versions** pop-up menu in the track list to delete the active track version for selected tracks.

Copying and Pasting Selection Ranges Between Track Versions

You can copy and paste ranges between different track versions, even across multiple tracks.

PREREQUISITE

You have at least 2 track versions.

PROCEDURE

1. Select the **Range Selection** tool.
 2. Select a range of the track version that you want to copy.
 3. Select **Edit > Copy**.
 4. Activate the track version into which you want to insert the copied range.
 5. Select **Edit > Paste**.
-

RESULT

The copied range from the first track version is pasted to the second track version at the exact same position.

NOTE

If you want to perform more complicated comping tasks, we recommend that you select **Project > Track Versions > Create Lanes from Versions** and proceed with the **Comp** tool.

Copying and Pasting Selected Events between Track Versions

You can copy and paste selected events between different track versions, even across multiple tracks.

PREREQUISITE

You have at least 2 track versions, and you have split the corresponding events with the **Split** tool, for example.

PROCEDURE

1. Select the **Object Selection** tool.
 2. Select the events that you want to copy.
 3. Select **Edit > Copy**.
 4. Activate the track version into which you want to insert the copied events.
 5. Select **Edit > Functions > Paste at Origin**.
This ensures that the events are inserted at the exact same position.
-

RESULT

The copied events from the first track version are pasted to the second track version at the exact same position.

Track Version Names

Each track version has a default track version name.

If more than one version is available for the track, the track version name is shown in the track list and in the **Track Versions** section in the **Inspector**. By default, track versions are named v1, v2, etc. However, you can rename each track version to your liking.

NOTE

You can show/hide the version name next to the track name in the track list by activating/deactivating **Show Version Name in Track List** in the **Track Versions** pop-up menu for a track.

RELATED LINKS

[Track Versions Pop-Up Menu](#) on page 194

Renaming a Track Version

You can rename track versions.

PROCEDURE

- In the **Track Versions** section in the **Inspector**, double-click the track version name and enter a new name.

The name is changed. If the available space in the track list is too small, the name is abbreviated automatically.

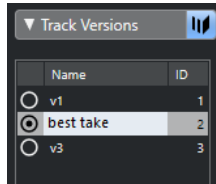

Renaming Track Versions on Multiple Tracks

You can rename track versions on multiple tracks.

PROCEDURE

1. Activate all track versions that you want to rename, and select the corresponding tracks.
2. Select **Project > Track Versions > Rename Version**.
3. Enter a new track version name and click **OK**.

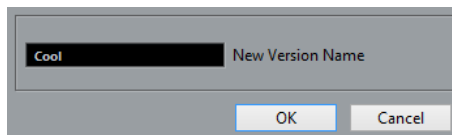

RESULT

In the track list, the new track version name is shown.

NOTE

If you want to assign the same ID to track versions, select **Project > Track Versions > Assign Common Version ID**.

Track Versions vs. Lanes

Track versions and lanes are individual features that complement each other. Every track version can have its own set of lanes.

Creating Lanes from Track Versions

If your project contains track versions and you want to continue working with lanes, using the **Comp** tool, for example, you can create lanes from track versions.

PROCEDURE

1. Select the tracks for which you want to create lanes.
 2. Select **Project > Track Versions > Create Lanes from Versions**.
A new track version named **Lanes from Version** is added. This track version contains all track versions on separate lanes. The original track versions are kept. Lanes that you create from MIDI track versions are muted.
 3. In the track list or in the **Inspector**, activate the **Show Lanes** button for the track.
 4. On the **Project** window toolbar, activate the **Comp** tool and continue as usual.
-

Creating Track Versions from Lanes

If your project contains lanes and you want to continue working with the track version functions, you can create track versions from lanes.

PROCEDURE

1. Select the tracks for which you want to create track versions.
If you only want to convert specific lanes, select these lanes.
 2. Select **Project > Track Versions > Create Versions from Lanes**.
-

RESULT

New track versions are added, one for each separate lane. The original lanes are kept. Any crossfades that you have created between different lanes are discarded.

Track Presets

Track presets are templates that can be applied to newly created or existing tracks of the same type.

You can create them from virtually all track types (audio, MIDI, instrument, sampler, group, FX, VST instrument return, input, and output channels). They contain sound and channel settings, and allow you to quickly browse, preview, select, and change sounds, or reuse channel settings across projects.

Track presets are organized in the **MediaBay**. There, you can categorize them with attributes.

When you apply a track preset, all the settings that are saved in the preset are applied.

Track presets can only be applied to tracks of their own type. The only exception are instrument tracks: for these, VST presets are also available.

NOTE

- Once a track preset is applied, you cannot undo the changes. It is not possible to remove an applied preset from a track and return to the previous state. If you are not satisfied with the track settings, you have to either edit the settings manually or apply another preset.

- Applying VST presets to instrument tracks leads to removal of modifiers, MIDI inserts, inserts, or EQs. These settings are not stored in VST presets.
-

Audio Track Presets

Track presets for audio tracks, group tracks, FX tracks, VST instrument channels, input channels, and output channels include all settings that define the sound.

You can use the factory presets as a starting point for your own editing and save the audio settings that you optimized for an artist that you often work with as a preset for future recordings.

The following data is saved in audio track presets:

- Insert effects settings (including VST effect presets)
- EQ settings
- Volume and pan
- Input gain and phase

NOTE

To access the track presets functions for input and output channels, activate the **Write** buttons for input and output channels in the **MixConsole**. This creates input and output channel tracks in the track list.

MIDI Track Presets

You can use MIDI track presets for multitimbral VST instruments. You can also use them for external instruments.

When creating MIDI track presets, you can either include the channel or the patch.

- To ensure that saved MIDI track presets for external instruments will work again with the same instrument, install the instrument as a MIDI device, see the separate document **MIDI Devices**.

The following data is saved in MIDI track presets:

- MIDI modifiers (Transpose, etc.)
- MIDI insert effects
- Output and Channel or Program Change
- Input Transformer settings
- Volume and pan
- Staff settings
- Color settings
- Drum map settings

Creating a Track Preset

You can create a track preset from a single track or from a combination of tracks.

PROCEDURE

1. In the **Project** window, select one or more tracks.
2. In the track list, right-click one of the selected tracks and select **Save Track Preset**.

3. In the **New Preset** section, enter a name for the new preset.

NOTE

You can also define attributes for the preset.

4. Click **OK** to save the preset and exit the dialog.
-

RESULT

Track presets are saved within the application folder in the track presets folder. They are saved in default subfolders named according to their track type: audio, MIDI, instrument, and multi.

RELATED LINKS

[Attribute Inspector](#) on page 728

Loading Presets for Tracks

You can choose from a variety of track presets.

PROCEDURE

1. In the **Inspector**, click the **Preset Management** icon on the right of the **Inserts** section.
 2. Select **From Track Preset**.
 3. In the **Results** browser, double-click a track preset to apply it.
-

RELATED LINKS

[Track Presets](#) on page 201

Loading Presets for VST Instruments

When working with VST instruments, you can choose from a variety of presets via the **Results** browser.

PROCEDURE

1. In the track list, right-click the instrument track and select **Load Track Preset**.
 2. In the **Results** browser, double-click a preset to apply it.
-

Instrument Track Presets

Instrument track presets offer both MIDI and audio features and are the best choice when handling sounds of simple, mono-timbral VST instruments.

Use instrument track presets for auditioning your tracks or saving your preferred sound settings, for example. You can also extract sounds from instrument track presets for use in instrument tracks.

The following data is saved in instrument track presets:

- Audio insert effects
- Audio EQ
- Audio volume and pan
- Audio input gain and phase
- MIDI insert effects

- MIDI track parameters
- Input Transformer settings
- The VST instrument used for the track
- Staff settings
- Color settings
- Drum map settings

VST Presets

VST instrument presets behave like instrument track presets. You can extract sounds from VST presets for use in instrument tracks.

The following data is saved in VST instrument presets:

- VST instrument
- VST instrument settings

NOTE

Modifiers, inserts, and EQ settings are not saved.

VST effect plug-ins are available in VST 3 and VST 2 format.

NOTE

In this manual, VST presets stands for VST 3 instrument presets, unless stated otherwise.

Extracting the Sound from an Instrument Track or VST Preset

For instrument tracks, you can extract the sound of an instrument track preset or VST preset.

PROCEDURE

1. Select the instrument track to which you want to apply a sound.
 2. In the **Inspector**, click **Extract Sound from Track Preset**.
 3. In the preset browser, select an instrument track preset or VST preset.
 4. Double-click the preset to load the settings.
-

RESULT

The VST instrument and its settings (but no inserts, EQs, or modifiers) on the existing track are overwritten with the data of the track preset. The previous VST instrument for this instrument track is removed and the new VST instrument with its settings is set up for the instrument track.

Multi-Track Presets

You can use multi-track presets, for example, when recording setups that require several microphones (a drum set or a choir, where you always record under the same conditions), and you have to edit the resulting tracks in a similar way. Furthermore, they can be used when working with layered tracks, where you use several tracks to generate a certain sound instead of manipulating only one track.

If you select more than one track when creating a track preset, the settings of all selected tracks are saved as one multi-track preset. Multi-track presets can only be applied if the target tracks are of the same type, number, and sequence as the tracks in the track preset, therefore, they should be used in recurring situations with similar tracks and settings.

Loading Multi-Track Presets

You can apply multi-track presets to several selected tracks.

PROCEDURE

1. In the **Project** window, select several tracks.

NOTE

Multi-track presets can only be applied if track type, number, and sequence are identical for the selected tracks and the track preset.

2. In the track list, right-click a track and select **Load Track Preset**.
3. In the preset browser, select a multi-track preset.
4. Double-click the preset to load it.

RESULT

The preset is applied.

Sampler Track Presets

You can use sampler track presets to reuse created sounds in later projects or newly created sampler tracks.

The following data is saved in sampler track presets:

- Audio insert effects
- Audio EQ
- Audio volume and pan
- Audio input gain and phase
- MIDI insert effects
- MIDI track parameters
- Input Transformer settings
- Color settings

RELATED LINKS

[Sampler Tracks](#) on page 136

Creating a Sampler Track Preset

You can create a sampler track preset from a sampler track or you can use the **Sampler Control** toolbar.

PROCEDURE

1. In the **Sampler Control** toolbar, click **Preset Management** .
2. Click **Save Track Preset**.
3. In the **Save Track Preset** dialog, type in a name for the new preset.
4. Click **OK** to save the preset and exit the dialog.

RESULT

The new sampler track preset is saved. It is displayed in the **Preset Name** field on the info line. Sampler track presets are saved within the application folder in the sampler track presets folder.

RELATED LINKS

[Creating a Track Preset](#) on page 202

Pattern Banks

Pattern banks are presets that are created for the **Beat Designer** MIDI effect.

They behave much like track presets.

RELATED LINKS

[Pattern Banks Previewer](#) on page 722

[Track Presets](#) on page 201

Loading Track or VST Presets

You can apply track or VST presets to selected tracks.

PROCEDURE

1. In the **Project** window, select a track.
2. Do one of the following:
 - In the **Inspector**, click **Load Track Preset**.
 - In the track list, right-click the track and select **Load Track Preset**.
 - In the **Sampler Control** toolbar, click the **Preset Management** button next to the **Preset Name** field and select **Load Track Preset**.
3. In the preset browser, select a track, VST, or sampler track preset.
4. Double-click the preset to load it.

RESULT

The preset is applied.

NOTE

You can also drag and drop track presets from the **MediaBay** or the File Explorer/macOS Finder onto a track of the same type.

RELATED LINKS

[Filters Section](#) on page 724

Loading Inserts and EQ from Track Presets

Instead of loading complete track presets, you can also apply insert or equalizer settings from track presets.

PROCEDURE

1. Select a track, open the **Inspector** or the **Channel Settings** window, and click the **Preset Management** button on the **Inserts** or **Equalizer** section.
 2. Select **From Track Preset**.
 3. In the preset browser, select a track preset.
 4. Double-click the preset to load the settings.
-

Track Quick Control Presets

For audio, instrument, MIDI, FX, and group tracks, you can save and load your own **Quick Control** assignments as presets or use the factory presets.

Saving/Loading Track Quick Control Assignments as Presets

You can save track quick control assignment, as presets and load them later or in other projects.

PROCEDURE

1. In the **Inspector** for your track, open the **Quick Controls** section.
For instrument tracks, the track quick controls are set to the 8 default VST quick controls of the loaded instrument by default.
2. Click **Preset Management** in the top right corner of the **Quick Controls** section and select one of the presets.

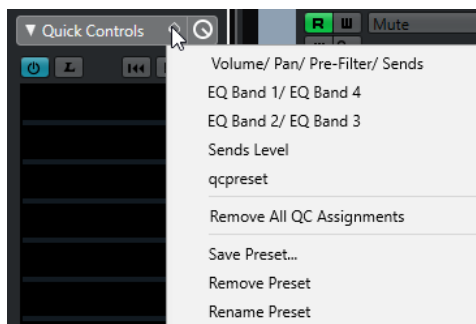

The **Track Quick Control** assignment changes and gives you access to the channel parameters.

NOTE

You can also make your own assignments and save them as presets, and delete, rename, or reset the presets to the default assignments.

Parts and Events

Parts and events are the basic building blocks in Nuendo.

Events

In Nuendo, most event types can be viewed and edited on their specific tracks in the **Project** window.

Events can be added by importing or recording.

RELATED LINKS

[Audio Regions](#) on page 211

[MIDI Events](#) on page 212

Audio Events

Audio events are created automatically when you record or import audio in the **Project** window.

You can view and edit audio events in the **Project** window and in the **Sample Editor**.

An audio event triggers the playback of the corresponding audio clip. By adjusting the **Offset** and the **Length** values of the event, you can determine which section of the audio clip is played back. The audio clip itself remains unchanged.

RELATED LINKS

[Project Window](#) on page 46

[Sample Editor](#) on page 574

[Audio Files and Audio Clips](#) on page 209

[Basic Recording Methods](#) on page 290

Creating Audio Events

You can create audio events by recording or importing audio into the **Project** window.

PROCEDURE

- Do one of the following:
 - Record some audio.
 - Select **File > Import > Audio File** to import an audio file from your hard disk or any external storage device.
 - Select **File > Import > Audio CD** to import an audio file from an audio CD.
 - Select **File > Import > Audio from Video File** to import the audio from a video file on your hard disk or any external storage device.
 - Drag an audio file from the **MediaBay**, the **Audio Part Editor**, or the **Sample Editor**, and drop it in the event display.
 - Copy an event from a different Nuendo project and paste it in the event display.
-

RELATED LINKS

- [Basic Recording Methods](#) on page 290
- [Audio File Import](#) on page 311
- [Importing Audio CD Tracks](#) on page 314
- [Importing Audio from Video Files](#) on page 317
- [MediaBay and Media Rack](#) on page 697
- [Audio Part Editor](#) on page 639
- [Sample Editor](#) on page 574

Creating New Files From Events

An audio event plays a section of an audio clip, which in turn refers to one or more audio files on the hard disk. However, you can create a new file that consists only of the section that is played by the event.

PROCEDURE

1. Select one or several audio events.
2. Set up fade in, fade out, and event volume.
These settings will be applied to the new file.
3. Select **Audio > Bounce Selection**.
You are asked whether you want to replace the selected event or not.
4. Do one of the following:
 - To create a new file that only contains the audio in the original event, click **Replace**.
 - To create a new file and add a clip for the new file to the **Pool**, click **No**.

RESULT

If you clicked **Replace**, a clip for the new file is added to the **Pool**, and the original event is replaced by a new event playing the new clip.

If you clicked **No**, the original event is not replaced.

NOTE

You can also apply the **Bounce Selection** function to audio parts. In that case, the audio from all events in the part is combined to a single audio file. If you select **Replace** when asked, the part is replaced with a single audio event playing a clip of the new file.

RELATED LINKS

- [Event-Based Fades](#) on page 335

Audio Files and Audio Clips

In Nuendo, audio editing and processing are non-destructive.

When you edit or process audio in the **Project** window, the audio file on the hard disk remains untouched. Instead, your changes are saved to an audio clip that is automatically created on import or during recording, and that refers to the audio file. This allows you to undo changes or revert to the original version.

If you apply processing to a specific section of an audio clip, a new audio file that contains only this section is created. The processing is applied to the new audio file only and the audio clip is automatically adjusted, so that it refers both to the original file and to the new, processed file. During playback, the program will switch between the original file and the processed file at the correct positions. You will hear this as a single recording, with processing applied to one section only.

This allows you to undo processing at a later stage, and to apply different processing to different audio clips that refer to the same original file.

You can view and edit audio clips in the **Pool**.

RELATED LINKS

[Pool](#) on page 675

[Audio Regions](#) on page 211

[Replacing Clips in Events](#) on page 210

Clip Packages

Clip packages are sound combinations that you create by arranging, editing, and grouping several audio events or parts in the **Project** window and saving them as clip packages.

Clip packages are shown in the **Pool** and in the **MediaBay** from where you can import them into several projects.

Clip packages are container files that include all the selected audio material as opposed to mere file references. This is useful for layered sounds such as explosions, background atmospheres, or effect sounds.

- Clip packages contain copies of the audio files. Any offline processes you applied to the audio are saved in the file and cannot be modified or undone later.
- Clip packages contain volume and pan automation of the audio, as well as any fades, crossfades and volume envelopes. Insert or send effects or EQ settings of the corresponding tracks are not included.
- Clip packages contain only the portion of an audio clip that is actually used by an event. This section is extended by 2 seconds at the beginning and the end of the event so that you are still able to adjust the event borders.

NOTE

- Audio clips set to musical time base are copied in entirety into the clip package.
- If a clip package contains audio material from VST Sound archives, this is not copied into the clip package. In this case, a reference to the original VST Sound archive is saved. If you want to use these clip packages in another project, you must copy the referred VST Sound files.

RELATED LINKS

[Importing Clip Packages](#) on page 318

[Exporting Audio Parts and Events as Clip Packages](#) on page 246

[Defining the Track Time Base](#) on page 193

[Pool Window](#) on page 675

Replacing Clips in Events

You can replace the clips in audio events.

PROCEDURE

- Do one of the following:
 - Hold down **Shift**, drag an audio file from the File Explorer/macOS Finder, and drop it on the event.
 - Click a clip in the **Pool**, hold down **Shift**, and drop it on the event.

RESULT

The clip in the event is replaced. However, the event edits remain unchanged. If the new clip is shorter than the replaced clip, the length of the event is adapted. If the new clip is longer than the replaced clip, the length of the event stays the same.

RELATED LINKS

[Inserting Clips into a Project via Drag and Drop](#) on page 682

Audio Regions

Nuendo allows you to create audio regions within audio clips to mark important sections in the audio.

You can view audio regions in the **Pool**. You can create and edit them in the **Sample Editor**.

NOTE

If you want to use one audio file in different contexts, or if you want to create several loops from one audio file, convert the corresponding regions of the audio clip to events and bounce them into separate audio files. This is necessary because different events that refer to the same clip access the same clip information.

RELATED LINKS

[Pool](#) on page 675

[Regions List](#) on page 591

Creating Regions

You can create regions from several selected audio events or from selection ranges.

PROCEDURE

1. Select several audio events or selection ranges.
 2. Select **Audio > Advanced > Event or Range as Region**.
 3. In the **Create Regions** dialog, enter a name for the regions, and click **OK**.
-

RESULT

A region is created in the corresponding clip, with the start and end position of the region determined by the start and end position of the event or selection range within the clip.

RELATED LINKS

[Creating Regions](#) on page 591

Creating Events from Regions

You can create events from regions. These replace the original event.

PROCEDURE

1. Select an audio event whose clip contains regions within the boundaries of the event.
 2. Select **Audio > Advanced > Events from Regions**.
-

RESULT

The original event is removed and replaced by events positioned and sized according to the regions.

MIDI Events

MIDI events are created automatically when you record or import MIDI in the **Project** window.

The **In-Place Editor** allows you to view and edit MIDI events in the **Project** window. You can also view and edit MIDI events in the **Key Editor**, the **Drum Editor**, **List Editor**, or the **Score Editor**.

RELATED LINKS

- [Project Window](#) on page 46
- [In-Place Editor](#) on page 1012
- [List Editor](#) on page 998
- [Key Editor](#) on page 945
- [Drum Editor](#) on page 979
- [Basic Recording Methods](#) on page 290

Creating MIDI Events

You can create MIDI events by recording or importing MIDI into the **Project** window.

PROCEDURE

- Do one of the following:
 - Record MIDI.
 - Select **File > Import > MIDI File** to import a MIDI file from your hard disk.
 - Drag a MIDI file from the File Explorer/macOS Finder, from one of the MIDI editors, or from the **MediaBay**, and drop it in the event display.
 - Copy an event from a different Nuendo project and paste it in the event display.
-

RELATED LINKS

- [Basic Recording Methods](#) on page 290
- [Importing MIDI Files](#) on page 320
- [MIDI Editors](#) on page 913
- [MediaBay and Media Rack](#) on page 697

Parts

Parts are containers for MIDI or audio events, and for tracks.

RELATED LINKS

- [Audio Parts](#) on page 212
- [MIDI Parts](#) on page 213
- [Folder Parts](#) on page 213

Audio Parts

Audio parts are containers for audio events. If you want to treat several audio events as one unit in the **Project** window, you can convert them to a part.

You can create audio parts in the following ways:

- Select the **Draw** tool and draw on the audio track.
- Press **Alt/Opt**, select the **Object Selection** tool, and draw on the audio track.

- Select the **Object Selection** tool and double-click on the audio track, between the left and right locator.
- Select several audio events on an audio track and select **Audio > Events to Part**.

NOTE

To make the events appear as independent objects on the track again, select the part and select **Audio > Dissolve Part**.

RELATED LINKS

[Audio Part Editor](#) on page 639

MIDI Parts

A MIDI part is automatically created when you record. It contains the recorded events.

However, you can also create empty MIDI parts in the following ways:

- Select the **Draw** tool and draw on the MIDI track.
- Press **Alt/Opt**, select the **Object Selection** tool and draw on the MIDI track.
- Select the **Object Selection** tool and double-click on the MIDI track, between the left and right locator.

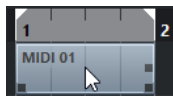

Folder Parts

A folder part is a graphic representation of events and parts on the tracks in the folder.

Folder parts indicate the time position as well as the vertical track position. If part colors are used, these are also shown in the folder part.

Any editing that you perform to a folder part affects all the events and parts it contains. Tracks inside a folder can be edited as one entity.

NOTE

If you want to edit the individual tracks within the folder, you can double-click the folder part. This opens the editors for the events and parts that are present on the tracks.

RELATED LINKS

[Event Colors Menu](#) on page 914

[Group Editing Mode](#) on page 238

Editing Techniques for Parts and Events

This section describes techniques for editing in the **Project** window. If not explicitly stated, all descriptions apply to both events and parts, even though we use the term event for convenience.

In the **Project** window, you can edit events using the following techniques:

- By selecting and using one of the tools in the **Project** window toolbar.

NOTE

Some editing tools feature additional functions if you press modifier keys. You can customize the default modifier keys in the **Preferences** dialog (**Editing—Tool Modifiers** page).

- By opening the **Edit** menu and selecting one of the functions.
- By editing on the info line.
- By using a key command.

NOTE

Snap is taken into account.

RELATED LINKS

[Editing - Tool Modifiers](#) on page 1361

Auditioning Audio Parts and Events

You can audition audio parts and events in the **Project** window by using the **Audition** tool.

PROCEDURE

1. Click **Play** and select **Play**.
 2. Click where you want playback to start, and keep the mouse button pressed.
 3. Optional: Select **Media > MediaBay**, and in the **Previewer** section, adjust the **Preview Level**.
-

RESULT

The track on which you click is played back, starting at the click position. Playback is stopped when you release the mouse button.

NOTE

When auditioning, audio is routed directly to the **Control Room** if the **Control Room** is activated. If the **Control Room** is deactivated, the audio is routed to the default output bus, bypassing the audio channel's settings, effects and EQs.

RELATED LINKS

[Project Window Toolbar](#) on page 48

[Previewer Section](#) on page 718

Scrubbing

The **Scrub** tool allows you to locate positions in events by playing back, forwards or backwards.

PROCEDURE

1. Click **Play**.
 2. Click again to open a pop-up menu.
 3. Select **Scrub**.
 4. Click the event and keep the mouse button pressed.
 5. Drag to the left or right.
-

RESULT

The project cursor moves correspondingly and the event is played back. The speed and the pitch of the playback depend on how fast you move the mouse.

NOTE

Insert effects are bypassed when scrubbing with the mouse.

RELATED LINKS

[Project Window Toolbar](#) on page 48

Scrub Tool

Scrubbing can be quite a burden on your system. If playback problems occur, open the **Preferences** dialog (**Transport—Scrub** page), and deactivate **Use High Quality Scrub Mode**. This lowers the resampling quality, but makes scrubbing less demanding on the processor, especially in large projects.

In the **Preferences** dialog (**Transport—Scrub** page), you can also adjust the **Scrub** volume.

Selecting with the Object Selection Tool

PROCEDURE

1. Click **Object Selection**.
2. In the event display, click the events that you want to select.

NOTE

You can also use the **Up Arrow**, **Down Arrow**, **Left Arrow** or **Right Arrow** keys on the computer keyboard to select the event on the upper or lower track or the previous or next event on the same track.

RELATED LINKS

[Project Window Toolbar](#) on page 48

Combine Selection Tools Mode

The **Combine Selection Tools** mode allows you to combine the **Object Selection** tool and the **Range Selection** tool. This is useful in situations where you often switch between these tools.

If you activate **Combine Selection Tools** on the **Project** window toolbar and the track height is set to at least 2 rows, the vertical track height of each track is divided into two areas. The mouse pointer changes automatically from **Object Selection** to **Range Selection** tool and vice versa according to the track area where you click.

- If you move the mouse pointer to the upper area of the track, the **Range Selection** tool is activated, and you can select ranges that are independent from event and part boundaries.

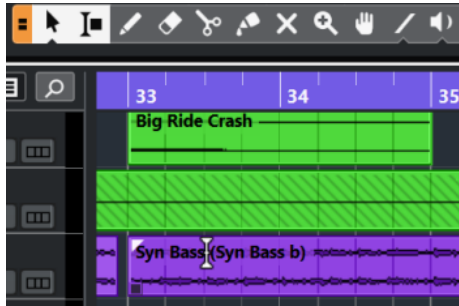

- If you move the mouse pointer to the lower area of the track, the **Object Selection** tool is activated, and you can select entire events or parts.

NOTE

You can also activate/deactivate the **Combine Selection Tools** mode by pressing **Alt - Shift - 1**.

RELATED LINKS

[Project Window Toolbar](#) on page 48

[Setting the Track Height](#) on page 185

[Creating a Selection Range](#) on page 248

[Resizing Events with the Object Selection Tool - Normal Sizing](#) on page 229

[Resizing Events with the Object Selection Tool - Sizing Moves Contents](#) on page 229

[Resizing Events with the Object Selection Tool - Sizing Applies Time Stretch](#) on page 230

Select Submenu

If the **Object Selection** tool is selected, the **Select** submenu features specific options for selecting events in the **Project** window.

- To open the **Select** submenu, select **Edit > Select**.

All

Selects all events in the **Project** window.

None

Deselects all events in the **Project** window.

Invert

Inverts the selection. All selected events are deselected and all events that were not selected are selected instead.

In Loop

Selects all events that are partly or wholly between the left and right locator.

From Start to Cursor

Selects all events that end to the left of the project cursor.

From Cursor to End

Selects all events that start to the right of the project cursor.

Equal Pitch all Octaves/Equal Pitch same Octave

These functions are available in the MIDI editors and the **Sample Editor**.

Select Controllers in Note Range

This function is available in the MIDI editors.

All on Selected Tracks

Selects all events on the selected track.

Events under Cursor

Automatically selects all events on the selected tracks that are touched by the project cursor.

Select Event

This function is available in the **Sample Editor**.

Left Selection Side to Cursor/Right Selection Side to Cursor

These functions are only used for range selection editing.

NOTE

When the **Range Selection** tool is selected, the **Select** submenu features different functions.

RELATED LINKS

[Select Menu for Selection Ranges](#) on page 248

[Range Editing](#) on page 587

Removing Events

You can remove events from the **Project** window.

PROCEDURE

- To remove an event from the **Project** window, do one of the following:
 - On the **Project** window toolbar, activate **Erase** and click the event.
 - In the event display, select the events and select **Edit > Delete**.
 - In the event display, select the events and press **Backspace**.
-

RELATED LINKS

[Project Window Toolbar](#) on page 48

Event Movement Options

Nuendo provides several methods to move events in the **Project** window.

You can move events using any of the following methods:

- Use the **Object Selection** tool.
- Use the **Nudge** tool.
- Select **Edit > Move to** and select one of the options.
- Select the event and edit the start position on the info line.
- Select multiple events and use the **Set Spacer Between Selected Events** function.

RELATED LINKS

[Moving Events with the Object Selection Tool](#) on page 218

[Moving Events with the Nudge Buttons](#) on page 218

[Move to Submenu](#) on page 218

[Moving Events via the Info Line](#) on page 219

[Setting Spacers between Events](#) on page 219

Moving Events with the Object Selection Tool

You can select one or several events with the **Object Selection** tool and drag them to a new position.

PROCEDURE

1. Select **Object Selection** .
2. Click the events that you want to move and drag them to a new position.

NOTE

You can only drag events to tracks of the same type. If you hold down **Ctrl/Cmd** while dragging, you can restrict the movement either horizontally or vertically.

RESULT

The events are moved. If you moved several events, their relative positions are kept.

NOTE

To avoid accidentally moving events when you click them in the **Project** window, the response when you move an event by dragging is slightly delayed. You can adjust this delay with the **Drag Delay** setting in the **Preferences** dialog (**Editing** page).

Moving Events with the Nudge Buttons

You can move one or several selected events by using the nudge buttons on the **Project** window toolbar.

PROCEDURE

1. Right-click the **Project** window toolbar and activate **Nudge Palette**.
The nudge buttons become available on the toolbar.

 2. Select the events that you want to move, and click **Move Left** or **Move Right**.
The selected events or parts are moved.
-

RELATED LINKS

[Project Window Toolbar](#) on page 48

Move to Submenu

If the **Object Selection** tool is selected, the **Move to** submenu features options for moving events to specific positions in the **Project** window.

- To open the **Move to** submenu, select **Edit > Move to**.

The following options are available:

Cursor

Moves the selected event to the project cursor position. If you selected several events on the same track, the following events keep their relative position.

Origin

Moves the selected events to the positions at which they were originally recorded.

Selected Track

Moves the selected events to separate tracks, starting on the selected track. The events are placed at their current positions.

Front/Back

Moves the selected events to the front or back, respectively. This is useful if you have overlapping audio events and you want to play back another event.

Moving Events via the Info Line

You can move a selected event by changing its start value on the info line.

PROCEDURE

1. Select the event that you want to move.
2. On the info line, double-click the **Start** field and enter a new value for the event start.

RESULT

The event is moved by the set value.

Setting Spacers between Events

You can rearrange multiple events on a track so that they are at a specified distance from each other.

PREREQUISITE

- A track contains multiple events.
- The events are not locked.

PROCEDURE

1. Select all events that you want to rearrange.
2. Select **Edit > Functions > Set Spacer between Selected Events**.
3. Set the **Spacer in Seconds** value.
4. Click **OK**.

RESULT

All selected events on the track are at the specified distance from each other.

NOTE

- Grouped events are handled like single events.
- This function does not work for automation and signature tracks.

RELATED LINKS

[Locking Events](#) on page 238

[Grouped Events](#) on page 237

Audio Alignment

The **Audio Alignment** tool allows you to automatically match the timing of similar audio events or selection ranges that you want to play back simultaneously.

Audio Alignment allows you to match the timing of different instrument or vocal tracks. You can also solve phasing problems that occur when using different microphones on the same take. In postproduction contexts, you can match the timing of a voice recording take or an alternative take to the production sound, for example.

The tool analyzes the audio of overlapping events that you have selected for aligning and either uses the warping function of the **Sample Editor** for time stretching or shifts the audio.

The **Audio Alignment Panel** provides a **Match Words** option for aligning audio that contains identical wording. Its algorithm detects phonemes and syllables and allows for an exact word-to-word synchronization.

The **Prefer Time Shifting** option is especially suited for audio that results from the same recording, for example, in case of a multiple microphone recording. It avoids time stretching if possible. However, if necessary, time stretching is still used.

NOTE

- If time stretching is necessary, **Audio Alignment** uses the warping algorithm that is selected in the **Sample Editor**.
- If the audio already contains real-time effects, **Audio Alignment** allows you to bounce it first, keeping the existing effects, or to overwrite the existing processing.
- If the audio is in **Musical Mode**, you must bounce it first.
- **Audio Alignment** only works as intended if the audio to be aligned and the project have the same sample rate.

RELATED LINKS

- [Algorithm Presets](#) on page 605
- [Aligning the Audio of Events](#) on page 221
- [Audio Alignment Panel](#) on page 220
- [Musical Mode](#) on page 606

Audio Alignment Panel

On the **Audio Alignment Panel**, you can select your reference and target events, and make settings for analyzing and aligning the audio.

To open the **Audio Alignment Panel**, do one of the following:

- Click **Open Audio Alignment Panel** on the **Project** window toolbar.
- Select **Audio > Open Audio Alignment Panel**.

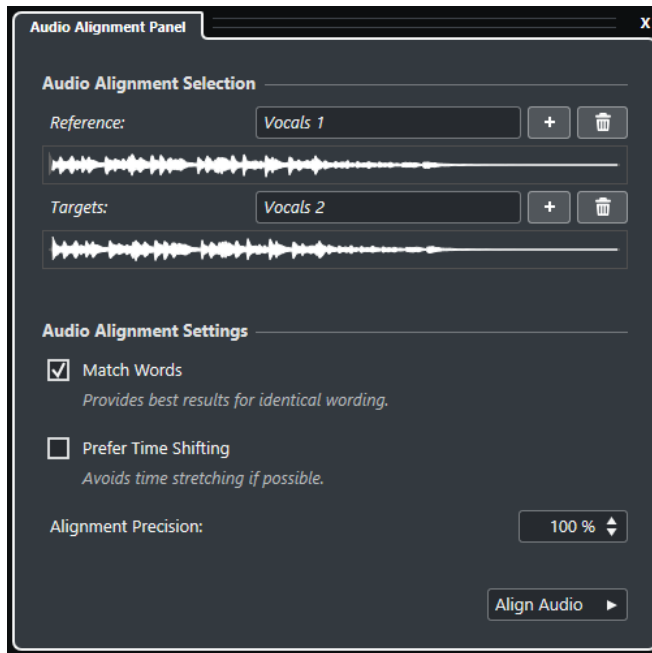

Audio Alignment Selection

In this section, you define the reference and target events or selection ranges for the alignment operation. In the waveform displays, the overlapping time range between reference and target is highlighted.

If multiple targets are selected, a pop-up menu allows you to toggle between their waveforms.

Audio Alignment Settings

Allow you to activate/deactivate options for analyzing and aligning.

- The **Match Words** option analyzes phonemes and syllables and allows for an exact word-to-word synchronization. This option provides best results if the wording on the aligned events is identical.
- The **Prefer Time Shifting** option is especially suited for aligning audio that results from the same recording, for example, in case of a multiple microphone recording. It avoids time stretching if possible. However, if necessary, time stretching is still used.
- **Alignment Precision** allows you to set the degree of alignment. Reducing the precision can help to retain a more natural sound.

Align Audio

Starts the alignment operation.

Aligning the Audio of Events

The **Audio Alignment** tool allows you to automatically align the audio of overlapping audio events or selection ranges on different tracks.

PREREQUISITE

- Your project contains two or more audio events, located on different tracks and overlapping in time.
- The audio that you want to align with the reference is not modified by **VariAudio** or **AudioWarp** operations.

NOTE

- If the audio already contains real-time effects, the **Audio Alignment** tool allows you to bounce it first, keeping the existing effects, or overwrite the existing processing.
 - If the audio is in **Musical Mode**, you must bounce it first.
-

PROCEDURE

1. Select the event or range that you want to use as alignment reference.
2. On the **Project** window toolbar, click **Open Audio Alignment Panel**.
3. On the **Audio Alignment Panel**, click **Add Selection as Alignment Reference**.
4. Select one or multiple events that you want to align with the reference.
5. On the **Audio Alignment Panel**, click **Add Selection as Alignment Target**.
The overlapping time range between reference and target is highlighted in the corresponding waveforms. If multiple targets are selected, you can toggle their waveforms using the pop-up menu.

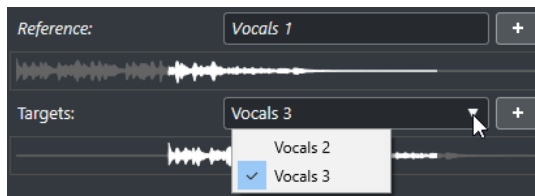

6. In the **Audio Alignment Settings** section, make your changes.
 7. Click **Align Audio** to start the processing.
The target events are processed.
-

RESULT

The audio of the target events is aligned with the reference event within the time range where the events overlap.

AFTER COMPLETING THIS TASK

To visualize the result of the alignment in the **Sample Editor**, select the reference and target events and activate **Show All Selected Audio Events** in the **Sample Editor** toolbar.

If the result of the time stretching does not meet your expectations, you can change the warping algorithm on the **Sample Editor** toolbar. This algorithm change is instantly applied to the audio. Alternatively, you can use the **Free Warp** tool to align the audio events.

RELATED LINKS

- [Sample Editor Toolbar](#) on page 576
- [Algorithm Presets](#) on page 605
- [Time Stretch and Pitch Shift Algorithms](#) on page 559
- [Free Warp](#) on page 610
- [Audio Alignment Panel](#) on page 220

Modifiers for Aligning to Parts, Events, and Selection Ranges

You can use modifiers to align audio events or parts to events.

The following modifiers are available:



Use **Ctrl/Cmd** to align the start of the audio event/part to the start of the selected event, part or range.

This function is available when you move the mouse to the beginning of the non-selected event.



Use **Ctrl/Cmd - Alt/Opt** to copy the audio event/part and align its start to the start of the selected event, part or range.

This function is available when you move the mouse to the beginning of the non-selected event.



Use **Ctrl/Cmd** to align the end of the audio event/part to the start of the selected event, part or range.

This function is available when you move the mouse to the end of the non-selected event.



Use **Ctrl/Cmd - Alt/Opt** to copy the audio event/part and align its end to the start of the selected event, part or range.

This function is available when you move the mouse to the end of the non-selected event.



Use **Ctrl/Cmd - Shift** to align the start of the audio event/part to the end of the selected event, part or range.

This function is available when you move the mouse to the beginning of the non-selected event.



Use **Ctrl/Cmd - Shift - Alt/Opt** to copy the audio event/part and align its start to the end of the selected event, part or range.

This function is available when you move the mouse to the beginning of the non-selected event.



Use **Ctrl/Cmd - Shift** to align the end of the audio event/part to the end of the selected event, part or range.

This function is available when you move the mouse to the end of the non-selected event.



Use **Ctrl/Cmd - Shift - Alt/Opt** to copy the audio event/part and align its end to the end of the selected event, part or range.

This function is available when you move the mouse to the end of the non-selected event.

For aligning audio events or parts to the cursor, the following modifiers are available:



Use **Ctrl/Cmd** to align the start of the audio event/part to the cursor.

This function is available when you move the mouse to the beginning of the non-selected event.



Use **Ctrl/Cmd - Alt/Opt** to copy the audio event/part and align its start to the cursor.

This function is available when you move the mouse to the beginning of the non-selected event.



Use **Ctrl/Cmd** to align the end of the audio event/part to the cursor.

This function is available when you move the mouse to the end of the non-selected event.



Use **Ctrl/Cmd - Alt/Opt** to copy the audio event/part and align its end to the cursor. This function is available when you move the mouse to the end of the non-selected event.

NOTE

You can change the modifiers in the **Preferences** dialog (**Editing-Tool Modifiers** page).

Aligning Audio Events or Parts to other Audio Events or Parts

You can align audio events or parts to other audio events or parts.

PROCEDURE

1. Select an event or part that you want to take as a reference for aligning.
2. Point on the audio event or part you want to move, press one of the modifiers and click.

RESULT

The mouse pointer changes its shape and the audio event or part is aligned with the selected part or event.

NOTE

If the snap point is set, it is used as a reference when you align events.

RELATED LINKS

[Modifiers for Aligning to Parts, Events, and Selection Ranges](#) on page 222
[Audio Alignment](#) on page 220

Aligning Audio Events or Parts to Selection Ranges

You can align audio events or parts to selection ranges.

PROCEDURE

1. Make a selection range on any track.
The selection is taken as a reference for aligning.
2. Point on an audio event or part, press one of the modifiers and click.
The mouse pointer changes its shape and the audio event or part is aligned with the selection range.

NOTE

If the snap point is set, it is used as a reference when you align events.

RELATED LINKS

[Modifiers for Aligning to Parts, Events, and Selection Ranges](#) on page 222

Aligning Audio Events or Parts to the Cursor

You can align audio events or parts to the cursor.

PROCEDURE

1. Set the cursor to the position where you want to move the audio part or event.
This will be taken as a reference for aligning.
2. Deselect everything in your project.
3. Select the **Object Selection** tool and point on an audio event or part, press one of the modifiers and click.

The mouse pointer changes its shape and the audio event or part is aligned with the cursor.

NOTE

If the snap point is set, it is used as a reference when you align events.

RELATED LINKS

[Modifiers for Aligning to Parts, Events, and Selection Ranges](#) on page 222

Renaming Events

PROCEDURE

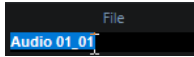
- Do one of the following:
 - Select the events, select **Edit > Rename Objects**, and select one of the renaming options.
 - Select the events and type in a new name in the **File** field on the info line.

 - Change the track name, hold down a modifier key, and press **Return** to rename all events according to the track.
 - Use the **Rename Events from List** dialog to rename parts and events that are selected in the **Project** window.
-

RELATED LINKS

[Renaming Clips or Regions in the Pool](#) on page 680

[Renaming Events from List](#) on page 225

Renaming Events from List

You can rename audio events, audio parts, and MIDI parts that you recorded in Nuendo so that they match the names of a list, created with an external text editor. This way, you can also rename markers.

PREREQUISITE

You have a list in .csv or .txt file format, for example, a script list that allows you to match the dialog with the recorded events or parts. You have recorded audio events or MIDI parts and arranged them so that they match the order of the script list.

PROCEDURE

1. In the **Project** window, select the events or parts that you want to rename.

2. Select **Edit > Rename Events from List**.

The **Rename Events from List** dialog opens, and the names of the selected events or parts are listed in the left column.

3. Click **Load List**, and in the file dialog, navigate to the script list, select it, and click **Open**.

NOTE

Alternatively, you can copy content from a text editor and paste it in the **Rename Events from List** dialog.

4. Locate the column that shows the file names that you want to use, and click the column header.
The column header is highlighted.
 5. Optional: Modify, rearrange, or add list content.
 6. Optional: In the **Rename Events from List** dialog, click **Locate Event** to the left of an event, and on the **Transport** panel, click **Start**.
This plays back the event and allows you to verify if it matches the name in the script list.
 7. Click **Rename**.
-

RESULT

The recorded audio events are renamed according to the imported script list.

AFTER COMPLETING THIS TASK

Export the audio events and select a naming scheme that uses the event names. Apply offline processing to the exported events, if required.

RELATED LINKS

[Rename Events from List Dialog](#) on page 226

[Export Audio Assets to a Game Audio Engine](#) on page 572

[Direct Offline Processing](#) on page 534

Rename Events from List Dialog

The **Rename Events from List** dialog allows you to rename events and parts that are selected in the **Project** window.

- To open the **Rename Events from List** dialog, select an event or a part in the **Project** window, and select **Edit > Rename Events from List**.

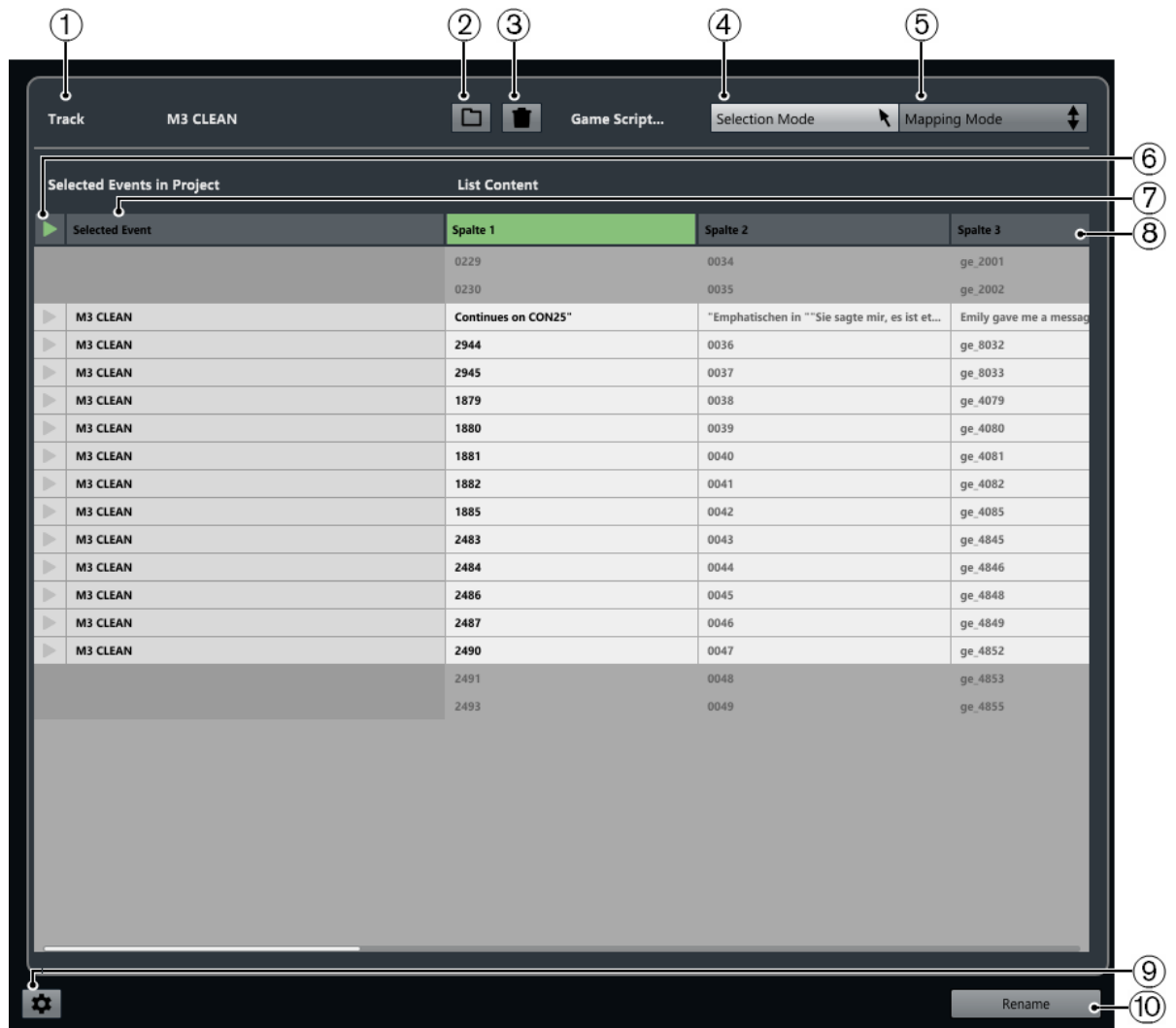

- 1 **Track**
Displays the name of the track of the selected events/parts.
- 2 **Load List**
Allows you to load a .csv or a .txt file that contains a dialog list.
- 3 **Clear List**
Removes the loaded list.
- 4 **Selection Mode**
Allows you to select list entries for editing.
 - Press **Delete** to delete entries.
 - Double-click an entry to change its text.
- 5 **Mapping Mode**
Allows you to slide the list content up or down in relation to the list of the selected events/parts in the project. This changes the mapping.
- 6 **Locate Event**
Moves the project cursor to the start of the event/part in the **Project** window.
- 7 **Selected Event**
Displays the names of the events/parts that you selected in the **Project** window.
- 8 **List Content**
Shows the content of the imported file.

- Drag to rearrange the order of the columns.
- Right-click a column header and deactivate the corresponding column in the pop-up menu to hide columns.
- Double-click to modify the list content.
- Copy content from a text editor, for example, Microsoft Excel or Apache OpenOffice, to add list content.

9 Open Rename Settings

Opens the rename settings.

10 Rename

Applies the names of the list to the selected events/parts.

RELATED LINKS

[Rename Settings](#) on page 228

Rename Settings

Allows you to set how selected events/parts should be renamed.

- To open the rename settings, select an event or a part in the **Project** window, select **Edit > Rename Events from List**, and click **Open Rename Settings**.



- **Ignore File Extension**
Activate this if you do not want the file extension to be shown.
- **Interpret First Row as Header**
Activate this if you want the first row of the loaded script list to be interpreted as a header.
- **Ignore Snippets Shorter Than**
Activate this to specify a minimum length that the events/parts must have to be shown in the list.
- **Handle Adjacent or Overlapping Events as One**
Activate this if adjacent or overlapping events should be considered as one event and thus receive the same name.

Event Resize Options

You can resize events by moving their start or end positions individually.

To resize events, you can use the **Object Selection**, the **Scrub** tool or the **Trim** tools on the **Nudge** palette.

Resizing also works, if the **Combine Selection Tools** mode is active.

IMPORTANT

When resizing events, automation data is not taken into account.

RELATED LINKS

- [Combine Selection Tools Mode](#) on page 215
- [Resizing Events with the Object Selection Tool - Normal Sizing](#) on page 229
- [Resizing Events with the Object Selection Tool - Sizing Moves Contents](#) on page 229
- [Resizing Events with the Object Selection Tool - Sizing Applies Time Stretch](#) on page 230
- [Resizing Events with the Trim Tools](#) on page 230
- [Resizing Events with the Scrub Tool](#) on page 231
- [Snap Function](#) on page 89

Resizing Events with the Object Selection Tool - Normal Sizing

You can move the start or end point of the event.

PROCEDURE

1. Select **Object Selection**.
2. Click the **Object Selection** tool again, and select **Normal Sizing** from the pop-up menu.
3. Click and drag the lower left or right corner of the event.



RESULT

The event is resized and according to where you dragged, more or less of the content is revealed. If several events are selected, they are all resized in the same way.

RELATED LINKS

- [Project Window Toolbar](#) on page 48

Resizing Events with the Object Selection Tool - Sizing Moves Contents

You can move the start or end point of the event and move the content.

PROCEDURE

1. Select **Object Selection**.
2. Click the **Object Selection** tool again, and select **Sizing Moves Contents** from the pop-up menu.
3. Click and drag the lower left or right corner of the event.



RESULT

The event is resized and the content follows. If several events are selected, they are all resized in the same way.

RELATED LINKS

- [Project Window Toolbar](#) on page 48

Resizing Events with the Object Selection Tool - Sizing Applies Time Stretch

You can move the start or end point of the event and time stretch the content to fit the new event length.

PROCEDURE

1. Select **Object Selection**.
2. Click the **Object Selection** tool again, and select **Sizing Applies Time Stretch** from the pop-up menu.
3. Click and drag the lower left or right corner of the event.

RESULT

The part is stretched or compressed to fit the new length.

- If you resize MIDI parts, the note events are stretched (moved and resized). Controller data and Note Expression data are stretched, too.
- If you resize audio parts, the events are moved, and the referenced audio files are time stretched to fit the new length.
If several events are selected, they are all resized in the same way.

RELATED LINKS

- [Time Stretch](#) on page 555
- [Project Window Toolbar](#) on page 48

Resizing Events with the Trim Tools

You can move the start or end point of the event by the amount set on the **Grid Type** pop-up menu.

PREREQUISITE

The **Object Selection** tool is set to **Normal Sizing** or to **Sizing Moves Contents**.

PROCEDURE

1. Right-click the **Project** window toolbar and activate **Nudge Palette**.
The nudge buttons become available on the toolbar.

2. Select the event.
3. Do one of the following:
 - Click **Trim Start Left**.
 - Click **Trim Start Right**.
 - Click **Trim End Left**.
 - Click **Trim End Right**.

RESULT

The start or end position of the selected events are moved by the amount set on the **Grid Type** pop-up menu.

RELATED LINKS

- [Project Window Toolbar](#) on page 48

Resizing Events with the Scrub Tool

You can scrub the event when moving the start or end point of the event.

PROCEDURE

1. Click **Play**.
2. Click **Play** again to open a pop-up menu.
3. Select **Scrub**.
4. Click and drag the lower left or right corner of the event.

RESULT

The event is resized and you get an acoustic feedback while dragging.

RELATED LINKS

[Project Window Toolbar](#) on page 48

Splitting Events

PROCEDURE

- Do one of the following:
 - Select **Split** and click the event that you want to split.
 - Select **Object Selection**, hold down **Alt/Opt** and click the event.
 - Move the project cursor to the position where you want to split the events, and select **Edit > Functions > Split at Cursor**.

NOTE

This splits all events on all tracks that are intersected by the project cursor. If you select specific events, only these events are split.

- Set up the left and right locators at the position where you want to split the events, and select **Edit > Functions > Split Loop**.

NOTE

This splits all events on all tracks that are intersected by the locators. If you select specific events, only these events are split.

RESULT

The events are split.

NOTE

If you split a MIDI part so that the split position intersects one or several MIDI notes and **Split MIDI Events** is activated in the **Preferences** dialog (**Editing—MIDI** page), the intersected notes are split and new notes are created at the beginning of the second part. If it is deactivated, the notes remain in the first part, but stick out after the end of the part.

RELATED LINKS

[Project Window Toolbar](#) on page 48

Splitting Events Repeatedly

You can split events repeatedly into multiple events of equal size.

PROCEDURE

- Select **Split** , hold down **Alt/Opt** and click the event where you want to make the first split.

RESULT

The event is automatically split into as many equal events as the length of the original event allows.

Split Multi-Channel Audio

The **Split Channels** function allows you to extract all or single channels from multi-channel audio and to add them to your project.

This is useful, for example, to extract a microphone subchannel from a polyphonic WAV file or to keep only the left or right channel from a stereo recording.

When splitting channels, the following applies:

- You can split several multi-channel events or clips at once.
- The original multi-channel events in your project are replaced by mono events on lanes of the corresponding tracks.
- You can use the **Track Info** metadata of multi-channel files as file name suffix for the split channel files by selecting **audio-(Track Info).wav** as **Name Format**.

RELATED LINKS

[Splitting Multi-Channel Audio into Mono Files](#) on page 232

[Split Channels Dialog](#) on page 233

Splitting Multi-Channel Audio into Mono Files

You can split interleaved multi-channel audio into separate mono files. Splitting multi-channel events in your project replaces the original event by mono events on lanes.

PROCEDURE

1. Select a multi-channel audio event in the **Project** window or a multi-channel clip in the **Pool** and select **Audio > Split Channels**.

NOTE

Alternatively, you can select **Split Channels** from the context menu of the event display or the **Pool**.

2. In the **Split Channels** dialog, change the settings as required.
3. Click **OK**.

RESULT

In the **Project** window, the multi-channel event is replaced by mono events on lanes of the same track, each containing a discrete channel of the original multi-channel audio. In the **Pool**, the original multi-channel clip is retained and the created mono clips are added.

AFTER COMPLETING THIS TASK

- To convert lanes into new tracks, right-click a track and select **Create Tracks from Lanes**.

- To move the created events to other tracks, select **Edit > Move to > Selected Track** or use the corresponding key command.

RELATED LINKS

[Split Channels Dialog](#) on page 233

Split Channels Dialog

The **Split Channels** dialog provides several options to split multi-channel WAV files into separate mono files.

To open the **Split Channels** dialog, do one of the following:

- Select **Audio > Split Channels**.
- Select **Split Channels** from the context menu of the event display or the **Pool**.

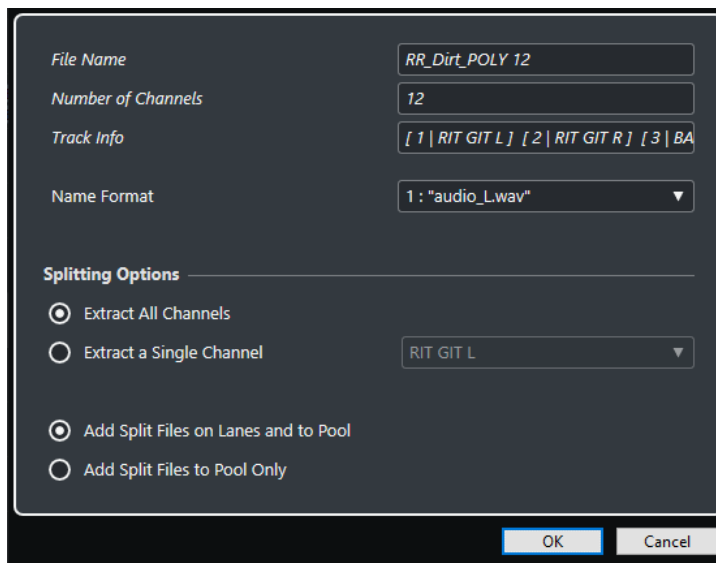

File Name

Shows the file name of the multi-channel file that you want to split.

Number of Channels

Shows the number of channels of the multi-channel file.

Track Info

Shows the channel names of the multi-channel file.

Name Format

Allows you to specify the naming scheme for the split channel files.

Extract All Channels

Adds all channels of the multi-channel file as mono files to your project.

Extract a Single Channel

Allows you to add a single channel of the multi-channel file to your project.

Add Split Files on Lanes and to Pool

If this option is activated, the split channel files are added to the **Pool** and inserted on lanes on the corresponding track. The original multi-channel event is removed from the track.

Add Split Files to Pool Only

If this option is activated, the split channel files are added to the **Pool** only. The original multi-channel event remains in your project.

Using Cut Head and Cut Tail

You can cut everything to the left or right of the cursor or a selected range.

PROCEDURE

- Do one of the following:
 - Select **Edit > Range > Cut Head** to delete everything to the left of the cursor/selection range.
 - Select **Edit > Range > Cut Tail** to delete everything to the right of the cursor/selection range.
-

Gluing Events

In the **Project** window, you can glue two or more events on the same track.

PROCEDURE

- Do one of the following:
 - Select the events that you want to glue, and select **Edit > Glue**.
 - Select **Glue** and click the event that you want to glue to the next event.
 - Select **Glue**, hold down **Alt/Opt**, and click the event that you want to glue to all following events.
-

RESULT

The events are glued together.

NOTE

If you first split an audio event and then glue the parts together again, an event is created. In any other case, a part is created.

RELATED LINKS

[Project Window Toolbar](#) on page 48

Pasting Events

You can paste events from the clipboard.

PROCEDURE

- Do one of the following:
 - Select the events and select **Edit > Functions > Paste at Origin** to paste the event at the same position from which you cut or copied it.
 - Select the events, select the track where you want to paste them, and select **Edit > Functions > Paste Relative to Cursor** to paste the event while keeping its relative position to the project cursor.
-

RESULT

If you paste an audio event, it is inserted on the selected track, positioned so that its snap point is aligned with the cursor position.

If the selected track is of the wrong type, the event is inserted on its original track.

Pasting Events to Matching Track Names

You can copy events in one project and paste them at the first track that matches the exact track name in another project.

PROCEDURE

1. Copy the events in one project.
2. Activate the project where you want to paste the events.
3. Select **Edit > Functions > Paste to Matching Track Name**.

RESULT

The events are inserted on the track with the name that exactly matches the original track name. For all events that have no matching track name, new tracks are created.

Duplicating Events

In the **Project** window, you can duplicate selected events.

PROCEDURE

- Select the event and do one of the following:
 - Select **Edit > Functions > Duplicate**.
 - Hold down **Alt/Opt** and drag the event to a new position.

NOTE

If you hold down **Ctrl/Cmd** as well, movement direction is restricted to either horizontal or vertical.

RESULT

A copy of the selected event is created and placed after the original. If several events are selected, all of these are copied as one unit, maintaining the relative distance between the events.

NOTE

If you duplicate audio events, the copies always refer to the same audio clip.

Repeating Events

PROCEDURE

- Do one of the following:
 - Select the events and select **Edit > Functions > Repeat** to open the **Repeat Events** dialog, that allows you to create a number of real or shared copies of the selected events.
 - Select the events, hold down **Alt/Opt**, click the handle in the lower right corner of the last selected event, and drag to the right to create a real copy.
 - Move the mouse pointer over the middle of the right event border so that it becomes a pointing hand symbol, click and drag to the right to create a real copy.
 - Select the events, hold down **Alt/Opt - Shift**, and drag to the right to create a shared copy.

NOTE

This applies to MIDI events only.

- Move the mouse pointer over the middle of the right event border so that it becomes a pointing hand symbol, hold down **Shift**, click and drag to the right to create a shared copy.

NOTE

Repeating by dragging only works if the track has a height of at least 2 rows.

RELATED LINKS

- [Shared Copies](#) on page 236
- [Repeat Events Dialog](#) on page 236
- [Setting the Track Height](#) on page 185

Repeat Events Dialog

The **Repeat Events** dialog allows you to create a number of real or shared copies of the selected events.

- To open the **Repeat Events** dialog, select **Edit > Functions > Repeat**.

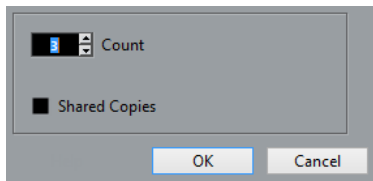

Count

Allows you to specify how many times you want the event to be repeated.

Shared Copies

Activate this to create a shared copy.

RELATED LINKS

- [Shared Copies](#) on page 236

Shared Copies

Shared copies are useful if you want to create copies that are automatically edited in the same way as the original event.

You can create shared copies by using the **Repeat Events** dialog.

You can convert a shared copy to a real copy by selecting **Edit > Functions > Convert to Real Copy**. This creates a new version of the clip that you can edit independently. The new clip is automatically added to the **Pool**.

RELATED LINKS

- [Repeating Events](#) on page 235
- [Repeat Events Dialog](#) on page 236

Fill Loop

You can create a number of copies between the right and left locators.

- Select **Edit > Functions > Fill Loop** to create a number of copies starting at the left locator and ending at the right locator.
The last copy is automatically shortened to end at the right locator position.

Sliding the Contents of Events

You can move the contents of an event without changing its position in the **Project** window.

PROCEDURE

- Hold down **Ctrl/Cmd - Alt/Opt**, click the event, and drag to the left or right.

RESULT

The content of the event is moved.

NOTE

You cannot slide an audio event past the start or end of the actual audio clip. If the event plays the whole clip, you cannot slide the audio at all.

Grouping Events

You can treat several events on the same or different tracks as one unit by grouping them.

PROCEDURE

- Select the events and select **Edit > Group**.

RESULT

The events are grouped. This is indicated by an icon.

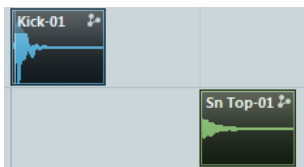

Grouped Events

If you edit one of the grouped events in the **Project** window, all other events in the same group are affected too.

Group editing operations include:

- Selecting
- Moving and duplicating
- Resizing
- Adjusting fade-in and fade-out (audio events only)
- Splitting
- Locking
- Muting

- Deleting

RELATED LINKS

[Fades, Crossfades, and Envelopes](#) on page 335

Group Editing Mode

The **Group Editing** mode for folder tracks allows you to edit parts and events in a folder as a group.

If **Group Editing**  is activated and you select an event, a part or a range on a track inside the folder track, other events, parts, or ranges that have the same start and end time and the same playback priority, are also selected and temporarily grouped. This allows you to edit together different drum tracks for bass drum, snare, and toms, for example.

Temporarily means that on every new selection with the **Object Selection** or the **Range Selection** tool, Nuendo looks for corresponding events or parts inside the folder and groups them. If you edit the start or end point of a single event or part before activating the **Group Editing** mode, the event or part is excluded from the group.

Edit actions in **Group Editing** mode affect all grouped events, parts, or ranges. If you select another take by using the **To Front** submenu, all other tracks inside the edit group also switch to the corresponding take. This is useful for comparing takes of a multi-track recording.

NOTE

Group Editing overwrites any regular group settings in the edit group.

RELATED LINKS



[Muting Events](#) on page 240

[Organizing Tracks in Folder Tracks](#) on page 187

Performing Group Editing

You can group events and parts on multiple tracks that have the same start and end time and the same playback priority to edit them together.

PROCEDURE

1. In the global track controls area of the track list, click **Add Track** .
 2. Click **Folder**.
 3. Click **Add Track**.
 4. Move the tracks that contain the events that you want to edit as a group into the folder track.
 5. In the track list for the folder track, click **Group Editing** .
-

RESULT

All events, parts, or ranges inside the folder that have the same start and end time and the same playback priority are temporarily grouped.

Locking Events

If you want to make sure that you do not edit or move an event by accident, you can lock it.

PROCEDURE

- Do one of the following:
 - Select the events and select **Edit > Lock** to lock the selected events.

- Click the padlock button in the track list or in the **Inspector** to lock all events on a track.
-

RESULT

The events are locked. This is indicated by a padlock symbol.

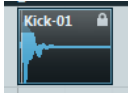

To unlock an event, select the event and select **Edit > Unlock**.

Lock Event Attributes Dialog

The **Lock Event Attributes** dialog allows you to lock specific event attributes.

- To open the **Lock Event Attributes** dialog, select a locked event and select **Edit > Lock**.

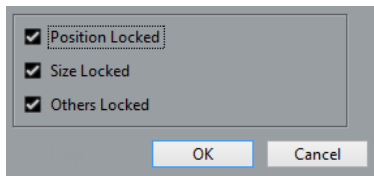

Position Locked

Activate this to prevent the event from being moved.

Size Locked

Activate this to prevent the event from being resized.

Others Locked

Activate this to prevent the event from being edited. This includes adjusting the fades and event volume, processing, etc.

NOTE

You can also set these attributes in the **Preferences** dialog (**Editing** page).

RELATED LINKS

[Lock Event Attributes](#) on page 1357

Inverting the Phase of Audio Events

You can invert the phase of audio events in the **Project** window.

PROCEDURE

1. In the **Project** window, select one or multiple audio events.
 2. On the info line, click the **Invert Phase** field.
-

RESULT

The phase of the events is inverted. This is reflected on the info line.

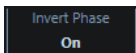

RELATED LINKS

[Info Line](#) on page 62

Muting Events

You can mute events in the **Project** window. Muted events can be edited as usual with the exception of adjusting fades, but are not played back.

PROCEDURE

- Do one of the following:
 - Select the **Mute** tool and click the events or drag a selection rectangle around them.
 - Select the events and select **Edit > Mute**.

RESULT

The events are muted and grayed out.



You can unmute events by selecting them and selecting **Edit > Unmute**.

RELATED LINKS

[Project Window Toolbar](#) on page 48

Exporting Selected Events

You can render selections or range selections of audio events and/or MIDI parts and export the rendered material as .wav files.

PROCEDURE

1. Select one or more audio events and/or MIDI parts or make a range selection.
2. Select **File > Export > Selected Events**.
3. In the **Export Selected Events** dialog, specify the render options.
4. Click **Export**.

RESULT

All selected source material is processed according to your render settings. Your render options are saved and used for all further render operations.

Export Selected Events Dialog

The **Export Selected Events** allows you to render selections or range selections of audio events and/or MIDI parts and export the rendered material as .wav files.

- To open the **Export Selected Events** dialog, select an event in the **Project** window, and select **File > Export > Selected Events**.

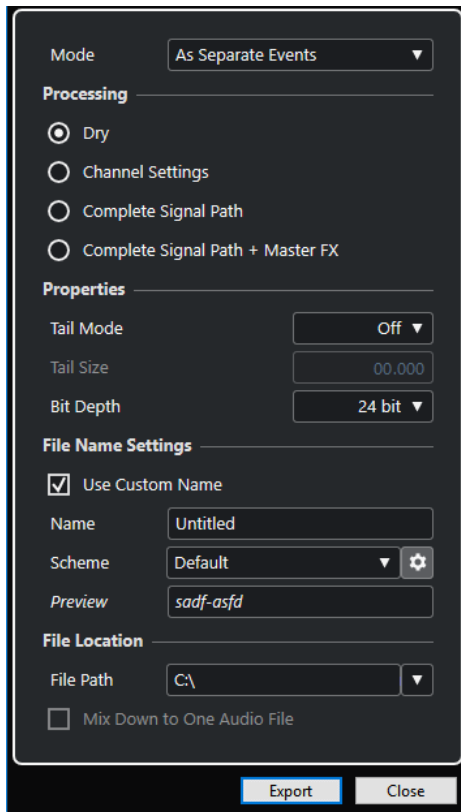

The following settings are available in the **Mode** section:

As Separate Events

Creates one or more tracks that contain separate events or parts that are saved as separate audio files.

As Block Events

Creates one or more tracks that contain adjacent events/parts that are combined to blocks. Every block is saved as a separate audio file.

As One Event

Creates one or more tracks that contain the events/parts and combines them to one event/part. Every combination is saved as a separate audio file.

The following settings are available in the **Processing** section:

Dry

Copies all effects and panner settings to new audio tracks. The resulting audio tracks keep the formats of their source tracks. A mono track results in a mono track, for example.

Channel Settings

Renders all effects into the resulting audio files. This includes insert effects, channel strip settings, group channel settings, and FX send channel settings. Panner settings are transferred to the new audio tracks. The resulting audio tracks keep the formats of their source tracks. A mono track results in a mono track, for example.

Complete Signal Path

Renders the complete signal path into the new audio files, including all channel settings, group channel settings, FX send channel settings, and panner settings. The new audio track is created without effects. Stereo balance panner settings are activated. The resulting audio file format is determined by the output channel of the source track. A mono track that is routed to a stereo bus results in a stereo audio file.

Complete Signal Path + Master FX

Renders the complete signal path and the master bus settings into the resulting audio files. This includes all channel settings, group channel settings, FX send channel settings, and panner settings. The resulting audio file format is determined by the output channel of the source track. A mono track that is routed to a stereo bus results in a stereo audio file.

The following settings are available in the **Properties** section:

Tail Mode

Allows you to set the tail mode to **Bars & Beats**, **Seconds** or **Off**.

Tail Size

Allows you to set a tail length for the rendered files. This adds time at the end of the rendered file to allow reverb and delay tails to fully fade out.

Bit Depth

Allows you to set the bit depth for the resulting file.

The following settings are available in the **File Name Settings** section:

Use Custom Name

Activates the use of custom names for the rendered files.

Name

Allows you to enter a custom name for the rendered files.

Scheme

Click **Open Naming Scheme Window** to define naming schemes.

Preview

Shows the name with the current naming scheme settings.

The following settings are available in the **File Location** section:

File Path

Allows you to select a custom folder to which the resulting .wav files are rendered.

Mix down to One Audio File

Creates one audio file from all your source material. This option is only available if several tracks are selected and **Dry (Transfer Channel Settings)** is deactivated.

RELATED LINKS

[Naming Scheme Dialog](#) on page 242

Naming Scheme Dialog

The **Naming Scheme** dialog allows you to define naming schemes for the audio material that you want to export.

- To open the **Naming Scheme** dialog, select an event in the **Project** window, select **File > Export > Selected Events**, and click **Open Naming Scheme Window**.

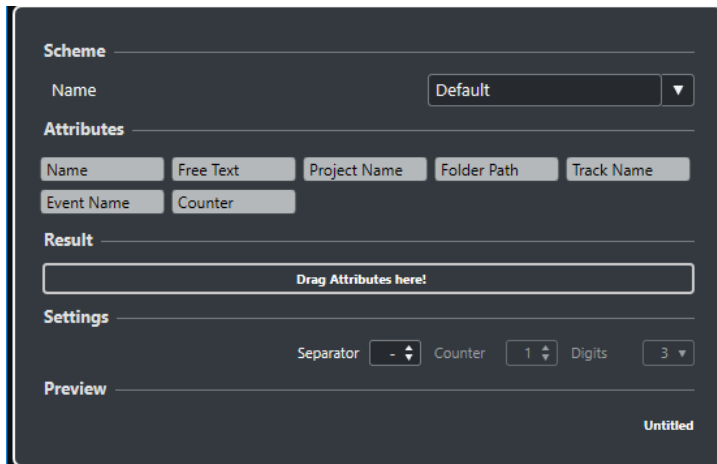

Scheme

Allows you to save and delete naming schemes.

Attributes

Holds the following naming scheme attributes:

- **Name**
Adds the text you entered on the **Export Selected Events** dialog in the **Name** field to the resulting file name.

NOTE

The resulting file name only contains the text in the **Name** field of the **File Name Settings** in the **Export Selected Events** dialog if no naming scheme defined. The file name corresponds to the naming scheme if the naming scheme contains attributes.

- **Project Name**
Adds the project name to the resulting file name.
- **Free Text**
Allows you to enter free text.
- **Folder Path**
Adds the folder path of the events from the track list to the resulting file name.
- **Track Name**
Adds the track name of the audio event or MIDI part to the resulting file name.
- **Event Name**
Adds the event name of the audio event or MIDI part to the resulting file name.
- **Counter**
Adds a number to the resulting file name.

Result

Allows you to drop attributes for the file name and rearrange them by dragging.

Settings

Allows you to select separator and counter settings.

- **Separator**
Divides attributes from each other.
- **Counter**
The value from which the counter starts counting.

- **Digits**
The number of digits of the counter value.

Preview

Displays a preview of your current settings.

RELATED LINKS

[Defining Naming Schemes](#) on page 244

[Entering Free Text](#) on page 245

Defining Naming Schemes

You can define naming schemes by setting up attributes which build the structure of the file name of the exported audio files.

PREREQUISITE

The **Export Selected Events** dialog is open and **Mix Down to One Track** is deactivated.

PROCEDURE

1. In the **Export Selected Events** dialog, click **Open Naming Scheme Window**.
The **Naming Scheme** dialog opens.

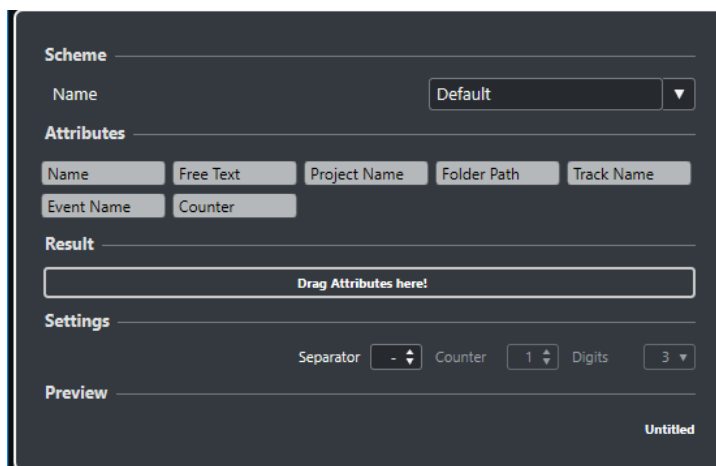

2. Open the **Scheme** pop-up menu and select **New Scheme**.
3. Optional: Double-click the name in the field and enter a name.
4. Double-click an attribute in the **Attributes** field to add it to the **Result** field.
You can also drag an attribute and drop it in the **Result** field.

NOTE

Each attribute is available only once, except the **Free Text** attribute. You can set up a maximum of seven attributes.

To remove an attribute, click its **x** icon.

-
5. Optional: Drag an attribute to the left/right in the **Result** field to change its order.
 6. Click **OK**.

RESULT

The naming scheme is saved and will be applied on export.

RELATED LINKS

[Entering Free Text](#) on page 245

Entering Free Text

You can enter free text that is added to the file name of the exported audio files.

PREREQUISITE

The **Export Selected Events** dialog is open and **Mix Down to One Track** is deactivated.

PROCEDURE

1. In the **Export Selected Events** dialog, click **Open Naming Scheme Window**.
The **Naming Scheme** dialog opens.

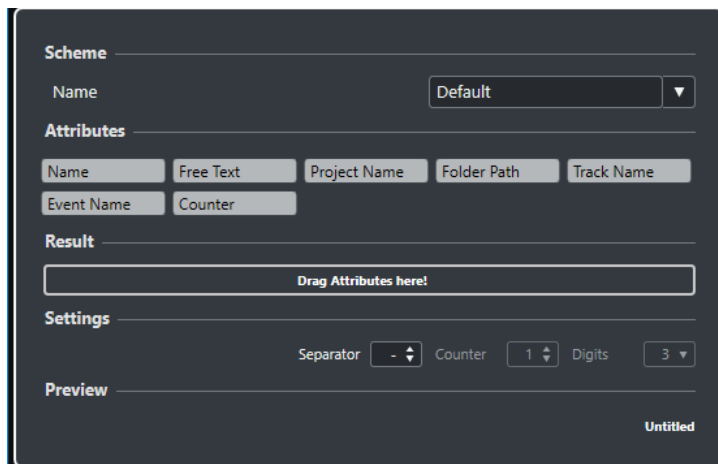

2. Open the **Scheme** pop-up menu and select **New Scheme**.
 3. Double-click the **Free Text** attribute to add it to the **Result** field.
 4. In the **Result** field, double-click the **Free Text** label and enter the text that you want to add.
 5. Press **Return** to confirm your changes.
 6. Click **OK**.
-

RESULT

The text that you entered is added to the file name scheme and will be applied on export.

Saving Naming Schemes

You can save several naming schemes in the **Naming Scheme** window. Saved naming schemes are displayed on the **Scheme** pop-up menu. Every change that is made to the active naming scheme is saved immediately.

PROCEDURE

1. Define a naming scheme by adding attributes to the **Result** field.
 2. Make separator and counter settings.
 3. To rename the naming scheme, double-click its name in the field, type in the new name, and press **Enter**.
-

Exporting Audio Parts and Events as Clip Packages

You can select audio parts and events in the **Project** window and export them as a clip package.

PROCEDURE

1. Select the audio events of parts that makes up the sound or create a selection range.

NOTE

Only audio material will be part of the clip package. Any other selected material is ignored. Any empty space before the audio is included in the clip package.

2. Optional: Read-enable the corresponding tracks to include automation data in the clip package.
3. Select **File > Export > Clip Package**.
4. In the upper section of the **Export Clip Package** dialog, specify the folder where you want to save the clip package.

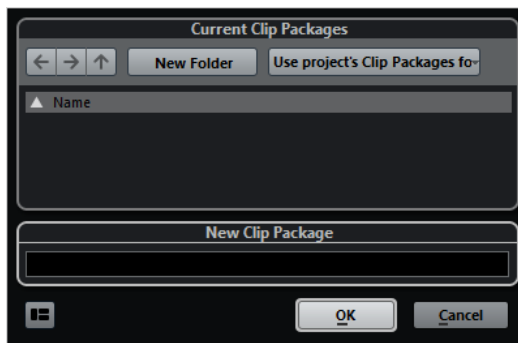

5. Enter a name in the name field.
 6. Click **OK**.
-

RESULT

The clip package is saved in the specified folder with the specified name.

RELATED LINKS

[Clip Packages](#) on page 210

[Attribute Inspector](#) on page 728

[Export Clip Package Dialog](#) on page 246

Export Clip Package Dialog

The **Export Clip Package** dialog allows you to export audio parts and events that are selected in the **Project** window as clip packages.

- To open the **Export Clip Package** dialog, select an event in the **Project** window, and select **File > Export > Clip Package**.

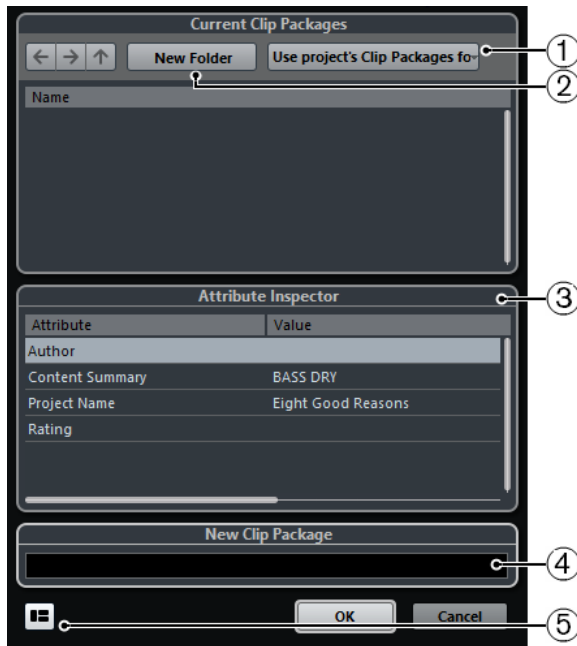

- 1 Select Folder**
Allows you to select a folder where the clip packages are saved. You can use the clip packages folder of the project or choose another folder.
- 2 Create New Folder**
Creates a new folder for your clip packages.
- 3 Attribute Inspector**
Allows you to show and edit the attributes for the clip package.
- 4 Name field**
Allows you to enter the name for the clip package.
- 5 Show Attribute Inspector**
Opens/Closes the **Attributes Inspector**.

Range Editing

Editing in the **Project** window is not restricted to handling whole events and parts. You can also work with selection ranges, which are independent from the event/part and track boundaries.

Creating a Selection Range

PROCEDURE

1. On the **Project** window toolbar, select **Range Selection**.
2. Do one of the following:
 - Draw a selection rectangle around the range that you want to select.
 - Select **Edit > Select**, and select one of the menu functions.
 - Double-click an event to create a selection range that encompasses it.

NOTE

If you hold down **Shift** and double-click several events in a row, you can create a selection range that encompasses several events.

RELATED LINKS

[Select Menu for Selection Ranges](#) on page 248

[Combine Selection Tools Mode](#) on page 215

Select Menu for Selection Ranges

If the **Range Selection** tool is selected, the **Select** submenu features specific options for selecting ranges in the **Project** window.

- To open the range selection options menu, select the **Range Selection** tool and select **Edit > Select**.

All

Makes a selection that covers all tracks, from the start of the project to the end. You can define the track length with the **Project Length** setting in the **Project Setup** dialog.

None

Removes the current selection range.

Invert

Inverts the selection. All selected events are deselected, and all events that were not selected are selected. Only used for event selection.

In Loop

Makes a selection between the left and right locator on all tracks.

From Start to Cursor

Makes a selection on all tracks, from the start of the project to the project cursor.

From Cursor to End

Makes a selection on all tracks, from the project cursor to the end of the project.

Equal Pitch - all Octaves

This function requires that a single note is selected. It selects all notes of this part that have the same pitch in any octave as the selected note.

Equal Pitch - same Octave

This function requires that a single note is selected. It selects all notes of this part that have the same pitch and the same octave as the selected note.

Select Controllers in Note Range

Selects the controllers within the note range.

All on Selected Tracks

Selects all events on the selected track. Only used for event selection.

Events under Cursor

Selects all events on the selected tracks that are touched by the project cursor.

Select Event

This is available in the **Sample Editor**.

Left Selection Side to Cursor

Moves the left side of the current selection range to the project cursor position.

Right Selection Side to Cursor

Moves the right side of the current selection range to the project cursor position.

Range to Next Event

Moves the selection range to the next event head or tail on the selected tracks and turns the selection range to a zero selection.

Range to Previous Event

Moves the selection range to the previous event head or tail on the selected tracks and turns selection range to a zero selection.

Enlarge Range to Next Event

Moves the right side of the current selection range to the next event head or tail on the selected tracks.

Enlarge Range to Previous Event

Moves the left side of the current selection range to the previous event head or tail on the selected tracks.

RELATED LINKS

[Project Setup Dialog](#) on page 108

[Selecting with the Object Selection Tool](#) on page 215

[Select Submenu](#) on page 216

Selecting Ranges for Several Tracks

You can create selection ranges that cover several tracks. It is also possible to exclude tracks from a selection range.

PROCEDURE

1. Create a selection range from the first to the last track.
2. Press **Alt/Opt** and click in the selection range on the tracks that you want to exclude from the selection.

If you press **Shift - Alt/Opt** while creating a selection range, the range will encompass all tracks in the track list.

Creating Different Selection Ranges

You can create 2 different selection ranges (selection A and selection B) and switch between these. Activating one of the options selects the corresponding selection and causes the event display to switch between the two locations.

PROCEDURE

1. Use the **Range Selection** tool to define a destination range for your selection.
By default, the first selection you perform will be **Selection A**. The letter displayed on the tool icon shows which selection range you are to define.
2. Click on the **Range Selection** tool again and select **Selection B** from the pop-up menu.

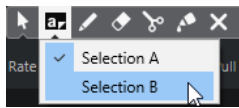

This switches the selection ranges.

3. Define the destination range for **Selection B**.
-

RESULT

You can now switch between **Selection A** and **Selection B** with the **Range Selection** pop-up menu.

AFTER COMPLETING THIS TASK

Deactivate the **Range Selection** tool. Otherwise, you might accidentally overwrite your defined selections.

Editing Selection Ranges

You can edit selection ranges, that is, adjust their size, move or duplicate them, split them, etc.

Adjusting the Size of Selection Ranges

You can adjust the size of a selection range in the following ways:

- By dragging its edges.
The pointer takes the shape of a double arrow when you move it over an edge of the selection range.
- By holding down **Shift** and clicking.
The closest selection range edge is moved to the position at which you clicked.
- By adjusting the selection range length, or the start or end position on the info line.
- By using the trim buttons on the toolbar.
The left trim buttons move the start of the selection range and the right buttons move the end. The edges are moved by the amount specified on the **Grid** pop-up menu.

NOTE

The trim buttons are located on the **Nudge Palette**, which is not visible on the toolbar by default.

- By using **Move Left** and **Move Right** on the toolbar.
These move the whole selection range to the left or the right. The amount of movement depends on the selected display format and the value specified on the **Grid** pop-up menu.

IMPORTANT

The contents of the selection are not moved. Using **Move Left/Move Right** is the same as adjusting the start and end of the selection range at the same time by the same amount.

NOTE

The move buttons are located on the **Nudge Palette**, which is not visible on the toolbar by default.

- To crop all events or parts that are partially within the selection range, select **Edit > Range > Crop**.
Events that are fully inside or outside the selection range are not affected.

RELATED LINKS

[Setup Context Menus](#) on page 1338

Moving Selection Ranges

PREREQUISITE

You have created a selection range.

PROCEDURE

- Click the selection range and drag it to a new position.
-

RESULT

The contents of the selection range are moved to the new position. If the range intersected events or parts, these are split before moving, so that only the sections within the selection range are affected.

RELATED LINKS

[Creating a Selection Range](#) on page 248
[Duplicating Events](#) on page 235

Duplicating Selection Ranges

PREREQUISITE

You have created a selection range.

PROCEDURE

- Click the selection range, hold down **Alt/Opt**, and drag.
-

RELATED LINKS

[Creating a Selection Range](#) on page 248

Cut, Copy, and Paste of Selection Ranges

You can cut or copy and paste selection ranges, using the functions on the **Edit** menu. You can also use the **Cut Time** and **Paste Time** options.

Cut

Cuts the data in the selection range and moves it to the clipboard. The selection range is replaced by empty track space in the **Project** window, meaning that events to the right of the range keep their positions.

Copy

Copies the data in the selection range to the clipboard.

Paste

Pastes the clipboard data to the start position and track of the current selection. Existing events on the tracks remain at their original position.

Paste at Origin

Pastes the clipboard data back at its original position. Existing events on the tracks remain at their original position.

This option is available in **Edit > Functions**.

Cut Time

Cuts the selection range and moves it to the clipboard. Events to the right of the removed range are moved to the left to fill the gap.

This option is available in **Edit > Range**.

Paste Time

Pastes the selection range from the clipboard to the start position and track of the current selection. Existing events are moved to make room for the pasted data.

This option is available in **Edit > Range**.

Paste Time at Origin

Pastes the selection range from the clipboard to its original position. Existing events are moved to make room for the pasted data.

This option is available in **Edit > Range**.

Global Copy

Copies everything between the left and right locator.

This option is available in **Edit > Range**.

Deleting Data in Selection Ranges

- To replace data within the deleted selection range with empty track space, select **Edit > Delete** or press **Backspace**.
Events to the right of the range keep their position.
- To remove the selection range and make the events to the right move to the left to fill the gap, select **Edit > Range > Delete Time**.

Splitting Selection Ranges

You can split events or parts at the selection range edges, that is, at the start and end of a selection range.

PROCEDURE

1. Do one of the following:

- On the **Project** window toolbar, activate **Combine Selection Tools**, and move the mouse to the upper area of the event or part that you want to split so that the **Range Selection** tool is activated.
 - On the **Project** window toolbar, activate the **Range Selection** tool.
2. Do one of the following:
- Select **Edit > Range > Split**.
 - Press **Shift-X**.
-

RESULT

The events or parts are split at the selection range edges.

If you activated **Combine Selection Tools** mode, the split events or parts are automatically selected.

RELATED LINKS

[Combine Selection Tools Mode](#) on page 215

Inserting Silence

You can insert empty track space from the start of the selection range. The length of the silence equals the length of the selection range.

- To insert silence, select **Edit > Range > Insert Silence**.
Events to the right of the selection range start are moved to the right to make room. Events that are intersected by the selection range start are split, and the right section is moved to the right.

Playback and Transport

Nuendo offers multiple methods and functions to control playback and transport.

Transport Panel

The **Transport** panel contains the main transport functions as well as many other options related to playback and recording.

- To show the **Transport** panel, select **Transport > Transport Panel** or press **F2**.

Transport Panel Sections

The **Transport** panel has different sections that you can show or hide by activating the corresponding options on the **Transport** panel context menu.

- To show all **Transport** panel sections, right-click anywhere on the **Transport** panel and select **Show All**.

The following sections are available:

System Performance Meter

System Performance Meter

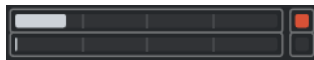

Shows the meters for average audio processing load and the disk cache load.

Common Record Modes

Common Record Modes



Allow you to determine what happens if you click **Record** during an audio or MIDI recording, and where the recording should start.

Audio Record Modes

Audio Record Modes

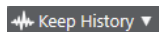

Allow you to select what happens when you record over existing audio events.

MIDI Record Modes

MIDI Record Modes

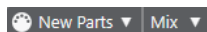

Allow you to select what happens when you record over existing MIDI parts.

MIDI Auto Quantize

Automatic MIDI Record Quantize



Activates automatic quantizing during a MIDI recording.

Locators

Go to Left Locator Position



Allows you to go to the left locator position.

Left Locator Position

1. 5. 1. 0

Shows the left locator position.

Go to Right Locator Position



Allows you to go to the right locator position.

Right Locator Position

4. 8. 1. 0

Shows the right locator position.

Locator Range Duration

Locators to Selection



Allows you to set the locators to the selection.

Locator Range Duration

4. 8. 1. 0

Shows the duration of the locator range.

Punch Points

Lock Punch Points to Locators



Locks the punch points to the left and right locator positions.

Punch In



Activates **Punch In**.

Punch In Position

20. 1. 1. 0

Allows you to set up the punch in position. For this to work, **Lock Punch Points to Locators** must be deactivated. To show/hide this, click the points on the divider.

Punch Out



Activates **Punch Out**.

Punch Out Position

1. 1. 1. 0

Allows you to set up the punch out position. For this to work, **Lock Punch Points to Locators** must be deactivated. To show/hide this, click the points on the divider.

Transport Controls

Go to Previous Marker/Zero



Moves the project cursor to the previous marker/zero position on the timeline.

Go to Next Marker/Project End



Moves the project cursor to the next marker/project end.

Rewind



Moves backward.

Forward



Moves forward.

Cycle



Activates/Deactivates cycle mode.

Stop



Stops playback.

Start



Starts playback.

Transport Record



Activates/Deactivates record mode.

Time Display

Select Primary Time Format



Allows you to select a time format for the primary time display.

Primary Time Display

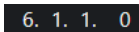

Shows the position of the project cursor in the selected time format.

Select Secondary Time Format



Allows you to select a time format for the secondary time display.

Secondary Time Display

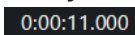

Shows the position of the project cursor in the selected time format.

Markers

Jump to Marker



Allows you to set and locate marker positions.

Open Markers Window



Opens the **Markers** window.

Pre-roll & Post-roll

Activate Pre-roll



Activates pre-roll.

Pre-roll Amount

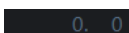

Allows you to set the pre-roll position. To show/hide this, click the points on the divider.

Activate Post-roll



Activates post-roll.

Post-roll Amount

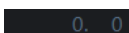

Allows you to set the post-roll position. To show/hide this, click the points on the divider.

Tempo & Time Signature

Activate Tempo Track



Allows you to activate/deactivate the tempo track.

Tempo



Allows you to set the tempo value.

Time Signature



Allows you to set the first time signature value. To show/hide this, click the points on the divider.

Activate External Sync

Activate External Sync



Activates external synchronization.

Open Synchronization Setup



Allows you to open the **Project Synchronization Setup** dialog.

Click & Count-In & Click Pattern

Activate Metronome Click



Activates the metronome click.

Activate Count-in



Activates the metronome click in count-in.

Click Pattern



Allows you to set up a click pattern. To show/hide this, click the points on the divider.

Open Metronome Setup



Opens the **Metronome Setup** dialog. To show/hide this, click the points on the divider.

Input/Output Activity

MIDI In Activity



Displays the MIDI input signals.

MIDI Out Activity



Displays the MIDI output signals.

Audio Activity



Displays the audio input/output signals.

Audio Clipping



Displays audio clipping.

Level Display



Displays the output level.

Level Control



Allows you to control the output level.

Set up Transport

Set up Transport



Opens a pop-up menu where you can set up which elements are visible.

RELATED LINKS

[Transport](#) on page 1375

[Transport - Scrub](#) on page 1376

Transport Menu

The **Transport** menu contains several transport functions as well as many other options related to playback and recording.

Transport Panel

Opens the **Transport** panel.

Transport Commands

Start

Starts playback.

Stop

Stops playback.

Start/Stop

Starts/Stops playback.

Cycle

Activates/Deactivates cycle mode.

Record

Activates/Deactivates record mode.

Rewind

Moves backward.

Forward

Moves forward.

Fast Rewind

Moves backward at a faster speed.

Fast Forward

Moves forward at a faster speed.

Nudge Cursor Left

Moves the project cursor position to the left.

Nudge Cursor Right

Moves the project cursor position to the right.

Enter Project Cursor Position

Allows you to enter the project cursor position manually.

Enter Tempo

Allows you to enter the tempo manually.

Enter Time Signature

Allows you to enter the time signature manually.

Go to Project Start

Moves the project cursor position to the start of the project.

Go to Project End

Moves the project cursor position to the end of the project.

Exchange Time Formats

Switches the primary and the secondary time display.

Locators

Go to Left Locator Position

Moves the project cursor position to the left locator.

Go to Right Locator Position

Moves the project cursor position to the right locator.

Set Left Locator to Project Cursor Position

Sets the left locator to the project cursor position.

Set Right Locator to Project Cursor Position

Sets the right locator to the project cursor position.

Enter Left Locator Position

Allows you to enter the position of the left locator manually.

Enter Right Locator Position

Allows you to enter the position of the right locator manually.

Enter Locator Range Duration

Allows you to enter the duration of the locator range manually.

Set Locators to Selection Range

Sets the locators to encompass the selection.

Exchange Left & Right Locator Positions

Switches the positions of the left and right locator.

Loop Selection Range

Activates playback from the start of the current selection and keeps starting over again when reaching the selection end.

Punch Points

Activate Punch In

Activates/Deactivates punch in.

Activate Punch Out

Activates/Deactivates punch out.

Go to Punch In Position

Moves the project cursor position to the punch in position.

Go to Punch Out Position

Moves the project cursor position to the punch out position.

Lock Punch Points to Locators

Allows you to unlock/lock the punch in and punch out position to the left and the right locator.

Set Punch In to Project Cursor Position

Moves the punch in position to the project cursor position.

Set Punch Out to Project Cursor Position

Moves the punch out position to the project cursor position.

Enter Punch In Position

Allows you to enter the punch in position manually.

Enter Punch Out Position

Allows you to enter the punch out position manually.

Set Punch Points to Selection Range

Sets the punch in and the punch out position to the selected event range.

Set Project Cursor Position

Locate Selection Start

Moves the project cursor to the beginning of the selection.

Locate Selection End

Moves the project cursor to the end of the selection.

Locate Next Marker

Moves the project cursor to the next marker.

Locate Previous Marker

Moves the project cursor to the previous marker.

Locate Next Hitpoint

Moves the project cursor to the next hitpoint on the selected track.

Locate Previous Hitpoint

Moves the project cursor to the previous hitpoint on the selected track.

Locate Next Event

Moves the project cursor to the next event on the selected track.

Locate Previous Event

Moves the project cursor to the previous event on the selected track.

Play Project Range

Play from Selection Start

Activates playback from the start of the current selection.

Play from Selection End

Activates playback from the end of the current selection.

Play until Selection Start

Activates playback two seconds before the start of the current selection and stops at the selection start.

Play until Selection End

Activates playback two seconds before the end of the current selection and stops at the selection end.

Play until Next Marker

Activates playback from the project cursor and stops at the next marker.

Play Selection Range

Activates playback from the start of the current selection and stops at the selection end.

Pre-roll & Post-roll

Use Pre-roll

Activates/Deactivates the pre-roll.

Use Post-roll

Activates/Deactivates the post-roll.

Post-roll from Selection Start

Starts playback from the beginning of the selected range and stops after the time set in the post-roll field on the **Transport** panel.

Post-roll from Selection End

Starts playback from the end of the selected range and stops after the time set in the post-roll field on the **Transport** panel.

Pre-roll to Selection Start

Stops playback at the selection start. The playback start position is set in the pre-roll field on the **Transport** panel.

Pre-roll to Selection End

Stops playback at the selection end. The playback start position is set in the pre-roll field on the **Transport** panel.

Use Tempo Track

Activates/Deactivates the tempo track.

Common Record Modes

Punch In/Out

Activates/Deactivates punch in/out.

Re-Record

Activates/Deactivates the re-record mode.

Start Recording at Project Cursor Position

Activates/Deactivates the start of the recording at the project cursor position.

Start Recording at Left Locator/Punch In Position

Activates/Deactivates the start of the recording at the left locator.

Audio Record Mode

These options allow you to select what happens when you record over existing events.

Keep History

Keeps existing events or portions of events.

Cycle History + Replace

Replaces existing events or portions of events by the new recording. In cycle mode, all takes from the current cycle recording are kept.

Replace

Replaces existing events or portions of events by the last take.

MIDI Record Mode

These options allow you to select what happens when you record over existing parts.

New Parts

Keeps existing parts and saves the new recording as a new part.

Merge

Keeps existing events in parts and adds the newly recorded events.

Replace

Replaces existing events in parts by the new recording.

Auto Quantize in Record

Activates automatic quantizing during recording.

MIDI Cycle Record Mode

Mix

Adds everything you record to what was previously recorded.

Overwrite

Overwrites all MIDI that you have recorded on previous laps as soon as you play a MIDI note or send any MIDI message.

Keep Last

Replaces previously recorded laps only if the new lap is completed.

Stacked

Turns each recorded cycle lap into a separate MIDI part, and divides the track into lanes for each cycle lap. The parts are stacked above each other, each on a different lane. All takes but the last one are muted.

Mix-Stacked (No Mute)

Same as **Stacked**, but parts are not muted.

Auto Quantize in Record

Activates automatic quantizing during recording.

MIDI Retrospective Recording

Allows you to recover MIDI data that you play in **Stop** mode or during playback. The following options are available:

Insert from All MIDI Inputs

Inserts MIDI data that was sent to all track inputs as a linear MIDI part on the selected track.

Insert from Track Input as Linear Recording

Inserts MIDI data that was sent to the track input as a linear MIDI part on the selected track.

Insert from Track Input as Cycle Recording

Inserts MIDI data that was sent to the track input as stacked MIDI parts on the selected track.

Empty All Buffers

Empties the retrospective record buffer for the selected track.

Use Video Follows Edit Mode

If this option is activated, the project cursor automatically follows when you make selections or when you perform editing operations.

Metronome Setup

Opens the **Metronome Setup** dialog.

Activate Metronome

Activates/Deactivates the metronome click.

Project Synchronization Setup

Opens the **Project Synchronization Setup** dialog.

Activate External Sync

Sets Nuendo to be synchronized externally.

RELATED LINKS

[Left and Right Locators](#) on page 271

[Punch In and Punch Out](#) on page 276

[Pre-Roll and Post-Roll](#) on page 275

[Common Record Modes Menu](#) on page 294

[Audio Record Modes](#) on page 299

[MIDI Record Modes](#) on page 306

[Recovery of MIDI Recordings](#) on page 307

[Metronome Click](#) on page 277

Transport Bar

The **Transport Bar** contains all transport functions in an integrated and fixed zone of the **Project** window.

- To activate the **Transport Bar**, click **Set up Window Layout** on the **Project** window toolbar and activate **Transport Bar**.
- To display all transport elements, right-click in an empty area of the **Transport Bar** and select **Show All**.
- To show all controls of a section, click the points to the right of the section and drag all the way to the right. To hide the controls again, drag to the left.



RELATED LINKS

[Transport Bar](#) on page 63

[Project Window Toolbar](#) on page 48

Transport Bar Sections

The **Transport Bar** has different sections that you can show or hide by activating the corresponding options on the context menu.

- To activate the **Transport Bar**, click **Set up Window Layout** on the **Project** window toolbar and activate **Transport Bar**.
- To show/hide tools, open the **Transport Bar** context menu by right-clicking in an empty area of the **Transport Bar** and activate the tools that you want to display. To show all tools, select **Show All**.

Constrain Delay Compensation

Constrain Delay Compensation



Minimizes the latency effects of the delay compensation.

Common Record Modes

Common Record Modes



Allow you to determine what happens if you click **Record** during an audio or MIDI recording, and where the recording should start.

Audio Record Modes

Audio Record Modes

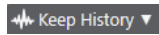

Allow you to select what happens when you record over existing audio events.

MIDI Record Modes

MIDI Record Modes

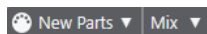

Allow you to select what happens when you record over existing MIDI parts.

MIDI Auto Quantize

Automatic MIDI Record Quantize



Activates automatic quantizing during a MIDI recording.

Left Divider

Left Divider

Tools that are placed to the left of the divider are always shown.

System Performance Meter

System Performance Meter



Shows the meters for average audio processing load and the disk cache load.

Locators

Go to Left Locator Position



Allows you to go to the left locator position.

Left Locator Position

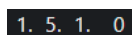

Shows the left locator position.

Go to Right Locator Position



Allows you to go to the right locator position.

Right Locator Position

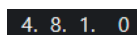

Shows the right locator position.

Locator Range Duration

Locators to Selection



Allows you to set the locators to the selection.

Locator Range Duration

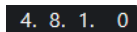

Shows the duration of the locator range.

Punch Points

Punch In



Activates **Punch In**.

Punch Out



Activates **Punch Out**.

Lock Punch Points to Locators



Locks the punch points to the left and right locator positions.

Punch In Position



Allows you to set up the punch in position. For this to work, **Lock Punch Points to Locators** must be deactivated. To show/hide this, click the points on the divider.

Punch Out Position

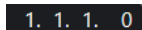

Allows you to set up the punch out position. For this to work, **Lock Punch Points to Locators** must be deactivated. To show/hide this, click the points on the divider.

Transport Controls

Go to Previous Marker/Zero



Moves the project cursor to the previous marker/zero position on the timeline.

Go to Next Marker/Project End



Moves the project cursor to the next marker/project end.

Rewind



Moves backward.

Forward



Moves forward.

Cycle



Activates/Deactivates cycle mode.

Stop



Stops playback.

Start



Starts playback.

Transport Record



Activates/Deactivates record mode.

Retrospective Record

Insert Retrospective Recording from All MIDI Inputs on Selected Track



Allows you to recover MIDI notes that you played in stop mode or during playback.

Time Displays

Select Primary Time Format



Allows you to select a time format for the primary time display.

Primary Time Display

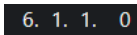

Shows the position of the project cursor in the selected time format.

Select Secondary Time Format



Allows you to select a time format for the secondary time display.

Secondary Time Display

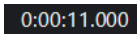

Shows the position of the project cursor in the selected time format.

Markers

Jump to Marker



Allows you to set and locate marker positions.

Open Markers Window



Opens the **Markers** window.

Pre-roll & Post-roll

Activate Pre-roll



Activates pre-roll.

Pre-roll Amount



Allows you to set the pre-roll position. To show/hide this, click the points on the divider.

Activate Post-roll



Activates post-roll.

Post-roll Amount



Allows you to set the post-roll position. To show/hide this, click the points on the divider.

Tempo & Time Signature

Activate Tempo Track



Allows you to activate/deactivate the tempo track.

Tempo



Allows you to set the tempo value.

Time Signature



Allows you to set the first time signature value. To show/hide this, click the points on the divider.

Right Divider

Right Divider

Tools that are placed to the right of the divider are always shown.

Activate External Sync

Activate External Sync



Activates external synchronization.

Open Synchronization Setup



Allows you to open the **Project Synchronization Setup** dialog.

Click & Count-in

Activate Metronome Click



Activates the metronome click.

Activate Count-in



Activates the metronome click in count-in.

Click Pattern



Allows you to set up a click pattern. To show/hide this, click the points on the divider.

Open Metronome Setup



Opens the **Metronome Setup** dialog. To show/hide this, click the points on the divider.

Input/Output Activity

MIDI In Activity



Displays the MIDI input signals.

MIDI Out Activity



Displays the MIDI output signals.

Audio Activity



Displays the audio input/output signals.

Audio Clipping



Displays audio clipping.

Level Display



Displays the output level.

Level Control



Allows you to control the output level.

Set up Transport Bar

Set up Transport



Opens a pop-up menu where you can set up which elements are visible.

Transport Pop-Up Window

The **Transport** pop-up window allows you to access specific transport commands if the **Transport** panel, the **Transport Bar**, and the **Transport Controls** in the **Project** window toolbar are closed or hidden.

The following default key commands open the **Transport Bar** pop-up window:

Enter Left Locator

Shift - L

Enter Right Locator

Shift - R

Enter Project Cursor Position

Shift - P

Enter Tempo

Shift - T

Enter Time Signature

Shift - C

Enter Punch In Position

Shift - I

Enter Punch Out Position

Shift - O

Go to Left Locator

Num 1

Go to Right Locator

Num 2

Using a specific key command opens the corresponding section of the **Transport** pop-up window:

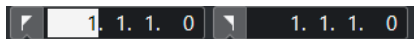

Transport pop-up window for entering the left **Locator** position.

NOTE

To close the **Transport** pop-up window, press **Esc**.

Time Display Window

The **Time Display** window allows you to view the current time position in a separate window. You can adjust its size and specify the time format that you want to display.

- To open the **Time Display** window, select **Studio > More Options > Time Display**.

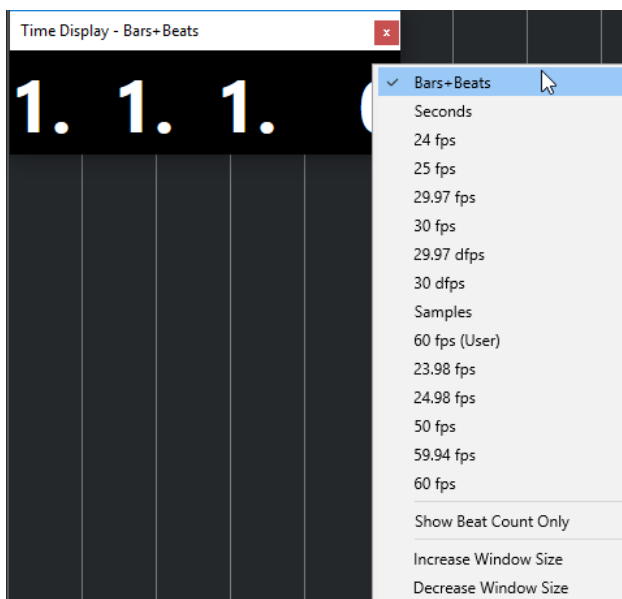

Right-click the window to access the following options:

Bars+Beats

Displays the time in bars and beats.

Seconds

Displays the time in seconds.

fps

Displays the time in frames per second.

Samples

Displays the time in samples.

Show Beat Count Only

Shows the beat counts only. This is useful if you want to use the **Time Display** window as a visual metronome.

Increase Window Size

Increases the size of the window and the displayed values.

Decrease Window Size

Decreases the size of the window and the displayed values.

NOTE

You can set up the **Window Transparency** in the **Studio Setup** dialog (**Time Display** page).

RELATED LINKS

[Time Signature Events](#) on page 1149

Left and Right Locators

The left and right locators are a pair of markers that you can use as reference positions in the **Project** window and in the editors.

Locators help you, for example, to do the following:

- Positioning the project cursor.
- Defining start and stop positions for recording.
- Defining start positions for importing or exporting events.
- Setting up a cycle range.
- Selecting, copying, creating or splitting events.



Locators are indicated by the flags in the ruler.

The area between the left and the right locator is the locator range. The locator range is highlighted in the ruler and the event display.

NOTE

In the event display of the MIDI editors, the locator range is only highlighted if **Show Part Borders** is deactivated.

- To activate/deactivate cycle mode, click the locator range in the upper part of the ruler, or activate **Activate Cycle** in the transport controls.



- NOTE

If you activate cycle mode, and the right locator is positioned before the left locator, the locator range is skipped during playback.



RELATED LINKS

- [Project Window Toolbar](#) on page 48
- [Setting the Project Cursor](#) on page 273
- [Activating Recording Manually](#) on page 291
- [Activating Recording Automatically](#) on page 291
- [Cycle Recording](#) on page 293
- [Punch In and Punch Out](#) on page 276
- [Common Record Modes Menu](#) on page 294
- [Import Options for MIDI Files](#) on page 319
- [Export Options Dialog for MIDI Files](#) on page 178
- [Export Audio Mixdown](#) on page 1162
- [Setting the Locators Using Cycle Markers](#) on page 369
- [Select Submenu](#) on page 216
- [Select Menu for Selection Ranges](#) on page 248
- [Cut, Copy, and Paste of Selection Ranges](#) on page 252
- [Audio Parts](#) on page 212
- [MIDI Parts](#) on page 213
- [Signature Track Controls](#) on page 162
- [Fill Loop](#) on page 237
- [Splitting Events](#) on page 231
- [Transport](#) on page 1375

Setting the Left Locator

Setting the left locator can be useful if you want to add a reference position in the **Project** window and in the editors.

PROCEDURE

- Do one of the following:
 - Press **Ctrl/Cmd** and click in the upper part of the ruler to set the left locator to that position.
 - Adjust the **Left Locator Position** value.
This is available in the **Locators** section of the **Project** window toolbar, the editor toolbars, the **Transport** panel, and the **Transport Bar**.
 - Drag the left locator handle in the upper part of the ruler.
 - Press **Ctrl/Cmd**, and on the numeric keypad press **1** to set the left locator to the project cursor position.
 - Press **Alt/Opt** and click **Go to Left Locator Position** on the **Transport** panel.
-

Setting the Right Locator

Setting the right locator can be useful if you want to add a reference position in the **Project** window and in the editors.

PROCEDURE

- Do one of the following:
 - Press **Alt/Opt** and click in the upper part of the ruler to set the right locator to that position.

- Adjust the **Right Locator Position** value.
This is available in the **Locators** section of the **Project** window toolbar, the editor toolbars, the **Transport** panel, and the **Transport Bar**.
 - Drag the right locator handle in the upper part of the ruler.
 - Press **Ctrl/Cmd**, and on the numeric keypad press **2** to set the right locator to the project cursor position.
 - Press **Alt/Opt** and click **Go to Right Locator Position** on the **Transport** panel.
-

Setting up Locator Ranges

You can set up the locator range, that is, the area between the left and the right locator.

PROCEDURE

- Do one of the following:
 - Press **Shift - D** to activate the **Locator Range Duration** value field in the **Locator Range Duration** section of the toolbar, and enter a value.
 - Click and drag in the upper part of the ruler.
 - Select a range or an event and press **P** to set the locators to the selection.
 - Double-click a cycle marker.
 - Press **Ctrl/Cmd - Alt/Opt** and click at a position in the upper part of the ruler to set both locators to the nearest snap position.
-

RESULT

The locator range is set up and highlighted in the ruler and the event display.

Moving Locator Ranges

In the ruler, you can move the locator range.

PREREQUISITE

You have set up a locator range.

PROCEDURE

1. Move the mouse pointer to the upper part of the ruler inside a locator range.
A hand symbol is shown.
 2. Click and drag to the left or to the right to move the locator range.
-

Setting the Project Cursor

You can set the project cursor to the position where you click, or to markers or other predefined positions.

PROCEDURE

- Do one of the following:
 - Hold down **Shift - Alt/Opt** and click in the **Project** window event display.
 - Click **Go to Previous Marker/Zero** or **Go to Next Marker/Project End**.
These are available in the **Transport Controls** section of the **Project** window toolbar, the editor toolbars, the **Transport** panel, and the **Transport Bar**.

- Click in the lower part of the ruler.
 - Select **Transport > Set Project Cursor Position**, and select an entry in the submenu.
-

RELATED LINKS

[Transport Panel Sections](#) on page 254

[Ruler](#) on page 60

[Transport Menu](#) on page 259

[Transport](#) on page 1375

[Transport Bar](#) on page 264

[Left and Right Locators](#) on page 271

[Key Commands](#) on page 1313

Auto-Scroll Settings Menu

Auto-Scroll allows you to keep the project cursor visible in the window during playback.

If you activate **Auto-Scroll** on the toolbar of the **Project** window or one of the editors, the following modes are available in the **Select Auto-Scroll Settings** pop-up menu:

Page Scroll

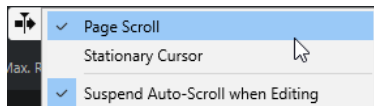

The project cursor moves from the left side to the right side of the window. When the project cursor reaches the right side of the window, the ruler and the project cursor jump to the left side of the window and start over again. This behavior can be compared to turning a page of a book.

Stationary Cursor

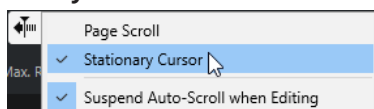

The project cursor is kept in the middle of the window and the ruler scrolls continuously to the left.

RELATED LINKS

[Project Window Toolbar](#) on page 48

Suspend Auto-Scroll When Editing

If you do not want the **Project** window display to change when editing during playback, activate **Suspend Auto-Scroll when Editing**.

Suspend Auto-Scroll when Editing is available as an option in the **Select Auto-Scroll Settings** pop-up menu to the right of the **Auto-Scroll** button.

If this option is activated, auto-scrolling is suspended as soon as you click anywhere in the event display during playback until playback stops or you click **Auto-Scroll** again.

As a visual feedback, the **Auto-Scroll** button changes its color.

Time Formats

You can set up different time formats.

Selecting the Primary Time Format

On the **Transport** panel, you can select the primary time format. This is the global display format that is used for all rulers and position displays in the program, except the ruler tracks.

PROCEDURE

1. In the main transport section on the **Transport** panel, click **Select Primary Time Format**.
2. Select a time format from the pop-up menu.

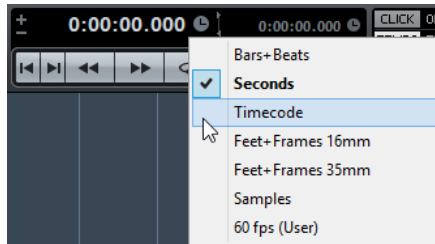

You can also select **Project > Project Setup > Display Format** to select the primary time format.

RESULT

The time format on the **Transport** panel and all rulers and position displays is updated.

Independent Time Displays

You can show time displays that are independent from the global display format.

To select an independent time display, do one of the following:

- In the ruler of the **Project** window or any editor, click the arrow button to the right of the ruler.
- Select **Project > Add Track > Ruler** to add a ruler track, and right-click the ruler.
- In the **Main Transport** section of the **Transport** panel, click **Select Secondary Time Format**.

RELATED LINKS

[Ruler](#) on page 60

[Ruler Track](#) on page 152

Pre-Roll and Post-Roll

You can activate pre-roll and post-roll with the corresponding buttons in the **Pre-roll & Post-roll** section on the **Transport** panel or by selecting **Transport > Pre-roll & Post-roll > Use Pre-roll/Use Post-roll**.

NOTE

To show the **Pre-roll & Post-roll** section, right-click anywhere in the **Transport** panel or in the **Transport Bar** and activate **Pre-roll & Post-roll**.

- By setting a pre-roll value, you instruct Nuendo to roll back a short section whenever playback is activated.

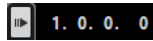

- By setting a post-roll value, you instruct Nuendo to play back a short section after automatic punch out before stopping.

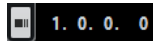

NOTE

This only works if **Punch Out** is activated on the **Transport** panel, and if **Stop after Automatic Punch Out** is activated in the **Preferences** dialog (**Record** page).

Using Pre-Roll and Post-Roll

You can set up a pre-roll and a post-roll value for recording.

PREREQUISITE

On the **Transport** panel, **Lock Punch Points to Locators** is activated.

PROCEDURE

1. Set the locators to where you want to start and end recording.
 2. On the **Transport** panel or in the **Transport Bar**, activate **Punch In** and **Punch Out**.
 3. In the **Preferences** dialog, select **Record**.
 4. Activate **Stop after Automatic Punch Out**.
 5. Right-click anywhere on the **Transport** panel or in the **Transport Bar** and activate **Pre-roll & Post-roll**.
 6. In the **Pre-roll & Post-roll** section, activate **Pre-roll** and **Post-roll** .
 7. In the **Pre-roll Amount** and **Post-roll Amount** fields, enter the pre-roll and post-roll values.
 8. Activate **Record**.
-

RESULT

The project cursor rolls back by the specified pre-roll value and playback starts. When the cursor reaches the left locator, recording is automatically activated. When the cursor reaches the right locator, recording is deactivated, but playback continues for the specified post-roll value before stopping.

Punch In and Punch Out

The punch in and the punch out points are a pair of markers that you can use for punch in and punch out of recordings. The punch in position determines the record start position and the punch out position determines the record stop position.

You can activate punch in and punch out by activating the corresponding buttons on the **Transport** panel.

The punch in position is locked to the left locator position and the punch out position to the right locator position. The punch position fields are unavailable.

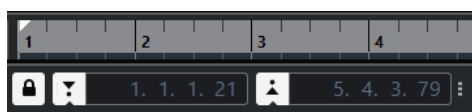

However, you can detach the punch points from the locators by deactivating **Lock Punch Points to Locators**.

If you do so, the value fields become available and you can use them to set up the punch positions independently from the locator positions.

You can also drag the punch in and punch out handles in the ruler to set the punch positions.

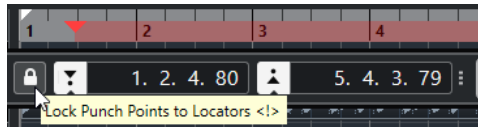

RELATED LINKS

[Activating Recording Automatically](#) on page 291

[Stopping Recording Automatically with Punch Out](#) on page 292

Metronome Click

You can use the metronome click as a timing reference for playing along and recording. The two parameters that govern the timing of the metronome are project tempo and the time signature that you can set up on the **Transport** panel.

- To activate the metronome click, activate **Activate Metronome Click** on the **Transport** panel.
You can also select **Transport > Activate Metronome** or use the corresponding key command.
- To define if the metronome click is played during playback, recording or count-in, select **Transport > Metronome Setup** and make your changes on the **General** tab.
- To set up the sounds for the metronome click, select **Transport > Metronome Setup** and make your changes on the **Click Sounds** tab.

RELATED LINKS

[Transport Panel Sections](#) on page 254

[Project Tempo Modes](#) on page 1132

Click Patterns

Click patterns allow you to create a custom metronome click.

By default, the metronome click in Nuendo has a 4/4 pattern with a fixed number of 4 clicks. The click level of the first click is high, while the level of the other beats is low.

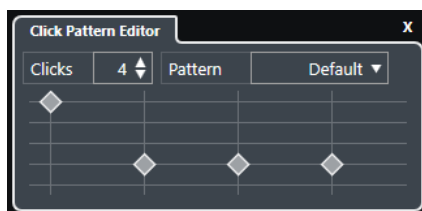

The default metronome click pattern with 4 clicks at a 4/4 time signature

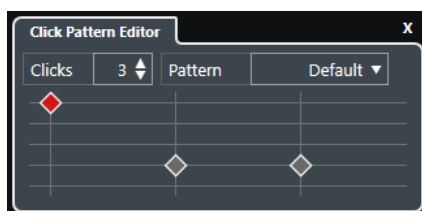

A metronome click pattern with 3 clicks at a 3/4 time signature

By setting up click patterns for the metronome at the current time signature, you can create a custom metronome click. You can determine the number of clicks and the level of the clicks to your liking.

If you have different project parts with different time signatures or tempos, and you want to set up different click patterns to match the rhythm and feel of these parts, you can set up a metronome click pattern for each signature event in your project.

You can also add the same time signature for different sections and set up different patterns for them.

NOTE

- If you want to visualize the current click pattern in the **Project** window, **Key Editor** or **Drum Editor** event display, activate **Use Metronome Click Pattern Level for Grid Line Emphasis** in the corresponding ruler context menu. This is useful if **Snap** is activated and the **Snap Type** is set to **Grid**.
- Grid lines are only emphasized if they are shown. If you want to visualize a click pattern that is set to **6 Clicks** and a **4/4 Time Signature**, you must set the **Grid Type** to a triplet value.

The **Click Patterns** tab in the **Metronome Setup** dialog allows you to manage the available click patterns. You can remove and rename them or create new click patterns for specific time signatures.

RELATED LINKS

[Click Pattern Editor](#) on page 278

[Setting up a Metronome Click Pattern](#) on page 279

[Setting up Metronome Click Patterns for Signature Events](#) on page 279

[Project Window Toolbar](#) on page 48

Click Pattern Editor

The **Click Pattern Editor** allows you to set up a click pattern for your project to create new grooves and feels for the metronome click. This is useful if you want to create a triplet pattern for a 4/4 signature, for example.

The **Click Pattern Editor** is available in the **Transport Bar**. If you add a signature track, it is available in the **Inspector** and on the info line.

- To open the **Click Pattern Editor** in the **Transport Bar**, click the points to the right of the **Click & Count-in & Click Pattern** section and drag all the way to the right. Click the pattern field to open the **Click Pattern Editor**.

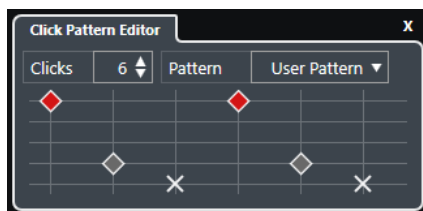

Clicks

Allows you to define the number of clicks that are used in the pattern.

Pattern

Allows you to select a pattern preset or to save your own ones. Which patterns are available depends on the current time signature, and on the settings in the **Metronome Setup** dialog on the **Click Patterns** tab.

NOTE

To view, edit and rename the pattern presets, open the **Click Patterns** tab in the **Metronome Setup** dialog.

Event display

Shows the defined number of beats for the selected pattern.

You can change the accent level for a beat by changing its vertical position in the event display. There are 4 different settings. These correspond to the settings in the **Metronome Setup** dialog on the **Click Sounds** tab. You can mute a beat by clicking the lowest vertical position.

RELATED LINKS

[Transport Bar Sections](#) on page 264

[Signature Track](#) on page 162

Setting up a Metronome Click Pattern

You can set up a different metronome click pattern for your project.

PROCEDURE

1. In the **Transport Bar**, click the points to the right of the **Click & Count-in & Click Pattern** section and drag all the way to the right to show the click pattern section.
 2. Click the pattern field to open the **Click Pattern Editor**.
 3. Do one of the following:
 - Open the **Pattern** pop-up menu and select one of the presets.
 - Use the **Clicks** setting to define the number of clicks that you want to hear, and click in the event display to set up a new click pattern.
 4. When you are done, click outside the **Click Pattern Editor** to close it.
 5. Activate the metronome click.
-

RESULT

The metronome click is played back with the defined click pattern.

RELATED LINKS

[Click Pattern Editor](#) on page 278

[Transport Bar Sections](#) on page 264

Setting up Metronome Click Patterns for Signature Events

You can set up a metronome click pattern for each signature event in your project. This is useful if you have different project parts with different time signatures, and you want to customize click patterns to the rhythm and feel of these parts. You can also add the same time signature for different sections and set up different patterns for them.

PROCEDURE

1. Double-click the plus sign to open the **Click Pattern Editor**.
2. Do one of the following:
 - Open the **Pattern** pop-up menu and select one of the presets.
 - Use the **Clicks** setting to define the number of clicks that you want to hear, and click in the event display to set up a new click pattern.
3. When you are done, click outside the **Click Pattern Editor** to close it.

4. Repeat this for each signature event for which you want to set up a click pattern.
-

RESULT

If you play back the project and activate the metronome click, the different project parts use the defined click patterns. The **Click Pattern Editor** in the **Transport Bar** shows the pattern at the project cursor position.

RELATED LINKS

[Click Pattern Editor](#) on page 278

[Signature Track](#) on page 162

[Time Signature Events](#) on page 1149

Metronome Setup Dialog

The **Metronome Setup** dialog allows you to make settings for the metronome.

To open the **Metronome Setup** dialog, do one of the following:

- Select **Transport > Metronome Setup**.
- In the **Transport Bar**, open the **Click & Count-in & Click Pattern** section, and click **Open Metronome Setup**.

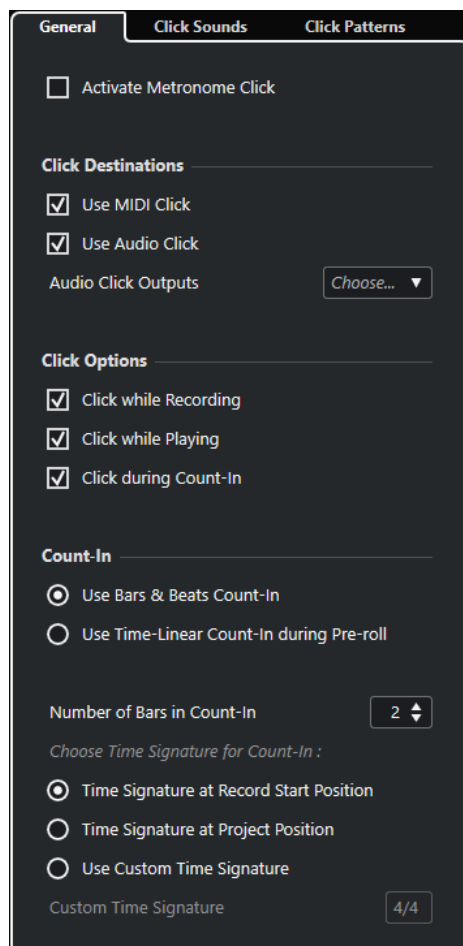

RELATED LINKS

[General Tab](#) on page 281

[Click Sounds Tab](#) on page 282

[Click Patterns Tab](#) on page 284

[Transport Bar Sections](#) on page 264

General Tab

The **General** tab allows you to make basic metronome settings.

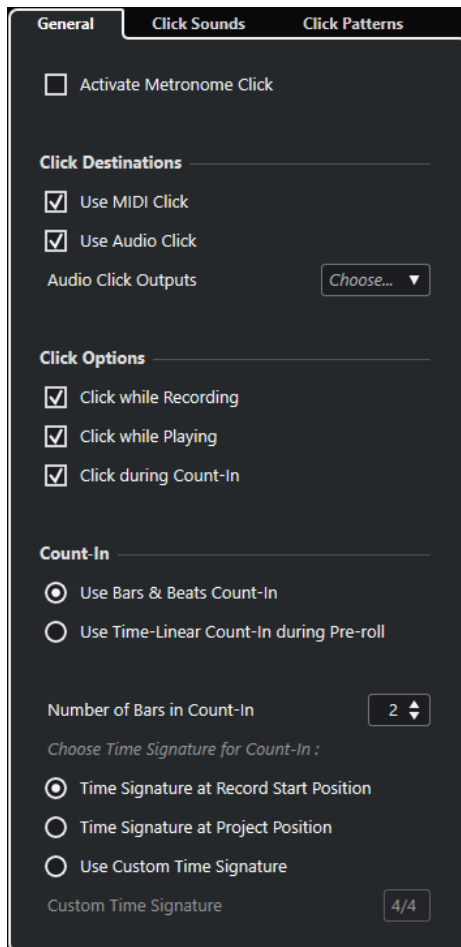

In the topmost section, the following options are available:

Activate Metronome Click

Activates/Deactivates the metronome click.

In the **Click Destinations** section, the following options are available:

Use MIDI Click

Activates a MIDI click for the metronome.

Use Audio Click

Activates an audio click for the metronome that is output via the audio hardware.

Audio Click Outputs

If you use multiple output busses, this allows you to activate the output bus where you want to route the metronome click.

In the **Click Options** section, the following options are available:

Click while Recording

Activates the metronome click during recording.

Click while Playing

Activates the metronome click during playback.

Click during Count-In

Activates a musical count-in that is played when you start recording from stop mode.

In the **Count-In** section, the following options are available:

Use Bars & Beats Count-In

The following options are available:

- **Number of Bars in Count-In**
Allows you to set the number of bars that the metronome counts in before recording starts.
- **Time Signature at Record Start Position**
Activate this to let the count-in automatically use the time signature and tempo set at the position where recording starts.
- **Time Signature at Project Position**
Activate this to let the count-in use the time signature at the project position.
- **Use Custom Time Signature**
Allows you to set a time signature for the count-in. In this mode, signature changes in the project do not affect the count-in.

Use Time-Linear Count-In during Pre-roll

The following options are available:

- **Count-In Click Count**
This allows you to set the number of clicks you hear during the pre-roll, before playback or recording starts.
- **Interval in Seconds**
This allows you to define a time interval for the clicks. You can calculate the position of the first click by multiplying the count-in click value with the specified interval and subtracting this value from the position of the left locator.
- **Emphasis**
This allows you to select an emphasized click. This is useful if you want to have an audible difference between the first and/or last click and the other clicks.

Click Sounds Tab

The **Click Sounds** tab allows you to set up and audition the MIDI click and the audio click. You can use the default audio or MIDI click, choose from a list of factory preset sounds, or assign your own custom sounds.

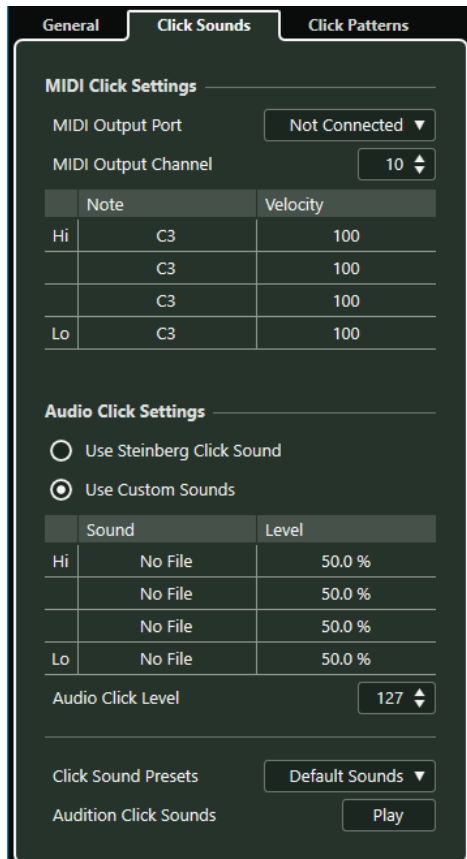

The **MIDI Click Settings** section allows you to set up the MIDI click that sounds if you activate **Use MIDI Click** in the **Click Destinations** section on the **General** tab.

MIDI Output Port

Allows you to select a MIDI output port for the MIDI click. You can also select a VST instrument previously set up in the **VST Instruments** window.

MIDI Output Channel

Allows you to select a MIDI output channel for the MIDI click.

Note

Allows you to set the MIDI note number, that is, the pitch from C-2 to G8. Set the note number for the first beat in a bar in the top row, and the note numbers for the other beats in the rows below.

Velocity

Allows you to set the velocity of the MIDI click sound. Set the velocity for the first beat in a bar in the top row, and the velocities for the other beats in the rows below.

The **Audio Click Settings** section allows you to set up the audio click that sounds if you activate **Use Audio Click** in the **Click Destinations** section on the **General** tab.

Use Steinberg Click Sound

Activates the default sounds for the metronome click.

Pitch

Allows you to set the pitch for the default sounds. Set the pitch for the first beat in a bar in the top row, and the pitches for the other beats in the rows below.

Level

Allows you to set the level for the default sounds. Set the level for the first beat in a bar in the top row, and the levels for the other beats in the rows below.

Use Custom Sounds

Activates custom sounds for the metronome click. For this to work, you must select an audio file for the custom sounds by clicking in the **Sound** column.

Sound

Allows you to select an audio file for the custom sounds. Select an audio file for the first beat in a bar in the top row, and the audio files for the other beats in the rows below.

Level

Allows you to set the level for the custom sounds. Set the level for the first beat in a bar in the top row, and the levels for the other beats in the rows below.

Audio Click Level

Allows you to adjust the level of the audio click.

Click Sound Presets

Allows you to load one of the click sound presets that supports up to 4 accents. Amongst other click sounds that are suited for a broad range of applications, you can also select **Steinberg Click Sound**, the default click sound of Nuendo. You can also create your own presets and save them.

Audition Click Sounds

Click **Play** to audition the activated click sounds.

Setting up a Custom Audio Click Sound

If you do not want to use the default click sound, you can set up your own custom sound.

PREREQUISITE

In the **Metronome Setup** dialog on the **General** tab, **Activate Metronome Click** is activated. In the **Click Destinations** section, **Use Audio Click** is activated.

PROCEDURE

1. Open the **Click Sounds** tab, and in the **Audio Click Settings** section, activate **Use Custom Sounds**.
2. In the **Sound** column, click the top row.
3. In the file dialog, navigate to the audio file that you want to use as a custom sound for the first beat and select it.
4. Click **Open**.
5. Click the other rows to select audio files for the other beats.
6. Set the level of the sounds by clicking the respective rows in the **Level** column and adjusting the value.
7. Optional: Click **Play** to audition the custom sounds.

RESULT

The metronome uses the defined custom sounds for the audio click.

AFTER COMPLETING THIS TASK

Open the **Click Sound Presets** pop-up menu and save your custom sounds as a preset.

Click Patterns Tab

The **Click Patterns** tab allows you to manage click patterns. Click patterns allow you to edit the default metronome click.

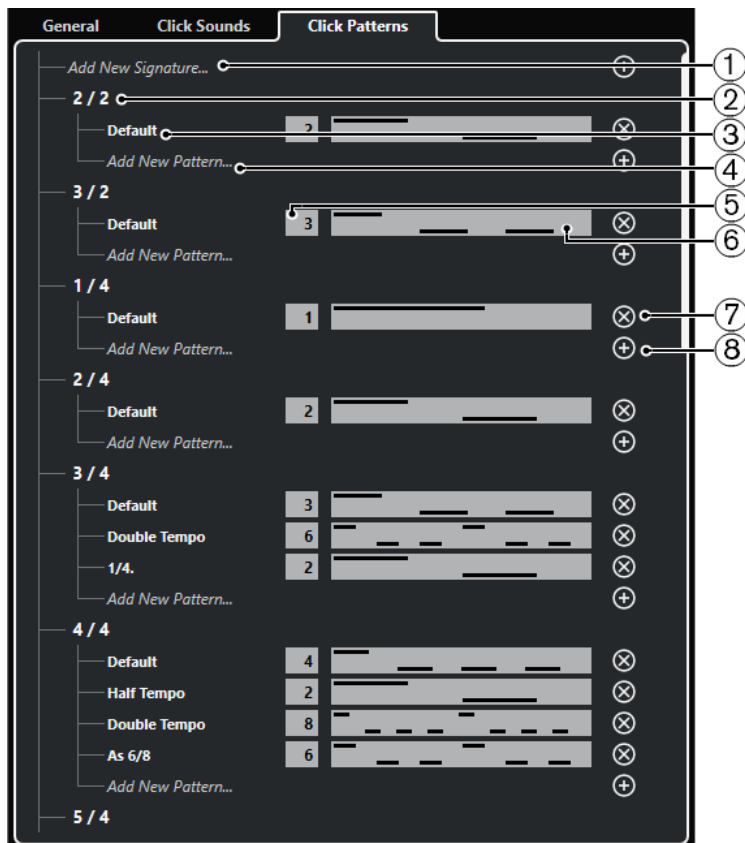

The following options are available:

- 1 Add New Signature**
Click and enter a time signature value to add a new time signature.
- 2 Available Time Signatures**
Shows the available time signatures.
- 3 Available Patterns**
Shows the available click patterns.
- 4 Add New Pattern**
Double-click to add a new click pattern for the time signature.
- 5 Clicks**
Allows you to change the number of clicks used in the click pattern.
- 6 Click Pattern**
Shows the click pattern. You can open the **Click Pattern Editor** by clicking the pattern.
- 7 Remove Click Pattern**
Removes the click pattern from the list of available patterns.
- 8 Add New Pattern**
Adds a new default click pattern for the time signature.

NOTE

If you scroll all the way down, you can reset all click patterns to the factory settings by clicking **Reset to Factory Patterns**.

You can double-click the name of a pattern to rename it.

Setting Up a Time-Based Count-In

You can set up a time-linear count-in as a timing reference for your recordings. This is useful for postproduction scenarios where projects are rather time based than referencing to bars and beats.

A typical use case would be the synchronization of voice-overs or dubbing versions. In these scenarios, you find yourself frequently jumping to positions from which you want the recording to start. By setting the locators to the sections that you want to record and defining a time-linear count-in, you can quickly assign, locate, and hear the record start position in your project.

PROCEDURE

1. Select **Transport > Activate Metronome** to activate the metronome click.
2. Right-click anywhere on the **Transport** panel or in the **Transport Bar** and activate **Pre-roll & Post-roll**.
3. In the **Pre-roll & Post-roll** section, activate **Pre-roll** and set up a suitable pre-roll value.

NOTE

The time-linear count-in only works, if you activate **Pre-roll**.

4. Select **Transport > Common Record Modes** and activate **Start Recording at Left Locator/Punch In Position**.
5. Select **Transport > Metronome Setup**, and open the **General** tab.
6. In the **Count-In** section, activate **Use Time-Linear Count-In during Pre-Roll** and set it up according to your needs.
7. Click **OK** to save your settings and close the dialog.
8. Set the locators to the section that you want to record and activate recording.
If you want to record several sections, set up cycle markers for all sections that you want to record.

RESULT

The project cursor jumps back to the pre-roll position, and playback starts. The count-in is triggered as specified. When the cursor reaches the left locator, the count-in stops and recording starts. If you have unlocked the punch positions from the locator positions, recording starts when the project cursor reaches the punch in position.

Creating a Click Track

You can create an audio or a MIDI track that contains the click.

PROCEDURE

- Do one of the following:
 - Select **Project > Signature Track > Render Audio Click between Locators**.
 - Select **Project > Signature Track > Render MIDI Click between Locators**.

RESULT

- An audio track containing an audio event with the click is added to your project. The level corresponds to the **Audio Click Level** setting on the **Click Sounds** tab of the **Metronome Setup** dialog.
- A MIDI track containing a MIDI part with the click is added to your project. The output of the MIDI track is routed to the **MIDI Output Port** that you set up on the **Click Sounds** tab of the **Metronome Setup** dialog.

Chase

Chase is a function that makes sure your MIDI instruments sound as they should when you locate to a new position and start playback. This is accomplished by the program transmitting a number of MIDI messages to your instruments each time that you move to a new position in the project, making sure all MIDI devices are set up correctly with regard to program change, controller messages (such as MIDI volume), etc.

EXAMPLE

You have a MIDI track with a program change event inserted at the beginning. This event makes a synth switch to a piano sound.

At the beginning of the first chorus, you have another program change event which makes the same synth switch to a string sound.

You now play back the song. It begins with the piano sound and then switches to the string sound. In the middle of the chorus you stop and rewind to some point between the beginning and the second program change. The synth now still plays the string sound although in this section it really should be a piano.

The **Chase** function takes care of that. If program change events are set to be chased, Nuendo tracks the music back to the beginning, finds the first program change, and transmits it to your synth, setting it to the correct sound.

The same can apply to other event types as well. In the **Preferences** dialog (**MIDI** page), the **Chase Events** settings determine which event types are chased when you locate to a new position and start playback.

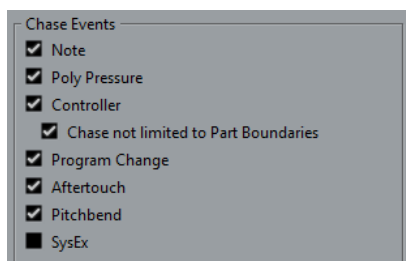

RELATED LINKS

[Chase Events](#) on page 1367

On-Screen Keyboard

The **On-Screen Keyboard** allows you to play and record MIDI notes by using your computer keyboard or mouse. This is useful if you have no external MIDI instrument at hand and you do not want to draw in notes with the **Draw** tool.

When the **On-Screen Keyboard** is displayed, the usual key commands are blocked because they are reserved for the **On-Screen Keyboard**. The only exceptions are:

- Save: **Ctrl/Cmd - S**
- Start/Stop Record: **Num ***
- Start/Stop Playback: **Space**
- Jump to Left Locator: **Num 1**
- Delete: **Delete** or **Backspace**
- Cycle on/off: **Num /**
- Show/Hide Transport panel: **F2**
- Show/Hide On-Screen Keyboard: **Alt/Opt - K**

Recording MIDI With the On-Screen Keyboard

You can use the **On-Screen Keyboard** to record MIDI in Nuendo.

PREREQUISITE

You have selected a MIDI or instrument track and activated **Record Enable**.

PROCEDURE

1. Select **Studio > On-Screen Keyboard**.
2. Activate **Record**.
3. Perform one of the following actions to enter some notes:
 - Click on the keys of the **On-Screen Keyboard**.
 - Press the corresponding key on your computer keyboard.

NOTE

Press several keys simultaneously to enter polyphonic parts. The maximum number of notes that can be played at one time varies between the different operating systems and hardware configurations.

AFTER COMPLETING THIS TASK

Close the **On-Screen Keyboard** to make all key commands available again.

On-Screen Keyboard Options

The **On-Screen Keyboard** offers different display modes as well as other options.

- To open the **On-Screen Keyboard**, select **Studio > On-Screen Keyboard**.

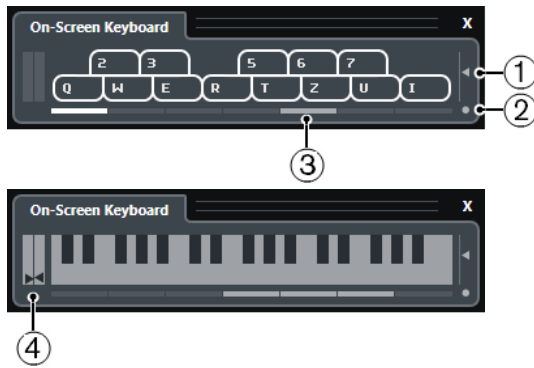

1 Note Velocity Level

This slider allows you to adjust the volume of the **On-Screen Keyboard**. You can also use **Up Arrow** or **Down Arrow** for this.

2 Change On-Screen Keyboard Type

This button allows you to switch between computer keyboard and piano keyboard display mode.

In computer keyboard mode, you can use the two rows of keys that are displayed on the **On-Screen Keyboard** to enter notes.

The piano keyboard has a wider range of keys. It allows you to enter more than one voice simultaneously. You can also use **Tab** for this.

3 Octave Offset

These buttons allow you to switch the keyboard range to a lower or higher octave. You have seven full octaves at your disposal. You can also use **Left Arrow** or **Right Arrow** for this.

4 Pitchbend/Modulation Sliders

These sliders are only available in piano keyboard mode. The left slider displays pitchbend, the right slider shows modulation changes. To introduce modulation, click on a key and drag upwards or downwards. To introduce pitchbend, drag left or right.

Recording

In Nuendo, you can record audio and MIDI.

Make the following initial preparations:

- Set up, connect, and calibrate your audio hardware.
- Open a project and set up the parameters in the **Project Setup** dialog according to your specifications.

The parameters in the **Project Setup** dialog determine the record file format, sample rate, project length, etc. that affect the audio recordings that you make during the course of the project.

- If you plan to record MIDI, set up and connect your MIDI equipment.

RELATED LINKS

[Setting up Audio](#) on page 17

[Setting up MIDI](#) on page 24

[Setting up a Metronome Click Pattern](#) on page 279

Basic Recording Methods

The basic recording methods apply to audio and MIDI recordings.

Record Enabling Tracks

To be able to record, you must record-enable the tracks on which you want to record.

PROCEDURE

- Do one of the following:
 - Activate **Record Enable** in the track list.
 - Activate **Record Enable** in the **MixConsole**.
 - Select the track that you want to record-enable, and activate **Record Enable** in the **Inspector**.

RESULT

The tracks are record-enabled.

NOTE

If you set up a key command for **Activate Record Enable for all Audio Tracks** in the **Mixer** category of the **Key Commands** dialog, you can record-enable all audio tracks simultaneously. The exact number of audio tracks that you can record simultaneously depends on your computer CPU and hard disk performance. Activate the **Warn on Processing Overloads** option in the **Preferences** dialog (**VST** page) to show a warning message as soon as the CPU overload indicator lights up during recording.

RELATED LINKS

[Editing - Project & MixConsole](#) on page 1360

[VST](#) on page 1378

Record Enabling Tracks on Selection

You can set up a preference so that tracks are record-enabled when you select them.

PROCEDURE

1. Select **Edit > Preferences**.
2. Open the **Editing—Project & MixConsole** page and activate **Enable Record on Selected Audio Track** or **Enable Record on Selected MIDI Track**.

RESULT

The tracks are record-enabled when you select them.

Activating Recording Manually

You can activate recording manually.

PROCEDURE

- Do one of the following:
 - Click **Record** on the **Transport** panel, on the toolbar, or in the **Transport Bar**.
 - Press **Num ***.

RESULT

Recording starts from the current cursor position.

NOTE

When you start recording in stop mode, you can start recording from the left locator. For this to work, you must select **Transport > Common Record Modes** and activate **Start Record at Left Locator/Punch In Position**. The pre-roll setting or the metronome count-in will be applied.

Activating Recording Automatically

Nuendo can automatically switch from playback to recording at a given position. This is useful if you must replace a section of a recording and want to listen to what is already recorded up to the recording start position.

PROCEDURE

1. Set the left locator to the position where you want to start recording.
If you want to set up the punch points independently from the locators, deactivate **Lock Punch Points to Locators** on the **Transport** panel, and set up the punch in and punch out positions in the value fields to the right.
2. Activate **Punch In** on the **Transport** panel.
3. Activate playback from any position before the left locator.

RESULT

If you have unlocked the punch positions from the locator positions, recording is automatically activated when the project cursor reaches the punch in position.

If cycle mode is activated, and the punch in point corresponds to the left locator position, and the punch out point is positioned before the right locator, recording is stopped at the punch out position and resumed at the punch in position.



If the punch positions are locked to the locators, recording is automatically activated when the project cursor reaches the left locator.

RELATED LINKS

[Punch In and Punch Out](#) on page 276

Stopping Recording

You can stop recording manually.

PROCEDURE

- Do one of the following:
 - Click **Stop** on the **Transport** panel.
 - Press **Num ***.

RESULT

Recording stops while playback continues.

Stopping Recording Automatically with Punch Out

Activating **Punch Out** allows you to stop recording automatically at the defined punch out position.

PROCEDURE

- Activate **Punch Out** on the **Transport** panel.

RESULT

Recording stops automatically when the project cursor reaches the punch out position. Playback continues.

NOTE

If you have unlocked the punch positions from the locator positions, recording is automatically stopped when the project cursor reaches the punch out position.

NOTE

If cycle mode is activated, the punch in point is set after the left locator, and the punch out point corresponds to the right locator, recording is started at the punch in position, stopped at the punch out position, and resumed at the punch in position.

RELATED LINKS

[Punch In and Punch Out](#) on page 276

Stopping Recording and Playback

You can stop recording and playback manually.

PROCEDURE

- Do one of the following:
 - Click **Stop** on the **Transport** panel.
 - Press **Num 0**.

RESULT

Recording and playback stops.

Cycle Recording

You can record in a cycle, that is, you can record a selected section repeatedly and seamlessly.

PREREQUISITE

A cycle is set up with the left and right locators.

PROCEDURE

1. Click **Activate Cycle** on the **Transport** panel to activate cycle mode.
2. Activate recording from the left locator, before or within the cycle.
As soon as the project cursor reaches the right locator, it jumps back to the left locator and continues recording a new lap.

RESULT

The results of cycle recording depend on the selected record mode. They also differ for audio and MIDI.

RELATED LINKS

[Left and Right Locators](#) on page 271

[MIDI Recording](#) on page 304

[Audio Recording](#) on page 299

Using Pre-Roll and Post-Roll

You can set up a pre-roll and a post-roll for recording.

PREREQUISITE

Activate **Stop after Automatic Punch Out** in the **Preferences** dialog (**Record** page).

PROCEDURE

1. Set the locators to where you want to start and end recording.
 2. On the **Transport** panel, activate **Punch In** and **Punch Out**.
 3. Activate **Pre-roll** and **Post-roll**.
 4. Specify a **Pre-roll Amount** and a **Post-roll Amount**.
 5. Click **Record**.
-

RESULT

The project cursor rolls back and starts playback at the time that has been set as pre-roll amount. When the cursor reaches the left locator, recording is automatically activated. When the cursor reaches the right locator, recording is deactivated, and playback continues for the time that has been set as post-roll amount.

Common Record Modes Menu

The **Common Record Modes** determine what happens if you click **Record** during an audio or MIDI recording.

- To access the record modes, select **Transport > Common Record Modes**.
You can also access the **Common Record Modes** by clicking the upper part of the **Record Modes** section on the **Transport** panel.

Punch In/Out

In this mode, the recording is stopped.

Re-Record

In this mode, the recording is reinitiated, the events are removed, and recording is restarted from the exact same position.

Start Recording at Project Cursor Position

In this mode, recording starts from the cursor position.

Start Recording at Left Locator/Punch In Position

In this mode, recording starts from the left locator.

RELATED LINKS

[Transport Menu](#) on page 259

[Transport Panel Sections](#) on page 254

Re-Recording

If you activate the **Re-Record** mode, you can reinitiate your recording by hitting the **Record** button again. Recording will restart from the initial position.

PROCEDURE

1. Select **Transport > Common Record Modes**, and activate **Re-Record**.
2. Activate recording.
3. Click **Record** again to restart recording.

RESULT

The project cursor jumps back to the record start position and recording is reinitiated. Pre-roll and count-in settings are taken into account.

NOTE

The previous recordings are removed from the project and cannot be retrieved using **Undo**. However, they remain in the **Pool**.

Monitoring

In Nuendo, monitoring means listening to the input signal while preparing to record or while recording.

The following ways of monitoring are available.

- Via Nuendo.
- Externally by listening to the signal before it reaches Nuendo.
- By using ASIO Direct Monitoring.
This is a combination of both other methods.

Monitoring via Nuendo

If you use monitoring via Nuendo, the input signal is mixed with the audio playback. This requires an audio hardware configuration with a low latency value.

PROCEDURE

1. In the track list, activate **Monitor**.



2. In the **MixConsole**, adjust the monitoring level and the panning.
You can add effects and EQ to the monitor signal using the track's channel. If you are using plug-in effects with large inherent delays, the automatic delay compensation function in Nuendo will increase the latency. If this is a problem, you can use the **Constrain Delay Compensation** function while recording.
3. In the **Preferences** dialog, select **VST**.
4. Open the **Auto Monitoring** pop-up menu and select a monitoring mode.

RESULT

The monitored signal will be delayed according to the latency value which depends on your audio hardware and drivers. You can check the latency of your hardware in the **Studio Setup** dialog (**Audio System** page).

RELATED LINKS

[VST](#) on page 1378

External Monitoring

External monitoring means listening to the input signal before it is sent into Nuendo. It requires an external mixer for mixing the audio playback with the input signal. The latency value of the audio hardware configuration does not affect the monitor signal. When using external monitoring, you cannot control the level of the monitor signal from within Nuendo or add VST effects or EQ to the monitor signal.

PROCEDURE

1. In the **Preferences** dialog, select **VST**.
 2. Open the **Auto Monitoring** pop-up menu and select **Manual**.
 3. Deactivate **Monitor** in Nuendo.
 4. On your mixing desk or mixer application for your audio hardware, activate the **Thru** or **Direct Thru** mode to send the input audio back out again.
-

ASIO Direct Monitoring

If your audio hardware is ASIO 2.0 compatible, it may support ASIO Direct Monitoring. This feature may also be available for audio hardware with macOS drivers. In ASIO Direct Monitoring mode, the monitoring is done in the audio hardware, and monitoring is controlled from Nuendo. The latency value of the audio hardware configuration does not affect the monitor signal when using ASIO Direct Monitoring.

PROCEDURE

1. In the track list, activate **Monitor**.



2. Select **Studio > Studio Setup**.
3. In the **Devices** list, select your audio hardware driver, and activate **Direct Monitoring**.
If the checkbox is grayed out, your audio hardware (or its driver) does not support ASIO Direct Monitoring. Consult the audio hardware manufacturer for details.
4. In the **Preferences** dialog, select **VST**.
5. Open the **Auto Monitoring** pop-up menu and select a monitoring mode.
6. In the **MixConsole**, adjust the monitoring level and panning.
Depending on the audio hardware, this might not be possible.

AFTER COMPLETING THIS TASK

You can monitor the input levels of audio tracks, that is, you can map the input bus metering to monitor-enabled audio tracks and watch the input levels of your audio tracks when working in the **Project** window.

- Activate **Map Input Bus Metering to Audio Track (in Direct Monitoring)** in the **Preferences** dialog (**Metering** page).
As the tracks are mirroring the input bus signal you will see the same signal in both places. When using mapped metering, any functions that you apply to the audio track are not reflected in its meters.

NOTE

With Direct Monitoring activated, Direct Routing cannot be used for routing destinations 2-8. Only the first bus can be used for Direct Monitoring.

RELATED LINKS

[VST on page 1378](#)

Monitoring MIDI Tracks

You can monitor everything you play and record through the MIDI output and channel that are selected for the MIDI track.

PREREQUISITE

Local Off is activated on your MIDI instrument.

PROCEDURE

1. In the **Preferences** dialog, select **MIDI**.
2. Make sure **MIDI Thru Active** is activated.
3. In the track list, activate **Monitor**.



RESULT

Incoming MIDI is echoed back out again.

RELATED LINKS

[MIDI](#) on page 1367

Audio Recording Specifics

Specific preparations and settings are required for audio recording.

Audio Recording Preparations

Before you can record audio, you must make some preparations.

Selecting a Record File Format

You can set up the record file format, that is, the sample rate, bit depth, and record file type for new audio files.

PROCEDURE

1. Select **Project > Project Setup**.
2. Set up the settings for **Sample Rate**, **Bit Depth**, and **Record File Type**.

IMPORTANT

The bit depth and file type can be changed at any time while the sample rate of a project cannot be changed at a later stage.

RELATED LINKS

[Creating New Projects](#) on page 103

Setting the Audio Record Folder

Each Nuendo project has a project folder containing an **Audio** folder. By default, this is where recorded audio files are stored. However, you can select record folders independently for each audio track if needed.

PROCEDURE

1. In the track list, select all tracks to which you want to assign the same record folder.
2. Right-click one of the tracks to open the context menu.
3. Select **Set Record Folder**.
4. In the file dialog, navigate to the folder that you want to use as record folder or create a new folder by clicking **New Folder**.

If you want to have separate folders for different types of material (speech, ambient sounds, music, etc.), you can create subfolders within the project **Audio** folder and assign different tracks to different subfolders. This way, all audio files still reside within the project folder, which makes managing the project easier.

Getting the Track Ready for Recording

Before you can record audio, you must add a track and set it up.

Adding a Track and Setting the Channel Configuration

To record audio, you must add an audio track and set up its channel configuration. The channel configuration of the track determines the channel configuration of the recorded audio file.

PROCEDURE

1. In the global track controls area of the track list, click **Add Track** .
 2. Click **Audio**.
 3. In the **Count** value field, select the number of tracks that you want to add.
 4. Open the **Configuration** pop-up menu and select a channel configuration.
 5. Optional: In the **Name** field, enter a track name.
 6. Click **Add Track**.
-

RELATED LINKS

[Add Track Dialog – Audio](#) on page 128

RAM Requirements for Recording

Each track on which you record requires a certain amount of RAM, and the memory usage increases the longer the recording lasts. For each audio channel, 2.4 MB of RAM are required for **MixConsole** settings, etc. The memory usage increases with the length of the recording, the sample rate, and the number of tracks you record. Consider the RAM limitation of your operating system when setting up your project for recording.

Selecting an Input Bus for the Track

Before you can record on your track, you must add and set up the required input busses and specify from which input bus the track will record.

PROCEDURE

1. In the **Inspector** for the audio track, open the **Input Routing** pop-up menu.

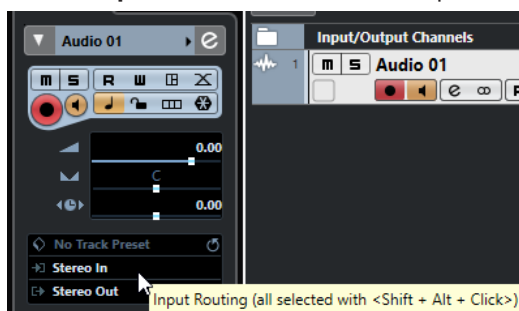

2. Select an input bus.
-

RELATED LINKS

[Setting up Input and Output Ports](#) on page 23

[Audio Bus Setup](#) on page 24

[Audio Track Inspector](#) on page 130

Audio Recording

You can record audio using any of the basic recording methods.

When you finish recording, an audio file is created in the **Audio** folder within the project folder. In the **Pool**, an audio clip is created for the audio file, and an audio event that plays the whole clip appears on the recording track. Finally, a waveform image is calculated for the audio event. If the recording was very long, this may take a while.

NOTE

The waveform image is calculated and displayed during the actual recording process. This real-time calculation uses some processing power. If your processor is slow or if you are working on a CPU-intensive project, deactivate **Create Audio Images during Record** in the **Preferences** dialog (**Record—Audio** page).

RELATED LINKS

[Basic Recording Methods](#) on page 290

[Cycle Recording](#) on page 293

Audio Record Modes

By selecting an **Audio Record Mode**, you decide what happens to your recording and to any existing events on the track where you are recording. This is necessary because you will not always record on an empty track. There may be situations where you record over existing events, especially in cycle mode.

- To access the record modes, select **Transport > Audio Record Mode**.
You can also access the **Audio Record Modes** by clicking to the right of the audio symbol in the **Record Modes** section on the **Transport** panel.

Keep History

Existing events or portions of events that are overlapped by a new recording are kept.

Cycle History + Replace

Existing events or portions of events that are overlapped by a new recording are replaced by the new recording. However, if you record in cycle mode, all takes from the current cycle recording are kept.

Replace

Existing events or portions of events that are overlapped by a new recording are replaced by the last recorded take.

RELATED LINKS

[Transport Menu](#) on page 259

[Transport Panel Sections](#) on page 254

Recording and Effects

Nuendo allows you to add effects and/or EQ directly while recording. This is done by adding insert effects and/or making EQ settings for the input channel in the **MixConsole**.

IMPORTANT

If you record with effects, the effects become part of the audio file itself. You cannot change the effect settings after recording.

When you are recording with effects, consider using 32-bit float or 64-bit float format. This way, the bit depth will not be reduced, which means there is no risk of clipping at this stage. Also, this preserves the signal quality perfectly. If you record in 16-bit or 24-bit format, the available headroom is lower, which means clipping can occur if the signal is too loud.

Recording a Mix of Separate Tracks

You can create a downmix of separate tracks, bass drum, hi-hats, or snare, for example. This is done by selecting an output bus, a group bus, or an FX channel bus as an input for your recording.

PROCEDURE

1. Set up your separate tracks and add a group track.
2. For each of the drum tracks, open the **Output Routing** pop-up menu and select the group track as output.
3. Create a new audio track, open the **Input Routing** pop-up menu and select the group track as input for this audio track.
4. Record-enable this audio track and start recording.

RESULT

The output of the group track will be recorded on the new track and you will get a mix of your separate tracks.

NOTE

You can also select an FX channel as recording source. In this case, only the output of the FX channel will be recorded.

RELATED LINKS

[Routing](#) on page 437

Undoing Recordings

You can undo a recording immediately after recording it.

PROCEDURE

- Select **Edit > Undo**.

RESULT

- The events that you just recorded are deleted from the **Project** window.
- The audio clips in the **Pool** are moved to the trash folder.

AFTER COMPLETING THIS TASK

To remove the recorded audio files from the hard disk, select **Media > Open Pool Window**, right-click the **Trash** icon and select **Empty Trash**.

RELATED LINKS

[Pool Window](#) on page 675

Recovery of Audio Recordings

Nuendo allows you to recover audio recordings.

You can recover audio recordings in two situations:

- You hit **Record** too late.
For this to work, you must specify an audio pre-record time.
- The system failed during recording.

Specifying an Audio Pre-Record Time

You can capture up to 1 minute of any incoming audio that you play in stop mode or during playback. This is possible because Nuendo can capture audio input in buffer memory, even when not recording.

PROCEDURE

1. In the **Preferences** dialog, select **Record > Audio**.
2. Specify a time (up to 60 seconds) in the **Audio Pre-Record Seconds** field.
This activates the buffering of audio input, making pre-record possible.
3. Make sure that an audio track is record-enabled and receives audio from the signal source.
4. When you have played some audio material that you want to capture (either in stop mode or during playback), click **Record**.
5. Stop the recording after a few seconds.
This creates an audio event that starts where the cursor position was when you activated recording. If you were in stop mode, and the cursor was at the beginning of the project, you may have to move the event to the right in the next step. If you were playing along to a project, you leave the event where it is.
6. Select the **Object Selection** tool and place the cursor on the bottom left edge of the event so that a double arrow appears. Then click and drag to the left.

RESULT

The event is now extended, and the audio that you played before activating the recording is inserted. This means that if you played along during playback, the captured notes end up exactly where you played them in relation to the project.

RELATED LINKS

[Record - Audio](#) on page 1372

Recovery of Audio Recordings after System Failure

Nuendo allows you to recover audio recordings after a system failure, because of a power cut or other mishap, for example.

When you experience a computer crash during a recording, relaunch the system and check the project record folder. By default, this is the **Audio** subfolder inside the project folder. It should contain the audio file that you recorded, from the moment when you started recording to the time when your computer crashed.

NOTE

- This feature does not constitute an overall guarantee by Steinberg. While the program itself was improved in such a way that audio recordings can be recovered after a system failure, it is always possible that a computer crash, power cut, etc. might have damaged another component of the computer, making it impossible to save or recover any of the data.

- Do not try to actively bring about this kind of situation to test this feature. Although the internal program processes have been improved to cope with such situations, Steinberg cannot guarantee that other parts of the computer are not damaged as a consequence.
-

MIDI Recording Specifics

Specific preparations and settings are required for MIDI recordings.

RELATED LINKS

[MIDI Recording Specifics](#) on page 302

[Recording in MIDI Editors](#) on page 304

[MIDI Record Modes](#) on page 306

MIDI Recording Preparations

The preparations described in the following sections mainly focus on external MIDI devices.

MIDI Instruments and Channels

Most MIDI synthesizers can play several sounds at the same time, each on a different MIDI channel. This allows you to play back several sounds (bass, piano, etc.) from the same instrument.

Some devices, such as General MIDI compatible sound modules, always receive on all 16 MIDI channels. If you have such an instrument, there is no specific setting to make in the instrument.

On other instruments, you must use the front panel controls to set up a number of parts, timbres, or similar so that they all receive on one MIDI channel.

For more information, refer to the manual that came with your instrument.

Naming MIDI Ports

MIDI inputs and outputs are often displayed with long and complicated names. In Nuendo, you can rename your MIDI ports to more descriptive names.

PROCEDURE

1. Select **Studio > Studio Setup**.
 2. In the **Devices** list, select **MIDI Port Setup**.
The available MIDI inputs and outputs are listed. On Windows, the device to choose depends on your system.
 3. Click in the **Show As** column and type in a new name.
 4. Click **OK**.
-

RESULT

The new port names appear on the **Input Routing** and **Output Routing** pop-up menus.

Setting the MIDI Input

In the **Inspector**, you set the MIDI input for the track.

PROCEDURE

1. In the track list, select the track to which you want to assign a MIDI input.

2. In the topmost **Inspector** section, open the **Input Routing** pop-up menu and select an input.

The available inputs depend on the type of MIDI interface that you are using. If you hold down **Shift - Alt/Opt**, the selected MIDI input is used for all selected MIDI tracks.

NOTE

If you select **All MIDI Inputs**, the track will receive MIDI data from all available MIDI inputs.

Setting the MIDI Channel and Output

The MIDI channel and output settings determine where the recorded MIDI is routed during playback. They are also relevant for monitoring MIDI in Nuendo. You can select the channel and output in the track list or in the **Inspector**.

PROCEDURE

1. In the track list, select the track to which you want to assign a MIDI channel and output.
2. In the topmost **Inspector** section, open the **Output Routing** pop-up menu and select an output.

The available outputs depend on the type of MIDI interface that you are using. If you hold down **Shift - Alt/Opt**, the selected MIDI output is used for all selected MIDI tracks.

3. Open the **Channel** pop-up menu and select a MIDI channel.

NOTE

If you select the **Any** MIDI channel, the MIDI material is routed to the channels that are used by your MIDI instrument.

Selecting a Sound

You can select sounds from within Nuendo by instructing the program to send Program Change and Bank Select messages to your MIDI device.

PROCEDURE

1. In the track list, select the track to which you want to assign a sound.
2. In the track list or the **Inspector**, open the **Program Selector** pop-up menu and select a program.

Program Change messages give access to 128 different program locations.

3. If your MIDI instruments have more than 128 programs, you can open the **Bank Selector** pop-up menu and select different banks, each containing 128 programs.

NOTE

Bank Select messages are recognized differently by different MIDI instruments. The structure and numbering of banks and programs may also vary. Refer to the documentation of your MIDI instruments for details.

RELATED LINKS

[MIDI Track Inspector](#) on page 140

Recording in MIDI Editors

You can record MIDI data into the MIDI part that is opened in a MIDI editor.

PREREQUISITE

You have selected **Merge** or **Replace** as **MIDI Record Mode**.

PROCEDURE

1. Click in the MIDI editor so that it gets the focus.
 2. In the MIDI editor toolbar, activate **Record in Editor**.
 3. Do one of the following to activate recording:
 - Click **Record** on the **Transport** panel.
 - Click **Record** on the toolbar.
-

RESULT

The MIDI data is recorded into the MIDI part that is opened in the MIDI editor. If you record outside the part borders, the part is automatically enlarged.

RELATED LINKS

[Key Editor Toolbar](#) on page 948

MIDI Recording

You can record MIDI using any of the basic recording methods.

When you finish recording, a part that contains MIDI events is created in the **Project** window.

NOTE

If you perform a live recording on a VST instrument, you usually compensate the latency of the audio card by playing earlier. In consequence, the timestamps are recorded too early. If you activate **ASIO Latency Compensation** on the track list, all recorded events are moved by the current latency setting.

The following preferences affect MIDI recording:

- Length Adjustment
- Snap MIDI Parts to Bars
- MIDI Record Catch Range in ms
- ASIO Latency Compensation Active by Default

You can find them in the **Preferences** dialog on the **MIDI** and on the **Record—MIDI** page.

RELATED LINKS

[Basic Recording Methods](#) on page 290

[MIDI](#) on page 1367

[Record - MIDI](#) on page 1372

Types of MIDI Messages

You can record different types of MIDI messages.

- To specify which event types are recorded, deactivate the options for the type of MIDI message that you want to record in the **Preferences** dialog (**MIDI—MIDI Filter** page).

RELATED LINKS

[MIDI - MIDI Filter](#) on page 1370

Note Messages

Cubase records note on, note off, and MIDI channel messages.

If you press and release a key on your synthesizer or on another MIDI keyboard, the following messages are recorded:

- Note On (key down)
- Note Off (key up)
- MIDI channel

NOTE

Normally, the MIDI channel information is overridden by the MIDI channel setting for the track. However, if you set the track to the **Any** MIDI channel, the notes will be played back on their original channels.

Continuous Messages

Pitchbend, aftertouch, and controllers, such as modulation wheel, sustain pedal, volume, etc. are considered MIDI continuous events, as opposed to the momentary key down and key up messages.

You can record continuous messages together or independently from the notes, that is, afterwards or before.

You can record continuous messages on their own tracks, separately from the notes to which they belong. As long as you set the two tracks to the same output and MIDI channel, it will appear to the MIDI instrument as if you made the two recordings at the same time.

Program Change Messages

When you switch from one program to another on your synthesizer or on another MIDI keyboard, a number corresponding to that program is sent out via MIDI as a Program Change Message.

You can record Program Change Messages together or independently from the notes, that is, afterwards or before.

You can record Program Change Messages on their own tracks, separately from the notes to which they belong. As long as you set the two tracks to the same output and MIDI channel, it will appear to the MIDI instrument as if you made the two recordings at the same time.

System Exclusive Messages

System Exclusive (SysEx) messages are special types of MIDI messages that are used to send data that only makes sense to a unit of a certain make and type.

SysEx can be used to transmit a list of the numbers that make up the settings of one or more sounds in a synth.

Reset Function

The **Reset** function sends out note-off messages and resets controllers on all MIDI channels. This is sometimes necessary if you experience hanging notes, constant vibrato, etc. when punching in and out on MIDI recordings with pitchbend or controller data.

- To perform a MIDI reset manually, select **MIDI > Reset**.

- If you want Nuendo to perform a MIDI reset on stop, activate **Reset on Stop** in the **Preferences** dialog (**MIDI** page).
- If you want Nuendo to insert a reset event at the end of a recorded part, activate **Insert Reset Events after Record** in the **Preferences** dialog (**MIDI** page).
This resets controller data such as sustain, aftertouch, pitchbend, modulation, and breath control. This is useful if a MIDI part is recorded and the sustain pedal is still held after stopping recording. Usually, this would cause all following parts to be played with sustain, as the pedal off command was not recorded.

RELATED LINKS

[MIDI](#) on page 1367

MIDI Record Modes

By selecting a **MIDI Record Mode** you decide what happens to any existing parts on the track where you are recording. MIDI tracks can play back all events in overlapping parts. If you record several parts in the same locations or move parts so that they overlap, you will hear the events in all parts.

NOTE

If you activate **Record in Editor** to record MIDI data in the editor, all new recordings are merged into the active part, and the **MIDI Record Modes** do not apply.

- To access the record modes, select **Transport > MIDI Record Mode**.
You can also access the **MIDI Record Modes** by clicking to the right of the MIDI symbol in the **MIDI Recording Modes** section on the **Transport** panel.

MIDI Record Mode

New Parts

Existing parts that are overlapped by a new recording are kept. The new recording is saved as a new part.

Merge

Existing events in parts that are overlapped by a new recording are kept. The newly recorded events are added to the existing part.

Replace

Existing events in parts that are overlapped by a new recording are replaced.

MIDI Cycle Record Mode

When you record MIDI in cycle mode, the result not only depends on the MIDI record mode, but also on the cycle record mode that is selected in the **Cycled MIDI Recording Only** section.

Mix

For each completed lap, everything you record is added to what was previously recorded. This is useful for building up rhythm patterns. Record a hi-hat part on the first lap, the bass drum part on the second lap, etc.

Overwrite

As soon as you play a MIDI note or send any MIDI message, all MIDI that you have recorded on previous laps is overwritten from that point. Make sure that you stop playing before the next lap begins. Otherwise, you will overwrite the entire take.

Keep Last

Each completed lap replaces the previously recorded lap. If you deactivate recording or press **Stop** before the cursor reaches the right locator, the previous take will be kept. If you do not play or input any MIDI during a lap, nothing happens, and the previous take will be kept.

Stacked

Each recorded cycle lap is turned into a separate MIDI part, and the track is divided into lanes, one for each cycle lap. The parts are stacked above each other, each on a different lane. All takes but the last one are muted.

Mix-Stacked (No Mute)

Same as **Stacked**, but parts are not muted.

RELATED LINKS

[MIDI Recording Specifics](#) on page 302

[Recording in MIDI Editors](#) on page 304

[Transport Menu](#) on page 259

[Transport Panel Sections](#) on page 254

Automatic MIDI Record Quantize

Nuendo can automatically quantize MIDI notes on recording.

- **Automatic MIDI Record Quantize**  is available in the **MIDI Auto Quantize** section of the **Transport Bar**.

If you activate **Auto Quantize**, the notes that you record are automatically quantized according to the quantize settings.

RELATED LINKS

[Quantizing MIDI and Audio](#) on page 321

[Quantize Panel](#) on page 326

Recovery of MIDI Recordings

Nuendo allows you to recover MIDI data, including controller data, that was captured in **Stop** mode or during playback.

The MIDI data is stored in the retrospective record buffer, and you can insert it as a MIDI part on the selected MIDI track.

The buffer captures up to 10000 MIDI events. This can correspond to a MIDI recording of around 2 minutes and 30 seconds. However, if you use a keyboard that produces a large amount of MIDI controller events, such as the ROLI Seaboard, this only corresponds to a recording of around 20 seconds.

NOTE

In the **Preferences** dialog (**Record—MIDI** page), you can specify a **Retrospective Record Buffer Size**.

If the buffer is full, the MIDI events that were captured first are replaced by the new events. MIDI events in the buffer are also replaced in the following situations:

- When you have inserted the retrospective recording on a track and you play new events in **Stop** mode or during playback.

- When you play MIDI notes in **Stop** mode and you do not play for more than 30 seconds, before playing more MIDI events in **Stop** mode.

NOTE

You can also empty the buffer manually.

RELATED LINKS

[Record - MIDI](#) on page 1372

[Emptying the Retrospective Record Buffer](#) on page 310

Inserting a Retrospective Recording from All MIDI Inputs on the Selected Track

You can insert a retrospective recording, that is, MIDI data that was sent to **All MIDI Inputs** in **Stop** mode or during playback, on the selected track.

PREREQUISITE

You have played some MIDI notes in **Stop** mode or during playback, and you want to recover them.

PROCEDURE

1. Select the MIDI track on which you want to insert the captured MIDI data.
 2. Select **Transport > MIDI Retrospective Recording > Insert from All MIDI Inputs**.
-

RESULT

The MIDI data that was captured at **All MIDI Inputs** is inserted on the selected track as one, linear MIDI part.

NOTE

If you insert buffer data from multiple selected tracks, the timing offsets between the data played on the different tracks are retained.

NOTE

If your MIDI track uses MIDI inserts, and **Record Output to Track** is enabled in the **MIDI Inserts** section, the buffer data includes the events that are created by the MIDI inserts.

RELATED LINKS

[Recording a MIDI Insert Effect](#) on page 888

[MIDI Inserts](#) on page 887

Inserting a Retrospective Track Recording

You can insert a retrospective track recording, that is, MIDI data that was sent to the track input in **Stop** mode or during playback, on the selected track.

PREREQUISITE

You have played some MIDI notes in **Stop** mode or during playback, and you want to recover them.

PROCEDURE

1. Select the MIDI track on which you want to insert the captured MIDI data.
2. In the top section of the MIDI track **Inspector**, click **Retrospective Recording**.

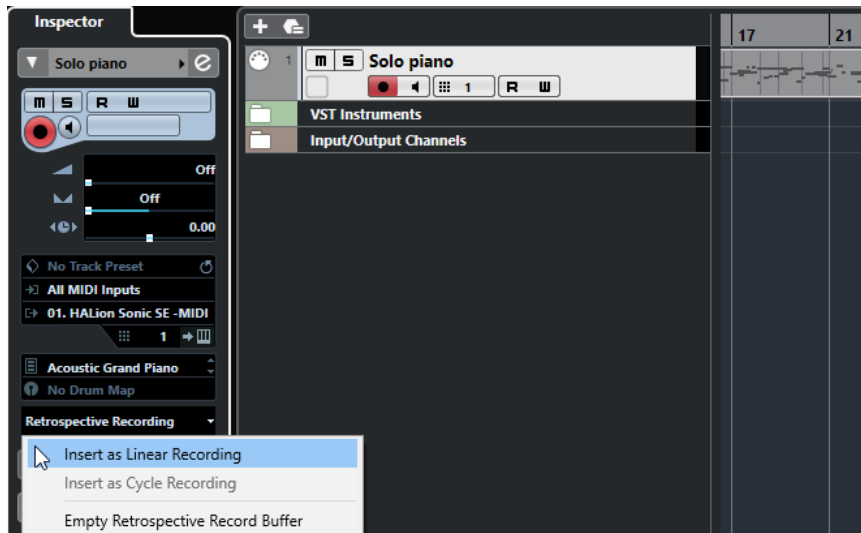

3. From the pop-up menu, select one of the following:
 - To insert the MIDI data as one, continuous MIDI part, select **Insert as Linear Recording**.
 - To insert the MIDI data as stacked MIDI parts, select **Insert as Cycle Recording**.

NOTE

This is only available if your MIDI data was captured during playback, and cycle mode was active.

RESULT

The MIDI data that was captured at the track input is inserted on the track.

NOTE

If the data was captured during playback, it is inserted at the position where you played it. If the data was captured in **Stop** mode, it is inserted at the project cursor position.

Inserting a Retrospective Track Recording into an Editor

You can insert a retrospective track recording, that is, MIDI data that was sent to the track input in **Stop** mode or during playback, into the MIDI part that is opened in a MIDI editor.

PREREQUISITE

You have played some MIDI notes in **Stop** mode or during playback, and you want to recover them.

PROCEDURE

1. Double-click the MIDI part where you want to insert the captured MIDI data to open it in a MIDI editor.
 2. On the MIDI editor toolbar, click **Insert MIDI Retrospective Recording in Editor**.
-

RESULT

The MIDI data that was captured on the track input is inserted into the MIDI part.

- If the data was captured during playback, it is inserted into the MIDI part along the timeline.
- If the data was captured in **Stop** mode, it is inserted at the project cursor position.

Emptying the Retrospective Record Buffer

You can empty the retrospective record buffer manually.

PROCEDURE

- Do one of the following:
 - In the top section of the MIDI track **Inspector**, open the **Retrospective Recording** pop-up menu, and select **Empty Retrospective Record Buffer**.
 - Select a track, and select **Transport > MIDI Retrospective Recording > Empty All Buffers**.
-

Remaining Record Time

The **Max. Record Time** display lets you see how much time you have left for recording.

51h 25min

The available time depends on the current setup, for example, on the amount of tracks that are record-enabled, the sample rate for your project, and the available hard disk space.

- To open the display, select **Studio > More Options > Max. Record Time**.

NOTE

The remaining record time is also shown in the status line above the track list.

If you use individual record folders to store your tracks on different drives, the time display refers to the medium with the least storage space available.

Lock Record

The **Lock Record** function prevents you from accidentally deactivating record mode.

- Select **Edit > Key Commands** and in the **Transport** category, assign key commands to the **Lock Record** and **Unlock Record** commands.

If **Lock Record** is activated and you want to enter stop mode, a dialog opens in which you need to confirm that you want to stop recording. You can also use the **Unlock Record** key command first and then enter stop mode as usual.

NOTE

An automatic punch out at the right locator position will be ignored in **Lock Record** mode.

Importing Audio and MIDI Files

You can add audio and MIDI files to your project by importing them.

Audio File Import

You can import compressed and uncompressed audio files in a variety of different formats. You can also import audio from audio CDs or extract the audio of video files.

For postproduction, Nuendo provides a dedicated import function for original production audio set recordings from a field recorder.

RELATED LINKS

- [Importing Audio Files](#) on page 313
- [Importing Audio CD Tracks](#) on page 314
- [Importing Audio from Video Files](#) on page 317
- [Importing ReCycle Files](#) on page 317
- [Importing Clip Packages](#) on page 318
- [Importing Media](#) on page 688
- [Field Recorder File Import](#) on page 1248

Setting up Audio File Import Options

You can specify how audio files should be handled on import.

PROCEDURE

1. In the **Preferences** dialog, select **Editing > Audio**.
2. Select an option from the **On Import Audio Files** pop-up menu.

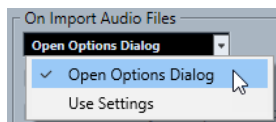

3. Click **OK**.
-

RESULT

The import settings are saved and will take effect when you import audio. If you selected **Open Options Dialog**, the **Import Options** dialog opens on every import and allows you to make your changes. If you selected **Use Settings**, the settings specified in the **On Import Audio Files** section of the **Preferences** dialog are used.

RELATED LINKS

- [Import Options Dialog for Audio Files](#) on page 312
- [On Import Audio Files Settings](#) on page 313

Import Options Dialog for Audio Files

The **Import Options** dialog allows you to make specific settings for the audio import.

- When you import audio files and **Open Options Dialog** is activated in the **On Import Audio Files** section of the **Preferences** dialog (**Editing—Audio** page), the **Import Options** dialog opens.

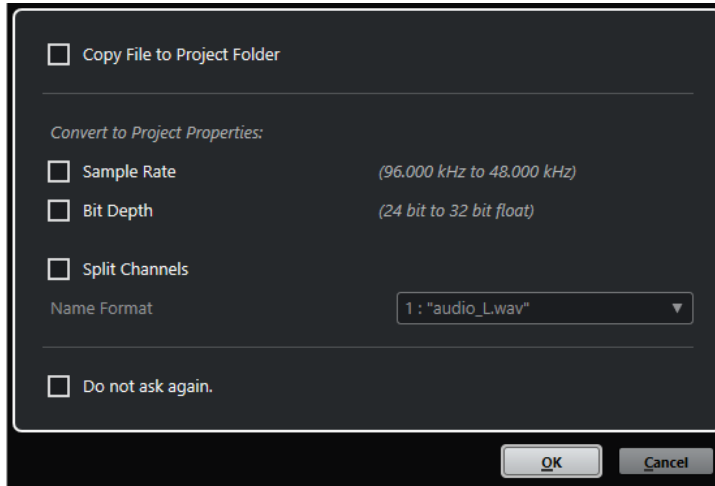

Import Options dialog for single file import

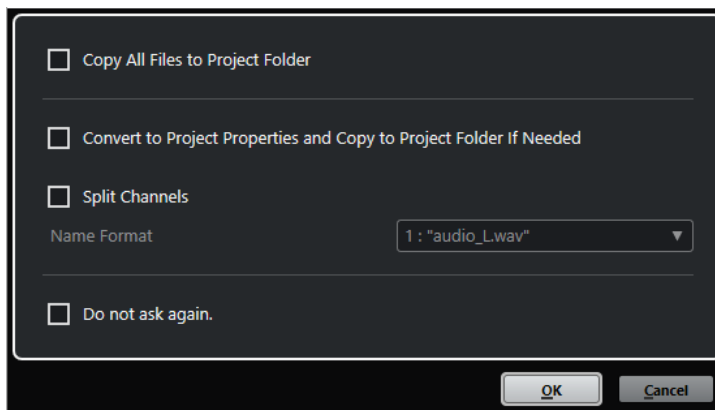

Import Options dialog for multiple file import

Copy File to Project Folder/Copy All Files to Project Folder

Copies the audio file to the **Audio** folder of the project, and has the clip refer to the copy.

Deactivate this option to have the clip refer to the original file in the original location. In this case, it is marked as "external" in the **Pool**.

Convert to Project Settings/Convert to Project Settings and Copy to Project Folder If Needed

Converts the imported file if the sample rate or the bit depth differ from the settings in the **Project Setup** dialog. For single file import, you can choose which properties are converted.

Split Channels

Splits stereo or multi-channel audio files into a corresponding number of mono files, one for each channel, and copies the imported files to the **Audio** folder of the project. The split files are inserted into the project and into the **Pool** as separate mono tracks.

The **Name Format** pop-up menu allows you to specify how the split files are named. This allows for compatibility with other products when exchanging audio files.

Do not ask again

Always imports files according to the settings without opening the dialog again. You can reset this option in the **Preferences** dialog (**Editing—Audio** page).

RELATED LINKS

[Setting up Audio File Import Options](#) on page 311

On Import Audio Files Settings

You can set up standard settings that are performed automatically each time you import audio files.

- When you import audio files and **Use Settings** is activated in the **On Import Audio Files** section of the **Preferences** dialog (**Editing—Audio** page), the settings are used for importing audio.

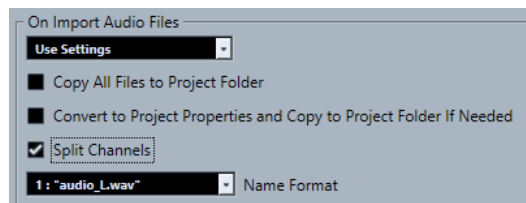

Copy File to Project Folder/Copy All Files to Project Folder

Copies the audio file to the **Audio** folder of the project, and has the clip refer to the copy.

Deactivate this option to have the clip refer to the original file in the original location. In this case, it is marked as “external” in the **Pool**.

Convert to Project Settings/Convert to Project Settings and Copy to Project Folder If Needed

Converts the imported file if the sample rate or the bit depth differ from the settings in the **Project Setup** dialog. For single file import, you can choose which properties are converted.

Split Channels

Splits stereo or multi-channel audio files into a corresponding number of mono files, one for each channel, and copies the imported files to the **Audio** folder of the project.

The split files are inserted into the project and into the **Pool** as separate mono tracks.

The **Name Format** pop-up menu allows you to specify how the split files are named. This allows for compatibility with other products when exchanging audio files.

Importing Audio Files

You can import uncompressed audio and compressed audio in several formats.

PROCEDURE

1. Select **File > Import > Audio File**.
2. In the file dialog that opens, locate and select the audio file and click **Open**.
3. Make your changes in the **Import Options** dialog.

NOTE

If **Use Settings** is activated in the **Preferences** dialog (**Editing—Audio** page), the corresponding import settings are used instead.

RESULT

In the **Project** window, an event referencing the audio file is inserted on the selected track at the project cursor position. If no track was selected, a new track is created.

A new audio clip is created and added to the **Pool**.

If you chose a compressed audio file other than FLAC, Nuendo copies the original compressed file and converts it to wave format (Windows) or AIFF format (macOS).

NOTE

The resulting Wave/AIFF file is significantly larger than the original compressed file.

The imported file is placed in the **Audio** folder of the project.

RELATED LINKS

[Setting up Audio File Import Options](#) on page 311

Supported Compressed Audio File Formats

In Cubase, you can import compressed audio files.

The following compressed audio file formats are supported:

FLAC file

This is an open source format that reduces the size of audio files by 50 % to 60 % compared to regular Wave files. The files have the extension **.flac**.

MPEG 1 Layer 3 file

This is a family of standards used for encoding audio-visual information such as movies, video, and music in a digital compressed format. Nuendo can read MPEG Layer 2 and MPEG Layer 3. MP3 files are highly compressed files that still provide good audio quality. The files have the extension **.mp3**.

Ogg Vorbis file

This is an open source, patent-free audio encoding and streaming technology. The Ogg Vorbis encoder uses variable bit rate encoding. It offers compressed audio files of small size, but with comparatively high audio quality. The files have the extension **.ogg**.

Windows Media Audio file (Windows only)

This is an audio file format defined by Microsoft Inc. WMA files can be decreased in size with no loss of audio quality. WMA Pro features the possibility of mixing down to 5.1 surround sound. The files have the extension **.wma**.

Importing Audio CD Tracks

You can import audio from audio CDs into Nuendo projects.

PROCEDURE

1. Select **File > Import > Audio CD** to import the CD tracks into the **Project** window.
2. Activate every audio file that you want to import in the **Copy** column.
3. Optional: Set a **Default Name** and a **Destination Folder** for the imported audio files.

4. Click the **Copy** button to create a local copy of the audio files or sections.
 5. Click **OK**.
-

RESULT

The copied audio files are imported into the **Project** window and inserted on new tracks at the project cursor position. By default, imported audio CD tracks are saved as wave files (Windows) or AIFF files (macOS) in the **Audio** folder of the current project.

New audio clips are created and added to the **Pool**.

NOTE

You can also import audio files to the **Pool** only without importing them into the **Project** window.

RELATED LINKS

[Importing Media](#) on page 688

Import From Audio CD Dialog

The **Import from Audio CD** dialog allows you to specify how the CD tracks are imported.

- To open the **Import from Audio CD** dialog, select **File > Import > Audio CD**.

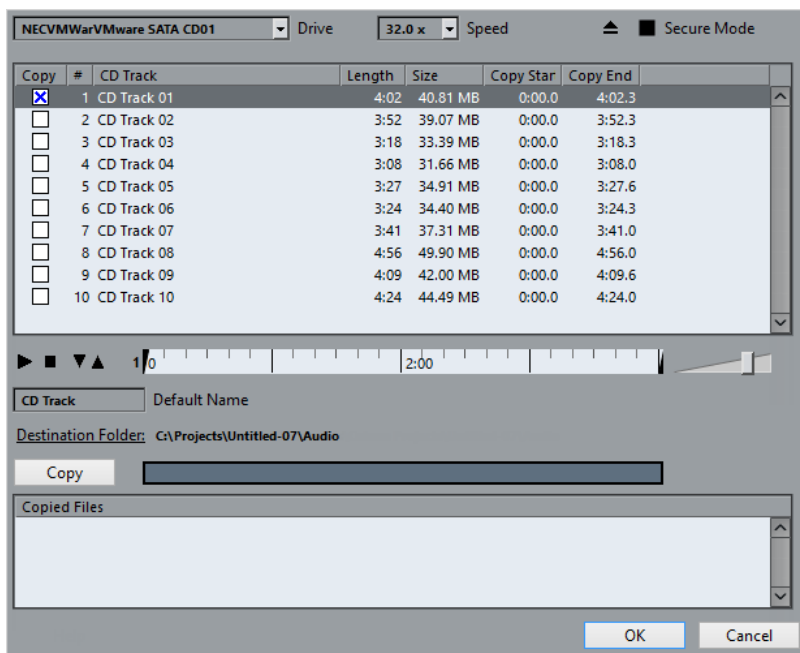

Drive

Opens a pop-up menu that allows you to select the correct CD drive.

Speed (Windows only)

Allows you to select the data transfer speed.

NOTE

While you normally want to use the fastest possible speed, you may have to select a slower speed for flawless audio extraction.

Eject CD

Opens the CD drive.

Secure Mode (Windows only)

Activates error checking and correction when reading the CD.

Columns

The columns in the dialog have the following functions:

Copy

Activate this option for the tracks that you want to copy/import.

#

Shows the track number.

CD Track

The name of the CD track. On import, this is used as file name. It is provided automatically from CDDb, if available.

To rename a track, click the track name and enter a new name.

Length

The length of the audio CD track in minutes and seconds.

Size

The file size of the audio CD track in MB.

Copy Start

The start of the section that is imported. On the ruler, drag the **Left Marker** to the right to adjust this.

Copy End

The end of the section that is imported. On the ruler, drag the **Right Marker** to the left to adjust this.

The Ruler

The ruler has the following functions:

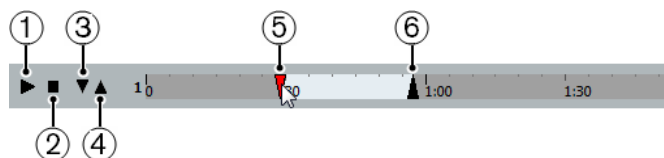

1 Play Tracks

Plays back the selected track from the start to the end or from the left marker to the right marker.

2 Stop Playback

Stops playback.

3 Play from Left Marker

Starts playback at the left marker.

4 Play to Right Marker

Starts playback some moments before the right marker and stops at the right marker.

5 Left Marker

Allows you to set the copy start manually.

6 Right Marker

Allows you to set the copy end manually.

Destination Folder

Allows you to select a folder for the imported files.

Copy

Copies the files.

Copied Files

Lists the files that you copied for import.

Importing Audio from Video Files

You can import the audio from a video file without importing the video itself.

PROCEDURE

1. Select **File > Import > Audio from Video File**.
2. In the file dialog that opens, locate and select the video file, and click **Open**.

RESULT

The audio of the selected video file is extracted and converted to a wave file that is saved in the **Audio** folder.

A new audio clip is created and added to the **Pool**. In the **Project** window, an event referencing the audio file is inserted on the selected track at the project cursor position. If no track was selected, a new track is created.

RELATED LINKS

- [Extracting Audio from Video](#) on page 1244
[Importing Video Files](#) on page 1236

Importing ReCycle Files

You can import REX and REX2 audio files created by ReCycle from Propellerhead Software. ReCycle slices a loop and creates separate samples of each beat, so that you can tempo match and edit a loop as if it was built of individual sounds.

PREREQUISITE

REX Shared Library is installed on your system.

PROCEDURE

1. Select an audio track and move the project cursor to where you want the imported file to start.
If you set the audio track to musical time base you can change the tempo later on and the imported REX file automatically adjusts.
2. Select **File > Import > Audio File**.
3. In the file dialog, open the file type pop-up menu and select **REX File** or **REX 2 File**.
4. Select the file you want to import, and click **Open**.

RESULT

The file is imported and automatically adjusted to the current Nuendo tempo.

The imported REX file consists of several events, one for each slice in the loop. The events are automatically placed in an audio part on the selected track and positioned so that the original internal timing of the loop is preserved.

AFTER COMPLETING THIS TASK

Open the part in the **Audio Part Editor** to edit each slice separately by muting, moving, and resizing events, adding effects and processing, for example.

You can also adjust the tempo and have the REX file automatically follow, provided that its track is set to a musical time base.

NOTE

You can achieve similar results by using Nuendo's own loop slicing features.

RELATED LINKS

[Slices](#) on page 599

Importing Clip Packages

You can import clip packages. Clip packages are sound combinations that you create by arranging, editing, and grouping audio events or parts in the **Project** window.

PROCEDURE

1. Select **File > Import > Clip Package**.
 2. In the file dialog that opens, locate and select the clip package and click **Open**.
 3. In the dialog that appears, select if you want to import automation data of the clip package.
-

RESULT

In the **Project** window, the events of the clip package are inserted and grouped. The first event is inserted on the selected track. If no track is selected, new tracks are added below the existing tracks and the events are inserted on these.

The audio parts and events are copied to the project folder.

If the sample rate of the audio files within the clip package does not correspond to the sample rate of the project into which it is inserted, the files are automatically converted to the project sample rate.

If automation data for volume and pan was saved in the clip package, a corresponding automation curve is created together with the event.

Automation data for the **VST MultiPanner** is only applied correctly on import if a target track with the correct surround format is selected.

RELATED LINKS

[Clip Packages](#) on page 210

[Importing Media](#) on page 688

[Show Media Types Selector](#) on page 715

[Clip Packages Previewer](#) on page 723

[Pool Window](#) on page 675

[VST MultiPanner](#) on page 747

MIDI File Import

Nuendo can import standard MIDI files. This allows you to transfer MIDI material to and from virtually any MIDI application on any platform.

Import Options for MIDI Files

The **Import Options** for MIDI files allow you to specify what data is included in imported MIDI files.

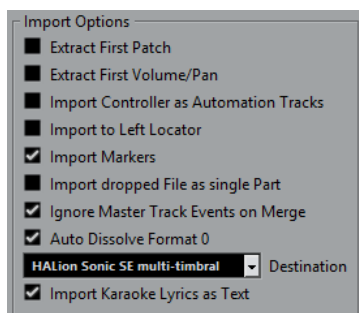

Extract First Patch

Converts the first **Program Change** and **Bank Select** events for each track to **Inspector** settings for the track.

Extract First Volume/Pan

Converts the first **MIDI Volume** and **Pan** events for each track to **Inspector** settings for the track.

Import Controller as Automation Tracks

Converts **MIDI Controller** events in the MIDI file to automation data for the MIDI tracks.

Import to Left Locator

Aligns the imported MIDI file at the position of the left locator.

Import Markers

Imports Standard MIDI File Markers in the file and converts them to Nuendo markers.

Import Dropped File as Single Part

Places the file on one track if you drag a MIDI file into the project.

Ignore Master Track Events on Merge

Ignores tempo track data if you import a MIDI file into the current project. The imported MIDI file will play according to the current tempo track in the project.

Auto Dissolve Format 0

Automatically dissolves imported MIDI files of type 0. Each embedded MIDI channel in the file is placed on a separate track in the **Project** window.

Destination

Allows you to specify what happens when you drag a MIDI file into the project.

- **MIDI Tracks** creates MIDI tracks for the imported file.
- **Instrument Tracks** creates instrument tracks for each MIDI channel in the MIDI file and lets the program automatically load appropriate presets.
- **HALion Sonic SE multi-timbral** creates several MIDI tracks, each routed to a separate instance of HALion Sonic SE in the **VST Instruments** window, and loads the appropriate presets.

Import Karaoke Lyrics as Text

Converts karaoke lyrics in the MIDI file to text that can be displayed in the **Score Editor**. If this option is deactivated, lyrics are only shown in the **List Editor**.

Importing MIDI Files

In Nuendo, you can import MIDI files.

PROCEDURE

1. Select **File > Import > MIDI File**.
2. Optional: If a project is open, choose if you want to create a new project. If you select **No**, the MIDI file is imported into the current project.
3. In the file dialog that opens, locate and select the MIDI file and click **Open**.

RESULT

The MIDI file is imported. The result depends on the contents of the MIDI file and the setting you made in the **Import Options** section in the **Preferences** dialog (**MIDI—MIDI File** page).

It is also possible to import a MIDI file from disk by dragging it from the File Explorer/macOS Finder into the **Project** window. The **Import Options** apply as well.

RELATED LINKS

[Import Options for MIDI Files](#) on page 319
[Markers](#) on page 368

Yamaha XF Format

Nuendo supports the Yamaha XF format. XF is an extension of the standard MIDI file format that allows you to save song-specific data with a MIDI file of type 0.

When importing a MIDI file containing XF data, this data is placed in parts on separate tracks called **XF Data**, **Chord Data**, or **SysEx Data**. You can edit such a part in the **List Editor** to add or change lyrics, for example.

IMPORTANT

Do not change the order of events within the XF data or the event data itself, unless you have a lot of experience with XF data.

Nuendo can also export XF data as part of a MIDI file of type 0. If you do not want to export the XF data together with the MIDI data, mute or delete the tracks containing the XF data.

MIDI Loops

In Nuendo, you can import MIDI loops.

To import MIDI loops, use the **MediaBay**. MIDI loops have the file extension `.midiloop`.

RELATED LINKS

[Importing MIDI Loops](#) on page 847

Quantizing MIDI and Audio

Quantizing means moving recorded audio or MIDI and positioning it on the nearest grid position that is musically relevant. Quantizing is designed to correct errors, but you can also use it in a creative way.

You can quantize audio and MIDI to a grid or to a groove. You can also quantize multiple audio tracks simultaneously.

Audio and MIDI can be quantized at the same time. However, what exactly happens during quantizing differs for audio and MIDI:

- Audio quantizing affects the audio event starts or the content of your audio.
- MIDI quantizing can affect the starts of MIDI events in a part, the MIDI event lengths, or the MIDI event ends.

NOTE

Quantizing is based on the original position of the events. Therefore, you can freely try out different quantize settings without the risk of destroying anything.

RELATED LINKS

[Quantizing Audio Event Starts](#) on page 323

[Quantizing Audio Event Lengths \(AudioWarp Quantizing\)](#) on page 324

[Quantizing MIDI Event Starts](#) on page 322

[Quantizing MIDI Event Lengths](#) on page 323

[Quantizing MIDI Event Ends](#) on page 323

Quantize Functions

The quantize functions are available in the **Edit** menu and in the **Snap** and **Quantize** sections of the **Project** window toolbar.

Quantize Functions on the Edit Menu

Quantize

Quantizes audio or MIDI event starts.

Reset Quantize

Reverts your audio or MIDI to its original, unquantized state, and resets any length changes that you performed in the **Quantize Panel**.

Quantize Panel

Opens the **Quantize Panel**.

Advanced Quantize

From this submenu, you can select the following functions:

- **Quantize MIDI Event Lengths**
Cuts off the ends of selected MIDI events so that the events match the length quantize value. The start positions are kept.
- **Quantize MIDI Event Ends**
Moves the ends of MIDI events to the nearest grid positions.

- **Freeze MIDI Quantize**
Makes the start and end positions of MIDI events permanent. This function is useful in situations where you want to quantize a second time, based on the current quantized positions rather than the original positions.
- **Create Groove Quantize Preset**
Creates a groove quantize map based on hitpoints that you have created in the **Sample Editor**.

Quantize Functions on the Project Window Toolbar

Apply Quantize



Applies the quantize settings.

Quantize Presets



Allows you to select a quantize preset.

Soft Quantize On/Off



Activates/Deactivates soft quantize.

AudioWarp Quantize On/Off



Activates/Deactivates **AudioWarp** quantize.

Open Quantize Panel



Opens the **Quantize Panel**.

Quantizing MIDI Event Starts

You can quantize the MIDI event start positions.

PREREQUISITE

You have set up a quantize grid on the **Quantize Presets** pop-up menu on the **Project** window toolbar.

PROCEDURE

1. Perform one of the following actions:
 - In the **Key Editor**, select the MIDI events that you want to quantize.
 - In the **Project** window, select a MIDI part.
2. Select **Edit > Quantize**.

RESULT

The starts of the selected MIDI events or all events of the selected MIDI part are quantized. Events that do not match exact note positions are moved to the closest grid position. The note lengths are maintained.

Quantizing MIDI Event Lengths

You can quantize the MIDI event lengths.

PREREQUISITE

You have set up a length quantize value on the **Length Quantize** pop-up menu on the **Key Editor** toolbar.

PROCEDURE

1. Perform one of the following actions:
 - In the **Key Editor**, select the MIDI events that you want to quantize.
 - In the **Project** window, select a MIDI part.
 2. Select **Edit > Advanced Quantize > Quantize MIDI Event Lengths**.
-

RESULT

The ends of the selected MIDI events are cut off so that the events match the length quantize value. The start positions are kept.

NOTE

If you have selected **Quantize Link** in the **Length Quantize** pop-up menu of the **Key Editor** toolbar, the events are resized according to the grid that is set up in the **Quantize Presets** pop-up menu. The **Swing**, **Tuplet**, and **Catch Range** settings on the **Quantize Panel** are taken into account.

Quantizing MIDI Event Ends

You can quantize the MIDI event end positions.

PREREQUISITE

You have set up a quantize grid on the **Quantize Presets** pop-up menu on the **Project** window toolbar.

PROCEDURE

1. Perform one of the following actions:
 - In the **Key Editor**, select the MIDI events that you want to quantize.
 - In the **Project** window, select a MIDI part.
 2. Select **Edit > Advanced Quantize > Quantize MIDI Event Ends**.
-

RESULT

The ends of the MIDI events are moved to the nearest grid positions.

Quantizing Audio Event Starts

You can quantize the audio event start positions.

PREREQUISITE

You have set up a quantize grid on the **Quantize Presets** pop-up menu on the **Project** window toolbar.

PROCEDURE

1. In the **Project** window, select an audio event, a sliced loop, or an audio part.
 2. Select **Edit > Quantize**.
-

RESULT

The event snap point, or, if not available, the start of the audio event, is quantized. Event starts that do not match exact note positions are moved to the closest grid positions.

NOTE

If you use the **Quantize** function on an audio part, the starts of the events inside the part are quantized.

Quantizing Audio Event Lengths (AudioWarp Quantizing)

You can quantize an audio event or an audio selection range by applying time stretch to the content of the audio event.

PROCEDURE

1. Perform one of the following actions:
 - Select the audio event that you want to quantize.
 - Select a range of the event that you want to quantize.
 2. On the toolbar, activate **AudioWarp Quantize On/Off**.
 3. Perform one of the following actions:
 - Click **Quantize Presets**, and select a quantize grid preset from the pop-up menu.
 - Click **Open Quantize Panel**, and define the quantize grid with the available parameters.
 4. Select **Edit > Quantize**.
-

RESULT

The audio event is quantized, that is, its warp markers are aligned with the quantize grid by applying time stretch, and the audio sections between the warp markers are stretched or compressed to fit into the time interval that you set up on the **Quantize Presets** pop-up menu.

NOTE

If you use a quantize value of 1/4 on audio that is based on 16th notes, the warp markers at the 1/4 note positions are quantized to the grid, and the remaining warp markers are moved, keeping the relative distances between the warp markers.

RELATED LINKS

[Quantize Panel](#) on page 326
[Slices](#) on page 599

Quantizing Multiple Audio Tracks

You can quantize multiple audio tracks at the same time.

PROCEDURE

1. In the global track controls area of the track list, click **Add Track** .

2. Click **Folder**.
3. Click **Add Track**.
4. Move all audio tracks that you want to quantize into the folder track.

NOTE

The audio on all tracks must have the same start and end positions.

5. Select the folder track and activate **Group Editing** in the track list.
 6. In the event display, select one of the events.
All audio events contained in the folder track are selected.
 7. On the **Project** window toolbar, click **Open Quantize Panel** to open the **Quantize Panel**.
 8. Make your changes in the **Slice Rules** section of the **Quantize Panel**, and click **Slice**.
The audio events in the edit group are sliced.
 9. Make your changes in the quantize section of the **Quantize Panel**, and click **Quantize**.
The sliced events are quantized.
 10. Optional: To correct overlaps or gaps in the quantized audio, make your changes in the **Crossfades** section of the **Quantize Panel**, and click **Crossfade**.
-

RESULT

The audio events are quantized.

RELATED LINKS

[Quantize Panel](#) on page 326

[Group Editing Mode](#) on page 238

AudioWarp Quantizing Multiple Audio Tracks

You can use warp markers for quantizing multiple audio tracks. However, AudioWarp quantizing does not maintain phase coherence.

PROCEDURE

1. In the global track controls area of the track list, click **Add Track** .
2. Click **Folder**.
3. Click **Add Track**.
4. Move all audio tracks that you want to quantize into the folder track.

NOTE

The audio on all tracks must have the same start and end positions.

5. Select the folder track and activate **Group Editing** in the track list.
 6. In the event display, select one of the events.
All audio events contained in the folder track are selected.
 7. On the **Project** window toolbar, activate **AudioWarp Quantize On/Off**.
 8. Click **Open Quantize Panel** to open the **Quantize Panel**.
 9. Make your changes in the **Warp Marker Creation Rules** section of the **Quantize Panel**, and click **Create**.
 10. Make your changes in the **Quantize Settings** section of the **Quantize Panel**, and click **Quantize**.
-

RESULT

AudioWarp quantizing is applied to all tracks in the edit group.

RELATED LINKS

[Quantize Panel](#) on page 326

[Group Editing Mode](#) on page 238

Quantize Panel

The **Quantize Panel** allows you to define how to quantize audio or MIDI to the grid or to a groove. Depending on what method you choose, different parameters are shown.

To open the **Quantize Panel**, perform one of the following actions:

- Click **Open Quantize Panel** on the toolbar.
- Select **Edit > Quantize Panel**.

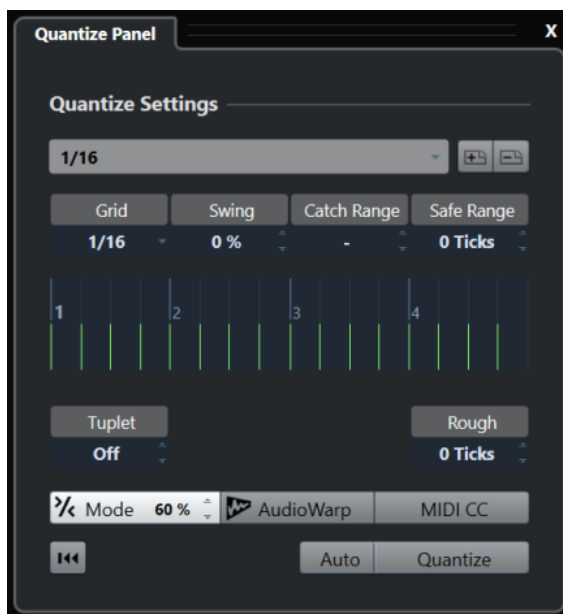

Quantize Presets

To the top of the **Quantize Panel** the quantize presets are shown. Here, you can load and save presets that include all settings for quantizing.

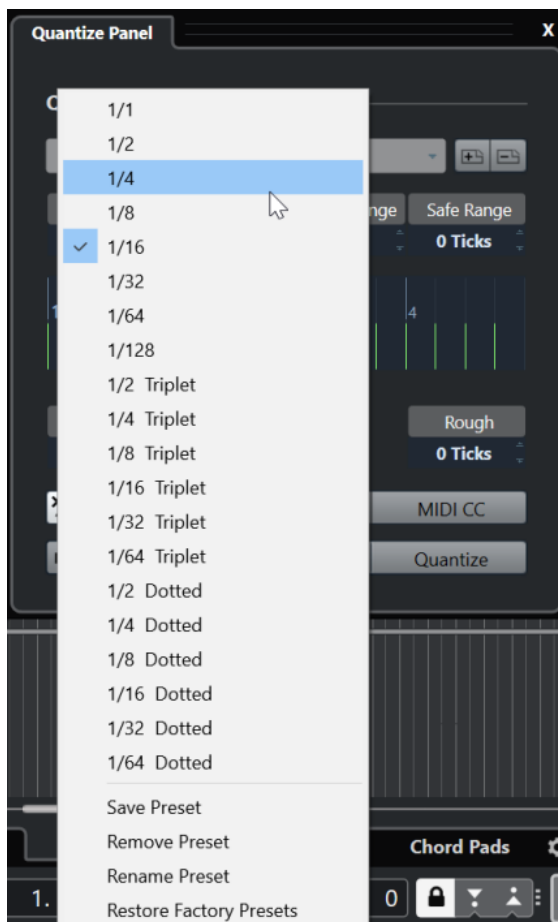

Select Preset

Allows you to select a preset.

Save Preset

Allows you to save the current settings as a preset, so that they become available on all **Quantize Presets** pop-up menus.

Remove Preset

Allows you to remove the selected preset.

Rename Preset

Opens a dialog where you can rename the selected preset.

Restore Factory Presets

Allows you to restore the factory presets.

Creating Groove Quantize Presets

You can create a groove quantize map based on hitpoints that you have created in the **Sample Editor**.

PROCEDURE

1. In the **Project** window, double-click the audio event from which you want to extract the timing.

The **Sample Editor** opens.

2. Open the **Hitpoints** section.

The hitpoints for the audio event are detected and displayed automatically.

3. Click **Create Groove**.

The groove is extracted.

RESULT

The groove is extracted from the audio event and made available in the **Quantize Presets** pop-up menu on the **Project** window toolbar.

AFTER COMPLETING THIS TASK

Open the **Quantize Panel** and save the groove as a preset.

RELATED LINKS

[Creating a Groove Quantize Map](#) on page 602

[Quantize Presets](#) on page 327

Options For Quantizing to a Musical Grid

You can use the musical grid to quantize your recorded music.

- To access the options for quantizing to a musical grid, select a musical time format from the **Select Preset** pop-up menu on the **Quantize Panel**.

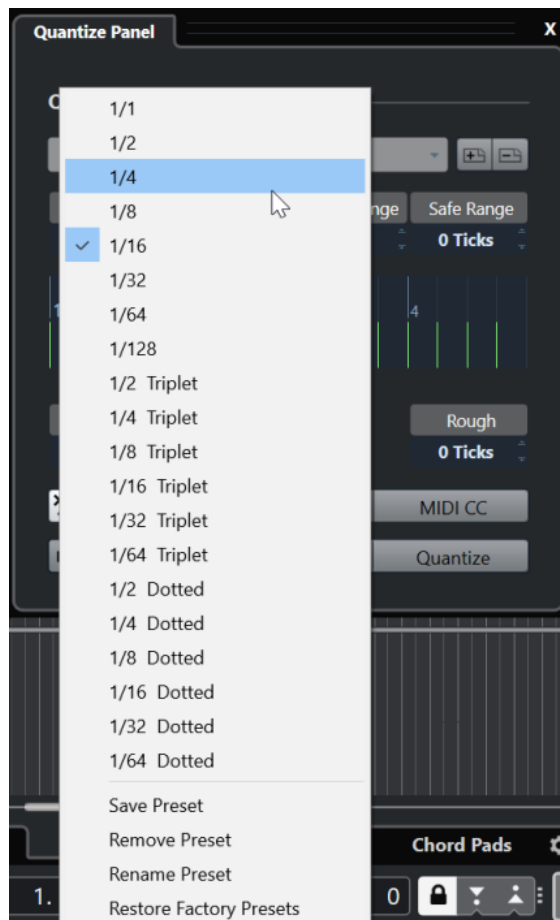

The following options are available:

Grid

Allows you to select the basic value for the quantize grid.

Swing

Offsets every second position in the grid, creating a swing or shuffle feel.

NOTE

Swing is only available if **Grid** is set to a straight value and **Tuplet** is deactivated.

Catch Range

Allows you to set a value that determines that quantizing affects only audio or MIDI within the set distance from the grid lines. This is reflected in the grid display.

Safe Range

Creates a safe zone before and after the quantize positions. If you specify a distance in ticks (120 ticks = one 16th note), events that lie within this zone are not quantized. This way, slight variations are kept.

Grid Display

Shows the quantize grid. Quantized audio or MIDI is moved to the positions indicated by the vertical grid lines.

Tuplet

Creates rhythmically more complex grids by dividing the grid into smaller steps, and thereby creating n-tuplets.

Rough

Allows you to set a distance in ticks, so that your audio or MIDI is quantized to random positions within the specified distance from the quantize grid. This allows for slight variations and, at the same time, prevents your audio or MIDI from ending up too far away from the grid.

Soft Quantize Mode

Applies a loose quantization so that your audio or MIDI moves only part of the way to the closest quantize grid position. The **Quantize Strength** value to the right determines how close your audio or MIDI moves towards the grid.

NOTE

Soft quantizing is based on the current, quantized positions and not on the original event positions. You can repeatedly use the soft quantize mode to gradually move your audio or MIDI closer to the quantize grid until you have found the right timing.

AudioWarp

Quantizes the content of your audio event by applying time stretch. The warp markers are aligned with the defined quantize grid.

MIDI CC

Moves controllers related to MIDI notes (pitchbend, etc.) automatically with the notes when these are quantized.

Reset Quantize

Resets your audio or MIDI to its original, unquantized state.

IMPORTANT

This function has no effect on an event that was moved manually.

Auto

Applies any changes immediately to the selected parts or events. A way of using this feature is to set up a playback loop and adjust the settings until you are satisfied with the result.

Quantize

Applies your settings.

Options for Quantizing to a Groove

You can generate a timing grid from a MIDI part or an audio loop, and use this groove to quantize your recorded music. This way, you can recreate the rhythmic feel of this specific event or part.

To access the options for quantizing to a groove, select a MIDI part from an audio loop, an audio event with hitpoints, or sliced audio, and perform one of the following actions:

- Drag the part or event to the grid display in the middle of the **Quantize Panel**.
- Select **Edit > Advanced Quantize > Create Groove Quantize Preset**.

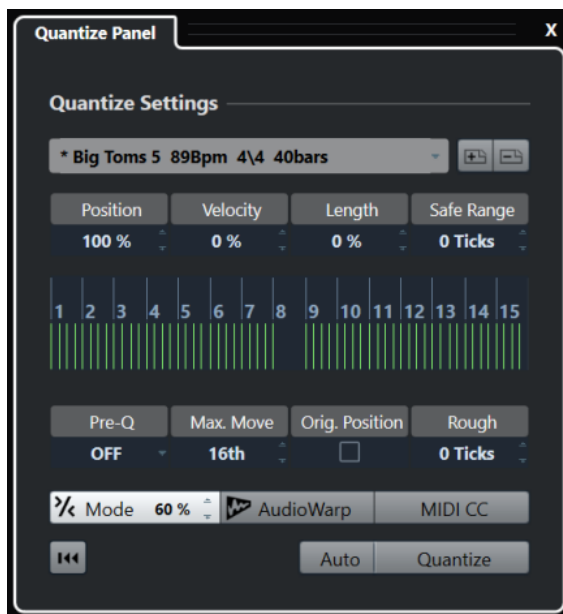

The following options become available:

Position

Determines how much the timing of the groove affects the music.

Velocity (MIDI Only)

Determines how much the velocity values within the groove affect the music.

NOTE

Not all grooves contain velocity information.

Length (MIDI Only)

Allows you to specify how much the lengths of the notes are affected by the groove.

NOTE

For drums, the **Length** setting is ignored.

Safe Range

Allows you to create a safe zone before and after the quantize positions. If you specify a distance in ticks (120 ticks = one 16th note), events that lie within this zone are not quantized. This way, slight variations are kept.

Grid display

Shows the quantize grid. Quantized audio or MIDI is moved to the positions indicated by the vertical grid lines.

Pre-Q

Allows you to select a musical grid to which you can quantize your audio or MIDI first. This gets the notes closer to their groove destination.

NOTE

If you apply a shuffle groove to a 16th-note pattern, for example, set up a pre-quantize value of 16 to straighten up the timing before applying the groove quantizing.

Max. Move

Allows you to select a note value to specify a maximum distance that the audio or MIDI can be moved.

Orig. Position

Sets the original starting position of the quantized material as starting point of the quantizing. This allows you to synchronize material that does not start from bar 1 of the project.

Rough Quantize

Allows you to set a distance in ticks so that your audio or MIDI is quantized to random positions within the specified distance from the quantize grid. This allows for slight variations and, at the same time, prevents your audio or MIDI from ending up too far away from the grid.

Soft Quantize Mode

Applies a loose quantization so that your audio or MIDI moves only part of the way to the closest quantize grid position. The **Quantize Strength** value to the right determines how close your audio or MIDI moves towards the grid.

NOTE

Soft quantizing is based on the current, quantized positions and not on the original event positions. You can repeatedly use the soft quantize mode to gradually move your audio or MIDI closer to the quantize grid until you have found the right timing.

AudioWarp

Quantizes the content of your audio event by applying time stretch. The warp markers are aligned with the defined quantize grid.

MIDI CC

Moves controllers related to MIDI notes (pitchbend, etc.) automatically with the notes when these are quantized.

Reset Quantize

Resets your audio or MIDI to its original, unquantized state.

IMPORTANT

This function has no effect on an event that was moved manually.

Auto

Applies any changes immediately to the selected parts or events. A way of using this feature is to set up a playback loop and adjust the settings until you are satisfied with the result.

Quantize

Applies your settings.

RELATED LINKS

[Creating Groove Quantize Presets](#) on page 327

Options for Quantizing Multiple Audio Tracks

If you quantize multiple audio tracks, the **Slice Rules** section becomes available in the **Quantize Panel**. Here, you determine how the audio events are sliced at the hitpoints.

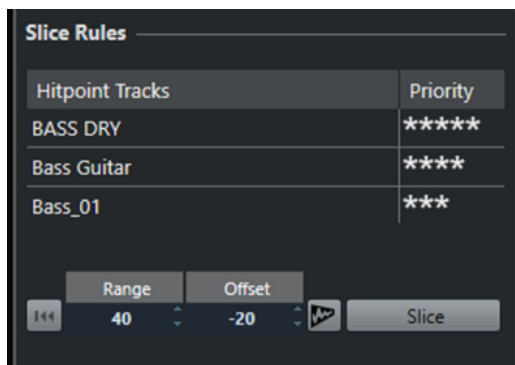

- To access the **Slice Rules** section, move your audio tracks to a folder track, activate **Group Editing**, and open the **Quantize Panel**.

Hitpoint Tracks

Lists all audio tracks of your edit group that have hitpoints.

Priority

Click and drag to the right or to the left to specify a priority. The hitpoints of the track with the highest priority determine slice positions for the audio on all tracks. If the zoom factor is high enough, cutting positions are marked in the **Project** window by vertical lines.

Range

Allows you to specify the distance in which two hitpoints on different tracks are considered to mark the same beat.

Offset

Allows you to set an offset that determines how far before the actual hitpoint position an audio event is sliced. This allows for slight variations of the cutting position and is useful if you want to create crossfades at the slice positions. Furthermore, it helps to avoid cutting off signals on tracks that do not contain any hitpoints.

AudioWarp Quantize On/Off

Activate this button to quantize the content of your audio event by applying time stretch. This enables the **Warp Marker Creation Rules** section that allows you to specify a priority. The hitpoints of the track with the highest priority determine warp marker positions for the audio on all tracks.

Slice

Slices all audio events of the edit group, and sets the event snap points to the position of the hitpoint with the highest priority.

Reset

Undoes the slicing and restores the original state of the audio events.

RELATED LINKS

[Options for AudioWarp Quantizing Multiple Audio Tracks](#) on page 333

[Crossfades Section](#) on page 333

[AudioWarp Quantizing Multiple Audio Tracks](#) on page 325

[Group Editing Mode](#) on page 238

Crossfades Section

The **Crossfades** section becomes available after you have sliced the audio events. The functions in this section allow you to correct the overlaps or the gaps that might appear due to the re-positioning of your audio.

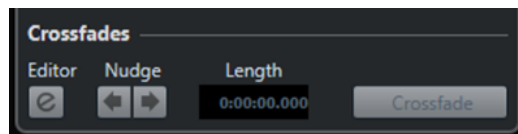

Clicking **Crossfade** cuts the end of the first event at the start position of the following event (in case of overlaps), and stretches the second event until it starts at the end of the previous event (in case of gaps).

In some cases, you might want to achieve seamless transitions, applying crossfades after closing the gaps. For this purpose, use the following parameters:

Open Crossfade Editor

Opens the **Crossfade** editor, where you can specify curve type, length, and other parameters for your crossfades.

Nudge Crossfade Left/Right

Moves the fade area in the audio event to the left or to the right in steps of one millisecond. This is useful if the **Offset** value in the **Slice Rules** section was not high enough, and you want to avoid that the crossfade cuts an attack.

Length

Specifies the length of the crossfade area.

RELATED LINKS

[Crossfade Editor](#) on page 341

Options for AudioWarp Quantizing Multiple Audio Tracks

The **Warp Marker Creation Rules** section becomes available when you activate AudioWarp quantizing for multiple audio tracks.

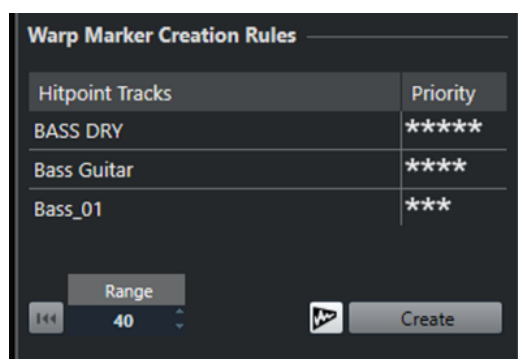

Priority

In this column, you can define a priority for each track. The track with the highest priority defines where the warp markers are created.

If you set up the same priority for several tracks, the warp marker position is defined by the track that contains the first hitpoint within the specified range. This is decided for each warp marker position anew.

- To specify a priority, click and drag to the right or to the left.
If no star is shown, the hitpoints on the corresponding track are not taken into account.

Range

Two hitpoints on different tracks are considered to mark the same beat if they are located within a certain distance from each other. The **Range** parameter specifies this distance. The following rules apply:

- If one of the tracks has a higher priority, its hitpoint is used to create the warp marker.
- If the tracks have the same priority, the first hitpoint in the range is used.

Reset

Undoes the creation of warp markers.

AudioWarp Quantize On/Off

Activates/Deactivates AudioWarp quantizing. This enables the **Slice Rules** section.

Create

Creates warp markers for all the tracks.

RELATED LINKS

[Options for Quantizing Multiple Audio Tracks](#) on page 332

[AudioWarp Quantizing Multiple Audio Tracks](#) on page 325

[Group Editing Mode](#) on page 238

Fades, Crossfades, and Envelopes

Fades allow you to gradually increase or decrease the volume at the start or end of audio events or audio clips, and to create smooth transitions.

You can create the following fades:

- Fade ins/fade outs

Fade ins and fade outs allow you to gradually increase or decrease the volume of audio events or audio clips. Fade ins and fade outs can be either event-based or clip-based.

Event-based fades are calculated in real time when you play back audio events. You can create different fade curves for several events, even if they refer to the same audio clip.

NOTE

The more event-based fades you apply, the more processing power is used.

Clip-based fades are applied to the audio clip. Events that refer to the same clip will have the same fades.

- Crossfades

Crossfades allow you to create smooth transitions for consecutive audio events on the same track. Crossfades are always event-based.

- Auto fades

Auto fades allow you to automatically apply short fade ins and fade outs to the events on specific audio tracks. You can also apply them globally on all audio tracks. This creates smooth transitions between events.

- Event envelopes

Event envelopes are volume curves for audio events or audio clips. They allow for volume changes not only at the start or the end, but also within the audio or clip. They can be either event-based or clip-based.

RELATED LINKS

[Event-Based Fades](#) on page 335

[Creating Clip-Based Fades](#) on page 339

[Crossfades](#) on page 340

[Auto Fades and Crossfades](#) on page 347

[Event Envelopes](#) on page 349

Event-Based Fades

You can create event-based fade ins and fade outs. These are calculated in real time when you play back audio events. You can create different fade curves for several events, even if they refer to the same audio clip.

There are several ways to create event-based fades:

- By using the event handles
- By using range selections

You can edit event-based fades in the **Fade** dialogs.

RELATED LINKS

[Creating and Editing Fades with the Handles](#) on page 336

[Creating and Editing Fades with the Range Selection Tool](#) on page 337

[Fade Dialog for Event-Based Fades](#) on page 338

Creating and Editing Fades with the Handles

You can create and edit event-based fade ins and fade outs using the event handles. This gives you a visual feedback and allows you to apply the same fade type to several selected events.

PROCEDURE

1. Select the audio events for which you want to create fades and point at one of them with the mouse.

Triangular fade handles become visible in the upper left and right corners.

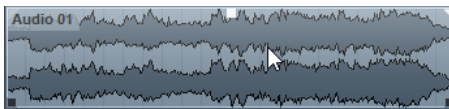

2. Perform one of the following actions:

- Drag the left fade handle to the right to create a fade in.

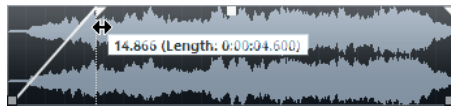

- Drag the right fade handle to the left to create a fade out.

RESULT

The fade is applied and shown in the event waveform. If you select multiple events, the same fade is applied to all selected events.

NOTE

You can change the length of the fades at any time by dragging the handles.

Event Handles

Audio events have a fade-in and a fade-out handle, as well as a volume handle. These handles provide a quick way to change the fade length or the volume of events in the **Project** window.

Event handles become visible if you point the mouse at an event or if you select events.

NOTE

To show event handles and fade curves always and not only when you point at events, activate **Show Event Volume Curves Always** in the **Preferences** dialog (**Event Display—Audio** page).

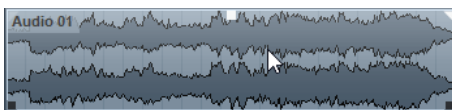

In the upper left and right corners, you find triangular fade handles that allow you to change the fade-in or fade-out length. In the top middle, you find a square handle that allows you to change the volume.

- To change the fade-in length, drag the fade handle in the upper left to the right or to the left.
- To change the fade-out length, drag the fade handle in the upper right to the left or to the right.
- To change the volume, drag the volume handle in the top middle up or down.

Fade and volume changes are reflected in the event waveform and on the info line.

NOTE

To change the event volume and the fades with the mouse wheel, activate **Use Mouse Wheel for Event Volume and Fades** in the **Preferences** dialog (**Editing—Audio** page). When you press **Shift** while moving the mouse wheel, and position the mouse pointer somewhere in the left half of the event, the fade in end point is moved. When the mouse pointer is in the right half of the event, the fade out start point is moved.

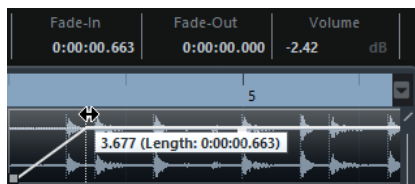

Creating and Editing Fades with the Range Selection Tool

You can create and edit event-based fades with the **Range Selection** tool. This allows you to apply a fade in and a fade out at the same time. Using the **Range Selection** tool is also useful if you want to create fades for multiple audio events on separate tracks.

PROCEDURE

1. On the **Project** window toolbar, select the **Range Selection** tool.
 2. Perform one of the following actions:
 - To create a fade in that starts at the event start, select a range that starts at the event start.
 - To create a fade out that ends at the event end, select a range that ends at the event end.
 - To create a fade in and a fade out, select a range in the middle of the event.
 - To create fades on multiple tracks, select a range that spans multiple audio events on multiple audio tracks.
 3. Select **Audio > Adjust Fades to Range**.
-

Applying Default Fades

You can use default fades to create event-based fade ins and fade outs.

PROCEDURE

1. Select one or more audio events in the **Project** window.
 2. Perform one of the following actions:
 - To create a fade in, select **Audio > Apply Standard Fade In**.
 - To create a fade out, select **Audio > Apply Standard Fade Out**.
-

RESULT

An event-based fade of the same length and shape as the default fade is applied.

NOTE

To change the default fade, select **Audio > Open Fade Editor(s)**, set up the fade and click **As Default**.

RELATED LINKS

[Fade Dialog for Event-Based Fades](#) on page 338

Removing Event-Based Fades

You can remove event-based fades for a whole event or for a range.

PROCEDURE

1. Perform one of the following actions:
 - To remove the fades for an event, select the event with the **Object Selection** tool.
 - To remove the fades for a range, select the fade area with the **Range Selection** tool.
 2. Select **Audio > Remove Fades**.
-

Fade Dialog for Event-Based Fades

The fade dialog for event-based fades allows you to set up the selected event-based fades.

- To open the dialog for event-based fades, create a fade for one or more audio events, select the events and select **Audio > Open Fade Editor(s)**.

NOTE

If you select several events, you can adjust the fade curves for all selected events at the same time. This is useful if you want to apply the same type of fade in to more than one event, for example.

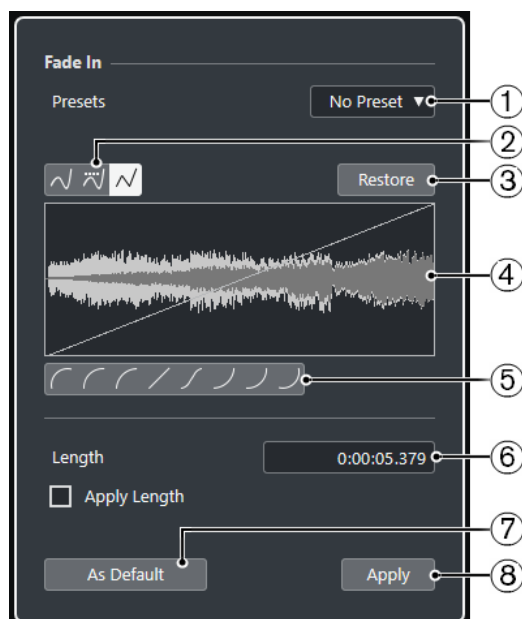

The following options are available:

1 Presets pop-up menu

Allows you to set up presets for fade-in or fade-out curves.

- To apply a saved preset, select it from the pop-up menu.
- To remove a saved preset, select it from the pop-up menu and click **Remove**.

2 Curve Type buttons

Apply a spline interpolation, a damped spline interpolation, or a linear interpolation to the curve.

3 Restore

Click this button to cancel any changes you have made since opening the dialog.

4 Fade display

Shows the shape of the fade curve. The resulting waveform shape is shown darker, the current waveform shape is shown lighter.

- To add points, click the curve.
- To change the curve shape, click and drag existing points.
- To remove a point from the curve, drag it outside the display.

5 Curve Shape buttons

Give you quick access to some common curve shapes.

6 Length field

Allows you to enter fade lengths numerically. The format of values displayed here is determined by the time display on the **Transport** panel.

- If you activate **Apply Length**, the value entered in the **Fade Length** value field is used when clicking **Apply** or **OK**.
- If you set the current fade as the default fade, the length value is included as part of the default settings.

7 As Default

Saves the current settings as default fade.

8 Apply

Applies the current fade settings to the selected events.

Creating Clip-Based Fades

You can create and edit clip-based fade ins and fade outs using **Direct Offline Processing**. These fades are applied to the audio clip. Events that refer to the same clip get the same fades.

PROCEDURE

1. In the **Project** window, select one or more audio events or a range for which you want to create a fade.
The length of your selection determines the length of the fade area.
 2. Perform one of the following actions:
 - To create a fade in, select **Audio > Processes > Fade In**.
 - To create a fade out, select **Audio > Processes > Fade Out**.
 3. In the **Direct Offline Processing** window, click the **Curve Type** buttons to specify a fade curve, or click and drag with the mouse in the curve display to draw in a curve.
 4. Optional: Activate **Audition** to hear the effect of the specified fade on the selected audio event.
-

RESULT

The fade is applied to the audio. You can remove or modify the fades at any time using the **Direct Offline Processing** window.

RELATED LINKS

[Direct Offline Processing](#) on page 534

[Fade In/Fade Out](#) on page 549

[On Processing Shared Clips](#) on page 340

On Processing Shared Clips

If several events refer to the same audio clip, this clip is a shared clip. If you edit one of the events that refer to a shared clip, you can decide if you want to apply the processing to all events referring to this clip.

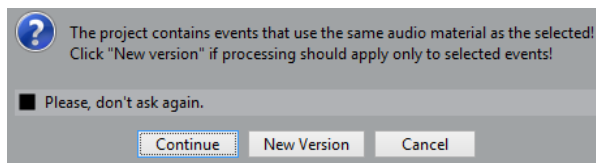

Continue

Click **Continue** to apply the processing to all events that refer to the audio clip.

New Version

Click **New Version** to create a separate, new version of the audio clip for the selected event.

Crossfades

Crossfades allow you to create smooth transitions for consecutive audio events on the same track. Crossfades are always event-based.

You can only create crossfades if the consecutive events or their respective clips overlap.

- If the audio events overlap, a crossfade of the default shape (linear, symmetric) is applied in the overlapping area.

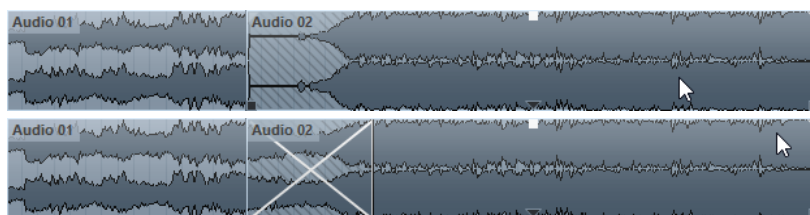

NOTE

You can edit the default crossfade length and shape in the **Crossfade** editor.

- If the respective audio clips overlap, the two events are resized so that they overlap, and a crossfade of the default length and shape is applied in the overlapping area.
- If neither the audio events nor the clips overlap, a crossfade cannot be created.

RELATED LINKS

[Crossfade Editor](#) on page 341

Creating Crossfades

You can create crossfades between two consecutive audio events.

PROCEDURE

1. Perform one of the following actions:
 - To create a crossfade between two events, select the **Object Selection** tool, and select two consecutive audio events.
 - To create a crossfade to a selected range between two events, select the **Range Selection** tool, and select a range covering the area where you want to apply a crossfade.
2. Select **Audio > Crossfade** or use the key command **X**.

RESULT

The crossfade is applied.

Changing the Crossfade Length

You can change the length of a crossfade.

PROCEDURE

1. Select the **Range Selection** tool.
2. Select a range between two events that covers the length of the crossfade you want to apply.
3. Select **Audio > Adjust Fades to Range**.

RESULT

The crossfade length is adjusted to the selected range.

Crossfade Editor

The **Crossfade** editor allows you to edit crossfades. It shows a fade display of the selected audio and the fade curves together with fade-in and fade-out curve settings, and common settings.



- To open the **Crossfade** editor, select one or both crossfaded events, and select **Audio > Crossfade**, or double-click the crossfade zone.

NOTE

You can activate a simplified **Crossfade** editor in the **Preferences** dialog. Select **Editing > Audio** and activate the **Simple Crossfade Editor** option.



Curve Type buttons

Determine whether the corresponding fade curve uses **Spline Interpolation** , **Damped Spline Interpolation** , or **Linear Interpolation** .

Curve Shape buttons

Give you quick access to some common curve shapes.



Fade Curve displays

Show the shape of the fade-out and fade-in curve, respectively.

- To add points, click a curve.
- To change the fade shape, click and drag existing points.
- To remove a point, drag a point outside the display.

Length

Specifies the length of the crossfade area.

Overlap

Defines the position of the splice point in the crossfade area.

Volume

Changes the volume of the crossfaded events. This is the same as using the volume handles in the event display.

Nudge

Nudges the fade area or the audio in the desired direction.

Nudge Range

Specifies the range that is moved when using **Nudge**.

Nudge modes

Determines what is moved when you use **Nudge**.

- To move the audio, activate **Nudge: Move Audio**.
- To move the fade, activate **Nudge: Move Fade**.

Chaining Mode

Determines how the audio to the right of the crossfade on the track behaves when you move the crossfade for an event.

- To move all following events on the track, activate **Until End**.
- To move all following events on the track up to the next gap, activate **Until Gap**.
- To move none of the following events on the track, activate **None**.

NOTE

The behavior is different depending on whether the next audio event on the track follows seamlessly or with a gap.

Splice Point Offset

The dotted vertical line in the fade-in and fade-out curves marks the splice point. If you work with asymmetric crossfades, you can set a splice point offset. This means that the splice points for the fade-in and the fade-out event are different.

Symmetric Fades

Activate this to link the editing controls of the fade-out and fade-in curves. This allows you to use the fade-out or fade-in controls to move both fade curves by the same amount.

Presets

Click **Save Preset** on the **Presets** pop-up menu to store the crossfade settings so that you can apply them to other events.

- To remove a preset, select it on the pop-up menu and click **Remove Preset**.

Default buttons

Click **As Default** to store the current settings as default. Default settings are used whenever you create new crossfades.

Click **Recall Default** to apply the curves and settings of the default crossfade.

Equal Gain

Adjusts the fade curves so that the summed fade-in and fade-out amplitudes are the same all along the crossfade region. This is often suitable for short crossfades.

Equal Power

Adjusts the fade curves so that the energy (power) of the crossfade is constant all along the crossfade region.

Equal Power curves have only one editable curve point. You cannot change the curve shape if this mode is selected.

Auto Zoom

Zooms and centers the display automatically on the current crossfade when you resize it. This also works when you select the next crossfade using **Select Crossfade**.

Auto-Scroll

Scrolls the crossfade display during playback, so that the position cursor is always visible. This only applies when using the **Transport** panel and it works like the corresponding function in the **Project** window.

Zoom to Fade

Zooms and centers the display on the selected crossfade area.

Volume

Allows you to set the audition level.

Pre-roll and Post-roll

- To start playback before the fade area, activate **Use Pre-roll**.
- To stop playback after the fade area, activate **Use Post-roll**.
- To adjust the pre-roll time, use the **Pre-roll Amount** value field.
- To adjust the post-roll time, use the **Post-roll Amount** value field.

Audition buttons

- To audition the fade-out part of the crossfade, click **Play Fade Out**.
- To audition the whole crossfade, click **Play Crossfade**.
- To audition the fade-in part of the crossfade, click **Play Fade In**.

You can set up key commands for this in the **Key Commands** dialog.

Select Crossfade buttons

Allow you to select the previous/next crossfade area, provided that the current track contains more than one crossfade.

Project Selection Follows Fade

If this option is activated, selecting another crossfade automatically changes the event selection in the **Project** window.

RELATED LINKS

[Moving the Crossfade Area with the Nudge buttons](#) on page 345

[Moving the Crossfade Area with the Overlap Controls](#) on page 344

[Resizing the Crossfade Area](#) on page 346

[Key Commands](#) on page 1313

[Event Handles](#) on page 336

[Auto-Scroll Settings Menu](#) on page 274

Moving the Crossfade Area

You can edit crossfades by moving the crossfade area, that is, the overlapping area between two audio events or clips.

In the **Crossfade** editor, you have the following options to move the crossfade area:

- You can use the **Overlap** controls to determine how much of the fade-out and how much of the fade-in event is included in the crossfade area.
- You can use the **Nudge** buttons in **Move Fade** mode to move the crossfade area. The audio events or clips keep their positions.
- You can use the **Nudge** buttons in **Move Audio** mode to move the audio of the fade-in event. The size of the crossfade area is kept.

Moving the Crossfade Area with the Overlap Controls

The **Overlap** controls allow you to determine how much of the fade-out and how much of the fade-in event are included in the crossfade area. By moving the **Overlap** controls, you move

the overlapping area between two audio events or clips. The audio events or clips keep their positions.

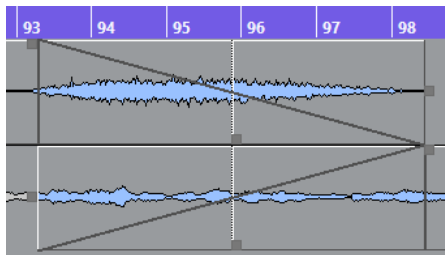

- If you activate the **Symmetric Fades** option, the splice point for the fade out and the fade in is initially situated in the center of the crossfade. If you move the **Overlap** control for the fade in, the fade out control moves accordingly.
- If you deactivate the **Symmetric Fades** option, you can move the **Overlap** controls separately to set up different overlap values for the fade-in and fade-out curves. This is indicated in the **Splice Point Offset** field.

Moving the Crossfade Area with the Nudge buttons

You can use the **Nudge** buttons in **Move Fade** mode to move the crossfade area. You can use the **Nudge** buttons in **Move Audio** mode to move the audio of the fade-in event. Each time you click **Nudge**, the crossfade area or audio clip is moved in the corresponding direction by the amount specified on the **Nudge Range** pop-up menu.

- To move the fade area, activate **Move Fade** in the **Nudge Mode** section.
- To move the audio clip, activate **Move Audio** in the **Nudge Mode** section.
- If you activate **Symmetric Fades**, and the **Nudge Mode** is set to **Move Fade**, the fade out area and the fade in area are moved by the same amount.

You can also move the fade by using the middle handle of the fade out or the fade in curve.

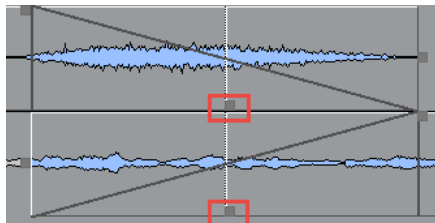

- If you activate **Symmetric Fades**, and the **Nudge Mode** is set to **Move Audio**, the **Nudge** buttons in the fade in display move the audio event.

You can also move the audio by clicking the fade in event and dragging with the hand symbol that appears.

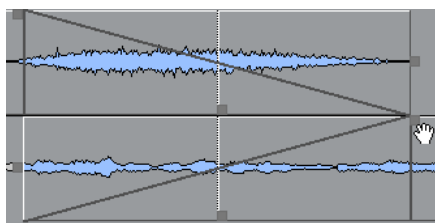

NOTE

You cannot move the audio of the fade out event.

Resizing the Crossfade Area

You can edit crossfades by resizing the crossfade area, that is, the overlapping area between two audio events or clips.

In the **Crossfade** editor, you have the following options to resize the crossfade area:

- You can use the **Length** controls to resize the crossfade areas between two audio events or clips without moving the splice points.
- You can use the fade in curve and fade out curve handles to resize the crossfade area between two audio events or clips and move the splice points at the same time.

IMPORTANT

To be able to resize a crossfade, it must be possible to resize the corresponding event. If the fade out event already plays its audio clip to the end, its end point cannot be moved any further to the right.

Changing the Crossfade Length Without Moving the Splice Points

You can resize the crossfade area between two audio events or clips without moving the splice points.

- To resize the crossfade area, use the **Length** controls or the **Length** fields. You can also resize the crossfade area by clicking and dragging the length handles for the fade out and the fade in curve in the crossfade display.

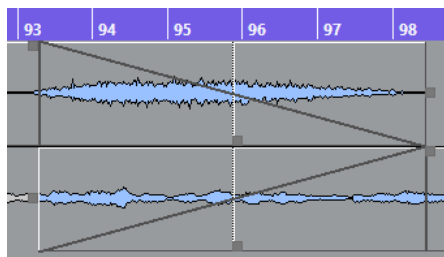

- If you activate **Symmetric Fades**, the fade out and the fade in lengths are changed by the same amount.
- If you deactivate **Symmetric Fades**, you can use the upper **Length** controls to change the length of the fade out curve, and the lower controls to change the length of the fade in curve.

Changing the Crossfade Length and Moving the Splice Points

You can resize the crossfade area between two audio events or clips and move the splice points at the same time.

- To resize the crossfade area together with the splice points, drag the right handle of the fade out curve to the left or drag the left handle of the fade in curve to the right.

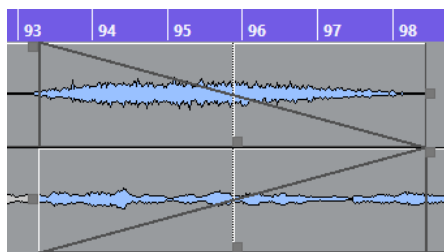

- If **Symmetric Fades** is activated, the length and splice points of both the fade out curve and the fade in curve are changed.

- If **Symmetric Fades** is deactivated, the right handle of the fade out curve changes the length and splice point of the fade out curve, and the left handle of the fade in curve changes the length and splice point of the fade in curve.

Removing Crossfades

You can remove crossfades.

PROCEDURE

1. Perform one of the following actions:
 - Select the **Object Selection** tool and select one of the crossfaded events.
 - Select the **Range Selection** tool and select the crossfades you want to remove.
2. Select **Audio > Remove Fades**.

RESULT

The selected crossfades are removed.

NOTE

You can also remove a crossfade by clicking and dragging it outside the track.

Auto Fades and Crossfades

Nuendo features an **Auto Fade** function that can be set both globally and separately for each audio track. Auto fades allow you to create smoother transitions between events by applying fade ins and fade outs with a length between 1 and 500 ms.

IMPORTANT

As event-based fades are calculated in real time during playback, applying auto fades to a higher number of audio events results in a higher demand on the processor.

NOTE

Auto fades are not indicated by fade lines.

Auto Fades Dialog

The **Auto Fades** dialog allows you to set up auto fades and crossfades for the whole project, or separately for each audio track.

- To open the global **Auto Fades** dialog, select **Project > Auto Fades Settings**.
- To open the **Auto Fades** dialog for a track, right-click in the track list and select **Auto Fades Settings**.

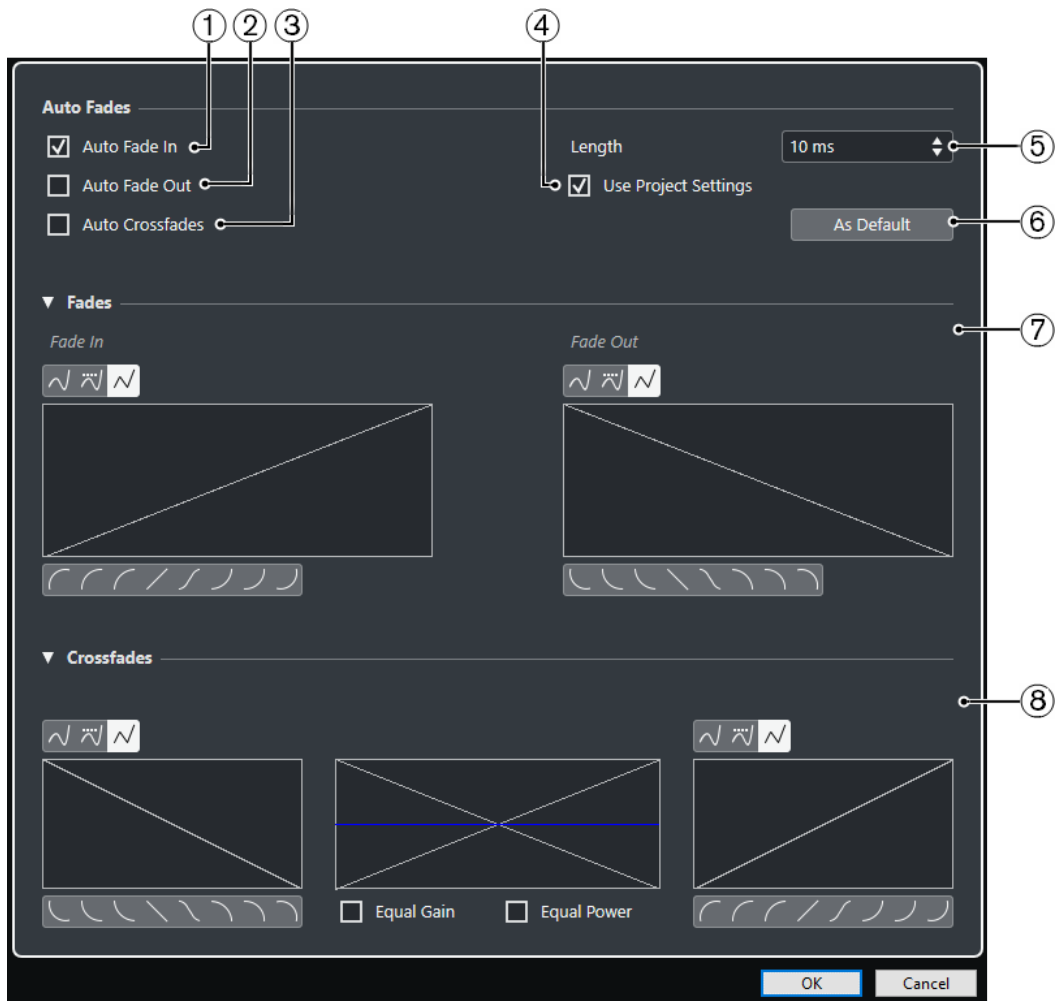

1 Auto Fade In

Activates auto fade ins.

2 Auto Fade Out

Activates auto fade outs.

3 Auto Crossfades

Activates auto crossfades.

4 Use Project Settings

This is only available if you opened the **Auto Fades** dialog for individual tracks. Deactivate this to set up and apply the settings to individual tracks only. If you want a track with individual auto fade settings to use the global settings again, activate **Use Project Settings**.

5 Length

Specifies the length of the auto fades or crossfades.

6 As Default

Saves the current settings as default.

7 Fades section

Provides the settings for auto fades.

The **Curve Type** buttons allow you to determine whether the corresponding fade curve uses **Spline Interpolation**, **Damped Spline Interpolation** or **Linear Interpolation**.

The **Curve Shape** buttons give you quick access to common curve shapes.

8 Crossfades section

Provides the settings for auto crossfades.

Equal Gain allows you to adjust the fade curves so that the summed fade-in and fade-out amplitudes are the same all along the crossfade region.

Equal Power allows you to adjust the fade curves so that the energy (power) of the crossfade is constant all along the crossfade region.

Making Global Auto Fade Settings

You can set up auto fades and crossfades for the whole project.

PROCEDURE

1. Select **Project > Auto Fades Settings**.
This opens the **Auto Fades** dialog for the project.
 2. Set up the fades as desired.
 3. Click **OK**.
-

RELATED LINKS

[Fade Dialog for Event-Based Fades](#) on page 338
[Crossfade Editor](#) on page 341

Making Auto Fade Settings for Individual Tracks

As auto fades use computing power, you might consider to turn auto fades off globally and activate them only for individual tracks.

PROCEDURE

1. Perform one of the following actions:
 - Right-click the track in the track list, and from the context menu, select **Auto Fades Settings**.
 - Select the track, and in the **Inspector**, click **Auto Fades Settings**.
The **Auto Fades** dialog for the track opens.
 2. Deactivate **Use Project Settings**.
Any settings you now make are applied to the track only.
 3. Set up the auto fades.
 4. Click **OK**.
-

Event Envelopes

Event envelopes are volume curves for audio events. They allow you to create volume changes within the event, not only at the start or end.

On the event envelopes, you can create volume changes by adding curve points with the **Draw** tool.

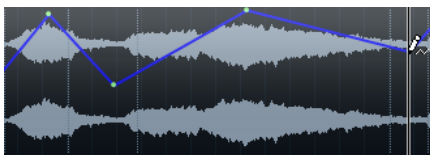

The envelope curve is a part of the audio event. If you move or copy the event, the event envelope follows.

Creating Event-Based Volume Changes

You can create volume changes for the audio event.

PROCEDURE

1. Zoom in on the event so that you can view its waveform properly.
2. Select the **Draw** tool and click at the position in the event where you want to change the volume.
3. Click with the **Draw** tool.



A curve point is added to the envelope curve.

4. Drag the curve point to adjust the volume curve.
-

RESULT

The volume change is created. The waveform image of the event changes according to the volume change.

Removing Event Envelopes

You can remove the entire event envelope or single curve points.

PROCEDURE

- Perform one of the following actions:
 - To remove a curve point from the envelope, click on it and drag it outside the event.
 - To remove an event envelope curve from a selected event, select **Audio > Remove Volume Curve**.
-

Creating Clip-Based Volume Changes

You can create volume changes for the audio clip. The audio event changes accordingly.

PROCEDURE

1. In the **Project** window, select the event.
 2. Select **Audio > Processes > Envelope**.
 3. In the **Direct Offline Processing** dialog, make your changes, and click **Apply**.
-

RESULT

The volume change is created. The waveform image of the event changes according to the volume change.

RELATED LINKS

[Envelope](#) on page 548

Arranger Track

The arranger functions in Nuendo allow you to work in a non-linear fashion. Using an arranger track allows you to specify how and when specific sections are played back, even in live performances. This way, you do not need to move, copy, and paste events in the **Project** window.

NOTE

There can be only one arranger track in a project.

To use the arranger functions, you must add an arranger track and define arranger events. Arranger events can be of any length. They can overlap and are not bound to the start or end of existing events and parts. You can order them in a list, and add repeats as desired.

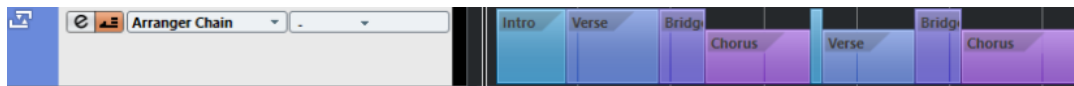

You can edit arranger events using the standard techniques. Copies from arranger events are independent from the original event.

You can create several arranger chains that allow you to save different versions of a song within the project.

You can flatten arranger chains to convert them into a linear project.

RELATED LINKS

[Adding Arranger Events on the Arranger Track](#) on page 351

[Setting up an Arranger Chain and Adding Events](#) on page 355

[Flattening the Arranger Chain](#) on page 356

Adding Arranger Events on the Arranger Track

On the arranger track, you can add arranger events that define specific sections of the project.

PREREQUISITE

Snap is activated, and **Snap Type** is set to **Events**.

PROCEDURE

1. Select **Project > Add Track > Arranger**.
The arranger track is added.
2. Select the **Draw** tool and draw an arranger event on the arranger track.
An arranger event is added.
3. Draw as many events as you need.

RESULT

The arranger events are added to your project.

AFTER COMPLETING THIS TASK

Use the functions of the **Arranger Editor** to arrange the events.

RELATED LINKS

- [Arranger Track](#) on page 158
- [Setting up an Arranger Chain and Adding Events](#) on page 355
- [Snap Function](#) on page 89
- [Snap Types Menu](#) on page 90

Renaming Arranger Events

When you add arranger events, they are automatically named in alphabetical order. You can change the names so that they reflect the structure of your project, such as Intro, Chorus, Bridge, for example.

PROCEDURE

1. Select the arranger event that you want to rename.
 2. Perform one of the following actions:
 - Select the event name on the info line.
 - Hold down **Alt/Opt** and double-click the name in the arranger chain.
 3. Enter a new name.
-

Arranger Editor

The **Arranger Editor** allows you to set up arranger chains.

- To open the **Arranger Editor**, select an arranger track, and click **Open Arranger Editor** in the track list.

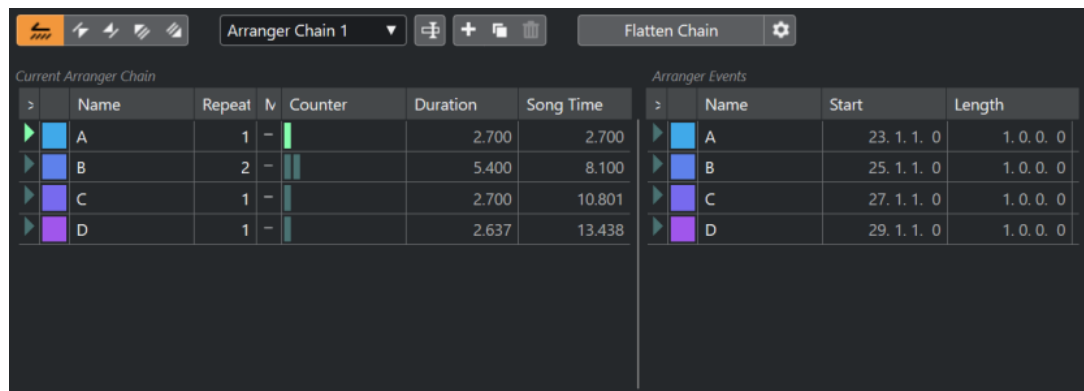

Arranger toolbar

Shows the transport buttons, the arranger transport buttons, and the arranger tools.

Current Arranger Chain

Shows the order in which the events are played back, from top to bottom, and how many times they are repeated.

NOTE

Initially, the arranger chain is empty. To fill it up, you must add events from the **Arranger Events** list.

Arranger Events

Lists the available arranger events in the order they appear on the timeline.

Arranger Editor Toolbar

The **Arranger Editor** contains tools and shortcuts for setting the flatten options.

- To open the **Arranger Editor**, select an arranger track, and click **Open Arranger Editor**  in the track list.

Activate Arranger Mode



Activates playback in arranger mode.

Previous Chain Step



Navigates to the previous entry in the current arranger chain list.

Next Chain Step



Navigates to the next entry in the current arranger chain list.

First Repeat of Current Chain Step



Navigates to the first repeat of the current entry in the current arranger chain list.

Last Repeat of Current Chain Step



Navigates to the last repeat of the current entry in the current arranger chain list.

Select Active Chain

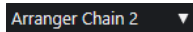

Allows you to select and activate an arranger chain.

Rename Current Chain



Allows you to rename the current arranger chain.

Create New Chain



Creates a new, empty arranger chain.

Duplicate Current Chain



Creates a duplicate of the current arranger chain, containing the same events.

Remove Current Chain



Removes the selected arranger chain. This is only available if you have created more than one arranger chain.

Flatten Chain

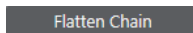

Converts the current arranger chain into a linear project.

Flatten (with Options & Preferences)



Allows you to set up the flatten options.

Arranger Chain Repeat Modes

The **Arranger Editor** features a function that allows you to repeat and loop your arranger events. This way, you can create a sketch of a song structure.

- To open the **Arranger Editor**, select an arranger track, and click **Open Arranger Editor** in the track list.

To select one of the repeat modes, click the **Mode** column in the **Current Arranger Chain** list.

1 Normal

Plays back the arranger chain exactly the way you set it up.

2 Repeat Forever

Repeats the current arranger event in a loop until you click another event in the **Arranger Editor** or until you click **Play** once again.

3 Pause After Repeats

Pauses playback after all repeats of the current arranger event have been played back.

NOTE

During playback, the **Counter** column indicates which repetition of the event is playing.

Flatten Options & Preferences

The flatten options allow you to define what happens when you flatten the arranger track.

- To show the flatten options, open the **Arranger Editor**, and click **Flatten (with Options & Preferences)**.

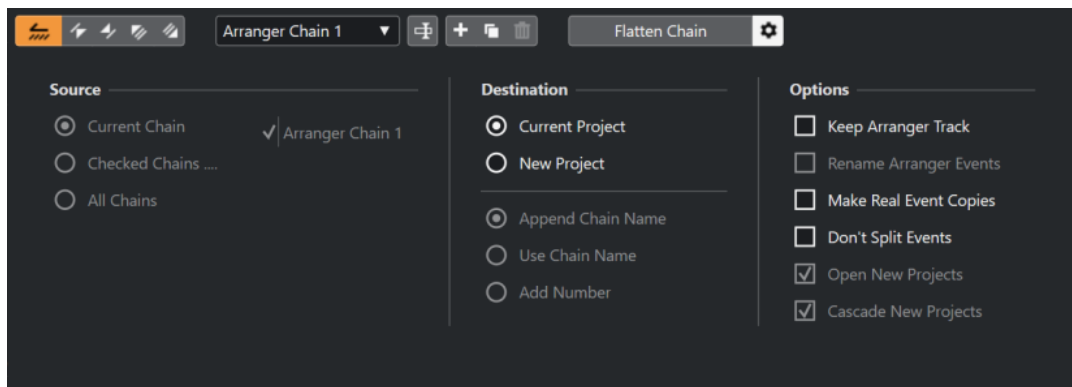

In the **Source** section, you can specify which arranger chains are flattened.

Current Chain

Flattens the current chain only.

Checked Chains

Opens a list of the available arranger chains where you can activate the arranger tracks that you want to flatten.

All Chains

Flattens all arranger chains of the current project.

The **Destination** section allows you to choose where the result of the flattening is saved.

Current Project

This is only available if **Source** is set to **Current Chain**. Activate this option if you want to save the flattened chain in the current project.

New Project

Allows you to flatten one or more chains in a new project with the following naming options:

- **Append Chain Name**
Appends the chain names to the project name.
- **Use Chain Name**
Names the new projects after the current arranger chains.
- **Add Number**
Names the new projects after the old ones and adds a number.

The **Options** section contains further settings.

Keep Arranger Track

Keeps the arranger track after flattening. Activate **Rename Arranger Events** to append numbers to the events.

Make Real Event Copies

Allows you to create real copies of the arranger track instead of shared copies.

Don't Split Events

Excludes MIDI notes that start before or are longer than the arranger event. Only MIDI notes that begin and end inside the arranger event are taken into account.

Open New Projects

Creates a new project for every flattened arranger chain. If you activate **Cascade New Projects**, the opened projects are cascaded.

RELATED LINKS

[Flattening the Arranger Chain](#) on page 356

Setting up an Arranger Chain and Adding Events

In the **Arranger Editor** you can set up arranger chains and add events to them.

PROCEDURE

1. Click **e** to open the **Arranger Editor**.
2. Activate **Activate Arranger Mode**.

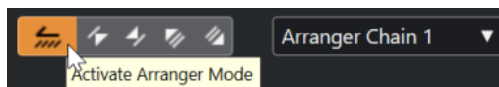

3. Perform one of the following actions to add arranger events to the arranger chain:
 - Double-click an event in the **Arranger Events** list.
 - Select one or more events in the **Arranger Events** list, right-click, and select **Append Selected In Arranger Chain**.
 - Drag an arranger event from the **Arranger Events** list and drop it in the **Current Arranger Chain** list.
 - Drag an arranger event from the **Project** window and drop it in the **Current Arranger Chain** list.
 4. Click **Play**.
-

RESULT

The arranger events are played back in the order that you specified in the arranger chain.

RELATED LINKS

[Arranger Chain Repeat Modes](#) on page 354

Adding a New Arranger Chain

You can create several arranger chains in order to set up alternative versions for playback.

PREREQUISITE

Arranger Mode is activated.

PROCEDURE

1. Open the **Arranger Editor**.
 2. Click **Create New Chain**.
-

RESULT

A new, empty arranger chain is activated. This is reflected by a new name in the **Select Active Chain** pop-up menu and a new, empty **Current Arranger Chain** list.

Editing Arranger Events in the Arranger Chain

In the **Current Arranger Chain** list, you can edit your arranger events.

You can perform the following actions:

- To select multiple events, **Ctrl/Cmd**-click or **Shift**-click them.
- To move events in the list, drag them up or down.
- To copy events, select them, hold **Alt/Opt** and drag.
- To repeat events, click in the **Repeats** column and enter the number of repeats.
- To specify how the event is repeated, click in the **Mode** column and select a **Repeat Mode** from the pop-up menu.
- To move the playback position to the start of an event, click the arrow to the left of the event.
- To remove an event from the list, right-click on it, and from the context menu, select **Remove Touched**.
- To remove several events, select them, right-click, and from the context menu, select **Remove Selected**.

RELATED LINKS

[Arranger Chain Repeat Modes](#) on page 354

Flattening the Arranger Chain

When you have set up an arranger chain that you like, and you are sure that you do not want to edit it any more, you can convert it to a linear project.

PREREQUISITE

You have saved a copy of the project before flattening the arranger chain.

NOTE

Flattening the arranger chain may remove events and parts from the project. Only use **Flatten** when you know you do not want to edit the arranger track/chain any more. If in doubt, save a copy of the project before flattening the arranger chain.

PROCEDURE

1. Select the arranger chain that you want to convert into a linear project.
2. Optional: Click **Flatten (with Options & Preferences)**

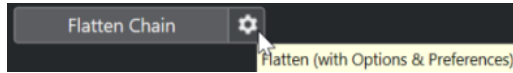

3. Optional: Activate the desired flattening options.

NOTE

If you realize that you want to do further adjustments, click **Go Back**. The activated flatten options are kept.

4. Click **Flatten**.
-

RESULT

The events and parts in the project are reordered, repeated, resized, moved and/or deleted, so that they correspond exactly to the arranger chain.

Jump Mode

If you have set up an arranger track and play it back, you have live access to the playback order. This way, you can loop your arranger events with more flexibility regarding the length of the playback.

PREREQUISITE

An arranger chain is set up and the arranger mode is activated.

PROCEDURE

1. Play back your project.
2. In the lower part of the **Inspector**, open the **Jump Mode** pop-up menu, and select an option from the pop-up menu.

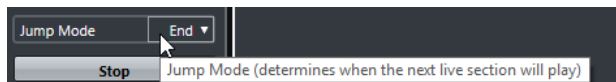

This determines how long the active arranger event is played, before jumping to the next one.

3. In the **Arranger Events** list of the **Inspector**, click the arrow to the left of the arranger event that you want to trigger.
-

RESULT

The arranger event is looped according to your settings, until you click another arranger event.

NOTE

You can assign key commands to trigger arranger events in the **Arranger** category of the **Key Commands** dialog.

AFTER COMPLETING THIS TASK

- To stop **Jump Mode**, click **Stop**.
- To continue playback from a specific arranger event, click the arranger event in the **Current Arranger Chain** list.

RELATED LINKS

[Jump Mode Options](#) on page 358

Jump Mode Options

The **Jump Mode** pop-up menu allows you to define how long the active arranger event is played before jumping to the next one.

- To show the **Inspector** for the arranger track, select the arranger track in the track list.

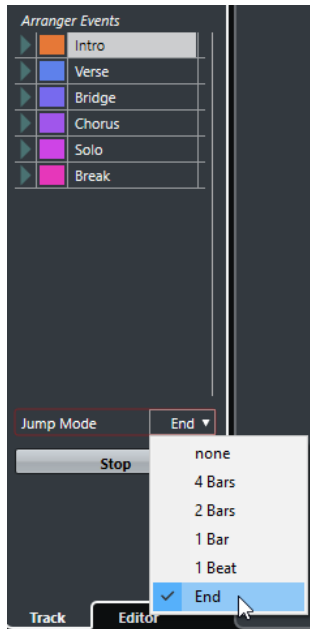

The following options are available:

None

Jumps to the next section immediately.

4 Bars, 2 Bars

Jumps to the next arranger event after 2 or 4 bars. If the current arranger event is shorter than 2 or 4 bars, playback jumps to the next arranger event at the event end.

1 Bar

Jumps to the next section at the next barline.

1 Beat

Jumps to the next section at the next beat.

End

Plays the current section to the end, then jumps to the next section.

Arranging Music to Video

When you compose music for video, you can use arranger events to fill a specific video section with music. The following is an example on how you could do that.

PREREQUISITE

You have connected and set up an external sync master device to your computer. You have created a new, empty project and added a MIDI track.

PROCEDURE

1. Create a MIDI part that starts at position 00:00:00:00 and ends at position 00:01:00:00.
 2. Create a MIDI part that starts at position 00:01:00:00 and ends at position 00:02:00:00.
 3. Create a MIDI part that starts at position 00:02:00:00 and ends at position 00:03:00:00.
 4. On the **Transport** panel, activate **Sync**.
 5. Select **Project > Add Track > Arranger**.
The arranger track is added.
 6. On the arranger track, add arranger events at the positions of the MIDI parts.
 7. Set up the arranger chain A-A-B-B-C-C.
 8. Activate **Arranger** mode and start playback.
 9. On your external sync master device, start external timecode at position 00:00:10:00.
In your project, the position 00:00:10:00 is located, and arranger part A is played back.
 10. Start your external sync master device at a position that does not match the project start time, for example, 00:01:10:00.
In your project, the position 00:01:10:00 is located, and arranger part A is played back.
-

RESULT

If you position the external sync master device to a position that does not match the project start time, Nuendo automatically jumps to the right position in the arranger track.

NOTE

The reference for the external timecode can be MIDI or any other timecode that can be interpreted by Nuendo.

RELATED LINKS

[Arranger Track](#) on page 158

Transpose Functions

The transpose functions for audio and MIDI in Nuendo allow you to change the pitches of audio and MIDI for playback without changing the actual MIDI notes or the audio.

You can transpose the following:

- An entire project by changing the **Project Root Key** on the **Project** window toolbar.
- Specific sections of your project by creating a transpose track and adding transpose events.
- Individual parts or events by changing their transpose value on the **Project** window info line.

IMPORTANT

As a general rule, always set the root key first when you work with content with a defined root key.

NOTE

To transpose MIDI notes on a selected track, you can also use MIDI modifiers. If you want to change the actual notes, use the MIDI transpose functions in the **Transpose Setup** dialog and in the MIDI effects (see the separate document **Plug-in Reference**).

RELATED LINKS

[Transposing with the Project Root Key](#) on page 361

[Transposing Sections of a Project with Transpose Events](#) on page 364

[Transposing Individual Parts or Events using the Info Line](#) on page 366

[MIDI Modifiers](#) on page 882

[Transpose and Velocity on the Info Line](#) on page 890

[Transpose Setup Dialog](#) on page 901

Project Root Key

The **Project Root Key** allows you to transpose your project. Audio or MIDI events in your project use it as a reference.

To change the **Project Root Key**, use the **Project Root Key** pop-up menu on the **Project** window toolbar.



If you change the project root key, loops that already contain root key information will follow automatically.

RELATED LINKS

[Transposing with the Project Root Key](#) on page 361

Transposing with the Project Root Key

The loops included in Nuendo already contain root key information. If you change the project root key, these loops will follow automatically.

PREREQUISITE

You have opened a project that contains audio loops with different root keys.

PROCEDURE

1. Optional: Select the drum and percussion loops in your project and set the **Global Transpose** setting on the info line to **Independent**.
This setting excludes the loops from being transposed.
2. On the **Project** window toolbar, open the **Project Root Key** pop-up menu and set a root key for the project.

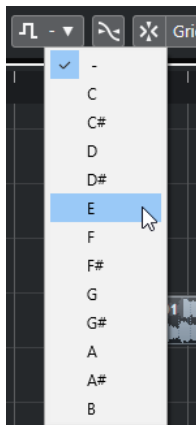

This changes the root key for the entire project and transposes the loops to match this key.

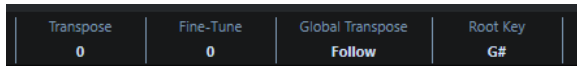

RESULT

The loops follow the project root key.

AFTER COMPLETING THIS TASK

Record audio or MIDI. The newly recorded events get the project root key. Change the project root key. The events with root key information follow.

RELATED LINKS

[Excluding Individual Parts or Events from Global Transpose](#) on page 367

[Transpose Track and Recording](#) on page 366

Assigning the Project Root Key to Parts or Events

Some audio or MIDI events that you have created by recording, for example, might not contain root key information. If you want them to follow the transposition changes, you must set them to the **Project Root Key**.

PROCEDURE

1. On the **Project** window toolbar, open the **Project Root Key** pop-up menu and set a root key for the project.
2. Optional: Select the drum and percussion loops in your project and set the **Global Transpose** setting on the info line to **Independent**.

This setting excludes the loops from being transposed.

3. Select **Project > Add Track > Transpose.**

The transpose track is added to the track list. You can only have one transpose track in a project.

4. In the track list, right-click the transpose track, and from the context menu select **Set root key for unassigned events.**

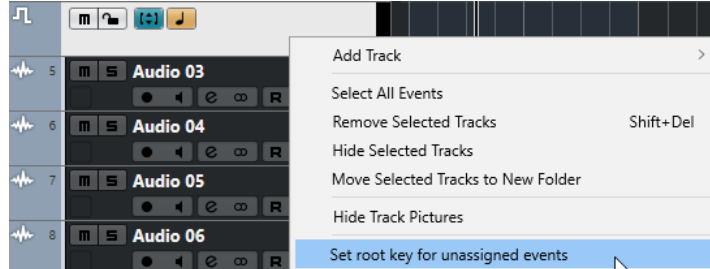

RESULT

All parts or events that do not contain any root key information are set to the project root key.

RELATED LINKS

[Excluding Individual Parts or Events from Global Transpose](#) on page 367

Recording with a Project Root Key

If you record with a project root key, the recorded events follow this root key automatically. This function is useful if you want to change the root key later and you want the events to follow.

PROCEDURE

1. Optional: Select the drum and percussion loops in your project and set the **Global Transpose** setting on the info line to **Independent**.
This setting excludes the loops from being transposed.
2. On the **Project** window toolbar, open the **Project Root Key** pop-up menu and set the root key.
All parts and events are transposed in order to match the root key.
3. Record your music.

RESULT

All recorded audio events and MIDI parts get the project root key information. On the info line, the **Global Transpose** setting for recorded events is set to **Follow**.

AFTER COMPLETING THIS TASK

Change the project root key. Your events will follow.

Changing the Root Key of Individual Audio Events

You can change or set the root key information for individual audio events or parts in the **Pool**.

PROCEDURE

1. Select **Media > Open Pool Window**.
2. Open the **View/Attributes** pop-up menu, and activate the **Root Key** option.
The **Key** column is displayed in the **Pool** window.

3. Click the **Key** column for the audio event or part that you want to assign a different root key to, and select a key from the pop-up menu.
-

RESULT

The root key of the audio event or part is changed. The corresponding audio file, however, remains unchanged. If you change the project root key, the audio events or parts keep their own root key settings, and are transposed to match the **Project Root Key**.

NOTE

You can also assign root keys in the **MediaBay**.

NOTE

Save the root key in the audio file by selecting the audio event in the event display, and by selecting **Audio > Bounce Selection**.

Changing the Root Key of Individual MIDI Parts

You can change the root key information for individual MIDI parts in the **Project** window info line.

PROCEDURE

1. In the event display, select the MIDI part.
 2. In the **Project** window info line, click **Root Key** and select a key from the pop-up menu.
-

RESULT

The root key of the MIDI part is changed. If you change the project root key, the MIDI parts keep their own root key settings, and are transposed to match the **Project Root Key**.

Transpose Track

The transpose track allows you to transpose the entire project or sections of it. This function is useful if you want to create harmonic variations.

For this function to work, you must add transpose events. These transpose events allow you to transpose specific sections of your project in semitones.

EXAMPLE

If your singer does not reach a certain pitch, you can transpose the entire project by adding a transpose track and creating a transpose event with the value -2 semitones. After recording, set the transpose event back to 0.

EXAMPLE

If you want to brighten up your loops in C major, you can transpose them by adding a transpose track and creating a transpose event with the value 5. This transposes them by 5 semitones, so that the subdominant on F major is played back.

EXAMPLE

If you want to turn your song more interesting, you can transpose the last chorus of your project by adding a transpose track and creating a transpose event with the value 1.

Transposing Sections of a Project with Transpose Events

You can transpose specific sections of your project by creating transpose events on the transpose track.

PROCEDURE

1. Select **Project > Add Track > Transpose**.

The transpose track is added to the track list. You can only have one transpose track in a project.

2. Select the **Draw** tool and click on the transpose track.

A transpose event is created from the point where you clicked until the end of the project.



3. Click at a new position to add another transpose event.



4. Click the value in the lower left corner of the event, and enter a transpose value between -24 and 24 semitones.

5. Play back your project.

RESULT

The sections of your project that are situated at the same time positions as the transpose events are transposed.

RELATED LINKS

[Excluding Individual Parts or Events from Global Transpose](#) on page 367

Muting Events on the Transpose Track

You can mute transpose events on the transpose track. This is useful if you want to compare the effect of the transposition with the original sound, for example.

PROCEDURE

- In the track list of the transpose track, click **Mute Transpose Events**.

RESULT

The transpose events are not taken into account during playback.

Transpose Lock

The lock function on the transpose track allows you to prevent your transpose events from being moved or changed by mistake.

To lock the transpose track, activate **Lock** in the track list.



Keep Transpose in Octave Range

Keep Transpose in Octave Range on the transpose track keeps the transposition in the octave range.

This ensures that nothing is transposed by more than seven semitones, and that your music never sounds unnatural because the pitch was raised too high or too low. We also recommend activating this function, when you work with audio loops.

EXAMPLE

You have opened the **Key Editor** and activated **Indicate Transpositions** .

You have added a transpose track and activated **Transpose in Octave Range** .

If you add a transpose event with a value of 8 semitones or higher, the chord is transposed to the nearest interval or pitch.

Indicate Transpositions

For MIDI parts, you can get a visual feedback that allows you to compare the original sounds and the music transposed for playback.

- To activate **Indicate Transpositions** for a MIDI part, open the part in the **Key Editor**, and click **Indicate Transpositions**.

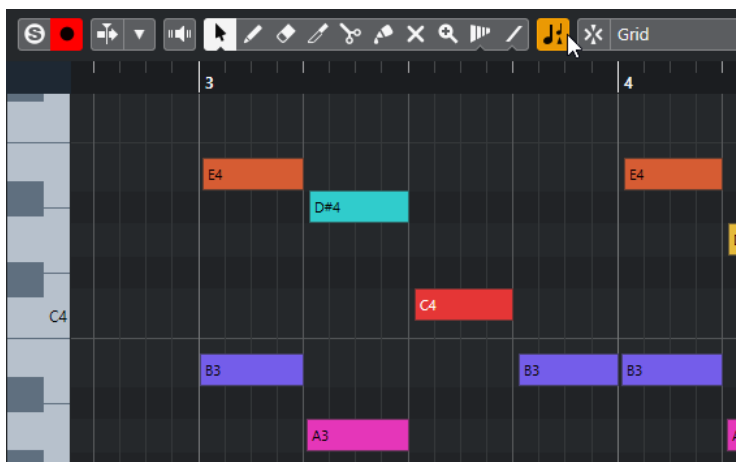

If **Indicate Transpositions** is activated, the transposed note pitches are shown.

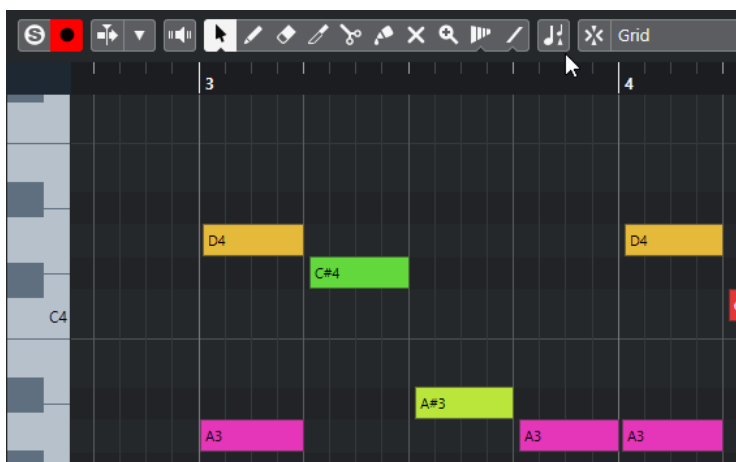

If **Indicate Transpositions** is deactivated, the original pitches of the notes in the MIDI part are shown.

Transpose Track and Recording

The transpose track affects the result of the recorded parts or events.

If your project contains a transpose track with transpose events, and you record audio or MIDI, the following happens:

- **Global Transpose** is automatically set to **Independent** for the recorded parts or events.
- The project root key is not taken into account.

If your project does not contain a transpose track or if no transpose events are added, the following happens:

- **Global Transpose** is automatically set to **Follow** for the recorded parts or events.
- The recorded parts or events get the project root key.

Transpose on the Info Line

In the **Project** window info line, you can change the transpose value for individual parts or events.

To do this, change the transpose value in the **Transpose** field on the info line.

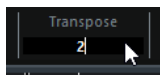

The Transpose field also indicates transpositions introduced by changing the **Project Root Key**.

Transposing Individual Parts or Events using the Info Line

You can transpose individual audio events and MIDI parts on the info line **Transpose** field.

PROCEDURE

1. Select the event or part that you want to transpose.
2. On the **Project** window info line, click the **Transpose** field and enter a transpose value in semitones.

NOTE

If the project already contains global transpose changes, it might be useful to activate **Keep Transpose in Octave Range**.

RESULT

The event is transposed accordingly. The transpose value is added to any global transpose change that you have created by using the root key or the transpose track.

RELATED LINKS

[Keep Transpose in Octave Range](#) on page 365

Excluding Individual Parts or Events from Global Transpose

If you add global transposition, for example, by changing the root key or by creating transpose events, you can exclude specific events from being transposed. This is useful for drum and percussion loops or special effects (FX) loops.

PROCEDURE

1. Select the event or part that you want to exclude from being transposed.
2. On the info line, click the **Global Transpose** field to set the value to **Independent**.
Events that are excluded from **Global Transpose** show a symbol in the upper right corner.

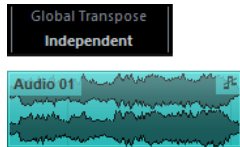

RESULT

If you change the project root key or add transpose events, the **Independent** parts or events are not affected.

NOTE

Ready-made parts or events that are tagged as drums or FX, are automatically set to **Independent**.

Markers

Markers are used to locate certain positions quickly. There are two types of markers: position markers and cycle markers.

If you often find yourself jumping to a specific position within a project, you should insert a marker at this position. You can also use markers to make range selections or for zooming.

Markers are located on marker tracks. For postproduction purposes, you can add up to 32 marker tracks. This is useful for viewing and working with Edit Decision Lists and CSV files.

A video cut detection allows you to add markers at all video cut positions.

You can show vertical marker lines that indicate marker positions on all tracks throughout the entire project. Marker lines are shown in the **Project** window and in the **Global Tracks** section of the **Key Editor Inspector**.

RELATED LINKS

[Position Markers](#) on page 368

[Cycle Markers](#) on page 368

[Marker Track](#) on page 377

[Event Opacity](#) on page 1362

[Event Display - Markers](#) on page 1365

[Showing/Hiding Marker Lines in the Project Window](#) on page 369

[Showing/Hiding Marker Lines in the Key Editor](#) on page 370

[Showing/Hiding Individual Tracks](#) on page 70

[Showing/Hiding Global Tracks in the Key Editor](#) on page 963

[EDL Files](#) on page 1254

[CSV Files](#) on page 383

[Adding Markers at Video Cut Positions](#) on page 1255

Position Markers

Position markers allow you to save a specific position.

Position markers on the marker track are shown as marker events: vertical lines with the marker description (if assigned) and number beside it. If you select a marker track, all its markers are shown in the **Inspector**.

Cycle Markers

By creating cycle markers you can save any number of left and right locator positions as start and end positions of a range and recall them by double-clicking on the corresponding marker.

Cycle markers are shown on a marker track as two markers bridged by a horizontal line. Cycle markers are ideal for saving sections of a project.

By defining cycle markers for different actors when post-synchronizing a film project, you can quickly navigate to the sections and repeat or record them again by activating **Activate Cycle** on the **Transport** panel.

Setting the Locators Using Cycle Markers

Cycle markers represent ranges in your project. You can use them for moving the left and right locators.

PROCEDURE

- To set the left locator to the cycle marker start and the right locator to the cycle marker end, perform one of the following actions:
 - Double-click on a cycle marker.
 - From the **Cycle** pop-up menu in the track list, select a cycle marker.
-

RESULT

The left and right locators are moved to encompass the cycle marker.

AFTER COMPLETING THIS TASK

Now you can move the project cursor position to the start or the end of the cycle marker by moving it to the corresponding locator or use cycle markers to export specific ranges of your project with the **Export Audio Mixdown** dialog.

Editing Cycle Markers

When editing cycle markers on a marker track, snap is taken into account.

- To add a cycle marker, press **Ctrl/Cmd**, click and drag on the marker track.
- To change the start/end position of a cycle marker, drag the start/end handle.
- To move a cycle marker to another position, drag the upper border.
- To delete a cycle marker, click with the **Erase** tool.
If you hold down **Alt/Opt** when you click, all consecutive markers are deleted.
- To cut a range in a cycle marker, select a range in the cycle marker and press **Ctrl/Cmd - X**.
- To set the marker start/end of the selected cycle marker to the cursor position, select **Project > Markers** to open the **Markers** window, and select **Functions > Set Marker Start/End to Cursor**.
- To set the left and right locators, double-click a cycle marker.
- To zoom in on a cycle marker, press **Alt/Opt** and double-click the cycle marker.

Showing/Hiding Marker Lines in the Project Window

You can activate/deactivate vertical marker lines that indicate marker positions on all tracks throughout the entire project. Marker lines are shown in the **Project** window event display. By default, marker lines are shown for the active marker track.

PREREQUISITE

- You have added at least one marker track and one marker to your project.
 - The marker track is visible and not filtered out with the **Visibility** tab.
-

PROCEDURE

- In the **Project** window track list, right-click a marker track and select an option from the **Show Marker Lines** menu.
You can show marker lines of the active marker track, of all marker tracks, or you can hide them.
-

RESULT

In the **Project** window event display, marker lines are shown according to your settings.

NOTE

The **Show Marker Lines** options are also available in the **Preferences** dialog (**Event Display—Markers** page).

Marker lines are shown behind other events on other tracks. If you need a more pronounced indication of the lines, consider lowering the **Event Opacity** in the **Preferences** dialog (**Event Display** page).

RELATED LINKS

[Event Display - Markers](#) on page 1365

Showing/Hiding Marker Lines in the Key Editor

You can activate/deactivate vertical marker lines that indicate marker positions on all tracks throughout the entire project. Marker lines are shown in the event display for global tracks in the **Key Editor**. By default, marker lines are shown for the active marker track.

PREREQUISITE

- You have added at least one marker track and one marker to your project.
 - The marker track is visible and not filtered out with the **Visibility** tab.
-

PROCEDURE

1. In the **Key Editor Inspector**, activate the **Global Tracks** section.
2. In the track list of the **Global Tracks** section, activate one or more marker tracks.
3. In the **Project** window track list, right-click a marker track and select an option from the **Show Marker Lines** menu.

You can show marker lines for the active marker track, for all marker tracks, or you can hide them.

RESULT

In the event display for global tracks in the **Key Editor**, marker lines are shown according to your settings.

NOTE

The **Show Marker Lines** options are also available in the **Preferences** dialog (**Event Display—Markers** page).

Marker lines are shown behind other events on other tracks. If you need a more pronounced indication of the lines, consider lowering the **Event Opacity** in the **Preferences** dialog (**Event Display** page).

RELATED LINKS

[Event Display - Markers](#) on page 1365

Markers Window

In the **Markers** window, you can view and edit markers. The markers on the active marker track are displayed in the marker list in the order in which they occur in the project.

To open the **Markers** window, you have the following possibilities:

- Select **Project > Markers**.
- On the **Transport** panel in the marker section, click **Show**.
- Use a key command (by default **Ctrl/Cmd - M**).

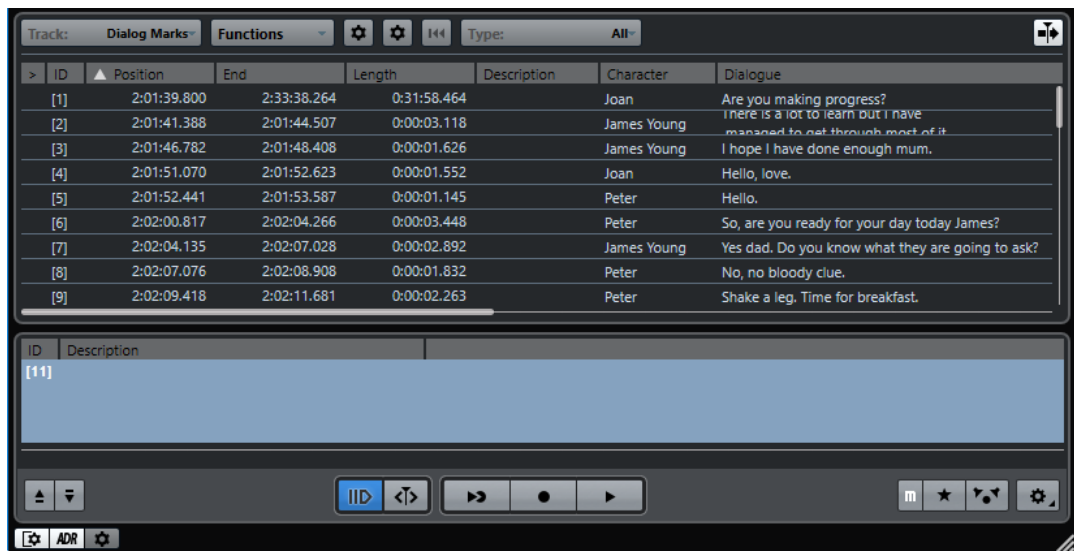

Set focus to marker track

Allows you to select the marker track that has the focus.

Functions menu

Lists all functions available in the **Marker** window.

Set up Attribute Columns

Allows you to set up the attribute columns.

Set up Attribute Columns for Details

Allows you to set up the attribute columns for the details.

Reset Filters

Allows you to remove all filters for all columns.

Filter Markers

Allows you to specify which marker type is shown in the marker list.

Auto-Scroll with Project Cursor

Allows you to keep track of the locate arrow, even if your project contains a large number of markers. If this option is activated, the **Marker** window is automatically scrolled to keep the locate arrow visible.

Markers list

Shows the markers in the order in which they occur in the project.

Details View

Shows the attributes that are set up for the details view.

ADR Panel

Shows the ADR functions.

Show Details View

Shows the details view.

Show ADR Panel

Shows the ADR panel.

Marker Settings

Shows the marker settings.

Editing in the Markers Window

In the **Markers** window, you can select, edit, add, move, and remove markers.

- To select or edit a marker, click on it.
Select multiple markers by **Shift**- or **Ctrl/Cmd**-clicking them.
- To add a position marker at the cursor position, select **Functions > Insert Marker**.
A position marker is added at the current project cursor position on the active marker track.
- To add a cycle marker at the cursor position, select **Functions > Insert Cycle Marker**.
This adds a cycle marker between the left and right locators on the active marker track.
- To move a marker to the cursor position, select the marker and select **Functions > Move Markers to Cursor**.
You can also enter the new position numerically in the **Position** column. If a cycle marker is selected, the move operation affects the cycle marker start position.
- To move markers to another track, select the markers, select **Functions > Move Markers to Track**, and select the marker track.
- To remove a marker, select it and select **Functions > Remove Marker**.

Navigating in the Marker List

You can navigate in the marker list using your computer keyboard and select entries by pressing **Return**. This is a quick and easy way to jump to markers during playback or recording.

- To move to the previous/next marker in the list, press the **Up Arrow** / **Down Arrow** keys.
- To jump to the first/last marker, press the **Page Up** / **Page Down** keys.
- To step through the attributes of a marker, select a marker, then click again and press **Tab**.
- To step back, press **Shift - Tab**.

NOTE

When working with video, you can use the **Markers** window as a spotting list (a list of timecode values) to position your audio events according to the video events.

RELATED LINKS

[Locating to Markers](#) on page 1261

Sorting and Reordering the Marker List

You can customize the display of the marker attributes in the marker list by sorting or reordering the columns.

- To sort the marker list by a specific attribute (except Row Count), click on the corresponding column header.
- To reorder the marker attributes, drag and drop the corresponding column headers.

- To adjust the width of a column, place the mouse pointer between two column headers and drag left or right.

NOTE

No matter by which attribute you sort, the second sort criterion will always be the position attribute.

Marker Settings

You can make general marker settings for your project.

- To open the marker settings, select **Project > Markers**, and click **Marker Settings** .

Cycle follows when locating to Markers

This sets the left and right locators automatically to a position or cycle marker, when locating to this marker. This is useful if you need to set the locators on the fly during recording for Punch In/Punch Out, for example.

Show marker IDs on marker track

If this option is activated, the marker IDs are shown on the marker track.

Sync Selection

If this option is activated, the **Markers** window selection is linked to the selection in the **Project** window.

Marker Attributes

Marker attributes are shown in the marker list of the **Markers** window by default.

- To open the **Markers** window, select **Project > Markers**.

The following attributes are available:

Locate

An arrow indicates which marker is at the project cursor position (or closest to the project cursor). If you click in this column, the project cursor is moved to the corresponding marker position. This column cannot be hidden.

ID

This column shows the marker ID numbers.

Position

In this column, you can view and edit the markers' time positions (or start positions for cycle markers). This column cannot be hidden.

End

In this column, you can view and edit the end positions of cycle markers.

Length

In this column, you can view and edit the length of cycle markers.

Description

Here you can enter names or descriptions for markers.

RELATED LINKS

[Marker IDs](#) on page 377

[Cycle Markers](#) on page 368

[Filtering Attributes](#) on page 375

Setting Up Attribute Columns

If you want to show different attributes in the **Markers** window, you can set up the attribute columns.

- To show other attributes, click **Set up Attribute Columns**, and select other attributes from the pop-up menu.
The most common attributes for postproduction are listed in categories according to their usage.
The number in brackets following the category name helps to get a quick overview of how many attributes of a certain category are displayed as columns in the **Marker** window.
- To show all attributes in the **Marker** window, select **Set up Attribute Columns > Show all**.
- To hide all attributes in the **Marker** window, select **Set up Attribute Columns > Hide all**.
This hides all attributes except for **Locate** and **Position**.
- To show only the columns that are used for at least one marker, select **Set up Attribute Columns > Show only used attributes**.
- To consecutively number the rows in the marker list, select **Set up Attribute Columns > Row Count**.
This can be useful when using filters for certain attributes.

Editing Attributes

There are 3 different types of attributes: Text, Number, and Yes/No switch. Depending on the type, you can enter text or numerical values, or activate/deactivate the corresponding checkbox.

- To edit a marker attribute, select the corresponding marker, click in the desired attribute column, and make your changes.
- To change the attributes of several markers, select the markers and activate the checkbox for the attribute.

All selected markers change their attributes accordingly. Note that this does not work when clicking on a timecode value or a text field.

NOTE

To navigate in the list of marker attributes, you can also use the **Tab** key and the **Up Arrow**, **Down Arrow**, **Left Arrow**, and **Right Arrow** keys.

Sorting and Reordering Columns

You can customize the display of the marker attributes in the marker list by sorting or reordering the columns.

- To sort the marker list by a specific attribute, click on the corresponding column header.

NOTE

No matter by which attribute you sort, the second sort criterion will always be the position attribute.

- To reorder the marker attributes, drag and drop the corresponding column headers.
- To adjust the width of a column, place the mouse pointer between two column headers and drag left or right.

Filtering Attributes

When you are working with many markers so that the list is very long, you may want to filter the list to show only markers with a certain attribute value, such as the name of a character. Filter settings are not saved in the project or defaults.

PROCEDURE

1. Right-click on the column header of the attribute that you want to use for the filter.

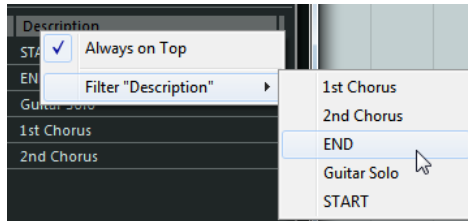

2. From the **Filter <Attribute Title>** submenu, select the desired attribute value.

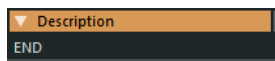

RESULT

The marker list is filtered according to your settings, and the column header changes its color to indicate that a filter is applied.

- To remove the filter, right-click the column header and select **Reset <Attribute Title> Filter**.
 - To remove all filters for all columns, click **Reset Filters**.
- The filters are also reset if you change the displayed marker track or hide a filtered attribute.

Setting Up the Details View

The **Details** view shows the details for the marker that is selected in the marker list. The **Details** view supports line breaks, which is useful for attributes with long texts. If more than one marker is selected, only the details for the first marker of the selection are shown.

PROCEDURE

1. Click **Show Details View**.

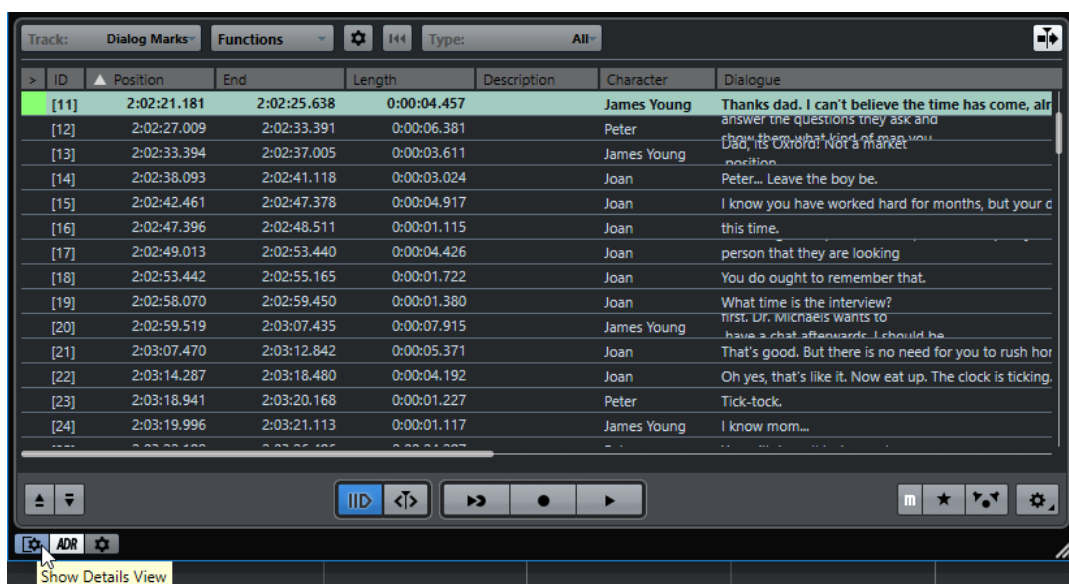

2. Click **Set up Attributes Columns for Details** and select the options from the pop-up menu.

Set up Attribute Columns for Details is displayed next to **Set up Attribute Columns**.

RESULT

The attributes are shown in the details view. You can edit the marker details in the same way as in the marker list.

To hide the details view, click **Show Details View** again.

Setting up User Attributes

You can add and define your own marker attributes.

PROCEDURE

1. Click **Set up Attribute Columns** and select **Define User Attributes**.

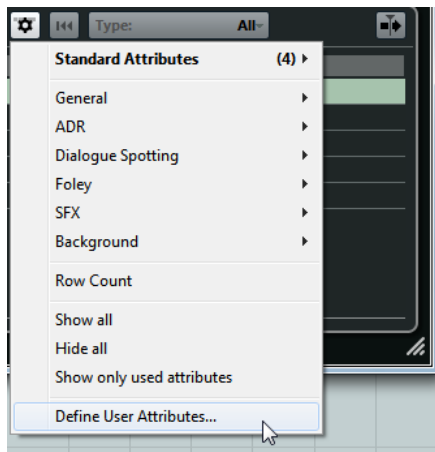

2. In the **User Attributes** dialog, click **Add User Attribute +**.
A new attribute is added to the attributes list.

NOTE

To remove a user attribute, select it and click **Remove User Attribute -**. The attribute is removed from the list and the pop-up menu.

3. Enter a name for the new attribute and define its type.
 4. Optional: Click **Store as Defaults** to save your user attributes as default.
New projects will contain these attributes in the **User Defined** category of the **Set up Attribute Columns** pop-up menu.
 5. Click **OK**.
-

RESULT

The new attribute is added to the list of available attributes and can be displayed in the **Marker** window.

NOTE

To restore your previously saved user attributes, click **Restore Defaults**. This removes any attributes that are not saved as defaults.

Marker IDs

Each time you add a marker, it is automatically and sequentially assigned an ID number, starting from 1.

IDs for cycle markers are shown in brackets and start from **1**. ID numbers can be changed at any time – this allows you to assign specific markers to key commands.

NOTE

If you move a marker from one marker track to another by drag and drop in the **Project** window, and the marker ID is already used on this track, the inserted marker automatically gets a new ID.

Reassigning Marker IDs

Sometimes, especially when setting markers on the fly, you may forget or miss to set a marker. When added later, this marker's ID will not correspond to its position on the marker track. Therefore, it is possible to reassign the IDs for all markers on a track.

PROCEDURE

1. Open the **Markers** window.
2. Select the marker track whose ID numbers you want to reassign.
3. Open the **Functions** pop-up menu and select either **Reassign Position Marker IDs** or **Reassign Cycle Marker IDs**.

RESULT

The marker IDs of the selected type are reassigned to match the order of markers on the marker track.

Marker Track

Marker tracks are used for adding and editing markers.

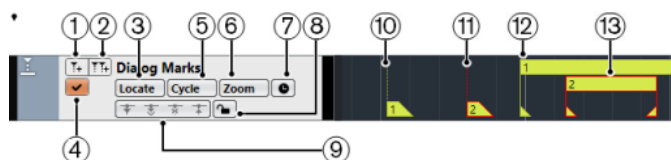

- 1 **Add Marker**
Adds a position marker at the cursor position.
- 2 **Add Cycle Marker**
Adds a cycle marker at the cursor position.
- 3 **Locate pop-up menu**
If you select a position or a cycle marker in this pop-up menu, the corresponding marker in the event display or in the **Markers** window is selected.
- 4 **Activate this track**
Activates the marker track.
- 5 **Cycle pop-up menu**
If you select a cycle marker in this pop-up menu, the left and right locators are set to the corresponding cycle marker.
- 6 **Zoom pop-up menu**

If you select a cycle marker in this pop-up menu, the view zooms to the corresponding cycle marker.

7 Toggle Time Base

Sets the track time base.

8 Lock

Locks the marker track. When a marker track is locked, you cannot edit the track and its markers. However, you can still rename the track or change its status (active/inactive).

9 Network Controls

10 Marker event (inactive)

Shows an inactive marker event.

11 Marker event (active)

Shows an active marker event.

12 Cycle marker event (inactive)

Shows an inactive cycle marker event.

13 Cycle marker event (active)

Shows an active cycle marker event.

Adding, Moving, and Removing the Marker Track

You can add, move, and remove the marker track.

- To add a marker track to the project, select **Project > Add Track > Marker**.
- To move a marker track to another position in the track list, click and drag it up or down.
- To remove one or more marker tracks, right-click them in the track list and select **Remove Selected Tracks**.
- To remove an empty marker track, select **Project > Remove Empty Tracks**. This also removes any other tracks that are empty.

NOTE

When you remove all marker tracks, the marker track that you removed last (including all its markers) is moved to the clipboard. If you later insert a new marker track, this track is pasted from the clipboard into the track list.

Multiple Marker Tracks

You can create up to 32 marker tracks. Multiple marker tracks are useful when working in a postproduction context. For example, they can be used to import Edit Decision Lists (EDLs) or import/export CSV files for Automated Dialogue Replacement (ADR).

A possible scenario would be to create a marker track with cycle markers for sections of the audio, and another marker track with important sync points in the video. You can also use multiple marker tracks to insert markers for different users in a network or different narrators in a movie.

Naming Marker Tracks

By default, the first marker track you create is called "Markers", the second "Marker 01", and so on. If you work with multiple marker tracks, we recommend you to name marker tracks according to their purposes.

You can name marker tracks by double-clicking on the marker track name in the track list or the **Inspector** and entering a new name.

The Active Marker Track

When you are working with multiple marker tracks, only one track is active. All editing functions affect the markers on the active track only. You activate a track by clicking **Activate this track** in the track list.

The following rules apply:

- When you add a new marker track, this track is automatically active.
- When you remove an active track, the topmost marker track in the track list is activated. When using cycle markers for zooming, only the cycle markers of the active track are displayed on the **Zoom** pop-up menu.
- When exporting an audio mixdown of the audio between the cycle markers, only the cycle markers of the active track are displayed in the **Export Audio Mixdown** dialog.
- Most marker key commands affect the active track.

Locking Marker Tracks

You can lock one or more marker tracks by clicking the corresponding lock button of the track. When a marker track is locked, you cannot edit the track and its markers. However, you can still rename the track or change its status (active/inactive). In the **Markers** window and the Project Browser, the unavailable features of a locked track are grayed out.

RELATED LINKS

[Editing Cycle Markers](#) on page 369

[Importing and Exporting Markers](#) on page 381

Working with Multiple Marker Tracks

Let's say you have a video project where the dialogue of two narrators is to be replaced. All you have to do is create different marker tracks for the individual narrators and set up the markers according to the video sections that need to be dubbed.

PREREQUISITE

You have added at least two marker tracks to the project and named them.

PROCEDURE

1. Select **Edit > Key Commands**.
2. In the **Marker** category, set up a key command for **Insert and name Marker**. This command adds a position marker, opens the **Markers** window and activates the **Description** column.
3. Set up key commands for **Activate next Marker Track** and **Activate previous Marker Track**.
4. Activate the marker track for the first narrator, and play back the video file.
5. At the position where the first dialogue section should be replaced, trigger **Insert and name Marker**. The **Marker** window opens with the **Description** column active, so that you can insert a name for the new marker.
6. Enter a name or description for the section, and press **Return** to confirm. A new marker is created on the active track in the **Project** window.
7. Activate the track on which you want to insert the next marker using the **Activate next/previous Marker Track** key command. A message informs you that a different marker track is now active.

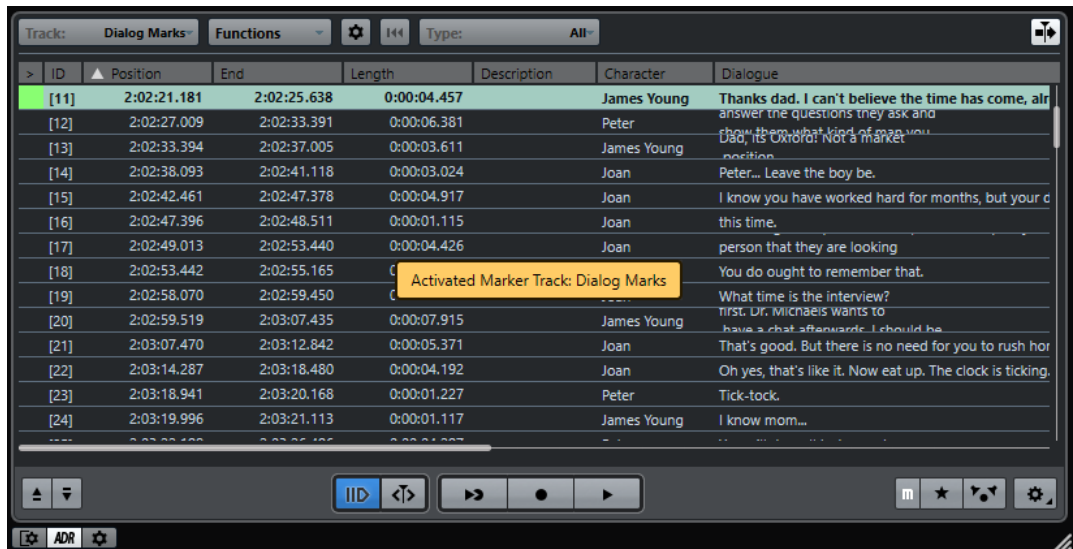

8. Trigger the **Insert and name Marker** key command at the position where the next dialogue section should be replaced.
Repeat this procedure for all markers that you want to insert.

Editing Markers on the Marker Track

You can edit markers on the marker track.

- To add a position marker, click **Add Marker** or use the **Draw** tool.
- To add a cycle marker, click **Add Cycle Marker** or use the **Draw** tool.
- To select a marker, use the standard techniques.
- To resize a cycle marker, select it and drag the handles. You can also do this numerically on the info line.
- To move a marker, select it and drag it. You can also edit marker positions on the info line. If you move markers from one track to another, the marker gets the numbering of the first free marker ID on the track where it is dropped.
- To remove a marker, select it and press **Delete** or use the **Erase** tool.

RELATED LINKS

[Marker IDs](#) on page 377

[Marker Track](#) on page 377

Using Markers to Select Ranges

Markers can be used in conjunction with the **Range Selection** tool to make range selections in the **Project** window. This is useful if you quickly want to make a selection that spans all tracks in the project.

PROCEDURE

1. Set markers at the start and end of the section that you want to move or copy.
2. Select the **Range Selection** tool and double-click on the marker track between the markers. Everything in the project within the marker boundaries is selected. Any functions or processing you perform now affect the selection only.
3. Click on the marker track in the selected range and drag the range to a new position.

If you hold down **Alt/Opt** while you drag the range, the selection in the **Project** window is copied instead.

Importing and Exporting Markers

Markers and marker tracks can be imported and exported.

The following files can contain markers:

- EDL files (edit decision lists)
- CSV files (comma separated values)
- MIDI files
- Track archives

Edit Decision Lists

You can import Edit Decision Lists (EDLs) in CMX3600 format.

EDLs are cut lists or representations of video edits that can be used to align audio events to a reference video file. They contain reel and timecode data that help you to detect the exact position of each video clip. Most EDLs are simple ASCII files created by offline editing systems, but you can also create, open, and edit them manually with a text editor.

The information contained in an EDL can be used in Nuendo to place audio events in the **Project** window at the specific timecode positions that correspond to the edits made in the video editing suite.

EDLs allow you to edit your audio according to the cuts of a video. When you import an EDL in Nuendo together with the cut video file, each cut described in the EDL is indicated by a marker.

NOTE

Every track in the EDL results in a new marker track in Nuendo. 1 video track and up to 4 audio tracks of the EDL can be imported.

RELATED LINKS

[EDL Files](#) on page 1254

Importing an EDL

You can import the data that is contained in a EDL file to marker tracks.

PROCEDURE

1. Optional: Create a new project.
This is not strictly necessary, but helps you keep track of things.
2. Set up the project frame rate according to the frame rate of the EDL that you want to import.
For EDL import, Nuendo supports the frame rates 24 fps, 25 fps, 29.97 fps, 29.97 dfps, 30 fps, and 30 dfps.
3. Select **File > Import > EDL CMX3600**.
4. Select the file that you want to import and click **Open**.
5. In the **Import Options** dialog in the **Import** column, activate the marker tracks that you want to import.

You can also select all tracks by clicking **Select All Tracks**.

6. In the sections **Marker Options - Video** and **Marker Options - Audio**, select whether you want to import position or cycle markers.
 7. Click **OK** to import the EDL file.
If there are EDL edits outside the current project range, you are asked if you want the range to be automatically adjusted.
-

Scene Detection with EDL files

EDL CMX3600 files can also be used for scene detection. Scene detection can be useful if you want to fill specific sections of your project with a certain background atmosphere. To do so, set the locators to the cycle marker and select **Edit > Functions > Fill Loop**. On import, each scene is indicated by a colored cycle marker.

Nuendo supports the following ways of scene naming:

- Number scene naming (25-3-5) where the first number signifies the scene, the second the setting or shooting angle, and the third the take number.

As separators, the following characters can be used:

- comma ,
- semicolon ;
- full stop .
- hyphen -
- underscore _
- slash /
- backslash \

```
002 7350 V C 11:58:48:17 11:58:54:10 10:00:05:04 10:00:10:22
* FROM CLIP NAME: 37401/2/3-K1.NEW.01
```

```
003 7351 V C 11:58:54:10 11:58:55:22 10:00:10:22 10:00:12:09
* FROM CLIP NAME: 37401/2/3-K2.NEW.01
```

- Clip scene naming

```
001 UNTITLED AA/V C 01:02:19:14 01:02:30:20 01:00:00:00 01:00:11:06
* FROM CLIP NAME: C0007.MOV
* COMMENT:
* CLIP FILTER: SHIFT FIELDS
AUD 3 4

002 UNTITLED AA/V C 01:02:30:20 01:02:40:17 01:00:11:06 01:00:21:03
* FROM CLIP NAME: C0008.MOV
* COMMENT:
* CLIP FILTER: SHIFT FIELDS
AUD 3 4
```

Recommendations

When exporting EDLs from your offline editing system, keep the following rules in mind in order to achieve the best import results in Nuendo:

- Export your EDL in CMX3600 format.
Nuendo only supports the CMX3600 format.
- Add clip names as comments to the EDL and use a consistent naming scheme.
These names are used for naming markers and detecting scenes.

NOTE

Make sure that you set the correct export options in your video editing application when creating the EDL.

CSV Files

In Nuendo, you can import CSV (Comma Separated Values) files that were created with an additional program (taker program, etc.) or manually (text editor, Excel, Open Office, etc.). The values in the file should be separated by comma, semicolon, or tab and must contain at least the timecode information. Make sure that the CSV file uses the file extension `.csv`.

On import, the data in the CSV file will be interpreted as markers. For example, these help you to detect the exact timecode position of each audio or video clip. This is extremely useful if you want to create dubbed or synchronized audio versions of your video.

Importing a CSV File

You can import the data that is contained in a CSV file to marker tracks.

PROCEDURE

1. Optional: Create a new project.
This is not strictly necessary, but helps you keep track of things.
2. Set up the project frame rate according to the frame rate of the CSV file that you want to import.
For CSV import, Nuendo supports the frame rates 24 fps, 25 fps, 29.97 fps, 29.97 dfps, 30 fps, and 30 dfps.
3. Select **File > Import > CSV Marker**.
4. Select the file that you want to import and click **Open**.
5. In the **CSV Import - Encoding** dialog, make your changes and click **OK** to apply them.
If you are not sure which encoding method was used, select the **Autodetect** option.

NOTE

The **Preview** section gives you visual feedback of how Nuendo interprets the data contained in the CSV file. If the data is not displayed correctly, try another encoding method.

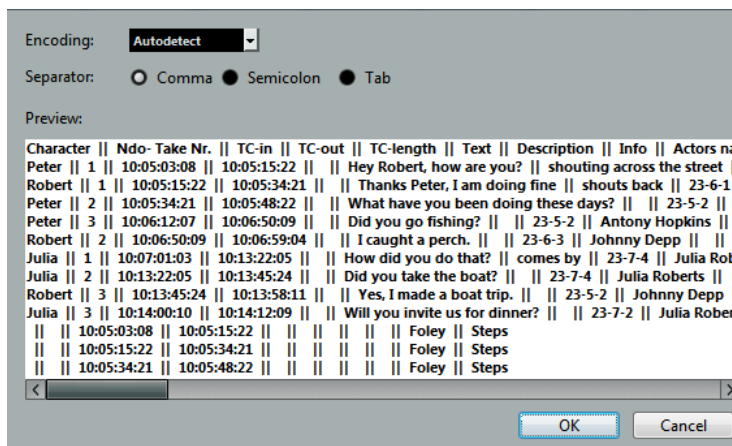

6. In the **CSV Import - Attribute Selection** dialog, make your changes and click **OK** to apply them.

NOTE

At least the attribute for **Timecode** in has to be assigned.

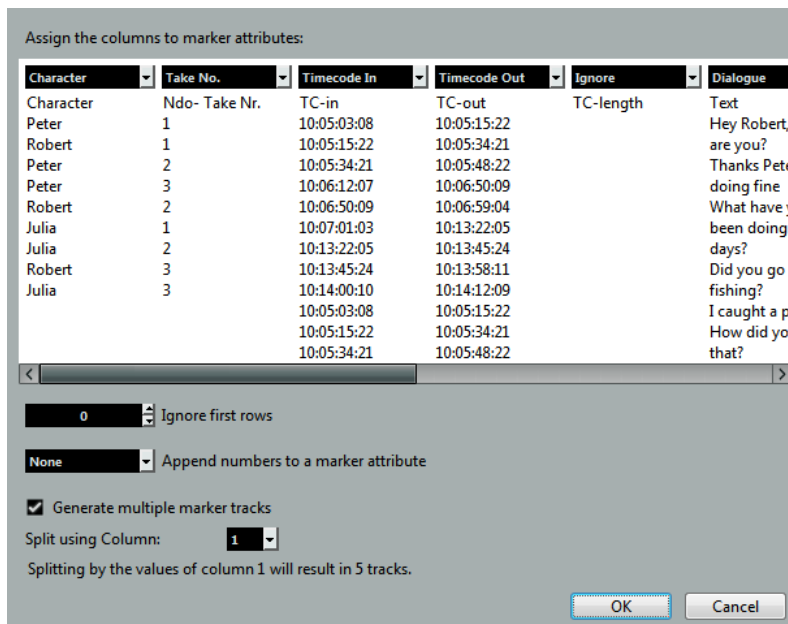

- In the **Import Options** dialog, select the tracks that you want to import by activating the corresponding tracks in the **Import** column to the left, or select all tracks by clicking **Select All Tracks**.
- Click **OK** to import the CSV file and close the dialog.

RESULT

The data contained in the CSV file is imported into marker tracks in Nuendo.

RELATED LINKS

- [CSV Import - Encoding](#) on page 384
- [CSV Import - Attribute Selection](#) on page 385

CSV Import - Encoding

The **Encoding** page of the **CSV Import** dialog allows you to select the encoding method and the separators.

- To open the **Export Options** dialog, select **File > Export > CSV Marker**.

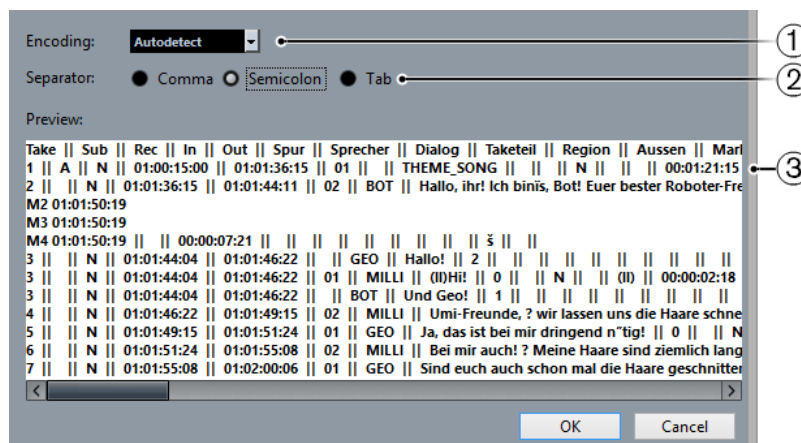

1 Encoding

Allows you to select the encoding method of the file that you want to import. If you are not sure which encoding method was used, select **Autodetect**.

2 Separator

Allows you to select the separator type of the CSV file that you want to import.

3 Preview

Gives you visual feedback of how Nuendo interprets the data contained in the CSV file.

NOTE

If the data is not displayed correctly, try another encoding method.

CSV Import - Attribute Selection

The **Attribute Selection** page of the **CSV Import** dialog allows you to assign marker attributes to the columns.

- To open the **CSV Import - Attribute Selection** dialog, select **File > Import > CSV Marker**, and select a CSV file. In the **CSV Import - Encoding** dialog, make your changes and click **OK**.

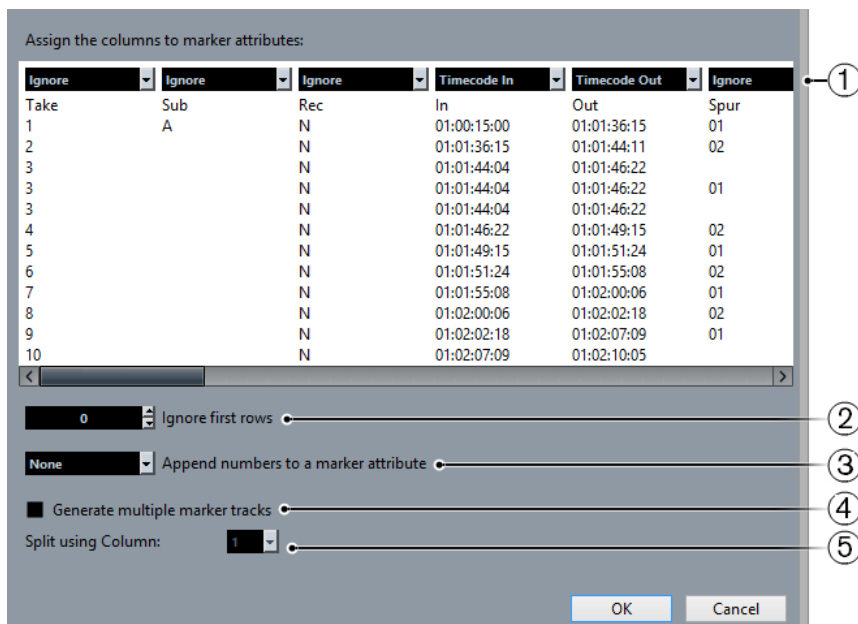

1 Column pop-up menus

These menus allow you to assign marker attributes. You must assign at least **Timecode In**.

2 Ignore first rows

Allows you to specify how many lines you want to exclude from import. Use this if your CSV file contains column headers that you want to exclude from import.

3 Append numbers to a marker attribute

Allows you to add a counter to a marker attribute. This is useful if you later sort the marker list by this attribute in the **Markers** window.

NOTE

Do not use this attribute to split your CSV file.

4 Generate multiple marker tracks

Activate this if you want the markers to be placed on different tracks.

5 Split using Column

Allows you to specify by what column the markers are sorted. This specifies that all lines with the same value in the split column are imported into the same marker track in Nuendo.

Exporting Markers as CSV File

You can export the markers you set up in Nuendo as CSV (Comma Separated Values) files to use them as dispositions. These are useful in recording studios, as they allow you to determine for how long a specific narrator is needed, etc. This makes it easier to calculate time and costs of a synchronization project.

PROCEDURE

1. Set up the markers for your project.
 2. Select **File > Export > CSV Marker**.
 3. In the **Export Options** dialog, activate the marker tracks that you want to export in the **Export** column.
To select all marker tracks, click **Select All**.
 4. On the right of the dialog, make your changes.
 5. Optional: To specify which marker attributes you want to export, click **Select Attributes**, and in the **CSV Export - Attribute Selection** dialog, make your changes.
Click **OK** to confirm your attribute selection and close the **Select Attributes** dialog.
 6. Click **OK** to export your markers as a CSV file.
-

Export Options

The **Export Options** dialog allows you to specify which marker tracks are exported and how the files are encoded.

- To open the **Export Options** dialog, select **File > Export > CSV Marker**.

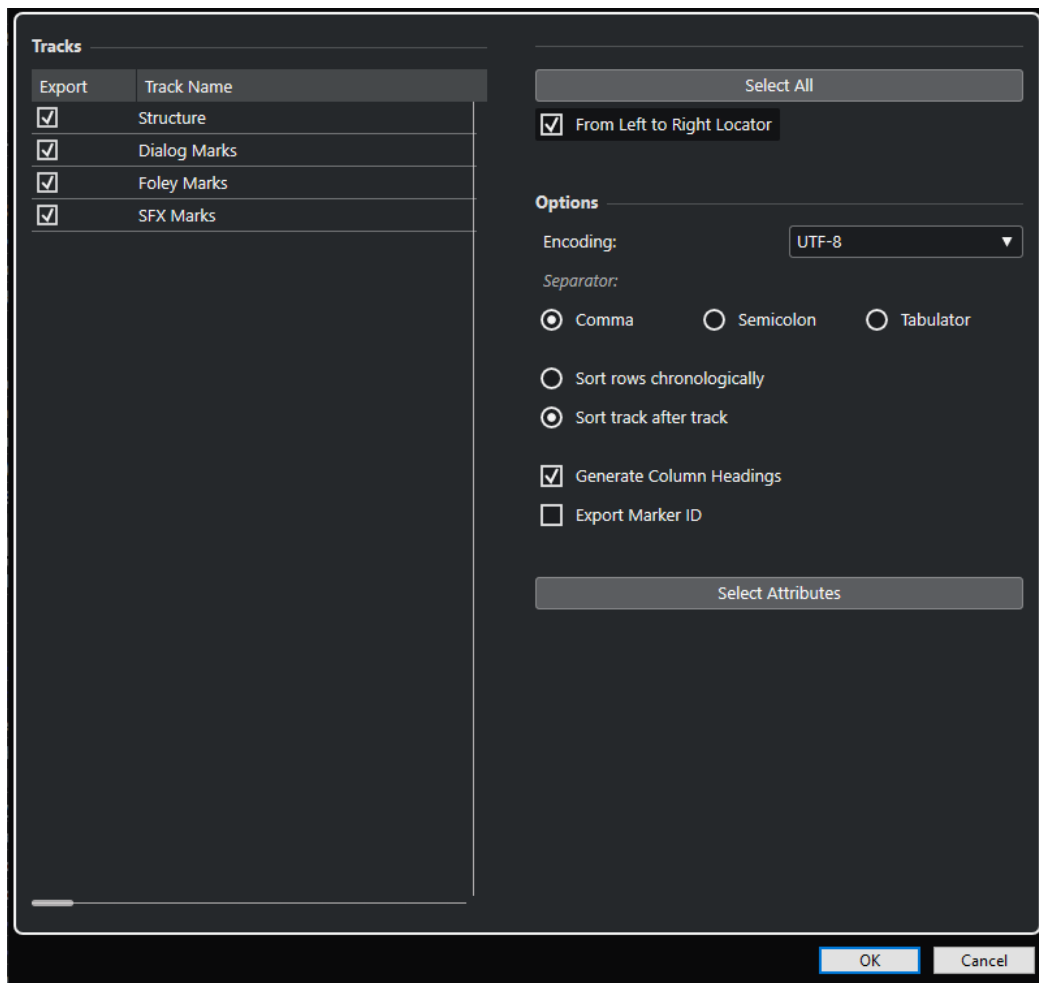

Export column

Allows you to activate the tracks that you want to export.

Select All

Allows you to activate all tracks for export.

Encoding

Allows you to select an encoding format for the CSV file.

Separator

Allows you to specify the kind of separator used in the CSV file.

Sort rows chronologically

Activate this if you want to sort the markers according to their position on the timeline.

Sort track after track

Activate this if you want to sort the markers by their track name.

Generate Column Headings

Activate this if you want to generate column headings.

Export Marker ID

Activate this if you want to export the marker ID.

Select Attributes

Allows you to open the **CSV Export - Attribute Selection** dialog where you can specify which marker attributes you want to export.

Attribute Selection

The **Attribute Selection** section of the **Export Options** dialog allows you to specify which attributes should be exported.

- To open the **Attribute Selection** section of the **Export Options** dialog, select **File > Export > CSV Marker**, and click **Select Attributes**.

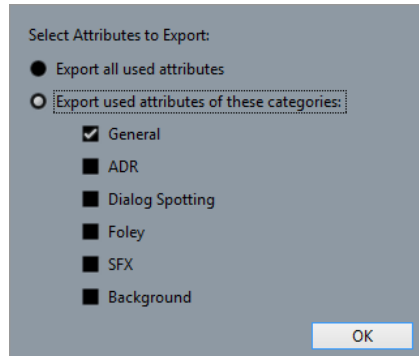

Export all used attributes

Allows you to export all used attributes, that is attributes where at least one marker has a value.

Export used attributes of these categories

Allows you to select specific attribute categories only.

RELATED LINKS

[Marker Attributes](#) on page 373

Importing Markers via MIDI

You can import position markers by importing MIDI files containing markers. This is useful if you want to use your marker tracks in other projects or if you want to share them with other Nuendo users. Any markers you have added are included in the MIDI file as standard MIDI file marker events.

- Activate **Import Markers** in the **Preferences** dialog (**MIDI—MIDI File** page).

The following settings are imported:

- The start position of position markers and cycle markers
- The track assignment of markers
- All marker tracks

NOTE

If you import a standard MIDI file created in other applications, all markers are merged on one marker track.

RELATED LINKS

[Importing MIDI Files](#) on page 320

Exporting Markers via MIDI

You can export your markers as part of a MIDI file.

- To include any markers in the MIDI file, activate **Export Markers** in the **Export Options** dialog.

The following settings are exported:

- The start position of position markers and cycle markers
- The track assignment of markers
- All marker tracks

NOTE

To be able to export markers via MIDI export, your project must contain at least one marker track.

RELATED LINKS

[Exporting MIDI Tracks as Standard MIDI Files](#) on page 177

Importing Markers as Part of a Track Archive

You can import position markers and cycle markers by importing track archives containing marker tracks. Select the tracks that you want to import in the **Import Options** dialog.

The following settings are imported:

- The start and end positions of cycle markers
- The track assignment of markers
- The marker IDs
- The attributes
- All marker tracks

RELATED LINKS

[Importing Tracks from Track Archives](#) on page 173

Exporting Markers as Part of a Track Archive

If you want to use your marker tracks in other projects, for example to share them with other users, you can export them as part of a track archive. To do so, select the marker tracks that you want to export. Then select **File > Export > Selected Tracks**.

The following settings are exported:

- The start and end positions of cycle markers
- The track assignment of markers
- The marker IDs
- The attributes
- All marker tracks

RELATED LINKS

[Track Export](#) on page 176

ADR

The **ADR Panel** allows you to perform ADR (Automated Dialogue Replacement) and language dubbing tasks.

Sometimes, it is necessary to re-record dialogue from production tracks or dub them in a different language. When you do this, the original takes are played back to allow the dubbing actor to listen to the original production track as a guide. The actor can then rehearse the dialogue and re-record it. These tasks can be performed with the ADR functions that are located in the **ADR Panel**.

- To open the **ADR Panel**, select **Project > ADR Panel**.

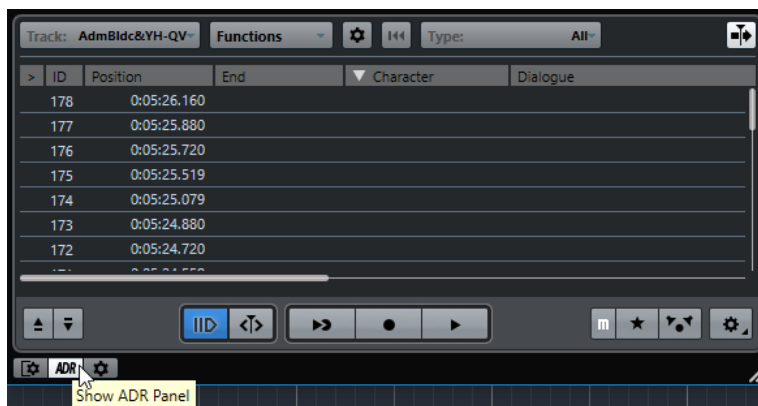

To get the most out of the ADR functions, it is important that you understand the following concepts:

- ADR and selecting markers
- ADR statuses
- ADR modes

ADR and Marker Selection

The ADR functionality makes extensive use of markers.

In the marker list, you can select cycle markers to set the start and end position for **Rehearse**, **Record**, and **Review**.

If you select position markers, only the start position is set.

If no marker is selected and **Free Run** is deactivated, the start position for any ADR status is determined by the left locator. If **Free Run** is activated, the start position is determined by the project cursor position.

NOTE

You can also select multiple markers, for example, to combine multiple takes.

RELATED LINKS

[ADR Statuses](#) on page 391

[ADR Modes](#) on page 391

ADR Statuses

The ADR statuses are transport functions that were designed specifically for ADR tasks.

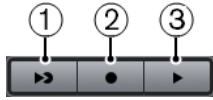

The following statuses are available:

- 1 Rehearse**
Allows you to play back the take, so that the artist can rehearse it.
- 2 Record**
Allows you to record the take on the record-enabled track.
- 3 Review**
Allows you to play back the recorded take for review.

NOTE

The ADR statuses take into account all settings in the **ADR Setup** window.

RELATED LINKS

[ADR Setup](#) on page 393

ADR Modes

You can activate or deactivate **Free Run** mode.

NOTE

The ADR modes take into account all settings in the **ADR Setup** window.

Free Run Off (Automatic)

This mode allows you to record a take according to the position and length of the selected marker. In the different ADR statuses, the following happens:

- If you click **Rehearse**, a locator range according to the position and length of the selected markers is selected in the **Project** window ruler. The project cursor jumps to the start of the **Pre-roll** phase and playback starts. At the end, the project cursor automatically jumps back to the start position.
- If you click **Record**, the project cursor jumps to the start of the **Pre-roll** phase and playback starts. When the left locator is reached, recording starts. At the end of the **Post-roll** phase, recording stops automatically and the project cursor jumps back to the left locator. The recorded event is automatically resized to this position.
- If you click **Review**, the project cursor jumps to the start of the **Pre-roll** phase and playback starts. At the end of the **Post-roll** phase, playback stops automatically and the project cursor jumps back to the take start position.

Free Run On



Activate **Free Run** for more flexibility. It allows you to use the project cursor position as the ADR start position. You can set the project cursor position manually or using a marker in the marker list. **Free Run** works as follows:

- If you click **Rehearse**, the left locator is set to the project cursor position and playback starts from there. If **Pre** is enabled, playback starts with the pre-roll that you defined in the **ADR Setup** window. Playback stops when you click **Stop**.
- If you click **Record**, the project cursor jumps to the take start position and recording starts. If **Pre** is enabled, playback starts at the beginning of the pre-roll phase and recording starts when the take start position is reached. Recording stops when you click **Stop**.
- If you click **Review**, the project cursor jumps to the take start position and playback starts. If **Pre** is enabled, playback starts at the beginning of the pre-roll phase. Playback stops when you click **Stop**.

NOTE

If **Return to Start Position on Stop** is activated in the **Preferences** dialog (**Transport** page), the project cursor returns to the take start position.

ADR Panel

The **ADR Panel** is located in the lower part of the **Markers** window.

- To open the **ADR Panel**, select **Project > ADR Panel**.

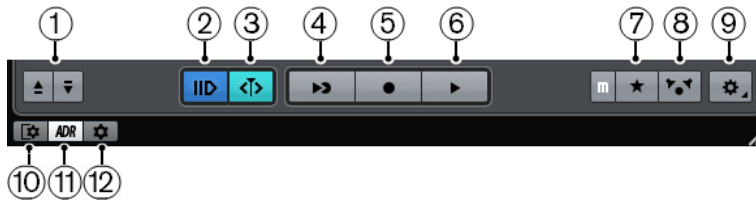

1 Locate Previous/Next Marker in Markers Window

Allows you to select the previous/next marker in the marker list. If **Cycle follows when locating to Markers** is activated in the **Marker Settings**, the corresponding locator range is also selected in the **Project** window ruler.

2 Pre-Roll On/Off

Allows you to activate/deactivate a pre-roll for the **Free Run Mode**.

3 Free Run Mode On/Off

Activate this mode to start from the project cursor position. On stop, the cursor returns to the start position by default. You can change this by deactivating **Return to Start Position on Stop** in the **Preferences** dialog (**Transport** page).

Deactivate this mode to use the selected cycle marker. Pre-roll and post-roll are determined by the settings on the **General** tab in the **ADR Setup** window.

4 Rehearse

Plays back the selected take so that the artist can rehearse it.

5 Record

Records the selected take on the record-enabled track.

6 Review

Plays back the take for review. To enable this, on the **Signal Switchboard** tab, activate **Take** in **Review** mode for **Other Audio** for the **Control Room** and **Cue 1**.

7 Guide Track for Cue 1 On/Off

Allows you to mute the guide track for cue 1.

8 Guide Track for Control Room On/Off

Allows you to mute the guide track for the **Control Room**.

9 Setup

Allows you to open the **ADR Setup** window.

10 Show Details View

Allows you to show/hide the details view.

11 Show ADR Panel

Allows you to show/hide the **ADR Panel**.

12 Marker Settings

Allows you to show the marker settings.

RELATED LINKS

[ADR Modes](#) on page 391

[ADR Setup - Signal Switchboard](#) on page 395

[ADR Setup](#) on page 393

ADR Setup

The **ADR Setup** dialog allows you to set up your ADR project.

- To open the **ADR Setup** dialog, select **Project > ADR Panel**, and click **Setup** .

The following tabs are available:

- General
- Video
- Signal Switchboard

ADR Setup - General

The **General** tab allows you to define the ADR track assignment.

- To open the **General** tab, select **Project > ADR Panel**, click **Setup** , and click the **General** tab.

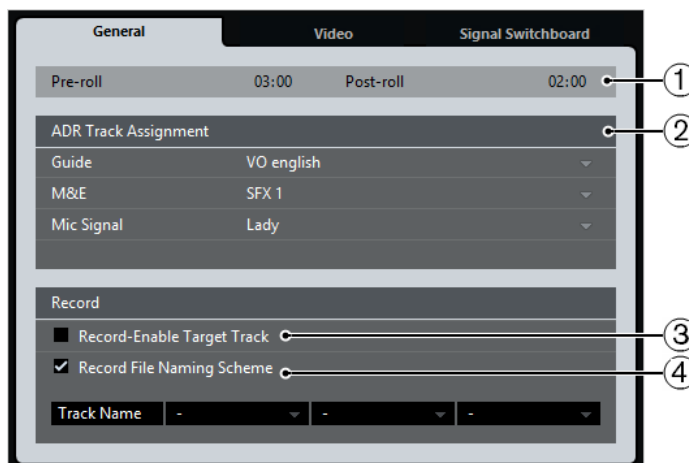

1 Pre-roll/Post-roll

Allows you to enter a **Pre-roll/Post-roll** value.

NOTE

You can set a value for **Audio Pre-Record Seconds** in the **Preferences** dialog (**Record—Audio** page). The post-record time corresponds to the post-roll time.

2 ADR Track Assignment

Allows you to specify which tracks you want to use as guide, M&E, and mic signal.

3 Record-Enable Target Track

Allows you to automatically record-enable the target track. To enable this, you must set up the **Target Track** marker attribute.

4 Record File Naming Scheme

Allows you to specify a naming scheme for the recorded files that is added to the track name as a suffix.

ADR Setup - Video

The **Video** tab allows you to define the video overlays.

- To open the **Video** tab, select **Project > ADR Panel**, click **Setup** , and click the **Video** tab.

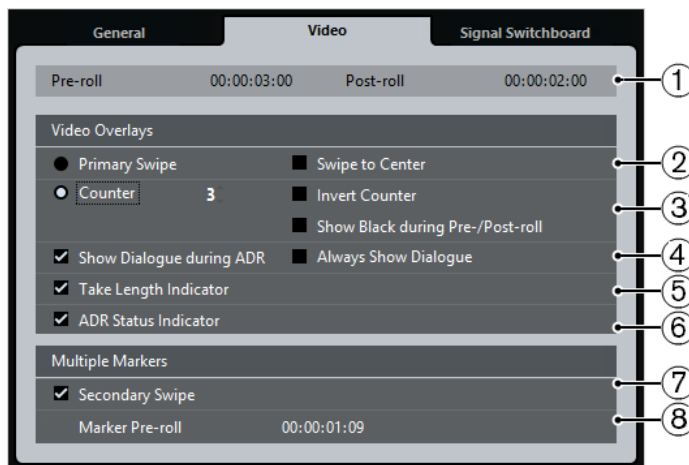

1 Pre-roll/Post-roll

Allows you to enter a **Pre-roll/Post-roll** value.

NOTE

You can set a value for **Audio Pre-Record Seconds** in the **Preferences** dialog (**Record—Audio** page). The post-record time corresponds to the post-roll time.

2 Primary Swipe

Activate this to display a bar that swipes from the left to the right side of the **Video Player** window as a take start indicator. The **Pre-roll** value defines the duration of the swipe.

Activate **Swipe to Center** to display two bars that swipe from the left and right sides to the center of the **Video Player** window.

3 Counter

Activate this to display a count-in by numbers as a take start indicator in the **Video Player** window. Specify a start number in the value field to the right. The interval between each count is one second. The metronome is automatically synchronized with the counter.

Activate **Invert Counter** to invert the order of the displayed numbers.

Activate **Show Black during Pre-/Post-roll** to show a black picture during pre-roll and post-roll.

4 Show Dialogue during ADR/Always Show Dialogue

These options allow you to show the dialogue attribute of the selected marker.

Activate **Show Dialogue during ADR** to display the **Dialogue** marker attribute as a video overlay in the **Video Player** window during one of the ADR modes.

Activate **Always Show Dialogue** to always display the dialogue marker attribute.

5 Take Length Indicator

Activate this to show a take length indicator at the bottom of the **Video Player** window.

6 ADR Status Indicator

Rehearse status is indicated with a yellow indicator, record status with a red indicator, and review with a green indicator.

Activate this to show an ADR status indicator at the top left corner of the **Video Player** window.

7 Secondary Swipe

If you selected multiple markers, activating this option displays a swipe as a pre-roll for every take.

8 Marker Pre-roll

Allows you to define a pre-roll for the secondary swipes.

ADR Setup - Signal Switchboard

The **Signal Switchboard** tab allows you to define which signals are heard during the different ADR phases. This helps you to set up different schemes for the dubbing artist and the ADR operator, for example.

- To open the **Signal Switchboard** tab, select **Project > ADR Panel**, click **Setup** , and click the **Signal Switchboard** tab.

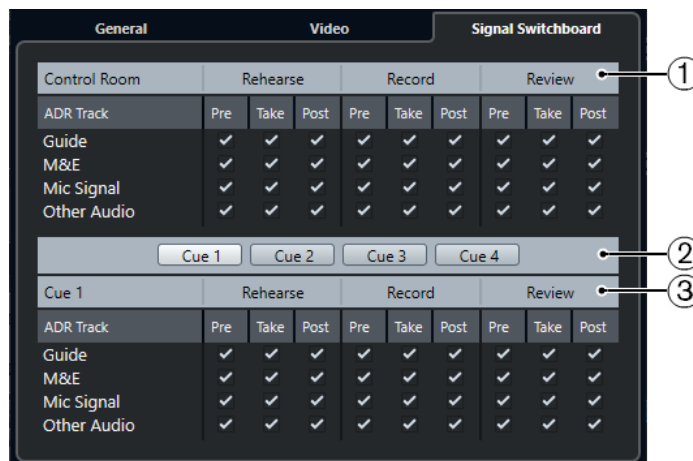

1 Control Room section

Allows you to specify the track that you hear in the **Control Room** channel during rehearse, record, and review. Furthermore, you can determine if you want to hear the signal during the pre-roll, take, and post-roll phases.

2 Cue selectors

Allow you to switch to another **Cue** channel.

3 Cue section

Allows you to specify the track that you hear in the selected **Cue** channel during rehearse, record, and review. Furthermore, you can determine if you hear the signal during the pre-roll, take, and post-roll phases.

NOTE

In the **MixConsole**, make sure that the **Control Room** and **Cue** channels are set up correctly.

Setting Up ADR Tracks

To use the available functions in the **ADR Panel**, you must set up your project first.

Creating a Guide Track

The guide track is to play back the original dialogue that you want to replace.

PROCEDURE

1. Create an audio track or a group and name it so that you can recognize it as the guide track.
 2. Set the **Output Routing** pop-up menu to the stereo output bus that is set as the **Main Mix**.
-

Creating an M&E (Music and Effects) Track

The **M&E** track is designed to play back music and effects.

PROCEDURE

1. Create an audio track or group and name it so that you can recognize it as the **M&E** track.
 2. Set the **Output Routing** pop-up menu to the stereo output bus that is set as the **Main Mix**.
-

Creating a Mic Signal Track

The **Mic Signal** track is designed to lead the signal that is to be recorded. For this to work, you must activate **Monitor**.

PROCEDURE

1. Create an audio track for the **Mic Signal**.
2. In the **Inspector**, set the **Input Routing** pop-up menu to your microphone input bus.
3. Set the **Output Routing** pop-up menu to the output bus that is set as the **Main Mix**.
4. Activate **Monitor** for the mic signal track.

NOTE

If you use a mic signal track, set the **Auto Monitoring** mode to **Manual** in the **Preferences** dialog (**VST** page). Otherwise, select **Tapemachine Style**.

Creating Other Tracks

The other tracks are designed for recording and for playback of your recordings.

PROCEDURE

1. Create as many other audio tracks as you need.
 2. In the **Inspector** of each track, set the **Input Routing** pop-up menu to your microphone bus.
 3. Set the **Output Routing** pop-up menu to the output bus that is set as the **Main Mix**.
-

Creating Cue Channels

Cue channels are used for sending cue mixes, also known as headphone mixes, to performers in the studio during recording.

PROCEDURE

1. Select **Studio > Audio Connections > Control Room**.
 2. Activate **Enable/Disable Control Room**.
 3. Click **Add Channel** and add at least one **Cue** channel.
-

Setting Up the ADR Environment

Setting up your ADR environment includes importing files and defining takes, assigning ADR tracks, setting up the routing, configuring video overlays, and enabling automatic record for target tracks.

Importing Files and Defining Takes

Import your files and define the takes that you want to record by creating cycle markers.

PROCEDURE

1. Select **File > Import > Video File** and navigate to the video file that you want to import.
2. Select the guide track, select **File > Import > Audio File**, and import the audio file for the dialogue that you want to replace.
3. Select the M&E track, select **File > Import > Audio File**, and import the music and effect sounds.
4. Play back the guide track and set up cycle markers for all dialogue that you want to re-record.

NOTE

If you have a take list from a dedicated ADR taker application or an Excel sheet, you can also import this.

Assigning ADR Tracks

You must define which of your tracks or groups correspond to a specific ADR track. This is useful for setting up the signal switchboard. The track assignment is stored with the project.

PROCEDURE

1. Select **Project > ADR Panel**.
 2. Click **Setup** .
 - The **ADR Setup** window opens.
 3. Click **General**.
 4. In the **ADR Track Assignment** section, use the **Guide**, **M&E**, and **Mic Signal** pop-up menus to select the tracks that you want to use as guide, M&E, and mic signal tracks.
-

Setting Up the Routing for Individual Mixes

You can define which signals are heard during the different ADR phases and set up different schemes for the dubbing artist and the ADR operator, for example. The routing that you set up is automatically applied when you use the ADR modes. The settings are saved globally.

PROCEDURE

1. On the **ADR Panel**, click **Setup**.
2. In the **ADR Setup** window, click **Signal Switchboard**.
The signal switchboard shows all ADR tracks (sources) for the **Control Room** (destination) in the upper section and the cues 1 to 4 (destinations) in the lower section.
3. Activate the checkboxes for the signals that you want to hear on each ADR track.
To hear the source signal of a specific ADR track during pre-roll, activate the **Pre** option for that track. To hear the signal during the take, activate **Take**. To hear the signal during post-roll, activate **Post**.

NOTE

In the **MixConsole**, make sure that the **Control Room** and **Cue** channels are set up correctly.

RELATED LINKS

[ADR Setup - Signal Switchboard](#) on page 395

Configuring Video Overlays

You can set up different video overlays that may be helpful for the dubbing artist.

PROCEDURE

1. On the **ADR Panel**, click **Setup**.
2. Select the **General** tab and enter values for **Pre-roll** and **Post-roll**.

NOTE

You can set a value for **Audio Pre-Record Seconds** in the **Preferences** dialog (**Record—Audio** page). The post-record time corresponds to the post-roll time.

3. Select the **Video** tab.
4. In the **Video Overlays** section, configure which overlays are displayed in the **Video Player** window.
 - To enable the timecode display as an overlay in the **Video Player** window, in the **Studio Setup** dialog (**Video Player** page), activate **Show Timecode**.
 - To adjust the display position, use the **Position** pop-up menu.

RELATED LINKS

[ADR Setup - General](#) on page 393

Enabling Dialogue Display in the Video Player

You can display the dialogue that must be replaced or dubbed in the **Video Player** window or on a dedicated video output device.

PREREQUISITE

The **Dialogue** attribute is assigned manually or has been imported via a CSV file.

PROCEDURE

1. In the **Markers** window, click **Set up Attribute Columns**, and activate **ADR > Dialogue**.
The **Dialogue** column is displayed in the **Markers** window.
 2. On the **ADR Panel**, click **Setup**.
 3. In the **ADR Setup** window, click **Video**.
 4. In the **Video Overlays** section, activate **Show Dialogue during ADR**.
-

RESULT

The dialogue of the selected marker is shown in the **Video Player** window during rehearse, record, and review.

NOTE

You can activate **Always Show Dialogue** if you want to see the dialogue always, not only during ADR.

Enabling Automatic Record-Enabling for Target Tracks

You can automatically record-enable a track when clicking **Rehearse**, **Record**, or **Review**.

PROCEDURE

1. In the **Markers** window, click **Set up Attribute Columns**, and activate **General > Target Track**.
The **Target Track** column is displayed in the **Markers** window.
 2. On the **ADR Panel**, click **Setup**.
 3. In the **ADR Setup** window, click **General**.
 4. In the **Recording** section, activate **Record-Enable Target Track**.
-

RESULT

You can now use the **Target Track** column of the **Markers** window to type in the number of the track. If you have imported this attribute with the take list, it is shown automatically.

NOTE

Only numbers are allowed as values for the target track attribute.

Rehearsing Takes

Before you start the actual recording, you can activate **Rehearse** so that the dubbing artist can rehearse the take first.

PREREQUISITE

Define takes by creating cycle markers and set up the **Signal Switchboard** as required.

PROCEDURE

1. In the markers list, select the marker for the take that you want to record.
 2. On the **ADR Panel**, click **Rehearse**.
-

Switching from Rehearse to Record

You can switch from **Rehearse** to **Record** without stopping playback. This is useful if you realize during rehearsing that you want to record straight away.

PREREQUISITE

You are rehearsing a take.

PROCEDURE

- On the **ADR Panel**, click **Record**.
 - If you click **Record** during the pre-roll phase, playback continues and recording starts only at the take start position.
 - If you click **Record** during the take phase, recording starts directly at the cursor position.
-

Recording Takes

PREREQUISITE

The dubbing artist has rehearsed the take and is ready to record. You have record-enabled the track on which you want to record.

NOTE

To combine track selection and record-enabling, activate **Enable Record on Selected Audio Track** in the **Preferences** dialog (**Editing—Project & MixConsole** page).

PROCEDURE

- On the **ADR Panel**, click **Record**.
-

RESULT

The take is recorded.

Reviewing Takes

You can play back a recorded take so that the director and the artist can review it.

PROCEDURE

- On the **ADR Panel**, click **Review**.
-

RESULT

The take is played back so that the director and the artist can review it.

NOTE

If you cannot hear the recorded take, open the **Signal Switchboard** tab and make sure that **Take** is activated in **Review** mode for **Other Audio** for the **Control Room** and **Cue 1**.

AFTER COMPLETING THIS TASK

If you are satisfied with the recording, proceed with the next take.

NOTE

You can select the next marker in the marker list by clicking **Locate Next Marker in Markers Window** on the **ADR Panel**. If **Sync Selection** is activated in the **Marker Settings**, the corresponding take is also selected in the **Project** window. Make sure that **Track Selection Follows Event Selection** is deactivated in the **Preferences** dialog (**Editing** page).

MixConsole

The **MixConsole** provides a common environment for producing mixes in stereo or surround. It allows you to control level, pan, solo/mute status, etc. for audio and MIDI channels. Furthermore, you can set up the input and output routing for multiple tracks or channels at the same time. You can undo/redo **MixConsole** parameter changes for an open project at any time.

You can open the **MixConsole** in a separate window or in the lower zone of the **Project** window.

While the **MixConsole** in the lower zone of the **Project** window features the key functions for mixing, the separate **MixConsole** window gives you access to additional functions and settings.

RELATED LINKS

[MixConsole in Lower Zone](#) on page 402

[MixConsole Window](#) on page 405

MixConsole in Lower Zone

You can show a **MixConsole** in the lower zone of the **Project** window. This is useful if you want to access the most important **MixConsole** functions from within a fixed zone of the **Project** window. The **MixConsole** in the lower zone of the **Project** window is a separate **MixConsole** that does not follow any visibility changes you perform in the **MixConsole** window.

To open a **MixConsole** in the lower zone of the **Project** window, do one of the following:

- Press **Alt/Opt - F3**.
- Select **Studio > MixConsole in Project Window**.

The **MixConsole** in the lower zone of the **Project** window is divided into the following sections:

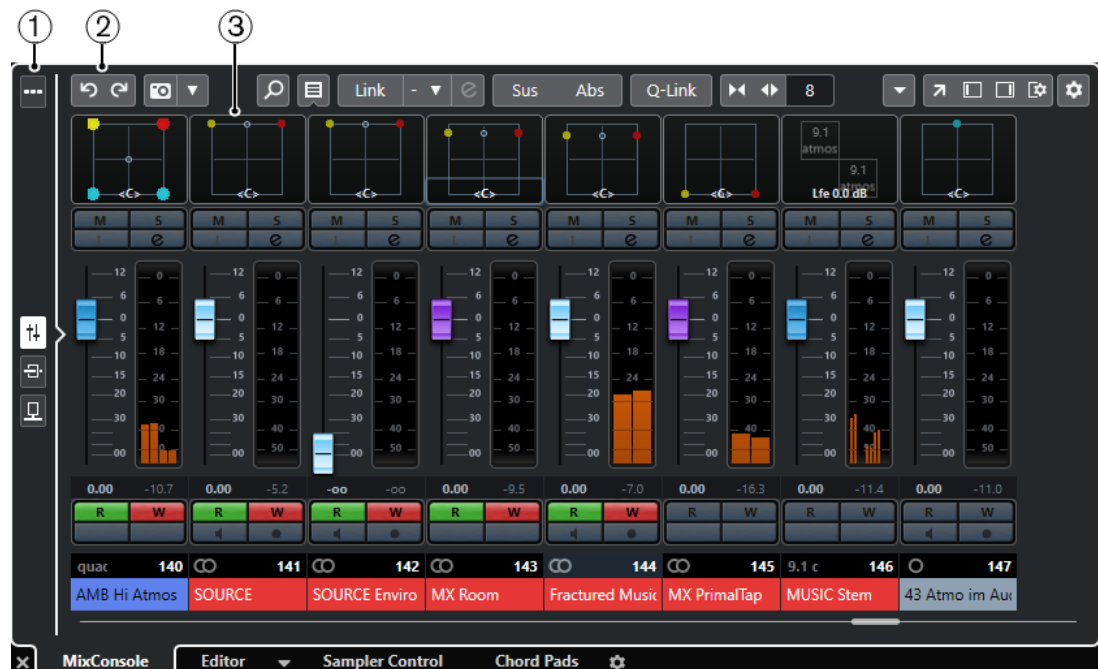

1 Page selector

Allows you to select what page is displayed in the fader section: the channel faders, the insert effects for a channel, or the send effects. The top button allows you to show/hide the toolbar.

2 Toolbar

The toolbar shows tools and shortcuts for settings and functions in the **MixConsole**.

3 Fader section

The fader section is always visible and shows all channels in the same order as in the track list.

RELATED LINKS

[Fader Section](#) on page 429

[Inserts](#) on page 440

[Sends](#) on page 452

[Filtering Channel Types](#) on page 420

[Undoing/Redoing MixConsole Parameter Changes](#) on page 416

[Linking Channels](#) on page 424

[Functions Menu](#) on page 427

Showing/Hiding MixConsole Channels in the Lower Zone

To determine what channels are visible in the **MixConsole** in the lower zone of the **Project** window, you must use the **Visibility** tab in the left zone of the **Project** window.

PROCEDURE

1. Click **Show/Hide Left Zone** on the **Project** window toolbar to activate the **Left Zone**.
2. At the top of the left zone, click the **Visibility** tab.
3. At the bottom of the left zone, click the **Track** tab.

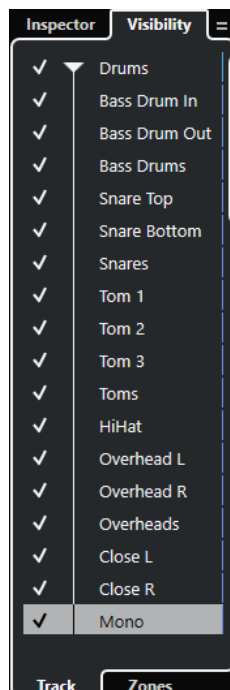

4. Click to the left of a track name to activate/deactivate the visibility for a channel.
-

RESULT

The track in the track list and the corresponding **MixConsole** channel are shown/hidden in the lower zone of the **Project** window.

RELATED LINKS

[Opening the Visibility](#) on page 69

[Showing/Hiding Individual Tracks](#) on page 70

[Visibility](#) on page 68

Determining the MixConsole Channel Order in the Lower Zone

You can determine and lock the position of **MixConsole** channels in the lower zone of the **Project** window.

PROCEDURE

1. At the top of the left zone, click the **Visibility** tab.
2. At the bottom of the left zone, click the **Zones** tab.

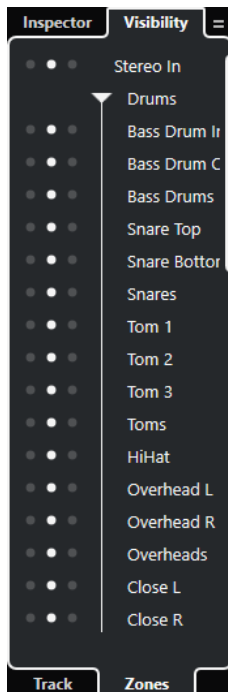

3. Do one of the following:
 - To lock a channel on the left of the fader section, click the left dot next to the channel name.
 - To lock a channel on the right of the fader section, click the right dot next to the channel name.
-

RESULT

The channel is locked. Locked channels are always displayed.

RELATED LINKS

[Opening the Zones](#) on page 71

MixConsole Window

You can open the **MixConsole** in a separate window.

To open the **MixConsole**, do one of the following:

- Press **F3**.
- Select **Studio > MixConsole**.
- On the **Project** window toolbar, click **Open MixConsole**.

NOTE

This is only visible on the toolbar if the **Media & MixConsole Windows** section is activated.



The **MixConsole** is divided into the following sections:

1 Toolbar

The toolbar shows tools and shortcuts for settings and functions in the **MixConsole**.

2 Left Zone

The left zone features the following tabs:

- The **Visibility** tab with the following tabs:
 - The **Channel** tab allows you to show/hide individual channels from the **MixConsole**.
 - The **Zones** tab allows you to determine and lock the position of certain **MixConsole** channels.
- The **History** tab lists all **MixConsole** parameter changes, and allows you to undo/redo specific changes.
- The **Snapshots** tab lists all snapshots of **MixConsole** settings, and allows you to recall them later.

3 Fader section

The fader section is always visible and shows all channels in the same order as in the track list.

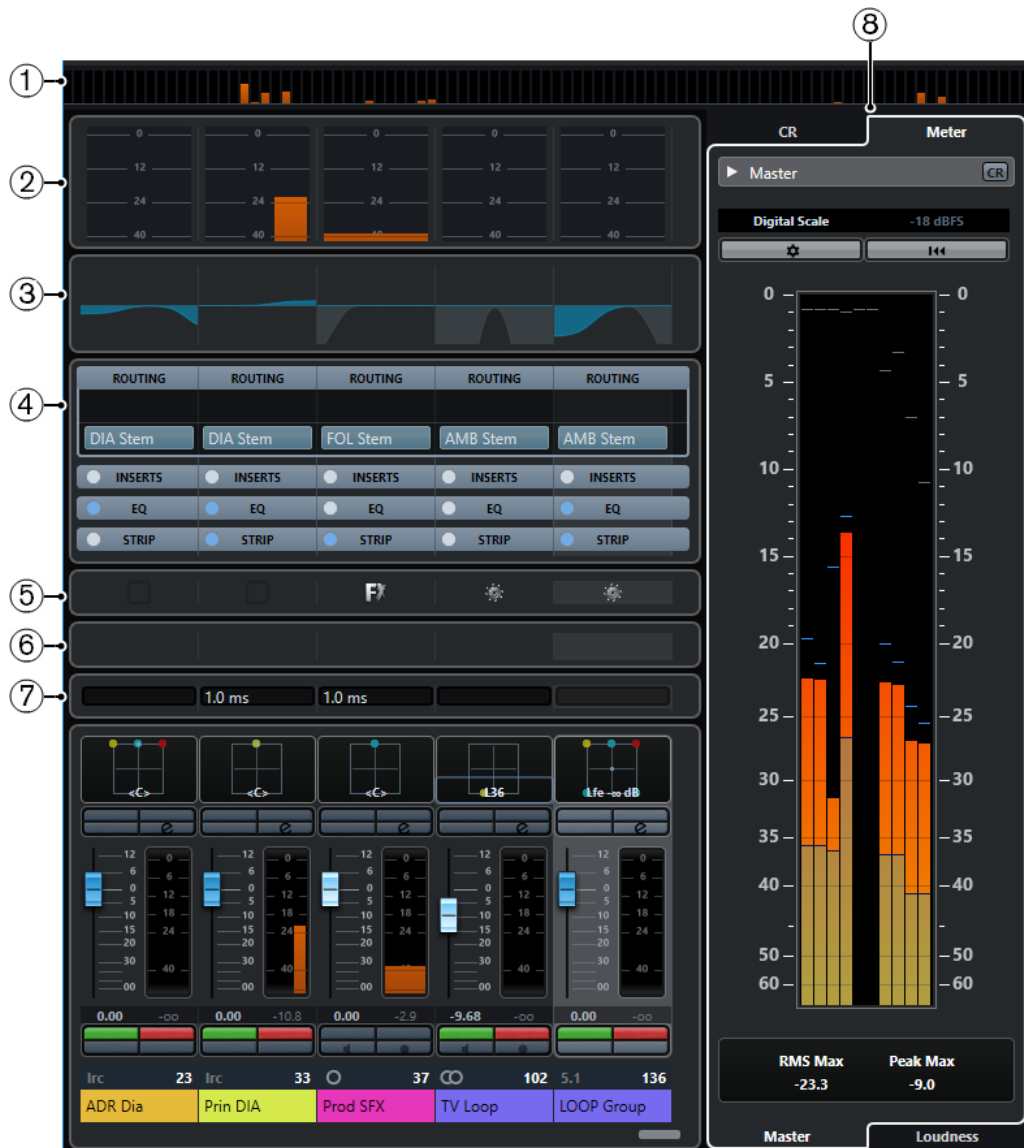

Apart from the main sections, you can also access the following sections from within the **MixConsole** window:

1 Channel overview

Displays all channels as boxes. If you have more channels than can be displayed in the window, you can use the channel overview to navigate to other channels and select them.

2 Meter bridge

Allows you to monitor the levels of your channels.

To select a meter type, open the meter bridge context menu and select either **PPM** or **Wave**.

3 Equalizer curves

Allows you to draw an EQ curve. Click in the curve display to open a larger view where you can edit the curve points.

4 Channel racks

Allows you to show additional channel controls as needed.

5 Pictures

Allows you to add a picture to the selected channel. Pictures can help you identify your **MixConsole** channels quickly.

6 Notepads

Allows you to enter notes and comments about a channel. Each channel has its own notepad.

7 Channel Latencies

Allows you to show the latencies caused by insert effects or channel strip modules.

8 Control Room/Meter (Right Zone)

Allows you to divide the studio environment into the performing area (studio) and the engineer/producer area (control room).

RELATED LINKS

[MixConsole Left Zone](#) on page 407

[MixConsole Toolbar](#) on page 410

[Project Window Toolbar](#) on page 48

[Fader Section](#) on page 429

[Channel Racks Selector](#) on page 422

[Track Pictures Browser](#) on page 183

[Adding Notes to a MixConsole Channel](#) on page 457

[Channel Latency Overview](#) on page 458

[Control Room](#) on page 479

[Master Meter](#) on page 493

[Loudness Meter](#) on page 495

[Channel Strips](#) on page 445

MixConsole Left Zone

The left zone of the **MixConsole** shows several tabs that allow you to change the visibility and the position of specific channels, to undo parameter changes, or to save **MixConsole** snapshots.

- To show/hide the left zone of the **MixConsole**, click **Show/Hide Left Zone** in the **MixConsole** window toolbar.

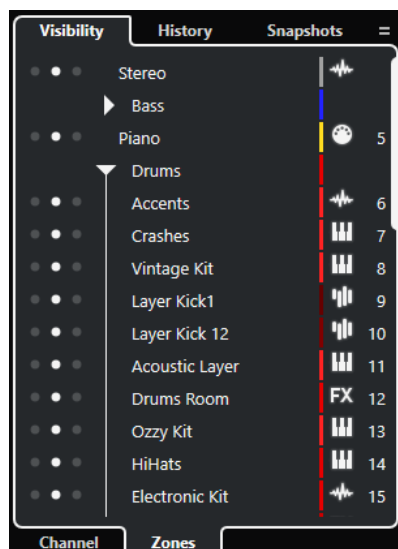

The following tabs are available at the top of the left zone:

Visibility

Lists all channels contained in your project, and allows you to show/hide specific channels.

History

Lists all **MixConsole** parameter changes, and allows you to undo/redo specific changes.

Snapshots

Lists all **MixConsole** snapshots that you saved, and allows you to recall snapshots.

The following tabs are available at the bottom of the left zone:

Channel

Lists all channels contained in your project.

Zones

Allows you to lock the position of specific channels.

RELATED LINKS

[Undoing/Redoing MixConsole Parameter Changes](#) on page 416

[MixConsole Toolbar](#) on page 410

MixConsole Visibility

The **Visibility** tab in the **MixConsole** lists all channels contained in your project, and allows you to show/hide specific channels.

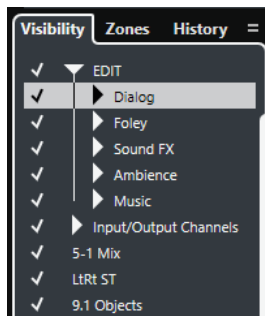

- To show/hide channels, check/uncheck them by clicking to the left of the channel name.
- To collapse/expand groups and folders, click the group or folder name.

NOTE

The **MixConsole** in the lower zone of the **Project** window does not follow any visibility changes that you perform in the **MixConsole** window and vice versa.

RELATED LINKS

[Synchronizing Channel and Track Visibility](#) on page 408

Synchronizing Channel and Track Visibility

You can synchronize the channel visibility in the **MixConsole** with the track visibility in the **Project** window.

PROCEDURE

1. In the left zone of the **MixConsole**, open the **Visibility** tab.
 2. Click **Sync Visibility of Project and MixConsole: On/Off** .
 3. Select **Sync Project and MixConsole** to synchronize the channel visibility with the track visibility.
-

RESULT

The track and channel visibility are synchronized.

NOTE

Channels that are locked on the **Zones** tab are not synchronized.

RELATED LINKS

[MixConsole Visibility](#) on page 408

[Synchronizing Track and Channel Visibility](#) on page 71

MixConsole Zones

The **Zones** tab lists all channels contained in your project, and allows you to lock the position of specific channels.

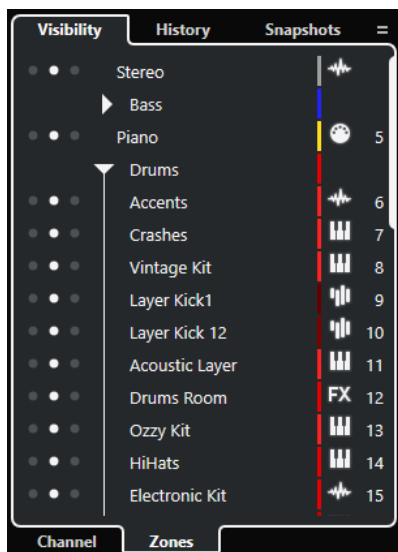

- To lock channels on the left/right of the fader section, click the left or right dots next to the channel names.
Locked channels are excluded from scrolling. They are always visible.

NOTE

The **MixConsole** in the lower zone of the **Project** window does not follow any visibility changes that you perform in the **MixConsole** window and vice versa.

MixConsole History

The **History** tab lists all **MixConsole** parameter changes, and allows you to undo/redo specific changes.

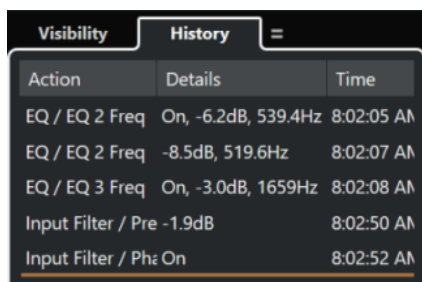
A screenshot of the MixConsole interface showing the 'History' tab. The interface has three tabs: 'Visibility', 'History', and 'Snapshots'. Below the tabs is a table with three columns: 'Action', 'Details', and 'Time'. The table contains the following rows:

Action	Details	Time
EQ / EQ 2 Freq	On, -6.2dB, 539.4Hz	8:02:05 AM
EQ / EQ 2 Freq	-8.5dB, 519.6Hz	8:02:07 AM
EQ / EQ 3 Freq	On, -3.0dB, 1659Hz	8:02:08 AM
Input Filter / Pre	-1.9dB	8:02:50 AM
Input Filter / Phz	On	8:02:52 AM

- To undo **MixConsole** parameter actions, click the orange line in the history list and drag it up.
- To redo **MixConsole** parameter actions, click the orange line in the history list and drag it down.

NOTE

You can also undo/redo **MixConsole** parameter actions by using the corresponding buttons in the **MixConsole** toolbar.

RELATED LINKS

[Undoing/Redoing MixConsole Parameter Changes](#) on page 416

MixConsole Snapshots

The **Snapshots** tab lists all snapshots of **MixConsole** settings, and allows you to recall them later. This is useful if you want to compare different versions of a mix.

In Nuendo, you can save up to 10 snapshots for audio-related channels. These save settings for input/output, audio, VST instrument, sampler track, group, FX, and VCA fader channels. Snapshots are saved with the project.

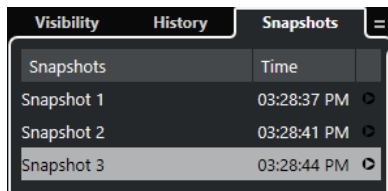

- To recall a specific **MixConsole** snapshot, select it in the list, and click **Recall Snapshot x**.
- To set up the recall settings, right-click in the list, and select **MixConsole Snapshot Recall Settings**.

NOTE

Recalling a snapshot can be undone/redone in the **MixConsole** history.

RELATED LINKS

[Renaming MixConsole Snapshots](#) on page 417

[Recalling MixConsole Snapshots via the Snapshots Tab](#) on page 417

[MixConsole Snapshot Recall Settings](#) on page 419

[MixConsole History](#) on page 409

MixConsole Toolbar

The toolbar contains tools and shortcuts for settings and functions in the **MixConsole**.

NOTE

The **MixConsole** toolbar in the lower zone of the **Project** window contains a limited set of tools.

MixConsole History

Undo/Redo



These buttons allow you to undo/redo **MixConsole** parameter changes.

MixConsole Snapshots

Save MixConsole Snapshot



Saves a **MixConsole** snapshot.

MixConsole Snapshot Functions



Opens the **MixConsole Snapshot Functions** menu.

Left Divider

Left Divider

Allows you to use the left divider. Tools that are placed to the left of the divider are always shown.

Search

Find Track/Channel



Opens a selector that lists all tracks/channels.

Channel Visibility Configuration

Channel Visibility Configurations

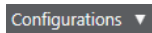

Allows you to create configurations that are useful for switching quickly between different visibility setups.

Channel Visibility Agents



Allows you to set a visibility agent to filter the channels.

Set Channel Type Filter



Opens the channel filter that allows you to show/hide all channels of a certain channel type.

Racks

Select Rack Types



Opens the rack selector that allows you to show/hide specific racks.

Rack Settings



Opens a pop-up menu with settings for the racks.

Locators

Go to Left Locator Position



Allows you to go to the left locator position.

Left Locator Position

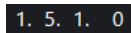

Shows the left locator position.

Go to Right Locator Position



Allows you to go to the right locator position.

Right Locator Position

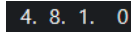

Shows the right locator position.

Locator Range Duration

Locators to Selection



Allows you to set the locators to the selection.

Locator Range Duration

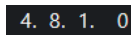

Shows the duration of the locator range.

Transport Buttons

Go to Previous Marker/Zero



Moves the project cursor to the previous marker/zero position on the timeline.

Go to Next Marker/Project End



Moves the project cursor to the next marker/project end.

Rewind



Moves backward.

Forward



Moves forward.

Activate Cycle



Activates/Deactivates cycle mode.

Stop



Stops playback.

Start



Starts playback.

Transport Record



Activates/Deactivates record mode.

Time Displays

Primary Time Display

6. 1. 1. 0

Shows the position of the project cursor in the selected time format.

Select Primary Time Format



Allows you to select a time format for the primary time display.

Secondary Time Display

0:00:11.000

Shows the position of the project cursor in the selected time format.

Select Secondary Time Format



Allows you to select a time format for the secondary time display.

Markers

Jump to Marker

1 2 3 4 5 6 7 8

Allows you to set and locate marker positions.

Open Markers Window



Opens the **Markers** window.

State Buttons

Deactivate All Mute States

M

Deactivates all mute states.

Deactivate All Solo States

S

Deactivates all solo states.

Deactivate All Listen States

L

Deactivates all listen states.

Activate/Deactivate Read for All Tracks

R

Activates/Deactivates read automation for all tracks.

Activate/Deactivate Write for All Tracks

W

Activates/Deactivates write automation for all tracks.

Suspend All Read/Write Automation

A

Suspends all read/write automation.

Bypass Inserts

Ins

Bypasses all inserts.

Bypass EQs



Bypasses all EQs.

Bypass Channel Strip



Bypasses all channel strip modules.

Bypass Sends



Bypasses all sends.

Link Group

Link/Unlink Selected Channels



Links the selected channels/removes their link.

Edit Link Group Settings



Allows you to change the link group settings.

Suspend All Channel Linking



Suspends all channel linking.

Absolute Mode



Enables absolute value changes.

Temporary Link Mode



Synchronizes all touched parameters of selected channels.

Zoom Palette

Reduce Channel Width



Allows you to reduce the channel width.

Set Number of Channels



Displays the set number of channels.

Increase Channel Width



Allows you to increase the channel width.

Reduce Rack Height



Allows you to reduce the rack height.

Increase Rack Height



Allows you to increase the rack height.

System Performance Meter

System Performance Meter



Shows the meters for average audio processing load and the disk cache load.

Right Divider

Right Divider

Tools that are placed to the right of the divider are always shown.

Mixer Functions Menu

Functions Menu



Opens a pop-up menu where you can select a **MixConsole** function.

Window Zone Controls

Show/Hide Left Zone



Shows/Hides the left zone of the window.

Show/Hide Right Zone



Shows/Hides the right zone of the window.

Set up Window Layout



Allows you to set up the window layout.

Set up Toolbar

Set up Toolbar



Opens a pop-up menu where you can set up which toolbar elements are visible.

Finding Channels

The **Find Track/Channel** function allows you to find specific channels. This is useful if you have a large project with many channels or if you have hidden channels using the visibility features.

PROCEDURE

1. Click **Find Track/Channel** on the **MixConsole** toolbar to open a selector that lists all channels.
2. In the search field, enter the name of the channel.
As you type, the selector filters automatically.
3. In the selector, select the channel and press **Return**.

RESULT

The channel is selected in the channel list.

NOTE

If the channel was outside the view or hidden, it is now shown. Channels that are hidden using **Set Channel Type Filter** are not shown.

Undoing/Redoing MixConsole Parameter Changes

You can undo/redo **MixConsole** parameter changes and experiment with different **MixConsole** settings.

NOTE

MixConsole parameters that change due to read automation actions are not part of the **MixConsole** history.

To undo/redo a **MixConsole** parameter, do one of the following:

- On the **MixConsole** toolbar in the **MixConsole** window or in the lower zone of the **Project** window, click **Undo** or **Redo**.
- Press **Alt/Opt - Z** to undo **MixConsole** parameter changes or press **Alt/Opt - Shift - Z** to redo parameter changes.

The following **MixConsole** parameter changes can be undone/redone:

- Volume changes
- Panorama changes
- Changes on the **Routing** rack
- Filter, gain, and phase changes in the **Pre** rack
- Plug-in changes in the **Inserts** rack
- EQ changes
- Changes on the **Channel Strip** rack
- Changes on the **Sends** rack
- Changes on the **Cue Sends** rack
- Changes on the **Direct Routing** rack

IMPORTANT

The **MixConsole** history is not saved with the project.

RELATED LINKS

[MixConsole History](#) on page 409

[MixConsole Toolbar](#) on page 410

Saving Snapshots of MixConsole Settings

You can save **MixConsole** settings for audio-related channels in a snapshot.

PROCEDURE

- On the toolbar, click **Save MixConsole Snapshot**.
-

RESULT

The **MixConsole** settings are saved in a snapshot. You can save up to 10 snapshots. These are shown on the **Snapshots** tab in the left zone of the **MixConsole**.

NOTE

Automation data is not saved in **MixConsole** snapshots.

AFTER COMPLETING THIS TASK

You can open the **MixConsole Snapshot Recall Settings** dialog, and activate the settings that you want to recall.

RELATED LINKS

[MixConsole Snapshot Recall Settings](#) on page 419

Renaming MixConsole Snapshots

You can rename **MixConsole** snapshots.

PROCEDURE

1. In the left zone of the **MixConsole**, open the **Snapshots** tab.
 2. Double-click the snapshot name and type in a new name for the snapshot.
 3. Press **Return**.
-

Updating a MixConsole Snapshot

You can update a snapshot. This is useful if you want to apply changes to an existing setting, or if you already saved 10 snapshots.

PROCEDURE

- Do one of the following:
 - On the **MixConsole** toolbar, click **MixConsole Snapshot Functions**, and select **Update Selected Snapshot: Snapshot x**.
 - On the **Snapshots** tab, right-click the snapshot that you want to update, and select **Update Selected Snapshot: Snapshot x**.
-

RESULT

The snapshot is updated.

NOTE

Automation data is not saved in **MixConsole** snapshots.

AFTER COMPLETING THIS TASK

You can open the **MixConsole Snapshot Recall Settings** dialog, and activate the settings that you want to recall.

RELATED LINKS

[MixConsole Snapshot Recall Settings](#) on page 419

Recalling MixConsole Snapshots via the Snapshots Tab

You can recall **MixConsole** snapshots via the **Snapshots** tab.

PREREQUISITE

You have saved at least one **MixConsole** snapshot.

PROCEDURE

1. In the left zone of the **MixConsole**, open the **Snapshots** tab.
2. Optional: Click **MixConsole Snapshot Functions** and select **MixConsole Snapshot Recall Settings** to open a dialog where you can activate the settings that you want to recall, and click **OK**.
3. Select the snapshot that you want to recall, and click **Recall Snapshot x** .

NOTE

Automation data is not saved in **MixConsole** snapshots. If you recall a snapshot to a channel that contains automation data, you get a warning message.

A message informs you that the snapshot is recalled.

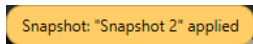

RESULT

The snapshot is recalled and the settings are applied. If you recall a snapshot during playback, you might hear a short gap, depending on how different the settings are from the current state.

RELATED LINKS

[MixConsole Snapshot Recall Settings](#) on page 419

Recalling MixConsole Snapshots via the MixConsole Toolbar

You can recall **MixConsole** snapshots via the **MixConsole** toolbar.

PREREQUISITE

You have saved at least one **MixConsole** snapshot.

PROCEDURE

1. On the toolbar, click **MixConsole Snapshot Functions**.
2. From the menu, select the snapshot that you want to recall.

NOTE

Automation data is not saved in **MixConsole** snapshots. If you recall a snapshot to a channel that contains automation data, you will get a warning message.

A message informs you that the snapshot is recalled.

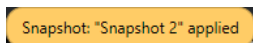

RESULT

The snapshot is recalled and the settings are applied. If you recall a snapshot during playback, you might hear a short gap, depending on how different the settings are from the current state.

RELATED LINKS

[MixConsole Snapshot Recall Settings](#) on page 419

Adding Notes to Snapshots

You can add notes and comments to a snapshot.

PREREQUISITE

You have saved at least one **MixConsole** snapshot.

PROCEDURE

1. In the left zone of the **MixConsole**, open the **Snapshots** tab.
 2. Select the snapshot for which you want to add comments.
 3. In the **Snapshot Notes** section of the **Snapshots** tab, type in your notes.
-

MixConsole Snapshot Recall Settings

The **MixConsole Snapshot Recall Settings** allow you to specify the channel settings that are recalled when you load a saved snapshot.

To open the **MixConsole Snapshot Recall Settings**, do one of the following:

- Open the **MixConsole Snapshot Functions** pop-up menu on the **MixConsole** toolbar, and select **MixConsole Snapshot Recall Settings**.
- In the left zone of the **MixConsole**, right-click in the **Snapshots** tab, and select **MixConsole Snapshot Recall Settings**.

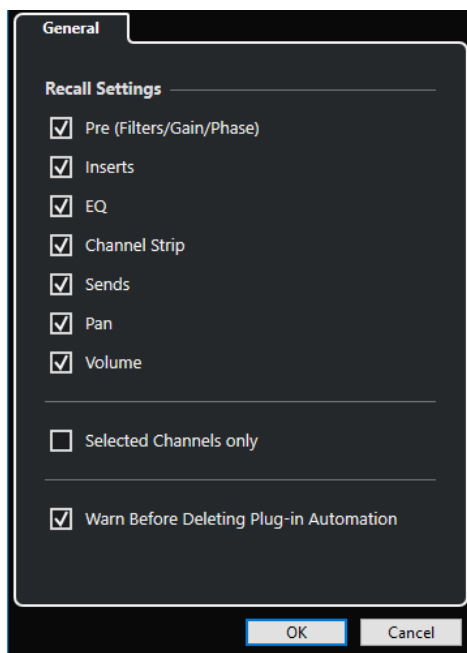

The following options allow you to specify which settings are recalled:

Pre (Filters/Gain/Phase)

Activate this to recall the filters, gain and phase settings.

Inserts

Activate this to recall the inserts.

EQ

Activate this to recall the equalizers.

Channel Strip

Activate this to recall the channel strip modules.

Sends

Activate this to recall the sends.

Pan

Activate this to recall the panorama.

Volume

Activate this to recall the volume.

Selected Channels only

Activate this to recall the settings only for selected channels.

Warn Before Deleting Plug-in Automation

If this option is activated, a warning opens if plug-in automation might be deleted.

Filtering Channel Types

The channel types filter on the **MixConsole** toolbar allows you to determine which channel types are shown.

PROCEDURE

1. Click **Set Channel Type Filter**.

This opens the channel types filter.

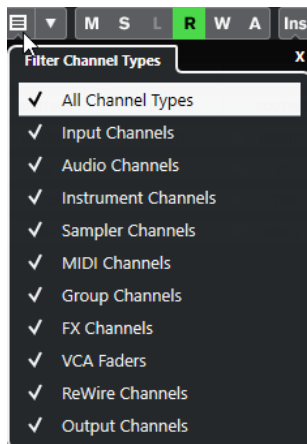

2. Click to the left of a channel type to uncheck it and hide all channels of that type.

RESULT

Channels of the filtered type are removed from the fader section and the color of the **Set Channel Type Filter** button changes to indicate that a channel type is hidden.

Channel Visibility Configurations Menu

The **Channel Visibility Configurations** button on the **MixConsole** toolbar allows you to create configurations that are useful for switching quickly between different visibility setups.

The button displays the name of the active configuration. A list of configurations is shown as soon as you create at least one configuration. To load a configuration, select it from the menu. Channel visibility configurations are saved with the project.

Add Configuration

Opens the **Add Configuration** dialog that allows you to save the configuration and enter a name for it.

Update Configuration

If you change the active configuration, this is indicated by an asterisk after the configuration name. Use this function to save changes to the active configuration.

Rename Configuration

Opens the **Rename Configuration** dialog that allows you to rename the active configuration.

Delete Configuration

Allows you to delete the active configuration.

Move Configuration to Position

This function becomes available if 2 or more configurations exist. It allows you to change the position of the active configuration on the menu. This is useful as you can assign key commands to the first 8 configurations in the **Channel & Track Visibility** category of the **Key Commands** dialog.

Saving Configurations

To quickly switch between different channel setups, you can save configurations. The configurations contain visibility and zone settings as well as the show/hide status of channel types and racks.

PROCEDURE

1. Set up the configuration that you want to save.
2. On the toolbar, click **Channel Visibility Configurations**.
3. From the pop-up menu, select **Add Configuration**.
4. In the **Add Configuration** dialog, enter a name for the configuration.
5. Click **OK**.

RESULT

The configuration is saved and you can return to it at any time.

Channel Visibility Agents

Channel visibility agents allow you to show or hide all channels, selected channels, or channels with certain properties.

To open the **Channel Visibility Agents** pop-up menu, do one of the following:

- Click **Channel Visibility Agents** on the toolbar.
- In the left zone of the **MixConsole**, select the **Visibility** tab and right-click an empty area to open the context menu.

Channel Visibility Agents Menu

Channel Visibility Agents pop-up menu contains options that allow you to show or hide all channels, selected channels, or channels with certain properties.

- To open the **Channel Visibility Agents** pop-up menu, click **Channel Visibility Agents** on the toolbar.

Show All Channels

Shows all channels of your project.

Show Only Selected Channels

Shows only channels that are selected.

Hide Selected Channels

Hides all channels that are selected.

Show Channels for Tracks with Data

Shows all channels for tracks with events or parts.

Show Channels for Tracks with Data at the Cursor Position

Shows all channels for tracks with events or parts at the cursor position.

Show Channels for Tracks with Data between the Locators

Shows all channels for tracks with events or parts between the locators.

Show Channels that are Connected to the First Selected Channel

Shows all channels that are connected to the channel you first selected.

Undo Visibility Change

Undoes visibility changes.

Redo Visibility Change

Redoes visibility changes.

NOTE

You can assign key commands for the channel visibility agents in the **Channel & Track Visibility** category of the **Key Commands** dialog.

Undoing/Redoing Visibility Changes

You can undo/redo up to 10 visibility changes.

PROCEDURE

1. On the **MixConsole** toolbar, click **Channel Visibility Agents**.
 2. Select **Undo Visibility Change** or **Redo Visibility Change**.
-

Rack Selector

The rack selector allows you to activate specific **MixConsole** functions that are organized in racks, such as routing, insert, or send handling.

Channel Racks Selector

You can activate and deactivate the different channel racks in the **MixConsole**.

- To open the rack selector, click **Select Rack Types** on the **MixConsole** toolbar.

Depending on the channel type, you can activate/deactivate the following racks:

Hardware

Allows you to control your audio hardware effects. This rack is only available if supported by your hardware.

Routing

Allows you to set up the input and output routing. For MIDI, you can also select the MIDI channel.

Pre (Filters/Gain/Phase)

For audio-related channels, it contains input filter and gain controls along with **Phase** and **Gain** controls. For MIDI channels, it contains an **Input Transformer** control.

Inserts

Allows you to select insert effects for your channel.

Equalizers (audio-related channels only)

Allows you to set the channel EQ.

Channel Strip (audio-related channels only)

Allows you to integrate channel strip modules, such as Gate, Compressor, EQ, Transformer, Saturator, and Limiter that allow you to enhance your sound.

Sends

Allows you to select send effects for your channel.

Cue Sends (audio-related channels only)

Allows you to activate and control the level and pan for up to 4 cue sends.

Direct Routing

Allows you to set and activate outputs for all selected channels at once.

Track Quick Controls

Allows you to add quick controls for instant access.

Device Panels

Allows you to view the available device panels.

VCA

Allows you to view and set connections to VCA faders.

RELATED LINKS

[MixConsole Toolbar](#) on page 410

Rack Settings Menu

The **Rack Settings** pop-up menu allows you to make settings for the racks.

- To open the **Rack Settings** pop-up menu, click **Rack Settings** on the **MixConsole** toolbar.

Exclusive Expanded Rack

Shows the selected rack exclusively and collapses the other racks.

Fixed Number of Slots

Shows all available slots for the **Inserts**, **Sends**, **Cues**, and **Quick Controls** racks.

Link Racks to Configurations

If this option is activated, the rack status is taken into account when you save and load a configuration.

Show Pre/Filters as <Combined Label & Setting>

Select **Combined Label & Setting** if you want to show the label and the setting in one line.

Select **Separate Label & Setting** if you want to show the label and the setting in separate lines.

Show Inserts as <Plug-in Names & Insert Controls>

Select **Plug-in Names** if you want to show the plug-in names only.

Select **Plug-in Names & Insert Controls** if you want to show the plug-in names and the insert controls.

Show All Channel Strip Controls

Shows all available controls on the **Channel Strip** rack.

Show One Channel Strip Type

Shows only one channel strip type at a time.

Show Sends as <Send Destination & Gain>

Select **Send Destination & Gain** if you want to show the destination and the gain in one line.

Select **Send Destination, Gain & Send Controls** if you want to show the destination, the gain and the send controls.

Show Quick Controls as <Combined Destination & Value>

Select **Combined Destination & Value** if you want to show the destination and the value in one line.

Select **Separate Destination & Value** if you want to show the destination and the value in separate lines.

RELATED LINKS

[MixConsole Toolbar](#) on page 410

Linking Channels

You can link selected channels in the **MixConsole** to form a link group. Any change that is applied to one channel is mirrored by all linked channels, depending on which settings are activated in the link group settings.

The **Link Group** options on the **MixConsole** toolbar allow you to link channels and to edit links and linking configuration.



Link Group Settings Dialog

The **Link Group Settings** dialog allows you to specify the channel settings that are linked.

- To open the **Link Group Settings** dialog, click **Link** on the **MixConsole** toolbar.

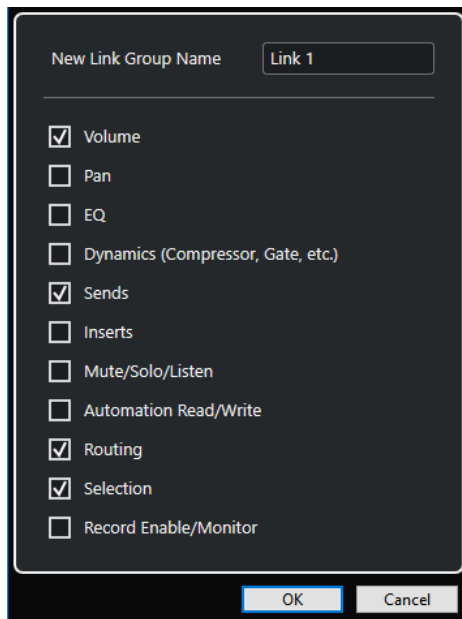

The following options are available:

New Link Group Name

Allows you to enter a name for the link group.

Volume

Activate this to link the volume of the linked channels.

Pan

Activate this to link the panorama of the linked channels.

EQ

Activate this to link the equalizers of the linked channels.

Dynamics (Compressor, Gate, etc.)

Activate this to link the dynamics of the linked channels.

Sends

Activate this to link the sends of the linked channels.

Inserts

Activate this to link the inserts of the linked channels.

Mute/Solo/Listen

Activate this to link the mute, solo, and listen states of the linked channels.

Automation Read/Write

Activate this to link the automation read/write states of the linked channels.

Routing

Activate this to link the routing of the linked channels.

Selection

Activate this to link the selection of the linked channels.

Record Enable/Monitor

Activate this to link the record enable/monitor states of the linked channels.

NOTE

By default, the volume, sends, routing, and selection settings are activated.

Display Line

Whenever you create a link group, a display line is added on top of the fader section in the **MixConsole**.

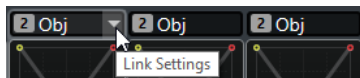

The display line shows the number and the name of the created link group and provides a **Link Settings** pop-up menu that allows you to edit the link group settings.

On the display line, you can change the name of the link group by double-clicking and entering a different name. If you hold down a modifier key and double-click the name, the **Link Group Settings** dialog opens.

The pop-up menu provides the following options:

Unlink Selected Channels

Only available for a selected link group. Select this option to remove the link between the channels. This removes the link group.

Edit Link Group Settings

Allows you to change the link group settings.

Included in Link Group: <name of link group>

Shows the link group to which the selected channel belongs. You can assign the selected channel to a different link group. This removes the channel from the current group. If you only want to remove the selected channel from the link group, select **None**.

Linked Channels

Shows which channels are linked in the link group.

RELATED LINKS

[Changing the Link Group Settings](#) on page 426

[Adding Channels to Link Groups](#) on page 427

[Removing Channels from Link Groups](#) on page 427

[VCA Faders](#) on page 474

Creating Link Groups

You can link several channels to form a link group.

PROCEDURE

1. Select the channels that you want to link.
2. On the **MixConsole** toolbar, click **Link**.
3. In the **Link Group Settings** dialog, activate the parameters that you want to link.
4. Click **OK**.

RESULT

The number and name of the link group is indicated above the channel name in the display line.

NOTE

- If you link groups, insert and channel strip module linking is applied at the slot level. For example, if you change the settings for insert slot 3 on one channel, these changes are also applied to slot 3 on the other channels. Insert effects in other slots remain unaffected.
- If you select a channel that belongs to a link group, all channels in this link group are selected by default. To prevent the multiple selection of all channels that belong to a link group, deactivate **Selection** in the **Link Group Settings** dialog.

RELATED LINKS

[Link Group Settings Dialog](#) on page 424

Changing the Link Group Settings

If you change a setting for a channel of a link group, the change is applied to the whole group.

- To change the link settings for an existing link group, select the group, on the **MixConsole** toolbar, click **Edit Link Group Settings**, and change the settings in the **Link Group Settings** dialog.
- To unlink channels, select one of the linked channels and click **Link** on the **MixConsole** toolbar.
- To prevent the multiple selection of all channels that belong to a link group, deactivate **Selection** in the **Link Group Settings** dialog.
- To make individual settings and changes for a channel in a link group, activate **Sus** on the **MixConsole** toolbar or press **Alt/Opt**.
- To make absolute instead of relative value changes, activate **Abs** on the **MixConsole** toolbar.

NOTE

The automation tracks for linked channels are not affected by the **Link** function.

RELATED LINKS

[Link Group Settings Dialog](#) on page 424

Adding Channels to Link Groups

You can add a channel to an existing link group.

PROCEDURE

1. On the display line of the channel that you want to add, open the **Link Settings** pop-up menu.
 2. Select **Included in Link Group: <None>** and select the link group.
-

RESULT

The channel is added to the link group.

Removing Channels from Link Groups

You can remove a channel from an existing link group.

PROCEDURE

1. On the display line of the channel that you want to remove, open the **Link Settings** pop-up menu.
 2. Select **Included in Link Group: <link group name>**, and from the link group list, select **None**.
-

RESULT

The channel is removed from the link group.

Using Quick Link

You can activate the **Temporary Link Mode** to synchronize all touched parameters of selected channels.

PROCEDURE

1. Select the channels that you want to link.
2. On the **MixConsole** toolbar, activate **Q-Link**.

NOTE

You can also press **Shift - Alt/Opt** to temporarily link channels. In that case, the link is only active as long as you press the keys.

3. Change the parameters for one of the selected channels.
-

RESULT

The changes are applied to all selected channels until you deactivate **Q-Link**.

Functions Menu

The **Functions Menu** contains tools and shortcuts for settings and functions in the **MixConsole**.

- To open the **Functions Menu**, click **Functions Menu** on the **MixConsole** toolbar.

Scroll to Selected Channel

If this option is activated and you select a channel on the **Visibility** tab, the selected channel is automatically displayed in the fader section.

Copy First Selected Channel's Settings

Copies the settings of the first selected channel.

Paste Settings to Selected Channels

Pastes the settings to the selected channels.

Zoom

Opens a submenu where you can increase or reduce the channel width and the rack height.

Open Audio Connections

Opens the **Audio Connections** window.

Control Room Cue Channels

Opens a submenu where you can activate/deactivate cue channels and change level and panning settings.

Constrain Delay Compensation

Allows you to activate/deactivate the **Constrain Delay Compensation** that keeps all channels in perfect sync and automatically compensates any delay inherent in VST plug-ins during playback.

Direct Routing: Summing Mode On/Off

Allows you to feed your signals to several outputs at the same time.

After Fader Listen Mode

Allows you to enable/disable that the signal of a listen-enabled channel is routed to the **MixConsole** channel after applying the fader and pan settings.

EQ/Filter Transition

Allows you to change the **EQ/Filter Transition** mode from **Soft** to **Quick**.

Save Selected Channels

Saves the settings for the selected channels.

Load Selected Channels

Loads the settings for the selected channels.

Global Meter Settings

Opens a submenu where you can set up the global meter settings.

Reset MixConsole Channels

Allows you to reset EQ, insert, and send effect settings for all or selected channels. Solo and mute buttons are deactivated, the volume fader is set to 0 dB, and pan is set to the center position.

Link MixConsoles

You can link multiple **MixConsole** windows. This allows you to display all channels that are visible in the fader section in different windows on different monitors, for example. The scrollbars, the visibility configurations, filters, and the toolbar functions that affect the fader section are linked.

NOTE

The **MixConsole** in the lower zone of the **Project** window is excluded from the link function.

RELATED LINKS

[MixConsole Toolbar](#) on page 410

Saving MixConsole Settings

You can save **MixConsole** settings for selected audio-related channels and load them into any project.

PROCEDURE

1. Select the channels with the settings that you want to save.
 2. Select **Functions Menu > Save Selected Channels**.
 3. In the file dialog, specify the file name and location.
 4. Click **Save**.
-

RESULT

The settings for the selected channels are saved with the file extension `.vmx`. The input/output routing is not saved.

Loading MixConsole Settings

You can load **MixConsole** settings that have been saved for selected channels.

PROCEDURE

1. Select the same number of channels that you selected when you saved your **MixConsole** settings.
The loaded **MixConsole** settings are applied in the same order as originally saved. For example, if you have saved the settings for channels 4, 6, and 8, and apply these settings to channels 1, 2, and 3, the settings saved for channel 4 are applied to channel 1, the settings saved for channel 6 to channel 2, and so on.
 2. Select **Functions Menu > Load Selected Channels**.
 3. In the **Load Selected Channels** dialog, select the `.vmx` file and click **Open**.
-

RESULT

The channel settings are applied to the selected channels.

NOTE

When you apply loaded **MixConsole** settings to fewer channels, some of the saved settings are not applied. Since the saved settings are applied from left to right as shown in the **MixConsole**, the settings for the channels furthest to the right are not applied to any channels.

Fader Section

The fader section is the heart of the **MixConsole**. It shows input and output channels together with audio, instrument, MIDI, group, FX, VCA fader, and ReWire channels.



NOTE

If a channel is deactivated on the **Visibility** tab or if its channel type is deactivated, it is not shown in the fader section. The **MixConsole** in the lower zone of the **Project** window does not follow any visibility changes you perform in the **MixConsole** window and vice versa. It is linked to the track visibility of the **Project** window.

The fader section allows you to do the following:

- Edit link group settings
- Set panorama
- Activate mute and solo
- Enable listen mode
- Open channel settings
- Set volume
- Enable automation
- Set input levels

NOTE

All fader section functions and settings are also available in the **MixConsole** in the lower zone of the **Project** window.

RELATED LINKS

[Changing the Link Group Settings](#) on page 426

[Channel Settings](#) on page 459

[Write/Read Automation](#) on page 805

[Showing/Hiding MixConsole Channels in the Lower Zone](#) on page 403

Pan Control

For each audio-related channel with at least a stereo output configuration, you can find a pan control at the top of the fader section. For MIDI channels, the pan control sends out MIDI pan messages. The result depends on how your MIDI instrument is set to respond to pan.

The pan control allows you to position a channel in the stereo spectrum. This control is different for stereo and surround configurations. Channels with a multi-channel output configuration feature a miniature **VST MultiPanner** control.

- To make fine adjustments, hold down **Shift** when you move the pan control.
- To select the default center pan position, hold down **Ctrl/Cmd**, and click the pan control.
- To edit the value numerically, double-click the pan control.

RELATED LINKS

[Creating New Projects](#) on page 103

[Surround Sound](#) on page 740

Stereo Balance Panner

The stereo balance panner allows you to control the balance between the left and right channels. It is activated by default.

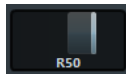

Stereo Combined Panner

With the stereo combined panner, the left and right pan controls are linked and keep their relative distance if you move them. It is available for channels with a stereo input and output configuration.

- To activate this panner, open the context menu for a pan control and select **Stereo Combined Panner**.

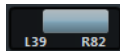

- To set the pan independently for the left and right channels, hold down **Alt/Opt** and drag left or right.
- To reverse the left and right channels, pan the left channel to the right and the right to the left.

The area between the pan controls changes the color to indicate that the channels are reversed.

- To sum two channels, set them to the same pan position (mono).
Note that this increases the volume of the signal.
- To specify the default stereo panner mode for new audio tracks, set the **Default Stereo Panner Mode** in the **Preferences** dialog (**VST** page).

Pan Bypass

You can bypass the panning for all audio-related channels.

- To activate panning bypass, click the button to the left or press **Ctrl/Cmd - Alt/Opt - Shift** and click the pan control.
- To deactivate panning bypass, press **Ctrl/Cmd - Alt/Opt - Shift** and click again.

When panning is bypassed for a channel, the following happens:

- Mono channels are panned center.
- Stereo channels are panned hard left and right.
- Surround channels are panned center.

Using Solo and Mute

You can silence one or several channels using **Solo** and **Mute**.

- To silence a channel, click **Mute**.
Click again to deactivate the mute state for the channel.
- To mute all other channels, click **Solo** for a channel.
Click again to deactivate the solo state.
- To deactivate the mute or solo states for all channels simultaneously, click **Deactivate All Mute States** or **Deactivate All Solo States** on the toolbar.
- To activate exclusive solo mode, hold down **Ctrl/Cmd** and click **Solo** for the channel.
The **Solo** buttons of all other channels are deactivated.
- To activate solo defeat for a channel, **Alt/Opt**-click **Solo**.



You can also click and hold **Solo** to activate solo defeat. In this mode, the channel is not muted when you solo another channel. **Alt/Opt**-click again to deactivate solo defeat.

Listen Mode

The listen mode allows you to quickly check the signal that is coming from selected channels without interrupting and interfering with the actual mix. During a recording session it allows the sound engineer in the control room to attenuate the signal that is coming from one of the musicians while the recording continues undisturbed, for example.

NOTE

To enable the listen mode, you need to enable the **Control Room**.

- To enable the listen mode, click **Listen** for a channel.
This routes the channel to the **Control Room** without interrupting the signal flow.
- To turn off listen mode for all channels simultaneously, click **Deactivate All Listen States** on the **MixConsole** toolbar.

Volume

Each channel in the fader section of the **MixConsole** has a volume fader. The fader levels are displayed below the fader, in dB for audio-related channels and as MIDI volume (0 to 127) for MIDI channels.

- To change the volume, move the fader up or down.
- To make fine volume adjustments, press **Shift** while moving the faders.
- To reset the volume to its default value, press **Ctrl/Cmd** and click a fader.

For audio channels, the volume fader controls the volume of the channel before it is routed to an output bus, directly or via a group channel. For output channels, the volume fader controls the master output level of all audio channels that are routed to an output bus. For MIDI channels, the volume fader controls the volume changes in the **MixConsole** by sending out MIDI volume messages to the connected instruments that are set to respond to MIDI messages.

Global Meter Settings Menu

You can change the meter characteristics for audio channels using the context menu of the channel meter.

Right-click the channel meter and select one of the following options from the **Global Meter Settings** menu:

Meter Peak Options - Hold Peaks

The highest registered levels are held and shown as static horizontal lines in the meter.

Meter Peak Options - Hold Forever

If this option is activated, the peak levels are shown until you reset the meters. If this option is deactivated, you can use the **Meters' Peak Hold Time** parameter in the **Preferences** dialog (**Metering** page) to specify for how long the peak levels are held. The peak hold time can be between 500 and 30000 ms.

Meter Position - Input

If this option is activated, the meters show input levels for all audio channels and input/output channels. The input meters are post input gain.

Meter Position - Post-Fader

If this option is activated, the meters show post-fader levels.

Meter Position - Post-Panner

If this option is activated, the meters show post-fader levels and also reflect pan settings.

Reset Meters

Resets the meters.

Setting up Meter Colors

Setting up meter colors can help you to keep an overview of what levels are being reached.

PROCEDURE

1. In the **Preferences** dialog, select **Metering > Appearance**.

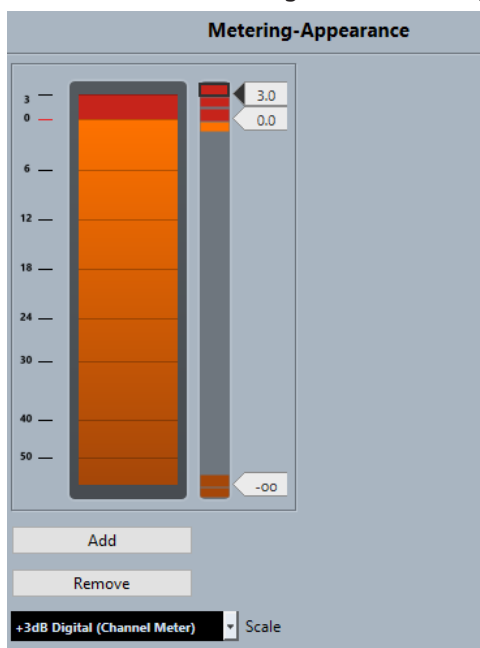

2. Select a scale from the **Scale** pop-up menu for editing.

NOTE

The **+3 dB Digital Scale** is used in the channel meters.

3. Do one of the following to set the level position for a color change:
 - Double-click a level position to the right of the meter scale and enter the level (dB) value. To enter dB values smaller than zero, add a minus sign before the entered number.
 - Click a level position and drag it to a specific level, and press **Shift** for more accurate positioning.
 - Click a level position and nudge it up or down with the **Up Arrow** / **Down Arrow** keys, and press **Shift** for faster positioning.
4. Click the upper or lower part of a color handle so that a frame is shown, and in the color picker, select a color.

Selecting the same color for the upper and lower part of the handle results in a meter that changes its colors gradually. Different colors indicate level changes even more precisely.

NOTE

- To add more color handles, click **Add**, or **Alt**-click at a level position to the right of the meter scale. Each new handle is automatically associated with a default color.
 - To remove a handle, select the handle and click **Remove**, or **Ctrl/Cmd**-click the handle.
-
5. Click **OK**.
-

RELATED LINKS

[Metering - Appearance](#) on page 1371

Level Meters

The channel meters show the level when you play back audio or MIDI. The **Meter Peak Level** indicator shows the highest registered level.

- To reset the peak level, **Alt/Opt**-click the **Meter Peak Level** value.

NOTE

Input and output channels have clipping indicators. When they light up, lower the gain or the levels until the indicator is no longer lit.

Input Levels

When recording digital sound, it is important to set the input levels high enough to ensure low noise and high audio quality. At the same time, you must avoid clipping (digital distortion).

Setting Input Levels

In the **MixConsole**, you can set the input level. Make sure that the signal is loud enough but does not exceed 0 dB.

PROCEDURE

1. Select **Functions Menu > Global Meter Settings > Meter Position** and activate **Input**.
In this mode, the input channel level meters show the level of the signal at the input of the bus, before any adjustments, such as input gain, EQ, effects, level, or pan are made. This allows you to check the level of the unprocessed signal coming into the audio hardware.
2. Play back the audio and check the level meter for the input channel.

The signal should be as loud as possible without exceeding 0 dB, that is, the clipping indicator for the input bus should not light up.

3. If necessary, adjust the input level in one of the following ways:
 - Adjust the output level of the sound source or the external mixer.
 - If possible, use the audio hardware's own application program to set the input levels. Refer to the documentation for the audio hardware.
 - If your audio hardware supports the ASIO control panel function, it may be possible to make input level settings. To open the ASIO control panel, select **Studio > Studio Setup** and in the **Devices** list, select your audio card. When this is selected, you can open the control panel by clicking **Control Panel** in the settings section to the right.
4. Optional: Select **Functions Menu > Global Meter Settings > Meter Position** and activate **Post-Fader**.

NOTE

This allows you to check the level of the audio being written to a file on your hard disk, which is only necessary if you make any adjustments to the input channel.

5. Optional: In the **Channel Racks** section, in the **Inserts** rack, click a slot and select an effect, or in the **Equalizers** rack, make your EQ settings.
For some effects you may want to adjust the level of the signal going into the effect. Use the input gain function for this. Press **Shift** or **Alt/Opt** to adjust the input gain.
 6. Play back the audio and check the level meter of the input channel.
The signal should be reasonably loud without exceeding 0 dB, that is, the clipping indicator for the input bus should not light up.
 7. If necessary, use the input channel fader to adjust the signal level.
-

Clipping

Clipping typically occurs in the audio hardware when an analog signal is too loud and therefore converted to digital in the hardware's A/D converters.

Clipping can also occur when the signal from the input bus is written to a file on your hard disk. The reason for this is that you can make settings for the input bus, adding EQ, effects, etc. to the signal while it is being recorded. This may raise the level of the signal, which causes clipping in the recorded audio file.

Channel Racks

The **Channel Racks** section contains specific **MixConsole** functions, such as routing, insert, or send handling. These are organized in racks.

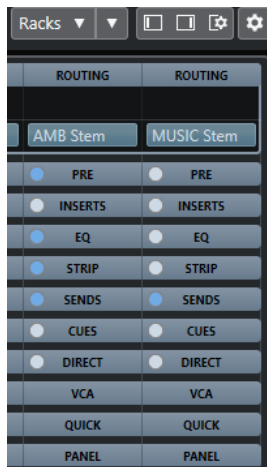

NOTE

The **MixConsole** in the lower zone of the **Project** window features the **Inserts** and the **Sends** rack only.

RELATED LINKS

- [Routing](#) on page 437
- [Pre \(Filters/Gain/Phase\)](#) on page 439
- [Inserts](#) on page 440
- [Equalizers \(EQ\)](#) on page 442
- [Channel Strips](#) on page 445
- [Sends](#) on page 452
- [Cue Sends](#) on page 453
- [Direct Routing](#) on page 454
- [Track Quick Controls](#) on page 456
- [Device Panels](#) on page 457

Copying and Moving Rack and Channel Settings

You can use drag and drop to copy or move rack and channel settings.

NOTE

This function is only available in the **MixConsole** window.

Drag and drop works between different channels or different rack slots on the same channel. When you drag, a visual feedback indicates the sections where you can drop your settings.

The following applies:

- To move the rack settings from one rack to another, drag the rack and drop it on the rack to which you want to move the settings.
- To copy the rack settings from one rack to another, press **Alt/Opt**, drag the rack, and drop it on the rack to which you want to copy the settings.
- To copy the channel settings from one channel to another, drag the channel and drop it on the channel to which you want to copy the settings.

- To copy the channel settings from one channel to another, including the direct routing and output routing settings, press **Alt/Opt**, drag the channel, and drop it on the channel to which you want to copy the settings.

You can copy rack and channel settings between different types of channels, provided that the target channels have corresponding settings.

- For example, copying from input/output channels leaves the sends settings in the target channel unaffected.
- For projects with surround sound, any insert effects that are routed to surround speaker channels become muted when the settings are pasted to a mono or stereo channel.

Routing

The **Routing** rack allows you to configure input and output routing, that is, setting up input and output busses.

NOTE

This channel rack is only available in the **MixConsole** window.

Input busses are used when you record on an audio track. In this case, you must select from which input bus the audio is received.

NOTE

The settings that you make for the input channel will be a permanent part of the recorded audio file.

Output busses are used when you play back an audio, group, or FX channel. In this case, you must route the channel to an output bus.

Setting up Routing

You can set up the input and output busses in **Routing** rack of the **MixConsole**.

PREREQUISITE

Set up busses and group channels in the **Audio Connections** window.

PROCEDURE

1. On the **MixConsole** toolbar, click **Racks** and activate **Routing** to show the **Routing** rack above the fader section.
 2. Click one of the slots of the **Routing** rack to open the input or the output routing pop-up menu for a channel.
 3. In the routing selector, select an entry.
 - To set up the routing for multiple selected channels simultaneously, press **Shift-Alt/Opt** and select a bus.
 - To set several selected channels to incrementing busses (the second selected channel to the second bus, the third to the third bus, etc.), press **Shift** and select a bus.
 - To disconnect input or output bus assignments, select **No Bus**.
-

Input Busses

The input routing selector only lists busses that correspond to the channel configuration.

NOTE

If you select a group channel as input for an audio channel, you can record a downmix.

Input Routing Configurations for Mono Channels

For mono channels, the following input routing configurations are available.

- Mono input busses or individual channels within a stereo or surround input bus.
- External inputs that are configured on the **Control Room** tab of the **Audio Connections** window.
These can be mono or individual channels within a stereo or surround bus. They can also be routed to the **Talkback** input.
- Mono output busses, mono group output busses, or mono FX channel output busses.
These should not lead to feedback.

RELATED LINKS

[Routing](#) on page 437

Input Routing Configurations for Stereo Channels

For stereo channels, the following input routing configurations are available.

- Mono or stereo input busses or stereo child busses within a surround bus.
- External inputs that are configured on the **Control Room** tab of the **Audio Connections** window.
These can be mono input busses or stereo input busses. They can also be routed to the **Talkback** input.
- Mono or stereo output busses, mono or stereo group output busses, and mono or stereo FX channel output busses.
These should not lead to feedback.

RELATED LINKS

[Routing](#) on page 437

Input Routing Configurations for Surround Channels

For surround channels, the following input routing configurations are available.

- Surround input busses.
- External inputs that are configured on the **Control Room** tab of the **Audio Connections** window.
These must have the same input configuration.
- Output busses.
These must have the same input configuration and should not lead to feedback.

RELATED LINKS

[Routing](#) on page 437

Output Busses

For output busses any assignment is possible.

You can route the output of audio, instrument, group, FX and rewire channels to output, group, FX channels, or use it as effect side-chain source.

Routing the outputs from multiple audio channels to a group allows you to control the channel levels using one fader, and to apply the same effects and equalization to all the channels.

Using Group Channels

You can route the outputs from multiple audio channels to a group. This enables you to control the channel levels using one fader, apply the same effects and EQ to all channels, etc. You can also select a group channel as input for an audio track, to record a downmix of separate tracks, for example.

PREREQUISITE

You have created and set up a group channel track in stereo.

PROCEDURE

1. Route the group channel track to an output bus.
2. Add effects to the group channel as insert effects.
3. Route the mono audio track to the group channel.

RESULT

The signal from the mono audio track is sent directly to the group, where it passes through the insert effect in stereo.

Pre (Filters/Gain/Phase)

The **Pre** rack for audio-related channels features a high-cut and a low-cut filter as well as gain and phase settings.

NOTE

This channel rack is only available in the **MixConsole** window.

For MIDI channels, the **Pre** rack allows you to open the **Input Transformer**.

NOTE

You cannot edit the **Pre** rack settings in the EQ curve display.

RELATED LINKS

[Input Transformer Window](#) on page 881
[Equalizer Settings](#) on page 443

Making Filter Settings

Each audio-related channel has separate high-cut and low-cut filters that allow you to attenuate signals with frequencies that are higher or lower than the cutoff frequency.

PROCEDURE

1. On the **MixConsole** toolbar, click **Racks** and activate **Pre (Filters/Gain/Phase)** to show the **Pre** rack above the fader section.

2. Click to the left of the high-cut filter to activate the high-cut filter. You have the following options:
 - Drag the slider to adjust the cutoff frequency.
The available range spans from 20 kHz to 50 Hz.
 - Click **Select Filter Slope** on the right of the high-cut filter to select a filter slope.
You can choose between 6, 12, 24, 36, and 48 dB. The default value is 12 dB.
 3. Click to the left of the low-cut filter to activate the low-cut filter. You have the following options:
 - Drag the slider to adjust the cutoff frequency.
The available range spans from 20 Hz to 20 kHz.
 - Click **Select Filter Slope** on the right of the low-cut filter to select a filter slope.
You can choose between 6, 12, 24, 36, and 48 dB. The default value is 12 dB.
-

RESULT

The changed settings are visible in the curve display. If you deactivate the high-cut and low-cut filters, the filter curves are removed from the display. Bypassed high-cut and low-cut filters are displayed in a different color.

Making Input Gain Settings

The **Pre-Gain** slider allows you to change the level of a signal before it reaches the EQ and the effects section. This is useful as the level going into certain effects can change the way the signal is affected. A compressor, for example, can be driven harder by raising the input gain. Gain can also be used to boost the level of poorly recorded signals.

PROCEDURE

1. On the **MixConsole** toolbar, click **Racks** and activate **Pre (Filters/Gain/Phase)** to show the **Pre** rack above the fader section.
 2. Drag the **Gain** slider to the left or to the right to cut or boost the gain.
-

Making Phase Settings

Each audio-related channel and input/output channel has a **Phase** button that allows you to correct the phase for balanced lines and microphones that are wired backwards or that are out of phase due to their positioning.

PROCEDURE

1. On the **MixConsole** toolbar, click **Racks** and activate **Pre (Filters/Gain/Phase)** to show the **Pre** rack above the fader section.
 2. Activate **Phase** to invert the phase polarity for the signal.
-

Inserts

The **Inserts** rack for audio-related channels features insert effect slots that allow you to load insert effects for a channel. For MIDI channels you can load MIDI inserts.

For further information, see the separate document **Plug-in Reference**.

RELATED LINKS

[Audio Effects](#) on page 502

Adding Insert Effects

You can add insert effects to **MixConsole** channels.

PROCEDURE

1. On the **MixConsole** toolbar, click **Racks** and activate **Inserts** to show the **Inserts** rack above the fader section.
2. Click one of the insert slots to open the insert selector.
3. Click an insert effect to select it.

RESULT

The selected insert effect is loaded and automatically activated. Its plug-in panel opens.

Changing the Number of Pre-Fader/Post-Fader Slots

For each audio-related channel, you can add pre-fader and post-fader inserts, and you can adjust their number.

PROCEDURE

- Do one of the following:
 - Right-click an insert effect in a pre-fader position, and from the context menu, select **Set as last Pre-Fader Slot**.
 - Click and drag the separator for pre-/post-fader slots up or down.

RESULT

The number of pre-fader and post-fader slots is adjusted. The color and the separator line show which effect is pre-fader and which is post-fader.

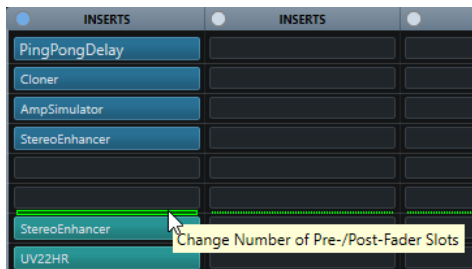

Bypassing Insert Effects

You can bypass all insert effects.

- To bypass all inserts, click **Bypass** at the top of the **Inserts** rack.
- To bypass a single insert, click the button on the left of the inserts slot.
- To deactivate bypass, click the button again.

Activating Side-Chaining for Inserts

Some of the inserts feature side-chain functionality.

PROCEDURE

1. Right-click an insert effect.
2. From the context menu, select **Activate/Deactivate Side-Chaining**.

Saving/Loading FX Chain Presets

You can save and load all insert rack settings using FX chain presets. FX chain presets have the file name extension `.fxchainpreset`.

PROCEDURE

- In the top right corner of the **Inserts** rack, open the **Presets** pop-up menu and perform one of the following actions:
 - To save the current settings as a preset, select **Save FX Chain Preset** and name your preset.
 - To load a preset, select **Load FX Chain Preset** and select a preset.

NOTE

You can also apply inserts together with EQ and channel strip settings from track presets. You can load, tag, and save FX chain presets in the **MediaBay**.

RELATED LINKS

[Applying FX Chain Presets](#) on page 544

Equalizers (EQ)

The **Equalizers (EQ)** rack is only available for audio-related channels. It features a built-in parametric equalizer with up to 4 bands for each audio channel.

NOTE

This channel rack is only available in the **MixConsole** window.

Activating Equalizer Bands

On the **EQ** rack, you can activate up to 4 EQ bands for each audio channel.

PROCEDURE

1. On the **MixConsole** toolbar, click **Racks** and activate **Equalizers** to show the **EQ** rack above the fader section.
2. Click **Activate/Deactivate Band** to activate an EQ band.

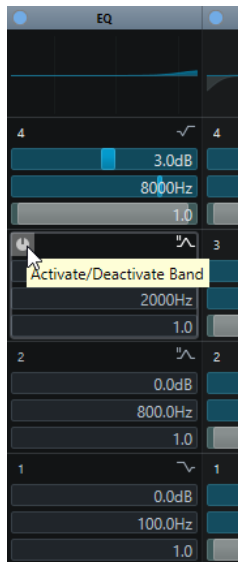

Equalizer Settings

You can make equalizer settings for the 4 bands. These have different default frequency values and different Q names. However, they all have the same frequency range (20 Hz to 20 kHz). You can specify different filter types for each individual module.

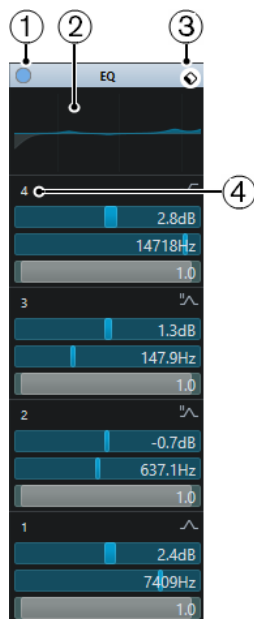

1 Bypass EQ

Click to bypass all EQ bands.

2 Curve display

Click on the display in a channel to show a larger version. The display is also available in the **Equalizers** section of the track **Inspector** in the **Project** window and in the **Channel Settings** window.

Clicking the curve display enlarges the view and shows a cross-hair cursor. The current mouse position shows the frequency, note value, offset, and level at the top or bottom of the display.

- Click to add a curve point and activate the corresponding EQ band.
- Double-click the curve point to deactivate it.

- Drag the curve point up or down to adjust the gain.
- Press **Ctrl/Cmd** to edit only the gain.
- Drag left or right to adjust the frequency.
- Press **Alt/Opt** to edit only the frequency.
- Press **Shift** while dragging to set the Q-factor.
- To invert the EQ curve, open the context menu and select **Invert EQ Settings**.

The final curve shows the EQ settings as well as active high-cut and low-cut filters of the **Pre** rack settings. Bypassed filter settings are shown in a different color than the active settings. Disabled filter settings are hidden from the display.

NOTE

You cannot edit the high-cut and low-cut filters in the curve display. To edit the filters, open the **Pre** rack.

3 Select Preset

Opens a pop-up menu where you can load/save a preset.

4 Activate/Deactivate Band

Click to activate/deactivate an EQ band.

Band Settings

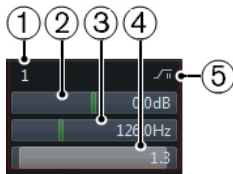

1 Activate/Deactivate Band

Activates/Deactivates the equalizer band.

2 Gain

Sets the amount of cut or boost. The range is ± 24 dB.

3 Frequency

Sets the center frequency of the frequency range to be cut or boosted. You can set the frequency either in Hz or as a note value. If you enter a note value, the frequency is automatically displayed in Hz. For example, a note value of A3 sets the frequency to 440 Hz. When you enter a note value, you can also enter a cent offset. For example, enter A5 -23 or C4 +49.

NOTE

Ensure that you enter a space between the note and the cent offset. Only in this case, the cent offsets are taken into account.

4 Q-Factor

Determines the width of the affected frequency range. Higher values give narrower frequency ranges.

5 Select EQ Band Type

Opens a pop-up menu where you can select an EQ type for the band. Bands 1 and 4 can act as parametric, shelving, or high/low-cut filters. EQ bands 2 and 3 are always parametric filters.

RELATED LINKS

[Making Filter Settings](#) on page 439

Saving/Loading EQ Presets

You can save and load EQ presets.

PROCEDURE

- In the top right corner of the **EQ** rack, open the presets pop-up menu and perform one of the following actions:
 - To save the current settings as a preset, select **Save Preset** and name your preset.
 - To load a preset, select **Load Preset** and select a preset.

NOTE

You can also apply EQ together with insert and channel strip settings from track presets. You can load, tag, and save EQ presets in the **MediaBay**.

Channel Strips

The **Channel Strip** rack is only available for audio-related channels. It allows you to load built-in processing modules for separate channels. You can change the position of specific modules in the signal flow via drag and drop.

NOTE

The **Channel Strip** rack is only available in the **MixConsole** window.

Noise Gate

Allows you to silence audio signals below a set threshold level. As soon as the signal level exceeds the set threshold, the gate opens to let the signal through.

Compressor

Allows you to create smooth compression effects. Drag the compressor up or down to change its position in the signal flow.

EQ

Allows you to make EQ settings.

Tools

Provides various tools.

Sat

Allows you to add warmth to the sound.

Limit

Allows you to avoid clipping even at high levels.

Noise Gate

Noise gating silences audio signals below a set threshold. As soon as the signal level exceeds the threshold, the gate opens to let the signal through.

Threshold

Determines the level at which **Gate** is activated. Signal levels above the set threshold trigger the gate to open, and signal levels below the set threshold close the gate.

Range

Adjusts the attenuation of the gate when it is shut. The higher the value, the higher the level of the signal that passes through the shut gate.

Attack

Sets the time after which the gate opens when it is triggered.

Release

Sets the time after which the gate closes.

Listen Filter

Allows you to monitor the filtered signal.

Activate Filter

Activates/Deactivates the internal side-chain and allows you to set up a filter to modify the signal detection.

Auto Release

Automatically finds the best release setting for the audio material.

Filter Frequency

If the internal side-chain is activated, this parameter sets the filter frequency for the signal detection.

Q-Factor

If the internal side-chain is activated, this parameter sets the resonance of the filter for the signal detection.

State LED

Indicates whether the gate is open (LED lights up in green), closed (LED lights up in red), or in an intermediate state (LED lights up in yellow).

Compressor

This channel strip module reduces the dynamic range of the audio, making softer sounds louder or louder sounds softer, or both.

Open the pop-up menu to select between **Standard Compressor**, **Tube Compressor**, and **VintageCompressor**.

Standard Compressor

The **Standard Compressor** allows you to create smooth compression effects. Drag the compressor up or down to change its position in the signal flow.

Threshold

Determines the level where the compressor kicks in. Only signal levels above the set threshold are processed.

Ratio

Sets the amount of gain reduction that is applied to signals above the set threshold. A ratio of 3:1 means that for every 3 dB the input level increases, the output level increases by 1 dB.

Attack

Determines how fast the compressor responds to signals above the set threshold. If the attack time is long, more of the early part of the signal passes through unprocessed.

Release

Sets the time after which the gain returns to the original level when the signal drops below the threshold.

Auto Make-Up

Automatically adjusts the output for gain loss.

Auto Release

Automatically finds the best **Release** setting for the audio material.

Make-Up Gain

Compensates for output gain loss that is caused by compression.

Gain Reduction LED

Indicates the amount of compression of the signal.

RELATED LINKS

[Standard Compressor – Details View](#) on page 464

Tube Compressor

The **Tube Compressor** with integrated tube-simulation allows you to achieve smooth and warm compression effects. The VU meter shows the amount of gain reduction. This compressor features an internal side-chain section that lets you filter the trigger signal.

Input Gain

Determines the compression amount. The higher the input gain, the more compression is applied.

Output Gain

Sets the output gain.

Gain Reduction LED

Indicates the amount of compression of the signal.

Attack

Determines how fast the compressor responds. If the attack time is long, more of the initial part of the signal passes through unprocessed.

Release

Sets the time after which the gain returns to the original level.

Auto Release

Automatically finds the best **Release** setting for the audio material.

Drive

Controls the amount of tube saturation.

Mix

Sets the level balance between the dry signal and the wet signal.

RELATED LINKS

[Tube Compressor – Details View](#) on page 464

VintageCompressor

The **VintageCompressor** is modeled after vintage type compressors.

Input Gain

In combination with the **Output Gain** setting, this parameter determines the compression amount. The higher the input gain setting and the lower the output gain setting, the more compression is applied.

Output Gain

Sets the output gain.

Attack

Determines how fast the compressor responds. If the attack time is long, more of the early part of the signal passes through unprocessed.

Release

Sets the time after which the gain returns to its original level.

Attack Mode (Punch)

If this option is activated, the early attack phase of the signal is preserved, retaining the original punch in the audio material, even with short **Attack** settings.

Auto Release

Automatically finds the best **Release** setting for the audio material.

Gain Reduction LED

Indicates the amount of compression of the signal.

RELATED LINKS

[VintageCompressor - Details View](#) on page 465

EQ

You can make equalizer settings for the 4 bands. These have different default frequency values and different Q names. However, they all have the same frequency range (20 Hz to 20 kHz). You can specify different filter types for each individual module.

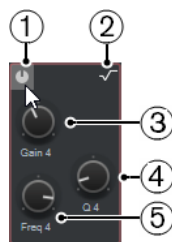

1 Activate/Deactivate Band

Activates/Deactivates the equalizer band.

2 Select EQ Band Type

Opens a pop-up menu where you can select an EQ type for the band. Bands 1 and 4 can act as parametric, shelf, or high/low-cut filters. EQ bands 2 and 3 are always parametric filters.

3 Gain

Sets the amount of cut or boost. The range is ± 24 dB.

4 Q-Factor

Determines the width of the affected frequency range. Higher values give narrower frequency ranges.

5 Frequency

Sets the center frequency of the frequency range to be cut or boosted.

Tools

Provides tools that allow you to reduce sibilance and attenuate or boost the gain of the attack and release phase of your audio.

DeEsser

This channel strip module reduces excessive sibilance, primarily for vocal and speech recordings. Basically, it is a special type of compressor that is tuned to be sensitive to the frequencies

produced by the s-sound. Close proximity microphone placement and equalizing can lead to situations where the overall sound is just right, but there is a problem with sibilants.

Threshold

Sets a threshold for the incoming signal level above which the plug-in starts to reduce the sibilants.

Reduction

Controls the intensity of the de-essing effect.

Auto Threshold

Automatically and continually chooses an optimum threshold setting independent of the input signal. The **Auto Threshold** option does not work for low-level signals (<-30 dB peak level). To reduce the sibilants in such a signal, set the threshold manually.

Release

Sets the time after which the de-essing effect returns to zero when the signal drops below the threshold.

Solo

Allows you to solo the frequency band to find the appropriate position and width of that band.

Diff

Allows you to listen to the sounds that the de-esser removes from the signal.

Low-Frequency

Allows you to set the low frequency band.

High-Frequency

Allows you to set the high frequency band.

Gain Reduction LED

Indicates the amount of compression of the signal.

EnvelopeShaper

This channel strip module can be used to attenuate or boost the gain of the attack and release phase of audio material. You can use the knobs to change parameter values. Be careful with levels when boosting the gain and if needed reduce the output level to avoid clipping.

Attack

Changes the gain of the attack phase of the signal.

Release

Changes the gain of the release phase of the signal.

Attack Length

Determines the length of the attack phase.

Output Gain

Sets the output level.

Sat

Allows you to add warmth to the sound. Open the pop-up menu to select between **Magneto II**, **Tape Saturation**, and **Tube Saturation**.

Magneto II

This channel strip module simulates the saturation and compression of recording on analog tape machines.

Saturation

Determines the amount of saturation and the generation of overtones. This leads to a small increase in input gain.

Low-Frequency

Sets the frequency range of the spectrum band to which the tape effect is applied.
To avoid the saturation of lower frequencies, set the value to 200 Hz or 300 Hz.

HF-Adjust

Sets the amount of high frequency content of the saturated signal.

High-Frequency

Sets the frequency range of the spectrum band to which the tape effect is applied.
To avoid the saturation of very high frequencies, set this parameter to values below 10 kHz.

HF-Adjust On/Off

Activates/Deactivates the **HF-Adjust** filter.

Solo

Allows you to hear only the set frequency range including the tape simulation effect.
This helps you to determine the appropriate frequency range.

Output

Allows you to adjust the output level.

Saturation Amount LED

Indicates the amount of saturation of the signal.

Tape Saturation

This channel strip module simulates the saturation and compression of recording on analog tape machines.

Drive

Controls the amount of tape saturation.

Low-Frequency

This is a low shelving filter with fixed frequency.

High-Frequency

This is a high-cut filter. Use the frequency fader to reduce harshness of the output signal.

Dual

Simulates the use of two tape machines.

Auto Gain

Adjusts the gain automatically.

Output

Sets the output gain.

Drive Amount LED

Indicates the amount of drive of the signal.

Tube Saturation

This channel strip module simulates the saturation and compression of recording of analogue tube compressors.

Drive

Controls the amount of tube saturation.

Low-Frequency

This is a low shelving filter with fixed frequency.

High-Frequency

This is a high-cut filter. Use the frequency fader to reduce harshness.

Output Gain

Sets the output gain.

Drive Amount LED

Indicates the amount of drive of the signal.

Limit

Allows you to avoid clipping even at high levels. Open the pop-up menu to select between **Brickwall Limiter**, **Maximizer**, and **Standard Limiter**.

Brickwall Limiter

Brickwall Limiter ensures that the output level never exceeds a set limit. Due to its fast attack time, **Brickwall Limiter** can reduce even short audio level peaks without creating audible artifacts. However, this channel strip module creates a latency of 1 ms.

Threshold

Determines the level where the limiter kicks in. Only signal levels above the set threshold are processed.

Release

Sets the time after which the gain returns to the original level when the signal drops below the threshold.

Auto Release

Automatically finds the best **Release** setting for the audio material.

Gain Reduction LED

Displays the amount of gain reduction.

Maximizer

This channel strip module raises the loudness of audio material without the risk of clipping.

Optimize

Determines the loudness of the signal.

Mix Amount

Sets the level balance between the dry signal and the wet signal.

Output

Determines the maximum output level. Set this to 0 dB to avoid clipping.

Gain Reduction LED

Displays the amount of gain reduction.

Standard Limiter

This channel strip module is designed to ensure that the output level does not exceed a set output level, to avoid clipping in following devices. **Standard Limiter** can adjust and optimize the **Release** parameter automatically according to the audio material, or it can be set manually.

Input

Adjusts the input gain.

Release

Sets the amount of time it takes for the gain to return to its original level. If **Auto Release** is activated, **Standard Limiter** automatically finds the best release setting for the audio material.

Output

Determines the maximum output level.

Gain Reduction LED

Displays the amount of gain reduction.

Saving/Loading Strip Presets

You can save and load strip presets. Strip presets have the file name extension `.stripreset`.

PROCEDURE

- In the top right corner of the **Channel Strip** rack, open the **Presets** pop-up menu and perform one of the following actions:
 - To save the current settings as a preset, select **Save Strip Preset** and name your preset.
 - To load a preset, select **Load Strip Preset** and select a preset.

NOTE

You can also apply channel strip settings together with insert and EQ settings from track presets. You can load, tag, and save strip presets in the **MediaBay**.

RELATED LINKS

[Loading Strip Presets](#) on page 735

Sends

The **Sends** rack for audio-related channels features send effect slots that allow you to load send effects and value sliders that for determining the send level for a channel. For MIDI channels, the **Sends** rack features send effect slots that allow you to load send effects.

You can use sends to route audio, instrument, group, FX and rewire channels to output, group, FX channels, or use them as effect side-chain sources.

Adding Send Effects

On the **Sends** rack, you can add send effects.

PROCEDURE

1. On the **MixConsole** toolbar, click **Racks** and activate **Sends** to show the rack above the fader section.
2. Click one of the send slots to open the send selector.
3. Click a send effect to select it.

The selected send effect is loaded.

4. Click on the left of the slot to activate the send.
-

Bypassing Send Effects

You can bypass all send effects.

- To bypass all sends, click the bypass button at the top of the **Sends** rack.
- To deactivate bypass, click the button again.

Adding FX Channels to a Send

You can add an FX channel track that is routed to a send from within the **MixConsole**.

PROCEDURE

1. Right-click on the send slot to open the context menu.
 2. Select **Add FX Channel to <send name>**.
 3. In the **Add FX Channel Track** window, select the effect and configuration.
 4. Click **OK**.
-

RESULT

The FX channel track is added in the **Project** window, and the send is automatically routed to it.

Cue Sends

Cue sends allow you to create discrete cue mixes that performers can listen to during recording. Essentially, cue sends are stereo aux sends that are routed to cue channel outputs in the **Control Room**.

NOTE

This channel rack is only available in the **MixConsole** window.

For every cue channel defined in the **Audio Connections** window, each channel in the **MixConsole** has a cue send, with level, pan, and pre/post-fader selection.

Adding Cue Sends

You can add cue sends that are routed to cue channel outputs in the **Control Room**.

PREREQUISITE

Create a cue channel in the **Audio Connections** window and activate the **Control Room**.

PROCEDURE

1. On the **MixConsole** toolbar, click **Racks** and activate **Cue Sends** to show the rack above the fader section.
 2. Click one of the slots to open the send selector.
The cue sends are displayed.
 3. Click on the left of the slot to activate the cue send.
-

RESULT

You can now change the level and pan settings.

Direct Routing

In addition to the main output, the **Direct Routing** rack allows you to set up 7 routing destinations that are positioned post-fader and post-panner in the signal path. This way, you can switch the destination of channels and create different mix versions in one go.

In the **Direct Routing** rack, the first routing slot mirrors the routing of the main output.

Direct routing is available for audio, instrument, sampler, FX channel tracks, groups, and output busses. You can also set and activate outputs for several selected channels at once.

RELATED LINKS

[Setting up Direct Routing](#) on page 454

[Automatic Downmixing](#) on page 455

Setting up Direct Routing

In the **Direct Routing** rack, you can assign up to 8 routing destinations to each channel.

PROCEDURE

1. On the **MixConsole** toolbar, click **Racks** and activate **Direct Routing**.
The **Direct Routing** rack is shown above the fader section.
2. Select all channels for which you want to set up the same destinations, press **Shift - Alt/Opt** and click in the first slot of the **Direct Routing** rack.
3. In the routing selector, select the main output for the selected channels.

NOTE

We recommend that you choose the same set of destinations for all channels that belong together. The main output should also have the widest channel configuration, since it is used as a reference for all additional output destinations.

IMPORTANT

The routing of the main output in the first **Direct Routing** slot defines the channel width. For several functions in Nuendo, for example, **Export Audio Mixdown** or surround panning, to work as expected, the main output routing must be set correctly.

4. Click in the next destination slot and select another output.
 5. Do this for as many destination slots as required (up to 8).
After routing your audio tracks to groups, you can route the groups to output busses.
 6. For each channel, you can now activate the appropriate routing destination by clicking on the corresponding slot.
The active routing destination lights up.
-

Automating Destination Switches

Especially in larger postproduction scenarios you often need to switch the output destinations for audio-related tracks. Automating these switches is especially useful for FX channel tracks that carry insert effects such as reverb that you want to apply to different stems. You can also automate switches if a certain type of sound is sometimes part of the ambience stem and at other times needs to be fed to the SFX stem.

PROCEDURE

1. Play back your project and take note of the positions where routing changes are necessary.

2. Write-enable the corresponding track.
3. At the right moment, click on the routing destination to which you want to switch. The new destination is now active, and the switch has been recorded as automation data.
4. Continue to record destination changes for your project.

NOTE

To switch destinations for multiple channels simultaneously, select these channels and keep **Shift - Alt/Opt** pressed when activating a different destination.

Feeding Signals to Multiple Destinations

Direct routing offers a summing mode, allowing you to feed your signals to several outputs at the same time. This is useful if you want to apply an effect to several stems at the same time, for example.

PROCEDURE

1. Set up your output busses as routing destinations.
2. In the **Direct Routing** rack, open the context menu and activate **Summing Mode** for all channels that you want to sum.

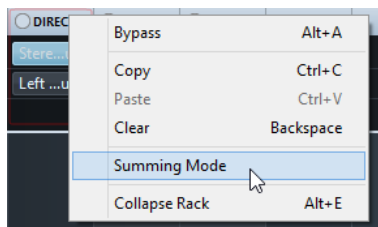

NOTE

To activate this setting for all channels at once use the **Link** function.

3. Activate all outputs to which you want to route the selected channels.
-

RELATED LINKS

[Setting up Routing](#) on page 437

Automatic Downmixing

The output in the first **Direct Routing** slot defines the channel width. Since the other destinations are positioned post-panner in the signal path, they have the same channel width to start with, and the signal needs to be converted accordingly by downmixing. Nuendo does that automatically.

NOTE

Always select the output with the widest channel configuration in the first slot. It is not recommended to use a setup where the main output has fewer channels than the direct routing destination even though it is technically possible. Upmixing might lead to unexpected side effects.

When performing an automatic downmix from 5.1 to stereo, the levels are adjusted as follows:

Automatic Downmixing from 5.1 to stereo

	L	R	C	Lfe	Ls	Rs
L	0.0		-3.01	-3.01	-6.02	
R		0.0	-3.01	-3.01		-6.02

Center and Lfe signals are split into L and R channels, Ls and Rs are sent to L and R respectively, but reduced in volume.

When performing an automatic downmix from 7.1 Music (Dolby) to 5.1, the levels are adjusted as follows:

Automatic Downmixing from 7.1 Music (Dolby) to 5.1

	L	R	C	Lfe	Ls	Rs	Sl	Sr
L	0.0						-3.01	
R		0.0						-3.01
C			0.0					
Lfe				0.0				
Ls					0.0		-3.01	
Rs						0.0		-3.01

Sl and Sr signals are split into L/R and Ls/Rs respectively, but reduced in volume.

Track Quick Controls

Track Quick Controls give you instant access to up to 8 different parameters, for example, track, effect, or instrument controls.

This saves you from having to click your way through the various windows and sections pertaining to your track.

NOTE

This channel rack is only available in the **MixConsole** window.

Adding Track Quick Controls in the MixConsole

You can add **Track Quick Controls** in the **MixConsole**.

PROCEDURE

1. On the **MixConsole** toolbar, click **Racks** and activate **Track Quick Controls** to show the rack above the fader section.
 2. Click one of the slots to open a selector.
 3. Select a parameter from the list.
-

RESULT

The selected parameter is loaded and automatically activated as **Track Quick Control**.

RELATED LINKS

[Parameter Assignment](#) on page 859

Device Panels

You can display device panels, for example, for external MIDI devices, audio track panels, or VST insert effect panels.

NOTE

This channel rack is only available in the **MixConsole** window.

For information on how to create or import MIDI device panels, see the separate document **MIDI Devices**.

RELATED LINKS

[Device Panels](#) on page 897

Adding Notes to a MixConsole Channel

You can add annotations to **MixConsole** channels.

PROCEDURE

1. On the **MixConsole** toolbar, click **Set up Window Layout**, and activate **Notepads**.
The **Notepads** section is shown above the fader section.
 2. Select the channel for which you want to add notes, click in the notepad section and enter your notes.
 3. To close the notepad, press **Esc**, or click in another section of the **MixConsole**.
-

Applying Channel Colors to Channel Controls

You can apply channel colors to the channel controls as well. This is useful if you have many channels in the **MixConsole** and you want to discern them by their color.

PREREQUISITE

You have manually or automatically assigned track/channel colors.

PROCEDURE

1. Select **Edit > Preferences**.
2. Open the **User Interface** page, and select **Track & MixConsole Channel Colors**.
3. In the **Colorize Tracks and MixConsole Channels** section, activate **MixConsole Channels**.
4. Optional: To adjust the brightness of a selected channel, adjust the **Selected Channel Brightness** slider.

NOTE

By default, the selected channel is shown in gray. If you want to display the selected channel in color, activate **Show Color for Selected Channel**. You can then discern it from the other channels by its pronounced color strength.

5. Click **OK**.

RESULT

The channel colors are applied to the channel controls.

RELATED LINKS

[Automatically Assigning Colors to New Tracks/Channels](#) on page 183

[Colorizing Single Tracks](#) on page 95

[Colorizing Selected Tracks](#) on page 95

[User Interface](#) on page 1376

[User Interface - Track & MixConsole Channel Colors](#) on page 1377

Channel Latency Overview

The **Channel Latencies** display the latencies caused by insert effects or channel strip modules for audio-related channels in the **MixConsole**.

- To show the channel latency display in the fader section of the **MixConsole**, click **Set up Window Layout** on the toolbar and activate **Channel Latencies**.
- To open an overview of the latencies for a specific channel, click **Open Channel Latency Overview**.

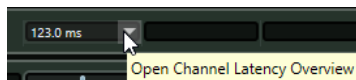

The **Channel Latency Overview** shows the following information:

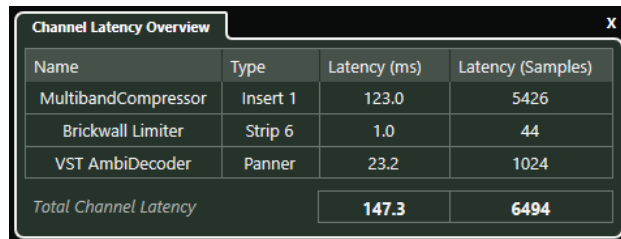
A screenshot of a window titled 'Channel Latency Overview'. It contains a table with the following data:

Name	Type	Latency (ms)	Latency (Samples)
MultibandCompressor	Insert 1	123.0	5426
Brickwall Limiter	Strip 6	1.0	44
VST AmbiDecoder	Panner	23.2	1024
<i>Total Channel Latency</i>		147.3	6494

Name

The name of the effect that causes the latency.

Type

Indicates if the latency is caused by an insert effect, a channel strip module or a panner.

Latency (ms)

Shows the latency in milliseconds.

Latency (Samples)

Shows the latency in samples.

Total Channel Latency

Shows the total latency for that channel in milliseconds and in samples.

NOTE

If you want any plug-in delay to be compensated during playback, make sure that **Constrain Delay Compensation** is deactivated.

RELATED LINKS

- [Plug-In Delay Compensation](#) on page 504
- [Functions Menu](#) on page 427
- [Constrain Delay Compensation](#) on page 846
- [MixConsole Window](#) on page 405

Channel Settings

You can open each **MixConsole** channel in a separate **Channel Settings** window. This allows for better overview and editing of individual channels and their settings.

The channel selection in the **Channel Settings** window is synchronized with the channel selection in the **MixConsole**, and the track selection in the **Project** window.

NOTE

To separate the channel selection in the **Channel Settings** window from the channel selection in the **MixConsole**, open the **Functions Menu** on the toolbar of the **Channel Settings** window, and deactivate **Follow 'e' buttons or selection changes**.

To separate the channel selection in the **Channel Settings** window from the track selection in the **Project** window, deactivate **Sync Selection in Project Window and MixConsole** in the **Preferences** dialog (**Editing—Project & MixConsole** page).

To open the channel settings for an audio-related channel, do one of the following:

- In the fader section of the **MixConsole**, select the channel, and click **Edit Channel Settings**.
- In the track list, select the track, and in the top section of the **Inspector**, click **Edit Channel Settings**.
- In the track list, select the track, and on the track click **Edit Channel Settings**.



The **Channel Settings** window is divided into several sections:

1 **Toolbar**

The toolbar shows tools and shortcuts for settings and functions in the **Channel Settings** window.

2 **Inserts/Strip**

The **Inserts** section features insert effect slots that allow you to load insert effects for a channel. The **Strip** section allows you to load built-in processing modules for separate channels.

3 **Channel Strip/Equalizer**

The **Channel Strip** section allows you to load built-in processing modules for separate channels. The **Equalizer** section features a built-in parametric equalizer with up to 4 bands for each audio channel.

4 Sends/Cue Sends

The **Sends** section features send effect slots that allow you to load send effects. The **Cue Sends** section allows you to create discrete cue mixes that performers can listen to during recording.

5 Direct Routing

The **Direct Routing** section allows you to set up 7 routing destinations that are positioned post-fader and post-panner in the signal path. This way, you can switch the destination of channels and create different mix versions in one go.

6 Fader

The fader section shows the current channel.

7 Output Chain

The output chain allows you to keep track of more complicated output routings.

The sections are arranged in zones at the left and right of the **Channel Settings** window.

RELATED LINKS

[Channel Settings – Channel Inserts](#) on page 462

[Channel Settings – Channel Strip](#) on page 463

[Channel Settings – Equalizer](#) on page 468

[Channel Settings – Channel Sends](#) on page 470

[Channel Settings – Direct Routing](#) on page 471

[Channel Settings – Channel Faders](#) on page 472

[Equalizer Settings](#) on page 443

[Routing Editor](#) on page 511

[Direct Routing](#) on page 454

Channel Settings Toolbar

The toolbar in the **Channel Settings** window contains tools and shortcuts for settings and functions in the **Channel Settings** window.

Channel Navigation

Go to Last Edited Channel



Shows the channel that you last edited in the **Channel Settings** window. This is only available if you have edited at least 2 channels.

Go to Next Edited Channel



Shows the next channel in the **Channel Settings** window. This is only available if you have edited at least 2 channels.

Go to Previous MixConsole Channel



Shows the previous **MixConsole** channel in the **Channel Settings** window.

Go to Next MixConsole Channel



Shows the next **MixConsole** channel in the **Channel Settings** window.

Search Channels



Allows you to search for specific channels and show them in the **Channel Settings** window.

Left Divider

Left Divider

Tools that are placed to the left of the divider are always shown.

Channel Sources

Input

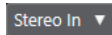

Opens the name of the input channel.

Go to Input/Select an Input



Shows the input channel in the **Channel Settings** window.

Channel Name

Channel Name



Shows the name of the channel that is shown in the **Channel Settings** window.

Channel Destinations

Go to Output/Select an Output



Opens the output channel in the **Channel Settings** window.

Output

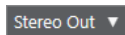

Shows the name of the output channel.

Edit Instrument

Edit VST Instrument



Allows you to open the VST instrument control panel. This is only available for MIDI and instrument channels.

Output Chain

Show Output Chain



Shows the output chain. This allows you to keep track of more complicated output routings.

Track Templates

Load/Save Track Preset



Allows you to load/save track presets.

Reload Track Preset



Allows you to reload track presets.

Channel Functions

Functions Menu



Opens a pop-up menu where you can select a **Channel Settings** function.

Window Zone Controls

Set up Window Layout



Allows you to set up the window layout.

Set up Toolbar



Opens a pop-up menu where you can set up which toolbar elements are visible.

Channel Settings – Channel Inserts

The **Channel Inserts** section is shown in the **Channel Settings** window.

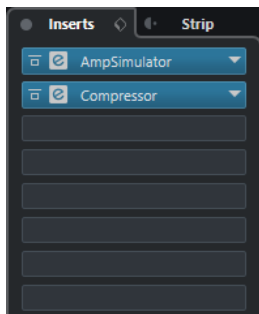

Bypass Inserts

Bypasses the insert effects for the channel.

Inserts

Allows you to add insert effects for the channel.

Preset Management

Allows you to load or save FX Chain presets.

Move Channel Strip to Pre/Post-Inserts Position

Allows you to move the channel strip to pre-fader position or to post-fader position in the signal flow.

Strip

Allows you to activate and set up channel strip modules for the channel.

Routing

Allows you to set up the routing for insert effects.

RELATED LINKS

[Channel Settings](#) on page 459

Channel Settings – Channel Strip

The **Channel Strip/Equalizer** section is shown in the **Channel Settings** window.



Bypass Channel Strip

Bypasses the channel strip modules for the channel.

NOTE

You can reset the channel strip modules for the channel by **Alt/Opt**-clicking this button.

Channel Strip

Allows you to activate and set up channel strip modules for the channel.

Preset Management

Allows you to load or save strip presets.

Channel Strip Modules

The following channel strip modules are shown:

- Noise Gate
- Compressor
- EQ
- Tools
- Sat
- Limit

You can change the position of channel strip modules in the signal chain by dragging.

RELATED LINKS

[Noise Gate](#) on page 445

[Compressor](#) on page 446

[EQ](#) on page 448

[Tools](#) on page 448

[Sat](#) on page 449

[Limit](#) on page 451

[Channel Settings](#) on page 459

Standard Compressor – Details View

The **Standard Compressor** features a details view with more controls and value readouts for the meters.

- To open the details view, click **Edit Module** .



In the details view, the following additional parameters are available:

- Soft Knee/High Ratio
- Hold
- Analysis
- Dry Mix
- Input Gain meter
- Output Gain meter
- Gain Reduction meter

You can close the details view by clicking **Close Module** .

RELATED LINKS

[Standard Compressor](#) on page 446

Tube Compressor – Details View

The **Tube Compressor** features a details view with more controls and value readouts for the meters.

- To open the details view, click **Edit Module** .



In the details view, the following additional parameters are available:

- Character
- Low/High switch for Ratio
- Side-chain section with Frequency, Filter Type, Q-Factor, and Monitor
- Input Gain meter
- Output Gain meter

You can close the details view by clicking **Close Module** **X**.

RELATED LINKS

[Tube Compressor](#) on page 447

VintageCompressor - Details View

The **VintageCompressor** features a details view with more controls and value readouts for the meters.

- To open the details view, click **Edit Module** **e**.



In the details view, the following additional parameters are available:

- Mix
- Ratio buttons
- Input Gain meter
- Output Gain meter
- Gain Reduction meter

You can close the details view by clicking **Close Module** .

RELATED LINKS

[VintageCompressor](#) on page 447

Maximizer – Details View

The **Maximizer** features a details view with more controls and value readouts for the meters.

- To open the details view, click **Edit Module** .



In the details view, the following additional parameters are available:

- **Classic**
This mode is suited for all styles of music.
- **Modern**
This mode is particularly suited for contemporary styles of music. **Release** allows you to set the overall release time, **Recover** allows for a faster signal recovering at the beginning of the release phase.
- **Soft Clip**
Activate this to start limiting or clipping the signal softly and to generate harmonics that add a warm, tube-like characteristic to the audio material.
- **High resolution input/output meter with gain reduction.**

You can close the details view by clicking **Close Module** .

RELATED LINKS

[Maximizer](#) on page 451

Channel Settings – Equalizer

The **Channel Strip/Equalizer** section is shown in the **Channel Settings** window.



Bypass Equalizers

Bypasses the equalizer settings for the channel.

NOTE

You can reset the equalizers by **Alt/Opt**-clicking this button.

Preset Management

Allows you to load or save equalizer presets.

Activate Channel Comparison

Activates the channel comparison mode that allows you to view and edit the spectral curves and EQ settings of two channels at the same time.

Select Reference Channel

Allows you to select the reference channel for the channel comparison. Click **Solo** to solo the channel.

Select Comparison Channel pop-up menu

Allows you to select a channel as comparison channel.

Equalizer Settings

Opens the **Equalizer Settings** panel.

Equalizer display

Allows you to make equalizer settings for the 4 bands in a large EQ curve display with several modes.

Here, you can also view and edit the reference and the comparison channel.

NOTE

You can modify the color settings for the **EQ Reference Channel** and the **EQ Comparison Channel** in the **Preferences** dialog (**User Interface—MixConsole Rack Colors** page).

Equalizer Controls

Allows you to make equalizer settings for the 4 bands in a large EQ curve display with several modes.

RELATED LINKS

[Channel Settings](#) on page 459

Equalizer Settings Panel

The **Equalizer Settings** panel allows you to set up the equalizer.

- To open the **Equalizer Settings** panel, click **Equalizer Settings** in the **Equalizer** section of the **Channel Settings** window.

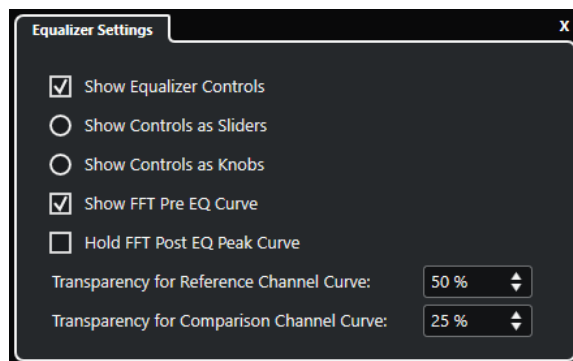

Show Equalizer Controls

Shows/Hides the equalizer controls.

Show Controls as Sliders

Shows the equalizer controls as sliders.

Show Controls as Knobs

Shows the equalizer controls as knobs.

Show FFT Pre EQ Curve

Shows/Hides the FFT (Fast Fourier Transform) input curve for the reference channel.

Hold FFT Post EQ Peak Curve

Holds the peak values of the FFT (Fast Fourier Transform) output curve for the reference channel.

Transparency for Reference/Comparison Channel Curve

Allows you to adjust the transparency of the filled area for the spectral curves. This is useful, if you compare the spectral curves of two channels, and you want to see both spectral curves at once, the curve of the selected channel in the front, and the curve of the other channel in the back.

Comparing Channels

You can compare the EQ settings and the spectral curves of two channels in the equalizer display of the **Channel Settings** window.

PROCEDURE

1. In the **MixConsole**, select a channel that you want to compare to another one, and click **Edit Channel Settings**.
2. In the **Channel Settings** window, open the **Channel Strip/Equalizer** section, and activate the **Equalizer** section.

3. Click **Activate Channel Comparison**, and start playback.
The EQ settings and the spectral curve of the selected reference channel are shown in the EQ display.
4. Open the **Select Comparison Channel** pop-up menu, and select a channel that you want to compare to the reference channel.
Both spectral curves are shown in the equalizer display, and you can compare and edit them.
5. Do one of the following:
 - Adjust the settings for the selected reference channel.
 - Click **Select Comparison Channel**, and adjust the settings for the selected comparison channel.

RESULT

You have now compared and edited the settings for two channels. To compare the reference channel with another channel, open the **Select Comparison Channel** pop-up menu again, and select a new comparison channel.

RELATED LINKS

[Equalizer Settings Panel](#) on page 469

[Channel Settings – Equalizer](#) on page 468

[User Interface](#) on page 1376

Channel Settings – Channel Sends

The **Channel Sends** section is shown in the **Channel Settings** window.

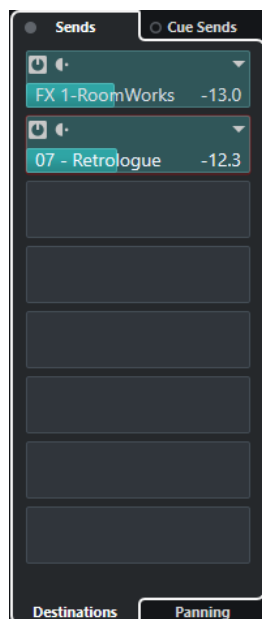

Bypass Sends

Bypasses the send effects for the channel.

Sends—Destinations

Allows you to set up a destination for the send effects for the channel.

Sends—Panning

Allows you to set up panning for the send effects.

Bypass Cue Sends

Bypasses the cue send effects for the channel.

Cue Sends

Allows you to add cue send effects for the channel.

RELATED LINKS

[Channel Settings](#) on page 459

Channel Settings – Direct Routing

You can open the **Direct Routing** section in the **Channel Settings** window.

- To open the **Direct Routing** section in the **Channel Settings** window, click **Set up Window Layout**, and activate **Direct Routing**.

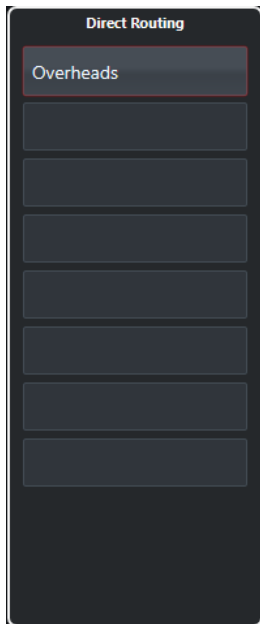

The **Direct Routing** section allows you to set up routing destinations that are positioned post-fader and post-panner in the signal path. This way, you can switch the destination of channels and create different mix versions in one go.

RELATED LINKS

[Channel Settings](#) on page 459

[Direct Routing](#) on page 454

Channel Settings – Channel Faders

The **Channel Faders** section is shown in the **Channel Settings** window.



The controls are the same as in the **MixConsole** fader section.

RELATED LINKS

[Fader Section](#) on page 429

[Channel Settings](#) on page 459

Keyboard Focus in the MixConsole

The left zone, the channel rack section, and the fader section can be controlled with the computer keyboard.

For this to work, the section must have the focus. If a section has the keyboard focus, the border that surrounds it is highlighted in a specific color.

Activating Keyboard Focus

To be able to control the **MixConsole** with the keyboard, you must activate the keyboard focus.

PROCEDURE

1. Click in an empty area of the section to activate the keyboard focus.
 2. Press **Tab** to activate the next section. This allows you to cycle forward through the sections.
 3. Press **Shift-Tab** to activate the previous section.
-

Navigating in a Section

Once you have activated the focus for a section, you can control it with the computer keyboard. In the channel racks section and in the fader section, controls that are selected for keyboard control are indicated by a red border.

- To navigate through the controls, use the **Up Arrow**, **Down Arrow**, **Left Arrow**, or **Right Arrow** keys.

- To activate or deactivate a switch, press **Return**.
- To expand or collapse an active rack, to open or close a value field in a slot, or to open the plug-in panel for a loaded plug-in, press **Return**.
- To access the controls in the left zone, press **Ctrl/Cmd - Return**.
- To access the controls in the middle zone, press **Return**.
- To access the controls in the right zone, press **Alt/Opt - Return**.
- To close a pop-up menu or a plug-in panel, press **Esc**.
- To enable or disable the loaded plug-in, press **Ctrl/Cmd - Alt/Opt - Return**.

VCA Faders

VCA faders serve as remote controls for channel faders in the **MixConsole**.

VCA stands for Voltage-Controlled Amplifier. VCA faders were originally found on hardware mixing desks. They allowed the user to control the volume levels of several mixer channels with only one fader. To assign channel faders to a VCA fader, the respective channels must be physically connected with the VCA fader.

In Nuendo, the VCA fader function is based on the same concept. VCA faders can be connected with different types of audio-related channels. This allows the VCA faders to control the volume of the connected channels. A channel can be connected to only one VCA fader.

From a technical perspective, moving a VCA fader to a different dB level adds or subtracts the new value to or from the original values of the connected channels.

EXAMPLE

A channel has a level of -6 dB, the VCA fader is at the 0 position. If you move the VCA fader to a level of +3 dB, this value is added to the level of the connected channel. The connected channel now has a level of -3 dB.

VCA Fader Settings

VCA fader channels are different from the default fader channels.

VCA faders have no panner. Their fader handles have a color different from the other fader channels. If you change the name and the color of the VCA fader, this is reflected in the connected channels on the VCA rack.

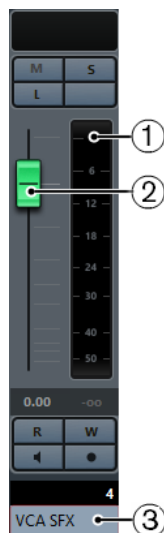

- 1 Peak meter that displays the summed up level of the meters of all connected channels
- 2 Fader handle
- 3 Fader name and color

The **VCA** channel rack provides the following options:

Disconnect All Channels

Disconnects the VCA fader from all connected channels.

Combine Automation of VCA and Connected Channels

Combines the automation of VCA fader and connected channels. This has the effect that the original automation settings of the connected channels are replaced by the combined automation and that the automation of the VCA fader is reset to its original position. In the **Project** window, the automation curve of the VCA fader is reset to the static value line. In the **MixConsole**, the VCA fader is reset to the 0 position.

RELATED LINKS

[VCA Fader Automation](#) on page 476

[Creating Smooth Transitions Between Automation Events \(Bézier Automation Curves\)](#) on page 809

[Link Group Settings Dialog](#) on page 424

Creating VCA Faders in the MixConsole

You can create VCA faders in the **MixConsole**.

PROCEDURE

1. Select **Studio > MixConsole**.
2. Right-click in the fader section, and select **Add VCA Fader**.

RESULT

This creates an unassigned VCA fader, and places it at the right end of the fader section in front of the output channels.

RELATED LINKS

[VCA Rack](#) on page 476

[Creating VCA Faders for a Selection of Channels](#) on page 475

[VCA Fader Track](#) on page 148

[Add Track Dialog – VCA](#) on page 148

Creating VCA Faders for a Selection of Channels

You can select several channels and automatically create and connect a VCA fader.

NOTE

You can also connect VCA faders to a selection of channels using the **VCA** rack.

PROCEDURE

1. Select several channels in the **MixConsole**.
2. Right-click one of the selected channels.
3. In the context menu, select **Add VCA Fader to Selected Channels**.

RESULT

A VCA fader is created and placed to the right of the selected faders. In the **Project** window, the VCA track is placed below the selected tracks.

RELATED LINKS

[Connecting Several Channels with VCA Faders](#) on page 478

Nested VCA Faders

VCA faders can control other VCA faders.

If you use several VCA faders that control different channels, you can create another VCA fader that controls the VCA faders. This allows you to control the volume level of more than one selection of connected channels at the same time.

Technically, a VCA fader that controls other VCA faders affects the volume level of all VCA faders and all connected channels.

EXAMPLE

A VCA fader (main fader) controls a nested VCA fader that has been set to -10 dB. The latter VCA fader controls a connected channel that had an original level of -3 dB and that is set to -13 dB. If you change the main fader level from 0 to +4 dB, the controlled VCA fader is set to a level of -6 dB, and the connected channel is set to a level of -9 dB.

VCA Fader Automation

VCA fader automation affects the volume automation of the connected channels.

VCA faders have their own, independent automation track. Whenever you write automation for a VCA fader, it affects the volume automation of the connected channels. The automation of the connected channels and the VCA fader are combined, which you can hear and see. On the automation tracks of the connected channels, this is visualized as follows:

- If the VCA fader and its connected channel have volume automation, the VCA fader automation influences the existing volume automation of the connected channel. The automation tracks show the original automation and the combined automation of VCA fader and its connected channels.
- If the VCA fader and its connected channels have volume automation and you select **Combine Automation of VCA and Connected Channel** in the context menu of the VCA fader, the automation of the connected channels takes over the combined automation. The automation of the VCA fader is reset to its default position. The automation tracks of the connected channels show the combined automation. The automation tracks of the VCA fader show the default static value line.

RELATED LINKS

[VCA Fader Settings](#) on page 474

[Creating Smooth Transitions Between Automation Events \(Bézier Automation Curves\)](#) on page 809

VCA Rack

The VCA rack allows you to connect channels to VCA faders. You can also let VCA faders control other VCA faders.

The VCA rack is divided into 2 slots. The top slot shows the name and color of the VCA fader that controls the connected channel.

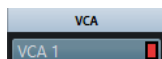

You can select the VCA fader that you want to connect to the channel and activate/deactivate an existing connection to the VCA fader. The top slot is available for channels and VCA faders.

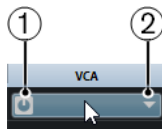

- 1 Activate/Deactivate VCA connections
- 2 VCA selector

The bottom slot shows the number of channels that are connected to a VCA fader. You can activate/deactivate the connection between the VCA fader and the connected channels. The bottom slot is only available for VCA faders.

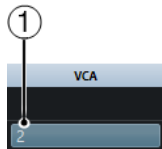

- 1 Activate/Deactivate VCA connections

Activating the VCA Rack

PROCEDURE

1. On the **MixConsole** toolbar, click **Racks**.
2. Activate **VCA**.

RESULT

The **VCA** rack is shown.

Connecting Channels with VCA Faders

PROCEDURE

1. Right-click in the fader section of the **MixConsole**, and select **Add VCA Track** from the context menu.
This creates an unassigned VCA fader.
2. In the **VCA** rack of the channel that you want to connect to the VCA fader, click the top slot.
3. In the VCA selector, select the VCA fader.

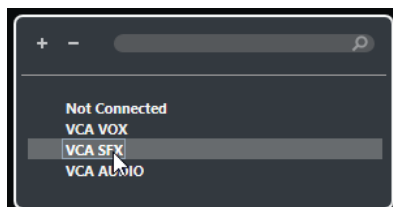

RESULT

The channel is connected to the VCA fader. The **VCA** rack slot of the channel displays the name and the color of the VCA fader. The **VCA** rack slot of the VCA fader displays the number of connected channels.

RELATED LINKS

[Creating VCA Faders in the MixConsole](#) on page 475

Connecting Several Channels with VCA Faders

You can connect several channels to VCA faders at once using **Q-Link**.

PROCEDURE

1. Select several channels in the **MixConsole**, and activate **Q-Link** in the **MixConsole** toolbar.
2. In the **VCA** rack of one of the selected channels, click the top slot.
3. In the VCA selector, select the name of the VCA fader.

RESULT

All channels are connected to the VCA fader. The **VCA** rack slots of the channels display the name and the color of the VCA fader. The **VCA** rack slot of the VCA fader displays the number of connected channels.

RELATED LINKS

[Using Quick Link](#) on page 427

Disconnecting Channels from VCA Faders

PROCEDURE

1. In the **MixConsole**, in the **VCA** rack of the channel that you want to disconnect, click the slot that displays the connected VCA fader.
2. In the VCA selector, select **Not Connected**.
3. Specify if the connected channels keep the combined automation.

RELATED LINKS

[VCA Fader Automation](#) on page 476

Deactivating VCA Connections

You can deactivate the connection between VCA faders and channels temporarily.

Instead of breaking the connection between VCA fader and channels, the connection and automation are suspended until you reactivate the connection. You can deactivate the connection either for a channel or for a VCA fader.

PROCEDURE

- In the VCA rack in the top slot of a VCA fader or a channel, click **Activate/Deactivate VCA Connection**.

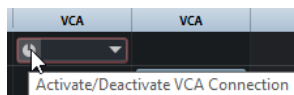

RESULT

If you deactivate the connection for a channel, only the channel loses the connection temporarily. The connection between the VCA fader and the other channels remains intact.

If you deactivate the connection for a VCA fader, the connection to all connected channels is suspended.

Control Room

The **Control Room** allows you to divide the studio environment into the performing area (studio) and the engineer/producer area (control room).

To open the **Control Room**, you have the following options:

- To open the **Control Room** in a separate window, select **Studio > Control Room**.
- To open the **Control Room** section in the **MixConsole** window, click **Show/Hide Right Zone** on the **MixConsole** toolbar.
- To open the **Control Room** section in the **Project** window, click **Show/Hide Right Zone** on the **Project** window toolbar.

The **Control Room** is divided into 2 sections.

- The **Main** tab contains all controls that you use regularly during recording, mixing, and mastering, for example.
- The **Inserts** tab contains settings that you most probably use only once for a project.

RELATED LINKS

[MixConsole Toolbar](#) on page 410

[Project Window Toolbar](#) on page 48

Adding Channels to the Control Room

To be able to use the **Control Room**, you must add the channels that you need first.

PROCEDURE

1. Select **Studio > Audio Connections**.
2. Click **Control Room**.
3. Click **Add Channel**.

A pop-up menu lists all available channel types and shows how many instances of each type are available.

4. Select a channel type.
For most channel types, a dialog opens that allows you to choose the channel configuration.
5. Click the **Audio Device** column to set an audio device for the channel type.
6. Click the **Device Port** column to assign a port for the channel.

IMPORTANT

You cannot assign the same device port to a bus or channel and a **Control Room** channel at the same time.

RESULT

The **Control Room** functions are available for use. If you disable the **Control Room**, the configuration is saved and will be restored when you reenables the **Control Room**.

Output Routing

For the **Control Room** to function correctly, you must assign the **Main Mix** bus to the set of outputs that contains the mix that you want to hear.

If you only have one output bus, it automatically becomes the **Main Mix**. All other outputs are not routed through the **Control Room**.

The channel width of the **Control Room** can only be as wide as the **Main Mix** bus.

All other outputs are not routed through the **Control Room**.

However, they can be added as additional monitor sources in the **Audio Connections** window. When the **Control Room** is enabled, the **Main Mix** bus is automatically shown on the **Control Room** tab. The reason is that the **Main Mix** is always available as a monitor source in the **Control Room**.

Exclusive Assignment of Monitor Channels

Generally, the port assignment to the **Control Room** channels is exclusive. However, it can be useful to create monitor channels that share device ports with each other as well as inputs and outputs. This can be helpful if you use the same speakers as a stereo pair and also as the left and right channels of a surround speaker configuration, for example.

Switching between monitors that share device ports is seamless, multi channel audio is mixed down to stereo as needed. Only one monitor set can be active at a time.

If your scenario does not require you to assign ports to several monitor channels, it is recommended to activate the **Exclusive Device Ports for Monitor Channels** option in the **Preferences** dialog (**VST—Control Room** page). This way, you make sure that you do not accidentally assign ports to inputs/outputs and monitor channels at the same time.

IMPORTANT

The state of the **Exclusive Device Ports for Monitor Channels** preference is saved together with the **Control Room** presets. Therefore, if you recall a preset, your current setting in the **Preferences** dialog might be overwritten.

Control Room Channels

Each **Control Room** channel type that you create defines an input or output of the **Control Room**.

Monitor Channels

A monitor channel represents a set of outputs that are connected to monitor speakers in the **Control Room**.

You can create up to 4 monitor channels for a mono, stereo, or surround speaker configuration. Each monitor can have its own custom downmix settings, input gain, and input phase settings.

NOTE

Monitor channels can share hardware inputs or outputs with another bus or channel. When you create the connections for the monitor channels, device ports that are already used for other busses or channels are shown in red on the **Device Port** pop-up menu. If you select a used port, its previous connection is lost.

Monitor Sources

You can set up different monitor sources and use the **Control Room Mixer** to select the mix sources that you want to listen to. Different monitor sources for dialogue, sound effects, and music are useful in post production setups that require more than one mix bus.

You can create up to 8 monitor sources for a mono, stereo, or surround speaker configuration. These can be input or output busses that you set up in the **Inputs/Outputs** tab of the **Audio Connections** window, or a group channel.

IMPORTANT

If you select a monitor source with a wider configuration than the main mix bus, automatic downmixing occurs.

Phones Channel

You can use the phones channel in the **Control Room** to listen to cue mixes.

You can create 1 phones channel for a stereo configuration. It allows you to listen to the main mix or cue mixes or to external inputs on a pair of headphones. You can also use it for previewing.

Cue Channels

You can use cue channels for sending cue mixes, also known as headphone mixes, to performers in the studio during recording.

You can create up to 4 cue channels in mono or stereo for 4 discrete cue mixes. Cue channels have talkback and click functions. They allow you to monitor the main mix, external inputs, or a dedicated cue mix.

EXAMPLE

If you have 2 available headphone amplifiers for performers, you can create 1 cue channel for each cue mix and name them according to their function: vocalist mix, bass player mix, etc.

Cue Channels and Cue Sends

For every cue channel that you define in the **Audio Connections** window, each channel in the **MixConsole** has a cue send with level, pan, and pre/post-fader selection. These cue sends can be used to create discrete cue mixes that performers can listen to.

- To show the cue sends, open the **MixConsole** and activate **Racks > Cue Sends**.

External Inputs

You can use external inputs for monitoring external devices, such as CD players, multi-channel recorders, or any other audio source.

You can create up to 6 external inputs for a mono, stereo, or surround speaker configuration.

NOTE

If you select external inputs as input source of an audio channel, you can record them. In this case, you do not need to assign the device ports to the input channel.

Talkback Channels

You can use talkback channels for communication between the **Control Room** and performers in the studio.

You can create up to 4 talkback channels and assign a mono input channel to each one of them.

You can also use talkback channels as input source for audio tracks and record them. You can route them to each cue channel and use different levels.

You can insert effects like a compressor or limiter on talkback channels. This ensures that erratic levels do not disturb performers and that clear communication with everyone is possible.

NOTE

The **Auto Disable Talkback Mode** option in the **Preferences** dialog (**VST—Control Room** page) allows you to specify how talkback works during playback and recording.

Metering Channel

You can use a metering channel for connecting a hardware metering device.

The metering channel allows you to meter monitoring sources without having the listening volume affect the meter. This channel is a physical ASIO output which feeds the same signal that goes through the meter channel.

NOTE

The metering channel does not appear in the project.

Control Room - Main Tab

The **Control Room Main** tab displays information and controls for the channels that you define on the **Control Room** tab in the **Audio Connections** window.

The **Control Room Main** tab is divided into a number of sections that you open by clicking their header. To open several sections simultaneously, use **Ctrl/Cmd**-click.



External

The **External** section allows you to use external inputs for monitoring external devices. It is only shown if you have added more than one external input in the **Audio Connections** window.

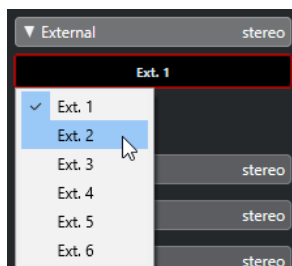

To switch to another external input, click the input name and select a new external input from the pop-up menu.

Monitor Sources

The **Monitor Sources** section allows you to select which monitor sources are routed to the **Control Room**.



1 Multiple Monitor Sources

Allows you to listen to several submixes at the same time. For this to work, you must activate the monitor sources that you want to include.

2 Monitor Sources

Allows you to listen to a monitor source. If you want to listen to only one source, deactivate **Multiple Monitor Sources**.

To listen to a monitor source exclusively, even if **Multiple Monitor Sources** is activated, **Alt/Opt**-click a monitor source.

To deactivate several monitor sources, even if **Multiple Monitor Sources** is activated, **Shift**-click the monitor source buttons.

Cue Channel

The **Cue Channel** section allows you to set up cue channels for sending cue mixes.

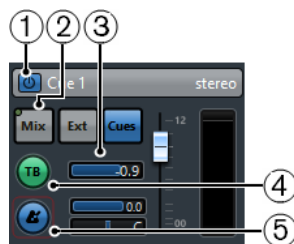

1 Activate Cue Channel

Allows you to activate/deactivate the cue channel.

2 Source selectors

Allow you to select the source for the cue channel: monitor mix (**Mix**), external inputs (**Ext**), or the cue sends (**Cues**). The signal presence indicators in the upper left corner light up when the source channel is sending data to the cue channel.

3 Signal Level

Allows you to set the signal level.

4 Enable Talkback to Cue Channel

Allows you to activate talkback for communication between the **Control Room** and the performers in the studio. You can set the level of the talkback signal with the slider.

5 Activate Metronome Click

Activates the metronome click. Use the **Click Level** and **Click Pan** controls to set the volume and the pan position of the metronome click.

Channels

The **Channels** section shows the speaker arrangement of the **Main Mix** bus.

You can use the solo functions to listen to individual channels of the **Main Mix**. You can also use this to test your multi-channel speaker system and make sure that the correct channels are routed to the speakers.

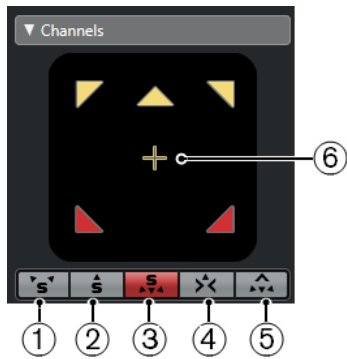

1 Solo Left and Right Channels

Allows you to solo the left and right channels.

2 Solo Front Channels

Allows you to solo the front channels.

3 Solo Surround Channels

Allows you to solo the surround channels.

4 Listen to Solo Channels on Center Channel

Allows you to listen to all soloed speakers in the center channel. If the center channel is not available, the channels are distributed equally to the left and right.

5 Listen to Surround Channels on Front Channels

Allows you to solo the surround channels and route them to the front speakers.

6 Solo LFE Channel

Allows you to solo the LFE channel.

To open the **Main Mix** bus in the **MixConvert V6** plug-in, double-click the channel display.

RELATED LINKS

[MixConvert V6](#) on page 764

Monitors

The **Monitors** section allows you to select and configure the monitor sets.

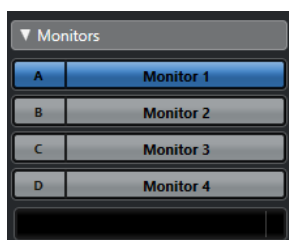

Downmix Presets

The **Downmix Presets** section allows you to configure downmix presets.

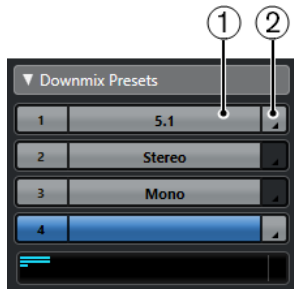

1 Assign Downmix Preset

Allows you to configure a downmix preset for the monitor that is selected in the **Monitors** section.

2 Select Output Configuration

Allows you to select an output channel configuration. You can also select **Open/Close MixConvert** or **Open/Close Ambisonics Decoder** to open **MixConvert V6** or **VST AmbiDecoder**.

RELATED LINKS

[MixConvert V6](#) on page 764

[VST AmbiDecoder Panel](#) on page 795

Phones

The **Phones** section allows you to use the phones channel in the **Control Room** to listen to cue mixes.

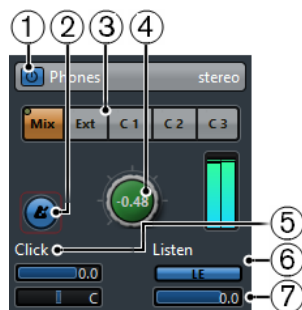

1 Activate Phones Channel

Allows you to activate/deactivate the phones channel.

2 Activate Metronome Click

Activates/Deactivates the metronome click.

3 Source selectors

Allow you to select the source for the phones channel: monitor mix (**Mix**), external inputs (**Ext**), or the cue sends (**Cues**). The signal presence indicators in the upper left corner light up when the source channel is sending data to the phones channel.

4 Phones Level

Allows you to set the phones level. **Ctrl/Cmd**-click to set the level to the reference level specified in the **Preferences** dialog (**VST—Control Room** page).

5 Click Level and Click Panning

Use the **Click Level** and **Click Panning** controls to set the volume and the pan position of the metronome click.

6 Enable Listen for Output

Enables the listen bus function.

7 Listen Level

Allows you to set the listen level.

Control Room Channel

The **Control Room** channel is the representation of the bus that is set up as the **Main Mix** bus on the **Outputs** tab in the **Audio Connections** window or the one that is selected as monitor source.

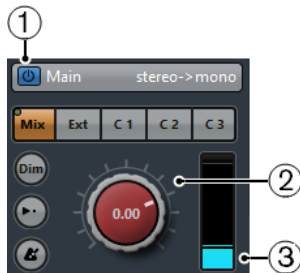

1 Activate Control Room Channel

Allows you to activate/deactivate the **Control Room** channel.

2 Signal Level

Allows you to set the volume for the **Control Room** output. This does not affect the recording input level or the **Main Mix** level for exporting mixdowns. **Ctrl/Cmd**-click to set the level to the reference level specified in the **Preferences** dialog (**VST—Control Room** page).

3 Signal meter

Shows the volume for the **Control Room** output.



1 Source selectors

Allow you to select the source for the **Control Room** channel. The available sources depend on the channels that you added to the **Control Room**. The signal presence indicators in the

upper left corner light up when the source channel is sending data to the **Control Room** channel.

2 Dim Signal

Activate this to lower the **Control Room** level by a fixed amount. This allows a quick reduction in monitor volume without disturbing the current monitor level. Clicking **Dim** again returns the monitor level to the previous setting.

3 Use Reference Level

Enable this button to set the **Control Room** level to the reference level specified in the **Preferences** dialog (**VST—Control Room** page). The reference level is the level that is used in calibrated mixing environments, such as film dubbing stages.

4 Activate Metronome Click

Activates the metronome click.

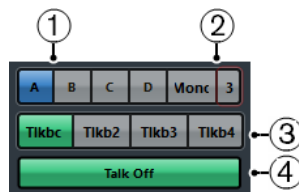

1 Monitor selectors

Allow you to select another monitor source.

2 Downmix Preset selectors

Allow you to select another downmix preset.

3 Activate Talkback

Allows you to activate talkback for communication between the **Control Room** and the performers in the studio. Click to activate, click and hold for momentary mode.

4 Talk Off

If you add more than 1 talkback channel, **Talk Off** becomes available. This allows you to deactivate all activated talkback channels.

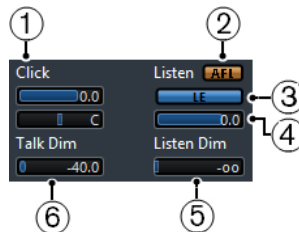

1 Click Level/Click Pan

Use the **Click Level** and **Click Pan** controls to set the volume and the pan position of the metronome click for the **Control Room** channel.

2 AFL/PFL

Allows you to determine whether the signal of a listen-enabled channel is routed to the **Control Room** channel after applying the fader and pan settings **AFL** or before applying the fader and pan settings **PFL**.

3 Enable Listen for Output

Enables the listen bus function for the **Control Room** output.

4 Listen Level

Allows you to adjust the volume of listen bus signals that are routed to the **Control Room** output.

5 Listen Dim

Allows you to adjust the volume of the **Main Mix** or monitor source when channels are in listen mode. This keeps listen-enabled channels in context with the **Main Mix**. If the **Listen Dim** level is set to the minimum value, you only hear the listen-enabled channels.

6 Talk Dim

When **Talkback** is active, this slider controls how much the output of all the channels in the **Control Room** is reduced to prevent unwanted feedback.

Control Room - Inserts Tab

The **Control Room Inserts** tab contains additional settings for the channels.

The **Control Room Inserts** tab is divided into a number of sections that you open by clicking their headers.



Input Gain

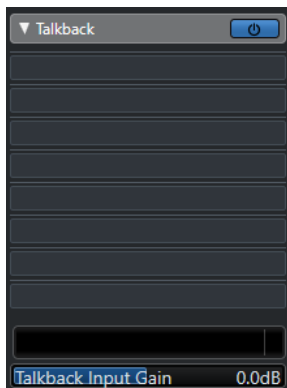

Setting up the input gain can be useful in the following situations:

- To balance the level of external inputs, for example, CD players and other sources to the **Main Mix** level, for A/B comparisons.
- To balance the level of your monitor systems, so that switching between sets of speakers does not change the playback volume.

Input Phase

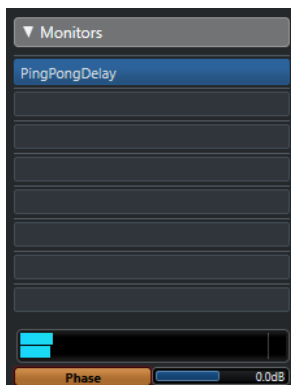

Inverting the input phase can be useful for external inputs and monitor speaker outputs.

Insert Effects

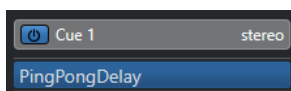

Each **Control Room** channel has a set of insert effect slots.

Control Room Channel Inserts

For metering and spectral analysis plug-ins. All solos including the Listen bus will come through the **Control Room** channel and allow analysis of individual sounds. A brickwall limiter in the last insert slot of the **Control Room** channel can prevent accidental overloads and damage to speaker systems.

Talkback Channel Inserts

To control the dynamics of the talkback microphone. This helps protect performers' hearing and ensures that everyone can be heard over the talkback microphone.

Monitor Inserts

For surround decoding or brickwall limiting to protect sensitive monitor speakers. Each monitor channel has a set of eight inserts, all of which are post **Control Room** faders.

NOTE

You can save the insert slots for **Cue**, **Monitor** and **Control Room** channels by saving a preset on the **Control Room** tab of the **Audio Connections** window. This is useful, as they are not saved with the project.

RELATED LINKS

[Audio Connections Window](#) on page 28

Setting up a Cue Mix

You can create a cue mix from the fader and pan levels that are used in the **MixConsole** and change them to meet the needs of the individual performers.

PROCEDURE

1. In the **MixConsole**, select the channels from which you want to copy the settings.
2. In the **Control Room**, do one of the following:
 - To apply the function only to this cue channel, right-click on a cue channel to open the context menu.
 - To apply the function to all cue channels, click anywhere but on a cue channel to open the context menu.
3. Select **From selected mixer channels** and select one of the functions.

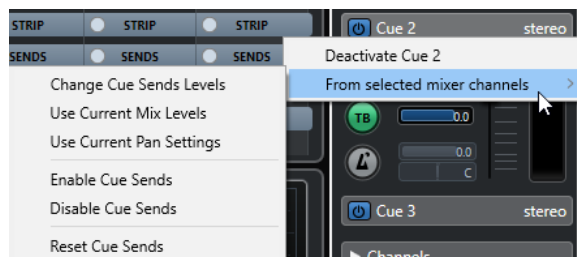

Cue Mix Context Menu

Change Cue Sends Levels

Allows you to adjust multiple send levels at the same time.

Use Current Mix Levels

Allows you to copy the fader levels of the selected tracks to the cue sends. This sets all cue send levels for the selected tracks to the level of the main channel fader. It also changes the cue send status to pre-fader, so that changes in the main mix do not affect the cue sends.

Use Current Pan Settings

Allows you to copy pan information from the main mix to the cue sends of the selected tracks. If the cue send is mono, the pan setting is copied, but the output of the cue send is the sum of the left and right channels.

Enable Cue Sends

Allows you to activate the cue sends of the selected channels. To be able to hear the cue mix for a cue channel, the cue sends must be enabled.

Disable Cue Sends

Allows you to disable the cue sends of the selected channels.

Reset Cue Sends

Allows you to deactivate the cue sends, to change the send level of all selected channels to 0 dB, and to set the signal source to post-fader. This way, any changes to the main mix also change the cue mix. To raise the level of individual cue channels, raise the level on that channel.

Adjusting the Overall Cue Send Level

You can adjust multiple send levels at the same time for the cue send mix, keeping the blend intact while lowering the overall volume. This is sometimes necessary, because the levels in the main mix are often optimized for the loudest possible signal level without clipping.

This means that when you create a “more me” mix, you may find that there is not enough headroom available in the cue send to raise levels without introducing clipping.

PROCEDURE

1. In the **MixConsole**, select the channels that you want to modify.
 2. In the **Control Room**, right-click a cue channel to open the context menu.
 3. Select **From selected mixer channels > Change Cue Sends Levels**.
 4. Activate **Relative Mode**.
This way, you adjust the existing levels. By deactivating **Relative Mode**, all cue sends are set to the same absolute level.
 5. Adjust the level as necessary.
The level of all selected cue sends is adjusted by the set amount.
 6. Click **OK**.
-

Metering and Loudness

Nuendo provides a master meter that works as a multi-channel true peak meter, and a loudness meter that allows you to measure the loudness in compliance with the loudness recommendation R 128 of the European Broadcasting Union (EBU).

Metering

Nuendo provides a master meter and a loudness meter that can be shown in the right zone of the **Project** window and the **MixConsole**, or in a separate window in the **Control Room**.

Master Meter

The master meter is a multi-channel true peak meter.

- To open the master meter, select the **Master** tab at the bottom of the meter display in the **MixConsole** or in the **Control Room**.

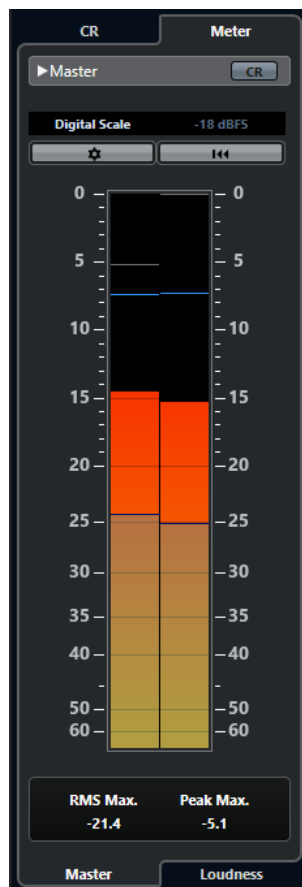

Activate Control Room View

Shows/Hides the **Control Room** section.

Switch between different Peak Program Meter scale standards

Allows you to select a scale according to different broadcast standards (Digital, DIN, EBU, British, Nordic, K-20, K-14, K-12, +3 dB Digital, +6 dB Digital, or +12 dB Digital). The headroom is indicated by red lines in the meter scale.

NOTE

You can customize the appearance of the meter for all scales individually in the **Preferences** dialog (**Metering—Appearance** page).

Alignment level standards

Allows you to select an alignment level (offset) for your scale. This is unavailable for digital and K-System scales. The broadcast meter scales DIN, EBU, Nordic, and British have a default alignment level of -18 dBFS.

Configure Meter Settings

Opens the **Meter Settings** pane. Here, you can change the RMS settings for the master meter.

Reset RMS Max. and PPM Max.

Resets the measurement.

RMS/Peak meter

Shows the RMS and peak hold values as blue lines and the peak values as gray lines.

RMS Max.

Shows the maximum RMS value.

Peak Max.

Shows the maximum peak value.

RELATED LINKS

[Control Room](#) on page 479

[Metering - Appearance](#) on page 1371

[Meter Settings Pane](#) on page 497

Displaying Meters

Meters can be displayed in the right zone of the **Project** window and the **MixConsole**, or in a separate window in the **Control Room**.

PROCEDURE

1. In the **Project** window or in the **MixConsole**, click **Show/Hide Right Zone** to show the right zone with the **Control Room/Meter**.
 2. Click the **Meter** tab at the top of the **Control Room/Meter** section.
By default, the master meter is displayed.
-

Loudness Measurement

Loudness measurements that correspond to the recommendation R 128 of the European Broadcasting Union (EBU) consider loudness, loudness range, and maximum true peak level values.

Loudness Measurement

The following measurements are performed:

- **Integrated Loudness**

Average loudness that is measured over the whole program in LUFS (Loudness Unit, referenced to Full Scale).

According to the loudness recommendation R 128, audio should be normalized at -23 LUFS (± 1 LU).

- **Short-Term Loudness**

Loudness that is measured every second on an audio block of 3 seconds. This gives information about the loudest audio passages.

- **Momentary Loudness**

Maximum value of all momentary loudness values that are measured every 100 ms in an audio range of 400 ms.

Loudness Range

The loudness range measures the dynamic range over the whole program in LU (Loudness Units). It reports the ratio between the loudest and the quietest non-silent sections. The audio is divided into small blocks. There is one audio block every second, and each block lasts 3 seconds so that the analyzed blocks overlap.

The top 10 % of the quiet blocks and the top 5 % of the loud blocks are excluded from the final analysis. The calculated loudness range is the ratio between the loudest and quietest remaining audio blocks. This measurement helps you to decide how much compression or expansion must be applied to the audio.

True Peak

When a digital signal is converted to an analog signal, EBU R 128 recommends that you rather measure an estimation of the real peaks instead of relying on digital peaks. This avoids clipping and distortion.

Naming and Units

EBU R 128 proposes the following naming and units conventions:

- A relative measurement, such as a value that is relative to a reference level, LU as Loudness Unit (1 LU is 1 dB).
- An absolute measurement, LUFS as loudness unit referenced to full scale. 1 LUFS can be understood as 1 dB in the AES17 scaling.

Scales

The loudness meter offers two different scales:

- The EBU +9 scale has a range from -18.0 LU to +9.0 LU (-41.0 LUFS to -14.0 LUFS).
- The EBU +18 scale has a range from -36.0 LU to +18 LU (-59.0 LUFS to -5.0 LUFS).

Loudness Meter

The **Loudness** meter allows you to analyze, measure, and monitor the loudness of your project in real time during playback or mixing.

- To open the loudness meter, select the **Loudness** tab at the bottom of the meter display in the right zone of the **Project** window or the **MixConsole**, or in the **Control Room**.

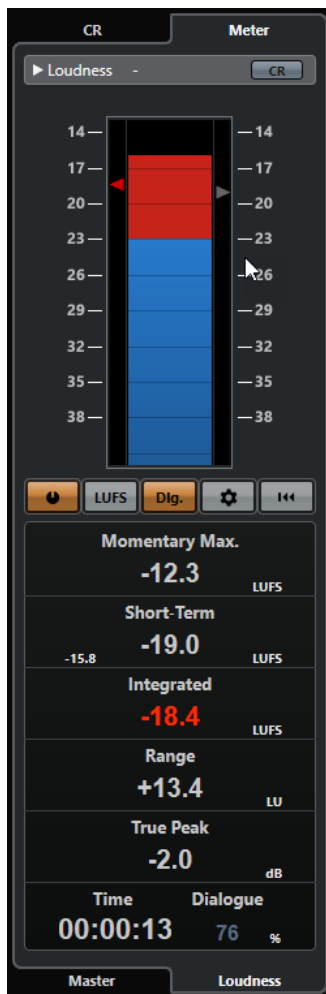

Activate Control Room View

Shows/Hides the **Control Room** section.

Loudness meter

Shows the **Integrated** value as a triangle in the left meter scale and the **Short-Term** value as a triangle in the right meter scale.

Measure Loudness

Activates the loudness measurement.

Switch between LU and LUFs

Switches the meter scale between LUFs (absolute values) and LU (relative values).

Switch Between Program-Gated and Dialogue-Gated Loudness Measurement

Switches between program-gated (EBU R 128) and dialogue-gated (ITU-R BS.1770) loudness measurement.

Configure Loudness Settings

Allows you to specify a threshold value for the **Momentary Max.**, the **Short-Term**, the **Integrated**, and the **True Peak** clipping indicators. If values above the set thresholds are detected, the corresponding indicators turn red.

You can switch the loudness meter between the EBU +9 scale and the EBU +18 scale and make settings for dialogue-gated loudness measurement.

To reset all values on playback start, activate the **Reset on Start** option.

Reset Loudness

Resets all loudness values.

Momentary Max.

Shows the maximum value of all momentary loudness values, based on a time window of 400 ms. The measurement is not gated.

Short-Term

Shows the maximum value of all short-term loudness values, based on a time window of 3 s. The measurement is not gated.

Integrated

Shows the average loudness measured from start to stop. The period of measurement is shown in the **Time** display. The recommended value for the integrated loudness is -23 LUFS. This absolute value is the reference point for the relative LU scale where -23 LUFS equals 0 LU.

Range

Shows the dynamic range of the audio measured from start to stop. This value helps you to decide how much dynamic compression you can apply. The recommended range for highly dynamic audio, such as film music, is 20 LU.

True Peak

Shows the true peak level of the audio. The maximum permitted true peak level in production is -1 dB.

Time

Shows the duration of the integrated loudness measurement.

Dialogue

Shows the percentage of speech that is detected in the audio.

NOTE

This value is only available if dialogue-gated loudness measurement is activated.

You can switch the gating mode in the **Loudness** tab at the bottom of the meter display in the right zone of the **Project** window or the **MixConsole**, or in the **Control Room**.

RELATED LINKS

[Displaying Meters](#) on page 494

[Control Room](#) on page 479

[Metering and Loudness](#) on page 493

[Meter Settings Pane](#) on page 497

Meter Settings Pane

- To open the **Meter Settings** pane, click **Configure Meter Settings** on the **Master** tab or **Configure Loudness Settings** on the **Loudness** tab.

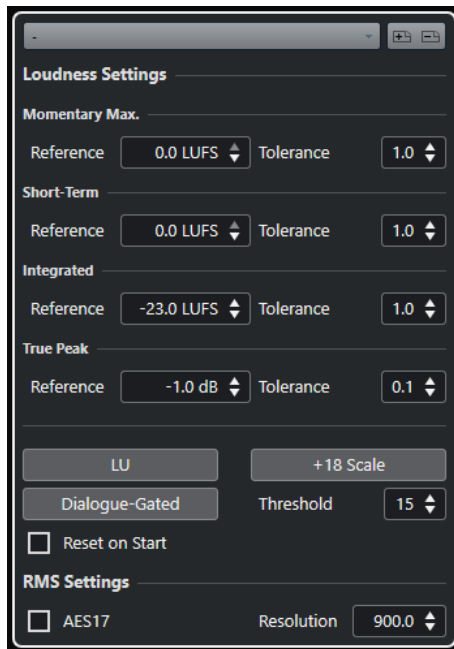

In the **Loudness Settings** section, the following parameters are available:

Save Preset/Remove Preset

Allows you to create, load, and remove loudness presets.

Momentary Max.

Allows you to specify a reference value and a tolerance value for the maximum momentary loudness. If higher values are detected, the clipping indicator in the loudness meter turns red.

Short-Term

Allows you to specify a reference value and a tolerance value for the short-term loudness. If higher values are detected, the clipping indicator in the loudness meter turns red.

Integrated

Allows you to specify a reference value and a tolerance value for the integrated loudness. If higher values are detected, the clipping indicator in the loudness meter turns red.

True Peak

Allows you to specify a reference value and a tolerance value for the true peak level. If higher values are detected, the clipping indicator in the loudness meter turns red.

Switch between LU and LUFS

Allows you to switch the meter scale between LUFS (absolute values) and LU (relative values).

Switch between EBU +9 Scale and EBU +18 Scale

Allows you to switch the meter between the EBU +9 scale and the EBU +18 scale.

Switch Between Program-Gated and Dialogue-Gated Loudness Measurement

Switches between program-gated (ITU-BS.1770-4) and dialogue-gated (ITU-BS.1770) loudness measurement. **Threshold** allows you to specify the percentage of speech in the audio below which program-gated measurement is used automatically.

In the **RMS Settings** section, the following parameters are available:

AES 17

Activates the AES17 standard that adds an offset of 3 dB to the RMS value.

Resolution

Allows you to set the length of audio that is measured and averaged between 1 ms and 1000 ms. Lowering the resolution raises the influence of short passages of loud/weak audio on the RMS value and vice versa.

RELATED LINKS

[Loudness Meter](#) on page 495

[Master Meter](#) on page 493

Loudness Track

The loudness track allows you to record the loudness of your whole project or of specific sections.

- To add a loudness track, select **Project > Add Track > Loudness**.

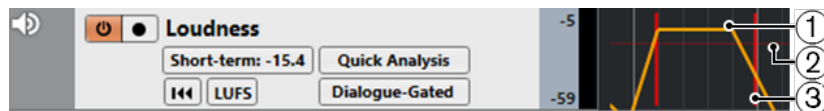

1 Loudness curve

Shows the loudness values that were detected during the loudness measurement.

2 Reference loudness level

Shows the EBU R 128 reference loudness level of -23 LUFs (0 LU).

3 True peaks

Shows the detected true peaks that exceed the reference value that you can set up in the **Loudness Settings** dialog.

RELATED LINKS

[Loudness Track Controls](#) on page 168

[Loudness Track Inspector](#) on page 167

Measuring Short-Term Loudness during Playback

You can record and display the short-term loudness during playback as a curve on the loudness track.

PROCEDURE

1. Select **Project > Add Track > Loudness**.

The loudness track is added to the track list. The EBU 128 reference loudness level of -23 LUFs (0 LU) is displayed as a horizontal line in the event display.

2. In the track list for the loudness track, activate **Activate Loudness Calculation**.

3. Activate **Enable Recording of Loudness Curve**.

4. Play back your project.

RESULT

The short-term loudness level is measured in real time at the cursor position. The corresponding loudness curve is written to the loudness track.

RELATED LINKS

[Loudness Track Controls](#) on page 168

Measuring Short-Term Loudness Offline

You can record and display the short-term loudness for a defined section only on the loudness track using offline analysis.

PROCEDURE

1. Select **Project > Add Track > Loudness**.
The loudness track is added to the track list. The EBU 128 reference loudness level of -23 LUFS (0 LU) is displayed as a horizontal line in the event display.
2. Set up the left and right locators to encompass the section that you want to analyze.
3. In the track list for the loudness track, activate **Activate Loudness Calculation**.
4. Set up the left and right locators to encompass the section that you want to analyze.
5. Click **Quick Analysis**.

RESULT

The loudness curve is created for the defined section and displayed on the loudness track.

RELATED LINKS

[Loudness Track Controls](#) on page 168

Normalizing Loudness on Export

You can normalize your audio to the integrated loudness on export. However, this is only suited for small level deviations and does not compensate for proper mixing.

- To access the **Normalize to Integrated Loudness** settings, select **File > Export > Audio Mixdown**.

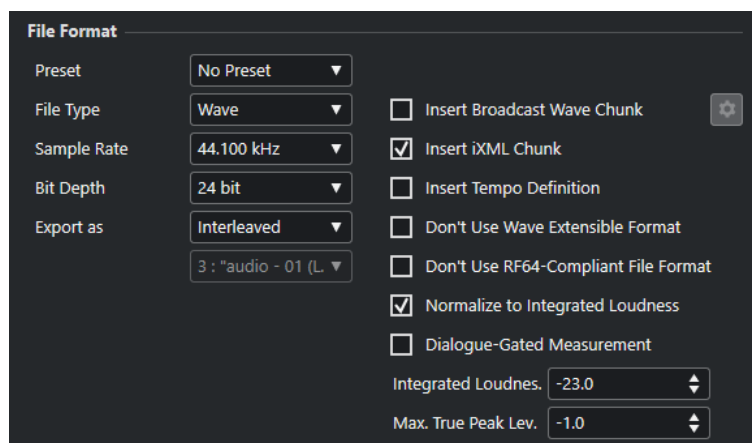

Normalize to Integrated Loudness

Normalizes your audio to the reference value that is specified in the **Integrated Loudness** field below.

Dialogue-Gated Measurement

If this option is activated and at least 15 % of speech are detected, a dialogue-gated loudness measurement according to ITU-R BS.1770-1 is used. If less speech is detected, a program-gated measurement according to ITU-R BS.1770-3 is used.

If this option is deactivated, a program-gated measurement according to EBU R 128 is used.

Max. True Peak Level

Limit the peak level to the value that is specified in the field to the right.

Audio Effects

Nuendo comes with a number of included effect plug-ins that you can use to process audio, group, instrument, and ReWire channels.

The effects and their parameters are described in the separate document **Plug-in Reference**.

Insert Effects and Send Effects

You can apply effects to audio channels by using insert effects or send effects.

NOTE

To apply audio effects to individual audio events, use **Direct Offline Processing**.

Insert Effects

Insert effects are inserted in the signal chain of an audio channel. This way, the whole channel signal passes through the effect.

You can add up to 16 different insert effects per channel.

Use insert effects for effects such as distortion, filters, or other effects that change the tonal or dynamic characteristics of the sound.

To add and edit insert effects, you can use the following inserts sections:

- The **Inserts** rack in the **MixConsole**.

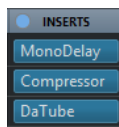

- The **Inserts** section in the **Channel Settings** window.

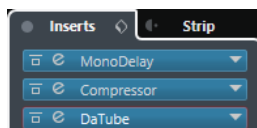

- The **Inserts** section in the **Inspector**.

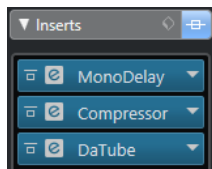

Send Effects

Send effects can be added to FX channel tracks, and the audio data to be processed can be routed to the effect. This way, the send effects remain outside the audio channel's signal path.

Each audio channel has 8 sends, each of which can be freely routed to an effect (or to a chain of effects).

Use send effects in the following cases:

- To control the balance between the dry and wet sound individually for each channel.
- To use the same effect for several different audio channels.

To edit send effects, you can use the following sends sections:

- The **Sends** rack in the **MixConsole**.

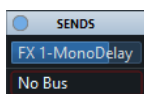

- The **Sends** section in the **Channel Settings** window.

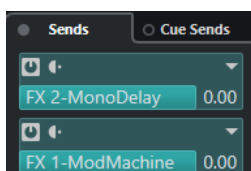

- The **Sends** section in the **Inspector**.

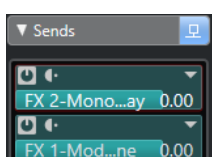

RELATED LINKS

[Direct Offline Processing](#) on page 534

VST Standard

Audio effects can be integrated in Nuendo thanks to the VST standard. At the moment, the VST 3 and VST 2 standards are supported.

The VST 3 plug-in standard offers improvements like smart plug-in processing and side-chain inputs. VST 3 retains full backwards compatibility to VST 2.

Smart Plug-In Processing

Smart plug-in processing is a technology that allows to disengage the processing for plug-ins when no signal is present. This reduces the CPU load on silent passages and allows you to load more effects.

To activate smart plug-in processing, activate **Suspend VST 3 plug-in processing when no audio signals are received** in the **Preferences** dialog (**VST—Plug-ins** page).

NOTE

Check the processor for the passage with the largest number of events playing simultaneously to make sure that your system offers the required performance at every time position.

Side-Chain Inputs

Several VST 3 effects feature side-chain inputs. These allow you to control the operation of the effect via external signals that are routed to the side-chain input.

The effect processing is still applied to the main audio signal.

RELATED LINKS

[Side-Chaining](#) on page 519

Plug-In Delay Compensation

Some audio effects, especially dynamics processors that feature a look-ahead functionality, may take a brief time to process the audio fed into them. As a result, the output audio is slightly delayed. To compensate for this, Nuendo provides plug-in delay compensation.

Plug-in delay compensation is featured throughout the entire audio path maintaining the sync and timing of all audio channels.

VST 3 dynamics plug-ins with look-ahead functionality feature a **Live** button that allows you to disengage the look-ahead. This minimizes latency during real-time recording. For details, see the separate document **Plug-in Reference**.

To avoid latency during real-time recording or real-time playback of VST instruments, you can also use **Constrain Delay Compensation**.

RELATED LINKS

[Constrain Delay Compensation](#) on page 846

[MixConsole Window](#) on page 405

Tempo Sync

Plug-ins can receive timing and tempo information from Nuendo. This is useful to synchronize plug-in parameters, such as modulation rates or delay times, to the project tempo.

Timing and tempo information is provided to plug-ins of the standard VST 2.0 or later.

To set up tempo sync, you must specify a base note value. Straight, triplet, or dotted note values (1/1 to 1/32) are supported.

For details about the included effects, see the separate document **Plug-in Reference**.

Insert Effects

Insert effects can be inserted in the signal chain of an audio channel. This way, the whole channel signal passes through the effect.

You can add up to 16 different insert effects independently for each audio-related channel (audio track, group channel track, FX channel track, instrument channel, or ReWire channel) or output bus.

The signal passes through the insert effects corresponding to their slot position from top to bottom.

You can define post-fader insert slots for any channel. Post-fader insert slots are always post-EQ and post-fader.

NOTE

To show all post-fader slots in the **MixConsole**, open the **Rack Settings** and activate **Fixed Number of Slots**.

Use post-fader slots for insert effects where you want the level to remain unchanged after the effect. Dithering and maximizers are typically used as post-fader insert effects for output busses, for example.

NOTE

If you want to use an effect with identical settings on several channels, set up a group channel and apply your effect as a single insert for this group.

RELATED LINKS

- [Dither Effects](#) on page 523
- [Changing the Number of Pre-Fader/Post-Fader Slots](#) on page 441
- [Adding Insert Effects to Group Channels](#) on page 506
- [Rack Settings Menu](#) on page 423

Adding Insert Effects

If you add insert effects to audio channels, the audio is routed through the insert effects.

PROCEDURE

1. Select the audio track.
2. In the track list, click **Edit Channel Settings**.
The **Channel Settings** window for the audio channel opens.
3. In the **Inserts** section, click the first insert slot on the **Inserts** tab, and select an effect from the selector.

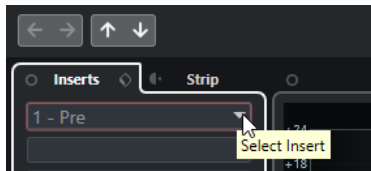

RESULT

The selected insert effect is loaded and activated, and the audio is routed through it. The effect control panel is opened.

RELATED LINKS

- [Effect Control Panel](#) on page 523

Adding Insert Effects to Busses

If you add insert effects to input busses, the effects become a permanent part of the recorded audio file. If you add insert effects to output busses, all audio routed to that bus is affected. Insert effects that are added to output busses are sometimes referred to as master effects.

PROCEDURE

1. Select **Studio > MixConsole** to open the **MixConsole**.
 2. In the fader section, perform one of the following actions:
 - Locate the input channel and click **Edit Channel Settings** to edit the input bus.
 - Locate the output channel and click **Edit Channel Settings** to edit the output bus.The **Channel Settings** window for the selected channel opens.
 3. In the **Inserts** section, click the first insert slot on the **Inserts** tab, and select an effect from the selector.
-

RESULT

The selected insert effect is added to the bus and activated. The effect control panel is opened.

Adding Insert Effects to Group Channels

If you add insert effects to group channels, you can process several audio tracks through the same effect.

PROCEDURE

1. In the global track controls area of the track list, click **Add Track** .
2. Click **Group**.
3. Open the **Audio Outputs** pop-up menu, and select the desired output bus.
4. Click **Add Track**.
The group track is added to the track list.
5. In the **Inspector** for the group track, open the **Inserts** section.
6. Click the first effect slot and select an effect from the selector.
7. In the **Inspector** for the audio tracks, open the **Output Routing** pop-up menus and select the group.

RESULT

The signal from the audio track is routed through the group channel and passes through the insert effect.

RELATED LINKS

[Add Track Dialog – Group Channel](#) on page 143

Adding Group Channels to Selected Channels

You can add a group channel to several selected channels.

PREREQUISITE

Your project contains some tracks that you want to route to a group channel.

PROCEDURE

1. In the track list, right-click the tracks that you want to route to a group channel, and select **Add Track > Group Channel to Selected Channels**.
2. In the **Add Track** dialog, open the **Configuration** pop-up menu, and select a channel configuration for the group channel track.
3. Open the **Folder Setup** pop-up menu, and select if you want to create group channel tracks inside or outside a dedicated folder.
4. Click **OK**.

RESULT

The group channel track is added to the track list. In the **Output Routing** pop-up menu of the selected tracks, the group is selected. The tracks are routed to the group channel.

RELATED LINKS

[Add Track Dialog – Group Channel](#) on page 143

Copying Insert Effects

You can add insert effects to audio channels by copying them from other audio channels or from other slots of the same audio channel.

PREREQUISITE

You have added at least one insert effect to an audio channel.

PROCEDURE

1. Select **Studio > MixConsole**.
2. In the **Inserts** rack, locate the insert effect that you want to copy.
3. Hold down **Alt/Opt**, and drag the insert effect on an insert slot.

RESULT

The insert effect is copied. If the destination slot already contains an insert effect, the previously existing effect is moved down one slot.

Rearranging Insert Effects

You can change the position of an insert effect in the signal chain of the audio channel by moving it to a different slot of the same channel. You can also move an insert effect to another audio channel.

PREREQUISITE

You have added at least one insert effect to an audio channel.

PROCEDURE

1. Select **Studio > MixConsole**.
2. In the **Inserts** rack, locate the insert effect that you want to rearrange.
3. Drag the insert effect to another insert slot.

RESULT

The insert effect is removed from the source slot and placed on the destination slot. If the destination slot already contains an insert effect, this effect is moved to the next insert slot.

Deactivating Insert Effects

If you want to listen to a track without having it processed by an effect, but do not want to remove this effect completely from the insert slot, you can deactivate it.

PREREQUISITE

You have added an insert effect to an audio channel.

PROCEDURE

1. In the track list, select the audio track with the insert effect that you want to deactivate.
2. In the **Inspector**, open the **Inserts** section, and **Alt/Opt**-click **Bypass Insert**.

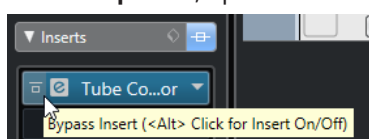

RESULT

The effect is deactivated and all processing is terminated, but the effect is still loaded.

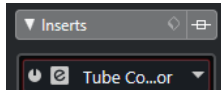

Bypassing Insert Effects

If you want to listen to the track without having it processed by a particular effect, but do not want to remove this effect completely from the insert slot, you can bypass it. A bypassed effect is still processing in the background. This allows for crackle-free comparison of the original and the processed signal.

PREREQUISITE

You have added an insert effect to an audio channel.

PROCEDURE

1. In the track list, select the audio track with the insert effect that you want to bypass.
2. In the **Inspector**, open the **Inserts** section, and click **Bypass Insert**.

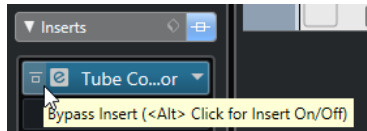

RESULT

The effect is bypassed, but still processing in the background.

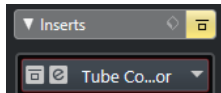

Removing Insert Effects

PROCEDURE

1. In the track list, select the audio track with the insert effect that you want to remove.
2. In the **Inspector**, open the **Inserts** section and on the effect that you want to remove, click **Select Insert**.
3. In the effect selector, select **No Effect**.

RESULT

The insert effect is removed from the audio channel.

Freezing Insert Effects

Freezing an audio track and its insert effects allows you to reduce processor power. However, frozen tracks are locked for editing. You cannot edit, remove, or add insert effects for the frozen track.

PREREQUISITE

You have made all settings for the track and you are sure that you do not need to edit it anymore.

PROCEDURE

1. In the **Inspector** for the audio track that you want to freeze, click **Freeze Audio Channel**.



2. In the **Freeze Channel Options** dialog, specify a **Tail Size** in seconds.
This adds time at the end of the rendered file. This way, reverb and delay tails can fully fade out.

RESULT

The output of the track including all pre-fader insert effects is rendered to an audio file.

The frozen audio track is saved in the **Freeze** folder that can be found in the following location:

- Windows: within the **Project** folder
- macOS: **User/Documents**

In the **MixConsole**, the frozen audio channel is indicated by a snowflake symbol above the channel name. You can still adjust the level and panning, make EQ settings, and adjust the effect sends.

AFTER COMPLETING THIS TASK

To unfreeze a frozen track, click **Freeze** again.

Insert Effects in Multi-Channel Configurations

You can insert VST 2 and VST 3 effects on tracks with a multi-channel configuration. However, not all effect plug-ins support multi-channel processing.

Mono or stereo effects can only process 1 or 2 channels, whereas surround-capable plug-ins are applied to all speaker channels, or to a subset of these.

- To set up to what speaker channels the insert effect is applied, use the **Routing Editor**.

RELATED LINKS

[Routing Editor](#) on page 511

Selecting a Plug-In Input Configuration

For plug-ins that support multi-channel processing, you can select the input configuration.

PROCEDURE

1. Open the control panel.
2. Click **Select requested input configuration**, and from the pop-up menu, select an input configuration.



The first entry is always identical with the channel configuration of the track. Below this, all possible channel subsets of the default configuration that are supported by Nuendo are shown.

RESULT

The selected input configuration is applied.

NOTE

Not all plug-ins support all channel configurations.

Routing Insert Effects through Specific Audio Channels

If you insert a stereo insert effect on a multi-channel track, the first speaker channels of the track are routed through the available effect channels. The other channels remain unprocessed. However, you can route the effect through different speaker channels.

PROCEDURE

1. In the track list, click **Edit Channel Settings** to open the **Channel Settings** window for the track on which the effect is inserted.
2. In the **Inserts** section, click **Routing** to open the **Routing** tab.
3. Double-click the signal diagram for the insert effect to open the **Routing Editor**.

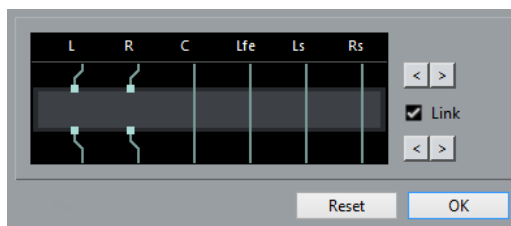

The first speaker channels of the track are routed through the available FX channels.

4. Optional: Activate **Link** to link the input and output channel assignment.
5. Click the arrow buttons to route different speaker channels through the effect.

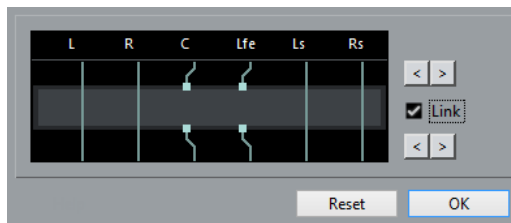

RESULT

The effect is routed through different channels of the audio.

NOTE

To route a stereo plug-in through all 6 channels of a 5.1 track, add 3 instances of it and use different speaker channels for each instance.

RELATED LINKS

[Routing Editor](#) on page 511

Routing Editor

The **Routing Editor** allows you to set up, to what speaker channels the effect is applied to.

- To open the **Routing Editor**, select the track that contains the insert effect, and click **Edit Channel Settings**. In the **Channel Settings** window, click the **Inserts** tab, and then the **Routing** tab. Double-click the signal diagram for the insert effect.

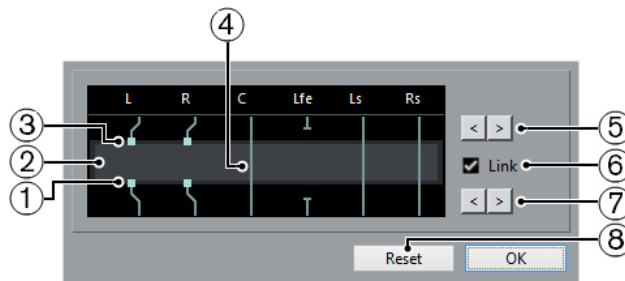

The **Routing Editor** shows the channels in the current configuration, with signals passing from top to bottom.

1 Outputs

The lower squares represent the outputs from the effect plug-in.

2 Effect plug-in

The field in the middle represents the effect plug-in.

3 Inputs

The upper squares represent the inputs to the effect plug-in.

4 Connections

The lines represent the connections.

5 Input channel assignment

These buttons allow you to assign the input channels.

6 Link

Activate this to link the input and output channel assignment.

7 Output channel assignment

These buttons allow you to assign the output channels.

8 Reset

This button allows you to reset the original channel setup.

Routing Connections

In the **Routing Editor**, you can set up the routing connections.

NOTE

You can only make settings in the **Routing Editor** if you route multi-channel audio through an effect that supports fewer channels.

The following connections are possible:

Routing Connection



The audio on the speaker channel is routed through the FX channel and processed by the effect.

Bypass Connection



The audio on the speaker channel passes the effect without being processed.

Broken Connection



The audio on the speaker channel is not sent to the output.

Cross Connection

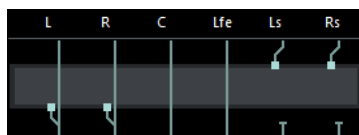

The audio on the specific channels is processed by the effect and output on other channels.

In this example, the audio on the Ls-Rs channels is output on the L-R channels. Since the L-R channels are bypassed, the final L-R output contains both the original L-R signals and the processed Ls-Rs signals.

VST Effect Selector

The VST effect selector allows you to select VST effects of the active collection.

- To open the VST effect selector, open the **Inserts** section of the audio track **Inspector**, and on an insert slot, click **Select Insert**.

The following controls are available:

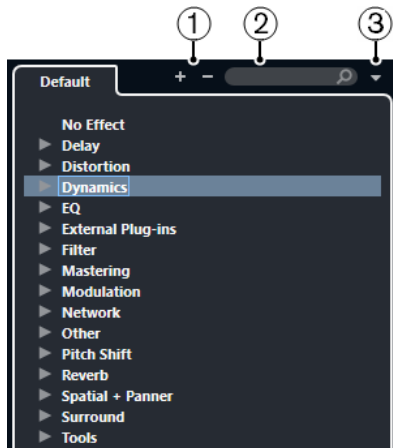

1 Expand Tree/Collapse Tree

Expands/Collapses the tree.

2 Search VST Effect

Allows you to search for VST effects by typing in the name or parts of the name, or the category.

3 Plug-in Collections and Options

Allows you to select a collection.

If you select the **Default** collection, the options **Sort By Category** and **Sort by Vendor** become available. These allow you to sort the default collection.

Send Effects

Send effects are outside the signal path of an audio channel. The audio data that is to be processed must be sent to the effect.

- You can select an FX channel track as routing destination for a send.
- You can route different sends to different FX channels.
- You can control the amount of signals sent to the FX channel by adjusting the effect send level.

NOTE

In the **Preferences** dialog (**VST** page), you can set a default send level. Use **Ctrl/Cmd**-click to set the send level to this default value.

To do this, you must create FX channel tracks.

RELATED LINKS

[FX Channel Tracks](#) on page 513

[VST](#) on page 1378

FX Channel Tracks

You can use FX channel tracks as routing destinations for audio sends. The audio is sent to the FX channel and through any insert effects set up for it.

- You can add several insert effects to an FX channel.
The signal passes through the effects in series, from the top downward.
- You can rename FX channel tracks as any other tracks.

- You can add automation tracks to FX channel tracks.
This allows for automating various effect parameters.
- You can route the effect return to any output bus.
- You can adjust the FX channel in the **MixConsole**.
This includes adjusting the effect return level, the balance, and the EQ.

When you add an FX channel track, you can select if FX channel tracks are created inside or outside a dedicated folder. If you select **Create Inside Folder**, FX channel tracks are shown in a dedicated folder.



This allows for better overview and editing of the FX channel tracks.

NOTE

By folding FX channel folders, you can save screen space.

RELATED LINKS

[Adding FX Channel Tracks](#) on page 514

Adding FX Channel Tracks

PROCEDURE

1. In the global track controls area of the track list, click **Add Track** .
 2. Click **Effect**.
 3. Open the **Effect** pop-up menu, and select an effect for the FX channel track.
 4. Open the **Configuration** pop-up menu, and select a channel configuration for the FX channel track.
 5. Open the **Folder Setup** pop-up menu, and select if you want to create FX channel tracks inside or outside a dedicated folder.
 6. Click **Add Track**.
-

RESULT

The FX channel track is added to the track list and the selected effect is loaded into the first available insert effect slot of the FX channel.

RELATED LINKS

[Add Track Dialog – Effect](#) on page 146

Adding FX Channels to Send Slots

PROCEDURE

1. In the track list, select the tracks to which you want to add an FX channel.
2. In the **Inspector**, open the **Sends** section.
3. Right-click the send slot to which you want to add the FX channel, and select **Add FX Channel to Send**.

4. Open the **Effect** pop-up menu, and select an effect for the FX channel track.
 5. Open the **Configuration** pop-up menu, and select a channel configuration for the FX channel track.
 6. Open the **Folder Setup** pop-up menu, and select if you want to create FX channel tracks inside or outside a dedicated folder.
 7. Click **Add Track**.
-

RESULT

The FX channel track is added to the track send slot.

Adding FX Channels to Selected Channels

PREREQUISITE

Your project contains some tracks to which you want to add an FX channel.

PROCEDURE

1. In the track list, select all tracks to which you want to add an FX channel.
 2. Right-click one of the tracks, and select **Add Track > FX Channel to Selected Channels**.
 3. In the **Add Track** dialog, open the **Effect** pop-up menu and select an effect for the FX channel track.
 4. Open the **Configuration** pop-up menu, and select a channel configuration for the FX channel track.
 5. Open the **Folder Setup** pop-up menu, and select if you want to create FX channel tracks inside or outside a dedicated folder.
 6. Click **OK**.
-

RESULT

The FX channel track is added to the track list. The selected effect is loaded into the first available insert effect slot of the FX channel, and to the first available send effect slot of all channels that you selected.

RELATED LINKS

[Add Track Dialog – Effect](#) on page 146

Adding Insert Effects to FX Channel Tracks

You can add insert effects to FX channel tracks.

PREREQUISITE

You have added an FX channel track and set up the correct output bus in the **Output Routing** pop-up menu.

PROCEDURE

1. In the track list for the FX channel track, click **Edit Channel Settings**. The **Channel Settings** window for the FX channel track opens.
 2. In the **Inserts** section, click an insert slot on the **Inserts** tab, and select an effect from the selector.
-

RESULT

The selected effect is added as an insert effect to the FX channel track.

Routing Audio Channels to FX Channels

If you route an audio channel send to an FX channel, the audio is routed through the insert effects that you have set up for the FX channel.

PROCEDURE

1. Select the audio track.
2. In the track list, click **Edit Channel Settings** to open the **Channel Settings** window.
3. In the **Sends** section, click **Select Destination** for an effect slot, and select the FX channel track from the selector.

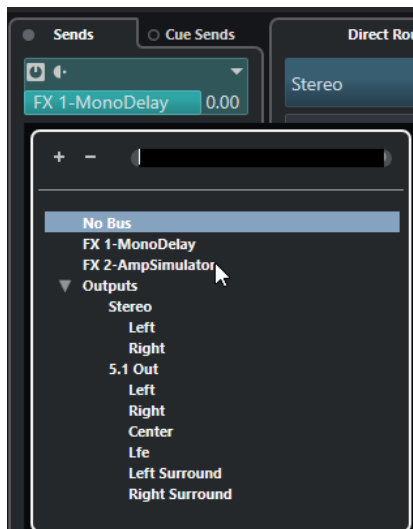

4. On the send slot, click **Activate/Deactivate Send**.

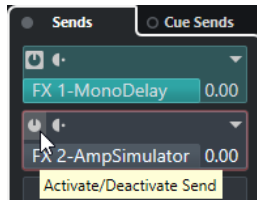

RESULT

The audio is routed through the FX channel.

AFTER COMPLETING THIS TASK

In the **Channel Settings** window for the audio channel, you can hold down **Alt/Opt** and double-click to show the send destination. If you have routed the send to an FX channel, the effect control panel is opened.

RELATED LINKS

[Adding FX Channel Tracks](#) on page 514

Pre/Post Fader Sends

You can send the signal from the audio channel to the FX channel before or after the audio channel volume fader.

- Pre-fader sends
The audio channel signal is sent to the FX channel before the audio channel volume fader.
- Post-fader sends

The audio channel signal is sent to the FX channel after the audio channel volume fader.

- To move a send to pre-fader position, open the **Channel Settings** window for the audio channel, right-click a send and select **Move to Pre-Fader**.

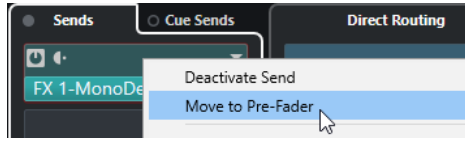

The **Pre-/Post-Fader** button indicates that the send is in pre-fader position.

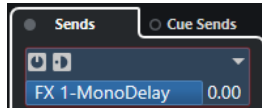

- To move a send to post-fader position, open the **Channel Settings** window for the audio channel, right-click a send and select **Move to Post-Fader**.

The **Pre-/Post-Fader** button indicates that the send is in post-fader position.

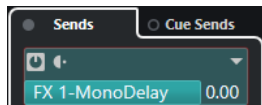

NOTE

If you activate **Mute Pre-Send when Mute** in the **Preferences** dialog (**VST** page), sends in pre-fader mode are muted if you mute their channels.

Setting Pan for the Sends

PROCEDURE

1. Select the audio track.
2. In the track list, click **Edit Channel Settings** to open the **Channel Settings** window.
3. On the **Sends** tab, click **Panning**.
For each send, a pan fader is shown.

NOTE

Depending on the routing, different pan controls are available for the sends.

4. Optional: Open the **Functions Menu** and activate **Link Panners**.

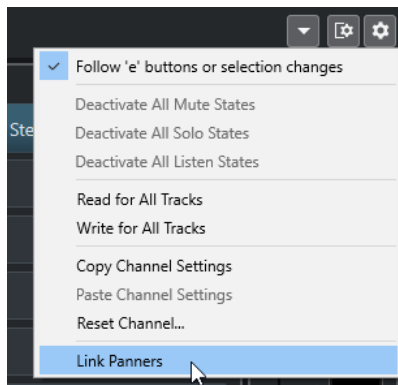

The send panners will then follow the pan for the channel, making the stereo imaging as clear and true as possible.

NOTE

In the **Preferences** dialog (**VST** page), you can set this as a default behavior for all channels.

5. Click and drag the pan control for the send.

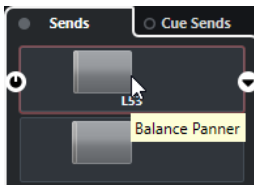

NOTE

You can reset the pan control to the center position by **Ctrl/Cmd**-clicking on the pan control.

RELATED LINKS

[Surround Sound](#) on page 740

Setting the Level for the Sends

PROCEDURE

1. In the track list, select the FX channel track that contains the effect for which you want to set the level.
2. Open the **Inserts** section of the **Inspector** and click the effect slot to open the effect control panel.
3. In the effect control panel, set the **Mix** control to 100.
This allows for full control of the effect level when you use the effect sends to control the signal balance later.
4. In the track list, select the audio track that is routed through the effect for which you want to set the level.
5. Click **Edit Channel Settings** to open the **Channel Settings** window for the audio track.
6. In the **Sends** section, locate the effect slot and drag to the left or right to set the send level. **Ctrl/Cmd**-click to set the level to the default send level specified in the **Preferences** dialog (**VST** page).

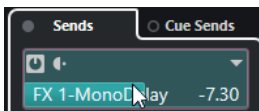

This determines how much of the signal from the audio channel is routed to the FX channel.

RESULT

The effect level is adjusted according to your settings.

NOTE

To determine how much of the signal from the FX channel is sent to the output bus, open the **Channel Settings** window for the FX channel track and adjust the effect return level.

Side-Chaining

Many VST 3 effects support side-chaining. Side-chaining allows you to use the output of one track to control the action of an effect on another track.

Effects from the following categories feature side-chaining:

- Modulation
- Delay
- Filter

By activating side-chaining you can do the following:

- Use the side-chain signal as a modulation source.
- Apply ducking to the instrument, that is, reduce the volume of the instrument track when a signal is present on the audio track.
- Compress the signals on one audio track when a second audio track starts.

This is typically used to add compression on a bass sound when the drums are hit.

NOTE

For detailed descriptions of the plug-ins that feature side-chaining, see the separate document **Plug-in Reference**.

NOTE

- Certain combinations of tracks and side-chain inputs may lead to feedback loops and added latency. If this is the case, the side-chain options are not available.
 - Side-chain connections are only kept when you move an effect within a channel. When you drag and drop an effect between channels, or when you copy an effect into another effect slot, the side-chain connections are lost.
-

Side-Chain and Modulation

Side-chain signals bypass the built-in LFO modulation and apply modulation according to the envelope of the side-chain signal. Since each channel is analyzed and modulated separately, this allows for creating astonishing spatial modulation effects.

RELATED LINKS

[Side-Chain Routing](#) on page 521

[Triggering a Delay Effect with Side-Chain Signals](#) on page 519

[Triggering a Compressor with Side-Chain Signals](#) on page 520

[Creating Side-Chain Connections From Multiple Inputs](#) on page 522

Triggering a Delay Effect with Side-Chain Signals

You can use side-chain signals to create a ducking delay effect. This is useful if you want to apply a delay effect that is audible only when no signal is present on a track.

PROCEDURE

1. Select the audio track that contains the audio you want to delay.
2. Select **Project > Duplicate Tracks**.
The events on the duplicated track are only used to reduce the volume of the effect that is added to the original track.
3. Select the original track.

4. In the **Inspector**, open the **Inserts** section and select **Delay > PingPongDelay**, for example.
5. On the effect control panel, make your effect settings, and click **Activate/Deactivate Side-Chaining**.



6. Click **Set up Side-Chain Routing**.
7. Click **Add Side-Chain Source**, and select the duplicate track from the selector.
8. Optional: Adjust the send level in the **Level** value field.
9. In the **Project** window, select the duplicate track.
10. In the **Inspector**, click **Output Routing** and select the side-chain node for the **PingPongDelay** effect.

RESULT

The signals from the duplicated track are routed to the effect. Every time the audio signals on the track set in, the delay effect is deactivated.

NOTE

To ensure that audio signals of low or medium volume also silence the delay effect, you can adjust the volume of the duplicated track.

RELATED LINKS

[Side-Chaining](#) on page 519

[Side-Chain Routing](#) on page 521

Triggering a Compressor with Side-Chain Signals

Compression, expansion, or gating can be triggered by side-chain signals exceeding a specified threshold. This allows you to lower the volume of one audio signal every time another audio signal sets in.

PREREQUISITE

You have set up a project with a bass guitar and a bass drum track, for example, and you want to lower the bass guitar volume each time the bass drum hits.

PROCEDURE

1. Select the bass guitar track.
 2. In the **Inspector**, open the **Inserts** section.
 3. Click the first effect slot, and from the selector, select **Dynamics > Compressor**.
 4. On the effect control panel, make your effect settings, and click **Activate/Deactivate Side-Chaining**.
 5. On the effect control panel, click **Set up Side-Chain Routing**.
 6. Click **Add Side-Chain Source**, and select the bass drum track from the selector.
 7. Optional: Adjust the send level in the **Level** value field.
-

RESULT

You have connected the bass drum track side-chain to the **Compressor** on the destination track. The bass drum signal triggers the **Compressor** on the bass guitar track. When you now play back the project, the bass guitar is compressed whenever the signals on the bass drum track exceed the set threshold.

RELATED LINKS

[Side-Chaining](#) on page 519

[Side-Chain Routing](#) on page 521

Side-Chain Routing

The **Side-Chain Routing** panel allows you to set up the side-chain routing for the selected plug-in.

- To open the **Side-Chain Routing** panel, click **Set up Side-Chain Routing** on the plug-in control panel.

The following controls are available:

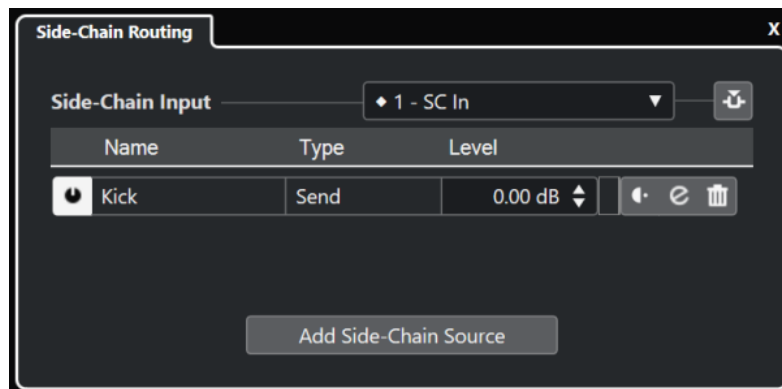

Select the Plug-in Side-Chain Input

This pop-up menu is only available if your plug-in supports several side-chain inputs. From the pop-up menu, select the input for which you want to add a side-chain source. Side-chain plug-in inputs that are routed to side-chain sources are indicated by a rhombus next to the input name. The number of available side-chain inputs depends on the plug-in.

Activate/Deactivate Side-Chaining

Activates/Deactivates the side-chain functionality.

Activate/Deactivate Side-Chain Source

Enables/Disables the side-chain source.

Name

Shows the name of the side-chain source.

Type

Shows the type of the side-chain source.

Level

Allows you to adjust the send level.

Meter

Shows the volume level of the input track.

Pre-/Post-Fader

Allows you to set the insert to pre-fader position or to post-fader position.

Edit Channel Settings

Opens the **Channel Settings** window for the selected side-chain source.

Remove Side-Chain Source

Removes the side-chain source.

Add Side-Chain Source

Opens a selector that allows you to add a side-chain source.

RELATED LINKS

[Side-Chaining](#) on page 519

[Creating Side-Chain Connections From Multiple Inputs](#) on page 522

Creating Side-Chain Connections From Multiple Inputs

For plug-ins that support multiple side-chain inputs, you can create side-chain connections coming from multiple side-chain inputs of that plug-in.

PREREQUISITE

Your effect plug-in supports several side-chain inputs. You can use the **Squasher** plug-in, for example, that supports up to 3 side-chain inputs.

You can also use **Frequency 2** that supports up to 8 side-chain inputs.

PROCEDURE

1. In the **Project** window, select an audio track.
 2. In the track list, click **Edit Channel Settings**.
The **Channel Settings** window for the audio channel opens.
 3. In the **Inserts** section, click the first insert slot on the **Inserts** tab, and from the selector select the effect plug-in that supports several side-chain inputs.
The selected insert effect is loaded and activated, and the audio is routed through it. The effect control panel opens.
 4. On the effect control panel, click **Set up Side-Chain Routing**.
 5. In the **Side-Chain Routing** panel, click **Select the Plug-in Side-Chain Input**, and from the pop-up menu, select the plug-in input for which you want to add a side-chain source.
The number of available side-chain inputs depends on the plug-in.
 6. Click **Add Side-Chain Source** and select a source from the pop-up menu.
 7. Optional: Repeat the steps above to activate more plug-in inputs.
 8. Adjust the effect plug-in as required and do not forget to activate the corresponding side-chain inputs.
-

RESULT

The number of possible side-chain inputs determines the number of bands that can be controlled by side-chain sources.

RELATED LINKS

[Side-Chaining](#) on page 519

[Side-Chain Routing](#) on page 521

Dither Effects

Dither effects allow you to control the noise that is produced by quantization errors that can occur when you mix down to a lower bit depth.

Dithering adds a special kind of noise at an extremely low level to minimize the effect of quantization errors. This is hardly noticeable and preferable to the distortion that otherwise occurs.

Applying Dither Effects

PROCEDURE

1. Select **Studio > MixConsole**.
 2. Open the **Rack Settings** and activate **Fixed Number of Slots**.
 3. Click **Edit Channel Settings** for the output channel.
 4. In the **Inserts** section, click a post-fader effect slot, and select **Mastering > UV22HR**.
 5. On the plug-in panel, select a bit depth for the mixdown file you want to create.
-

RELATED LINKS

[Export Audio Mixdown](#) on page 1162

[Rack Settings Menu](#) on page 423

External Effects

You can integrate external effect devices into the sequencer signal flow by setting up external FX busses.

An external FX bus is a combination of outputs (sends) and inputs (returns) on your audio hardware, along with a few additional settings.

All external FX busses you have created are available on the effect pop-up menus. If you select an external effect as an insert effect for an audio track, the audio is sent to the corresponding audio output, processed in your hardware effect and returned via the specified audio input.

RELATED LINKS

[Audio Connections](#) on page 28

[External Instruments and Effects](#) on page 37

Effect Control Panel

The effect control panel allows you to set up the parameters of the selected effect. The contents, design, and layout of the control panel depend on the selected effect.

- To open the control panel for a plug-in, click the effect slot.

The following controls are available for all effects:



- 1 Activate Effect**
Activates/Deactivates the effect.
- 2 Bypass Effect**
Allows you to bypass the effect.
- 3 Read Automation/Write Automation**
Allows you to read/write automation for the effect parameter settings.
- 4 Switch between A/B Settings**
Switches to setting B when setting A is active, and to setting A when setting B is active.
- 5 Apply current settings to A and B**
Copies the effect parameters of effect setting A to effect setting B, and vice versa.
- 6 Activate/Deactivate Side-Chaining**
Activates/Deactivates the side-chain functionality.
- 7 Set up Side-Chain Routing**
Allows you to set up the side-chain routing for the selected plug-in.
- 8 Preset browser**
Opens the preset browser where you can select another preset.
- 9 Load previous Program/Load next Program**
Loads the previous/next program in the preset browser.
- 10 Preset Management**
Opens a pop-up menu that allows you to save or load a preset.
- 11 Add VST Plug-in Picture to Media Rack**
Adds a picture of the VST plug-in to the **Media** rack. This is only available for plug-ins of other vendors.

12 Routing selector

Allows you to select an input configuration for the effect. To reset the input configuration to its default setting, click **Reset Input Configuration**.

13 Functions menu

Opens a pop-up menu with specific functions and settings.

NOTE

For detailed information about the included effects and their parameters, see the separate document **Plug-in Reference**.

RELATED LINKS

[Hiding/Showing Effect Control Panels](#) on page 526

Effect Control Panel Context Menu

The effect control panel context menu and the **Functions** menu on the effect control panel show functions and settings that are specific for the effect.

Do one of the following:

- Right-click an empty area of the effect control panel.
- Open the **Functions** pop-up menu on the effect control panel.

The following functions are available:

Copy <VST effect name> Setting/Paste <VST effect name> Setting

Allows you to copy the effect settings and paste them to another effect.

Load Preset/Save Preset

Allows you to load/save a preset.

Default Preset

Allows you to define and save a default preset.

Switch to A Setting/Switch to B Setting

Switches to setting B when setting A is active, and to setting A when setting B is active.

Apply Current Settings to A/Apply Current Settings to B

Copies the effect parameters of effect setting A to effect setting B, and vice versa.

Activate Outputs

Allows you to activate one or more outputs for the effect.

Activate/Deactivate Side-Chaining

Activates/Deactivates side-chaining for the effect.

NOTE

This option is only available for VST 3 effect that support side-chaining.

Remote Control Editor

Opens the **Remote Control Editor**.

Switch to Generic Editor

Opens the generic editor for the effect.

Allow Window to be Resized

Allows the dynamic resizing of third-party plug-in windows in Nuendo. This is useful if you activated **Enable HiDPI** (Windows only) in the **Preferences** dialog (**General** page), and your plug-in does not support dpi settings.

NOTE

Allow Window to be Resized is a plug-in-specific setting. You must activate/deactivate it for every plug-in that requires it.

RELATED LINKS

[General](#) on page 1365

[Side-Chaining](#) on page 519

Fine-Tuning Effect Settings

You can take your effect parameter settings as a starting point for further fine-tuning and then compare the new settings with the original settings.

PREREQUISITE

You have adjusted the parameters for an effect.

PROCEDURE

1. On the control panel for the effect, click **Switch between A/B Settings**.
This copies the initial parameter setting A to setting B.
 2. Fine-tune the effect parameters.
These parameter settings are now saved as setting B.
-

RESULT

You can now switch between both settings by clicking **Switch between A/B Settings**. You can compare them, make further adjustments or just go back to setting A. Settings A and B are saved with the project.

AFTER COMPLETING THIS TASK

You can copy the settings between A and B by clicking **Copy A to B**. You can take these settings as a starting point for further fine-tuning.

Hiding/Showing Effect Control Panels

When you add an audio effect, the respective plug-in control panel opens automatically. You can hide the control panels from view. This is useful to get a better overview if you added a number of plug-ins to your project whose control panels clutter up the screen.

PROCEDURE

- Select **Window > Hide Plug-in Windows**.

NOTE

This also hides VST instrument control panels.

RESULT

The control panels are hidden and sent to the back of the application. To show them again, select **Show Plug-in Windows**.

RELATED LINKS

[Effect Control Panel](#) on page 523

Closing All Control Panels

When you add an audio effect, the respective plug-in control panel opens automatically. You can close all control panels at once.

PROCEDURE

- Select **Window > Close All Plug-in Windows**.

NOTE

This also closes VST instrument control panels.

RESULT

The control panels are closed.

RELATED LINKS

[Effect Control Panel](#) on page 523

Effect Presets

Effect presets store the parameter settings of an effect. The included effects come with a number of presets that you can load, adjust, and save.

The following effect preset types are available:

- VST presets for a plug-in.
These are plug-in parameter settings for a specific effect.
- Insert presets that contain insert effect combinations.
These can contain the whole insert effects rack with settings for each effect.

Effect presets are saved in the following location:

- Windows: `\Users\\My Documents\VST 3 Presets\\`
- macOS: `/Users/<user name>/Library/Audio/Presets/<company>/<plug-in name>`

RELATED LINKS

[Loading Presets for Effects](#) on page 528

[Loading Insert Presets](#) on page 531

Preset Browser

The preset browser allows you to select a VST preset for the loaded effect.

- To open the preset browser, click the preset browser field in the effect control panel.

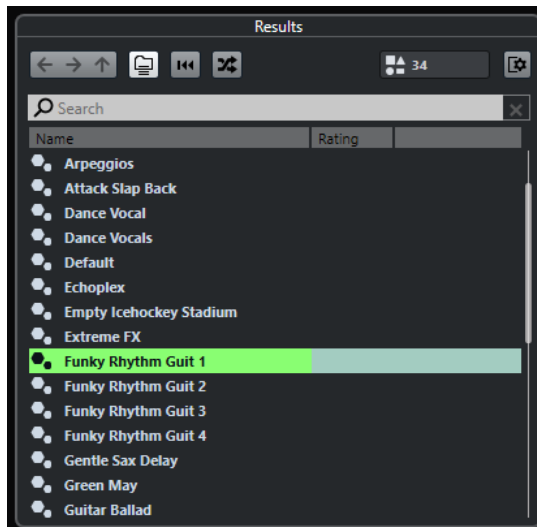

The **Results** section of the presets browser lists the available presets for the selected effect.

Loading Presets for Effects

Most VST effect plug-ins come with a number of useful presets that you can instantly select.

PREREQUISITE

You have loaded an effect, either as a channel insert or into an FX channel, and the effect control panel is open.

PROCEDURE

1. Click the preset browser field at the top of the control panel.



2. In the **Results** section, select a preset from the list.
 3. Double-click to load the preset that you want to apply.
-

RESULT

The preset is loaded.

AFTER COMPLETING THIS TASK

You can return to the preset that was selected when you opened the preset browser by clicking **Revert to Last Setting**.

Saving Effect Presets

You can save your effect settings as presets for further use.

PROCEDURE

1. Open the **Preset Management** pop-up menu.



2. Select **Save Preset**.
The **Save <plug-in name> Preset** dialog opens.
 3. In the **New Preset** section, enter a name for the new preset.
 4. Optional: Click **New Folder** to add a subfolder inside the effect preset folder.
 5. Optional: Click **Show Attribute Inspector** in the bottom left corner of the dialog and define attributes for the preset.
 6. Click **OK**.
-

RESULT

The effect preset is saved.

RELATED LINKS

[Attribute Inspector](#) on page 728

Saving Default Effect Presets

You can save your effect parameter settings as default effect preset. This allows you to load your parameter settings automatically every time you select the effect.

PROCEDURE

1. Open the **Preset Management** pop-up menu.



2. Select **Save as Default Preset**.
You are asked if you want to save the current settings as default preset.
 3. Click **Yes**.
-

RESULT

The effect settings are saved as default preset. Every time you load the effect, the default preset is loaded automatically.

Copying and Pasting Presets Between Effects

You can copy and paste effect presets between different instances of the same plug-in.

PROCEDURE

1. Open the control panel for the effect that you want to copy.
 2. Right-click the control panel and select **Copy <plug-in name> Setting** from the context menu.
 3. Open another instance of the same effect.
 4. Right-click the control panel and select **Paste <plug-in name> Setting** from the context menu.
-

Saving Insert Presets

You can save the inserts of the inserts effect rack for a channel as an inserts preset, together with all parameter settings. Insert presets can be applied to audio, instrument, FX channel, or group tracks.

PREREQUISITE

You have loaded a combination of insert effects and the effect parameters are set up for each effect.

PROCEDURE

1. Select the track.
2. In the **Inspector**, open the **Inserts** section.
3. On the **Inserts** tab, click **Preset Management** and select **Save FX Chain Preset**.

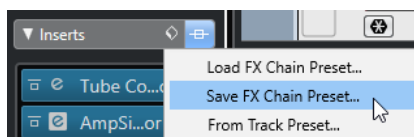

4. In the **Save FX Chain Preset** pane, enter a name for the new preset in the **New Preset** section.

5. Click **OK**.
-

RESULT

The insert effects and their effect parameters are saved as insert preset.

RELATED LINKS

[Applying FX Chain Presets](#) on page 544

Loading Insert Presets

You can load insert presets to audio, group, instrument, and FX channels.

PREREQUISITE

You have saved a combination of insert effects as insert presets.

PROCEDURE

1. Select the track to which you want to apply the new preset.
2. In the **Inspector**, open the **Inserts** section.
3. On the **Inserts** section, click **Preset Management** and select **Load FX Chain Preset**.
4. Select an insert preset.

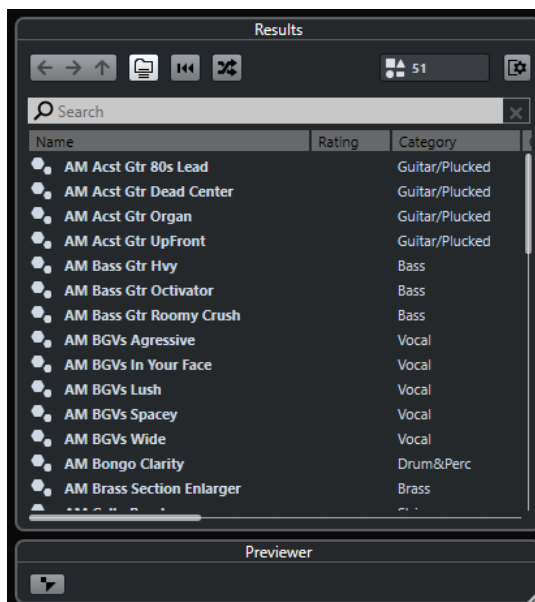

5. Double-click to apply the preset and close the pane.
-

RESULT

The effects of the insert effect preset are loaded and any plug-ins that were previously loaded for the track are removed.

Loading Insert Effect Settings from Track Presets

You can extract the effects that are used in a track preset and load them into your inserts rack.

PROCEDURE

1. Select the track to which you want to apply the new preset.
2. In the **Inspector**, open the **Inserts** section.

3. On the **Inserts** tab, click **Preset Management** and select **From Track Preset**.
4. In the track preset pane, select the preset that contains the insert effects you want to load.
5. Double-click to load the effects and close the pane.

RESULT

The effects used in the track preset are loaded.

RELATED LINKS

[Track Presets](#) on page 201

System Component Information Window

The **System Component Information** window lists all available MIDI plug-ins, audio-codec plug-ins, program plug-ins, project import-export plug-ins, and the virtual file system plug-ins.

- To open the **System Component Information** window, select **Studio > More Options > System Component Information**.

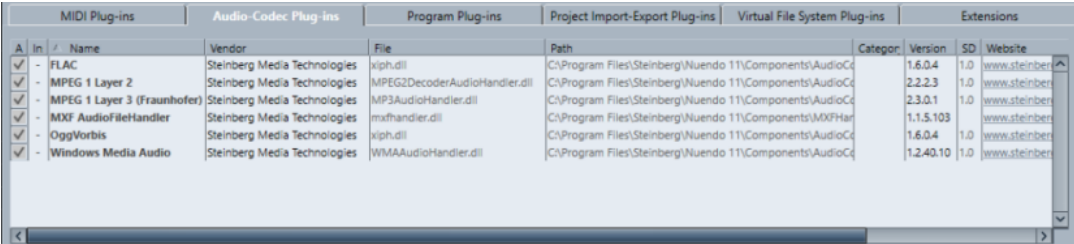

MIDI Plug-ins		Audio-Codec Plug-ins		Program Plug-ins		Project Import-Export Plug-ins		Virtual File System Plug-ins		Extensions	
A	In	Name	Vendor	File	Path	Category	Version	SD	Website		
<input checked="" type="checkbox"/>		FLAC	Steinberg Media Technologies	xiph.dll	C:\Program Files\Steinberg\Nuendo 11\Components\AudioC...		1.6.04	1.0	www.steinber...		
<input checked="" type="checkbox"/>		MPEG 1 Layer 2	Steinberg Media Technologies	MPEG2DecoderAudioHandler.dll	C:\Program Files\Steinberg\Nuendo 11\Components\AudioC...		2.2.23	1.0	www.steinber...		
<input checked="" type="checkbox"/>		MPEG 1 Layer 3 (Fraunhofer)	Steinberg Media Technologies	MP3AudioHandler.dll	C:\Program Files\Steinberg\Nuendo 11\Components\AudioC...		2.3.01	1.0	www.steinber...		
<input checked="" type="checkbox"/>		MXF AudioFileHandler	Steinberg Media Technologies	mxfhandler.dll	C:\Program Files\Steinberg\Nuendo 11\Components\MXFHar...		1.1.5.103		www.steinber...		
<input checked="" type="checkbox"/>		OggVorbis	Steinberg Media Technologies	xiph.dll	C:\Program Files\Steinberg\Nuendo 11\Components\AudioC...		1.6.04	1.0	www.steinber...		
<input checked="" type="checkbox"/>		Windows Media Audio	Steinberg Media Technologies	WMAAudioHandler.dll	C:\Program Files\Steinberg\Nuendo 11\Components\AudioC...		1.2.40.10	1.0	www.steinber...		

Update (only available for MIDI Plug-ins)

Re-scans the designated plug-in folders for updated system component information.

The following columns are available:

Active

Allows you to activate or deactivate a plug-in.

Instances

The number of plug-in instances that are used in Nuendo.

Name

The name of the plug-in.

Vendor

The manufacturer of the plug-in.

File

The name of the plug-in, including its file name extension.

Path

The path in which the plug-in file is located.

Category

The category of each plug-in.

Version

The version of the plug-in.

SDK

The version of the VST protocol with which the plug-in is compatible.

Managing System Components in the System Component Information Window

- To make a plug-in available for selection, activate the checkbox in the left column. Only the activated plug-ins appear in the effect selectors.
- To see where a plug-in is used, click in the **Instances** column.

NOTE

A plug-in may be in use even if it is not activated in the left column. The left column only determines whether or not the plug-in is visible on the effect selectors.

Exporting System Component Information Files

You can save system component information as an XML file, for example, for archiving purposes or troubleshooting.

- The system component information file contains information on the installed/available plug-ins, their version, vendor, etc.
- The XML file can then be opened in any editor application supporting the XML format.

NOTE

The export function is not available for program plug-ins.

PROCEDURE

1. In the **System Component Information** window, right-click in the middle of the window and select **Export**.
 2. In the dialog, specify a name and location for the system component information export file.
 3. Click **Save** to export the file.
-

Direct Offline Processing

Direct Offline Processing allows you to instantly add plug-in effects and audio processes to the selected audio events, clips, or ranges, without destructing the original audio.

Applying offline effects is common practice in dialogue editing and sound design. Offline processing has several advantages over applying real-time mixer effects:

- The workflow is clip-based. This allows you to apply different effects to events on the same track.
- The **MixConsole** can be kept clean from insert effects and parameter changes. This facilitates later mixing by another person, on a different system.
- Less CPU load is used.

Direct Offline Processing allows you to undo any changes regarding plug-in effects and audio processes, at any point and in any order. You can always revert to the original version. This is possible because processing does not affect the actual audio files.

If you process an event, a clip, or a selection range, the following happens:

- A new audio file is created in the **Edits** folder within your project folder. This file contains the processed audio, and the processed section of the audio clip refers to it.
- The original file remains unaffected. The unprocessed sections still refer to it.

All applied offline processing is saved with the project and can still be modified after reopening the project. **Direct Offline Processing** operations on the selected audio are persistent in track archives and project backups, and when using network collaboration or copying processes between projects.

NOTE

If you export audio via **Game Audio Connect** or as an AAF file, all offline processing is automatically made permanent.

Processing is always applied to the selection. This can be one or multiple events in the **Project** window or in the **Audio Part Editor**, an audio clip in the **Pool**, or a selection range on one or multiple events in the **Project** window or in the **Sample Editor**. If a selection is shorter than the audio file, only the selected range is processed.

If you select an event that is a shared copy, and therefore refers to a clip that is used by other events in the project, you can decide how to proceed:

- Select **Continue** to process all shared copies.
- Select **New Version** to process the selected event only.

NOTE

This only works if **Open Options Dialog** is selected for the **On Processing Shared Clips** setting in the **Preferences** dialog (**Editing—Audio** page).

RELATED LINKS

[Modifying Processes](#) on page 545

[Applying Offline Processing Permanently](#) on page 547

[Game Audio Connect](#) on page 569
[Exporting AAF Files](#) on page 1302
[Editing - Audio](#) on page 1357
[Direct Offline Processing Workflow](#) on page 535
[Direct Offline Processing Window](#) on page 536

Direct Offline Processing Workflow

You can perform offline processing operations in the **Direct Offline Processing** window. The window always shows the processing of the selected audio.

When you add or modify offline processing, the following applies:

- You can add processing by adding plug-ins or audio processes. Furthermore, you can add FX chain presets, track presets, or effect favorites within the **Direct Offline Processing** window, or drag plug-ins or plug-in chains from **Inserts** or from the **Media** rack.
- If you add a plug-in effect or a process, its last used parameter settings are loaded. You can reset it to its default settings by clicking **Reset to Default Values**.
- You can keep a plug-in effect or a process in the process panel by activating **Pin Process**. This allows you to apply it consecutively to several audio events with the same settings.
- All changes are instantly applied to the audio.

NOTE

You can change this by deactivating **Auto Apply** in the **Direct Offline Processing** window. This can be necessary if you work with long events or if you use plug-ins that have a learning function.

- If you modify parameters or remove processing, these changes are instantly applied to the audio.
- You get a visual feedback while a process is running.

NOTE

You can add, modify, or delete plug-in effects or audio processes at any time, even if a process is running. A new rendering process is instantly started.

- You can undo and redo all **Direct Offline Processing** operations by using **Ctrl/Cmd - Z** or **Shift - Ctrl/Cmd - Z**.
- If an event is locked, you cannot edit it in the **Direct Offline Processing** window.
- You can apply all offline processing permanently to the audio.
- If you load a project with offline processing of plug-in effects or audio processes that are not available on your computer, these processes are shown as **Not available** in the **Direct Offline Processing** window.

RELATED LINKS

[Direct Offline Processing Window](#) on page 536
[Auto Apply](#) on page 536
[Key Commands for Direct Offline Processing](#) on page 557
[Locking Events](#) on page 238
[Applying Offline Processing Permanently](#) on page 547

Auto Apply

When you add or modify plug-in effects or audio processes, the processing is by default automatically applied to the audio. If you work with long events or if you use plug-ins with learning function, you can deactivate **Auto Apply**.

If **Auto Apply** is deactivated, the following applies:

- You must click **Apply** or use the corresponding key command to apply processing to the audio.

NOTE

If the **Direct Offline Processing** window has the focus, you can also press **Return** to apply the processing.

- You must click **Discard** or use the corresponding key command to cancel processing.

IMPORTANT

Audio processes without adjustable parameters, for example, **Reverse** or **Silence**, are instantly applied to the audio, even if **Auto Apply** is deactivated.

NOTE

Activating **Pin Process** deactivates **Auto Apply** automatically.

RELATED LINKS

[Applying Plug-in Effects with Learning Function](#) on page 542

[Key Commands](#) on page 1313

[Built-In Audio Processes](#) on page 548

Direct Offline Processing Window

The **Direct Offline Processing** window allows you to add, modify, or delete audio processing instantly for one or multiple events, clips, or selection ranges in one window. Furthermore, you can undo any audio processing, at any point and in any order.

To open the **Direct Offline Processing** window, do one of the following:

- Select **Audio > Direct Offline Processing**.
- Press **F7**.
- On the **Project** window toolbar, click **Open Direct Offline Processing Window**.
- Select **Audio > Processes**, and from the submenu, select a process.

NOTE

Processes without adjustable parameter settings, such as **Silence**, do not open the **Direct Offline Processing** window when applied from the menu or using a key command.

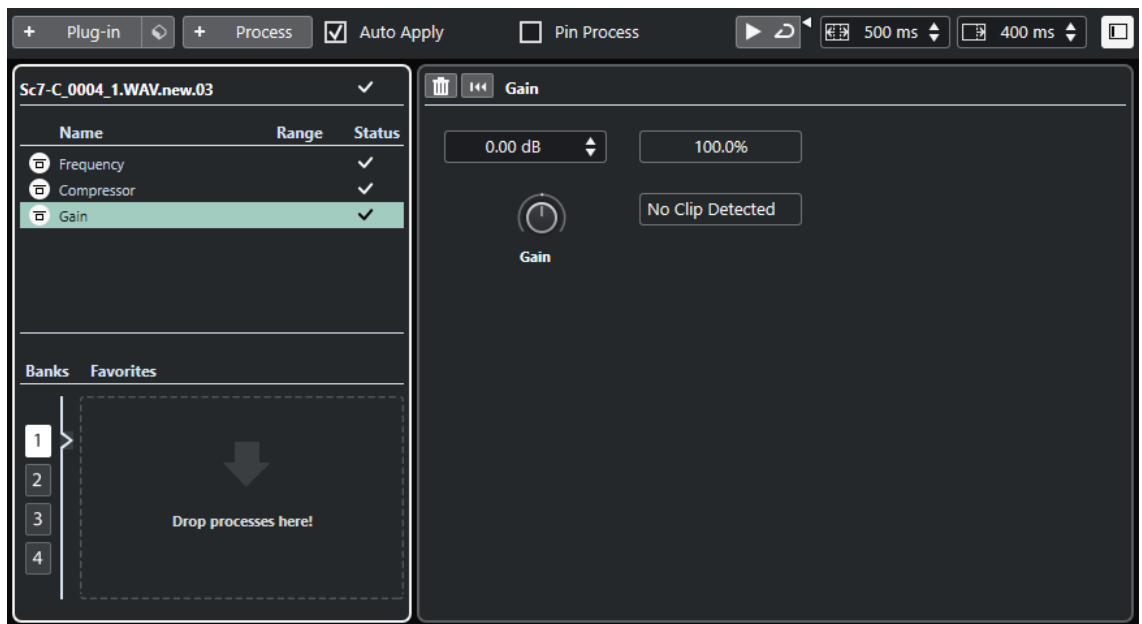

In the **Direct Offline Processing** window, the following options and settings are available:

Toolbar

Allows you to add audio processing, to audition the audio with the current edits, and to make global settings for offline processing.

Process list

Lists all plug-in effects and built-in audio processes that you add to the selected event, clip, or range. You can bypass items in this list. An icon at the right of each process shows the status.

If only a range of a selected event is processed, this is indicated by a waveform icon in the **Range** column.

If more than one processed event or clip is selected, the **Count** column shows how many instances of each process are used on the whole selection.

You can copy or cut processes with all settings and paste them to other events, clips, or ranges, delete them, and make offline processing permanent by using the context menu.

If a process is not available on your computer, it is shown as **Not available**.

Process panel

Allows you to modify, reset, or delete the selected plug-in effect or audio process.

Apply and **Discard** allow you to apply a new plug-in effect or audio process or a parameter change manually to the audio or to discard it.

NOTE

- If **Auto Apply** is activated, the **Apply** and **Discard** buttons are not available.
- The effect parameters for plug-ins are described in the separate document **Plug-in Reference**.

Favorites

Allow you to add and manage single processes or process batches with dedicated parameter settings. You can create up to 36 favorites that are available on 4 banks.

RELATED LINKS

[Applying Processing](#) on page 540

- [Bypass Processes](#) on page 546
- [Copying and Pasting Processes](#) on page 547
- [Favorites](#) on page 542
- [Batch Processing](#) on page 544
- [Applying Offline Processing Permanently](#) on page 547
- [Applying Processing to Multiple Events](#) on page 541
- [Auto Apply](#) on page 536
- [Direct Offline Processing Toolbar](#) on page 538

Direct Offline Processing Toolbar

The **Direct Offline Processing** toolbar allows you to add audio processing, to audition the audio with the current edits, and to make global settings for offline processing.

On the toolbar, the following options and settings are available:

Add Processes

Add Plug-in

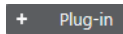

Allows you to add a plug-in effect to the selected event or clip.

Select Preset



Allows you to select a plug-in preset.

Add Process

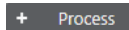

Allows you to add a built-in audio process to the selected event or clip.

Apply Options

Auto Apply

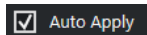

If this option is activated and you add or modify a plug-in effect or an audio process, it is instantly rendered into the audio and added to the process list in the left zone of the **Direct Offline Processing** window.

If this option is deactivated, you can make your changes on the process panel without rendering your changes instantly into the audio. To add the plug-in effect or the audio process to the process list, or to apply parameter changes of a process that you already added, click **Apply**. To discard a plug-in effect, an audio process, or a parameter change, click **Discard**.

NOTE

- The **Auto Apply** function for instant rendering is suited for most workflows. However, if you work with long events, you might want to deactivate it.
- Activating **Auto Apply** deactivates **Pin Process** automatically.

Pin Process

If this option is activated and you add a plug-in effect or an audio process, you can apply it with the same settings consecutively to several audio events.

To render the plug-in effect or the audio process into an event, select the event and click **Apply**. To discard the plug-in effect or audio process, click **Discard**.

NOTE

- **Pin Process** is useful if you work with plug-ins that have a learning function or if you want to apply the same amount of an effect to an event multiple times.
- Activating **Pin Process** deactivates **Auto Apply** automatically.

Left Divider

Left Divider

Tools that are placed to the left of the divider are always shown.

Audition

Audition



Allows you to audition the selected audio with all processing from the top of the process list up to the selected process in the list. All processes below are ignored during playback.

Audition Loop



Loops the playback until you deactivate the **Audition** button.

Audition Volume



Allows you to adjust the volume.

Extend Process Range

Extend Process Range in ms



Allows you to extend the process range over the left and right of the event borders. This allows you to enlarge the event at a later stage with all applied processing.

Tail

Tail in ms



Allows you to add time at the end of the rendered files. This way, reverb and delay effects can fully fade out.

Right Divider

Right Divider

Tools that are placed to the right of the divider are always shown.

Window Zone Controls

Show/Hide Left Zone



Shows/Hides the left zone of the **Direct Offline Processing** window that contains the process list.

NOTE

This setting is saved globally.

RELATED LINKS

[Auto Apply](#) on page 536

[Process Range Extension](#) on page 545

[Tail](#) on page 545

Applying Processing

You can add processing to one or multiple events, clips, or ranges in the **Direct Offline Processing** window. This includes plug-in effects, audio processes, and **Sample Editor** operations, such as **Cut**, **Paste**, **Delete**, and using the **Draw** tool.

The **Auto Apply** function for instant rendering is suited for most workflows. However, if you work with long events or if you use plug-ins that have a learning function, you might want to deactivate it.

PROCEDURE

1. Do one of the following:
 - Select an event or a range in the **Project** window.
 - Select a clip in the **Pool**.
 - Select a range in the **Sample Editor**.
 - Select an event or a range in the **Audio Part Editor**.
2. Select **Audio > Direct Offline Processing**.
3. Do one of the following:
 - On the **Direct Offline Processing** toolbar, click **Add Process** and select an audio process.
 - On the **Direct Offline Processing** toolbar, click **Add Plug-in** and select a plug-in effect.
 - In the **Media** rack, click the **VST Effects** tile, select a plug-in effect, and drag it to the process list in the left zone.

IMPORTANT

- You can select all installed VST plug-ins for offline processing. However, not every plug-in is suited for offline processing.
- If you apply a stereo effect to mono audio material, the left side of the effect's stereo output is used.

The selected plug-in effect or audio process is added to the process list.

4. Activate **Audition** and make your changes on the process panel.
You get a visual feedback while a process is running. However, even if the processing is not finished, you can activate **Audition** at any time.
 5. Optional: If **Auto Apply** is deactivated, choose whether you want to apply the processing to the audio or to discard it.
 - Click **Apply** to add the plug-in effect or audio process to the process list and render it into the audio.
 - Click **Discard** to discard the plug-in effect or audio process. The process panel is emptied.
-

RESULT

The plug-in effect or audio process is rendered into the audio.

In the **Project** window, the **Pool** or the **Audio Part Editor**, the processed events show a waveform symbol.

Applying Processing to Multiple Events

Direct Offline Processing allows you to add plug-in effects or built-in audio processes to multiple events at once. You can also modify or delete processing on multiple events simultaneously.

- To apply plug-ins or audio processes to multiple events at once, select the audio and add, modify, or delete the processing.

If you select multiple events, the **Count** column of the process list shows how many instances of each process are used on the whole audio selection. The processes in the process list are ordered alphabetically.

NOTE

Applying plug-in effects to multiple events that have different channel configurations may lead to unwanted results depending on the plug-in used.

NOTE

In the **Direct Offline Processing** window, you can also edit the audio processing of multiple clips in the **Pool** simultaneously.

RELATED LINKS

[Built-In Audio Processes](#) on page 548

[Direct Offline Processing Window](#) on page 536

Applying Insert Effects as Offline Processing

You can apply audio effects from **MixConsole** or **Inspector** insert slots or entire plug-in chains with their current parameter settings as offline processing.

PREREQUISITE

Your project contains tracks with audio insert plug-in effects.

PROCEDURE

1. Select an audio event, clip, or range.
2. Select **Audio > Direct Offline Processing**.
3. Do one of the following:
 - In the **MixConsole** or **Inspector**, click an **Inserts** slot with a loaded plug-in and drag the plug-in to the **Direct Offline Processing** process list.
 - In the **MixConsole**, click the **Inserts** rack header and drag the entire rack with all loaded plug-ins to the **Direct Offline Processing** process list.

NOTE

The plug-in effect or the complete plug-in chain is instantly added to the process list, even if **Auto Apply** is deactivated.

RESULT

The plug-in effect or the complete plug-in chain is rendered into the audio with its current parameter settings.

Applying Plug-in Effects with Learning Function

You can train a plug-in effect that has a learning function, for example, a plug-in for noise reduction.

PROCEDURE

1. Select an audio range that you want to use for training the plug-in about the noise spectrum. For example, you can use a pause that only contains noise and no dialog.
2. In the **Direct Offline Processing** window, activate **Pin Process**.
3. Add the noise reduction plug-in and activate its learning mode.
4. On the **Direct Offline Processing** window toolbar, activate **Audition Loop**.
5. Activate **Audition**.
6. When you have trained the plug-in, deactivate its learning mode.
7. Deactivate **Audition**.
8. Select the whole event.
9. Click **Apply** or use the corresponding key command.

RESULT

Noise reduction is applied to the whole event with the current parameter settings.

AFTER COMPLETING THIS TASK

Select another event and click **Apply** to apply the processing with the same parameter settings.

Favorites

For plug-ins or audio processes that you use frequently, you can create favorites in the **Direct Offline Processing** window.

Favorites allow you to instantly apply single or multiple plug-ins and audio processes with dedicated parameter settings to the selected audio. You can create up to 36 favorites on 4 banks by dragging plug-ins and audio processes to the favorites section below the process list.

RELATED LINKS

[Creating Favorites](#) on page 542

[Applying Processing via Favorites](#) on page 543

[Batch Processing](#) on page 544

Creating Favorites

In the **Direct Offline Processing** window you can create favorites for frequently used plug-ins or processes with dedicated parameter settings.

PREREQUISITE

The process list contains plug-ins or audio processes with parameter settings that you want to save as favorites.

PROCEDURE

1. Optional: In the favorites section, select a bank.
2. Do one of the following:

- In the process list, select one or multiple processes, and drag them to the favorites section.

NOTE

If you drag multiple processes, you must enter a batch name in the **New Batch** window.

- In the **Media** rack, click the **VST Effects** tile, select a plug-in effect, and drag it to the favorites section.

RESULT

A single favorite or a batch of favorites is created on the selected bank in the favorites section.

AFTER COMPLETING THIS TASK

You can rename or delete the favorite or batch by using the context menu.

RELATED LINKS

[Batch Processing](#) on page 544

Creating Favorites from Insert Effects

You can use audio effects from **MixConsole** or **Inspector** insert slots or entire plug-in chains with their current parameter settings to create favorites in the **Direct Offline Processing** window.

PREREQUISITE

Your project contains tracks with audio insert plug-in effects.

PROCEDURE

1. Select an audio event, clip, or range.
2. Select **Audio > Direct Offline Processing**.
3. Do one of the following:
 - In the **MixConsole** or **Inspector**, click an **Inserts** slot with a loaded plug-in and drag the plug-in to the **Direct Offline Processing** favorites section.
 - In the **MixConsole**, click the **Inserts** rack header and drag the entire rack with all loaded plug-ins to the **Direct Offline Processing** favorites section.If you drag multiple processes, you must enter a batch name in the **New Batch** window.

RESULT

A single favorite or a batch of favorites is created on the selected bank in the favorites section.

AFTER COMPLETING THIS TASK

You can rename or delete the favorite or batch by using the context menu.

Applying Processing via Favorites

Favorites allow you to instantly apply processing to one or multiple events, clips, or ranges.

NOTE

If you apply plug-in effects or audio processes by clicking a favorite, the processing is instantly rendered to the audio, even if **Auto Apply** is deactivated.

PROCEDURE

1. Select one or multiple events.

2. In the **Direct Offline Processing** window, click a favorite.
-

RESULT

The corresponding plug-in, audio process, or process batch is instantly applied to the audio.

RELATED LINKS

- [Favorites](#) on page 542
- [Auto Apply](#) on page 536
- [Batch Processing](#) on page 544

Batch Processing

Direct Offline Processing allows you to save multiple plug-in effects or audio processes with dedicated settings as batches in the **Favorites** section, and to apply these batches with one click. You can also apply FX chain presets or insert effects of track presets as batches.

- You can create batches by dragging multiple processes from the process list to the favorites section.
- You can apply a batch to the audio by clicking the corresponding favorite.
- You can apply FX chain presets or insert effects of track presets as batches by clicking **Select Preset** in the **Direct Offline Processing** toolbar.

NOTE

- Batches are instantly applied to the audio, even if **Auto Apply** is deactivated.
 - Batches are saved globally.
 - If batches contain plug-in effects that are not available on your computer, these batches are applied without the plug-ins.
-

RELATED LINKS

- [Creating Favorites](#) on page 542
- [Applying Processing via Favorites](#) on page 543
- [Applying FX Chain Presets](#) on page 544
- [Auto Apply](#) on page 536

Applying FX Chain Presets

You can import FX chain presets or insert effects of track presets and apply them as batch processes.

NOTE

Batches are instantly applied to the audio, even if **Auto Apply** is deactivated.

PROCEDURE

1. In the **Direct Offline Processing** toolbar, click **Select Preset** and choose to load an FX chain preset or an insert effect from a track preset.
 2. From the selector, select an FX chain preset or a track preset.
-

RESULT

The effects of the FX chain preset or track preset are instantly applied to the audio.

RELATED LINKS

- [Auto Apply](#) on page 536
- [Saving Insert Presets](#) on page 530
- [Track Presets](#) on page 201

Process Range Extension

You can extend the process range over the left and right borders of the audio event.

This setting allows you to enlarge the event even after applying the processing.

- To extend the process range, click **Extend Process Range in ms** on the **Direct Offline Processing** toolbar and specify a value in milliseconds.

NOTE

- For this to work, audio must be available outside the event borders.
 - This setting works globally for all events.
-

Tail

You can add time at the end of the rendered audio when applying plug-in effects.

Adding tail avoids that a reverb tail or a delay effect is cut off. Tail is added at the end of the event and the event is automatically resized.

- To add tail when applying a plug-in effect, click **Tail in ms** on the **Direct Offline Processing** toolbar and specify a value in milliseconds.

NOTE

- This setting works globally for all events.
 - Tail is added only if you add plug-in effects. If you add audio processes, for example **Gain**, no tail is added.
 - If you add tail to an event that you have manually resized before, the tail is added but the event length is not adjusted automatically. Therefore, you must adjust the event manually. In this case, the tail is mixed with the underlying audio clip.
-

RELATED LINKS

- [Event Resize Options](#) on page 228

Modifying Processes

You can delete or modify some or all processing from a clip in the **Direct Offline Processing** window. This includes the audio processes on the **Processes** pop-up menu, any applied plug-in effects, and **Sample Editor** operations, such as **Cut**, **Paste**, **Delete**, and drawing with the **Draw** tool.

The **Auto Apply** function for instant rendering is suited for most workflows. However, if you work with long events or if you use plug-ins that have a learning function, you might want to deactivate it.

PROCEDURE

- Do one of the following:
 - Select the processed event in the **Project** window or in the **Audio Part Editor**.

NOTE

In the **Project** window or in the **Audio Part Editor**, processed events are indicated by a waveform symbol in the upper right corner.

- Select the processed clip in the **Pool**.

NOTE

In the **Pool**, processed clips are indicated by a waveform symbol in the **Status** column.

- Select the processed range in the **Sample Editor**.
2. Select **Audio > Direct Offline Processing**.
 3. In the process list, select the process that you want to edit by clicking on it.
 4. Do one of the following:
 - Activate **Audition** and modify the settings of the process.
 - Reset the process to its default settings by clicking **Reset to Default Values**.
 - Delete the process by clicking **Delete**  on the process panel.

NOTE

Alternatively, you can right-click the process list and select **Delete**.

- To delete all processing applied to the event, right-click the process list and select **Delete All**.
5. Optional: If **Auto Apply** is deactivated, choose whether you want to apply your parameter changes to the audio or to discard them.
 - Click **Apply** to apply the parameter changes to the audio.
 - Click **Discard** to discard the parameter changes.
-

RELATED LINKS

[Direct Offline Processing Window](#) on page 536
[Pool Window Columns](#) on page 677

Reordering the Process List

You can reorder the operations in the **Direct Offline Processing** process list by dragging.

PROCEDURE

- Click a plug-in effect or an audio process and move it by dragging.
-

RESULT

The offline processing operations are rendered into the audio in the specified order.

Bypass Processes

In the **Direct Offline Processing** window, you can bypass processes. This allows you to hear the audio without the processes.

- To activate/deactivate bypass for a process, click the **Bypass Process** button on the left of the process.

NOTE

- If you activate/deactivate **Bypass Process**, the complete process chain is recalculated. Depending on the length of the audio and number of processes, this may take some time. In the process list, you get a visual feedback while a process is running.
 - The bypass status is saved with the project.
-

Copying and Pasting Processes

You can copy and paste plug-in effects and audio processes together with their parameter settings between events, clips, and ranges.

PROCEDURE

1. Select a processed audio event, clip, or range.

NOTE

Processing on selections of multiple events cannot be copied.

2. In the **Direct Offline Processing** window, select one or multiple items in the process list.
 3. Right-click the process in the process list and select **Copy** from the context menu.
 4. Select the events or clips where you want to paste the process.
 5. In the **Direct Offline Processing** window, right-click the process in the process list and select **Paste**.
-

RESULT

The copied processes and all parameter settings are added to the process list of the selected audio.

Applying Offline Processing Permanently

You can apply all offline processing permanently to the audio.

PREREQUISITE

You have applied plug-in effects or audio processes to an event, clip, or range and you are sure that you do not need to edit the processing anymore.

IMPORTANT

Making offline processing permanent cannot be undone.

PROCEDURE

1. Select the processed event, clip, or range.
2. Select **Audio > Make Direct Offline Processing Permanent**.

NOTE

Alternatively, select **Make All Permanent** in the context menu of the **Direct Offline Processing** process list.

3. Click **OK**.
-

RESULT

- All processing and applied effects are permanently added to the selected event, clip, or range.
- The process list is emptied.
- The event or clip is no longer marked as offline-processed by a waveform symbol.

Built-In Audio Processes

Nuendo provides several built-in audio processes that can be used for **Direct Offline Processing**.

IMPORTANT

Audio processes without adjustable parameters, for example, **Reverse** or **Silence**, are instantly applied to the audio, even if **Auto Apply** is deactivated.

Envelope

Envelope allows you to apply a volume envelope to the selected audio.

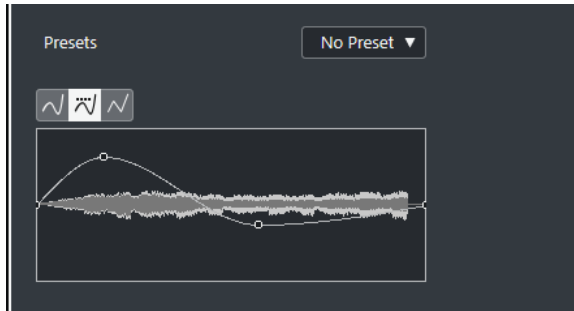

Curve Type buttons

Determine whether the corresponding envelope uses **Spline Interpolation**, **Damped Spline Interpolation**, or **Linear Interpolation**.

Envelope display

Shows the shape of the envelope. The resulting waveform shape is shown in a dark tone, with the current waveform shape in a light tone.

- To add a curve point, click the curve.
- To move a curve point, click and drag.
- To remove a curve point, click and drag it outside the display.

Presets pop-up menu

Allows you to manage your presets.

- To save a preset, select **Save Preset** from the pop-up menu, enter a name, and click **OK**.
- To apply a preset, select it from the pop-up menu.
- To remove a preset, select it from the pop-up menu, and click **Remove Preset**.

Fade In/Fade Out

Fade In and **Fade Out** allow you to apply a fade to the selected audio.

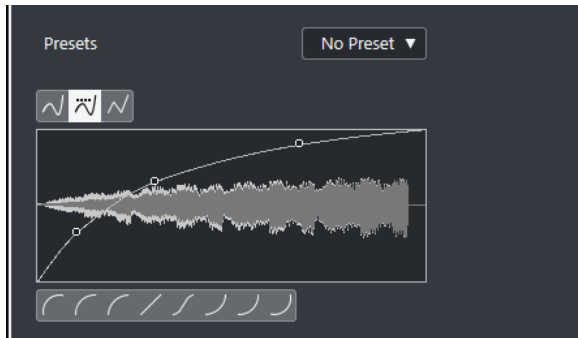

Curve Type buttons

Determine whether the corresponding envelope uses **Spline Interpolation**, **Damped Spline Interpolation**, or **Linear Interpolation**.

Fade display

Shows the shape of the fade curve. The resulting waveform shape is shown in a dark tone, with the current waveform shape in a light tone.

- To add points, click the curve.
- To change the curve shape, click and drag existing points.
- To remove a point from the curve, drag it outside the display.

Presets pop-up menu

Allows you to manage your presets.

- To save a preset, select **Save Preset** from the pop-up menu, enter a name, and click **OK**.
- To apply a preset, select it from the pop-up menu.
- To remove a preset, select it from the pop-up menu, and click **Remove Preset**.

Curve Shape buttons

These buttons give you quick access to some common curve shapes.

Gain

Gain allows you to change the gain, that is, the level of the selected audio.

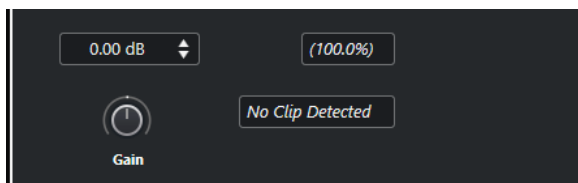

Gain

Allows you to set a gain value between -50 dB and +20 dB.

Clipping Detection text

This text is displayed if you use **Audition** and the gain setting results in audio levels above 0 dB.

NOTE

In case of clipping, lower the **Gain** value and use the **Normalize** audio process instead. This allows you to increase the level of the audio as much as possible without causing clipping.

RELATED LINKS

[Normalize](#) on page 550

Invert Phase

Invert Phase allows you to invert the phase of the selected audio.

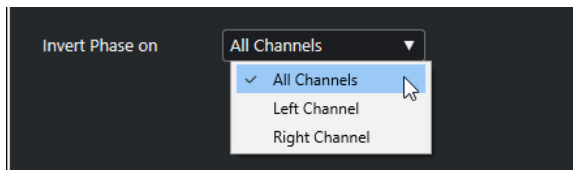

For stereo audio files, a pop-up menu is available. It allows you to specify which channels are phase-inverted: the left channel, the right channel, or both.

Normalize

Normalize allows you to raise or lower the level of audio that was recorded at an inappropriate input level. You can use the maximum peak level or the loudness of the audio as normalization reference.

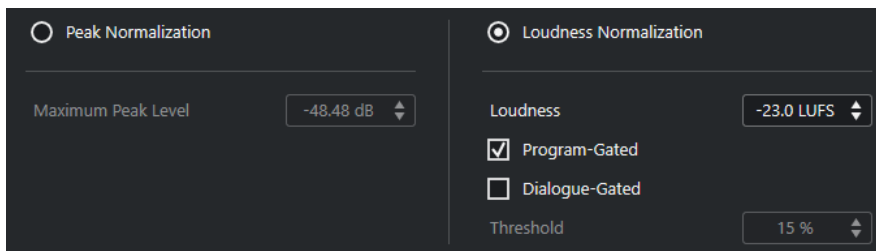

Peak Normalization

Allows you to normalize your audio based on the maximum peak level. **Maximum Peak Level in dBFS** sets a maximum peak level for the audio, between -50 dB and 0 dB. From this maximum level, the current maximum level of the selected audio is subtracted, and the gain is raised or lowered by the resulting amount.

Loudness Normalization

Allows you to normalize your audio based on the integrated loudness, according to the recommendation R 128 of the European Broadcasting Union (EBU). **Integrated Loudness in LUFS** sets a loudness value for the audio, between -34 LUFS and 0 LUFS.

NOTE

- For audio shorter than 0.4 s, no loudness normalization is applied in order to avoid unexpectedly high gain changes.
 - Normalizing a highly dynamic signal based on the integrated loudness may cause peaks over 0 dB. To avoid this, we recommend that you add the **Brickwall Limiter** plug-in after the **Normalize** process.
-

Program-Gated

Uses program-gated loudness measurement according to EBU R 128.

Dialogue-Gated

Uses dialogue-gated loudness measurement according to ITU-R BS.1770. **Threshold** allows you to specify the percentage of speech in the audio below which program-gated measurement is used automatically.

NOTE

Since dialogue-gated loudness measurement requires a minimum of 3 s audio for reliable results, we do not recommend to use it for audio shorter than 3 s.

RELATED LINKS

[Loudness Measurement](#) on page 494

Pitch Shift

Pitch Shift allows you to change the pitch of the audio with or without affecting its length. You can also create harmonies by specifying several pitches or apply pitch shift based on an envelope curve.

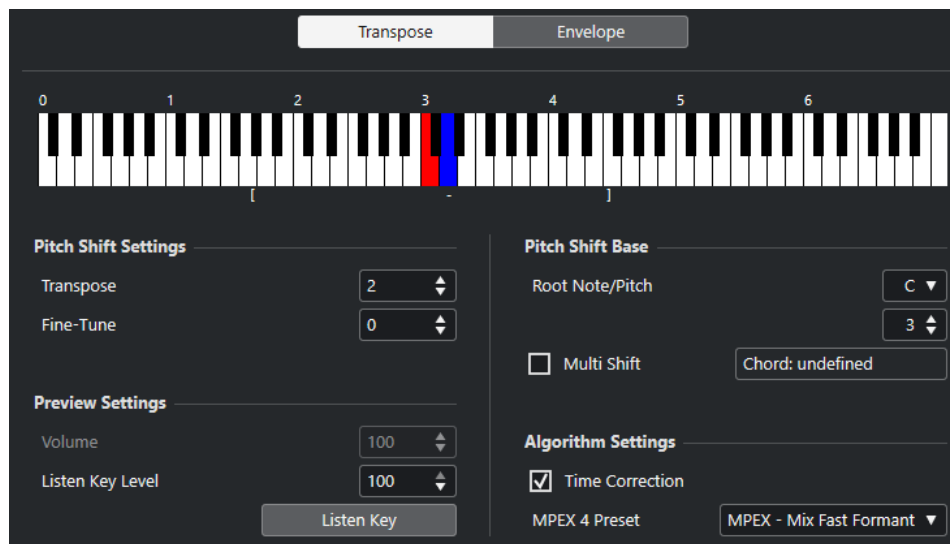

On the **Transpose** tab, the following options are available:

Keyboard display

Shows a graphic overview of the transposition where the root note is indicated in red and the transposed key is indicated in blue.

NOTE

The indicated root note has nothing to do with the key or pitch of the original audio, it just provides a way to display transpose intervals.

- To change the root note, use the settings in the **Pitch Shift Base** section, or hold **Alt**, and click the keyboard display.
- To specify a transpose interval, click one of the keys.
- To specify a chord, activate **Multi Shift** and click several keys.
To remove a transpose interval, click a blue key.

Pitch Shift Settings

Transpose

Allows you to specify the amount of pitch shift in semitones.

Fine-Tune

Allows you to specify the amount of pitch shift in cents.

Preview Settings

Volume

Allows you to lower the volume of the pitch-shifted sound. This is not available if **Time Correction** is activated.

Listen Key Level

Allows you to adjust the level of the pitch-shifted sound. Click **Listen Key/Listen Chord** to play a test tone of the pitch-shifted sound.

Pitch Shift Base

Root Note/Pitch

Allows you to set the root note.

NOTE

The indicated root note has nothing to do with the key or pitch of the original audio, it just provides a way to display transpose intervals.

Multi Shift

Activate this to specify several transpose keys and create multi-part harmonies. If the intervals you add make up a standard chord, this chord is displayed to the right.

- To include the original, untransposed sound, click the root key in the keyboard display so that it is displayed in blue.

Algorithm Settings

Time Correction

Activate this option to shift the pitch without affecting the length of the audio. If this is deactivated and you raise the pitch, the audio section is shortened.

MPEX 4 Preset

Allows you to select an MPEX 4 algorithm.

RELATED LINKS

[Time Stretch and Pitch Shift Algorithms](#) on page 559

Envelope-Based Pitch Shift

On the **Envelope** tab, you can specify an envelope curve as a base for the pitch shift.

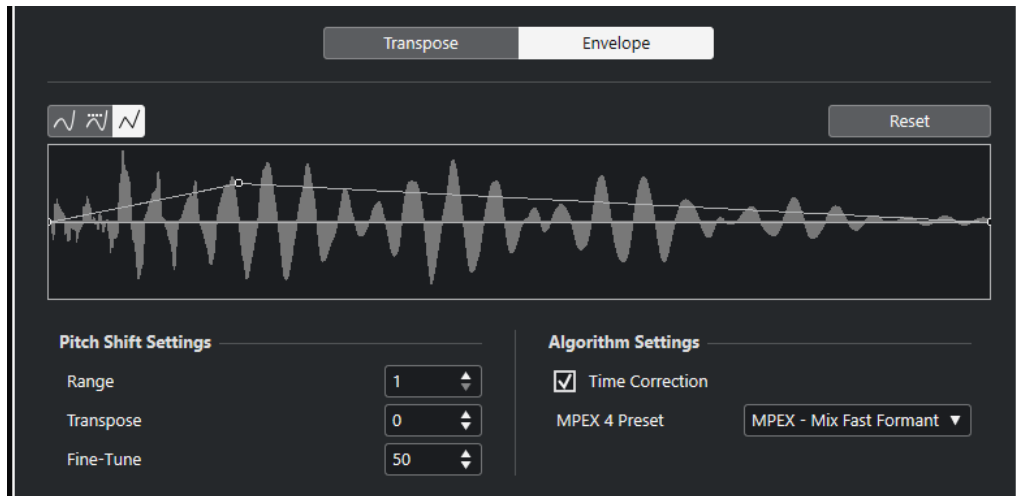

Curve Type buttons

Determine whether the corresponding envelope uses **Spline Interpolation**, **Damped Spline Interpolation**, or **Linear Interpolation**.

Envelope display

Shows the shape of the envelope curve over the waveform image of the audio selected for processing. Envelope curve points above the center line indicate a positive pitch shift, curve points below the center line indicate a negative pitch shift. Initially, the envelope curve is a horizontal, centered line, indicating zero pitch shift.

- To add a curve point, click the curve.
- To move a curve point, click and drag.
- To remove a curve point, click and drag it outside the display.
- To remove all curve points, click **Reset** above the envelope display.

Pitch Shift Settings

Range

Allows you to determine the vertical pitch range of the envelope. Moving a curve point to the top of the display shifts the pitch by this value.

Transpose

Allows you to specify the amount of pitch shift in semitones.

Fine-Tune

Allows you to specify the amount of pitch shift in cents.

Algorithm Settings

Time Correction

Activate this option to shift the pitch without affecting the length of the audio. If this is deactivated, raising the pitch shortens the audio section and vice versa, much like changing the playback speed on a tape recorder.

MPEX 4 Preset

Allows you to select an MPEX 4 algorithm.

RELATED LINKS

[MPEX](#) on page 559

Remove DC Offset Option

Remove DC Offset allows you to remove any DC offset in the audio selection.

If your audio signal contains too large a component of direct current, you may notice that it is not centered around the zero level axis. This is called DC offset.

- To verify if your audio contains DC offsets, select the audio and select **Audio > Statistics**.

IMPORTANT

DC offset is normally present throughout the entire recording. Therefore, always apply **Remove DC Offset** to complete audio clips.

There are no adjustable parameters for this audio process.

RELATED LINKS

[Statistics Window](#) on page 567

Resample

Resample allows you to change the length, tempo, and pitch of an event.

If you resample to a higher sample rate, the event gets longer and the audio plays back at a slower speed with a lower pitch. If you resample to a lower sample rate, the event gets shorter and the audio plays back at a faster speed with a higher pitch.

File Sample Rate	48000.00
New Sample Rate	44100.0
Difference	-8.125 %

File Sample Rate

Shows the original sample rate of the event.

New Sample Rate

Allows you to resample the event by specifying a sample rate.

Difference

Allows you to resample the event by specifying the difference between the original sample rate and the new sample rate.

Reverse

Reverse allows you to reverse the audio selection so that it sounds as if you play back a tape backwards. There are no adjustable parameters for this audio process.

Silence

Silence allows you to replace the selection with silence. There are no adjustable parameters for this audio process.

Stereo Flip

Stereo Flip allows you to manipulate the left and right channels of stereo audio selections.

In the **Mode** pop-up menu, the available options are:

Flip Left-Right

Swaps the left and right channel.

Left to Stereo

Copies the left channel sound to the right channel.

Right to Stereo

Copies the right channel sound to the left channel.

Merge

Merges both channels on each side for mono sound.

Subtract

Subtracts the left channel information from the right. This function is typically used for karaoke background as it removes the centered mono material from a stereo signal.

Time Stretch

Time Stretch allows you to change the length and tempo of the selected audio without affecting the pitch.

The screenshot shows a dark-themed control panel for the Time Stretch process. It features several sections:

- Algorithm:** A dropdown menu set to "MPEX - Mix Fast".
- Define Bars:** Includes a "Bars" dropdown set to 2, a "Beats" dropdown set to 0, and a "Signature" dropdown set to 4/4.
- Original Length:** Includes "Length in Samples" (282240), "Length in Seconds" (0:00:06.400), and "Tempo in BPM" (75.0000).
- Resulting Length:** Includes "Samples" (338688), "Seconds" (0:00:07.680), and "BPM" (62.5000).
- Range:** Includes a "Range" dropdown set to "1. 1. 1. 0", a "Range" dropdown set to "4. 1. 4. 24", and a "Use Locators" button.
- Time Stretch Ratio:** A dropdown menu set to 120.00000.

Define Bars

You can set the length of the selected audio and the time signature in this section.

Bars

Allows you to set the length of the selected audio in bars.

Beats

Allows you to set the length of the selected audio in beats.

Signature

Allows you to set the time signature.

Original Length

This section contains information and settings regarding the audio that is selected for processing.

Length in Samples

Shows the length of the selected audio in samples.

Length in Seconds

Shows the length of the selected audio in seconds.

Tempo in BPM

Allows you to enter the actual tempo of the audio in beats per minute. This option allows you to time-stretch the audio to another tempo, without having to compute the actual time stretch amount.

Resulting Length

These values change automatically if you adjust the **Time Stretch Ratio** to stretch the audio so that it fits within a specific time span or tempo.

Samples

Shows the resulting length in samples.

Seconds

Shows the resulting length in seconds.

BPM

Shows the resulting tempo in beats per minute. For this to work, the **Original Length** values must be specified.

Range

These settings allow you to set a range for the time stretch.

Arbitrary Range Start Time

Allows you to set a start position for the range.

Arbitrary Range End Time

Allows you to set an end position for the range.

Use Locators

Allows you to set the **Range** values to the left and right locator positions, respectively.

Algorithm

Allows you to select a time stretch algorithm.

Time Stretch Ratio

Allows you to set the amount of time stretch as a percentage of the original length. If you use the settings in the **Resulting Length** section to specify the amount of time stretch, this value changes automatically.

RELATED LINKS

[Time Stretch and Pitch Shift Algorithms](#) on page 559

Key Commands for Direct Offline Processing

You can apply offline processing by using key commands.

If you add plug-in effects or audio processes using key commands, the following applies:

- If you add plug-ins or audio processes directly, their current settings are used.
- If you add plug-ins or audio processes via favorites or batches, the dedicated settings of the favorites or batches are used.
- The **Direct Offline Processing** window opens. This does not apply if the selected process does not feature any adjustable parameters or if the window is in the background or minimized.
- You can apply offline processing by using key commands even if **Auto Apply** is deactivated.

If the corresponding section in the **Direct Offline Processing** window has the focus, the following default key commands apply:

Option	Key command
Open/Close Direct Offline Processing window	F7
Set focus within Direct Offline Processing window	Tab
Navigate in the process list	Up Arrow / Down Arrow
Activate/Deactivate Audition (Playback Toggle triggers Local Preview must be activated in the Preferences dialog)	Space
Apply process in process panel (only available if Auto Apply is deactivated)	Enter
Discard process in process panel (only available if Auto Apply is deactivated)	Delete
Delete selected item from process list	Delete
Select all items in process list	Ctrl / Cmd - A
Cut selected items from process list	Ctrl / Cmd - X
Copy selected items in process list	Ctrl / Cmd - C
Paste items to process list	Ctrl / Cmd - V
Undo	Ctrl / Cmd - Z

To define key commands for further **Direct Offline Processing** operations, and for directly adding particular plug-in effects, audio processes, favorites, or batches use the **Key Commands** dialog.

RELATED LINKS

[Favorites](#) on page 542

[Batch Processing](#) on page 544

[Direct Offline Processing Window](#) on page 536

[Transport](#) on page 1375

[Auto Apply](#) on page 536

[Key Commands](#) on page 1313

Time Stretch and Pitch Shift Algorithms

In Nuendo, time-stretching and pitch-shifting algorithms are used for offline processes, in the **Sample Editor**, or for the **Flattening Realtime Processing** function. Depending on the feature, **élastique**, **MPEX**, or **Standard** algorithm presets are available.

RELATED LINKS

[Time Stretch](#) on page 555
[Pitch Shift](#) on page 551
[Sample Editor](#) on page 574
[élastique](#) on page 559
[MPEX](#) on page 559
[Standard](#) on page 560
[Limitations](#) on page 561

élastique

The **élastique** algorithm is suited for polyphonic and monophonic material.

The following modes are available:

élastique Pro

For best audio quality, without formant preservation.

élastique Pro Formant

For best audio quality, but including formant preservation.

élastique efficient

Requires less computing power, but has a lower audio quality than the **Pro** modes.

The modes support the following variants:

Time

Favors timing accuracy over pitch accuracy.

Pitch

Favors pitch accuracy over timing accuracy.

Tape

Locks the pitch shift to the time stretch as if playing back a tape with varying speed. If you stretch the audio material, the pitch decreases automatically. This variant has no effect if you use it with event transpose or the transpose track.

MPEX

MPEX is an alternative high-quality algorithm.

You can choose between the following quality settings:

MPEX – Preview Quality

For preview purposes.

MPEX – Mix Fast

A very fast mode for preview. This mode works best with composite music signals (mono or stereo material).

MPEX – Solo Fast

For single instruments (monophonic material) and voice.

MPEX – Solo Musical

Higher quality for single instruments (monophonic material) and voice.

MPEX – Poly Fast

For monophonic and polyphonic material. This is the fastest setting that still gives very good results. You can use this for drum loops, mixes, and chords.

MPEX – Poly Musical

For monophonic and polyphonic material. This is the recommended **MPEX** quality setting. You can use this for drum loops, mixes, or chords.

MPEX – Poly Complex

For complex material or for higher stretch factors. This high-quality setting is quite CPU-intensive.

NOTE

If you apply **Pitch Shift** as an offline process, you can choose between the regular setting and a setting where the formants are preserved for each quality setting.

Standard

The **Standard** algorithm is optimized for CPU-efficient realtime processing.

The following presets are available:

Standard – Drums

For percussive sounds. This mode does not change the timing of your audio. If you use it with certain tuned percussion instruments, you may experience audible artifacts. In this case, try **Mix** mode as an alternative.

Standard – Plucked

For audio with transients and a relatively stable spectral sound character like plucked instruments.

Standard – Pads

For pitched audio with slower rhythm and a stable spectral sound character. This minimizes sound artifacts, but the rhythmic accuracy is not preserved.

Standard – Vocals

For slower signals with transients and a prominent tonal character like vocals.

Standard – Mix

For pitched material with a less homogenous sound character. This mode preserves the rhythm and minimizes the artifacts.

Standard – Custom

Allows you to set the time-stretching parameters manually.

Standard – Solo

For monophonic material like solo woodwind/brass instruments or solo vocals, monophonic synths or string instruments that do not play harmonies. This mode preserves the timbre of the audio.

Custom Warp Settings

If you select the **Standard – Custom** mode, a dialog opens where you can manually adjust the parameters that govern the sound quality of the time stretching:

Grain Size

Allows you to determine the size of the grains in which the standard time-stretching algorithm splits the audio. Low grain size values lead to good results for material that has many transients.

Overlap

This is the percentage of the whole grain that will overlap with other grains. Use higher values for material with a stable sound character.

Variance

This is a percentage of the whole length of the grains, and sets a variation in positioning, so that the overlapping area sounds smooth. A variance setting of 0 produces a sound akin to time stretching used in early samplers, whereas higher settings produce more rhythmic smearing effects but fewer audio artifacts.

Limitations

Applying time stretching or pitch shifting to audio material can lead to a degradation in audio quality and to audible artifacts. The result depends on the source material, the particular stretch and pitch operations applied, and the selected audio algorithm preset.

As a rule of thumb, smaller changes in pitch or duration cause less degradation. However, there are additional issues one should be aware of when working with time stretching and pitch shifting algorithms.

NOTE

In rare cases, editing warped audio events may cause discontinuities at the edit points. You can then try to move the edit point to a different position or bounce the audio event prior to editing.

Reverse Playback and Scrubbing

Most of the algorithms used for time stretching and pitch shifting only support forward playback. Reverse playback or scrubbing of warped audio events can lead to recurring artifacts in playback.

Pitch and Stretch Factor

Some algorithms may put limitations on the maximum degree of time stretching or pitch shifting supported. However, with **élastique** there are no limitations.

Audio Functions

Nuendo offers particular functions for analyzing the audio in your project.

RELATED LINKS

[Detect Silence Dialog](#) on page 562

[Spectrum Analyzer Window](#) on page 565

[Statistics Window](#) on page 567

Detect Silence Dialog

The **Detect Silence** dialog allows you to search for silent sections in events. You can split events and remove the silent parts from the project, or create regions corresponding to the non-silent sections.

- To open the **Detect Silence** dialog for a selected audio event, clip, or selection range, select **Audio > Advanced > Detect Silence**.

NOTE

If you select multiple events, you can process the selected events successively with individual settings or apply the same settings to all selected events simultaneously.

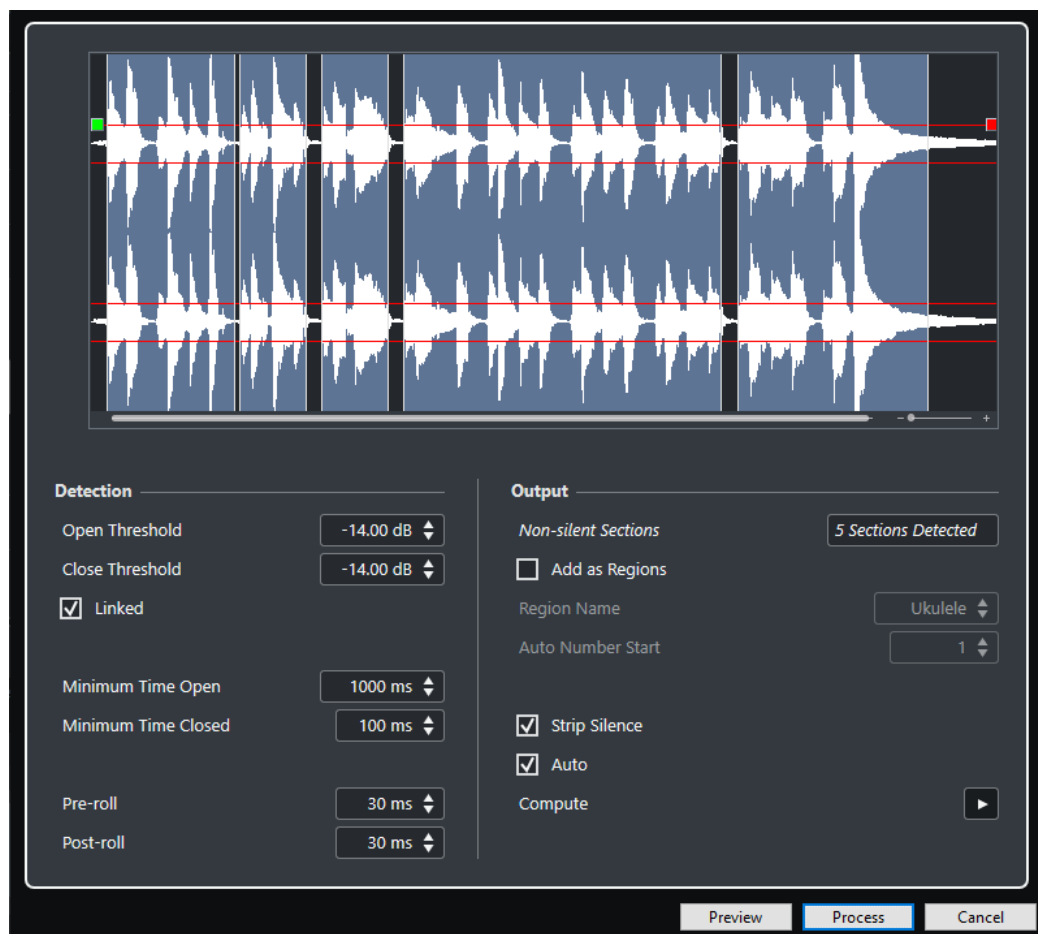

The following options are available:

Waveform display

Allows you to zoom in on and out of the waveform by using the zoom slider to the right or by clicking in the waveform and moving the mouse up or down.

You can scroll the waveform by using the scrollbar, or by using the mouse wheel.

You can adjust the **Open Threshold** and **Close Threshold** values by moving the squares at the beginning and at the end of the audio file.

The **Detection** section features the following options:

Open Threshold

When the audio level exceeds this value, the function opens and lets the sound pass. Audio material below the set level is detected as silence.

Close Threshold

When the audio level drops below this value, the function closes and detects sounds below this level as silence. This value cannot be higher than the **Open Threshold** value.

Linked

Activate this option to set the same values for **Open Threshold** and **Close Threshold**.

Minimum Time Open

Determines the minimum time that the function remains open after the audio level has exceeded the **Open Threshold** value.

NOTE

If your audio contains repeated short sounds, and this results in too many short open sections, try raising this value.

Minimum Time Closed

Determines the minimum time that the function remains closed after the audio level has dropped below the **Close Threshold** value. Set this to a low value to make sure that you do not remove sounds.

Pre-roll

Causes the function to open slightly before the audio level exceeds the **Open Threshold** value. Use this option to avoid removing the attack of sounds.

Post-roll

Causes the function to close slightly after the audio level drops below the **Close Threshold** value. Use this option to avoid removing the natural decay of sounds.

The **Output** section features the following options:

Non-silent Sections

Shows the number of events that are created if you click **Process**.

Add as Regions

Creates regions of the non-silent sections.

Region Name

Allows you to specify a name for the non-silent sections.

Auto Number Start

Allows you to specify the start number for the numbers that are automatically appended to the region names.

Strip Silence

Splits the event at the beginning and end of each non-silent section, and removes the silent sections in between.

Process all selected Events

Applies the same settings to all selected events. This option is only available if you selected more than one event.

Auto

Activate this option to analyze the audio event and update the display automatically every time you change the settings.

NOTE

If you are working with very long files, consider deactivating the **Auto** option as this may slow down the process.

Compute

Analyzes the audio event and redraws the waveform display to indicate which sections are considered silent.

Preview

Allows you to listen to the result before it is processed.

Process

Processes the audio according to your settings.

RELATED LINKS

[Removing Silent Sections](#) on page 564

Removing Silent Sections

The **Detect Silence** dialog allows you to detect and remove silent sections of your audio.

PROCEDURE

1. Select one or multiple audio events with silent sections in the **Project** window.
 2. Select **Audio > Advanced > Detect Silence**.
 3. In the **Detect Silence** dialog, make your changes.
 4. Click **Compute** to analyze the audio.
The audio is analyzed and the waveform is redrawn to indicate which sections are considered silent according to your settings. The number of detected regions is displayed.
 5. Optional: Click **Preview** to listen to the result.
The event is played back and the sections are silenced according to your settings.
 6. Optional: In the **Detection** section, readjust the settings until you are satisfied with the result.
 7. Optional: In the **Output** section, activate **Add as Regions**.
 8. In the **Output** section, activate **Strip Silence**.
 9. Click **Process**.
-

RESULT

The event is split and the silent sections are removed.



AFTER COMPLETING THIS TASK

If you have selected more than one event and did not activate **Process all selected Events**, the **Detect Silence** dialog opens again after processing, allowing you to make separate settings for the next event.

RELATED LINKS

[Detect Silence Dialog](#) on page 562

Spectrum Analyzer Window

The **Spectrum Analyzer** window displays the audio spectrum of an event, clip, or selection range as a two-dimensional graph, with frequency range on the x-axis and level distribution on the y-axis.

- To open the **Spectrum Analyzer** window for a selected audio event, clip, or selection range, select **Audio > Spectrum Analyzer**.

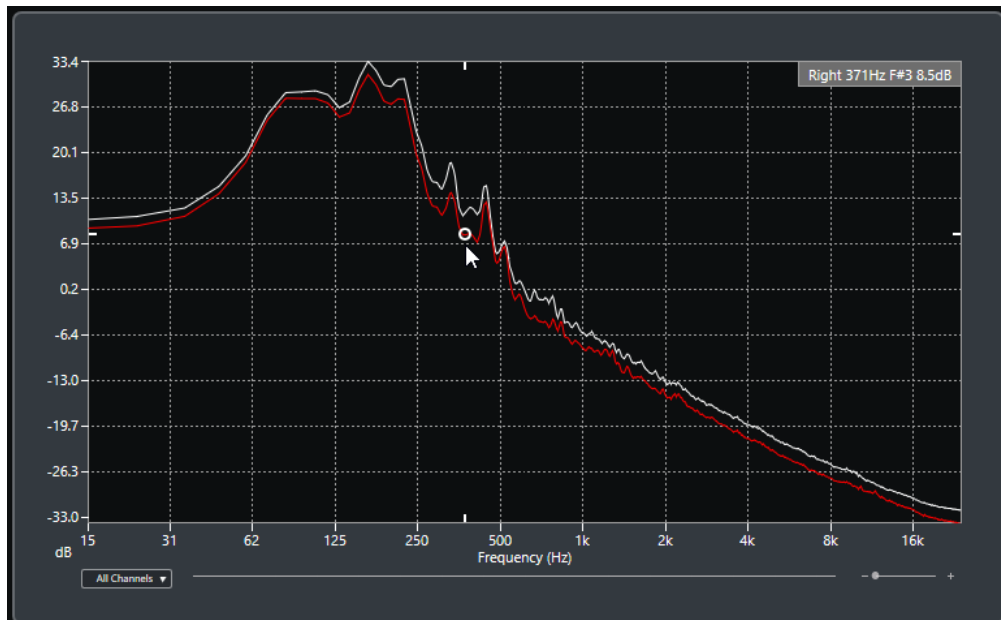

Frequency display

Shows the frequency graphs for the analyzed audio.

If you move the mouse pointer over a certain position, the channel, frequency, note, and level at that position are shown in the value field at the top of the display.

Channel selector

For multi-channel audio, this pop-up menu allows you to select which channels are shown in the frequency display.

Zoom slider

Allows you to zoom in and out horizontally.

RELATED LINKS

[Analyzing the Audio Spectrum](#) on page 566

Analyzing the Audio Spectrum

The **Spectrum Analyzer** allows you to analyze the audio of a selected event, clip, or selection range.

PROCEDURE

1. Select an audio event, clip, or a selection range.
2. Select **Audio > Spectrum Analyzer**.

RESULT

The audio spectrum of the selected event, clip, or selection range is displayed as a two-dimensional graph in the **Spectrum Analyzer** window.

AFTER COMPLETING THIS TASK

You can display the difference in level between two positions on the same or different graphs.

RELATED LINKS

[Comparing Level Values](#) on page 566

Comparing Level Values

You can display the difference in level between two positions on the same or different graphs in the **Spectrum Analyzer** window.

PROCEDURE

1. Move the mouse pointer to the first position and right-click to select it.
2. Move the mouse pointer to the second frequency position.

RESULT

The difference in level between the positions is displayed as value **D** in the value field.

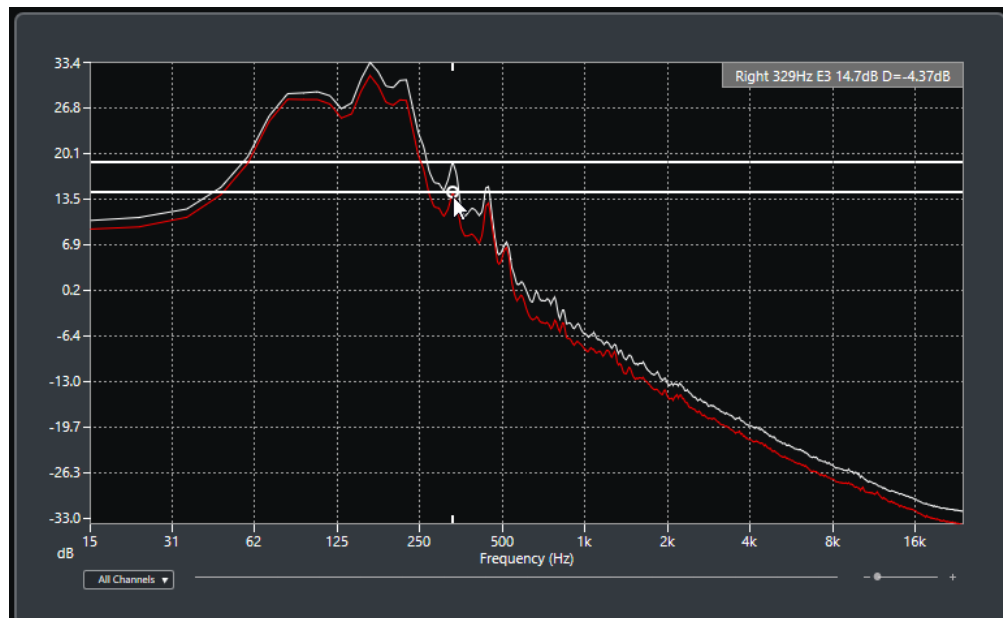

AFTER COMPLETING THIS TASK

Click the frequency display to reset the selection of the first position.

RELATED LINKS

[Spectrum Analyzer Window](#) on page 565

Statistics Window

The **Statistics** function analyzes the selected audio events, clips, or selection ranges.

- To open the **Statistics** window for a selected audio event, clip, or selection range, select **Audio > Statistics**.

Channel	Left	Right
Min. Sample Value	-0.52 dB	-0.89 dB
Max. Sample Value	-0.50 dB	-0.36 dB
Peak Amplitude	-0.50 dB	-0.36 dB
True Peak	-0.50 dB	-0.36 dB
DC Offset	0.00 % -∞ dB	0.00 % -∞ dB
Bit Depth	24 bit	24 bit
Estimated Pitch	2052.5Hz/C6	2019.8Hz/B5
Sample Rate	48.000 kHz	
Average RMS (AES-17)	-17.61 dB	-16.13 dB
Max. RMS	-9.68 dB	-10.75 dB
Max. RMS All Channels	-9.68 dB	
Loudness (EBU R 128)		
Max. Momentary Loudness	-8.9 LUFS	
Max. Short-Term Loudness	-12.9 LUFS	
Integrated Loudness	-16.4 LUFS	
Loudness Range	3.4 LU	
Max. True Peak Level	-0.36 dBTP	
Dialogue-Gated Loudness (ITU-R BS.1770)		
Integrated Loudness	-16.8 LUFS	
Loudness Range	3.4 LU	
Dialogue	99 %	
<input type="button" value="Copy to Clipboard"/> <input type="button" value="Close"/>		

The **Statistics** window shows the following information:

Channel

Shows the name of the analyzed channel.

Min. Sample Value

Shows the lowest sample value in dB.

Max. Sample Value

Shows the highest sample value in dB.

Peak Amplitude

Shows the largest amplitude in dB.

True Peak

Shows the maximum absolute level of the audio signal waveform in the continuous time domain.

DC Offset

Shows the amount of DC offset as a percentage and in dB.

Bit Depth

Shows the current calculated bit depth.

Estimated Pitch

Shows the estimated pitch.

Sample Rate

Shows the sample rate.

Average RMS (AES17)

Shows the average loudness in accordance with the AES17 standard.

Max. RMS

Shows the highest RMS value.

Max. RMS All Channels

Shows the highest RMS value of all channels.

Loudness (EBU R 128)**Max. Momentary Loudness**

Shows the maximum value of all momentary loudness values, based on a time window of 400 ms. The measurement is not gated.

Max. Short-Term Loudness

Shows the maximum value of all short-term loudness values, based on a time window of 3 s. The measurement is not gated.

Integrated Loudness

Shows the average loudness over the whole title in LUFS (Loudness Unit, referenced to Full Scale) in accordance with EBU R 128 that recommends to normalize audio at -23 LUFS.

Loudness Range

Shows the dynamic range over the whole title in LU (Loudness Units). This value allows you to see if dynamic processing is needed.

Max. True Peak Level

Shows the maximum value of the audio signal waveform in the continuous time domain.

Dialog-Gated Loudness (ITU-R BS.1770)**Integrated Loudness**

Shows the average loudness over the program in LUFS (Loudness Unit, referenced to Full Scale) in accordance with EBU R 128 that recommends to normalize audio at -23 LUFS. The measurement is dialogue-gated.

Loudness Range

Shows the dynamic range over the whole program in LU (Loudness Units). This value allows you to see if dynamic processing is needed. The measurement is dialogue-gated.

Dialogue

Shows the percentage of speech that is detected in the audio.

RELATED LINKS

[Remove DC Offset Option](#) on page 554

Game Audio Connect

Game Audio Connect makes it easy to transfer game audio assets to game audio engines or middleware, such as Audiokinetic Wwise. As a sound designer, you create and edit game audio assets in Nuendo and directly transfer them to your game audio engine.

An audio engine that is enabled for Game Audio Connect is able to locate your audio parts, either on a local hard disk, in a network, or in a version control system. From your game audio engine, you can select an audio asset and make Nuendo open the project that contains it.

Game Audio Connect Window

The **Game Audio Connect** window is the interface between the game audio engine and Nuendo. It displays the connected game audio engine and the selected audio asset. The **Game Audio Connect** window is a drop zone for drag and drop, render, and export operations.

- To open the **Game Audio Connect** window, select **Project > Game Audio Connect**.

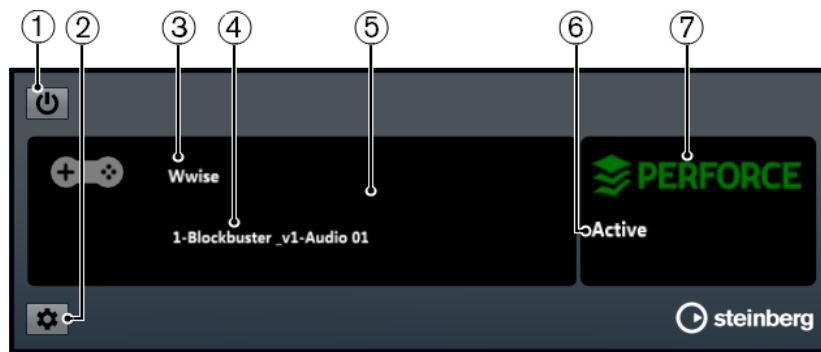

- 1 Activate Game Audio Connect**
Activates Game Audio Connect.
- 2 Open Game Audio Connect Settings**
Allows you to open the **Game Audio Connect Settings** dialog.
- 3 Game Audio Engine**
Displays the connected game audio engine.
- 4 Audio Asset**
Displays the audio asset that is selected in the game audio engine.
- 5 Drop Zone**
Drag audio assets in this area to export them to the game audio engine.
- 6 Connection Status**
Displays the connection status of the version control system.
- 7 Version Control System**
Displays the connected version control system.

Game Audio Connect Settings Dialog

The **Game Audio Connect Settings** dialog allows you to connect your game audio engine to Nuendo.

- To open the **Game Audio Connect Settings** dialog, select **Project > Game Audio Connect** and click the **Settings** button.

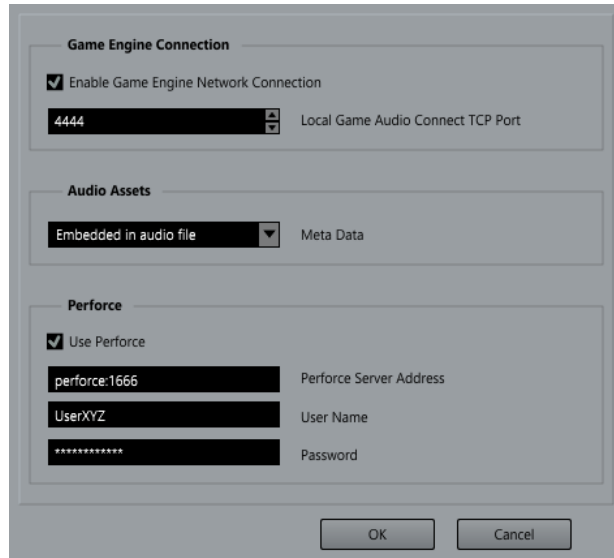

The following settings are available:

Enable Game Engine Network Connection

Allows your game audio engine to connect to Nuendo.

Local Game Audio Connect TCP Port

Sets the port for the game audio engine to connect to.

Metadata

Sets the type of metadata storage. Metadata is used to locate audio assets in Nuendo projects. By default, metadata is embedded in the rendered audio file.

If the metadata is stored in a separate file, this file has the extension `.amd`.

Use Perforce

Activates the **Perforce** feature.

Perforce Server Address

Allows you to set the **Perforce** server address.

User Name

Allows you to enter your **Perforce** user name.

Password

Allows you to enter your **Perforce** password.

Setting Up Game Audio Connect for Network Communication

If Nuendo and your game audio engine run on different computers, you can use the **Game Engine Connection** settings to establish a network connection. In such a network connection, Nuendo serves as host.

PREREQUISITE

The network address in your game audio engine is set to the IP address of the computer that is running Nuendo.

PROCEDURE

1. In Nuendo, open the **Game Audio Connect Settings** dialog.
2. In the **Game Engine Connection** section, activate the **Enable Game Engine Network Connection** option.
3. Specify the **Local Game Audio Connect TCP Port**.
The default port may be in use by another software on your system. In this case, specify another port to establish a network connection.

RESULT

Nuendo and your game audio engine are connected.

RELATED LINKS

[Game Audio Connect Settings Dialog](#) on page 570

Perforce Integration

Game Audio Connect provides a **Perforce** integration that allows version control for Nuendo projects.

Perforce Settings

The **Perforce** settings in the **Game Audio Connect Settings** dialog allow you to enable **Perforce**.

- To open the **Game Audio Connect Settings** dialog, select **Project > Game Audio Connect** and click the **Settings** button.

The following settings are available:

Use Perforce

Activates **Perforce**.

Server

Allows you to set the **Perforce** server address.

User

Allows you to enter your **Perforce** user name.

Password

Allows you to enter your **Perforce** password.

Rearrange Audio Assets for Editing

You can rearrange multiple events on a track at the same time so that they are at a specified distance from each other.

After importing audio assets to your project, you often have many adjacent events on one track. To make editing easier, you can use the **Set Spacer between Selected Events** function to rearrange all events at a specific distance.

You can also use this function on a marker track to create multiple position or cycle markers at the same distance on the timeline, allowing you to use them as export markers.

RELATED LINKS

[Setting Spacers between Events](#) on page 219

Rename Audio Assets

You can rename multiple audio events, audio parts, and MIDI parts that you recorded in Nuendo at once, so that they match the names of a script list, for example. This is useful if you produce dialogue assets for games.

To rename your assets, use the **Rename Events from List** dialog to load a script list in .csv or .txt file format that allows you to match the dialog with the recorded events or parts. You can also copy and paste content from a text editor directly to the **Rename Events from List** dialog.

RELATED LINKS

[Renaming Events from List](#) on page 225

Export Audio Assets to a Game Audio Engine

In Nuendo, you can render and export audio assets to your game audio engine.

To render and export audio assets you have the following possibilities:

- Drag audio events from the **Project** window and drop them in the drop zone of the **Game Audio Connect** window.
- Select audio events in the **Project** window and use the key command that you have set up for **Trigger Export to Game Audio Engine** in the **Game Audio Connect** category of the **Key Commands** dialog.
- Use the **Export Selected Events** dialog.
- Use the **Export Audio Mixdown** dialog.

NOTE

If you export audio assets for use in your game audio engine, you must activate the **Insert iXML Chunk** option.

RELATED LINKS

[Game Audio Connect Window](#) on page 569

[Exporting Selected Events](#) on page 240

[File Formats](#) on page 1177

Exporting Audio Assets Using Drag and Drop

Using drag and drop is the quickest way to render and export audio material from Nuendo to your game audio engine.

PROCEDURE

1. Select a sound effect in your game audio engine.
2. Drag the corresponding audio events from the **Project** window and drop them in the drop zone of the **Game Audio Connect** window.

NOTE

Alternatively, you can use the key command that you have set up for **Trigger Export to Game Audio Engine** in the **Game Audio Connect** category of the **Key Commands** dialog.

RESULT

The render operation is triggered for the dragged events. The rendered audio files are automatically exported to the connected game audio engine.

RELATED LINKS

[Render Selection Dialog](#) on page 1159

[Setting Up Game Audio Connect for Network Communication](#) on page 571

Exporting Music Segments Using Drag and Drop

The music that you use for video can consist of music segments that contain audio events, audio/MIDI parts, or markers on several tracks. These can be controlled dynamically using the game audio engine.

PREREQUISITE

You have composed several audio events, audio/MIDI parts, or markers for a music segment.

PROCEDURE

1. In your game audio engine, select the music segment option.
In Wwise, for example, open the project explorer, and select the root node Interactive Music Hierarchy.
2. Select the audio events, audio/MIDI parts, and the position and cycle markers that make up the music segment in the **Project** window.
3. Drag the music segment to the drop zone of the **Game Audio Connect** window.

NOTE

Alternatively, you can use the key command that you have set up for **Trigger Export to Game Audio Engine** in the **Game Audio Connect** category of the **Key Commands** dialog.

RESULT

The render operation is triggered for the dragged events using the current settings. The rendered files are automatically transferred to the connected game audio engine. The tempo and time signature are exported for the music segment.

AFTER COMPLETING THIS TASK

After exporting the music segments, an import dialog opens in Wwise that contains all tracks and events of the music segment. The cycle marker start defines the pre-entry and post-exit range for the segment, position markers are interpreted as cue markers.

Sample Editor

The **Sample Editor** provides an overview of the selected audio event. It allows you to view and edit audio by cutting and pasting, removing, or drawing audio data, and by processing audio. Editing is non-destructive so that you can undo modifications at any time.

You can open the **Sample Editor** in a separate window or in the lower zone of the **Project** window. This is useful if you want to access the **Sample Editor** functions from within a fixed zone of the **Project** window.

To open an audio event in the **Sample Editor**, do one of the following:

- Double-click an event in the **Project** window.
- Select an event in the **Project** window and press **Return** or **Ctrl/Cmd - E**.
- Select an event in the **Project** window and select **Audio > Open Sample Editor**.
- In the **Key Commands** dialog in the **Editors** category, assign a key command for **Open Sample Editor**. Select an event in the **Project** window and use the key command.

NOTE

If you select **Audio > Set up Editor Preferences**, the **Preferences** dialog opens on the **Editors** page. Make your changes to specify if you want the **Sample Editor** to open in a separate window or in the lower zone of the **Project** window.

The **Sample Editor** window:

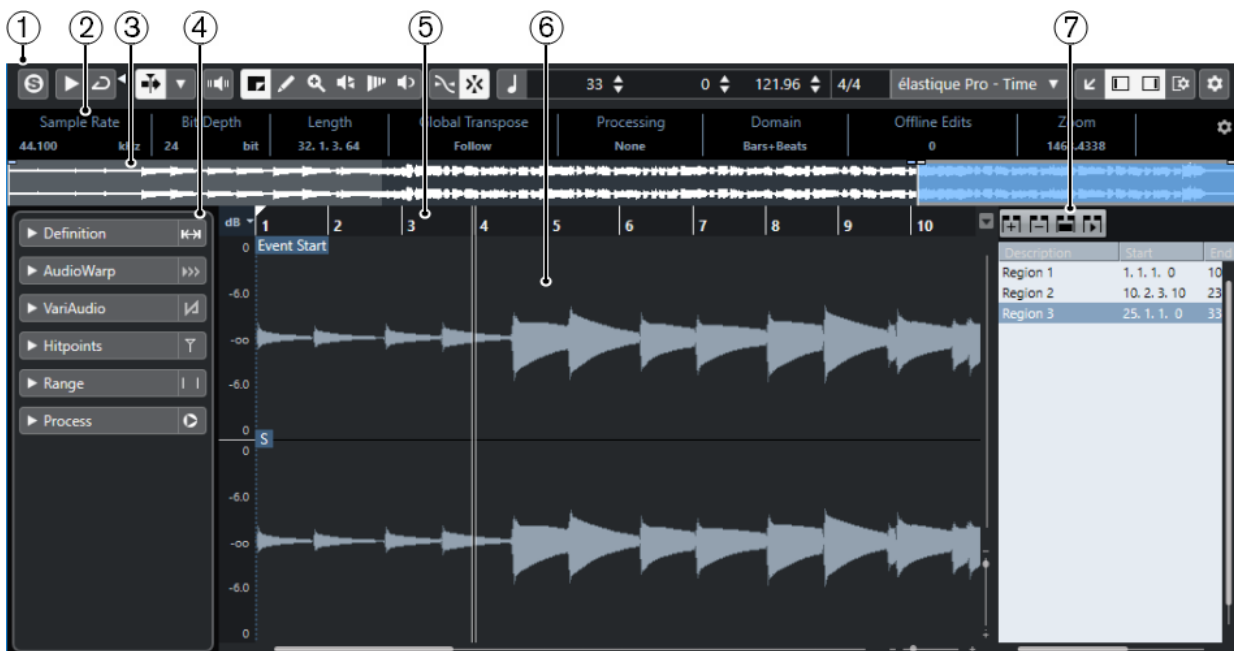

The **Sample Editor** in the lower zone of the **Project** window:



The **Sample Editor** is divided into several sections:

- 1 **Toolbar**
Contains tools for selecting, manipulating, and playing back audio.
 - 2 **Info Line**
Shows information about the audio.
 - 3 **Overview**
Shows an overview of the whole audio clip and indicates which part of the clip is shown in the waveform display.
 - 4 **Sample Editor Inspector**
Contains audio editing tools and functions.
- NOTE**
- The **Inspector** for the lower zone editor is shown in the left zone of the **Project** window.
-
- 5 **Ruler**
Shows the timeline and the display format of the project.
 - 6 **Waveform display**
Shows the waveform image of the edited audio clip.
 - 7 **Regions**
Allows you to add and edit regions.

NOTE

The info line, the overview line, and the regions can be activated/deactivated by clicking **Set up Window Layout** on the toolbar and activating/deactivating the corresponding options.

RELATED LINKS

[Opening the Editor in the Lower Zone](#) on page 75

[Opening the Editor Inspector](#) on page 66

[Sample Editor Toolbar](#) on page 576

[Info Line](#) on page 580

[Overview Line](#) on page 581

[Sample Editor Inspector](#) on page 581

[Ruler](#) on page 584

[Waveform Display](#) on page 585

[Regions List](#) on page 591

Sample Editor Toolbar

The toolbar contains tools for selecting, editing, and playing back audio.

- To show or hide the toolbar elements, right-click the toolbar and activate or deactivate the elements.

The following options are available:

Static Buttons

Solo Editor



Solos the selected audio during playback.

Left Divider

Left Divider

Tools that are placed to the left of the divider are always shown.

View Options

Show Audio Event



Highlights the section corresponding to the edited event in the waveform display and the overview line.

NOTE

This button is not available if you opened the audio event from the **Pool**. You can adjust the start and end of the event in the clip by dragging the event handles in the waveform display.

Edit Active Audio Event Only



Restricts editing operations to the active audio event.

Show All Selected Audio Events



Shows the waveform images of all audio events that you selected in the **Project** window.

NOTE

Use the **Currently Edited Audio Event** pop-up menu to select the audio event that you want to edit.

Currently Edited Audio Event

01 132 Drums ▾

Lists all audio events that are opened in the **Sample Editor**, and allows you to activate an audio event for editing.

Auto-Scroll

Auto-Scroll



Keeps the project cursor visible during playback.

Select Auto-Scroll Settings



Allows you to activate **Page Scroll** or **Stationary Cursor** and to activate **Suspend Auto-Scroll When Editing**.

Preview

Audition



Plays back the selected audio.

Audition Loop



Loops the playback until you deactivate **Audition**.

Audition Volume



Allows you to adjust the volume.

Tool Buttons

Range Selection



Selects ranges.

Zoom



Zooms in. Hold **Alt/Opt** and click to zoom out.

Draw



Draws a volume curve.

Play



Allows you to play back the clip from the position where you click until you release the mouse button.

Scrub



Allows you to locate positions.

Time Warp



Adjusts musical positions of events to time positions.

Acoustic Feedback

Acoustic Feedback



Automatically plays back a VariAudio segment when you modify the pitch.

Snap

Snap to Zero Crossing



Restricts editing to zero crossings, that is, positions where the amplitude is zero.

Snap On/Off



Restricts horizontal movement and positioning to the specific positions.

Musical Information

Musical Mode



Locks audio clips to the project tempo by using realtime time stretching.

Number of Bars Defined in Audio File



Displays the estimated bars of your audio file.

Remaining Number of Beats Defined in Audio File



Displays the remaining number of beats of your audio file.

Defined Tempo of Audio File



Displays the estimated tempo of your audio file.

Defined Time Signature of Audio File



Displays the estimated time signature of your audio file.

Warping Algorithm for Audio Clip

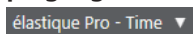

Allows you to select a warp algorithm.

VariAudio Segment Colors

VariAudio Segment Colors

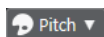

Allows you to select a color scheme for VariAudio segments. This makes it easier to see which segments belong to which event when working with several audio events.

Right Divider

Right Divider

Tools that are placed to the right of the divider are always shown.

Window Zone Controls

Open in Separate Window



This button is available in the lower zone editor. It opens the editor in a separate window.

Open in Lower Zone



This button is available in the editor window. It opens the editor in the lower zone of the **Project** window.

Set up Window Layout



Allows you to set up the window layout.

Show/Hide Left Zone



Allows you to activate/deactivate the left zone.

Show/Hide Regions



Allows you to activate/deactivate the regions.

Set up Toolbar



Opens a pop-up menu where you can set up which toolbar elements are visible.

RELATED LINKS

[Auto-Scroll Settings Menu](#) on page 274

[Suspend Auto-Scroll When Editing](#) on page 274

Locating Positions with the Scrub Tool

The **Scrub** tool allows you to locate positions in the audio.

PROCEDURE

1. On the toolbar, activate the **Scrub** tool.
 2. Click in the waveform display and keep the mouse button pressed.
The project cursor moves to the position where you clicked.
 3. Drag to the left or right.
-

RESULT

The audio is played back, and you can hear at which position the cursor is located.

NOTE

You can determine the speed and pitch of the playback by dragging faster or slower.

Editing Audio Samples with the Draw Tool

You can edit the audio clip at sample level with the **Draw** tool. This way, you can remove audio clicks manually, for example.

PROCEDURE

1. On the audio waveform, locate the sample position that you want to edit and zoom in to the highest zoom level.
2. Select the **Draw** tool.

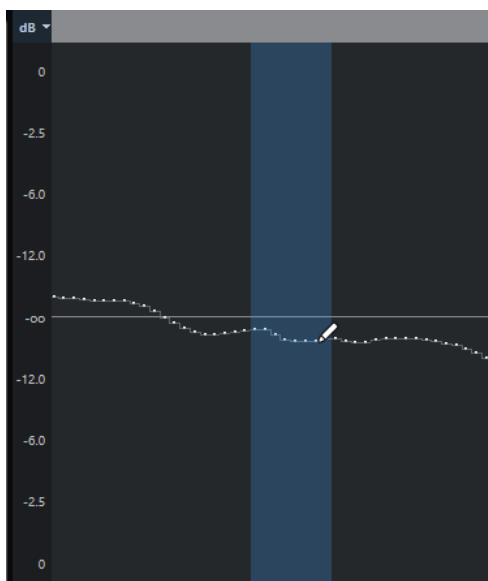

3. Click at the beginning of the section that you want to correct and draw in the new curve.

RESULT

A range selection covering the edited section is automatically applied.

NOTE

The **Draw** tool cannot be used when the **VariAudio** section is open.

Info Line

The info line shows information about the audio clip, such as the audio format and the selection range.

Sample Rate	Bit Depth	Length	Global Transpose	Processing	Domain	Offline Edits
48,000 kHz	24 bit	12. 2. 2.111	Follow	None	Bars+Beats	2
Zoom	Selection	Current Pitch	Original Pitch			
0.1294	0. 0. 0. 0 [6. 2. 2. 65 - 6. 2. 2. 65]	-	-			

- To show or hide the info line, click **Set up Window Layout** on the toolbar and activate or deactivate **Info Line**.
The on/off status of the info line in the **Sample Editor** window and in the lower zone editor are independent of each other.

NOTE

Initially, length and position values are displayed in the format specified in the **Project Setup** dialog.

Overview Line

The overview line displays the whole clip, and indicates which part of the clip is shown in the waveform display.



- To show or hide the overview line, click **Set up Window Layout** on the toolbar and activate or deactivate the **Overview** option.

The on/off status of the overview line in the **Sample Editor** window and in the lower zone editor are independent of each other.

1 Event Start

Shows the start of the audio event if **Show Audio Event** is activated on the toolbar.

2 Selection

Shows which section is selected in the waveform display.

3 Event End

Shows the end of the audio event if **Show Audio Event** is activated on the toolbar.

4 Waveform display

Shows the section of the audio that is displayed in the waveform display.

- You can specify which section of the audio is shown by clicking in the lower half of this display and dragging to the left or right.
- You can zoom in or out horizontally by dragging the left or right edge of this display.
- You can show a different section of the audio by clicking in the upper half of this display and dragging a rectangle.

5 Snap Point

Shows the start of the audio event if **Show Audio Event** is activated on the toolbar.

Sample Editor Inspector

The **Inspector** shows controls and parameters that allow you to edit the audio event that is opened in the **Sample Editor**.

- In the **Sample Editor** window, you can show or hide the **Inspector** by clicking **Set up Window Layout** on the toolbar and activating or deactivating **Inspector**.

NOTE

In the lower zone editor, the **Inspector** is always shown in the left zone of the **Project** window.

- To open or close the **Inspector** sections, click their names.

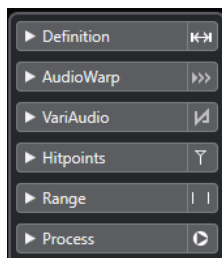

RELATED LINKS

[Opening the Editor Inspector](#) on page 66

Definition Section

The **Definition** section allows you to adjust the audio grid and define the musical context of your audio. You can use the available functions to match an audio file or audio loop to the project tempo.

- To open the **Definition** section, click its tab in the **Sample Editor Inspector**.

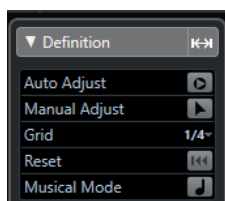

AudioWarp Section

The **AudioWarp** section allows you to perform timing settings for your audio. This includes applying **Swing** and manually changing the rhythm of the audio by dragging beats to time positions on the grid.

- To open the **AudioWarp** section, click its tab in the **Sample Editor Inspector**.

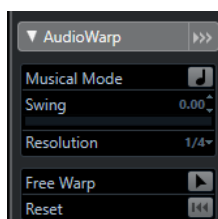

VariAudio Section

The **VariAudio** section allows you to edit single sounds of your audio file and change their pitch or timing. Furthermore, you can extract MIDI from your audio.

- To open the **VariAudio** section, click its tab in the **Sample Editor Inspector**.

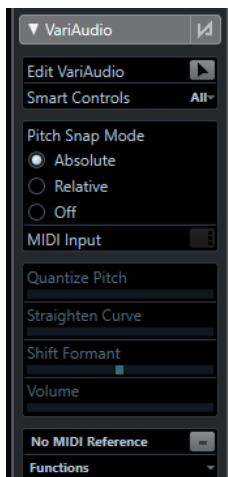

RELATED LINKS

[VariAudio Inspector Section](#) on page 615

Hitpoints Section

The **Hitpoints** section allows you to edit hitpoints to slice your audio. Here you can create groove quantize maps, markers, regions, events, and warp markers based on hitpoints.

- To open the **Hitpoints** section, click its tab in the **Sample Editor Inspector**.



Range Section

The **Range** section allows you to edit ranges and selections or create a sampler track from the selected range.

- To open the **Range** section, click its tab in the **Sample Editor Inspector**.

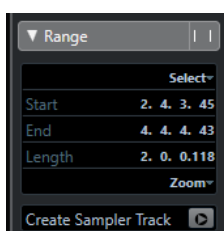

Select

Opens a pop-up menu with functions to select ranges.

Start

Shows the start position of the selection range.

End

Shows the end position of the selection range.

Length

Shows the length of the selection range.

Zoom

Opens a pop-up menu with the zoom functions for ranges.

Create Sampler Track

Allows you to create a sampler track from the range selection.

Process Section

The **Process** section regroups the most important audio editing commands from the **Audio** and **Edit** menus.

- To open the **Process** section, click its tab in the **Sample Editor Inspector**.

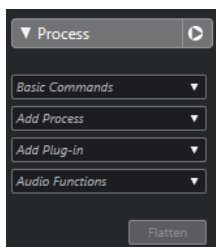

Ruler

The ruler shows the timeline and display format of the project, the project tempo grid.

The ruler is located above the waveform display. It is always shown.

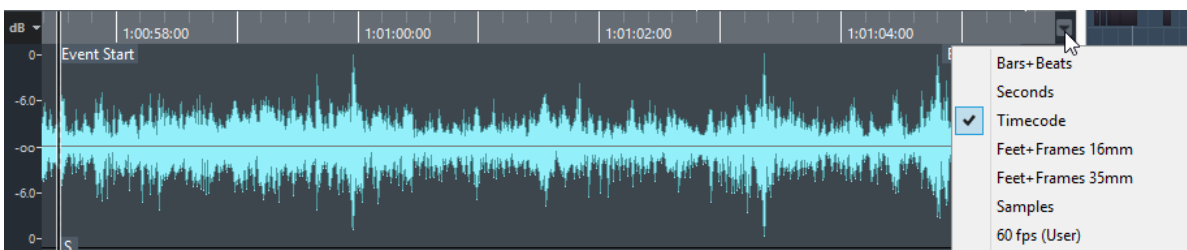

When the **Definition** section is open, an additional ruler is shown below the project tempo grid. It displays the musical structure of the audio file, the audio tempo grid.



Waveform Display

The waveform display shows the waveform image of the edited audio clip.

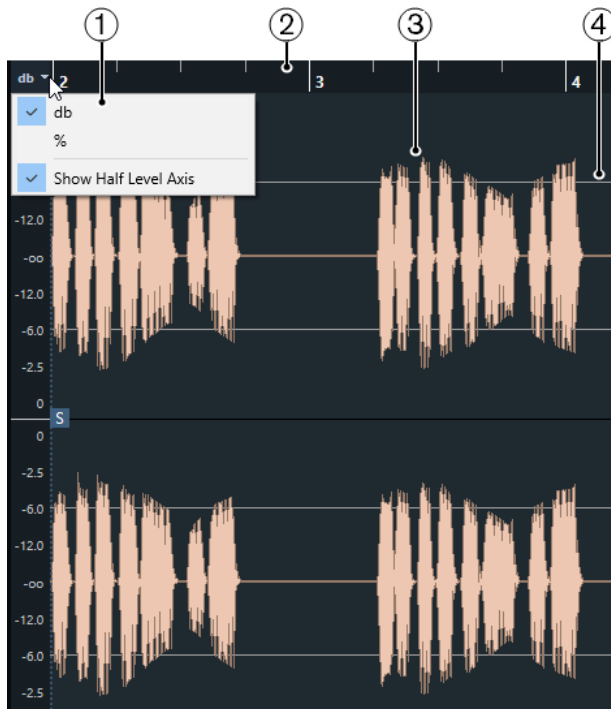

1 Level Scale menu

Allow you to show the level as a percentage or in dB. Here, you can also activate the display of the half level axis.

2 Ruler

Shows the project tempo grid.

3 Audio waveform

Shows the waveform image of the selected audio.

NOTE

You can show the waveform images of multiple selected audio events at once by activating **Show All Selected Audio Events** on the **Sample Editor** toolbar.

4 Half Level Axis

To show the half level axis, open the level scale menu and select **Show Half Level Axis**.

NOTE

You can set up a wave image style in the **Preferences** dialog (**Event Display—Audio** page).

Zooming Vertically

You can zoom in the waveform vertically. This allows you to see a specific detail of the waveform.

PROCEDURE

- Drag the vertical zoom slider down to zoom in or up to zoom out.



NOTE

If the **VariAudio** section is open, you can also zoom vertically if you deactivate **Zoom Tool Standard Mode: Horizontal Zooming only** in the **Preferences** dialog (**Editing—Tools** page) and drag a rectangle with the **Zoom** tool.

RESULT

The vertical scale changes relative to the height of the **Sample Editor**.

Zooming Horizontally

You can zoom in the waveform horizontally. This allows you to zoom in or out on the time scale.

PROCEDURE

- Drag the horizontal zoom slider to the right to zoom in or to the left to zoom out.



RESULT

The horizontal zoom setting is shown on the info line as samples per pixel. You can zoom in horizontally to a scale of less than one sample per pixel. This is required for using the **Draw** tool.

NOTE

- If you have zoomed in to one sample per pixel or less, the appearance of the samples depends on the **Interpolate Audio Waveforms** option in the **Preferences** dialog (**Event Display—Audio** page).
-

Zoom Submenu

The **Zoom** submenu of the **Edit** menu contains options for zooming in the **Sample Editor**.

- To open the **Zoom** submenu, select **Edit > Zoom**.

The following options are available:

Zoom In

Zooms in one step, centering on the project cursor.

Zoom Out

Zooms out one step, centering on the project cursor.

Zoom Full

Zooms out so that the whole clip is visible in the waveform display.

Zoom to Selection

Zooms out so that the whole clip is visible in the waveform display. If the **VariAudio** section is open, this zooms in horizontally and vertically so that the current selection fills the waveform display.

Zoom to Selection (Horiz.)

Zooms in horizontally so that the current selection fills the waveform display.

Zoom to Event

Zooms in so that the waveform display shows the section of the clip corresponding to the edited audio event. This is not available if you have opened the **Sample Editor** from the **Pool**.

Zoom In Vertically

Zooms in one step vertically.

Zoom Out Vertically

Zooms out one step vertically.

Undo/Redo Zoom

Allows you to undo/redo the last zoom operation.

Range Editing

In the **Sample Editor** you can edit selection ranges. This option is useful if you want to quickly edit or process a specific section in the audio waveform, or if you want to create a new event or clip.

You can only select one range at a time. The selection is indicated in the **Selection** field on the info line.

The **Range** section in the **Sample Editor Inspector** contains functions for working with regions.

RELATED LINKS

[Range Section](#) on page 583

[Shared Copies](#) on page 236

Selecting a Range

PREREQUISITE

Snap to Zero Crossing is activated on the toolbar. This option ensures that the start and the end of the selection are always at zero crossings.

PROCEDURE

1. On the toolbar, activate the **Range Selection** tool.
2. Click at the position in the waveform display where you want the range to start and drag to the position, where you want the range to end.
3. Optional: Perform one of the following actions to resize the selection range:
 - Drag the left or the right edge of the selection to a new position.
 - Hold down **Shift** and click at a new position.

RESULT

The selected range is highlighted in the waveform display.

NOTE

You can also use the functions in the **Select** pop-up menu to select ranges.

RELATED LINKS

[Select Menu](#) on page 588

Select Menu

Select Pop-Up Menu in the Range Section

On the **Select** pop-up menu in the **Range** section in the **Sample Editor Inspector**, the following functions are available:

Select All

Selects the whole clip.

Select None

Deselects everything.

Select in Loop

Selects the audio between the left and the right locator.

Select Event

Selects only the audio that is included in the edited event. If the **VariAudio** section is open and you segmented the audio, all segments that start or end within the event boundaries are selected.

Set Locators to Selection Range

Sets the locators to encompass the current selection. This option is available if you have selected one or several events or made a selection range.

Locate Selection

Moves the project cursor to the beginning or end of the current selection. This option is available if you have selected one or several events or made a selection range.

Loop Selection

Activates playback from the start of the selection and keeps starting over again at the selection end.

Select Submenu on the Edit Menu

If you select **Edit > Select**, the following functions are available:

All

Selects the whole clip.

None

Deselects everything.

In Loop

Selects the audio between the left and right locator.

From Start to Cursor

Selects the audio between the clip start and the project cursor.

From Cursor to End

Selects the audio between the project cursor and the clip end. This option is available if the project cursor is positioned between the clip boundaries.

Equal Pitch - all Octaves/same Octave

Selects all notes that have the same pitch as the selected note, in any octave or in the current octave. This option is available if the **VariAudio** section is open and **Edit VariAudio** is activated.

Events under Cursor

Selects all events that are touched by the project cursor. This option is available if the **VariAudio** section is open and **Edit VariAudio** is activated.

Select Event

Selects the event.

Left Selection Side to Cursor

Moves the left side of the selection range to the project cursor position. This option is available if the project cursor is positioned between the clip boundaries.

Right Selection Side to Cursor

Moves the right side of the selection range to the project cursor position or the end of the clip if the project cursor is positioned to the right of the clip.

Creating Events from Selection Ranges

You can create a new event that contains only the selected range.

PROCEDURE

1. Select a range.
 2. Drag the selection range to an audio track in the **Project** window.
-

RELATED LINKS

[Selecting a Range](#) on page 587

Creating Clips from Selection Ranges

You can create a new clip that contains only the selected range.

PROCEDURE

1. Select a range.
 2. Click the selected range and select **Audio > Bounce Selection**.
 3. Perform one of the following actions:
 - Click **Replace** if you want to replace the original.
 - Click **No** if you want to keep the original.
-

RESULT

A new **Sample Editor** window opens with the new clip. It refers to the same audio file as the original clip, but it contains the audio corresponding to the selection range only.

Creating Sampler Tracks from Selection Ranges

You can create a sampler track that contains only the selected range.

PROCEDURE

1. Select a range.
If you select no range, the event start/end is used.
 2. Open the **Range** section in the **Sample Editor Inspector**.
 3. Click **Create Sampler Track**.
-

RESULT

A new **Sampler Track** is created and added to the track list. The new sampler track contains your range selection.

Edit Menu for Selection Ranges

You can edit selection ranges.

- To edit a selection range, open the **Process** section in the **Sample Editor Inspector**, and select one of the **Basic Commands** pop-up menu functions.

NOTE

If you edit ranges of events that are shared copies, you are asked whether you want to create a new version of the clip. Select **New Version** if you want to edit the event, select **Continue** if all shared copies should be edited.

The following options are available:

Cut

Cuts the selected range from the clip and saves it in the clipboard. The section to the right of the range is moved to the left to fill the gap.

Copy

Copies the selected range to the clipboard.

Paste

Replaces the selected range with the data from the clipboard.

Delete

Removes the selected range from the clip. The section to the right of the range is moved to the left to fill the gap.

Insert Silence

Inserts a silent section with the same length as the current range selection at the selection start. The selected range is not replaced, but moved to the right.

Event or Range as Region

Creates a region from the selected range.

Make Direct Offline Processing Permanent

Allows you to apply all offline processing permanently to the audio.

RELATED LINKS

[Shared Copies](#) on page 236

[Applying Offline Processing Permanently](#) on page 547

Direct Offline Processing for Ranges

You can apply plug-in effects and audio processes to selection ranges.

- To apply a plug-in effect or an audio process to a selection range, open the **Process** section in the **Sample Editor Inspector**, and select one of the options in the **Add Plug-in** pop-up menu or in the **Add Process** pop-up menu.

NOTE

If you apply offline processing to ranges of events that are shared copies, you are asked whether you want to create a new version of the clip. Select **New Version** if you want to edit the event, select **Continue** if all shared copies should be edited.

RELATED LINKS

[Direct Offline Processing](#) on page 534

[Applying Processing](#) on page 540
[Shared Copies](#) on page 236

Regions List

Regions are sections within an audio clip that allow you to mark important sections in the audio. You can add and edit regions for the selected audio clip in the regions zone.

- To show or hide the **Regions**, click **Set up Window Layout** on the toolbar and activate or deactivate **Regions**.

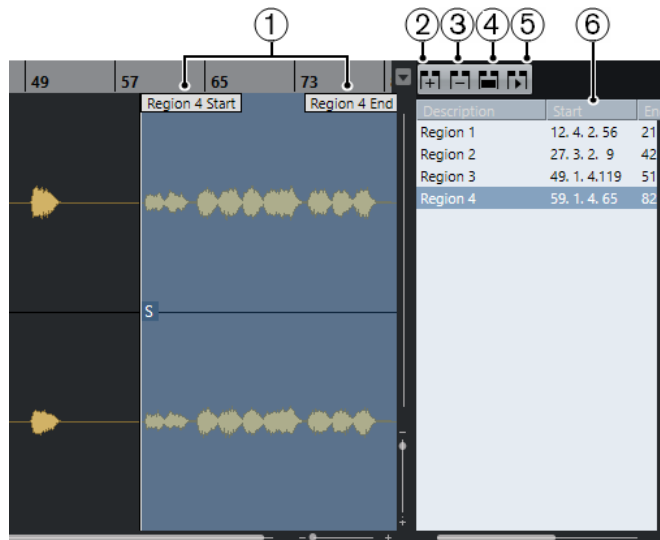

The following controls are available:

- 1 Region Start/Region End**
Shows the start and end of the region in the audio waveform.
- 2 Add Region**
Allows you to create a region of the current range selection.
- 3 Remove Region**
Allows you to remove the selected region.
- 4 Select Region**
If you select a region in the list and click this button above, the corresponding section of the audio clip is selected (as if you had selected it with the **Range Selection** tool) and zoomed. This is useful if you want to apply processing to the region only.
- 5 Play Region**
Plays back the selected region.
- 6 Regions list**
Allows you to select and display regions in the audio waveform.

Creating Regions

PREREQUISITE

You have clicked **Set up Window Layout** on the toolbar and activated **Regions**.

PROCEDURE

1. On the **Sample Editor** toolbar, activate the **Range Selection** tool and in the waveform display, select the range that you want to convert into a region.

2. Perform one of the following actions:
 - Above the regions list, click **Add Region**.
 - Select **Audio > Advanced > Event or Range as Region**.A region is created, corresponding to the selected range.
 3. Optional: Double-click the region name in the list and enter a new name.
-

RESULT

The region is added to the regions list.

AFTER COMPLETING THIS TASK

Click the region in the regions list to instantly display it in the **Sample Editor**.

RELATED LINKS

[Creating Regions](#) on page 602

Creating Regions from Hitpoints

You can create regions from hitpoints. This is useful to isolate specific sounds.

PREREQUISITE

The audio event from which you want to create regions is opened in the **Sample Editor** and the hitpoints are set at the correct positions.

PROCEDURE

- In the **Hitpoints** section of the **Sample Editor Inspector**, click **Create Regions**.
-

RESULT

Regions are created between two hitpoint positions and shown in the **Sample Editor**.

Adjusting Start and End Positions of Regions

PREREQUISITE

You have clicked **Set up Window Layout** on the toolbar and activated **Regions**. You have created regions.

PROCEDURE

- Perform one of the following actions:
 - Drag the **Region Start** or **Region End** handle to a different position in the waveform display.
 - Double-click the **Start** or **End** field in the regions list and enter a new value.

NOTE

The positions are shown in the display format selected for the ruler and info line, but are relative to the start of the audio clip.

Removing Regions

PREREQUISITE

You have clicked **Set up Window Layout** on the toolbar and activated **Regions**. You have created regions.

PROCEDURE

1. In the regions list, select the region that you want to remove.
 2. Above the regions list, click **Remove Region**.
-

RESULT

The region is removed from the regions list.

Creating Audio Events from Regions

You can create new audio events from regions using drag and drop.

PREREQUISITE

You have clicked **Set up Window Layout** on the toolbar and activated **Regions**. You have created regions.

PROCEDURE

1. Select the region in the regions list.
 2. Drag the region to the desired position in the **Project** window.
-

RESULT

An event is created from the region.

Snap Point

The snap point is a marker within an audio event that can be used as a reference position.

- To show the snap point, activate **Show Audio Event** on the toolbar.

The snap point is set at the audio event start, but you can move it to another relevant position in the audio.

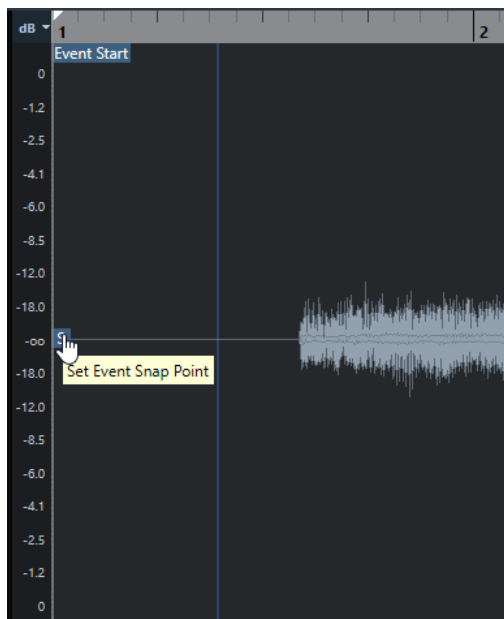

The snap point is used when **Snap** is activated and you insert a clip from the **Sample Editor** in the event display. It is also used when you move or copy events in the event display.

In the **Sample Editor**, you can edit the following snap points:

- Event Snap Point
This is shown in the **Sample Editor** if you open a clip from within the **Project** window.
- Clip Snap Point
This is shown in the **Sample Editor** if you open a clip from the **Pool**.

NOTE

The clip snap point serves as a template for the event snap point. However, it is the event snap point that is taken into account when snapping.

IMPORTANT

When you set the grid start in the **Definition** section, the snap point is moved to the grid start.

RELATED LINKS

[Sample Editor Toolbar](#) on page 576

Adjusting the Snap Point

PREREQUISITE

The audio event is opened in the **Sample Editor** and **Show Audio Event** is activated on the toolbar.

PROCEDURE

1. Optional: On the **Sample Editor** toolbar, select the **Scrub** tool.
This allows you to audition the audio while setting the snap point.
2. Move the mouse pointer over the snap point, and drag it to the desired position in the audio event.

The mouse pointer becomes a hand symbol and a tooltip indicates that you can set the snap point.

RESULT

The event snap point is adjusted to the position where you dragged it.

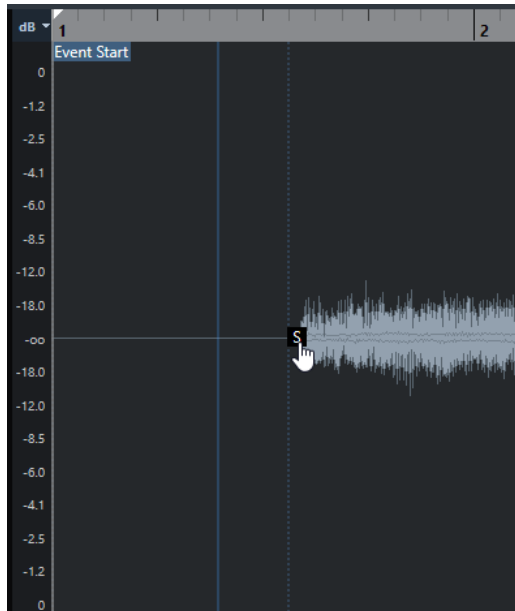

NOTE

You can also adjust the snap point by setting the project cursor at the desired position and selecting **Audio > Snap Point to Cursor**.

Hitpoints

Hitpoints mark musically relevant positions in audio files. Nuendo can detect these positions and create hitpoints automatically by analyzing onsets and melodic changes of the audio.

NOTE

All hitpoint operations can be performed in the **Sample Editor** window and in the lower zone editor.

When you add an audio file to your project by recording or by importing, Nuendo automatically detects hitpoints. In the **Project** window, hitpoints are shown for the selected event, provided that the zoom factor is high enough.

The hitpoint functions are available in the **Hitpoints** section of the **Sample Editor**.

You can use hitpoints for the following purposes:

- Create slices of the audio
Slices allow you to change tempo and timing of the audio without affecting its pitch and quality, or to replace or extract individual sounds from loops.
- Quantize audio
- Extract the groove from the audio
The timing is extracted from the audio and a groove map is created. You can use this groove map to quantize other events.
- Create markers from the audio
- Create regions from the audio
- Create events from the audio
- Create warp markers from the audio
- Create MIDI notes from the audio

NOTE

Hitpoints work best with drums, rhythmic recordings, or loops.

Calculating Hitpoints

When you add an audio file to your project by recording or by importing, Nuendo automatically detects hitpoints.

PROCEDURE

1. Import or record an audio file.
Nuendo automatically detects hitpoints.

NOTE

If your audio file is very long, this may take a while.

2. Select the audio event in the **Project** window and make sure the zoom factor is high enough.

RESULT

The calculated hitpoints for the selected event are shown in the **Project** window.

NOTE

You can disable automatic hitpoint detection by deactivating **Enable Automatic Hitpoint Detection** in the **Preferences** dialog (**Editing—Audio** page).

Hitpoint Filters in the Hitpoint Section

Nuendo automatically detects and filters hitpoints. However, if the result does not meet your expectations you can filter hitpoints manually.

- To filter hitpoints, open the audio event in the **Sample Editor** and open the **Hitpoints** section.

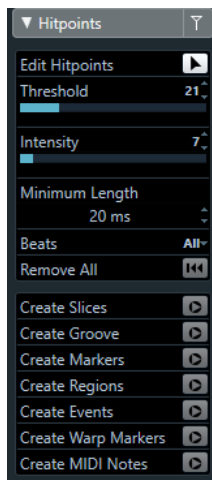

Threshold

Filters hitpoints by their peaks. Drag the slider to the right to discard hitpoints of quieter crosstalk signals, for example.

Intensity

Filters hitpoints by their intensity. Drag the slider to the right to discard less intense hitpoints.

Minimum Length

Filters hitpoints by their distance between two hitpoints. This option allows you to avoid creating slices that are too short.

Beats

Filters hitpoints by their musical position. This option allows you to discard hitpoints that do not fit within a certain range of a defined beat value.

Editing Hitpoints Manually

It is crucial for any further editing that the hitpoints are set at the correct positions. Therefore, if the automatic hitpoint detection does not meet your expectations, you can edit hitpoints manually.

PREREQUISITE

The audio event is opened in the **Sample Editor**, and in the **Hitpoints** section, hitpoints are filtered by their peak and/or intensity, by their distance, or by their musical position.

PROCEDURE

1. In the **Hitpoints** section in the **Sample Editor Inspector**, activate the **Edit Hitpoints** tool.



2. Move the mouse to the waveform display and click between two hitpoints. The mouse pointer changes to a speaker icon and the tooltip **Play back Slice** is shown. The slice is played back from the beginning to the end.

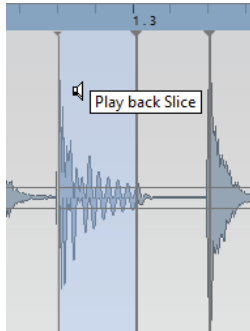

3. To disable a hitpoint that you do not need, press **Shift** and click on the line that represents the hitpoint. The mouse pointer changes to a cross icon and the tooltip **Disable Hitpoints** is shown. Disabled hitpoints are not taken into account for further operations.

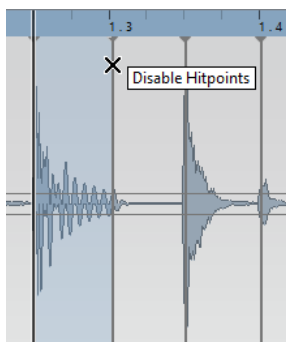

4. Press **Tab** to navigate to the next slice. The slice is played back automatically.
5. To insert a hitpoint, press **Alt/Opt** and click at the position where you want to insert the hitpoint. The mouse pointer changes to a draw icon and the tooltip **Insert Hitpoint** is shown.
6. To move a hitpoint, move the mouse pointer on the vertical line that represents the hitpoint, and drag to the left or to the right.

The mouse pointer changes to a double arrow and the tooltip **Move Hitpoint** is shown. Moved hitpoints are locked by default.

7. To make sure that a hitpoint is not accidentally filtered out, lock it by pointing at it and clicking.

The tooltip **Lock Hitpoint** is shown.

RESULT

The hitpoints are edited according to your settings.

NOTE

To reset a hitpoint to its original state, press **Ctrl/Cmd - Alt/Opt** until the tooltip **Enable/Unlock Hitpoints** is shown and click.

RELATED LINKS

[Hitpoint Filters in the Hitpoint Section](#) on page 597

Locating to Hitpoints in the Project Window

You can navigate through the hitpoints of an audio event in the **Project** window.

PREREQUISITE

Enable Automatic Hitpoint Detection is activated in the **Preferences** dialog (**Editing—Audio** page).

PROCEDURE

1. Select the audio track that contains the audio event for which you want to locate hitpoints.
 2. Perform one of the following actions:
 - Press **Alt/Opt - N** to navigate to the next hitpoint.
 - Press **Alt/Opt - B** to navigate to the previous hitpoint.
-

RESULT

The project cursor jumps to the respective hitpoint.

Slices

You can create slices from hitpoints, where each slice ideally represents an individual sound or beat of the audio.

You can use these slices to change tempo and timing of the audio without affecting its pitch and quality.

NOTE

Slices are created in the **Sample Editor** and edited in the **Audio Part Editor**.

Audio that meets the following characteristics is suitable:

- Individual sounds have a noticeable attack.
- The recording quality is good.
- The recording is free of crosstalk signals.
- The audio is free of smearing effects like delays, for example.

Slicing Audio

Slicing audio is useful if you want to change tempo and timing of the audio without affecting its pitch and quality.

PREREQUISITE

The audio event is opened in the **Sample Editor** and the hitpoints are set at the correct positions.

NOTE

When slicing audio, all events referring to the edited clip are also replaced.

PROCEDURE

- Perform one of the following actions:
 - In the **Hitpoints** section in the **Sample Editor Inspector**, click **Create Slices**.
 - Select **Audio > Hitpoints > Create Audio Slices from Hitpoints**.
-

RESULT

The areas between the hitpoints are sliced and become separate events. The original audio event is replaced by an audio part containing the slices.

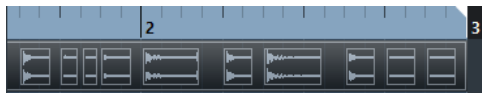

On playback, the audio plays back seamlessly at the project tempo.

AFTER COMPLETING THIS TASK

Change the project tempo. The slices are moved accordingly, keeping their relative positions within the part.

Double-click the sliced audio part and replace or extract individual slices in the **Audio Part Editor**.

RELATED LINKS

[Slices and the Project Tempo](#) on page 601

[Audio Part Editor](#) on page 639

Slicing Multi-Track Drum Recordings

You can slice all tracks of a multi-track drum recording at once.

PREREQUISITE

You have created a multi-track drum recording and set up an edit group for all the tracks.

PROCEDURE

- Select the folder track, and select **Audio > Hitpoints > Divide Audio Events at Hitpoints**.
-

RESULT

The audio of all tracks in the folder track is sliced.

RELATED LINKS

[Quantizing Multiple Audio Tracks](#) on page 324

[Group Editing Mode](#) on page 238

Slices and the Project Tempo

The project tempo affects how the sliced audio is played back.

RELATED LINKS

[Closing Gaps](#) on page 601

[Deleting Overlaps](#) on page 601

[Musical Mode](#) on page 606

[Making Global Auto Fade Settings](#) on page 349

[Making Auto Fade Settings for Individual Tracks](#) on page 349

Closing Gaps

If the project tempo is slower than the tempo of the original audio event, there may be audible gaps between the slice events in the part. You can close these gaps so that the audio plays without any breaks.

PROCEDURE

- Do one of the following:
 - Select **Audio > Advanced > Close Gaps (Time Stretch)** to apply time stretch to each slice and close the gaps.
Consider activating auto fades for the corresponding audio track, and setting the fade-out to 10 ms to eliminate clicks.
 - Select **Audio > Advanced > Close Gaps (Crossfade)** to apply crossfades to the slices and close the gaps.

AFTER COMPLETING THIS TASK

NOTE

If you decide to change the tempo again, undo your actions and use the original, unstretched file.

Deleting Overlaps

If the project tempo is higher than the tempo of the original audio event, the slice events in the part may overlap. You can delete these overlaps.

PROCEDURE

1. Right-click the track in the track list and from the context menu, select **Auto Fades Settings**.
 2. In the **Auto Fades** dialog, activate **Auto Crossfades**.
 3. Click **OK**.
 4. Select the overlapping events in the part and select **Audio > Advanced > Delete Overlaps**.
-

RESULT

The sound is smoothed out.

Creating a Groove Quantize Map

You can use hitpoints to create a groove quantize map.

PREREQUISITE

The audio event from which you want to extract the timing is opened in the **Sample Editor**, and the hitpoints are set at the correct positions.

PROCEDURE

- In the **Hitpoints** section in the **Sample Editor Inspector**, click **Create Groove**.

RESULT

The groove is extracted from the audio event and automatically selected in the **Quantize Presets** pop-up menu on the **Project** window toolbar.

AFTER COMPLETING THIS TASK

Open the **Quantize Panel** and save the groove as a preset.

Creating Markers

You can create markers at hitpoint positions. This allows you to snap to hitpoint positions.

PREREQUISITE

The audio event from which you want to create markers is opened in the **Sample Editor**, and the hitpoints are set at the correct positions.

PROCEDURE

- In the **Hitpoints** section in the **Sample Editor Inspector**, click **Create Markers**.

RESULT

If your project has no marker track, a marker track is added and activated automatically, and a marker is created at every hitpoint position.

RELATED LINKS

[Markers](#) on page 368

Creating Regions

You can create regions at hitpoint positions. This allows you to isolate recorded sounds.

PREREQUISITE

The audio event from which you want to create regions is opened in the **Sample Editor**, and the hitpoints are set at the correct positions.

PROCEDURE

- In the **Hitpoints** section in the **Sample Editor Inspector**, click **Create Regions**.

RESULT

Regions are created between two hitpoint positions and shown in the **Sample Editor**.

RELATED LINKS

[Creating Regions](#) on page 591

Creating Events

You can create events at hitpoint positions.

PREREQUISITE

The audio event from which you want to create events is opened in the **Sample Editor**, and the hitpoints are set at the correct positions.

PROCEDURE

- In the **Hitpoints** section in the **Sample Editor Inspector**, click **Create Events**.

RESULT

Events are created between two hitpoint positions.

Creating Warp Markers

You can create warp markers at hitpoint positions. This allows you to quantize audio based on hitpoint positions.

PREREQUISITE

The audio event from which you want to create warp markers is opened in the **Sample Editor**, and the hitpoints are set at the correct positions.

PROCEDURE

- In the **Hitpoints** section in the **Inspector**, click **Create Warp Markers**.

RESULT

Warp markers are created at every hitpoint position.

AFTER COMPLETING THIS TASK

Open the **AudioWarp** section to show and edit the warp markers.

RELATED LINKS

[Tempo Matching Audio](#) on page 605

Creating MIDI Notes

You can create MIDI notes from hitpoints. This allows you to double, replace, or enrich drum hits by triggering sounds of a VST instrument.

PREREQUISITE

The audio event from which you want to create MIDI notes is opened in the **Sample Editor**, and the hitpoints are set at the correct positions.

PROCEDURE

1. In the **Hitpoints** section in the **Sample Editor Inspector**, click **Create MIDI Notes**.
2. In the **Convert Hitpoints to MIDI Notes** dialog, set up the parameters.

3. Click **OK**.

RESULT

A MIDI track is added to your project, and MIDI notes are created at every hitpoint position.

AFTER COMPLETING THIS TASK

Assign a VST instrument to the MIDI track, and select a sound to enrich the audio.

Convert Hitpoints to MIDI Notes Dialog

The **Convert Hitpoints to MIDI Notes** dialog allows you to specify how hitpoints should be converted when you create MIDI notes from hitpoints.

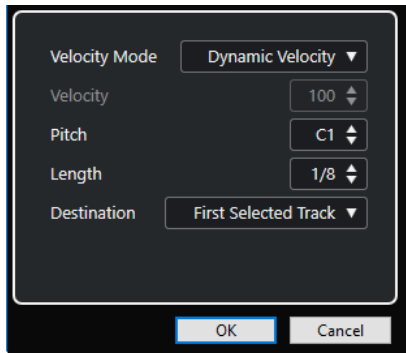

The following options are available:

Velocity Mode

Allows you to select a velocity mode:

- If you want the velocity values of the created MIDI notes to vary according to the peak levels of the corresponding hitpoints, select **Dynamic Velocity**.
- If you want to assign the same velocity value to all created MIDI notes, select **Fixed Velocity**.

Velocity

Sets the **Fixed Velocity**.

Pitch

Sets a note pitch for all created MIDI notes.

Length

Sets a note length for all created MIDI notes.

Destination

Allows you to select a destination:

- To place the MIDI part on the first selected MIDI or instrument track, select **First Selected Track**.

NOTE

Any MIDI parts from previous conversions on this track will be deleted.

- To create a new MIDI track for the MIDI part, select **New MIDI Track**.
- To copy the MIDI part to the clipboard, select **Project Clipboard**.

Tempo Matching Audio

Nuendo offers several functions that allow you to match the tempo of audio in your project.

In the **Sample Editor** window and in the lower zone editor, you can perform the following tempo matching operations:

- **Stretch to Project Tempo**
Stretches the selected event to match the project tempo.
- **Musical Mode**
Applies realtime time stretching to audio clips, so that they match the project tempo.
- **Auto Adjust**
Extracts a definition grid from your audio. After that, you can match the audio with the project tempo by using **Musical Mode**.
- **Manual Adjust**
Allows you to manually modify the grid and tempo of your audio file. After that, you can match the audio with the project tempo by using **Musical Mode**.
- **Free Warp**
Allows you to change the timing of individual positions in your audio.

NOTE

In the **Project** window, you can match the tempo of different audio events using the **Audio Alignment** tool. This allows you to match the timing of audio events on different tracks.

RELATED LINKS

[Stretching Audio Events to the Project Tempo](#) on page 606

[Musical Mode](#) on page 606

[Auto Adjust](#) on page 608

[Manual Adjust](#) on page 609

[Free Warp](#) on page 610

[Audio Alignment](#) on page 220

Algorithm Presets

You can select an algorithm preset that is applied for realtime playback and time stretching.

The **Warping Algorithm for Audio Clip** pop-up menu on the **Sample Editor** toolbar contains various presets that determine the audio quality of the realtime time stretching.

These presets are sorted into the categories **élastique** and **Standard** according to the technology used.

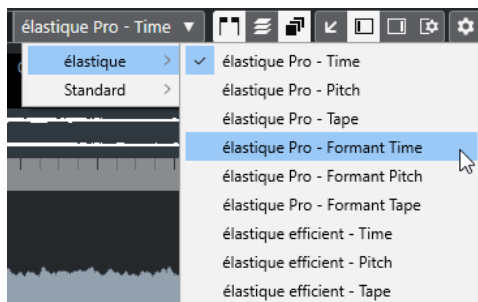

The algorithm preset affects warp changes in **Musical Mode**, **FreeWarp**, **Swing**, and **Audio Alignment**. For the VariAudio warping and pitching features **Standard – Solo** is applied automatically.

RELATED LINKS

[Algorithm Presets](#) on page 605

[Time Stretch and Pitch Shift Algorithms](#) on page 559

[Audio Alignment](#) on page 220

Stretching Audio Events to the Project Tempo

You can stretch audio loops to the project tempo.

PROCEDURE

1. Select **File > Import > Audio File**, select the audio loop that you want to import, and click **OK**.
2. Select the audio loop in the project.
3. Select **Audio > Advanced > Stretch to Project Tempo**.

RESULT

The audio loop is stretched to match the project tempo.

Musical Mode

The **Musical Mode** allows you to tempo-match audio loops to the project tempo.

If you activate **Musical Mode** for an audio clip, realtime time stretching is applied to the clip so that it matches the project tempo. The audio events adapt to any tempo changes in Nuendo, just like MIDI events.

In the **Sample Editor**, you can activate **Musical Mode** in the **AudioWarp** section, the **Definition** section, and the toolbar.

NOTE

- You can also activate/deactivate **Musical Mode** from within the **Pool** by clicking the corresponding checkbox in the **Musical Mode** column.
 - Nuendo supports ACID® loops. These loops are standard audio files but with embedded tempo/length information. When ACID® files are imported into Nuendo, **Musical Mode** is automatically activated and the loops will adapt to the project tempo.
-

Matching Audio to the Project Tempo

You can use **Musical Mode** to adjust audio loops to the project tempo. Loops are short audio files that have a defined number of bars.

PROCEDURE

1. Select **File > Import > Audio File**, and select an audio loop in the file dialog.
2. In the **Project** window, double-click the imported audio loop to open it in the **Sample Editor**.
3. Open the **Definition** section and verify the rulers.

The project tempo grid shown in the upper ruler and the grid of your audio shown in the lower ruler do not match.



4. On the toolbar, verify that the length in bars corresponds to the length of the imported audio file. If necessary, listen to your audio and enter the correct length in bars and beats.
5. On the toolbar, open the **Algorithm** pop-up menu, and select a preset.
6. Listen to the loop and if necessary correct the **Bars** and **Beats** values on the toolbar.
7. Activate **Musical Mode**.

RESULT

The loop is warped and stretched to the project tempo. The rulers reflect the change.

In the **Project** window, the audio event shows a note symbol and a warp symbol. This indicates that time stretching has been applied.

RELATED LINKS

[Algorithm Presets](#) on page 605

Applying Swing

The **Swing** function allows you to add swing to audio that sounds too straight.

PREREQUISITE

You have opened your audio in the **Sample Editor**, and **Musical Mode** is activated.

PROCEDURE

1. On the toolbar, open the **Algorithm** pop-up menu, and select a preset.
2. Open the **AudioWarp** section, and from the **Resolution** pop-up menu select a grid resolution.

This defines the positions that the swing is applied to. If you select **1/2**, the swing is applied in steps of half notes, for example.

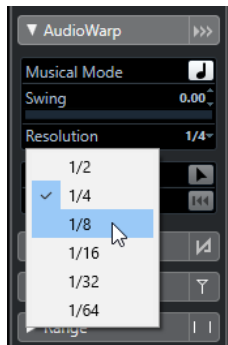

3. Move the **Swing** fader to the right.
-

RESULT

This offsets the grid positions and creates a swing or shuffle feel. If you selected **1/2**, every second position in the grid is offset.

Auto Adjust

The **Auto Adjust** function is useful if you do not know the tempo of your audio file, or if the beat is not straight. It allows you to extract a definition grid from your audio. After that, you can tempo match the file to the project tempo with the **Musical Mode**.

The **Auto Adjust** function extracts a local definition grid that you can match with the project tempo using **Musical Mode**.

RELATED LINKS

[Musical Mode](#) on page 606

Extracting a Tempo Definition Grid from Audio

If you have an audio file with an unknown tempo or a beat that is not straight, and you want to match it to the project tempo, you must first extract its tempo definition grid. This is done with the **Auto Adjust** function in the **Definition** section of the **Sample Editor**.

PREREQUISITE

You have defined a range in your audio clip or event that starts and ends at a barline.

PROCEDURE

1. Double-click the audio clip or event in the **Project** window to open it in the **Sample Editor**.
2. Open the **Definition** section, and select a value from the **Grid** pop-up menu.
This determines the grid resolution for your audio.
3. With the **Range Selection** tool, select the section that you want to use in your project, and that covers one or several bars.

NOTE

If you do not select a range, the grid is calculated for the audio event. If no audio event is defined, the grid is calculated for the clip. Make sure that the event or clip starts and ends on a barline.

4. Click **Auto Adjust**.
-

RESULT

The definition grid is calculated for the selected section. The snap point moves to the start of the selected range. The audio tempo definition ruler changes to reflect your edits, and bars and beats positions are marked with vertical lines.

Manual Adjust

The **Manual Adjust** function is useful if you need to manually modify the grid and tempo of your audio file. This is the case if the extraction of a definition grid with the **Auto Adjust** function did not bring satisfying results, for example.

The **Manual Adjust** function allows you to correct the local definition grid. After this, you can match it with the project tempo using **Musical Mode**.

RELATED LINKS

[Musical Mode](#) on page 606

Correcting the Audio Definition Grid

If the extraction of a definition grid with the **Auto Adjust** function did not bring satisfying results, you can correct the grid and tempo of your audio file with the **Manual Adjust** function.

PROCEDURE

1. Double-click the audio clip or event in the **Project** window to open it in the **Sample Editor**.
2. Open the **Definition** section, and activate **Manual Adjust**.
3. Move the mouse pointer to the beginning of the audio clip.

The tooltip **Set Grid Start** is shown, and the mouse pointer turns into a double arrow.

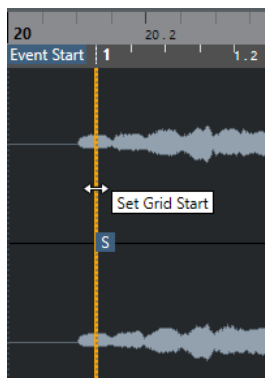

4. Click and drag to the right until the first downbeat and release the mouse button.
This matches the grid start and the snap point with the first main beat. The audio tempo definition ruler changes to reflect your edits.
5. In the upper part of the waveform, move the mouse pointer to the vertical line nearest to the second bar.
The tooltip **Stretch Grid** and a blue vertical line are shown.
6. Click and drag to the position of the first downbeat in the second bar and release the mouse button.
This sets the beginning of the next bar. All following bar positions in the grid are stretched or compressed so that all bars have the same length.

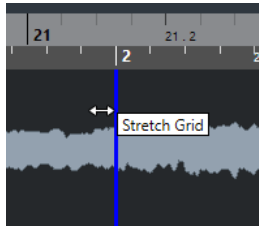

7. In the lower part of the waveform, move the mouse pointer over the grid lines. The tooltip **Set Bar Position (Move Following Bars)** and a green vertical line are shown.
8. For incorrect bar positions, click and drag the green vertical line to the position of the first downbeat of the following bar and release the mouse button. This also moves the bars to the right. The area to the left remains unaffected.

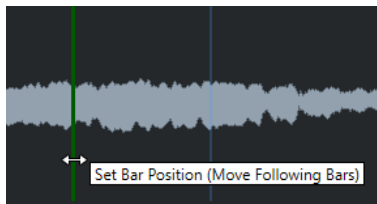

9. Move the mouse pointer over the grid lines for single beats. The tooltip **Set Beat Position** and a blue vertical line are shown.
10. Click and drag the grid line to align single, incorrect beat positions and release the mouse button.

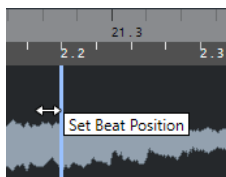

NOTE

You can remove misplaced beat edits by pressing any modifier key and clicking with the **Erase** tool.

RESULT

The definition grid is corrected, the audio tempo definition ruler reflects your edits.

AFTER COMPLETING THIS TASK

Activate **Musical Mode**.

Free Warp

The **Free Warp** tool allows you to correct the timing of individual positions in the audio material. This is useful if you want to synchronize audio to video.

You can create and edit warp markers and drag them to musically relevant time positions in an audio event. This way, the audio before and after the warp marker is stretched. The amount of stretch is shown next to the warp marker handle.



A stretch factor higher than 1.0 indicates that the audio preceding the warp marker is stretched, a stretch factor lower than 1.0 indicates that the audio is compressed.

NOTE

The **Free Warp** tool snaps to hitpoint positions and warp markers.

Correcting the Timing with the Free Warp Tool

PROCEDURE

1. Double-click the audio clip or event in the **Project** window to open it in the **Sample Editor**.
 2. On the toolbar, activate **Snap to Zero Crossing**.
If this button is activated, warp markers snap to zero crossings.
 3. Optional: If you want to correct the timing of individual positions in the audio, define the local definition with the **Auto Adjust** or the **Manual Adjust** function, and activate **Musical Mode**.
 4. On the **Transport** panel, activate **Click**, and play back the audio to determine positions where the beat is not on time with the click.
 5. In the **AudioWarp** section, activate **Free Warp**, place the mouse pointer at the position of the beat that you want to adjust, click, and hold.
The mouse pointer changes to a clock with arrows, and a warp marker is inserted.
 6. Drag the warp marker to the new position, and release the mouse button.
-

RESULT

The beat is now aligned with the corresponding position in the project.

RELATED LINKS

- [Auto Adjust](#) on page 608
- [Manual Adjust](#) on page 609
- [Musical Mode](#) on page 606

Correcting Warp Marker Positions

PROCEDURE

1. In the **AudioWarp** section, activate **Free Warp**.
2. In the **Sample Editor**, click the warp marker handle and drag it to a new position.

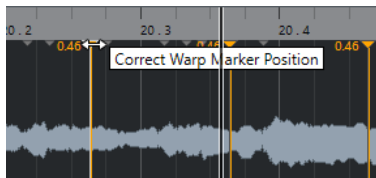

A tooltip is shown to indicate that you can drag to correct the warp marker position.

RESULT

The warp marker moves to the new position and the audio is stretched or compressed accordingly.

Deleting Warp Markers

PROCEDURE

1. In the **AudioWarp** section, activate **Free Warp**.
2. Hold down **Alt/Opt** and click the warp marker you want to delete.

NOTE

To delete several markers, draw a selection rectangle.

RESULT

The warp marker is removed from the waveform.

Resetting Warp Markers

PROCEDURE

- In the **AudioWarp** section, click **Reset Warp Changes**.
-

RESULT

The warp markers are removed from the waveform, and the warp edits of the waveform are reset.

NOTE

If **Musical Mode** is activated, only **Free Warp** edits are reset.

Flattening Realtime Processing

You can flatten warp modifications. This is useful if you want to reduce the CPU load, optimize the sound quality of the processing, or apply any offline processing.

PROCEDURE

1. Select the audio events that you want to process.
2. Perform one of the following actions:
 - Select **Audio > Realtime Processing > Flatten Realtime Processing**.
 - In the **Process** section of the **Sample Editor**, click **Flatten**.
3. In the **Flatten Realtime Processing** dialog, select an algorithm preset.

4. Click **OK**.

RESULT

Any loop that was previously stretched in realtime plays back exactly the same, but the warp markers discarded.

RELATED LINKS

[MPEX](#) on page 559

Flatten Realtime Processing Dialog

The **Flatten Realtime Processing** dialog allows you to select an algorithm.

- To open the **Flatten Realtime Processing** dialog, select one or more audio event in the **Project** window, and select **Audio > Realtime Processing > Flatten Realtime Processing**.

NOTE

This option is only available, if you have performed warp modifications.

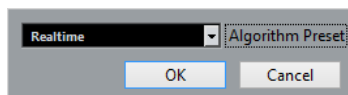

The following options are available:

Algorithm Preset

Allows you to select an algorithm preset.

Unstretching Audio Files

You can remove realtime time stretching from audio events.

PREREQUISITE

You have stretched an audio event in the **Sample Editor** with the **Free Warp** tool, or in the **Project** window with the **Object Selection** tool in **Sizing Applies Time Stretch** mode.

PROCEDURE

1. Select the audio event that you want to unstretch.
 2. Select **Audio > Realtime Processing > Unstretch Audio**.
-

RESULT

All realtime time stretching is removed.

Pitch Editing and Time Correction with VariAudio

The VariAudio features in Nuendo allow you to edit pitch, and correct the timing and intonation of individual notes in monophonic vocal recordings.

All VariAudio operations can be performed in the **Sample Editor** window and in the lower zone editor. Any modifications to the audio material can be undone.

NOTE

The VariAudio features are optimized for monophonic recordings of vocals. It may work well for other monophonic recordings, such as saxophone, as well. However, the quality of the result depends greatly on the recording.

Before you can edit the pitch and correct the timing of monophonic recordings, Nuendo must analyze the audio and split it into segments. These segments are graphic representations of the individual notes.

NOTE

Due to the data gained during segmentation, the audio and thus the size of your project can increase.

RELATED LINKS

[Segmenting Monophonic Audio](#) on page 618

[Segments and Gaps](#) on page 619

VariAudio and Offline Processes

If you apply offline processes and edits that affect the length of audio files that contain VariAudio data, existing VariAudio data becomes invalid. We therefore recommend that you apply offline processing or edits before using the VariAudio features.

The following processes and edits may lead to the reanalysis of the audio material:

- All offline processes in the **Processes** submenu of the **Audio** menu, except **Envelope**, **Fade In**, **Fade Out**, **Normalize**, and **Silence**.
- Effect processes in the submenu **Audio > Plug-ins**.
- Cutting, pasting, deleting, or drawing in the **Sample Editor**.

VariAudio Inspector Section

The **VariAudio** section allows you to edit individual notes of your audio file, change their pitch or timing, and to extract MIDI from your audio.

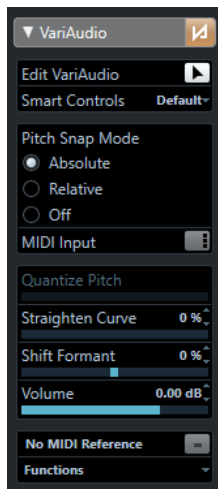

Bypass VariAudio Changes

Bypasses pitch, formant shift, and volume changes so that you can compare the changes to the original audio.

Edit VariAudio

Activates the audio analysis, splits the audio into segments that are shown in the waveform image, and enables VariAudio editing.

Smart Controls

Allows you to select how many smart controls are shown on the segments. **Default** shows the frequently used smart controls, while **All** shows all smart controls.

Pitch Snap Mode

Allows you to choose how a segment snaps to a specific pitch when you move it with the mouse or the **Up Arrow / Down Arrow** keys.

MIDI Input

Allows you to change the pitch of a segment via MIDI input.

Quantize Pitch

Allows you to quantize the pitch of a segment.

Straighten Curve

Allows you to straighten the pitch curve of a segment.

Shift Formant

Allows you to shift the formants of a segment without affecting the pitch or timing.

Volume

Allows you to edit the volume of a segment.

Show MIDI Reference Track

Allows you to show a MIDI reference track in the event display.

Functions

Opens a pop-up menu with other functions.

RELATED LINKS

[VariAudio Section](#) on page 582

- [Smart Controls](#) on page 616
- [Pitch Snap Mode](#) on page 624
- [MIDI Input Modes](#) on page 626
- [Quantizing Pitches](#) on page 626
- [Straightening Pitch Curves](#) on page 629
- [Formant Shifting](#) on page 632
- [Showing MIDI Reference Tracks](#) on page 631
- [Editing Volume](#) on page 633
- [Functions Menu](#) on page 633

Smart Controls

Each segment has smart controls that allow you to change the start and end points of the segment and to perform pitch changes, volume editing, formant shifting, and timing modifications of the associated audio.

- To show the smart controls on a segment, zoom in on the segment, and move the mouse pointer over it.

NOTE

In the **Smart Controls** pop-up menu in the **Sample Editor Inspector** you can select **All** mode to show all smart controls or **Default** to show the frequently used smart controls.

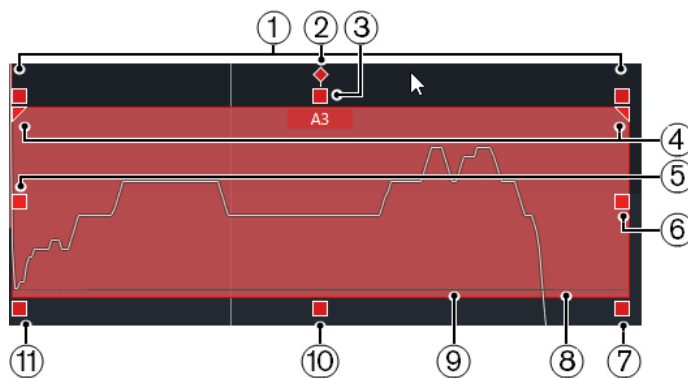

The following smart controls are available:

1 Tilt

This smart control is only shown if you select **All** in the **Smart Controls** pop-up menu in the **Sample Editor Inspector**.

It allows you to tilt the pitch curve upwards or downwards. The smart control on the left allows you to tilt the start of the curve, the smart control on the right allows you to tilt the end of the curve. Press **Alt/Opt** to rotate the curve around the tilt/rotate anchor.

2 Set Tilt/Rotate Anchor

This smart control is only shown if you select **All** in the **Smart Controls** pop-up menu in the **Sample Editor Inspector**.

By default, the pitch curve is tilted or rotated around the center of the segment. This smart control allows you to move the anchor to the left or to the right.

3 Straighten Pitch Curve

This smart control is shown by default.

It allows you to straighten the pitch curve. This also works on a selection of segments.

4 Set Range for Straighten Pitch Curve

This smart control is only shown if you select **All** in the **Smart Controls** pop-up menu in the **Sample Editor Inspector**.

By default, the entire pitch curve is straightened. These smart controls allow you to set a range for **Straighten Pitch Curve**. Use this smart control for several selected segments to set the same range for all selected segments.

5 **Warp Start/Correct Segment Start**

This smart control is shown by default.

Allows you to warp the segment start. Press **Alt/Opt** to correct the segment start.

6 **Warp End/Correct Segment End**

This smart control is shown by default.

Allows you to warp the segment end. Press **Alt/Opt** to correct the segment end.

7 **Volume**

This smart control is only shown if you select **All** in the **Smart Controls** pop-up menu in the **Sample Editor Inspector**.

Allows you to edit the volume of the segment. To mute a segment, turn the volume down. This also works on a selection of segments.

8 **Glue Segments**

This smart control is shown by default.

Allows you to glue the segment to the adjacent segment. This also works on a selection of segments.

9 **Split Segment**

This smart control is shown by default.

Allows you to split the segment. This also works on a selection of segments.

10 **Quantize Pitch**

This smart control is shown by default.

Allows you to quantize the pitch of the segment to the nearest semitone position. This also works on a selection of segments.

11 **Shift Formant**

This smart control is only shown if you select **All** in the **Smart Controls** pop-up menu in the **Sample Editor Inspector**.

Allows you to shift the formants of the segment. This also works on a selection of segments.

RELATED LINKS

[Navigation and Zoom](#) on page 620

[Tilting a Pitch Curve](#) on page 628

[Straightening Pitch Curves](#) on page 629

[Pitch Snap Mode](#) on page 624

[Warping Segments](#) on page 630

[Changing the Start and End Point of Segments](#) on page 623

[Splitting Segments](#) on page 621

[Gluing Segments](#) on page 622

[Quantizing Pitches](#) on page 626

[Formant Shifting](#) on page 632

[Editing Volume](#) on page 633

Segmenting Monophonic Audio

To be able to edit the pitch and correct the timing of monophonic recordings, Nuendo must analyze the audio and split it into segments.

PROCEDURE

1. In the **Project** window, double-click the monophonic vocal recording to open the **Sample Editor**.
2. In the **Sample Editor Inspector**, click **VariAudio** to open the **VariAudio** section.
A waveform image of the audio is shown.
3. Activate **Edit VariAudio**.

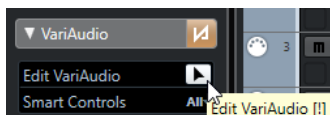

RESULT

Nuendo automatically analyzes the audio and splits it into segments that are shown in the waveform image. The segments allow you to associate the individual notes to their pitch that is displayed on the piano keyboard to the left, and their duration that is displayed on the timeline. If you move the mouse pointer over a segment, the pitch of that segment is shown on the segment.

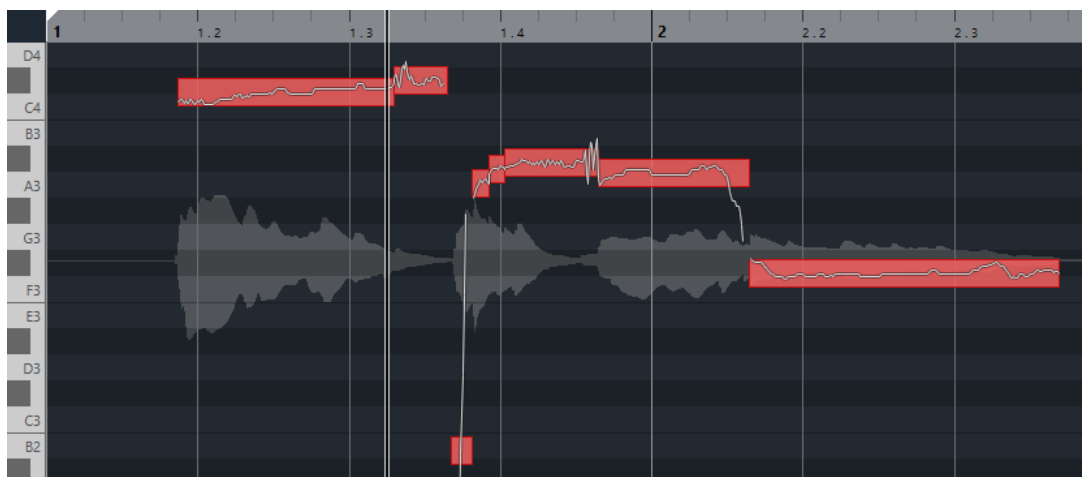

NOTE

The analysis of long audio files may take some time.

RELATED LINKS

[Segments and Gaps](#) on page 619

Segments and Gaps

Nuendo automatically analyzes the audio and splits it into segments.

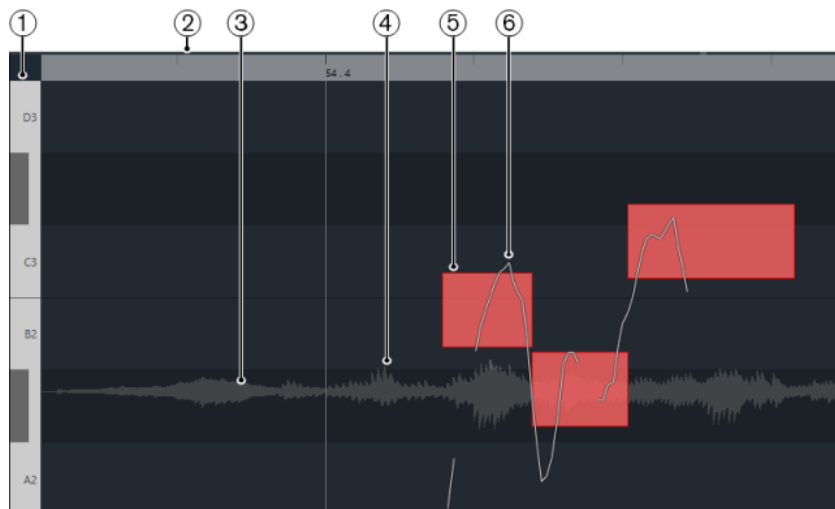

The following concepts are crucial to understand the segmentation:

1 Pitch Position

The pitch position of the segments is displayed on the piano keyboard to the left of the waveform. If you move the mouse pointer over a segment, the pitch of that segment is also shown on the segment. Pitches represent the perceived fundamental frequency of the note. The average pitch of a segment is calculated from its pitch curve.

2 Time Position

The time position and the length of the segments are indicated by the timeline.

3 Audio Waveform

The audio waveform is always shown as mono, even if you have opened a stereo or multi-channel file.

4 Gap

The gaps in between segments represent the non-tonal portions of the analyzed audio. These can be caused by breath sounds or rests, for example.

NOTE

Gaps, caused by weak audio signals or audio sections with unclear pitch information, such as consonants or effect sounds, must be included in the segments manually. To do this, you must change the start and end points of a segment. Otherwise, later pitch modifications affect only the tonal portions.

5 Segment

The segments represent the tonal portions of the analyzed audio. The pitch and time position of the segments allow you to associate the segments to the original audio.

6 Pitch Curve

The pitch curves that are shown in the segments represent the progression of the pitch.

RELATED LINKS

[Changing the Start and End Point of Segments](#) on page 623

VariAudio Segment Colors Menu

You can select a color scheme for VariAudio segments. If you work with several audio events, this makes it easier to see which segments belong to which event.

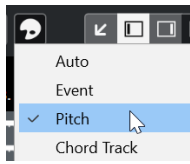

The following options are available:

Auto

Segments that belong to the same voice get the same color.

Event

Segments get the same color as the corresponding event in the **Project** window.

Pitch

Segments get colors depending on their pitches.

Chord Track

Segments that match the corresponding chord or scale events on the chord track get a specific color.

Auditioning

You can audition the segments one by one or in a loop, or play them back from the beginning to the end.

PROCEDURE

- Do one of the following:
 - Select the segments and activate **Audition**.

NOTE

To play back selected segments in a loop, activate **Audition Loop**.

- Select the **Play** tool and click the position where you want to start playback.
-

RELATED LINKS

[Sample Editor Toolbar](#) on page 576

Navigation and Zoom

You can navigate through the segments and zoom in on them.

- To navigate through the segments, use the **Left Arrow** key or the **Right Arrow** key on your computer keyboard.
- To zoom in on segments, hold down **Alt/Opt** and draw a selection rectangle.
- To zoom out, hold down **Alt/Opt** and click in an empty area of the waveform.
- To zoom out to show all segments, hold down **Alt/Opt** and double-click in an empty area of the waveform.

Segment Editing

Segment editing might be necessary if the original audio contains non-tonal portions of the analyzed audio, that is, signals or sections with unclear pitch information, such as consonants or effect sounds.

Non-tonal portions of the analyzed audio might not be included in a segment. If this is the case, pitch changes, volume editing, formant shifting, or timing modifications affect only the tonal portions. On the other hand, segments can contain unwanted notes or tonal portions.

To prevent this, you can edit the segments manually by using the smart controls.

Segment editing includes:

- Shortening segments by splitting them, or changing their start or end point
- Enlarging segments by gluing them to the next segment, or by changing their start or end point
- Deleting segments

NOTE

Changing the length of a segment may lead to a different average pitch and therefore to a pitch change.

RELATED LINKS

[Changing the Start and End Point of Segments](#) on page 623

[Splitting Segments](#) on page 621

[Gluing Segments](#) on page 622

[Deleting Segments](#) on page 622

[Segments and Gaps](#) on page 619

[Smart Controls](#) on page 616

Splitting Segments

If a segment includes more than one note, you can split it.

PREREQUISITE

You have opened the audio in the **Sample Editor** and activated **Edit VariAudio** in the **VariAudio** section.

PROCEDURE

1. Select one or several segments.
 2. On the **Sample Editor** toolbar, activate **Audition** to audition the segments.
 3. Compare the segments with the pitch curve for each note.
 4. If a segment includes more than one note, do one of the following:
 - Use the smart control for **Split Segment** on the bottom edge of the segment, and click.
 - Hold down **Alt/Opt**, and click anywhere above the smart control for **Split Segment**.
-

RESULT

The segment is split and the average pitch is recalculated.

NOTE

Splitting a segment may lead to a different average pitch and therefore to a pitch change.

AFTER COMPLETING THIS TASK

If splitting the segment results in a wrong pitch, move the segment vertically.

RELATED LINKS

[Segmenting Monophonic Audio](#) on page 618

[Smart Controls](#) on page 616

Gluing Segments

If a single sound is spread over multiple segments, you can glue these segments.

PREREQUISITE

You have opened the audio in the **Sample Editor** and activated **Edit VariAudio** in the **VariAudio** section.

PROCEDURE

1. On the **Sample Editor** toolbar, activate **Audition** to audition the segments.
2. Compare the segments with the pitch curve for each note.
3. Do one of the following:
 - Use the smart control for **Glue Segments** on the bottom left edge of a segment, and click to glue it to the previous segment.
 - Use the smart control for **Glue Segments** on the bottom right edge of a segment, and click to glue it to the next segment.
 - Select several contiguous segments, use the smart control for **Glue Segments** on the bottom left or right edge of one of the segments, and click to glue the selected segments.

RESULT

The segments are glued together. The average pitch of the segment is recalculated.

RELATED LINKS

[Segmenting Monophonic Audio](#) on page 618

[Smart Controls](#) on page 616

Deleting Segments

You can delete segments. This is useful if a segment only contains non-tonal portions of the audio, and therefore does not require any pitch editing.

PREREQUISITE

You have opened the audio in the **Sample Editor** and activated **Edit VariAudio** in the **VariAudio** section.

PROCEDURE

1. Select one or several segments.
2. On the **Sample Editor** toolbar, activate **Audition** to audition the segments.
3. Compare the segments with the pitch curve for each note.
4. Select the segment that you want to delete, and press **Backspace**.

RESULT

The segment is deleted.

RELATED LINKS

[Segmenting Monophonic Audio](#) on page 618

Changing the Start and End Point of Segments

If the start or end point of a segment does not match the associated audio, you can change it.

PREREQUISITE

You have opened the audio in the **Sample Editor** and activated **Edit VariAudio** in the **VariAudio** section.

PROCEDURE

1. Select one or several segments.
2. On the **Sample Editor** toolbar, activate **Audition** to audition the segments.
3. Compare the start and end positions of the segments with the pitch curve.
4. Do one of the following:
 - If a segment starts too early or too late, hold down **Alt/Opt**, move the mouse pointer over the smart control on the middle left corner of the segment, and click and drag to the right or to the left.
 - If a segment ends too early or too late, hold down **Alt/Opt**, move the mouse pointer over the smart control on the middle right corner of the segment, and click and drag to the right or to the left.

NOTE

You can only drag the segment start or end until the boundaries of the next segment. Segments cannot overlap.

RESULT

The start and end positions of the segments are changed according to your edits. The average pitch of the segment is recalculated.

NOTE

Changing the length of a segment may lead to a different average pitch and therefore to a pitch change.

RELATED LINKS

[Segmenting Monophonic Audio](#) on page 618

[Smart Controls](#) on page 616

Pitch Changes

You can change the pitch of audio segments for corrective or creative purposes. By changing note pitches, you can change the melody of the original audio.

Pitch changes include the following:

- Raising or lowering pitches
- Quantizing pitches
- Changing the pitch curve
- Straightening pitches

To change the pitch of audio segments, you can use the **VariAudio** section in the **Sample Editor Inspector**, or the smart controls.

RELATED LINKS

[VariAudio Inspector Section](#) on page 615

[Smart Controls](#) on page 616

Pitch Snap Mode

The **Pitch Snap Mode** defines how a segment snaps to a certain pitch.

- You can set the **Pitch Snap Mode** in the **VariAudio** section of the **Sample Editor Inspector**.

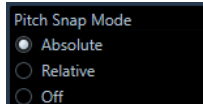

The following modes are available:

Absolute

Segments snap to the next semitone.

Relative

Segments snap to the next semitone, but they keep their original deviation in cents, if available.

Off

Segments do not snap, and you can edit the pitch freely.

NOTE

You can also assign a key command to toggle the **Pitch Snap Mode**.

Raising or Lowering Pitches

You can raise or lower the pitch of one or several segments.

PREREQUISITE

The audio file is segmented and the segments are correct. You have opened the audio in the **Sample Editor** and activated **Edit VariAudio** in the **VariAudio** section.

PROCEDURE

1. Optional: Activate **Acoustic Feedback** to audition pitch modifications while editing.
2. Select one or several segments, and move the mouse pointer over it.
The mouse pointer becomes a hand symbol.

NOTE

If you hold down **Shift** and double-click a segment, all following segments of the same pitch are selected.

3. Do one of the following:
 - Drag the segment up or down and release the mouse, or use the **Up Arrow** / **Down Arrow** keys to take the **Pitch Snap Mode** setting into account.
 - Hold down **Shift** while using the **Up Arrow** / **Down Arrow** keys to change the pitch in cent steps, and ignore the **Pitch Snap Mode**.

NOTE

You can change the **Pitch Snap Mode** on the fly. Use **Shift** to enter **Off** mode, **Ctrl/Cmd** to enter **Absolute** mode, and **Alt** to enter **Relative** mode.

RESULT

The **Solo** algorithm is selected automatically and the segment pitch is raised or lowered according to your settings.

NOTE

The more the pitch deviates from the original pitch, the less likely it is that your audio sounds natural.

AFTER COMPLETING THIS TASK

To compare your pitch changes to the original audio pitches, activate **Bypass VariAudio Changes** in the **VariAudio** section.

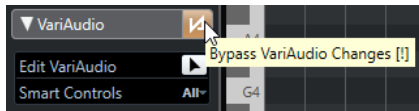

RELATED LINKS

[Select Submenu](#) on page 216

Changing Pitches using MIDI Input

You can change the pitches of one or several selected segments by pressing a key on your MIDI keyboard or by using the **On-Screen Keyboard**.

PREREQUISITE

The audio file is segmented and the segments are correct. You have opened the audio in the **Sample Editor** and activated **Edit VariAudio** in the **VariAudio** section. You have connected and set up a MIDI keyboard.

PROCEDURE

1. Select one or several segments.

NOTE

If you hold down **Shift** and double-click a segment, all following segments of the same pitch are selected.

2. In the **VariAudio** section, activate **Change Note Pitch via MIDI Input**.

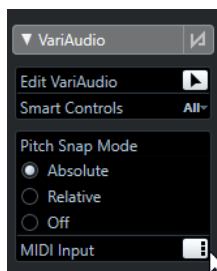

3. Do one of the following to change the pitch:
 - Press a key on your MIDI keyboard.

- Use the **On-Screen Keyboard** to change the pitch.

NOTE

The more the pitch deviates from the original pitch, the less likely it is that your audio sounds natural. You cannot choose pitches above C5 and below E0.

RESULT

The **Solo** algorithm is selected automatically, and the segment pitch is raised or lowered according to the note you play. If you select several segments, the pitch of the first selected segment is changed to the pitch of the MIDI note you play and the pitches of the other segments are changed by the same amount.

NOTE

The **MIDI Input** only affects the pitches of the segments. MIDI controller data are ignored.

AFTER COMPLETING THIS TASK

Deactivate **MIDI Input**.

RELATED LINKS

[On-Screen Keyboard](#) on page 288

[Pitch Snap Mode](#) on page 624

MIDI Input Modes

The **MIDI Input** function allows you to assign MIDI notes in **Still** mode or in **Step** mode.

- To switch between **Still** mode and **Step** mode, **Alt**-click **MIDI Input**.

Still mode



Use this mode if you want to change the pitches of individual segments or selections.

Step mode



Use this mode if you want to step through the segments while changing their pitches. This allows you to work in a more creative way, for example, to develop completely new melody lines via MIDI.

After you have assigned a MIDI note to a segment, the next segment is automatically selected.

RELATED LINKS

[Step Input](#) on page 978

Quantizing Pitches

You can quantize the audio pitch to the nearest semitone position.

PREREQUISITE

The audio file is segmented and the segments are correct. You have opened the audio in the **Sample Editor** and activated **Edit VariAudio** in the **VariAudio** section.

PROCEDURE

1. Select one or several segments.

NOTE

If you hold down **Shift** and double-click a segment, all following segments of the same pitch are selected.

2. In the **VariAudio** section of the **Sample Editor Inspector**, move the **Quantize Pitch** slider to the right.

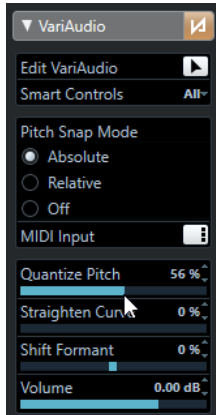

NOTE

You can also quantize the pitch by dragging the **Quantize Pitch** smart control in the middle of the bottom edge of the segment upwards or downwards.

RESULT

The **Solo** algorithm is selected automatically, and the segment pitch is quantized softly.

NOTE

In the **Sample Editor** category of the **Key Commands** dialog, you can set up a key command for **Quantize Pitch**. If you use the key command, the segments are immediately quantized to the next semitone position.

RELATED LINKS

[Key Commands](#) on page 1313
[Smart Controls](#) on page 616

Pitch Curve Changes

You can perform more detailed editing on the audio by modifying the pitch curves inside the segments.

IMPORTANT

The pitch curve displays the progression of the pitch for the tonal portion of the audio segment. For non-tonal portions of the audio, pitch curves cannot be shown.

Changes of the pitch curve include the following tasks:

- Tilting the pitch curve
This allows you to correct pitch deviations for individual segments. These include deviations from the tonal center.
- Rotating the pitch curve

This allows you to correct pitch deviations for individual segments. These include deviations from the tonal center.

- Straightening the pitch curve
This allows you to reduce the degree of fluctuation or vibrato for individual segments.

RELATED LINKS

[Setting Tilt/Rotate Anchors](#) on page 628
[Tilting a Pitch Curve](#) on page 628
[Rotating a Pitch Curve](#) on page 629
[Straightening Pitch Curves](#) on page 629
[Straightening Ranges of Pitch Curves](#) on page 630

Setting Tilt/Rotate Anchors

By default, the reference or anchor point for tilting and rotating pitch curves is set to the center of the segment. You can move that reference point to the left or to the right for a different result.

PREREQUISITE

The audio file is segmented and the segments are correct. You have opened the audio in the **Sample Editor** and activated **Edit VariAudio** in the **VariAudio** section.

PROCEDURE

1. In the **Sample Editor Inspector**, set **Smart Controls** to **All**.
2. Drag the smart control for **Set Tilt/Rotate Anchor** in the center of the upper edge of the segment to the left or to the right.

RESULT

The anchor is set to the position where you released the mouse button, and is used as a reference point when you tilt or rotate the pitch curve.

AFTER COMPLETING THIS TASK

To reset the anchor, hold down **Alt/Opt** and click the smart control for **Set Tilt/Rotate Anchor**.

RELATED LINKS

[Smart Controls](#) on page 616
[Tilting a Pitch Curve](#) on page 628
[Rotating a Pitch Curve](#) on page 629

Tilting a Pitch Curve

You can tilt the start or the end of a pitch curve. This allows you to correct pitch deviations for a segment.

PREREQUISITE

The audio file is segmented and the segments are correct. You have opened the audio in the **Sample Editor** and activated **Edit VariAudio** in the **VariAudio** section.

PROCEDURE

1. In the **Sample Editor Inspector**, set **Smart Controls** to **All**.
2. Optional: Move **Set Tilt/Rotate Anchor** to the left or to the right to adjust the reference point for tilting.
3. Do one of the following:

- To tilt the start of the curve, drag the smart control for **Tilt** in the upper left corner of the segment upwards or downwards.
 - To tilt the end of the curve, drag the smart control for **Tilt** in the upper right corner of the segment upwards or downwards.
-

RESULT

The **Solo** algorithm is selected automatically, and the pitch curve is tilted according to your settings.

RELATED LINKS

[Smart Controls](#) on page 616

[Setting Tilt/Rotate Anchors](#) on page 628

Rotating a Pitch Curve

You can rotate the pitch curve to correct pitch deviations of individual segments.

PREREQUISITE

The audio file is segmented and the segments are correct. You have opened the audio in the **Sample Editor** and activated **Edit VariAudio** in the **VariAudio** section.

PROCEDURE

1. In the **Sample Editor Inspector**, set **Smart Controls** to **All**.
 2. Optional: Move **Set Tilt/Rotate Anchor** to the left or to the right to adjust the reference point for the rotation.
If you do not move the anchor, the pitch curve is rotated around the center of the segment.
 3. Press **Alt/Opt**, and drag the smart control for **Tilt** in the upper left or the upper right corner of the segment upwards or downwards.
-

RESULT

The **Solo** algorithm is selected automatically, and the pitch curve is rotated around the anchor.

RELATED LINKS

[Setting Tilt/Rotate Anchors](#) on page 628

Straightening Pitch Curves

You can straighten pitch curves to compensate for the rise and fall in pitch, that is, the deviation from a representative pitch.

PREREQUISITE

The audio file is segmented and the segments are correct. You have opened the audio in the **Sample Editor** and activated **Edit VariAudio** in the **VariAudio** section.

PROCEDURE

1. Select one or several segments.

NOTE

If you hold down **Shift** and double-click a segment, all following segments of the same pitch are selected.

2. Do one of the following:

- Drag the smart control for **Straighten Pitch Curve** in the center of the upper edge of a segment upwards or downwards.
 - In the **Sample Editor Inspector**, move the **Straighten Curve** slider to the right.
-

RESULT

The **Solo** algorithm is selected automatically, and the pitch curves are straightened.

RELATED LINKS

[Smart Controls](#) on page 616

[Straightening Ranges of Pitch Curves](#) on page 630

Straightening Ranges of Pitch Curves

You can restrict the straightening of pitch curves to specific ranges of segments. This allows you to straighten the pitch of segments while preserving a natural transition between the segments.

PREREQUISITE

The audio file is segmented and the segments are correct. You have opened the audio in the **Sample Editor** and activated **Edit VariAudio** in the **VariAudio** section.

PROCEDURE

1. In the **Sample Editor Inspector**, set **Smart Controls** to **All**.
 2. Drag the smart control for **Set Range for Straighten Pitch Curve** in the upper left corner of the segment to the right to set the start of the range.
 3. Drag the smart control for **Set Range for Straighten Pitch Curve** in the upper right corner of the segment to the left to set the end of the range.
 4. Drag the smart control for **Straighten Pitch Curve** in the center of the upper edge of the segment upwards or downwards.
-

RESULT

Only the defined range of the pitch curve is straightened. The **Solo** algorithm is selected automatically.

Timing Modifications

Modifying the timing of segments, or warping, is useful if you want to align a musical accent to a certain time position or change the timing of segments in monophonic recordings.

If you warp audio segments, warp markers are created. These are shown in the **VariAudio** and the **AudioWarp** sections of the **Sample Editor Inspector**.

To modify the timing of audio segments, you can use the **VariAudio** section in the **Sample Editor Inspector** or the smart controls.

RELATED LINKS

[VariAudio Inspector Section](#) on page 615

[Smart Controls](#) on page 616

Warping Segments

PREREQUISITE

The audio file is segmented and the segments are correct. You have opened the audio in the **Sample Editor** and activated **Edit VariAudio** in the **VariAudio** section.

PROCEDURE

- Do one of the following:
 - Drag the smart control for **Warp Start** to the left or to the right.
 - Drag the smart control for **Warp End** to the left or to the right.
-

RESULT

The **Solo** algorithm is selected automatically. The timing of the segment and the adjacent segments is changed according to your settings. Warp markers are shown below the ruler to indicate which portions of the audio are stretched.

NOTE

Timing modifications introduced this way do not adapt to the project tempo. If this is what you want, use **Musical Mode**.

AFTER COMPLETING THIS TASK

To compare your warp changes to the original timing of the audio, activate **Disable Warp Changes** in the **AudioWarp** section.



RELATED LINKS

- [Smart Controls](#) on page 616
- [Correcting Warp Marker Positions](#) on page 611
- [Deleting Warp Markers](#) on page 612

Showing MIDI Reference Tracks

You can use a MIDI track as a reference for your pitch and timing corrections.

PREREQUISITE

- The audio file is segmented and the segments are correct. You have opened the audio in the **Sample Editor** and activated **Edit VariAudio** in the **VariAudio** section.
 - Your MIDI track contains a MIDI part with MIDI events that play a melody that you want to use as a reference for your audio.
-

PROCEDURE

- In the **VariAudio** section of the **Sample Editor Inspector**, open the **Select MIDI Reference Track** pop-up menu and select the MIDI track that you want to use as a reference for your audio.

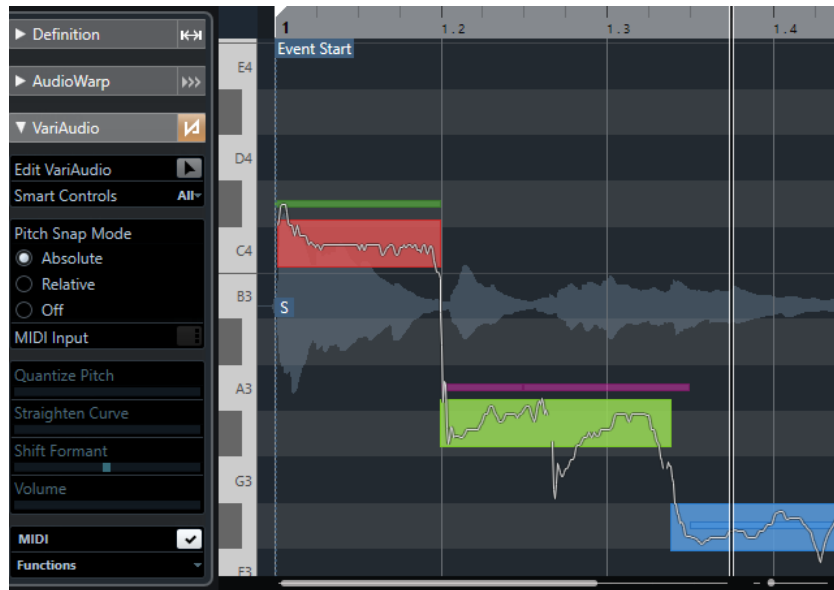

RESULT

The events of the selected MIDI track are shown in the **Sample Editor** event display as lines. Their color adapts to the **VariAudio Segment Colors** setting. You can use the **Pitch** or the **Chord Track** option, for example, to associate the pitches of audio and MIDI.

The MIDI reference track selection applies to all **Sample Editors** in a project. It is saved with the project.

NOTE

- You cannot edit MIDI data that is shown from within the **Sample Editor**.
- You cannot show MIDI reference tracks if you have opened the **Sample Editor** from the **Pool**.

AFTER COMPLETING THIS TASK

To hide the MIDI reference track from the **Sample Editor** event display, deactivate **Show MIDI Reference Track**.

RELATED LINKS

[VariAudio Segment Colors Menu](#) on page 620

Formant Shifting

Formants are the harmonic frequencies that occur in the human voice. They define the timbre and alter the perception of how a vocal has been performed (more from the diaphragm than from the throat, for example). Formant shifting does not affect the pitch or timing of a segment.

PREREQUISITE

The audio file is segmented and the segments are correct. You have opened the audio in the **Sample Editor** and activated **Edit VariAudio** in the **VariAudio** section.

PROCEDURE

1. Select one or several segments.
2. In the **VariAudio** section of the **Sample Editor Inspector**, move the **Shift Formant** slider to the left or to the right.

You can set positive and negative percentages. 0 leaves the original unaffected.

NOTE

If **Smart Controls** is set to **All**, you can also shift the formant by dragging the smart control in the lower left corner of the segment upwards or downwards.

RESULT

The **Solo** algorithm is selected automatically, and the formant is shifted.

RELATED LINKS

[Smart Controls](#) on page 616

Editing Volume

You can raise or lower the volume of the audio for a segment or mute it.

PREREQUISITE

- The audio file is segmented and the segments are correct. You have opened the audio in the **Sample Editor** and activated **Edit VariAudio** in the **VariAudio** section.
- You have selected **All** from the **Smart Controls** pop-up menu in the **Sample Editor Inspector**.

PROCEDURE

- Do one of the following:
 - Drag the smart control for **Volume** in the lower right corner of the segment upwards or downwards.
 - In the **VariAudio** section of the **Sample Editor Inspector**, drag the **Volume** slider to the left or right.

NOTE

To mute a segment, turn down the volume, or select the segment and select **Edit > Mute**.

RESULT

The volume of the segment is changed.

Functions Menu

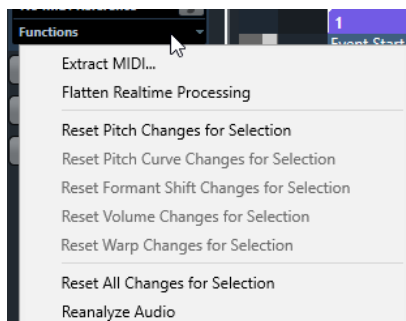

Extract MIDI

Opens the **Extract MIDI** dialog that allows you to specify which audio data is used to create a MIDI part. The entire audio event is taken into account.

Flatten Realtime Processing

Opens the **Flatten Realtime Processing** dialog that allows you to select an algorithm preset for the flattening of VariAudio and warp modifications. The entire audio event is taken into account.

Reset Pitch Changes/Reset Pitch Changes for Selection

Resets all segment pitches. If you select specific segments, only their pitches are reset.

Reset Pitch Curve Changes/Reset Pitch Curve Changes for Selection

Resets all pitch curves. If you select specific segments, only their pitch curves are reset.

Reset Formant Shift Changes/Reset Formant Shift Changes for Selection

Resets all formant shift changes. If you select specific segments, only their formant shift changes are reset.

Reset Volume Changes/Reset Volume Changes for Selection

Resets all volume changes. If you select specific segments, only their volume changes are reset.

Reset Warp Changes/Reset Warp Changes for Selection

Resets all warp changes. If you select specific segments, only their warp changes are reset.

Reset All Changes/Reset All Changes for Selection

Resets all changes. If you select specific segments, only their changes are reset.

Reanalyze Audio

Resets the segmentation and reanalyzes the entire audio event.

RELATED LINKS

[Extract MIDI Dialog](#) on page 635

[Generating Harmony Voices for Monophonic Audio](#) on page 637

[Flattening Realtime Processing](#) on page 637

Extracting MIDI from Audio

You can create a MIDI part from specific data of your audio. This is useful if you want to copy the tune and sound of your audio with a MIDI instrument or VST instrument.

PREREQUISITE

The audio file is segmented and the segments are correct. All pitch and timing changes are completed. You have opened the audio in the **Sample Editor** and activated **Edit VariAudio** in the **VariAudio** section.

PROCEDURE

1. In the **VariAudio** section, open the **Functions** menu, and select **Extract MIDI**.
 2. In the **Extract MIDI** dialog that opens, make your changes and click **OK**.
-

RESULT

A MIDI part is created according to your settings.

RELATED LINKS

[Segmenting Monophonic Audio](#) on page 618

[Extract MIDI Dialog](#) on page 635

Extract MIDI Dialog

The **Extract MIDI** dialog allows you to specify which audio data is used when creating a MIDI part with the **Extract MIDI** function.

- To open the **Extract MIDI** dialog, open the **VariAudio** section of the **Sample Editor Inspector**, activate **Edit VariAudio** in the **VariAudio** section, and in the **Functions** menu, click **Extract MIDI**.

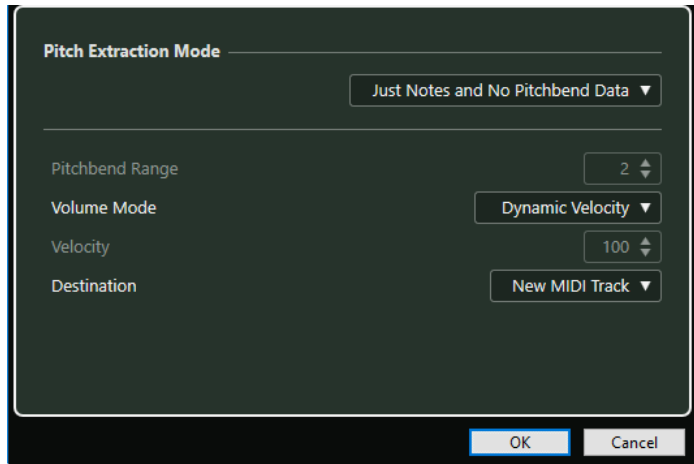

The following pop-up menus are available:

Pitch Extraction Mode

Allows you to specify which data is included if you extract MIDI. The following options are available:

Just Notes and No Pitchbend Data

Extracts MIDI notes only.

Notes and Static Pitchbend Data

Extracts pitchbend events for each segment. In the **Pitchbend Range** field, you can specify a pitchbend value from 1 to 24.

NOTE

If you work with an external MIDI device, set it to the same **Pitchbend Range** value.

Notes and Continuous Pitchbend Data

Extracts pitchbend events that correspond to the pitch curve. In the **Pitchbend Range** field, you can specify a pitchbend value from 1 to 24.

NOTE

If you work with an external MIDI device, set it to the same **Pitchbend Range** value.

Notes and NoteExp Pitchbend Curve

Extracts pitchbend events that correspond to the pitch curve. These are saved as Note Expression data for the resulting MIDI notes.

Notes and NoteExp VST 3 Tuning Curve

Extracts VST 3 events for the **Tuning** parameter. These are created as Note Expression data for the resulting MIDI notes.

NOTE

This works only with a connected VST instrument that is compatible with Note Expression.

Volume Mode

Allows you to specify how volume information from the audio is extracted. The following options are available:

Fixed Velocity

Assigns the same velocity to all created MIDI notes. In the **Velocity** field you can specify a velocity value.

Dynamic Velocity

Assigns an individual velocity value to each created MIDI note according to the amplitude of the audio signal.

Volume Controller Curve

Creates a continuous volume controller curve within the MIDI part. In the **MIDI Controller** field you can specify the MIDI controller.

NoteExp Volume Controller Curve

Extracts MIDI volume controller events. These are created as Note Expression data for the resulting MIDI notes.

NoteExp VST 3 Volume Curve

Extracts a VST 3 volume curve. This is created as Note Expression data for the resulting MIDI notes.

NOTE

This option works only with a connected VST instrument that is compatible with Note Expression.

Destination

Allows you to specify where the MIDI part is placed. The following options are available:

First Selected Track

Places the MIDI part on the first selected MIDI or instrument track. Any MIDI parts from previous extractions on this track are deleted.

New MIDI Track

Creates a new MIDI track for the MIDI part.

Project Clipboard

Copies the MIDI part into the clipboard. This option allows you to insert it at the desired position on a MIDI or instrument track in the **Project** window.

NOTE

If you opened the **Sample Editor** from the **Pool** and the audio file is not part of your project, the MIDI part is inserted at the beginning of the project.

Flattening Realtime Processing

You can flatten VariAudio and AudioWarp modifications. This is useful if you want to reduce the CPU load, optimize the sound quality of the processing, or apply any offline processing.

PROCEDURE

1. Optional: Select the segments that you want to flatten.
If you do not select anything, all segments are flattened.
2. In the **VariAudio** section, open the **Functions** menu, and select **Flatten Realtime Processing**.
3. In the **Flatten Realtime Processing** dialog, select an algorithm preset.

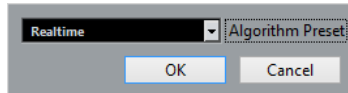

NOTE

For time stretch factors between 0.5 and 2, you can choose **Realtime** or **MPEX** as algorithm preset. For other time stretch factors, **Realtime** is automatically set.

-
4. Click **OK**.

RESULT

Any loop that was previously pitch shifted plays back exactly the same, but **Musical Mode** is deactivated, and VariAudio data, such as pitch changes, volume editing, and formant shifting, is lost.

Harmony Voices for Audio

Nuendo allows you to quickly create harmonies for monophonic audio material.

You have the following options:

- You can have Nuendo create default harmony voices for your audio.
- You can create a chord track with some chords first, and then create harmony voices for your audio based on that track.

In both cases, a VariAudio analysis is performed for the selected audio event, and up to 4 copies of the corresponding track are created. These new tracks that are named **Soprano**, **Alto**, **Tenor**, and **Bass** contain independent copies of the selected audio event.

If you use the function without a chord track, the voices are distributed by default. If you create a chord track with some chords and set the original track to follow the chord track in **Single Voice** mode, the harmony voices are distributed according to the chord voicing.

Generating Harmony Voices for Monophonic Audio

You can automatically generate harmony voices for monophonic audio.

PROCEDURE

1. Optional: Add a chord track to your project and set it up.
2. Select **File > Import > Audio File** and import a monophonic audio file.
3. In the **Project** window, select the audio event.
4. Select **Audio > Generate Harmony Voices**.

5. Specify the number of voices that you want to create, enter a value for the vibrato reduction, and click **OK**.

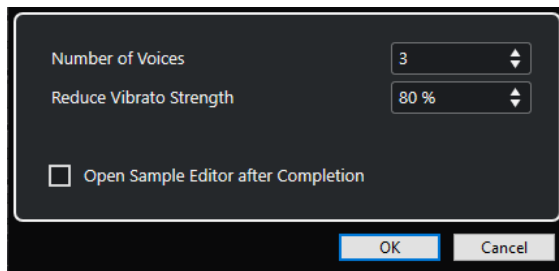

RESULT

The audio event is analyzed and VariAudio segments are created automatically. A copy of the event with altered pitches is created for every voice and placed on a newly created track.

NOTE

- If you added a chord track, the pitches of the resulting voices follow the soprano, alto, tenor, and bass voices from the chord track voicing.
- If you work without the chord track, the generated VariAudio segments of voice number 1 (soprano) are transposed 3 semitones upwards in relation to the original audio. The segments of voice numbers 2, 3, and 4 (alto, tenor, and bass) are transposed 3, 6, and 9 semitones downwards.

RELATED LINKS

[Adding the Chord Track](#) on page 1052

Generate Harmony Voices Dialog

The **Generate Harmony Voices** dialog allows you to quickly create harmonies for monophonic audio material.

- To open the **Generate Harmony Voices** dialog, select an audio event in the **Project** window, and select **Audio > Generate Harmony Voices**.

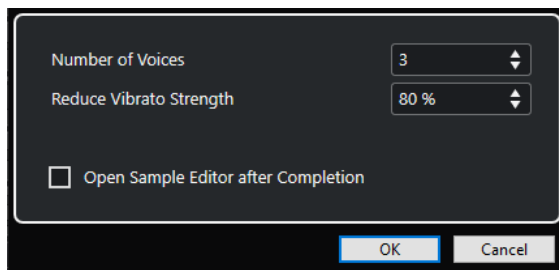

The following options are available:

Number of Voices

Allows you to select, how many voices are generated. You can generate up to 4 voices.

Reduce Vibrato Strength

Allows you to set a value for the vibrato reduction.

Open Sample Editor after Completion

Opens the generated voices together with the original audio event in the **Sample Editor**.

Audio Part Editor

The **Audio Part Editor** provides an overview of the selected audio parts. It allows you to view, audition and edit parts by cutting and pasting, crossfading, drawing level curves, or by processing parts. Editing is non-destructive so that you can undo modifications at any time.

You can open the **Audio Part Editor** in a separate window or in the lower zone of the **Project** window. Opening the **Audio Part Editor** in the lower zone of the **Project** window is useful if you want to access the **Audio Part Editor** functions from within a fixed zone of the **Project** window.

To open an audio part in the **Audio Part Editor**, do one of the following:

- Double-click an audio part in the **Project**.
- Select an audio part in the **Project** window and press **Return** or **Ctrl/Cmd - E**.
- Select an audio part in the **Project** window and select **Audio > Open Audio Part Editor**.
- In the **Key Commands** dialog in the **Editors** category, assign a key command for **Open Audio Part Editor**. Select an audio part in the **Project** window and use the key command.

NOTE

If you select **Audio > Set up Editor Preferences**, the **Preferences** dialog opens on the **Editors** page. Make your changes to specify if you want the **Audio Part Editor** to open in a separate window or in the lower zone of the **Project** window.

The **Audio Part Editor** window:

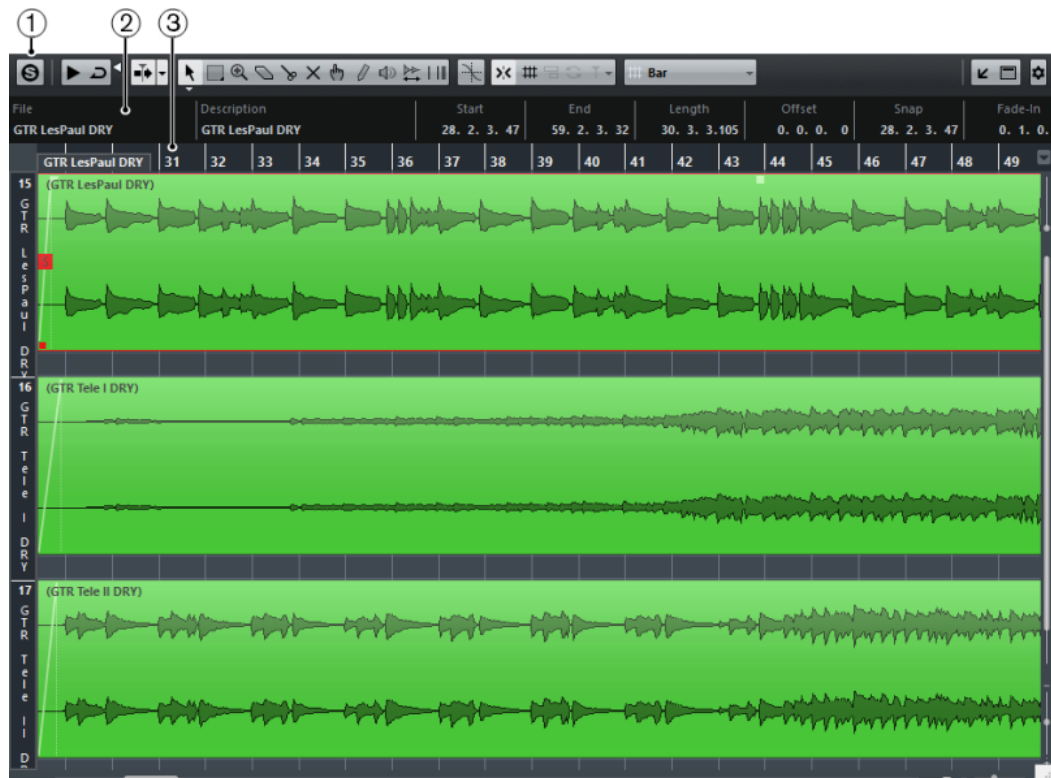

The **Audio Part Editor** in the lower zone of the **Project** window:

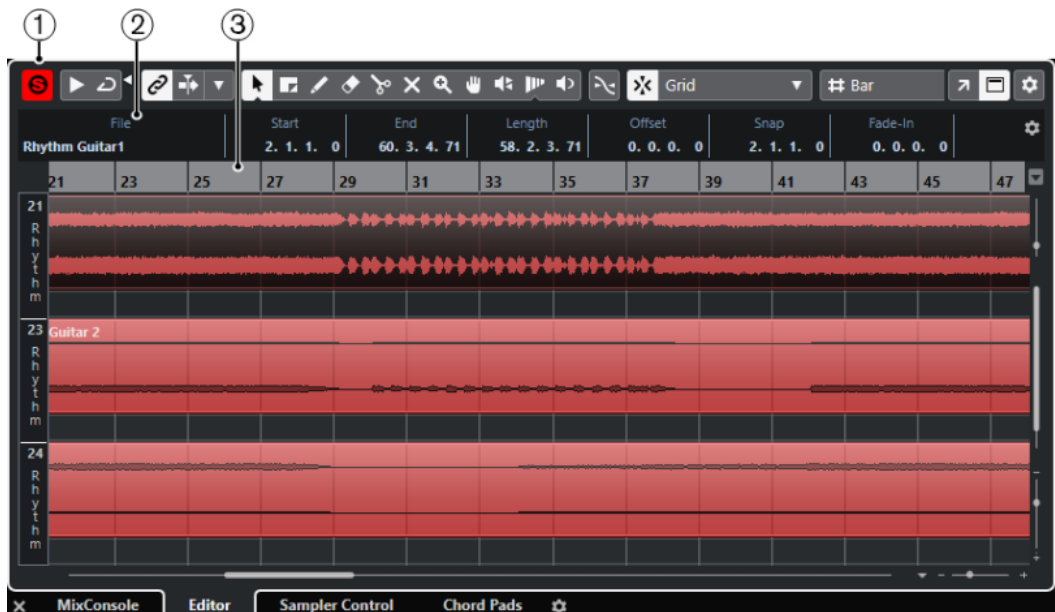

1 Toolbar

Contains tools for selecting, editing, and playing back audio parts.

2 Info Line

Displays information on the audio parts.

3 Ruler

Displays the timeline and the display format of the project.

RELATED LINKS

[Opening the Editor in the Lower Zone](#) on page 75

[Opening the Editor Inspector](#) on page 66

[Ruler](#) on page 60

[Info Line](#) on page 62

[Audio Part Editor Toolbar](#) on page 640

Audio Part Editor Toolbar

The toolbar contains tools for selecting, editing, and playing back audio parts.

- To show or hide the toolbar elements, right-click the toolbar and activate or deactivate the elements.

The following options are available:

Info/Solo

Solo Editor



Solos the selected audio during playback.

Left Divider

Left Divider

Tools that are placed to the left of the divider are always shown.

Auto-Scroll

Link Project and Lower Zone Editor Cursors



Links timelines, cursors, and zoom factors of the lower zone editor and the **Project** window.

NOTE

You cannot activate **Link Project and Lower Zone Editor Cursors** if **Independent Track Loop** is active.

Auto-Scroll



Keeps the project cursor visible during playback.

Select Auto-Scroll Settings



Allows you to activate **Page Scroll** or **Stationary Cursor** and to activate **Suspend Auto-Scroll When Editing**.

Preview

Audition



Plays back the selected audio.

Audition Loop



Loops the playback until you deactivate **Audition**.

Audition Volume



Allows you to adjust the volume.

Tool Buttons

Object Selection



Selects audio parts.

Range Selection



Selects ranges.

Zoom



Zooms in. Hold **Alt/Opt** and click to zoom out.

Erase



Deletes audio parts.

Split



Splits audio parts.

Mute



Mutes audio parts.

Comp



Assembles takes.

Draw



Draws a volume curve.

Play



Allows you to play back the clip from the position where you click until you release the mouse button.

Scrub



Allows you to locate positions.

Time Warp



Adjusts musical positions of events to time positions.

Multiple Part Controls

Show Part Borders



Shows/Hides part borders for the active audio part, within the left and right locators.

Edit Active Part Only



Restricts editing operations to the active part.

Currently Edited Part

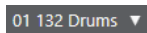

Lists all parts that were selected when you opened the editor, and allows you to activate a part.

Nudge Palette

Trim Start Left



Increases the length of the selected element by moving its start to the left.

Trim Start Right



Decreases the length of the selected element by moving its start to the right.

Move Left



Moves the selected element to the left.

Move Right



Moves the selected element to the right.

Trim End Left



Decreases the length of the selected element by moving its end to the left.

Trim End Right



Increases the length of the selected element by moving its end to the right.

Snap

Snap to Zero Crossing



Restricts editing to zero crossings, that is, positions where the amplitude is zero.

Snap On/Off



Restricts horizontal movement and positioning to the specific positions.

Snap Type



Allows you to specify to what positions you want events to snap.

Grid Type

Grid Type



Allows you to select a grid type. The options depend on the display format that is selected for the ruler. If you select **Seconds** as ruler format, time-based grid options are available. If you select **Bars+Beats** as ruler format, musical grid options are available.

Quantize

Soft Quantize On/Off



Activates/Deactivates soft quantize.

AudioWarp Quantize On/Off



Activates/Deactivates **AudioWarp** quantize.

Quantize Presets



Allows you to select a quantize preset.

Apply Quantize



Applies the quantize settings.

Open Quantize Panel



Opens the **Quantize Panel**.

Event Colors

Select Color for Selected Tracks or Events



Allows you to define audio part colors.

Independent Track Loop

Independent Track Loop



Activates/Deactivates the independent track loop for the edited part.

NOTE

If you activate **Independent Track Loop**, the **Link Project and Lower Zone Editor Cursors** function is automatically deactivated in the lower zone editor.

Right Divider

Right Divider

Tools that are placed to the right of the divider are always shown.

Window Zone Controls

Open in Separate Window



This button is available in the lower zone editor. It opens the editor in a separate window.

Open in Lower Zone



This button is available in the editor window. It opens the editor in the lower zone of the **Project** window.

Show/Hide Info



Allows you to activate/deactivate the info line.

Set up Toolbar



Opens a pop-up menu where you can set up which toolbar elements are visible.

RELATED LINKS

[Link Project and Lower Zone Editor Cursors](#) on page 77

[Auto-Scroll Settings Menu](#) on page 274

[Suspend Auto-Scroll When Editing](#) on page 274

Info Line

The info line shows information about the audio part, such as the start, end, length, or the time stretch algorithm.

File	Start	End	Length	Offset	Snap
04 piano 01	1. 1. 1. 0	3. 1. 1. 0	2. 0. 0. 0	0. 0. 0. 0	1. 1. 1. 0
Fade-In	Fade-Out	Volume	Lock	Transpose	Fine-Tune
0. 0. 0. 0	0. 0. 0. 0	0.00 dB	-	0	0
Global Transpose	Root Key	Mute	Musical Mode	Algorithm	
Follow	E	-	Musical	élastique Pro - Time	

- To show or hide the info line, activate **Show/Hide Info** on the toolbar.
The on/off status of the info line in the **Audio Part Editor** window and in the lower zone editor are independent of each other.

RELATED LINKS

[Audio Part Editor Toolbar](#) on page 640

Ruler

The ruler shows the timeline and the display format of the project.

You can select a separate display format by clicking on the arrow button on the right. Select an option from the pop-up menu.

Lanes

Lanes can make it easier to work with several audio events in a part. Moving some of the events to another lane can make selecting and editing much easier.

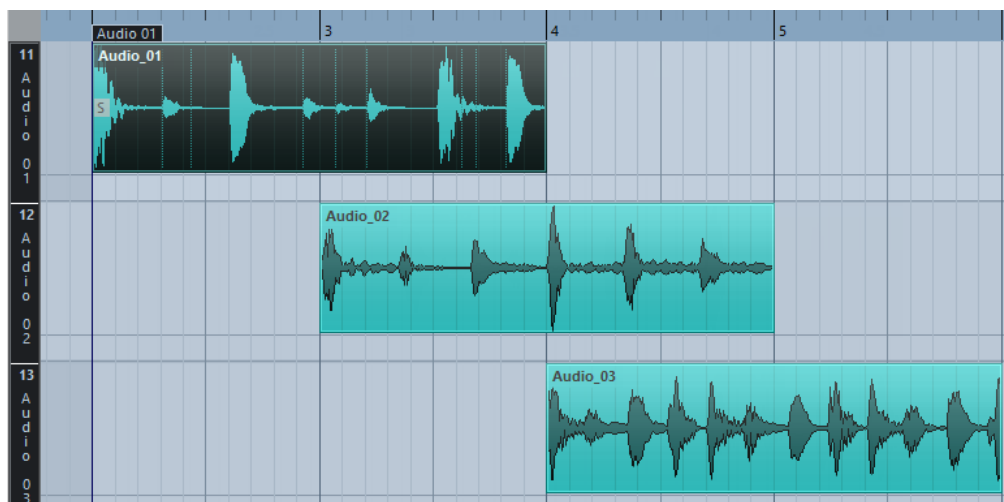

If **Snap** is deactivated and you want to move an event to another lane without accidentally moving it horizontally, press **Ctrl/Cmd** while dragging it up or down.

RELATED LINKS

[Track Handling](#) on page 170

Operations

All operations can be performed in the **Audio Part Editor** window and in the lower zone editor. Zooming, selecting and editing in the **Audio Part Editor** is done just as in the **Project** window.



NOTE

If a part is a shared copy, any editing you perform affects all shared copies of this part.

RELATED LINKS

[Project Window](#) on page 46
[Shared Copies](#) on page 236

Audition

When auditioning with the **Play**  tool or the **Audition**  tool, audio will be routed directly to the **Control Room** or to the main mix (the default output bus) if the **Control Room** is disabled.

Auditioning Using the Audition Tool

You can use the **Audition** tool to directly start a single audition of a selection or loop an audition using the **Audition Loop** function.

PROCEDURE

1. Do one of the following:
 - To play back the section between the first and last selected event, select the events with the **Object Selection** tool.
 - To play back a range, select a range with the **Range Selection** tool.
 - To start playback from the current cursor position, set the project cursor to that position.
2. On the toolbar, click **Audition**.

NOTE

If you activate **Audition Loop**, playback continues until you deactivate **Audition**.

RELATED LINKS

[Audio Part Editor Toolbar](#) on page 640

Auditioning Using the Play Tool

PROCEDURE

1. Select **Play** on the toolbar.
 2. On an audio part, click and hold at the position from which you want to begin auditioning.
-

RESULT

You are auditioning the audio part. The audition will stop at the end of the part you clicked on.

RELATED LINKS

[Audio Part Editor Toolbar](#) on page 640

Auditioning Using Regular Playback

PROCEDURE

1. Set the project cursor to the position from where you want to start playback.
 2. Optional: On the toolbar of the **Audio Part Editor**, activate **Solo Editor**.
This way, only the events in the edited part are played back.
 3. On the **Transport** panel, activate **Start**.
-

Setting up the Independent Track Loop

The independent track loop is a sort of mini-cycle, affecting only the edited part. When the loop is activated, the events in the parts that are within the loop will be repeated continuously and completely independent – other events (on other tracks) are played back as usual. The only interaction between the loop and the regular playback is that the loop starts every time the cycle starts over again.

PROCEDURE

1. Activate **Independent Track Loop** on the toolbar.

NOTE

If you activate **Independent Track Loop**, the **Link Project and Lower Zone Editor Cursors** function is automatically deactivated in the lower zone editor.

If it is not visible, right-click the toolbar and add the **Independent Track Loop** section.

2. **Ctrl/Cmd**-click in the ruler to set the start and **Alt/Opt**-click to set the end of the loop.

NOTE

You can also edit the loop start and end positions numerically in the fields next to the **Loop** button.

RESULT

The loop is indicated in blue in the ruler.

NOTE

The events are looped as long as the **Loop** button is activated and the **Audio Part Editor** is open.

RELATED LINKS

[Setup Options](#) on page 1338

[Audio Part Editor Toolbar](#) on page 640

Scrub

In the **Audio Part Editor**, the **Scrub** tool has a separate icon on the toolbar. Apart from that, scrubbing works exactly as in the **Project** window.

RELATED LINKS

[Scrubbing](#) on page 214

Handling Several Parts

When you open the **Audio Part Editor** with several parts selected – all on the same track or on different tracks – they might not all fit in the editor window, which can make it hard to get an overview of the different parts when editing.

Therefore, the toolbar features functions to make working with multiple parts easier and more comprehensive:

- The **Currently Edited Part** pop-up menu lists all parts that were selected when you opened the editor, and lets you select which part is active for editing.

When you select a part from the list, it is automatically made active and centered in the display.

NOTE

You can also activate a part by clicking on it with the **Object Selection** tool.

- **Edit Active Part Only** lets you restrict editing operations to the active part only. If you select **Edit > Select > All** with this option activated, all events in the active part are selected, but not the events in other parts.
- You can zoom in on an active part so that it is displayed in its entirety in the window by selecting **Edit > Zoom > Zoom to Event**.
- **Show Part Borders** can be used if you want to see clearly defined borders for the active part. If this option is activated, all parts except the active one are grayed out, making the borders easily discernible. There are also two markers in the ruler with the name of the active part, marking its beginning and end. These can be moved freely to change the part borders.
- It is possible to cycle between parts, making them active using key commands. In the **Key Commands** dialog, there are two functions in the **Edit** category: **Activate Next Part** and **Activate Previous Part**. If you assign key commands to these, you can use them to cycle between parts.

RELATED LINKS

[Key Commands](#) on page 1313

[Audio Part Editor Toolbar](#) on page 640

Extensions in Nuendo

Nuendo supports extensions such as Audio Random Access (ARA). ARA allows you to integrate compatible programs as plug-ins into your DAW. This integration allows for random access to audio events in the musical context of your project.

To be able to use a program as an extension, you must first install and register that program. After that, Nuendo automatically loads the extension, and you can activate it from within the program.

All extensions that are installed on your system are listed in the **System Component Information** window (**Extensions** page). Extensions that might lead to stability problems or even cause the program to crash are deactivated. If you still want to use them, you must activate them manually in the **System Component Information** window.

In Nuendo, extensions are integrated in the **Editor**. Information such as project timeline and tempo are shared between the **Project** window and the **Editor**.

RELATED LINKS

[Activating an Extension in Nuendo](#) on page 649

[System Component Information Window](#) on page 532

[Editor for Extensions](#) on page 650

Activating an Extension in Nuendo

To be able to use an extension in Nuendo, you must activate it.

PREREQUISITE

You have installed and registered the extension.

PROCEDURE

1. In the **Project** window, select the audio event that you want to edit.
2. Do one of the following:
 - Select **Audio > Extensions**, and select the desired extension.
 - Right-click the audio event, select **Extensions**, and select the desired extension.
 - Click the **Extension** field on the info line, and select the desired extension.

NOTE

If the **Extension** field is not shown, right-click the info line to open a context menu that allows you to configure the visible items and their order.

RESULT

The extension is activated and its interface is shown in the **Editor**. From here, you can edit the audio event.

In the **Project** window, the audio event shows a symbol in the upper right corner. This indicates that an extension is active.

For further information about the functions of the extension, refer to its documentation.

RELATED LINKS
[Setup Context Menus](#) on page 1338

Editor for Extensions

In Nuendo, extensions are integrated in the **Editor**. From there, you have access to all their editing functions.

To edit an audio event with an extension in the **Editor**, select the audio event in the **Project** window, and do one of the following:

- Select **Audio > Extensions**, and select the extension.
- Click the **Extension** field in the **Project** window info line, and select the extension.

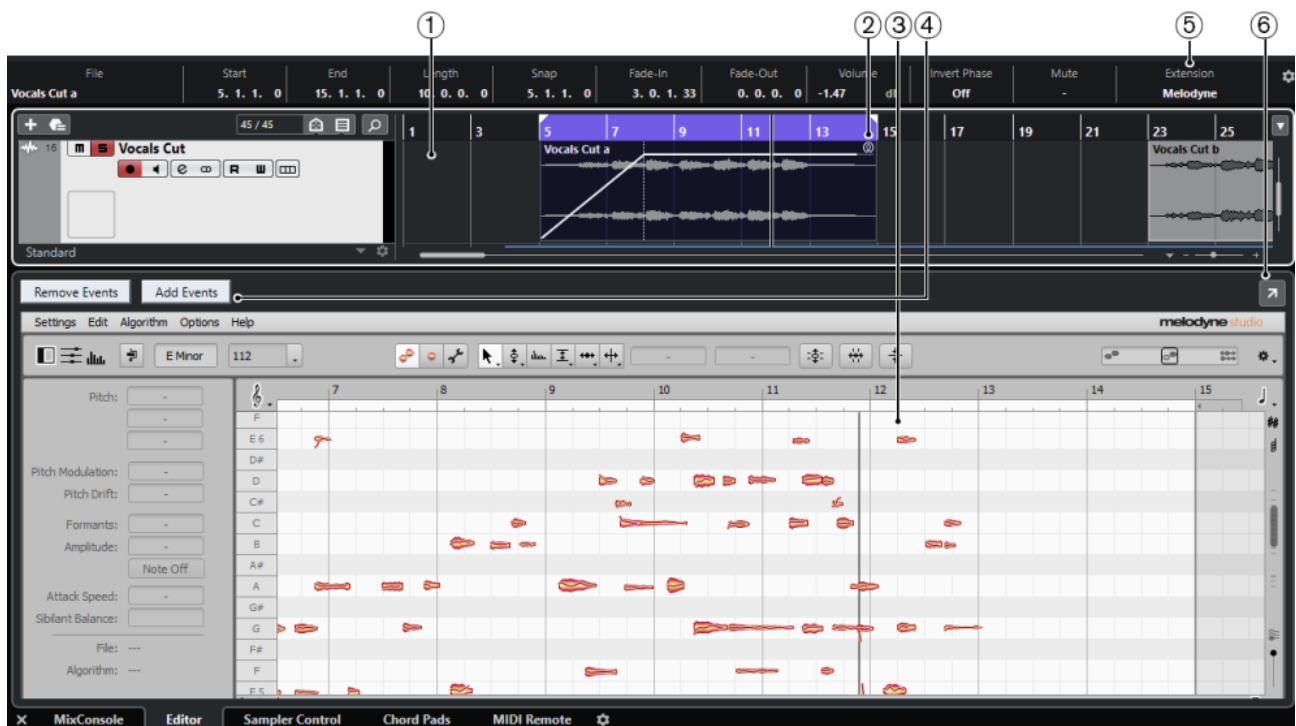

The **Editor** for Melodyne in the lower zone of the **Project** window

1 Project window event display

Allows you to see the edited audio event in its musical context.

2 Audio event

If an extension is activated for an audio event, the event in the **Project** window is shown with a symbol in the upper right corner.

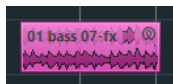

3 Extension editor

Shows the user interface of the activated extension and gives you access to its functions. Nuendo gives you an acoustic feedback of the changes during editing. Edits that you perform with the extension are saved with the project.

For further information about the functions of the selected extension, refer to its documentation.

4 Add Events/Remove Events

Automatically activates/deactivates the extension for all events that you select in the **Project** window.

5 Extension field on the info line

The **Extension** field on the info line allows you to activate/deactivate an extension.

6 Open in Separate Window

Opens the extension in a separate window. To show the extension in the lower zone editor, click **Open in Lower Zone**.

NOTE

Extensions cannot be open in the lower zone **Editor** and in a separate window at the same time.

Activating the Extension for Further Audio Events

You can activate the extension for more than one audio event via the extension **Editor**.

PREREQUISITE

- Your project contains at least two audio events, and you have activated the extension for one of them.
 - The extension **Editor** is open in the lower zone of the **Project** window.
-

PROCEDURE

1. In the extension **Editor**, activate **Add Events**.
2. In the **Project** window, select the audio event for which you want to activate the extension.

NOTE

To activate the extension for several events, drag a selection rectangle to select events and click one of them.

RESULT

The extension is activated for that audio event and the audio event is shown in the extension **Editor**.

AFTER COMPLETING THIS TASK

Deactivate **Add Events** to avoid accidentally activating the extension for audio events that you select in the **Project** window.

Deactivating the Extension for Audio Events

You can deactivate the extension for audio events via the extension **Editor**.

PREREQUISITE

- The extension **Editor** is open in the lower zone of the **Project** window.
-

PROCEDURE

1. In the extension **Editor**, activate **Remove Events**.
2. In the **Project** window, select the audio event for which you want to deactivate the extension.

NOTE

To deactivate the extension for several events, drag a selection rectangle to select events and click one of them.

RESULT

The extension is deactivated for that audio event and in the lower zone of the **Project** window, the audio event is shown in the **Sample Editor**.

AFTER COMPLETING THIS TASK

Deactivate **Remove Events** to avoid accidentally deactivating the extension for audio events that you select in the **Project** window.

Audio Event Editing

You can edit audio events in the extension **Editor** and in the **Project** window.

If you activate the extension for an audio event, you can instantly work on it in the extension **Editor**. All editing that you perform in the extension **Editor** is automatically rendered into the original file and there is no need to permanently apply the edits by bouncing the audio event. As a consequence, you can apply event fades and envelopes as well as warp edits on the edited events. In addition, the audio input for audio events remains in the buffer memory.

In the **Project** window, you can split, copy, paste, and resize audio events that you edited with the extension, and you can revert changes by using **Undo**.

Limitations

If the extension is activated, you can only edit it with the tools available in the extension **Editor**. You cannot access any of the **Sample Editor** options. You cannot warp that event, activate **Musical Mode**, perform **Hitpoint** editing, **AudioWarp Quantizing**, **Direct Offline Processing**, **Sizing Applies Time Stretch**, **Generate Harmony Voices**, or **Audio Alignment**.

You cannot transpose the event using the info line, nor fine-tune it or invert its phase.

NOTE

All offline processes that you applied to the audio event before activating the extension for it are preserved and become available again when you deactivate the extension for the event.

NOTE

If you edit multiple selected events in the **Project** window, be aware that events for which you activated the extension are not affected by the mentioned functions.

RELATED LINKS

[Event Resize Options](#) on page 228

[Splitting Events](#) on page 231

[Duplicating Events](#) on page 235

[Pasting Events](#) on page 234

[On Processing Shared Clips](#) on page 1358

[Specifying an Audio Pre-Record Time](#) on page 301

Sampler Tracks

The sampler track feature allows you to chromatically play back any audio from your audio sample library via MIDI. You can create and edit new sounds based on specific samples, and integrate them into an existing project.

The sampler track feature includes:

- The **Sampler Control** section in the lower zone of the **Project** window. Here you can load and edit audio samples, choose between different playback modes, or transfer samples to Steinberg VST instruments.
- A sampler track in your project that allows you to control the playback of the sample that is loaded in **Sampler Control** via MIDI.

RELATED LINKS

[Sampler Control](#) on page 654

[Sampler Tracks](#) on page 136

[Creating Sampler Tracks](#) on page 654

Loading Audio Samples into Sampler Control

You can load audio samples into **Sampler Control** by dragging.

Nuendo allows you to load mono or stereo samples in .wav or .aiff file format or REX and REX2 audio files created by ReCycle from Propellerhead Software into **Sampler Control**.

- To load an audio sample, drag it from the **MediaBay**, the **Project** window event display, or the File Explorer/macOS Finder and drop it in **Sampler Control**.

IMPORTANT

If **Sampler Control** already contains an audio sample, this sample and all its settings are overwritten.

NOTE

- Audio samples that you load into **Sampler Control** are not copied to the project audio folder. If you want to archive or share your project including all audio samples that you have loaded into **Sampler Control**, you must create a self-contained project.
- In the **Pool**, all audio samples that you have loaded into **Sampler Control** are listed in a dedicated sampler track subfolder in the main audio folder.
- Imported REX and REX2 files are converted to files in .wav format. These files are stored in a wav folder, created in addition to the original file.

In **Sampler Control**, playback mode is automatically set to **Slice** with slice markers set as defined in the imported REX file.

RELATED LINKS

[Self-Contained Projects](#) on page 115

[Pool](#) on page 675

Loading MIDI Parts into Sampler Control

You can load MIDI parts from instrument tracks or MIDI tracks into **Sampler Control** by dragging.

NOTE

For this to work, the instrument track or the MIDI track must be routed to a VST instrument.

- To load a MIDI part, drag it from the **MediaBay**, the **Project** window event display, or the File Explorer/macOS Finder and drop it in **Sampler Control**.

IMPORTANT

If **Sampler Control** already contains MIDI, it is overwritten.

Nuendo creates an audio file from the MIDI part. This includes the instrument sound and the channel settings from the VST instrument or the return channel. The audio file is copied to the project audio folder.

RELATED LINKS

[VST Instruments](#) on page 835

[Instrument Track Inspector](#) on page 134

[MIDI Track Inspector](#) on page 140

Creating Sampler Tracks

To create a sampler track, do one of the following:

- In the **Project** window, select an audio event and select **Audio > Create Sampler Track**.
- In the **MediaBay**, right-click an audio file and select **Create Sampler Track**.
- In the **Sample Editor Inspector**, open the **Range** section and click **Create Sampler Track**.
This creates a sampler track from the selected range. If no range is selected, the entire event is used.
- On the context menu of the track list, select **Add Sampler Track**.
In this case, **Sampler Control** is empty and you must load an audio sample by dragging.

Sampler Control

If the sampler track is selected, **Sampler Control** is available in the lower zone of the **Project** window. **Sampler Control** allows you to view, edit, and play back samples or specific sections of the samples.



1 **Toolbar**

Contains tools that allow you to select and edit the audio sample, to organize track presets, and to transfer the sample with its settings to an instrument.

2 **Waveform display/Envelope editor**

Shows the waveform image of the sample and allows you to define the playback range for the sample and to set a loop.

If the envelope editors for the pitch, filter, or amp section are shown, you can adjust their envelope curve settings here.

3 **Playback and Sound Parameter section**

Allows you to make settings for different playback modes (**Normal**, **AudioWarp**, and **Slice**), tuning and pitch modulation (**Pitch** section), filtering (**Filter** section), and level and panorama (**Amp** section).

4 **Keyboard section**

Allows you to set the key range of the sample, its root key, and the modulation range of the pitchbend wheel. These settings are used if you work with an external MIDI device.

RELATED LINKS

[Creating Sampler Tracks](#) on page 654

[Waveform Display](#) on page 659

[Envelope Editors](#) on page 664

[Playback and Sound Parameters](#) on page 660

[Keyboard Section](#) on page 668

Sampler Control Toolbar

The **Sampler Control** toolbar contains various settings and functions.

Read Automation



Allows you to read track automation.

Write Automation



Allows you to write track automation.

Switch between A/B Settings



Allows you to switch between different parameter settings.

Event Received Indicator



This LED indicates incoming MIDI messages via the selected MIDI input. The LED lights up on receiving note-on and controller messages. This way, you can check if Nuendo and your MIDI keyboard are connected to the same MIDI device input.

Snap to Zero Crossing



Restricts sample editing to zero crossings, that is, to positions where the amplitude is zero.

Auto-Scroll



Keeps the project cursor visible during playback.

Preset section

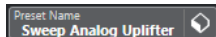

Shows the name of the track preset that is loaded for the sampler track. You can also save and load presets.

Import Audio File



Opens the **Import Audio** dialog that allows you to load an audio file into **Sampler Control**.

NOTE

If **Sampler Control** already contains an audio file, the original file is replaced by the new file.

File Name

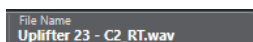

Shows the file name of the sample.

Tempo



Shows the tempo of the loop, as read from the sample file or calculated from the sample length. In **Slice** playback mode, you can adjust this value manually.

Root Key



Shows the root key that determines the pitch of the sample. You can change the root key by entering a new value in the value field or by dragging the root key handle on the **Sampler Control** keyboard.

Fixed Pitch



If a sample is triggered by a MIDI note other than the one defined by the **Root Key** setting, the sample is pitched accordingly. If **Fixed Pitch** is activated, the relation between played note and root key is disregarded and all keys play the sample just as it was recorded.

NOTE

This setting is only available in **Normal** and **AudioWarp** playback mode.

Loop Mode

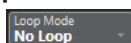

Allows you to select a loop mode for playback via MIDI.

- If this is set to **No Loop**, the sample is played once.
- If this is set to **Continuous**, the sample is played in a continuous loop.
- If this is set to **Alternate**, the sample is played back in a loop that alternates forward and backward.
- If this is set to **Once**, the sample is looped once.
- If this is set to **Until Release**, the sample is looped repeatedly until you release the key on the keyboard.

- If this is set to **Alternate Until Release**, the loop alternates forward and backward for as long as you hold the key.

NOTE

This setting is only available in **Normal** and **AudioWarp** playback mode.

Signature



Shows the detected time signature of the sample. You can adjust this value manually.

NOTE

This setting is only available in **Slice** playback mode.

Bars/Beats



These value fields show the detected length of the sample in bars and beats. You can adjust these values manually, which affects the grid and the tempo.

NOTE

This setting is only available in **Slice** playback mode.

Grid



Sets the grid.

NOTE

This setting is only available in **Slice** playback mode.

One Shot



The sample is played back once from beginning to end, regardless of any loop settings.

Normalize Sample

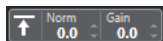

Normalizes the sample by detecting the highest peak level in the sample and adjusting the gain to reach the set **Normalization Level** value. **Sample Gain** allows you to modify the gain value manually afterwards.

Trim Sample



Trims the sample to a selected range. If no range is selected, the sample is trimmed to the range that is set with the sample start/end markers. **Revert to Full Sample** resets the sample to its original range.

NOTE

This setting is only available in **Normal** and **AudioWarp** playback mode.

Reverse Sample



Reverses the sample. This allows you to play back the sample backwards.

Monophonic Mode



Activates monophonic playback. For solo instruments, this usually results in a more naturally sounding performance. If monophonic playback is activated, a note that was stolen by another note is retriggered if you still hold the stolen note when you release the new one. This way, you can play trills by holding one note and quickly and repeatedly pressing and releasing another note, for example.

NOTE

If **Monophonic Mode** is deactivated, you can play up to 128 notes simultaneously.

If **Legato Mode** is activated as well and you play legato notes, only the pitch of the sample is set to the new note, but the sample is not retriggered and the envelopes keep running.

Lock Parameter Settings



If this option is activated, the current **Sampler Control** parameter settings are kept if you load another sample into **Sampler Control**.

NOTE

Parameters that are directly related to the sample, for example, sample start/end, loop start/end, root key, or tempo are not kept, and instead taken from the new sample.

MIDI Reset



Stops playback and resets all MIDI controllers to their default values.

This is useful, for example, if you want to stop playback of a long audio sample in **One Shot** mode.

Transfer to New Instrument



Allows you to transfer the audio sample with all its **Sampler Control** settings to an instrument that is loaded to a new instrument track.

Open in Separate Window



Opens **Sampler Control** in a separate window.

Open in Lower Zone



Opens **Sampler Control** in the lower zone.

RELATED LINKS

[Setting the Root Key Manually](#) on page 670

[Setting up Loops for Audio Samples](#) on page 670

[Normalizing Samples](#) on page 672

[Transferring Samples from Sampler Control to VST Instruments](#) on page 673

Waveform Display

The waveform display shows the waveform of your audio sample. It allows you to define the start and end of the audio sample, of the loop, and of the fade-in/-out.



Set Sample Start

Defines the sample start. On playback, all audio before the sample start is ignored.

Set Sample End

Defines the sample stop. On playback, all audio after the sample end is ignored.

Set Sample Start and End Markers Simultaneously

When you move the mouse cursor between the sample start and end marker, a connecting bar appears at the height of the marker flags. Dragging this bar moves both markers simultaneously with keeping their relative distance.

Set Sustain Loop Start

Defines where the sustain loop starts.

Set Sustain Loop End

Defines where the sustain loop ends. When this marker is reached, playback jumps back to the sustain loop start.

Set Sustain Loop Start and End Markers Simultaneously

When you move the mouse cursor between the sustain loop start and end marker, a connecting bar appears at the height of the marker flags. Dragging this bar moves both markers simultaneously with keeping their relative distance.

Set Fade In Length

Defines the fade-in length.

Set Fade Out Length

Defines the fade-out length.

Set Sustain Loop Crossfade Length

Loop crossfades allow for smoother loops. This marker defines the length for the loop crossfade.

Ruler

The ruler shows the timeline in the specified display format.

- To select the format, click the arrow button to the right of the ruler and select an option from the pop-up menu.
You can display bars and beats, seconds, or samples.

Zooming

- To zoom in/out on the time and level axes, use the horizontal and vertical zoom sliders or the corresponding key commands.

RELATED LINKS

[Key Commands](#) on page 1313

Playback and Sound Parameters

In the sections below the waveform display, you can make settings for different playback modes (**Normal**, **AudioWarp**, and **Slice**), tuning and pitch modulation (**Pitch** section), filtering (**Filter** section), and level and panorama (**Amp** section).

RELATED LINKS

[Playback Section](#) on page 660

[Pitch Section](#) on page 663

[Filter Section](#) on page 663

[Amp Section](#) on page 664

Playback Section

In the playback section, you can choose between different ways samples are played back.

Normal Playback

In this playback mode, you can choose the quality for sample playback. When samples are played back with another than their original pitch, you can choose between different algorithms for transposing them in real time.

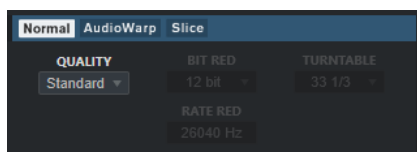

- To activate this mode, select **Normal** in the playback section.

Quality

Sets the playback quality.

- **Standard**, **High**, **Best**, and **Extreme** provide different algorithms for transposing samples in real time. The higher the quality setting, the better the suppression of artifacts, particularly in higher frequencies, and the higher the processor load. For samples with little high-frequency content, we recommend to use **Standard** quality.
- **Vintage** allows for a deliberate reduction of playback quality by lowering the bit and sample rate to emulate the artifacts of early samplers. **Turntable** emulates a memory-optimized sampling workflow of the past, where turntables were sampled at a higher speed to record short samples, and then tuned down again to correct for the change in pitch. A value of **45 rpm** leads to typical vintage artifacts. A value of **78 rpm** allows you to increase the effect even further.

AudioWarp Playback

This playback mode allows you to apply time stretching and formant shifting to your samples. You can choose between different warp and sync modes.

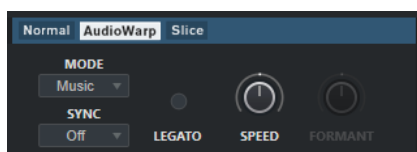

- To activate this mode, select **AudioWarp** in the playback section.

AudioWarp Mode

- **Music** mode offers parameters for time stretching.
This mode is suitable for complex material like drum loops and samples of mixed music. It uses considerably more CPU time than **Solo** mode.

NOTE

The more the sample is stretched, the higher the CPU load.

- **Solo** mode offers parameters for time stretching and formant shifting.
This mode is suitable for loops and samples of solo instruments or vocals.

AudioWarp Sync Mode

Allows you to match the playback speed of the sample to the project tempo.

- If **Off** is selected, the playback speed is specified manually, in percent.
- If **Tempo** is selected, the playback speed is calculated using the ratio between the original tempo of the sample and the tempo of the host.

Legato

If this option is deactivated, each note that is played via MIDI starts playback from the **Sampler Control** position cursor.

If this option is activated, the first note starts playback from the position cursor, and any following notes start from the current playback position for as long as the first note is held.

Speed

If **AudioWarp Sync Mode** is set to **Off**, you can adjust the playback speed of the sample.

In **Music** mode, the minimum playback speed adjustment is 12.5 %. Values below this limit have no effect.

Original BPM

If **AudioWarp Sync Mode** is set to **Tempo**, you can enter the original tempo of the sample in beats per minute. The playback speed of the sample is adjusted to match the tempo of the host application.

NOTE

This parameter is only available in **Solo** and in **Music** mode. In **Music** mode, the lower limit of the playback speed adjustment is 12.5 %. Values below this limit have no further effect.

Formant

Allows you to adjust formant shifting. Formant shifting allows you to avoid so-called Mickey Mouse effects when pitch-shifting a sample. This is especially useful with samples of human voices or acoustic instruments.

This parameter is only available in **Solo** mode.

Slice Playback

In this playback mode, you can slice a sample into several pieces, which are then mapped to the keyboard, so that every slice can be played individually. Additionally, a corresponding MIDI file is created, which can be dragged to the project to play the slices either in their original order or completely rearranged.

Selecting **Slice** mode automatically slices the sample. You can choose between different slice detection modes or combine them. You can manually adjust the position of the slice markers by dragging and add or remove slices using **Alt**-click.

NOTE

Slice playback uses the quality settings for **Normal** playback.



- To activate this mode, select **Slice** in the playback section.

Mode

Sets the slice detection mode.

- **Transient** mode allows you to specify the **Threshold** that determines the minimum peak level that a transient needs to become a slice marker.
- **Grid** mode sets the slice markers according to the **Grid Resolution** set on the **Sampler Control** toolbar.
- **Transient + Grid** mode combines the conditions of both **Transient** and **Grid** mode.
- **Manual** mode allows you to add and remove slices manually by **Alt**-clicking in the waveform. In this mode, no automatic slice detection is performed.

Threshold

Determines the minimum level that a transient needs to be detected as the start of a new slice.

Minimal Length

Sets the minimal length of a slice.

Grid Catch

In **Transient + Grid** slice detection mode, this parameter specifies how close to the grid a transient marker must be.

Fade In

Sets the fade-in time for all slices of the loop.

Fade Out

Sets the fade-out time for all slices of the loop.

Drag MIDI Phrase to Project

Click this button and drag it to the event display to create a corresponding MIDI event in your project.

RELATED LINKS

[Slicing Samples](#) on page 672

Pitch Section

In the **Pitch** section, you can adjust the tuning and pitch of your audio sample. The pitch envelope allows you to modulate the pitch over time.

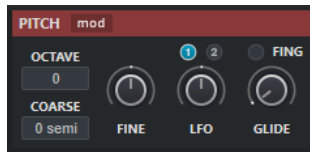

Show/Hide Pitch Modulators

Shows/Hides the pitch envelope and the LFO editor in the waveform window.

Octave

Sets the pitch of the sample in octave steps.

Coarse

Sets the pitch of the sample in semitone steps.

Fine

Fine-tunes the pitch of the sample in cents (hundredths of a semitone).

LFO

Allows you to select the LFO and to set the LFO modulation depth.

Glide

Specifies the time that is needed to bend the pitch of the sample from one note to the following note. If you move this control all the way to the left, **Glide** is deactivated.

If **Fingered** is activated, the pitch only glides between notes that are played legato.

RELATED LINKS

[Envelope Editors](#) on page 664

Filter Section

In the **Filter** section, you can adjust the tone color of the sample sound. The filter envelope allows you to control the cutoff frequency to shape the harmonic content over time.



Activate/Deactivate Filter

Activates/Deactivates the filtering effect.

Show/Hide Filter Modulators

Shows/Hides the filter envelope and the LFO editor in the waveform window.

Type

Sets the filter type.

Shape

Sets the filter shape.

Cutoff

Controls the cutoff frequency of the filter.

Resonance

Sets the filter resonance.

Drive

Determines the level of the input signal and thus the amount of saturation.

Cutoff Key Follow

Sets the cutoff modulation using the note number. Increase this parameter to raise the cutoff with higher notes. At 100 %, the cutoff frequency follows the played pitch exactly.

LFO

Allows you to select the LFO and to set the LFO modulation depth.

RELATED LINKS

[Envelope Editors](#) on page 664

Amp Section

In the **Amp** section, you can set the volume and the pan of the sample. The amplifier envelope allows you to shape the volume over time.

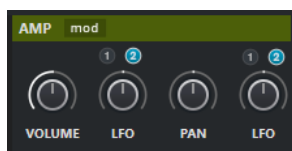

Show/Hide Amp Modulators

Shows/Hides the amp envelope and the LFO editor in the waveform window.

Volume

Sets the level of the sample.

Volume LFO

Allows you to select the volume LFO and to set the volume LFO modulation depth.

Pan

Sets the position of the sample in the stereo panorama.

Pan LFO

Allows you to select the pan LFO and to set the pan LFO modulation depth.

RELATED LINKS

[Envelope Editors](#) on page 664

Envelope Editors

You can adjust the **Pitch**, **Filter**, and **Amp** envelope curves. Each of these envelopes can contain up to 128 nodes.

- Click **Show/Hide Pitch Modulators**, **Show/Hide Filter Modulators**, or **Show/Hide Amp Modulators** in the section header to show/hide the corresponding envelope editor and the LFO section.



Pitch Envelope

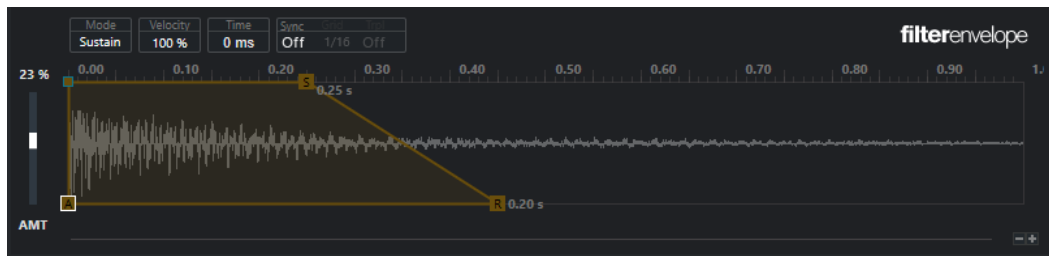

Filter Envelope



Amp Envelope

Envelope Amount

Determines how much the selected envelope affects the audio. This parameter allows for positive and negative values. If the **Envelope Amount** is set to 0, the envelope has no effect.

NOTE

This parameter is only available for **Pitch** and **Filter**.

Envelope display

Shows the pitch, filter, or amp envelope curve. You can adjust it by adding, moving, and deleting nodes. The nodes for attack (**A**), sustain (**S**), and release (**R**) are always shown and cannot be deleted. Next to the release node, the release time of the envelope is shown.

Mode

Determines how the corresponding envelope is played back when it is triggered.

- Select **Sustain** to play the envelope from the first node to the sustain node. The sustain level is held as long as you play the note. When you release the note, the envelope continues with the stages following the sustain. This mode is suited for looped samples.
- Select **Loop** to play back the envelope from the first node to the loop nodes. Then, the loop is repeated for as long as the key is held. When you release the note, the envelope continues playing the stages that follow the sustain. This mode is suited for adding motion to the sustain of the envelope.

- Select **One Shot** to play the envelope from the first to the last node, even if you release the key. The envelope has no sustain stage. This mode is suited for drum samples.
- Select **Sample Loop** to preserve the natural attack of the sample. The decay of the envelope does not start until the sample has reached the sample loop start. If you set the second node to the maximum level and use the following nodes to shape the decay during the loop phase of the sample, the envelope only affects the loop phase. The attack of the envelope is still executed.

Velocity

Determines how the velocity affects the level of the corresponding envelope.

The level of the envelope depends on the velocity setting and on how hard you hit a key. Higher values increase the level of the envelope the harder you hit a key.

Time

Sets the time value for the selected node.

Sync

Activates/Deactivates tempo sync for the corresponding envelope. **Grid** sets the base note value for tempo-syncing the envelope. **Trpl** allows you to set triplet base notes.

RELATED LINKS

[Selecting Nodes](#) on page 666

[Adding and Removing Nodes](#) on page 666

[Adjusting the Envelope Curve](#) on page 667

[Zoom Functions in the Envelope Editors](#) on page 667

[Synchronizing Envelopes to the Project Tempo](#) on page 672

Selecting Nodes

You can select single nodes or multiple nodes. Selected nodes are edited together.

- To select a node, click on it in the graphical editor. The **Time** field at the top of the graphical envelope editor shows the parameters of the selected node.
- To add a node to a selection, **Shift**-click the node.
- To select multiple nodes, draw a rectangle around them with the mouse. If multiple nodes are selected, the **Time** field shows the parameters of the node that is indicated by a white border.
- To select all envelope nodes, press **Ctrl/Cmd - A**.
- If the envelope editor has the keyboard focus, you can select the next or the previous node using **Left Arrow** and **Right Arrow**.

RELATED LINKS

[Keyboard Focus in the Project Window](#) on page 84

Adding and Removing Nodes

You can add up to 128 nodes to an envelope curve.

- To add a node, double-click at the position where you want to add the node.
- To remove a node, double-click it.
- To delete several selected nodes, press **Delete** or **Backspace**.

NOTE

- You cannot remove the attack (**A**), the sustain (**S**), or the release node (**R**).
- All nodes added after the sustain node always affect the release phase of the envelope.

Adjusting the Envelope Curve

The envelope editor allows you to adjust the envelope curve by dragging.

- To move a node horizontally or vertically, click and drag it.
- To move the envelope curve vertically between two nodes, click and drag it.

Zoom Functions in the Envelope Editors

The vertical axis of the envelope editor displays the level. The horizontal axis displays the time.

- To zoom in or out, click the + or - buttons to the right of the scrollbar below the envelope editor or use the corresponding key commands.
- To zoom in or out at the current position, click in the timeline and drag up or down.
- To zoom to a specific region, hold **Alt/Opt** and click and drag the mouse over the region.

RELATED LINKS

[Key Commands](#) on page 1313

LFO Editor

Sampler Control provides two monophonic LFOs. These LFOs are only calculated once and feed all voices at the same time.

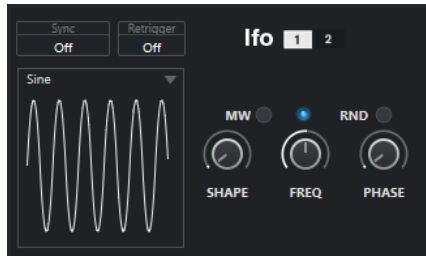

LFO

Allows you to select LFO 1 or 2 for editing.

Sync

Defines how the speed of the corresponding LFO is set.

- **Off** allows you to set the LFO speed in Hz.
- **Tempo + Retrig** allows you to set the LFO speed in note values. The resulting rate depends on the tempo of your project.
- **Tempo + Beat** allows you to set the LFO speed in note values. The resulting rate depends on the tempo of your project. Additionally, the current start phase is calculated based on the current position.

Retrigger

Defines whether the LFO is restarted with the specified start phase when a new note is triggered. This parameter is available for the sync modes **Off** and **Tempo + Retrig**.

- If **Off** is selected, the LFO is not restarted.
- **First Note** restarts the LFO when a note is triggered and no other note is held.

- **Each Note** restarts the LFO every time that a note is triggered.

MW

Allows you to scale the output level of the LFO using the modulation wheel of your keyboard. This allows you, for example, to control the vibrato of the sound with the modulation wheel.

Waveform

Sets the waveform for the selected LFO. You can adjust the selected waveform using the **Shape** control to the right.

- **Sine** produces smooth modulation, suitable for vibrato or tremolo. **Shape** adds additional harmonics to the waveform.
- **Triangle** is similar to **Sine**. **Shape** continuously changes the triangle waveform to a trapezoid.
- **Saw** produces a ramp cycle. **Shape** continuously changes the waveform from ramp down to triangle to ramp up.
- **Pulse** produces stepped modulation, where the modulation switches abruptly between two values. **Shape** continuously changes the ratio between the high and low state of the waveform. If **Shape** is set to 50 %, an even square wave is produced.
- **Ramp** is similar to the **Saw** waveform. **Shape** increasingly puts silence before the sawtooth ramp up begins.
- **Log** produces a logarithmic modulation. **Shape** continuously changes the logarithmic curvature from negative to positive.
- **S & H 1** produces randomly stepped modulation, where each step is different. **Shape** puts ramps between the steps and changes the sample and hold signal into a smooth random signal when fully turned right.
- **S & H 2** is similar to **S & H 1**. The steps alternate between random high and low values. **Shape** puts ramps between the steps and changes the sample and hold signal into a smooth random signal when fully turned right.

Freq

Controls the frequency of the modulation, that is, the speed of the LFO.

If **Sync** is activated for the corresponding LFO, the speed is specified in fractions of beats. If **Sync** is deactivated, you can set the frequency in Hz.

Phase

Sets the initial phase of the waveform when the LFO is retriggered. If **RND** is activated, each note starts with a randomized start phase.

Keyboard Section

In the keyboard section of **Sampler Control** you can set the root key and the key range of the sample, and the modulation range of the pitchbend wheel on your MIDI keyboard.

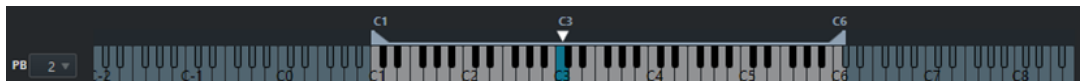

Pitchbend



Determines the maximal modulation that is applied when you move the pitchbend wheel on your MIDI keyboard. You can set the pitchbend range in semitone steps up to 24 semitones.

Key range handles



Determine the key range of the sample.

NOTE

The set key range is used in **Normal** and **AudioWarp** mode.

Root key handle



Determines the root key of the sample.

RELATED LINKS

[Setting the Root Key Manually](#) on page 670

[Setting the Key Range](#) on page 671

Sample Editing and Playback Functions

All sample editing in **Sampler Control** is non-destructive.

Setting Sample Start and End

By setting the sample start and end, you can define what range of the sample is played back when you press a key on your MIDI keyboard.

PREREQUISITE

You have loaded a sample into **Sampler Control**.

PROCEDURE

1. In the waveform display, drag the **Set Sample Start** handle to the right to adjust the sample start point.
 2. Drag the **Set Sample End** handle to the left to adjust the sample end point.
-

RESULT

When you trigger the sample, only the defined range between start and end handle is played back.

AFTER COMPLETING THIS TASK

- You can move both sample start and end markers simultaneously with keeping their relative distance by moving the mouse cursor between both markers and dragging the connecting bar.

NOTE

This only works if no loop mode is selected.

- You can trim the sample length to the defined playback range by clicking **Trim Sample** in the **Sampler Control** toolbar.

RELATED LINKS

[Waveform Display](#) on page 659

[Sampler Control Toolbar](#) on page 655

Setting up Loops for Audio Samples

You can set up a loop that is played back when the sample is triggered.

PREREQUISITE

You have loaded a sample into **Sampler Control**.

PROCEDURE

1. On the toolbar, click **Loop Mode** and select a loop mode from the pop-up menu.
The **Set Sustain Loop Start** and **Set Sustain Loop End** handles and the green loop range overlay are shown.
2. Drag the **Set Sustain Loop Start** and **Set Sustain Loop End** handles to adjust the loop start and end points.
To create a smooth loop transition, try to match the shape of the green loop range overlay with the shape of the gray sample waveform.

NOTE

You cannot drag the loop start and end points outside the defined sample range.

RESULT

When you trigger the sample in a loop mode, the defined loop range is used.

AFTER COMPLETING THIS TASK

- You can move both loop start and end markers simultaneously by dragging the area between the loop markers.

RELATED LINKS

[Setting Sample Start and End](#) on page 669

Setting the Root Key Manually

The **Root Key** shows the original pitch of the sample. Sometimes, if the sample does not contain any root key information or if you want the sample to play at a different pitch, you must set the root key manually. In **Slice** mode, lowering the root key allows you to increase the number of slices that can be mapped to your keyboard.

NOTE

If you load a sample that does not contain any root key information, the root key is automatically set to C3.

PROCEDURE

- Do one of the following:
 - In the keyboard section of **Sampler Control**, click and drag the root key handle.
 - On the toolbar of **Sampler Control**, double-click in the **Root Key** field and enter the new root key using your computer keyboard, your mouse wheel, or your MIDI keyboard.
-

RELATED LINKS

[Keyboard Section](#) on page 668
[Setting the Key Range](#) on page 671
[Slicing Samples](#) on page 672

Setting the Key Range

You can determine the key range for the sample. This is useful for samples that only sound good within a certain key range.

PREREQUISITE

You have loaded a sample into **Sampler Control**.

PROCEDURE

- In the keyboard section, adjust the key range by dragging the range handles above the keyboard display.

RESULT

Only keys within the determined key range play a sound when triggered.

RELATED LINKS

[Keyboard Section](#) on page 668

Playing Back Samples

After you have loaded an audio sample into **Sampler Control**, you can play back the sample using an external MIDI keyboard or the **On-Screen Keyboard**.

PREREQUISITE

You have loaded a sample into **Sampler Control** and made all sample editing and settings. You have installed and set up your MIDI keyboard.

PROCEDURE

1. In the track list, activate **Monitor** for the sampler track.
2. Optional: On the **Sampler Control** toolbar, activate **Fixed Pitch**.
This allows you to play back the sample in its original pitch and speed.
3. Hit some notes on your keyboard or use the **On-Screen Keyboard** to play back the sample.

RESULT

If **Fixed Pitch** is deactivated, the sample is played back and the pitch is defined by the notes you play. If you hit lower keys, the sample is played back with a low pitch. If you hit higher keys, the sample is played back with a high pitch.

If **Fixed Pitch** is activated, the sample is played back in its original pitch.

AFTER COMPLETING THIS TASK

To use the sound of the edited sample in your project, create or record a MIDI event on the sampler track.

RELATED LINKS

[Monitoring via Nuendo](#) on page 295

[On-Screen Keyboard](#) on page 288

[Sampler Control Toolbar](#) on page 655

[MIDI Events](#) on page 212

[Basic Recording Methods](#) on page 290

Synchronizing Envelopes to the Project Tempo

You can synchronize the **Pitch Envelope**, **Filter Envelope**, and **Amp Envelope** to the tempo of your project. This allows you to set envelope times that relate to musical time intervals, regardless of tempo changes.

PREREQUISITE

You have loaded a sample into **Sampler Control**.

PROCEDURE

1. In the corresponding envelope section, set **Sync** to **On**.
2. Use **Grid** and **Trpl** to set a note value. This sets the note resolution to which envelope nodes snap when coming close enough.

NOTE

- The **Time** field of an envelope node displays times in fractions of a whole note. The fraction is always reduced to the smallest possible value, for example, 2/16 is displayed as 1/8.
 - You can also enter note values manually in the **Time** field. Envelope nodes that do not exactly match a note value display the closest note value.
-

Normalizing Samples

You can normalize samples to a target value. An additional gain control allows you to fine-tune the gain value afterwards.

PREREQUISITE

You have loaded a sample into **Sampler Control**.

PROCEDURE

1. On the **Sampler Control** toolbar, set a **Normalization Level** as target value.
 2. Click **Normalize Sample**.
The sample is normalized to the target value.
 3. Use **Sample Gain** to fine-tune the normalization result.
-

RELATED LINKS

[Sampler Control Toolbar](#) on page 655

Slicing Samples

You can slice samples into several pieces that are mapped to the keyboard, so that you can play every slice individually.

PREREQUISITE

You have loaded a sample into **Sampler Control**.

PROCEDURE

1. In the playback section, click **Slice**.
2. Optional: Change the **Slice Mode**, adjust the slicing parameters, and add or delete slicing markers.

3. Optional: If you want to increase the number of slices that can be mapped to your keyboard, lower the root key in the keyboard section.
-

RESULT

The slices are automatically mapped to the keyboard, starting on the set root key. You can play a slice by pressing the corresponding key on your MIDI keyboard.

AFTER COMPLETING THIS TASK

You can create a corresponding MIDI phrase in your project by dragging the **Drag MIDI Phrase to Project** button to the event display. This allows you to rearrange the order of the slices.

RELATED LINKS

[Playback Section](#) on page 660

[Setting the Root Key Manually](#) on page 670

[Setting the Key Range](#) on page 671

Transferring Samples from Sampler Control to VST Instruments

You can transfer audio samples with all settings that you have made in **Sampler Control** to specific Steinberg VST instruments.

Transferring audio samples from **Sampler Control** to a VST instrument creates a new instrument track in the track list. This new track is added below the sampler track. The audio sample and all its settings are loaded in the VST instrument.

You can transfer audio samples from **Sampler Control** to the following Steinberg VST instruments:

- Groove Agent
- Groove Agent SE
- HALion
- Padshop
- Backbone

Transferring a Sample

PREREQUISITE

You have installed Groove Agent, Groove Agent SE, HALion, Padshop, or Backbone. You have loaded an audio sample in **Sampler Control**.

PROCEDURE

1. In the **Sampler Control** toolbar, click **Transfer to New Instrument**.
 2. In the pop-up menu, select the instrument to which you want to transfer the sample.
-

RESULT

In the track list, a new instrument track is created below the sampler track. The instrument track has the same name as the sampler track. The audio sample and its settings are loaded in the selected VST instrument.

NOTE

If a parameter is not available for the VST instrument that you have chosen as destination, it is either not transferred or is adapted to a similar parameter in the VST instrument. The following applies:

- Groove Agent/Groove Agent SE: LFO and filter settings are not used.
- Padshop: Sample trimming is not used. A transfer in **AudioWarp** playback mode sets the grain settings to a **Number** of 2 grains and the **Speed** value accordingly. A transfer in **Slice** playback mode uses the selected slice only.
- Backbone: Sample trimming is not used. A transfer in **AudioWarp** playback mode activates **Resynth** mode and sets the **Speed** value accordingly. A transfer in **Slice** playback mode uses the selected slice only.

RELATED LINKS

[Transferring a Sample](#) on page 673

Pool

Every time that you record on an audio track, a file is created on your hard disk. A reference to this file, a clip, is added to the **Pool**.

The following rules apply to the **Pool**:

- All audio and video clips that belong to a project are listed in the **Pool**.
- Every project has a separate **Pool**.

The way the **Pool** displays folders and their contents is similar to the way the File Explorer/macOS Finder displays folders and file lists. In the **Pool**, you can perform operations that affect files on disk and operations that only affect clips.

Operations That Affect Files

- Importing clips (audio files can automatically be copied and/or converted)
- Converting file formats
- Renaming clips (this also renames the referenced files on disk) and regions
- Deleting clips
- Preparing file archives for backup
- Minimizing files

Operations That Affect Clips

- Copying clips
- Auditioning clips
- Organizing clips
- Applying audio processing to clips
- Saving or importing complete **Pool** files

Pool Window

The **Pool** window allows you to manage the media files of the active project.

To open the **Pool**, do one of the following:

- On the **Project** window toolbar, click **Open Pool Window**. If this icon is not visible, you must activate the **Media & MixConsole Windows** option on the toolbar context menu.
- Select **Project > Pool**.
- Select **Media > Open Pool Window**.

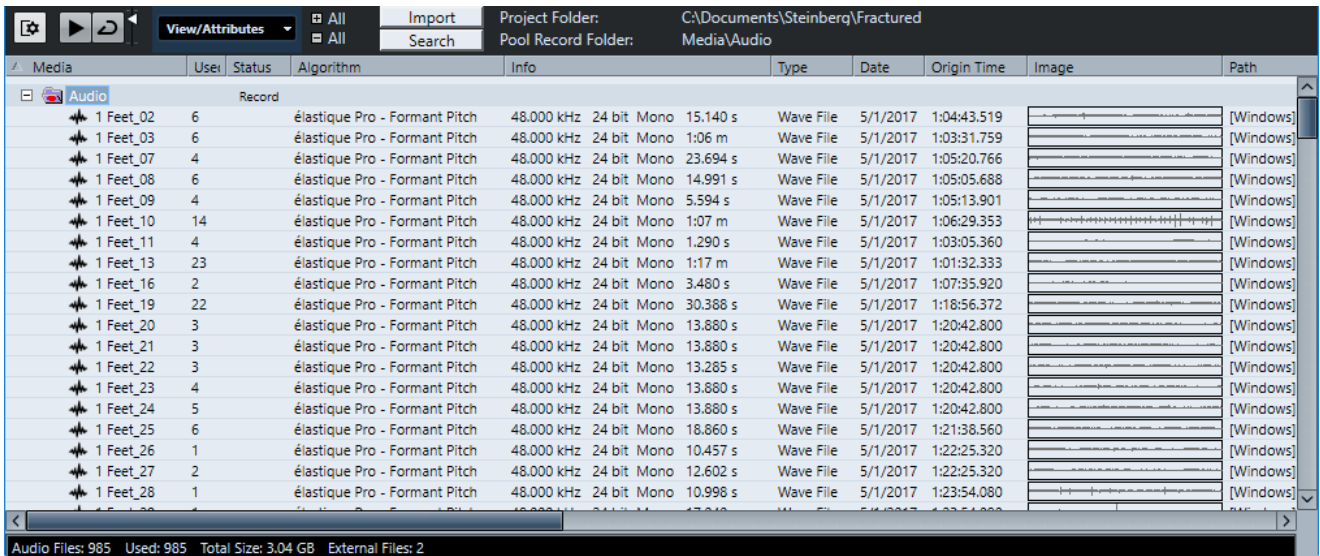

The content of the **Pool** is divided into the following folders:

Audio folder

Contains all audio clips and regions that are in the project.

If the project contains one or more sampler tracks, a dedicated **Sampler Track** subfolder is created in the **Audio** folder. This subfolder contains all clips of samples that you have loaded into **Sampler Control**.

Clip Packages Folder

Contains all imported or created clip packages.

Video folder

Contains all video clips that are in the project.

Trash folder

Contains unused clips that have been moved here for later permanent removal from the hard disk.

NOTE

You cannot rename or delete these folders, but you can add any number of subfolders.

Pool Window Columns

The **Pool** window columns display information about the clips and regions.

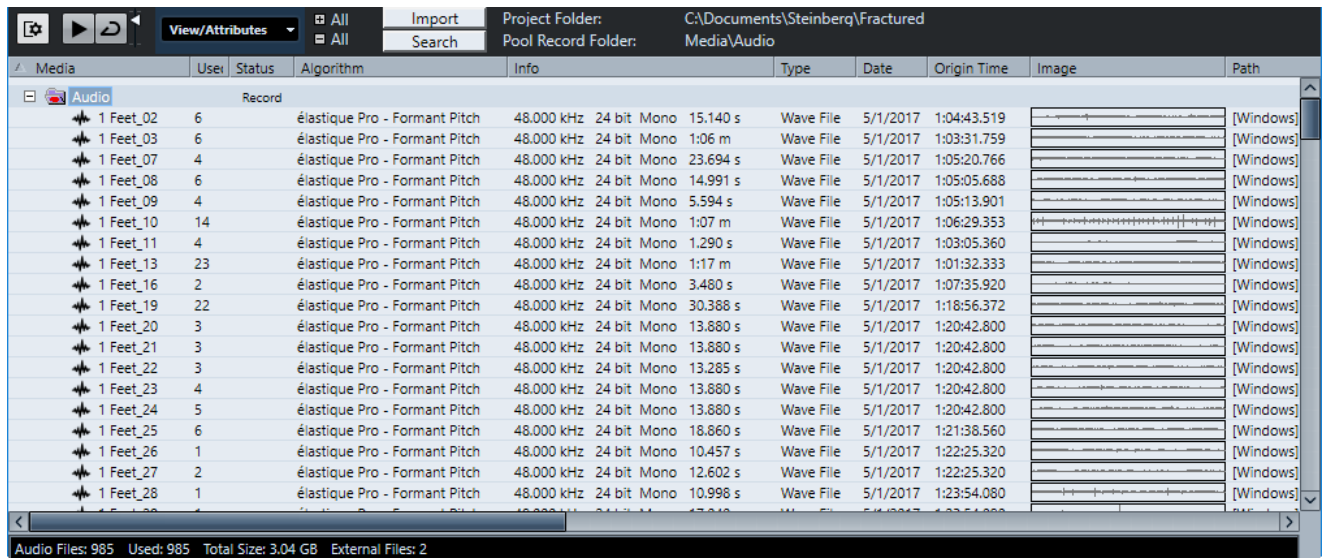

The following columns are available:

Media





Contains the **Audio**, **Video**, and **Trash** folders. If the folders are opened, the clip or region names are shown and can be edited.

Used

Displays how many times a clip is used in the project. If there is no entry in this column, the corresponding clip is not used.

Status

Displays various icons that relate to the current **Pool** and clip status. The following symbols can be displayed:

- **Record folder**  **Record**
Indicates the **Record** folder.
- **Process** 
Indicates that a clip has been processed.
- **Missing** 
Indicates that a clip is referenced in the project but missing from the **Pool**.
- **External** 
Indicates that the file the clip relates to is external, for example, located outside the current **Audio** folder for the project.
- **Recorded** 
Indicates that the clip has been recorded in the open version of the project. This is useful for finding recently recorded clips quickly.

Musical Mode

You can use **Musical Mode** to tempo-match audio loops to the project tempo. The checkbox in this column allows you to activate or deactivate musical mode. If the **Tempo** column displays “???”, you must enter the correct tempo before you can activate **Musical Mode**.

Tempo

Displays the tempo of audio files if available. If no tempo has been specified, the column displays “???”.

Sign.

Displays the time signature, for example, “4/4”.

Key

Displays the root key if one has been specified for the file.

Algorithm

Displays the algorithm preset that is used if the audio file is processed.

- To change the default preset, click the preset name and select another preset from the pop-up menu.

Info

For audio clips, this column displays the sample rate, bit depth, number of channels, and length.

For regions, it displays start and end times in frames.

For video clips, it displays the frame rate, resolution, number of frames, and length.

Type

Displays the file format of the clip.

Date

Displays the date when the audio file was last changed.

Origin Time

Displays the original start position where a clip was recorded in the project. As this value can be used as a basis for the **Insert into Project** option in the **Media** or context menu, you can change it if the **Origin Time** value is independent (for example, not for regions).

In the Pool, you can change the value by editing the **Origin Time**. In the **Project** window, you can change the value by moving the event to a new position and selecting **Audio > Update Origin**.

Image

Displays waveform images of audio clips or regions.

Path

Displays the path to the location of a clip on the hard disk.

Reel Name

If you have imported an OMF file, it may include this attribute, which is then shown in this column. It describes the reel or tape from which the media was originally captured.

NOTE

You can rearrange the order of the columns by clicking a header and dragging left or right.

Pool Window Toolbar

The toolbar contains tools and settings for working in the **Pool**.

Show Info

Shows/Hides the info line.

Audition



Plays back the selected audio.

Audition Loop



Loops the playback until you deactivate **Audition**.

Audition Volume



Allows you to adjust the volume.

View/Attributes

Allows you to activate/deactivate the attributes that are displayed in the **Pool** window. You can also define custom user attributes.

+/- All

Opens/Closes all folders.

Import

Allows you to import media files to the **Pool**.

Search

Allows you to search the **Pool** and connected disks for media files.

Project Folder

Displays the path to the folder of the active project.

Pool Record Folder

Displays the path to the **Record** folder of the active project. By default, this is the **Audio** folder. However, you can create a new **Audio** subfolder and designate this as your **Pool** record folder.

Info Line

The info line shows information about the event or part that you selected in the **Pool**.

- To activate the info line, click **Show Info** at the left of the toolbar.

The info line shows the following information:

Audio Files

The number of audio files in the **Pool**.

Used

The number of audio files in use.

Total Size

The total size of all audio files in the **Pool**.

External Files

The number of files in the **Pool** that do not reside in the project folder (for example, video files).

Working with the Pool

NOTE

Most of the **Pool**-related main menu functions are also available on the **Pool** context menu.

Renaming Clips or Regions in the Pool

IMPORTANT

Renaming clips or regions in the **Pool** also renames the referenced files on disk. It is recommended to rename clips or regions in the **Pool**. Otherwise, the reference from the clip to the file may get lost.

PROCEDURE

1. In the **Pool** window, select a clip or region, and click the existing name.
 2. Enter a new name and press **Return**.
-

RELATED LINKS

[Missing Files](#) on page 686

Renaming Multiple Clips or Regions in the Pool

PROCEDURE

1. In the **Pool** window, select the clips or regions that you want to rename.
You can only select one type of object at a time.
 2. Select **Edit > Rename Objects**.
A dialog with several renaming options opens.
 3. In the dialog, set the parameters for renaming object and click **OK**.
-

Rename Objects Dialog

The **Rename Objects** dialog allows you to add prefixes, suffixes, and incremental numbers to names. You can also remove certain characters, include timestamp information, and more.

In the **Pool** window, right-click a clip and select **Edit - Rename Objects**, or select a clip and select **Edit > Rename Objects**.

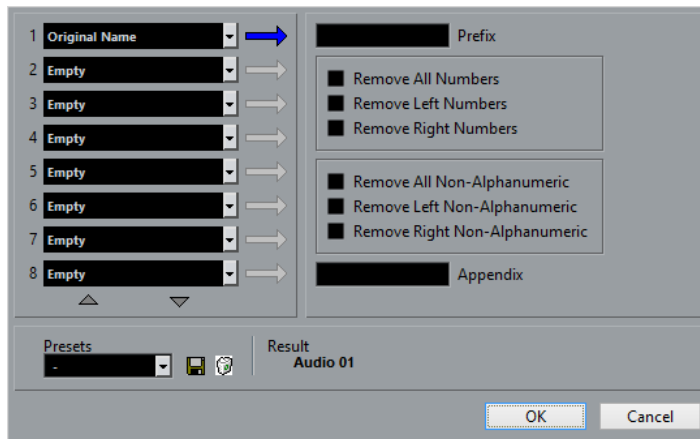

Each of the fields found in the left section of the **Rename Objects** dialog can be used to add an element to the name for each object.

Depending on the selected element, different renaming options are available on the right side of the dialog. The following elements are available:

Free Text

Any text that you want to include in the name.

Original Name

The original name given to the object. There are options to remove all numbers, non-alpha numerics, or only numbers at the beginning or end of the name.

Number

An increasing or decreasing number starting with a minimum amount of digits and a starting number (for example, 001, 002, etc.).

Project Time

The current location of the clip in the project window using any of the seven ruler formats (Bars+Beats, Timecode, etc.).

Date

Creation date of the file in several formats.

File Extension

The file type.

Audio Bitsize

The bit depth of the audio file.

Sample Rate

The sample rate of the audio file.

Audio Tempo

The audio tempo for the clip if it has been assigned.

User Attribute

Any of the custom attributes created in the **Setup User Attributes** dialog.

NOTE

- You can use a prefix to create a space that separates items in the generated name.
- An example of the result is displayed at the bottom of the window. You can also save all of these parameters as a preset.

Duplicating Clips in the Pool

You can create duplicates of clips and apply different processing methods to them.

NOTE

Duplicating a clip does not create a new file on disk, but a new edit version of the clip that refers to the same audio file.

PROCEDURE

1. In the **Pool** window, select the clip that you want to duplicate.
 2. Select **Media > New Version**.
-

RESULT

A new version of the clip appears in the same **Pool** folder. The duplicated clip has the same name as the original but with a version number after it. Regions within a clip are also copied, but keep their name.

Inserting Clips into a Project

To insert a clip into a project, you can either use the insert commands on the **Media** menu or use drag and drop.

Inserting Clips into a Project via Menu Commands

PROCEDURE

1. In the **Pool** window, select the clips that you want to insert into the project.
2. Select **Media > Insert into Project** and select one of the insert options.
If several clips are selected, choose whether to insert them on one track or each on a different track.

NOTE

The clips are positioned so that their snap points are aligned with the selected insert position. If you want to adjust the snap point before inserting a clip, double-click a clip to open the **Sample Editor**. Here, you can adjust the snap position and then perform the insert options.

RESULT

The clip is inserted on the selected track or on a new audio track. If several tracks are selected, the clip will be inserted on the first selected track.

RELATED LINKS

[Adjusting the Snap Point](#) on page 594

Inserting Clips into a Project via Drag and Drop

You can drag a clip from the **Pool** into the **Project** window.

Snap is taken into account if **Snap** is activated.

If you drag the clip into the **Project** window, the cross-hair cursor and a tooltip are shown. The tooltip indicates the timeline position where the snap point of the clip is aligned.

If you position the clip in an empty area of the track list, that is, where no track exists, a new track is created for the inserted event.

NOTE

If you press and hold **Shift** while dragging the clip from the **Pool** on an event, the clip in this event is replaced.

RELATED LINKS

[Adjusting the Snap Point](#) on page 594

[Replacing Clips in Events](#) on page 210

[Cross-Hair Cursor](#) on page 92

Deleting Clips from the Pool

You can delete clips from the **Pool** with or without deleting the corresponding file from the hard disk.

Removing Clips from the Pool

You can remove clips from the **Pool** without deleting the corresponding files from the hard disk.

PROCEDURE

1. In the **Pool** window, select the clips that you want to remove, and select **Edit > Delete**. You can also press **Backspace** or **Delete**.
 2. Depending on whether the clips are used by an event, you have the following options:
 - If the clips are used by an event, click **Remove** and then click **Remove from Pool**.
 - If the clips are not used by an event, click **Remove from Pool**.
-

RESULT

The clips are no longer available in the **Pool** for this project, but the files still exist on the hard disk and can be used in other projects, etc. This operation can be undone.

Deleting Files from the Hard Disk

You can delete clips from the **Pool** by deleting the corresponding file from the hard disk. To delete a file permanently from the hard disk, you must first move the corresponding clips to the **Trash** folder in the **Pool**.

IMPORTANT

Make sure that the audio files that you want to delete are not used in other projects.

PROCEDURE

1. In the **Pool** window, select the clips that you want to delete from the hard disk, and select **Edit > Delete**. You can also press **Backspace** or **Delete**, or drag the clips into the **Trash** folder.

NOTE

You can retrieve a clip or region from the **Trash** folder by dragging it back into an **Audio** or **Video** folder.

2. Depending on whether the clips are used by an event, you have the following options:

- If the clips are used by an event, click **Remove** and then click **Trash**.
 - If the clips are not used by an event, click **Trash**.
3. Select **Media > Empty Trash**.
 4. Click **Erase**.
-

RESULT

The files are deleted from the hard disk.

Removing Unused Clips from the Pool

You can find all clips in the **Pool** that are not used in the project. This allows you to quickly remove all unused clips.

PREREQUISITE

The **Pool** window is open.

PROCEDURE

1. Select **Media > Remove Unused Media**.
 2. Do one of the following:
 - To move the clips to the **Trash** folder, select **Trash**.
 - To remove the clips from the **Pool**, select **Remove from Pool**.
-

Removing Regions from the Pool

PROCEDURE

- In the **Pool**, select a region and select **Edit > Delete**.
You can also press **Backspace** or **Delete**.

IMPORTANT

You are not warned if the region is still in use.

Locating Events and Clips

You can quickly display to which clips the selected events belong and to which events the selected clips belong.

Locating Events via Clips in the Pool

You can find out which events in the project refer to a particular clip in the **Pool**.

PROCEDURE

1. In the **Pool** window, select one or more clips.
 2. Select **Media > Select in Project**.
-

RESULT

All events that refer to the selected clips are now selected in the **Project** window.

Locating Clips via Events in the Project Window

You can find out which clip belongs to a particular event in the **Project** window.

PROCEDURE

1. In the **Project** window, select one or more events.
2. Select **Audio > Find Selected in Pool**.

RESULT

The corresponding clips are located and highlighted in the **Pool**.

Searching for Audio Files

The search functions help you locate audio files in the **Pool**, on your hard disk, or on other media. This works much like the regular file search, but with extra features.

PROCEDURE

1. In the **Pool** window, click **Search** on the toolbar.
A search pane appears at the bottom of the window, displaying the search functions.

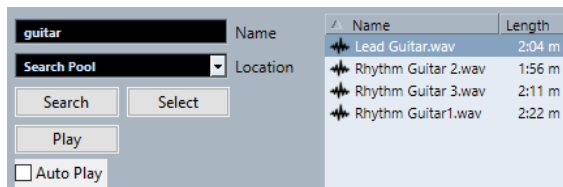

2. Specify the files that you search for in the **Name** field.
You can use partial names or wildcards (*).

NOTE

Only audio files of the supported formats will be found.

3. Use the **Location** pop-up menu to specify where to search.
The pop-up menu lists all your local drives and removable media.
 - To limit the search to certain folders, select **Select Search Path**, and in the dialog that opens, select the folder in which you want to search.

The search includes the selected folder and all subfolders.

NOTE

Folders that you have recently selected using the **Select Search Path** function appear on the pop-up menu, so that you can quickly select them again.

4. Click **Search**.
The search is started and **Search** is labeled **Stop**.
 - To cancel the search, click **Stop**.When the search is finished, the files that are found are listed on the right.
 - To audition a file, select it in the list and use the playback controls to the left (Play, Stop, Pause, and Loop). If **Auto Play** is activated, selected files are automatically played back.
 - To import a file into the **Pool**, double-click the file in the list or select it and click **Import**.
 5. To close the search pane, click **Search** on the toolbar again.
-

Using the Extended Search Functionality

Apart from the search criterion Name, additional search filters and user attributes are available. The extended search options allow for a detailed search, helping you to master even the largest sound database.

PROCEDURE

1. Optional: Create user attributes.
2. In the **Pool** window, click **Search** on the toolbar.
The search pane is displayed in the lower part of the **Pool** window.
3. Click **Name** to open the extended search pop-up menu where you can select and define a search criterion.



The menu also contains the user attributes that you specified, as well as the **Add Filter** and **Presets** submenus.

The search criteria have the following parameters:

- **Name:** partial names or wildcards (*)
 - **Size:** less than, more than, equal, between (two values), in seconds, minutes, hours, and bytes
 - **Bit Depth:** 8 bit, 16 bit, 24 bit, 32 bit, 32 bit float, 64 bit float
 - **Channels:** mono, stereo, and from 3 to 16
 - **Sample Rate:** various values, choose **Other** for free setting
 - **Date:** various search ranges
4. Select one of the search criteria in the pop-up menu.
The search criterion changes to the selected criterion.
 5. Optional: To display more search options, open the extended search pop-up menu, select the **Add Filter** submenu, and select an element.
 6. Optional: To save your search filter settings as a preset, open the extended search pop-up menu, select **Presets > Save Preset**, and enter a name for the preset.
Saved presets are added to the **Presets** submenu.
 7. Optional: To remove a search filter settings preset, open the extended search pop-up menu, select the preset, and then select **Remove Preset**.
-

RELATED LINKS

[User Attributes](#) on page 691

Missing Files

When you open a project and one or more files are missing, the **Resolve Missing Files** dialog opens. If you click **Close**, the project opens without the missing files.

In the **Pool**, you can check which files are considered missing. This is indicated by a question mark in the **Status** column.

A file is considered missing under one of the following conditions:

- The file has been moved or renamed outside the program since you last worked with the project, and you ignored the **Resolve Missing Files** dialog when you opened the project for the current session.
- You have moved or renamed the file outside the program during the current session.

- You have moved or renamed the folder in which the missing files are located.

Locating Missing Files

PROCEDURE

1. Select **Media > Find Missing Files**.
 2. In the **Resolve Missing Files** dialog, decide if you want the program to find the file for you (**Search**), if you want to find it yourself (**Locate**), or if you want to specify in which directory the program searches for the file (**Folder**).
 - If you select **Search**, a dialog opens to let you specify which folder or disk the program scans. Click **Search Folder**, select a directory or a disk, and click **Start**. If found, select the file from the list and click **Accept**. Afterwards, Nuendo tries to map all other missing files automatically.
 - If you select **Locate**, a file dialog opens, allowing you to locate the file manually. Select the file and click **Open**.
 - If you select **Folder**, a dialog opens to let you specify the directory in which the missing file can be found. This might be the preferred method if you have renamed or moved the folder containing the missing file, but the file still has the same name. Once you select the correct folder, the program finds the file and you can close the dialog.
-

Reconstructing Missing Edit Files

If a missing file cannot be found, this is normally indicated with a question mark in the **Status** column in the **Pool**. However, if the missing file is an edit file (a file that is created when you process audio and that is stored in the **Edits** folder within the project folder), it may be possible for the program to reconstruct it by recreating the editing to the original audio file.

PROCEDURE

1. In the **Pool** window, locate the clips for which files are missing.
 2. Check the **Status** column. If the status of the files is "Reconstructible", the files can be reconstructed by Nuendo.
 3. Select the reconstructible clips and select **Media > Reconstruct**.
-

RESULT

The editing is performed and the edit files are recreated.

Removing Missing Files from the Pool

If the **Pool** contains audio files that cannot be found or reconstructed, you may want to remove these.

PROCEDURE

- In the **Pool** window, select **Media > Remove Missing Files**.
-

RESULT

All missing files from the **Pool** and the corresponding events from the **Project** window are removed.

Auditioning Clips in the Pool

You can audition clips in the **Pool** using key commands, the **Audition** button, or by clicking in the waveform image for a clip.

- Use key commands.
If you activate **Playback Toggle Triggers Local Preview** in the **Preferences** dialog (**Transport** page), you can use **Space** to audition. This is the same as activating **Audition** on the toolbar.
- Select a clip and activate **Audition**.
The whole clip plays back. To stop playback, click **Audition** again.
- Click in the waveform image for a clip.
The clip plays back from the selected position in the waveform until the end. To stop playback, click **Audition** or anywhere else in the **Pool** window.

The audio is routed directly to the **Control Room** if activated. When the **Control Room** is deactivated, the audio is routed to the **Main Mix** (the default output) bus, bypassing the settings of the audio channel, effects, and EQs.

NOTE

You can adjust the auditioning level with the miniature level fader on the toolbar. This does not affect the regular playback level.

If you have activated **Audition Loop** before you audition, the following happens:

- When you click **Audition** to audition a clip, the clip is repeated indefinitely until you stop playback by clicking **Audition** or **Audition Loop** again.
- When you click in the waveform image to audition, the section from the selected point to the end of the clip is repeated indefinitely until you stop playback.

Opening Clips in the Sample Editor

The **Sample Editor** allows you to perform detailed editing on the clip.

- To open a clip in the **Sample Editor**, double-click a clip waveform icon or a clip name in the **Media** column.
- To open a certain region of a clip in the **Sample Editor**, double-click a region in the **Pool**.
You can use this to set a snap point for a clip, for example. When you later insert the clip from the **Pool** into the project, the defined snap point allows it to be properly aligned.

RELATED LINKS

[Adjusting the Snap Point](#) on page 594

[Sample Editor](#) on page 574

Importing Media

The **Import Medium** dialog lets you import files directly into the **Pool**.

To open the dialog, select **Media > Import Medium**, or click **Import** on the **Pool** toolbar.

This opens a standard file dialog, where you can navigate to other folders, audition files, etc. The following audio file formats can be imported:

- Wave (Normal or Broadcast)
- AIFF and AIFC (Compressed AIFF)

- MXF (Material Exchange Format)
- REX or REX 2
- FLAC (Free Lossless Audio Codec)
- MPEG Layer 2 and Layer 3 (MP2 and MP3 files)
- Ogg Vorbis (OGG files)
- Windows Media Audio (Windows only)
- Wave 64 (W64 files)

The following characteristics are possible:

- Stereo or mono
- Any sample rate

NOTE

Files that have a different sample rate than the project sample rate are played back at the wrong speed and pitch.

-
- 8 bit, 16 bit, 24 bit, 32 bit, 32 bit float, or 64 bit float
 - Various video formats

NOTE

You can also use the commands on the **Import** submenu of the **File** menu to import audio or video files into the **Pool**.

RELATED LINKS

[Wave Files](#) on page 1178

[Importing ReCycle Files](#) on page 317

[Supported Compressed Audio File Formats](#) on page 314

[Video File Compatibility](#) on page 1234

[MXF Files](#) on page 1306

Importing Audio CDs into the Pool

You can import tracks or sections of tracks from an audio CD directly into the **Pool**. This opens a dialog in which you can specify which tracks are copied from the CD, converted to audio files, and added to the **Pool**.

- To import an audio CD to the **Pool**, select **Media > Import Audio CD**.

RELATED LINKS

[Importing Audio CD Tracks](#) on page 314

Import Options Dialog

The **Import Options** dialog allows you to specify how audio files are imported into the **Pool**.

- If you select a file in the **Import Medium** dialog and click **Open**, the **Import Options** dialog opens.

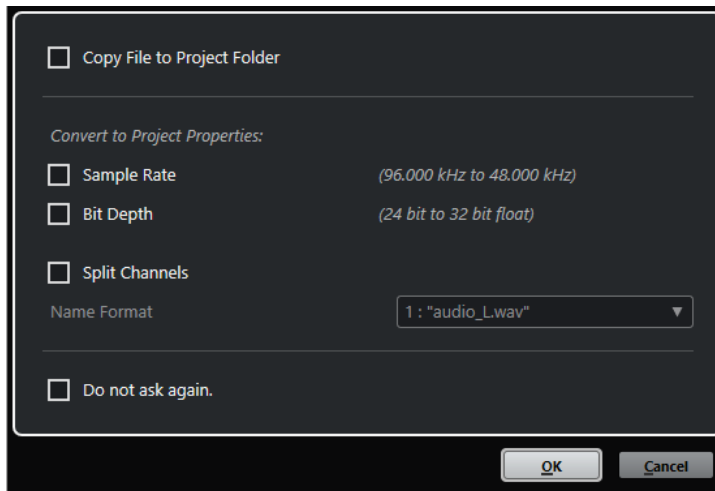

Import Options dialog for single file import

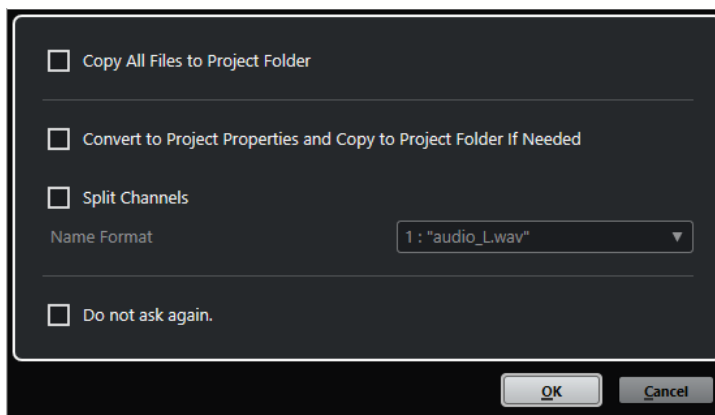

Import Options dialog for multiple file import

Copy File to Project Folder/Copy All Files to Project Folder

Copies the audio file to the **Audio** folder of the project, and has the clip refer to the copy.

Deactivate this option to have the clip refer to the original file in the original location. In this case, it is marked as “external” in the **Pool**.

Convert to Project Settings/Convert to Project Settings and Copy to Project Folder If Needed

Converts the imported file if the sample rate or the bit depth differ from the settings in the **Project Setup** dialog. For single file import, you can choose which properties are converted.

Split Channels

Splits stereo or multi-channel audio files into a corresponding number of mono files, one for each channel, and copies the imported files to the **Audio** folder of the project.

The split files are inserted into the project and into the **Pool** as separate mono tracks.

The **Name Format** pop-up menu allows you to specify how the split files are named. This allows for compatibility with other products when exchanging audio files.

Do not ask again

Always imports files according to the settings without opening the dialog again. You can reset this option in the **Preferences** dialog (**Editing—Audio** page).

RELATED LINKS

[Pool Window Columns](#) on page 677

[Converting Files](#) on page 694

Exporting Regions as Audio Files

If you have created regions within an audio clip, these can be exported as separate audio files. If you have two clips that refer to the same audio file, you can create a separate audio file for each clip.

PROCEDURE

1. In the **Pool** window, select the region that you want to export.
2. Select **Audio > Bounce Selection**.
3. Select the folder in which you want the new file to be created and click **OK**.
4. Optional: If you are using the **Bounce Selection** option to create a separate audio file for a clip that refers to the same audio file as another clip, enter a name for the new audio file.

RESULT

A new audio file is created in the specified folder. The file has the name of the region and is automatically added to the **Pool**.

RELATED LINKS

[Creating Audio Events from Regions](#) on page 593

User Attributes

You can define your own attributes for elements in the **Pool**. This is useful if you have a large number of audio files in the **Pool**. You can use the attributes, for example, to sort items in the **Pool**.

User attributes have their own columns in the **Pool**. Each attribute can be defined as checkbox, text field, or number. You can then specify the user attributes for each file, thus categorizing them further.

All user attributes that you create are automatically available as search criteria in the **Pool**. In the search pane, you can search for values in the user attributes. This allows for a very detailed search and helps you master even the largest sound database.

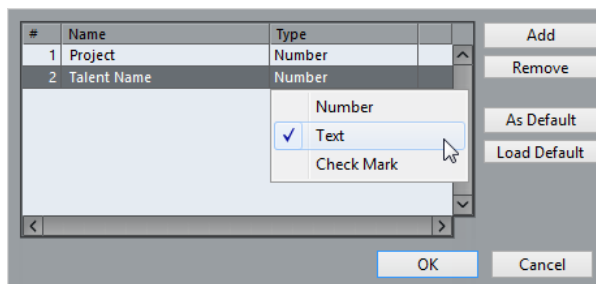

Creating User Attributes

PROCEDURE

1. In the **Pool** window, open the **View/Attributes** pop-up menu, and select **Define User Attributes**.
2. In the **Set up User Attributes** dialog, click **Add**.

A new attribute is added to the attributes list.

3. In the attributes list, enter a name and select an attribute type for the new attribute.
 4. Add as many user attributes as you need.
 5. Click **OK**.
-

RESULT

The user attributes get their own columns in the **Pool**.

Changing the Pool Record Folder

All audio clips that you record in the project are saved in the **Pool Record** folder. The **Pool Record** folder is indicated by the text **Record** in the **Status** column and by a dot on the folder itself.

By default, this is the main **Audio** folder. However, you can create a new **Audio** subfolder and designate this as your **Pool Record** folder.

NOTE

The folders that you create in the **Pool** are only for organizing your files in the **Pool**. All files are recorded to the folder that you specified as the **Pool Record** folder.

PROCEDURE

1. In the **Pool**, select the **Audio** folder or any audio clip.

NOTE

You cannot designate the **Video** folder or any of its subfolders as the **Pool Record** folder.

2. Select **Media > Create Folder**.
 3. Rename the new folder.
 4. Select the new folder and select **Media > Set Pool Record Folder**, or click in the **Status** column of the new folder.
-

RESULT

The new folder becomes the **Pool Record** folder. Any audio recorded in the project is saved in this folder.

Organizing Clips and Folders

If you accumulate a large number of clips in the **Pool**, it can be difficult to quickly find specific items. Organizing clips in new subfolders with names that reflect the content can be a solution. For example, you could put all sound effects in one folder, all lead vocals in another, etc.

PROCEDURE

1. In the **Pool** window, select the folder for which you want to create a subfolder.

NOTE

You cannot put audio clips in a video folder and vice versa.

2. Select **Media > Create Folder**.
3. Rename the folder.

4. Drag the clips to the new folder.
-

Applying Processing to Clips in the Pool

You can apply audio processing to clips from within the **Pool** in the same way as to events in the **Project** window.

PROCEDURE

1. In the **Pool** window, select the clips that you want to process.
 2. Select **Audio > Direct Offline Processing** and select a processing method.
-

RESULT

A waveform symbol indicates that the clips have been processed.

RELATED LINKS

[Direct Offline Processing](#) on page 534

Undoing Processing

You can undo processing that has been applied to clips.

PROCEDURE

1. In the **Pool** window, select the clip from which you want to remove the processing.
 2. Select **Audio > Direct Offline Processing**.
 3. Select the action that you want to remove, and click **Delete**.
-

Minimizing Files

You can minimize the audio files according to the size of the audio clips referenced in the project. The files that are produced using this option only contain the audio file portions that are actually used in the project.

This can significantly reduce the size of the project if large portions of the audio files are unused. Therefore, the option is useful for archiving purposes after you have completed a project.

IMPORTANT

This operation permanently changes the selected audio files in the **Pool**. This cannot be undone. If you only want to create the minimized audio files as a copy, leaving the original project untouched, you can use the **Back up Project** option.

NOTE

Minimizing files clears the entire edit history.

PROCEDURE

1. In the **Pool** window, select the files that you want to minimize.
2. Select **Media > Minimize File**.
3. Click **Minimize**.
After the minimizing is finished, the file references in the stored project become invalid.

4. Do one of the following:
 - To save the updated project, click **Save Now**.
 - To proceed with the unsaved project, click **Later**.
-

RESULT

Only the audio portions that are actually used in the project remain in the corresponding audio files in the **Pool Record** folder.

RELATED LINKS

[Backing up Projects](#) on page 116

Importing and Exporting Pool Files

You can import or export a **Pool** as a separate file. The file extension is “.npl”.

- To import a **Pool** file, select **Media > Import Pool**.
When you import a **Pool** file, its file references are added to the current **Pool**.

NOTE

Since the audio and video files are only referenced but not saved in the **Pool** file, the **Pool** import is only useful if you have access to all referenced files. These files have preferably the same file paths as when the **Pool** was saved.

- To export a **Pool** file, select **Media > Export Pool**.

You can also save and open libraries, that is, stand-alone **Pool** files that are not associated with a project.

RELATED LINKS

[Working with Libraries](#) on page 694

Working with Libraries

You can use libraries to save sound effects, loops, video clips, etc., and transfer media from a library into a project by using drag and drop.

- To create a new library, select **File > New Library**.
You must specify a project folder for the new library in which media files will be stored. The library appears as a separate **Pool** window.
- To open a library, select **File > Open Library**.
- To save a library, select **File > Save Library**.

Converting Files

In the **Pool**, you can convert files to another format.

PROCEDURE

1. In the **Pool** window, select the files that you want to convert.
 2. Select **Media > Convert Files**.
 3. In the **Convert Options** dialog, make your changes and click **OK**.
-

Convert Options Dialog

In this dialog, you can convert audio files in the **Pool**.

- To open the **Convert Options** dialog, select a clip in the **Pool** window, and select **Media > Convert Files**.

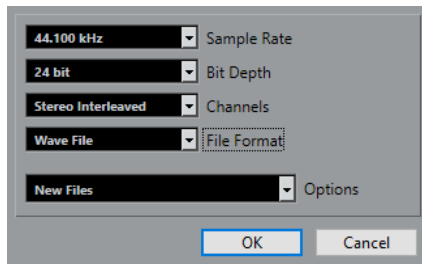

Sample Rate

Allows you to convert to another sample rate.

Bit Depth

Allows you to convert to 16 bit, 24 bit, 32 bit, 32 bit float, or 64 bit float.

Channels

Allows you to convert to mono or stereo interleaved.

File Format

Allows you to convert to Wave, AIFF, MXF, FLAC, Wave 64, or Broadcast Wave Format.

Options

You can use the **Options** pop-up menu to set one of the following options:

- **New Files**
Creates a copy of the file in the audio folder and converts this new file according to the chosen attributes. The new file is added to the **Pool**, but all clip references still point to the original, unconverted file.
- **Replace Files**
Converts the original file without changing clip references. However, the references are saved with the next save action.
- **New + Replace in Pool**
Creates a new copy with the chosen attributes, replaces the original file with the new one in the **Pool** and redirects the current clip references from the original file to the new file. Select this option if you want your audio clips to refer to the converted file, but want to keep the original file on disk, for example, if the file is used in other projects.

Extracting Audio from Video File

You can extract audio from video files. This automatically generates a new audio clip that appears in the **Pool Record** folder.

NOTE

This function is not available for MPEG-1 and MPEG-2 video files.

PROCEDURE

1. In the **Pool** window, select **Media > Extract Audio from Video File**.

2. Select the video file from which you want to extract audio and click **Open**.
-

RESULT

The audio is extracted from the video file. The audio file gets the same file format and sample rate/width as in the current project, and the same name as the video file.

MediaBay and Media Rack

You can manage media files on your computer as well as presets from multiple sources from within the **MediaBay** or the **Media** rack.

The **MediaBay** window offers advanced functions for working with media files and managing database items. To show the media files on your computer in the **MediaBay**, you must scan the folders or volumes that contain the files so that these are added to the database.

The **Media** rack in the right zone of the **Project** window allows you to access some of the most important **MediaBay** functions from within a fixed zone of the **Project** window. For quick access to specific media files, the **Media** rack allows you to add specific folders on your computer as favorites. Media files within the favorite folders that you add in the **Media** rack are automatically scanned and added to the database.

RELATED LINKS

[MediaBay Window](#) on page 708

[Scanning Folders](#) on page 711

[Media Rack in Right Zone](#) on page 697

[Adding Favorites Using the Favorites Page](#) on page 706

[Adding Favorites Using the File Browser Page](#) on page 706

Media Rack in Right Zone

The **Media** rack in the right zone of the **Project** window allows you to access the **MediaBay** functions from within a fixed zone of the **Project** window.

- To open the **Media** rack in the right zone, click **Show/Hide Right Zone** on the **Project** window toolbar, and at the top of the right zone, click the **Media** tab.

The **Media** rack opens on the **Home** page that features different tiles. These tiles correspond to the available media types.

RELATED LINKS

[Showing/Hiding Zones](#) on page 47

[Home Page](#) on page 697

[Project Window Toolbar](#) on page 48

Home Page

The **Home** page gives you access to the tiles that correspond to the available media types, to the **Favorites**, and to the **File Browser**.

- To open the **Home** page, click the **Home** navigation control on the **Media** rack.

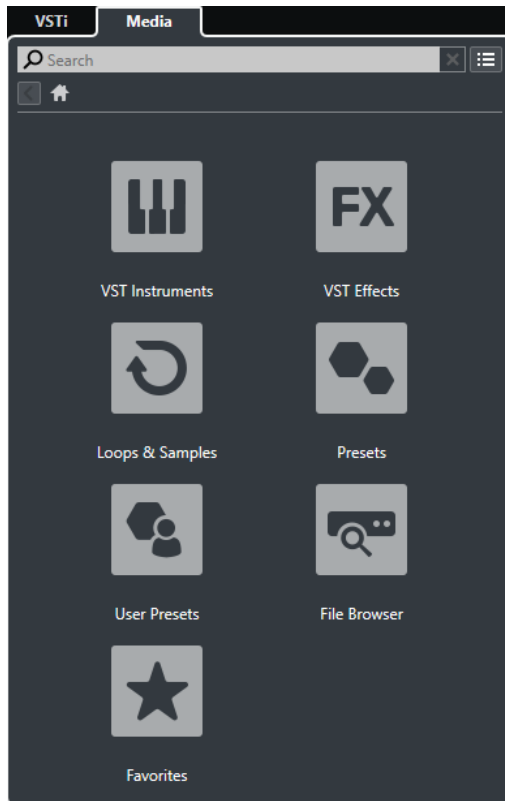

The following tiles are available:

VST Instruments

Shows VST instruments and instrument presets.

VST Effects

Shows VST effects and effect presets.

Loops & Samples

Shows audio loops, MIDI loops, or instrument sounds ordered by content set.

Presets

Shows track presets, strip presets, pattern banks, FX chain presets, and VST FX presets.

User Presets

Shows track presets, strip presets, pattern banks, FX chain presets, VST FX presets, and instrument presets that are listed in the **User Content** folder.

Favorites

Shows your favorite folders and allows you to add new favorites. The folder content is automatically added to the **MediaBay** database.

File Browser

Shows your file system and the pre-defined folders **Favorites**, **This Computer**, **VST Sound**, **Factory Content**, and **User Content** where you can search for media files and access them immediately.

RELATED LINKS

[Loading Instrument Presets](#) on page 733

[Loading Loops and Samples](#) on page 733

[Loading Track Presets](#) on page 733

[Loading Effect Plug-In Presets](#) on page 734

[Loading FX Chain Presets](#) on page 734

[Loading Strip Presets](#) on page 735

[Loading Pattern Banks](#) on page 735

[Adding Favorites Using the Favorites Page](#) on page 706

[Adding Favorites Using the File Browser Page](#) on page 706

Favorites Page

The **Favorites** page allows you to add your own favorite folders to the **Media** rack.

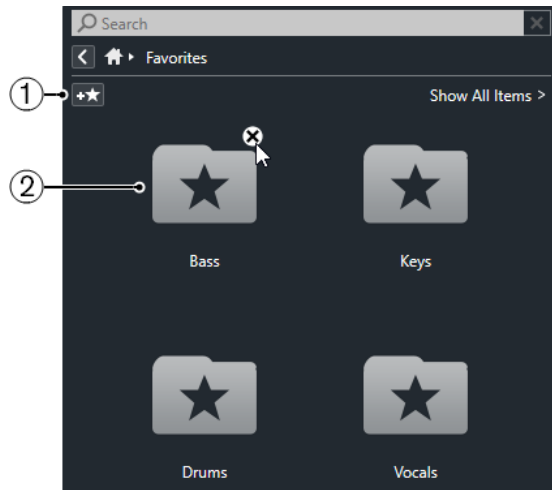

1 Add Favorite

Opens a file dialog where you can navigate to the location of a folder and add it as a favorite folder.

2 Favorite folders

The folders that you added as favorites are shown as tiles on the **Favorites** page.

- To show the content of a folder, click it.
- To delete a folder from the **Favorites** page, click its close button.

RELATED LINKS

[Adding Favorites Using the Favorites Page](#) on page 706

Results Page

The **Results** page shows all media files that are found in the defined favorite folder.

- To open the **Results** page, click the **Show All Results** navigation control on the **Media** rack.

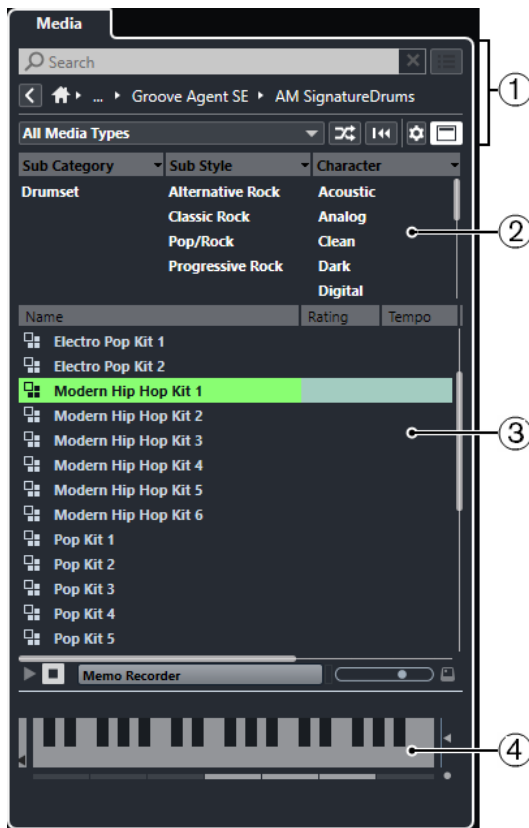

The following options are available:

- 1 Media Rack navigation controls**
Allow you to navigate to specific folders and filter the **Results** list.
- 2 Attribute filter**
Allows you to view and edit some of the standard file attributes found in your media files.
- 3 Results list**
Shows all media files that are found in the selected folder and allows you to select a media file.
- 4 Previewer**
Allows you to preview the selected media file.

RELATED LINKS

- [Media Rack Navigation Controls](#) on page 704
- [Setting up the Results List Columns](#) on page 713
- [Attribute Inspector](#) on page 728
- [Results Section](#) on page 713
- [Previewer Section](#) on page 718

File Browser Page

The **File Browser** page shows all media files that are found in the **File Browser**.

- To open the **File Browser** page, go to the **Home** page of the **Media** rack, and click **File Browser**.

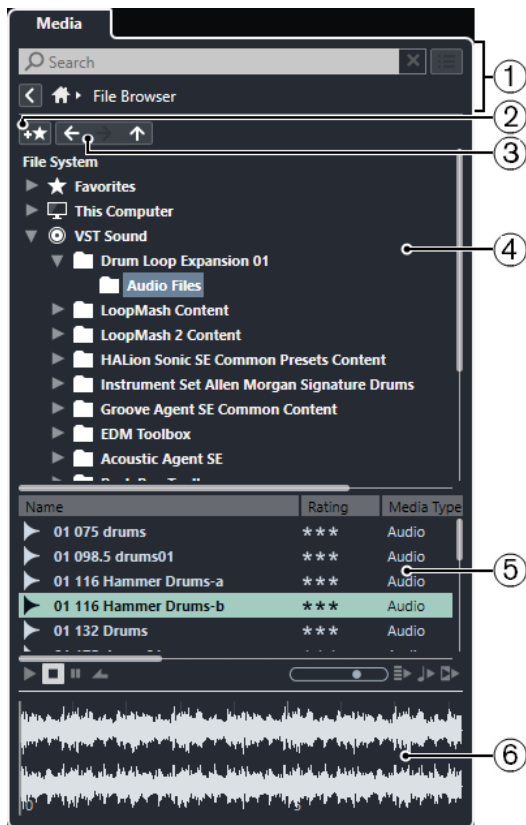

The following options are available:

- 1 Media Rack navigation controls**
Allow you to navigate to specific folders and filter the **Results** list.
- 2 Add Favorite**
Allows you to add the selected folder as a favorite folder.
- 3 Back/Forward/Up**
Up navigates to the parent folder. **Back** navigates to the previously used folder. **Forward** navigates to the most recent folder.
- 4 File browser**
Allows you to browse selected folders.
- 5 Results list**
Shows all supported media files that are found in the selected folder and allows you to select a media file.
- 6 Previewer**
Allows you to preview the selected media file.

RELATED LINKS

[Media Rack Navigation Controls](#) on page 704

[File Browser Section](#) on page 711

[Results Section](#) on page 713

[Previewer Section](#) on page 718

VST Instruments Page

The **VST Instruments** page shows all VST instruments of the selected collection.

- To open the **VST Instruments** page, go to the **Home** page of the **Media** rack, and click **VST Instruments**.

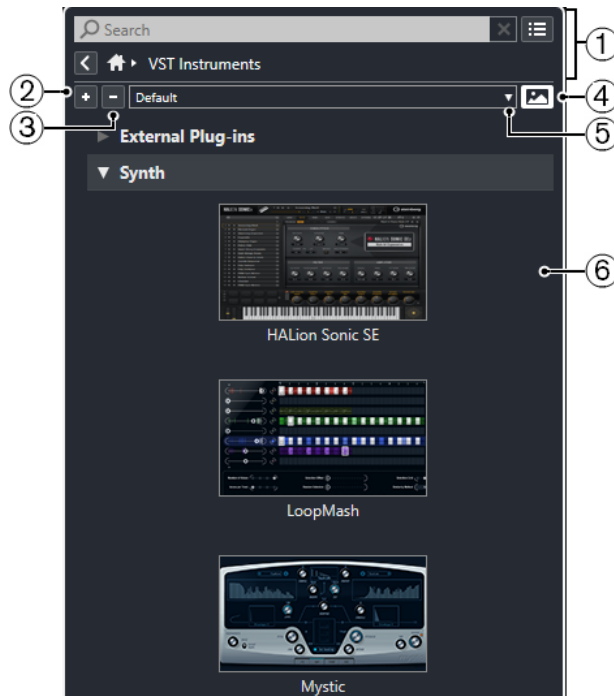

The following options are available:

1 Media Rack navigation controls

Allow you to navigate to specific folders and filter the **Results** list.

2 Expand All

Expands all results.

3 Collapse All

Collapses all results.

4 Show/Hide VST Plug-in Pictures

Shows/Hides the pictures of the VST instrument control panels.

5 Plug-in Collections and Options

- Default** activates the default collection.
- Sort By Category** sorts the collection by category. This is only available for the **Default** collection.
- Sort By Vendor** sorts the collection by vendor. This is only available for the **Default** collection.
- Plug-in Manager** opens the **Plug-in Manager** that allows you to create new plug-in collections. These will be listed in the **Plug-in Collections and Options** menu below the **Default** collection.

6 Plug-in list

Shows the plug-ins of the selected collection.

RELATED LINKS

[VST Plug-in Manager Window](#) on page 853

[Adding Pictures of VST Instruments to the Media Rack](#) on page 707

VST Effects Page

The **VST Effects** page shows all VST effects of the selected collection.

- To open the **VST Effects** page, go to the **Home** page of the **Media** rack, and click **VST Effects**.

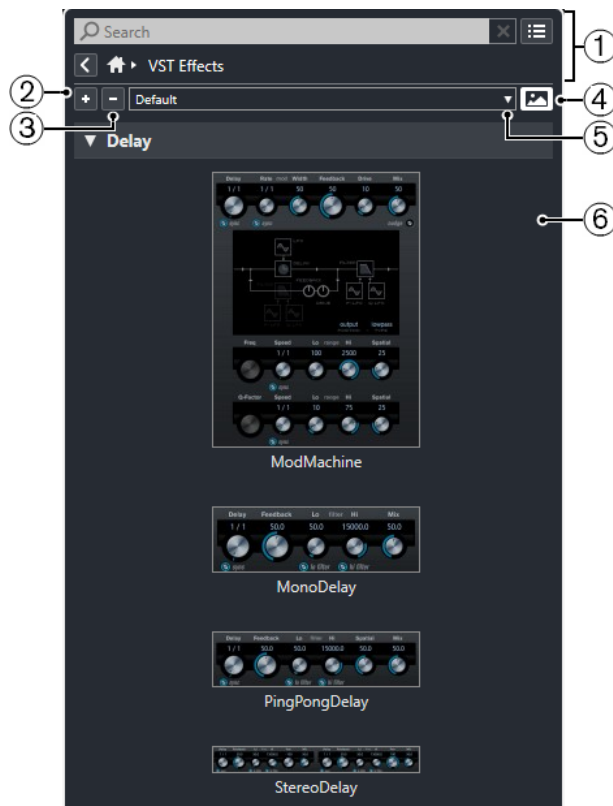

The following options are available:

1 Media Rack navigation controls

Allow you to navigate to specific folders and filter the **Results** list.

2 Expand All

Expands all results.

3 Collapse All

Collapses all results.

4 Show/Hide VST Plug-in Pictures

Shows/Hides the pictures of the VST effect control panels.

5 Plug-in Collections and Options

- Default** activates the default collection.
- Sort By Category** sorts the collection by category. This is only available for the **Default** collection.
- Sort By Vendor** sorts the collection by vendor. This is only available for the **Default** collection.
- Plug-in Manager** opens the **Plug-in Manager** that allows you to create new plug-in collections. These will be listed in the **Plug-in Collections and Options** menu below the **Default** collection.

6 Plug-in list

Shows the plug-ins of the selected collection.

RELATED LINKS

[VST Plug-in Manager Window](#) on page 853

[Adding Pictures of VST Effects to the Media Rack](#) on page 707

Media Rack Navigation Controls

The navigation controls allow you to navigate to files and folders in the **Media** rack.

The following controls allow you to perform a text search, and to show all results on the current page.



1 Search

Allows you to search media files by name or by attribute.

2 Reset Search

Allows you to reset the search.

3 Show All Results

Shows the **Results** page for a selected tile. If no tile is selected, all media files are shown.

The following controls allow you to navigate from the current page to other pages.

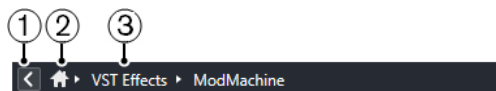

1 Back

Allows you to navigate back to the previous page.

2 Home

Allows you to navigate back to the **Home** page.

3 Breadcrumb path

Shows the path to the current page and allows you to navigate back to the previous page.

The following controls allow you to set up and modify the **Results** page.



1 Select Media Types

Allows you to select the media types that are displayed on the **Results** page.

2 Shuffle Results

Shuffles the **Results** page.

3 Reset Attribute Filter

Lights up if an attribute filter is set. Click this button to reset the attribute filter.

4 Set up Result Columns

Allows you to specify which attribute columns are displayed on the **Results** page.

5 Show/Hide Attribute Filters

Shows/Hides the **Attribute Filters** section.

RELATED LINKS

[Home Page](#) on page 697

[Results Page](#) on page 699

[Media File Attributes](#) on page 726

Working with the Media Rack

The **Media** rack in the right zone of the **Project** window allows you to search for supported media files and included VST instruments, and add them to your project.

The controls on the different pages of the **Media** rack allow you to browse, filter, select, and to preview your media files.

The **Favorites** page and the **File Browser** page allow you to add folders where your media files are located as **Favorites**. This helps you to quickly navigate to these media files.

The tiles and controls on the different pages of the **Media** rack allow you to browse, filter, select, and preview the content.

Once you have located the media file, the instrument, or the preset that you want to use, and selected it in the **Results** list, you can insert it into your project by using drag and drop, by using the context menu options, or by double-clicking.

RELATED LINKS

[Media Rack in Right Zone](#) on page 697

[Results Page](#) on page 699

Adding VST Instruments to Projects

You can use the **Media** rack to add VST instruments to your project.

PROCEDURE

1. In the **Media** rack, click the **VST Instruments** tile.
2. Drag an instrument on the track list or on the event display.

NOTE

To exchange the VST instrument of an instrument track, drag the instrument from the **Media** rack, and drop it on the top section of the instrument track **Inspector**. Note that you must update the track name manually if needed.

RELATED LINKS

[Loading Instrument Presets](#) on page 733

Adding VST Effects to Projects

You can use the **Media** rack to add VST effects to your project.

PROCEDURE

1. In the **Media** rack, click the **VST Effects** tile.
 2. Do one of the following:
 - Drag an effect on the track list to create an FX channel track.
 - To add the effect to an audio-related track, drag the effect from the **Media** rack, and drop it in the **Inserts** or **Sends** section of the track **Inspector**.
 - To add the effect to an audio-related channel, drag the effect from the **Media** rack, and drop it in the **Inserts** or **Sends** section of the **MixConsole** in the lower zone of the **Project** window, or the **Channel Settings** window.
-

RELATED LINKS

[Loading Effect Plug-In Presets](#) on page 734

Applying Track Presets

You can use the **Media** rack to add track presets to your project.

PROCEDURE

1. In the **Media** rack, click the **Presets** tile.
2. Click **Track Presets**.
3. Click **Audio**, **VST Instruments**, **MIDI**, **Multi**, or **Sampler** depending on the track type.
4. Do one of the following:
 - Drag a track preset on the **Inspector** or in the track list for the corresponding track type.
 - Drag a track preset below the track list to add a new track with the track preset loaded.

NOTE

To exchange the track preset of a track, drag the preset from the **Media** rack, and drop it on the track in the track list. Note that you must update the track name manually if needed.

RESULT

The track preset is applied.

Adding Favorites Using the Favorites Page

You can add favorite folders to the **Favorites** page. This allows you to directly access media files in specific folders.

PROCEDURE

1. In the **Media** rack, click the **Favorites** tile.
2. At the top left of the page, click **Add Favorite**.
3. Select the folder that you want to add as a **Favorite**.
4. Click **OK**.

RESULT

- The favorite folder is added to the database.
- On the **Favorites** page, a new tile with the specified name is added.
- In the **File Browser**, a new folder with the specified name is added to the **Favorites** folder.

RELATED LINKS

[Favorites Page](#) on page 699

Adding Favorites Using the File Browser Page

You can add favorite folders using the **File Browser** page. This allows you to directly access media files in specific folders.

PROCEDURE

1. In the **Media** rack, click the **File Browser** tile.
2. In the **File Browser**, navigate to the folder that you want to add as a favorite and select it.

3. Do one of the following:
 - At the top left of the page, click **Add Favorite**.
 - Right-click the folder, and from the context menu, select **Add Favorite**.
 4. In the **Set Name** dialog that opens, enter a name for the folder.
 5. Click **OK**.
-

RESULT

- The favorite folder is added to the database.
- In the **File Browser**, a new folder with the specified name is added to the **Favorites** folder.
- On the **Favorites** page, a new tile with the specified name is added.

RELATED LINKS

[File Browser Page](#) on page 700

Adding Pictures of VST Instruments to the Media Rack

Pictures of VST instruments from other vendors are not loaded by default. However, you can add them to the **Media** rack manually.

PREREQUISITE

You have added the VST instrument of another vendor as a rack or a track instrument.

PROCEDURE

1. Open the control panel of the VST instrument.
 2. On the control panel, click **Add VST Plug-in Picture to Media Rack**.
-

RESULT

The picture of the VST instrument is shown in the **Media** rack.

RELATED LINKS

[Adding VST Instruments](#) on page 835

[VST Instrument Control Panel](#) on page 835

Adding Pictures of VST Effects to the Media Rack

Pictures of VST effects from other vendors are not loaded by default. However, you can add them to the **Media** rack manually.

PREREQUISITE

You have added a VST effect from another vendor.

PROCEDURE

1. Open the control panel of the VST effect.
 2. On the control panel, click **Add VST Plug-in Picture to Media Rack**.
-

RESULT

The picture of the VST effect is shown in the **Media** rack.

RELATED LINKS

[Adding Insert Effects](#) on page 505

[Effect Control Panel](#) on page 523

MediaBay Window

To open the **MediaBay** in a separate window, do one of the following:

- Select **Media > MediaBay**.
- Press **F5**.



The **MediaBay** is divided into the following sections:

1 File Browser

Allows you to scan specific folders in your file system, and to add favorites.

2 Toolbar

Contains tools and shortcuts for settings and functions in the **MediaBay**, and allows you to switch between the previously defined favorite locations. Favorites in the **MediaBay** window are not automatically scanned.

3 Filters

Allows you to filter the **Results** list using a logical or an attribute filter.

4 Results

Displays all supported media files. You can filter the list and perform text searches.

5 Previewer

Allows you to preview the files shown in the **Results** list.

6 Attribute Inspector

Allows you to view, edit, and add media file attributes or tags.

RELATED LINKS

[File Browser Section](#) on page 711

[MediaBay Toolbar](#) on page 709

[Adding Favorites](#) on page 712

[Scanning Folders](#) on page 711
[Filters Section](#) on page 724
[Results Section](#) on page 713
[Previewer Section](#) on page 718
[Attribute Inspector](#) on page 728
[Setting up the MediaBay](#) on page 711

MediaBay Toolbar

The toolbar contains tools and shortcuts for settings and functions in the **MediaBay**.

Navigation

Back



Navigates to the previously used folder.

Forward



Navigates to the most recent folder.

Up



Navigates to the parent folder.

Favorites

Add Favorite



Allows you to add the selected folder as a favorite folder.

Select Defined Favorite

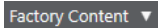

Allows you to select a **Favorite** to quickly browse to the files you are looking for.

Include Folders and Subfolders



Activate this to show the content of folders and subfolders.

Left Divider

Left Divider

Tools that are placed to the left of the divider are always shown.

Text Search

Search

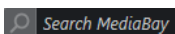

Allows you to search media files by name or by attribute.

Media Types Filter

Select Media Types

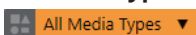

Allows you to select the media types that are displayed on the **Results** page.

Rating Filter

Rating Filter

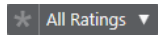

Filters files according to their rating.

Reset Result Filters

Reset Filters



Allows you to reset the filters.

Results

Update Results



Updates the results.

Shuffle Results



Shuffles the **Results** page.

Attribute Counter

Attribute Counter



Shows the number of attributes that are being updated.

Right Divider

Right Divider

Tools that are placed to the right of the divider are always shown.

MediaBay Settings

MediaBay Settings



Opens the **MediaBay** settings.

Window Zone Controls

Show/Hide Left Zone



Shows/Hides the left zone of the window.

Show/Hide Lower Zone



Shows/Hides the lower zone of the window.

Show/Hide Right Zone



Shows/Hides the right zone of the window.

Set up Window Layout



Allows you to set up the window layout.

Set up Toolbar



Opens a pop-up menu where you can set up which toolbar elements are visible.

Setting up the MediaBay

You can show and hide the different sections of the **MediaBay**. This saves screen space and allows you to display only the information that you need.

PROCEDURE

1. Click **Set up Window Layout**.
 2. Activate/Deactivate the checkboxes for the sections that you want to show/hide.
 3. Click outside the pane to exit the setup mode.
-

File Browser Section

The **File Browser** section shows your file system with the pre-defined folders **Favorites**, **This Computer**, **VST Sound**, **Factory Content**, and **User Content**.

- To open the **File Browser** section in the **MediaBay**, click **Set up Window Layout** and activate **File Browser**.

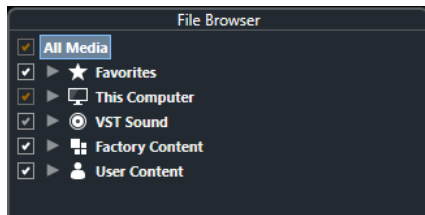

To show the supported media files in the **Results** section of the **MediaBay**, you must scan all folders that you want to include in the search.

You can also add favorite folders. All media files contained in a **Favorite** are automatically scanned.

RELATED LINKS

[Scanning Folders](#) on page 711

[Adding Favorites](#) on page 712

Scanning Folders

To include specific folders in the **MediaBay** search, you must scan them.

PROCEDURE

1. In the **File Browser** section of the **MediaBay**, navigate to the folder that you want to include in the scan.
2. Activate the checkbox for the folder to activate the scan.

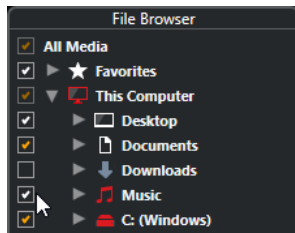

RESULT

All files that are found in the scanned folder are shown in the **Results** list. The scan result is saved in a database file.

The color of the checkmark helps you to identify which folders and subfolders are scanned:

- White indicates that all subfolders are included in the scan.
- Orange indicates that at least one subfolder is excluded from the scan.

The color of the folder indicates the state of the scan:

- Red indicates that a folder is currently being scanned.
- White indicates that all subfolders have been scanned.
- Yellow indicates that at least one subfolder is not yet scanned.

NOTE

Please wait until the **MediaBay** completes the scan to continue your work.

Adding Favorites

You can add favorite folders using the **File Browser** section.

PROCEDURE

1. In the **File Browser** section, navigate to the folder that you want to add as a favorite, and select it.
 2. Right-click the folder or the volume, and from the context menu, select **Add Favorite**.
 3. In the **Set Name** dialog that opens, enter a name for the folder.
 4. Click **OK**.
-

RESULT

- In the **File Browser** section, a new folder with the specified name is added to the **Favorites** folder.
- In the **Favorites** section, the added favorite is available in the **Select Defined Favorite** pop-up menu.
- In the **Media** rack in the right zone of the **Project** window, a new tile with the specified name is added on the **Favorites** page.

NOTE

Favorites in the **MediaBay** window are not automatically scanned.

AFTER COMPLETING THIS TASK

To remove a **Favorite**, select it in the **Favorites** tree of the **File Browser** section, open the context menu and select **Remove Favorite**.

RELATED LINKS

[Scanning Folders](#) on page 711

Refresh Views

If you change already scanned folders by adding or removing files when Nuendo is closed, you must rescan the corresponding media folders. This also applies if you modified attributes of your user content using another program.

If you have made changes to your content and want the changes to be displayed in the **MediaBay**, you must refresh the views of the corresponding media folders.

- To refresh a folder, in the **File Browser** section of the **MediaBay**, right-click a folder, and select **Refresh Views**.
- To display a new drive, in the **File Browser** section of the **MediaBay**, right-click the parent node, and select **Refresh Views**. You can then scan the drive for media files.
- To update the scan state of the folders after modifying the volume database with another program, right-click the volume database, and select **Refresh Views**.

Results Section

The **Results** list shows all media files that are found in the selected folder in the **File Browser**.

- To show media files in the **Results** section, you must select a scanned folder in the **File Browser** section of the **MediaBay**.

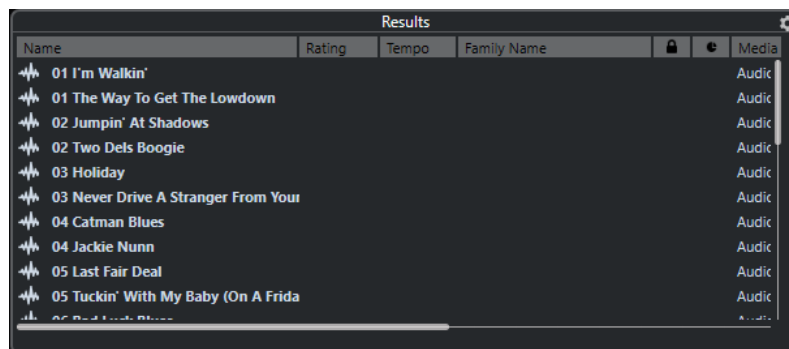

NOTE

You can set the maximum number of files that are displayed in the **Results** list in the **MediaBay Settings**.

Setting up the Results List Columns

For each media type, or for combinations of media types, you can specify the attribute columns that are displayed in the **Results** list.

PROCEDURE

1. In the **Results** section, select the media types for which you want to make settings.
2. Click **Set up Result Columns** and do one of the following:
 - To show specific columns, activate or deactivate the respective options on the submenus.
 - To remove all columns except **Name**, select **Select None**.
 - To show the default columns, select **Use Defaults**.
 - To show all columns with set attributes, select **All Available**.

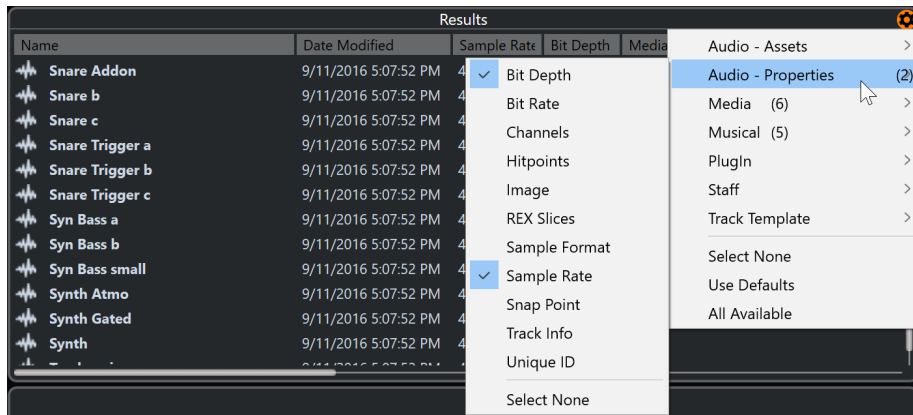

NOTE

If **Allow Editing in Results List** is activated in the **MediaBay Settings**, you can also edit attributes in the **Results** list. Otherwise, this is only possible in the **Attribute Inspector**.

RELATED LINKS

[Setting up the MediaBay](#) on page 711

[Attribute Inspector](#) on page 728

Managing Media Files in the Results List

- To move or copy a file from the **Results** list to another location, drag it to another folder in the **File Browser** section.
- To change the order of the columns in the **Results** list, click a column header and drag that header to another position.
- To delete a file, right-click it in the list and select **Delete**. The file is permanently deleted from your computer.

IMPORTANT

If you delete a file using the File Explorer/macOS Finder, it is still displayed in the **Results** list, although it is no longer available to the program. To remedy this, rescan the corresponding folder.

Shuffling the Results List

You can display the **Results** list entries in a random order.

- To shuffle the **Results** list, click **Shuffle Results** in the **MediaBay** toolbar.

Finding the Location of a File

You can show the location of a file on your system in the File Explorer/macOS Finder.

NOTE

This function is not available for files which are part of a VST Sound archive.

PROCEDURE

- In the **Results** list, right-click a file, and select **Show in Explorer/Reveal in Finder**.

RESULT

The File Explorer/macOS Finder opens and the corresponding file is highlighted.

Filtering According to Media Type

You can set up the **Results** list to display only a particular media type or a combination of media types.

PROCEDURE

1. In the **MediaBay** toolbar, open the **Show Media Types** selector.

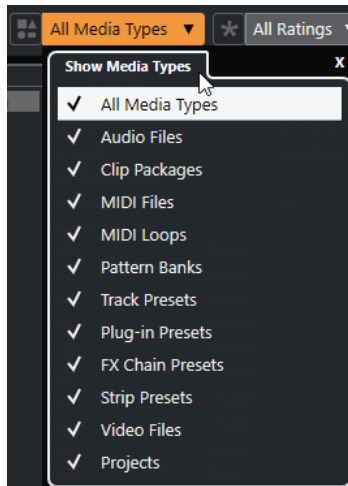

2. Activate the media types that you want to be displayed in the **Results** list.

RESULT

The files are filtered by the selected media type.

Show Media Types Selector

You can activate the media types that you want to be displayed in the **Results** list.

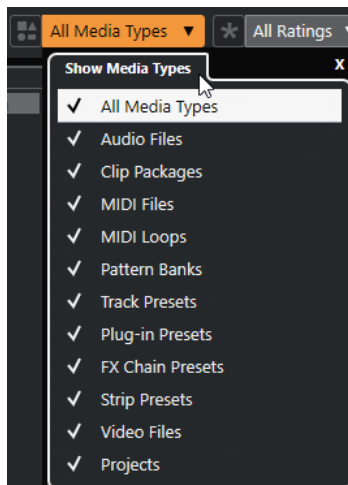

The following media types are available:

Audio Files

Shows all audio files. The supported formats are .wav, .w64, .aiff, .aifc, .rex, .rx2, .mp3, .mp2, .ogg, .wma (Windows only).

Clip Packages

If this option is activated, the list shows all clip packages (file name extension `.package`). Clip packages contain a number of audio parts and events, which make up a special sound.

MIDI Files

Shows all MIDI files (file name extension `.mid`).

MIDI Loops

Shows all MIDI loops (file name extension `.midiloop`).

Pattern Banks

Shows all pattern banks (file name extension `.patternbank`). Pattern banks are generated via the MIDI plug-in **Beat Designer**. For more information, see the separate document **Plug-in Reference**.

Track Presets

Shows all track presets for audio, MIDI, and instrument tracks (file name extension `.trackpreset`). Track presets are a combination of track settings, effects, and **MixConsole** settings that can be applied to new tracks of various types.

Plug-in Presets

Shows all VST presets for instrument and effect plug-ins. Furthermore, EQ presets that you save in the **MixConsole** are listed. These presets contain all parameter settings for a particular plug-in. They can be used to apply sounds to instrument tracks and effects to audio tracks.

Strip Presets

Shows all strip presets (file name extension `.strippreset`). These presets contain channel strip effect chains.

FX Chain Presets

Shows all effect chain presets (file name extension `.fxchainpreset`). These presets contain insert effect chains.

Video Files

Shows all video files.

Projects

Shows all project files (from Cubase, Nuendo): `.cpr`, `.npr`.

RELATED LINKS

[Clip Packages](#) on page 210

[Pattern Banks Previewer](#) on page 722

[Track Presets](#) on page 201

[Saving/Loading Strip Presets](#) on page 452

[Saving/Loading EQ Presets](#) on page 445

[Saving/Loading FX Chain Presets](#) on page 442

[Video File Compatibility](#) on page 1234

Filtering According to Rating

With the **Rating Filter**, you can filter files according to their rating.

NOTE

The **Rating Filter** is not available in the **Media** rack in the right zone.

PROCEDURE

- In the **Rating Filter** section of the **MediaBay** toolbar, select a value from the **Rating Filter** pop-up menu.
-

Performing a Text Search

You can perform a text search of the **Results** list. If you enter text in the text search field on the **MediaBay** toolbar, only media files whose attributes match the entered text are displayed.

NOTE

The **Search MediaBay** field has the same function as the **matches** operator of the logical filter. However, the search is applied to all file attributes.

- Click the field and enter the text that you want to find.
For example, if you are looking for all audio loops relating to drum sounds, enter “drum” in the search field. The search results will contain loops called “Drums 01”, “Drumloop”, “Snare Drum”, etc. In addition, all media files with the **Drum&Percussion** category attribute or any other attribute that contains “drum” are found. You can also add apostrophes to find exact matches for the entered words and use boolean operators.

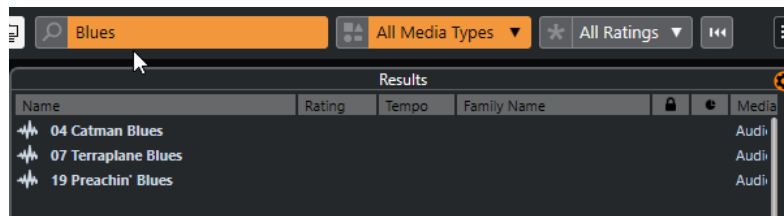

- To reset the text search, delete the text, or click **Reset Filters**.

RELATED LINKS

[Logical Filter](#) on page 724

Boolean Text Search

You can perform advanced searches, using boolean operators or wildcards.

You can use the following elements:

And [+]

[a and b]

When entering strings separated by “and” (or a plus sign), all files are found that contain both a and b.

[And] is the default setting when no boolean operator is used, for example, you can also enter [a b].

Or [,]

[a or b]

When entering strings separated by “or” (or a comma), files are found that contain either a or b, or both.

Not [-]

[not b]

When entering text preceded by “not” (or a minus sign), all files not containing b are found.

Parentheses [()]

[(a or b) + c]

Using parentheses, you can group text strings. In this example, files are found that contain c and either a or b.

Quotation marks [""]

["your search text"]

With quotation marks, you can define sequences of several words. Files are found if they contain the sequence of words that you entered.

IMPORTANT

When you are searching for files whose names contain a hyphen, put the search text in quotation marks. Otherwise the program treats the hyphen as the boolean operator "not".

NOTE

These operators can also be used for logical filtering.

RELATED LINKS

[Applying a Logical Filter](#) on page 725

Resetting the Results List

You can reset all filter settings and filter results.

- In the **MediaBay** toolbar, click **Reset Filter**.

Previewer Section

You can preview individual files in the **Previewer** section to find out which one to use in your project.

The elements visible in this section and their functions depend on the media type.

IMPORTANT

The **Previewer** section is not available for video files, project files, and audio track presets.

RELATED LINKS

[MediaBay Settings](#) on page 739

Audio Files Previewer

The **Previewer** for audio files allows you to listen to audio files before you use them in your project.



1 Transport controls

Start, stop, pause, and cycle the preview.

2 Preview Level fader

Specifies the preview level.

3 Auto Play New Results Selection

Automatically plays back the selected file.

4 Align Beats to Project

Plays back the selected file in sync with the project, starting at the project cursor position. Note that this can apply real-time time stretching to your audio file.

NOTE

If you import an audio file into your project for which **Align Beats to Project** is activated in the **Previewer, Musical Mode** is automatically activated for the corresponding event.

5 Wait for Project Play

Synchronizes the play and stop functions from the **Transport** panel with the play and stop buttons in the **Previewer** section.

To use this option to its full extent, set the left locator at the beginning of a bar, then start playing back the project using the **Transport** panel. The loops that you now select in the **Results** list start together with the project in perfect sync.

RELATED LINKS

[Musical Mode](#) on page 606

Using Selection Ranges

You can specify selection ranges to preview a particular section of an audio file and insert it into the project.

NOTE

Selection ranges cannot be used when the **Align Beats to Project** option is activated in the **Previewer**.

- To select a range, move the mouse over the upper part of the waveform, so that it turns into a pencil, click and drag.



- To adjust the borders of the selection range, drag the handles.



- To deselect the range, drag both handles all the way to the left.

MIDI Files Previewer

The **Previewer** for MIDI files allows you to listen to MIDI files before you use them in your project.

- To preview a MIDI file, load a VST instrument, and select it as output device from the **Select MIDI Output** pop-up menu.



1 Transport controls

Start and stop the preview.

2 Preview Level fader

Specifies the preview level.

3 Output

Allows you to select the output device.

4 Align Beats to Project

Plays back the selected file in sync with the project, starting at the project cursor position. Note that this can apply real-time time stretching to your MIDI file.

5 Auto Play New Results Selection

Automatically plays back the selected file.

RELATED LINKS

[VST Instruments](#) on page 835

MIDI Loops Previewer

The **Previewer** for MIDI loops allows you to listen to MIDI loops before you use them in your project.

NOTE

MIDI loops are always played back in sync with the project.



1 Transport controls

Start and stop the preview.

2 Preview Level fader

Specifies the preview level.

3 Auto Play New Results Selection

Automatically plays back the selected file.

4 Link Playback to Chord Track

Transposes the events of the MIDI loop to play back in context with the chord track. Note that you need a chord track with chord events for this.

If this option is activated, and you insert a MIDI loop into the project, **Follow Chord Track** is automatically activated for the track.

RELATED LINKS

[Using Follow Chord Track](#) on page 1068

VST Presets and Track Presets Previewer for MIDI and Instrument Tracks

The **Previewer** for VST presets and track presets allows you to listen to presets before you use them in your project.

- To preview track presets for MIDI or instrument tracks and VST presets, you must send some MIDI notes to the track preset via MIDI input, using a MIDI file, the **Memo Recorder** mode, or via the computer keyboard.

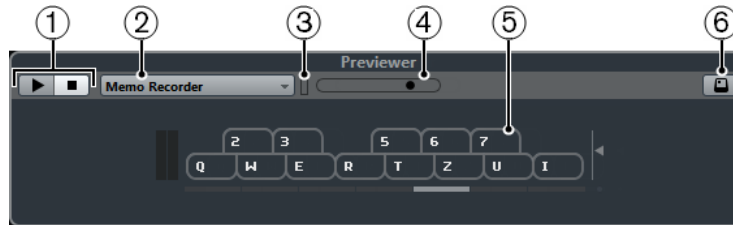

1 Transport controls

Start and stop the preview.

2 Previewer Sequence Mode

Allows you to load a MIDI file to apply the selected preset to the MIDI file. You can also select the **Memo Recorder** mode that continually repeats a given sequence of notes as a loop.

3 MIDI Activity

Allows you to monitor incoming MIDI messages.

4 Preview Level fader

Specifies the preview level.

5 Keyboard

You can display the **Keyboard** in keyboard display mode or in piano display mode.

6 Computer Keyboard Input

Allows you to use your computer keyboard to preview the presets.

RELATED LINKS

[Previewing Presets Using the Memo Recorder Mode](#) on page 722

[On-Screen Keyboard](#) on page 288

Previewing Presets Via MIDI Input

MIDI input is always active. For example, when a MIDI keyboard is connected to your computer and set up properly, you can directly start playing the notes to preview the selected preset.

Previewing Presets Using a MIDI File

PROCEDURE

1. On the **Previewer Sequence Mode** pop-up menu, select **Load MIDI File**.
 2. In the file dialog that opens, select a MIDI file and click **Open**.
The name of the MIDI file is displayed on the pop-up menu.
 3. Click **Play** to the left of the pop-up menu.
-

RESULT

The notes received from the MIDI file are played back with the settings of the track preset applied.

NOTE

The recently used MIDI files are kept on the menu for quick access. To remove an entry from this list, select it on the menu and then select **Remove MIDI File**.

Previewing Presets Using the Memo Recorder Mode

The **Memo Recorder** mode continually repeats a given sequence of notes as a loop.

NOTE

You cannot use the **Memo Recorder** mode when previewing presets using a MIDI file.

PROCEDURE

1. On the **Previewer Sequence Mode** pop-up menu, select **Memo Recorder**.
 2. Activate **Play**.
 3. Play some notes on the MIDI keyboard or on the computer keyboard.
-

RESULT

The notes are played back with the instrument preset that is selected in the **Results** section.

When you stop playing notes and wait for 2 seconds, the note sequence that you played until this moment is played back in a continuous loop.

To use another sequence, start entering notes again.

Previewing Presets Via the Computer Keyboard

NOTE

If you activate **Computer Keyboard Input**, the computer keyboard is used exclusively for the **Previewer** section. However, you can still use the following key commands: **Ctrl/Cmd - S** (Save), **Num *** (Start/Stop Record), **Space** (Start/Stop Playback), **Num 1** (Jump to left locator), **Delete** or **Backspace**, **Num /** (Cycle on/off), and **F2** (Show/Hide Transport panel).

PROCEDURE

1. Activate **Computer-Keyboard Input**.
 2. Play some notes on the computer keyboard.
-

Pattern Banks Previewer

The **Previewer** for pattern banks allows you to listen to pattern banks before you use them in your project.

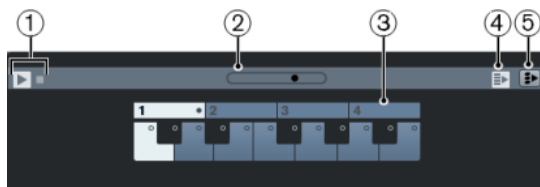

- 1 **Transport controls**
Start and stop the preview.
- 2 **Preview Level fader**

Specifies the preview level.

3 Keyboard

The keyboard allows you to preview the selected pattern bank. In the **Previewer** section, choose a subbank (the number at the top) and pattern (a key), and click **Play**.

One pattern bank contains 4 subbanks which in turn contain 12 patterns each.

Subbanks can contain empty patterns. Selecting an empty pattern in the **Previewer** section has no effect. Patterns containing data are indicated by a circle in the upper part of the key in the display.

4 Auto Play New Results Selection

Automatically plays back the selected file.

5 Link Playback to Chord Track

Transposes the events of the pattern bank to play back in context with the chord track. Note that you need a chord track with chord events for this.

NOTE

You can create drum patterns with the MIDI plug-in **Beat Designer**. You can find detailed information on the **Beat Designer** and its functions in the separate document **Plug-in Reference** in the **MIDI Effects** chapter.

Clip Packages Previewer

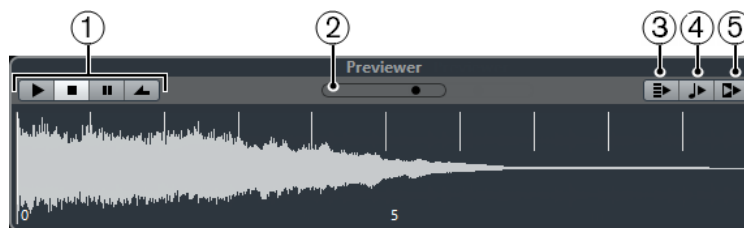

1 Transport Controls

Start, stop, pause, and cycle the preview.

2 Preview Level Fader

Specifies the preview level.

3 Auto Play New Results Selection

Automatically plays back the selected file.

4 Align Beats to Project

Plays back the selected file in sync with the project, starting at the project cursor position. Note that this can apply realtime time stretching to your audio file.

NOTE

If you import an audio file into your project for which **Align Beats to Project** is activated in the **Previewer, Musical Mode** is automatically activated for the corresponding track.

5 Wait for Project Play

Synchronizes the play and stop functions from the **Transport** panel with the play and stop buttons in the **Previewer** section.

To use this option to its full extent, set the left locator at the beginning of a bar, then start playing back the project using the **Transport** panel. The loops that you now select in the **Results** list will start together with the project in perfect sync.

RELATED LINKS

[Clip Packages](#) on page 210

Filters Section

The **MediaBay** allows you to refine your file searches. You have two possibilities: **Logical** or **Attribute** filtering. You can also save your filter settings in a MediaBay Aspect, which allows for a quick recall of particular searches.

RELATED LINKS

[MediaBay Aspects](#) on page 736

Logical Filter

The logical filter allows you to set up complex search conditions that must be met to find files.

NOTE

The **Logical Filter** is not available in the **Media** rack in the right zone.

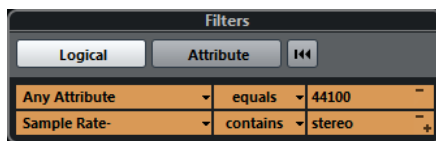

contains

The search result must contain the text or number specified in the text field to the right.

matches words

The search result must match the words specified in the text field to the right.

omits

The search result must not contain the text or number specified in the text field to the right.

equals

The search result must correspond exactly to the text or number specified in the text field to the right, including any file extension. Text searches are not case-sensitive.

>=

The search result must be higher than or equal to the number specified in the field to the right.

<=

The search result must be lower than or equal to the number specified in the field to the right.

is empty

Use this option to find files for which certain attributes have not been specified yet.

matches

The search result must include the text or number entered in the text field to the right. You can also use boolean operators. Add apostrophes to find exact matches for the entered words, for example, 'drum' AND 'funky'. This option allows for a very advanced text search.

in range

If this option is selected, you can specify a lower and an upper limit for the search result in the fields to the right.

Applying a Logical Filter

To quickly find certain audio files, you can search for a specific file attribute value, for example.

PREREQUISITE

The folder in which you want to search for files is selected.

PROCEDURE

1. In the **Filters** section, activate **Logical**.
2. Click **Search in these Attributes** to open the **Select Filter Attributes** dialog.
3. Select the attributes that you want to use.
If you select more than one attribute, the files found match either one or the other attribute.
4. Click **OK**.
5. On the condition pop-up menu, select one of the search operators.

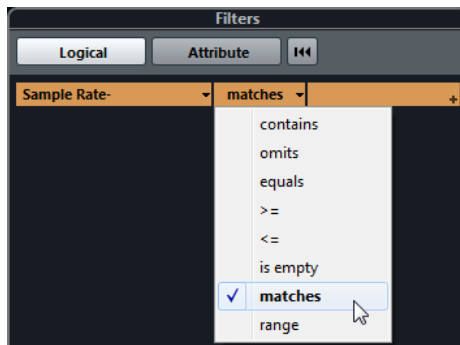

6. Enter the text or number that you want to find in the field to the right.

NOTE

If you enter 2 or more strings or filter lines, the files that are found match all strings or filter lines.

- To add more than one string in the text field, enter a **Space** between them.
 - To add another filter line, click **+** to the right of the text field. You can add up to seven filter lines in which you can define further search conditions.
 - To remove a filter line, click **-**.
 - To reset all search fields to their default settings, click **Reset Filter** at the top of the **Filters** section.
-

RESULT

The **Results** list is automatically updated, showing only the files that correspond to your search conditions.

Advanced Text Search

You can perform advanced text searches using boolean operators.

PREREQUISITE

The folder in which you want to search for files is selected.

PROCEDURE

1. In the **Filters** section, activate **Logical**.

2. Select an attribute on the **Search in these Attributes** pop-up menu or keep the **Any Attribute** setting on.
3. Set the condition to **matches**.
4. Specify the text that you want to search for in the field to the right using boolean operators.

RELATED LINKS

[Performing a Text Search](#) on page 717

Media File Attributes

Media file attributes are sets of metadata providing additional information on the file.

The different types of media files have different attributes. For example, .wav audio files have attributes, such as name, length, size, sample rate, content set, etc., while .mp3 files have additional attributes, such as artist or genre. In postproduction contexts, you would use attributes like actor's text, episode, pull factor, etc.

RELATED LINKS

[Attribute Inspector](#) on page 728

Attribute Filter

Assigning attribute values to your files facilitates organizing your media files. The **Attribute** filter allows you to view and edit some of the standard file attributes that are found in your media files.

If you click **Attribute**, the **Filters** section displays all values that have been specified for the displayed attribute categories. Selecting one of these values filters the results to display only the files to which this attribute value is assigned.

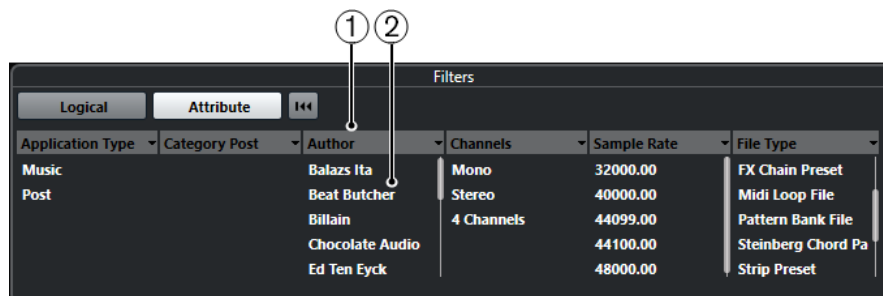

1 Attribute column titles

Allow you to select different attribute categories. If the columns are wide enough, the number of files that match these criteria is displayed to the right of the value.

2 Attribute values

Displays the attribute values and how often a certain attribute value is available among your media files.

NOTE

- Some attributes are directly linked to each other. For example, for each category value, there are certain sub-category values available. Changing the value in one of these attribute columns displays different values in the other column.
- Each attribute column displays only the attribute values that are found.

RELATED LINKS

[Attribute Inspector](#) on page 728

Applying an Attribute Filter

With the **Attribute** filter, you can quickly find tagged media files with certain attributes.

- To apply an **Attribute** filter, select an attribute value.
The **Results** list is filtered accordingly. Apply more attribute filters to narrow down the result even more.
- To find files that match either one or the other attribute, **Ctrl/Cmd**-click different attribute values in the same column.
- To change the displayed attribute values of a column, click the attribute column title and select another attribute.

NOTE

Character attributes always form an AND condition.

Performing a Context Menu Search

You can search for other files that have the same attribute as the selected file. This allows you to find all the files that have a value in common, for example, if you want to view all the files that were created on the same day.

- In the **Results** list or the **Attribute Inspector**, right-click a file and select the attribute value for which you want to search from the **Search for** submenu.

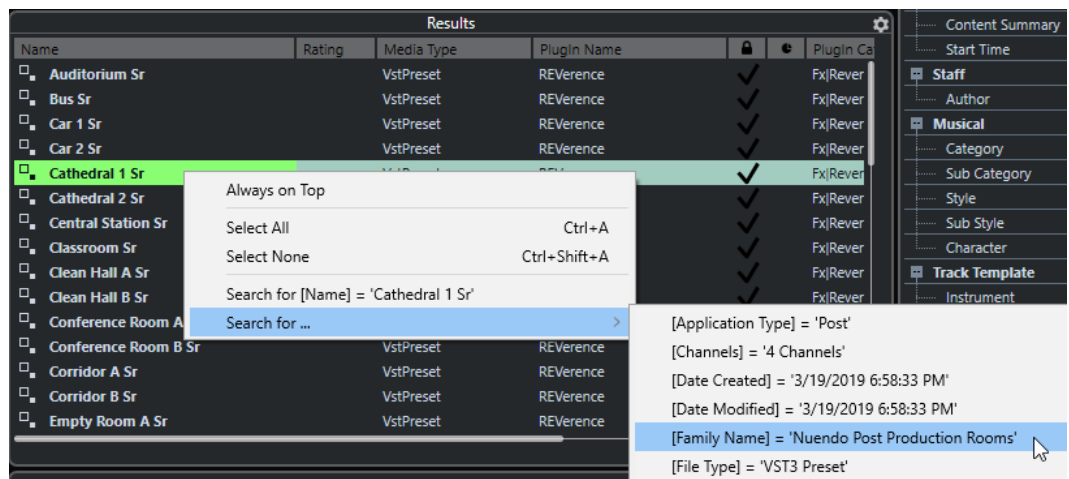

The **Filters** section automatically switches to **Logical** filtering and the corresponding filter condition line is displayed.

- To reset the filter, click **Go Back**.

Resetting the Filter

PROCEDURE

- To reset the filter, click **Reset Filter** at the top of the **Filters** section.

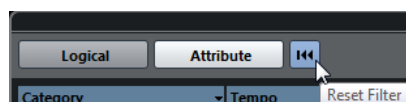

This also resets the **Results** list.

Attribute Inspector

When you have selected one or more files in the **Results** list, the **Attribute Inspector** shows a list of attributes and their values.

NOTE

The **Attribute Inspector** is not available in the **Media** rack in the right zone.

In the **Attribute Inspector**, you can also edit and add new attribute values.

The available attributes are divided into several groups (Media, Musical, Preset, etc.), to keep the list manageable and to facilitate finding items.

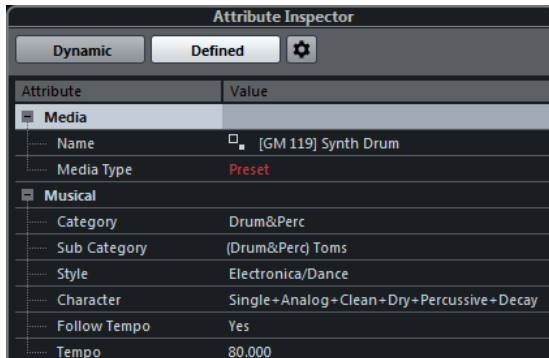

Dynamic

Displays all available values for the selected files.

Defined

Displays a configured set of attributes for the selected media type regardless of whether corresponding values are available for the selected files.

Configure Defined Attributes

Activates the configuration mode, in which you can set up the attributes that are displayed in the **Attribute Inspector**.

Configuration Mode

When you click **Configure Defined Attributes**, the configuration mode is enabled.

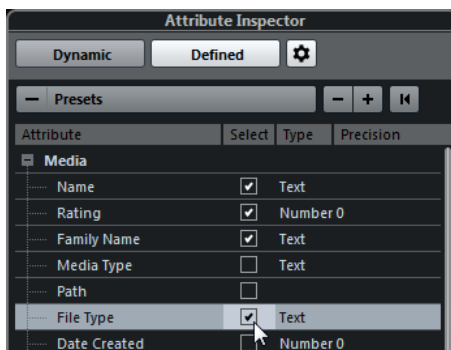

Select Media Types

Allows you to select the media types that are displayed on the **Results** page.

Add User Attribute

Opens the **Add User Attribute** dialog, where you can add custom user attributes. You can select the **Attribute Type** and the **Display Name**.

Reset to Default

Resets the attribute list to the default settings.

Attribute

Shows the attribute name.

Select

Shows whether an attribute is activated or deactivated.

Type

Shows whether the value for an attribute is a number, text, or a Yes/No switch.

Precision

Shows the number of decimals displayed for number attributes.

RELATED LINKS

[Media File Attributes](#) on page 726

[Managing Attribute Lists](#) on page 731

Editing Attributes

The search functions, especially the attribute filter, are a powerful media management tool when making extensive use of tagging, that is, when adding and editing attributes.

Media files are usually organized in complex folder structures to provide a logical way of guiding the user to certain files, with the folder and/or file names indicating the sound, recording location, etc.

Tags help you to find a particular sound or loop in such a folder structure.

Editing Attributes in the Attribute Inspector

In the **Attribute Inspector**, you can edit attribute values of the various media files. Attribute values can be chosen from pop-up lists, entered as text or numbers, or set to Yes or No.

NOTE

- Changing an attribute value in the **Attribute Inspector** permanently changes the corresponding file unless the file is write-protected or part of a VST Sound archive.
- Some attributes cannot be edited. In this case, the file format does not permit changing this value, or changing a particular value makes no sense. For example, you cannot change the file size in the **MediaBay**.

PROCEDURE

1. In the **Results** list, select the file for which you want to make settings.
The corresponding attribute values are displayed in the **Attribute Inspector**.
You can also select several files and make settings for them simultaneously. The only exception is the name attribute, which must be unique for every file.
2. In the **Attribute Inspector**, click in the **Value** column for an attribute.
Depending on the selected attribute, the following happens:
 - For most of the attributes, a pop-up menu opens from which you can choose a value. Some of the pop-up menus also have a **more** entry to open a window with more attribute values.
 - For the **Rating** attribute, you can click in the **Value** column and drag left or right to modify the setting.

- For the **Character** attribute (Musical group), the **Edit Character** dialog opens. To define values, click a radio button on the left or the right side and then click **OK**.
3. Set the attribute value.
To remove the attribute value from the selected files, right-click in the corresponding **Value** column and select **Remove Attribute** from the context menu.
-

Editing Attributes in the Results List

You can edit attributes directly in the **Results** list. This allows you to assign attributes to a number of loop files, for example.

PREREQUISITE

Allow Editing in Results List is activated in the **MediaBay Settings**.

PROCEDURE

1. In the **Results** list, select the files for which you want to make settings.
You can make settings for several files simultaneously, except for the attribute name, which must be unique for every file.
 2. Click in the column for the value that you want to change and make the settings.
-

RELATED LINKS

[MediaBay Settings](#) on page 739

Editing Attributes of Multiple Files Simultaneously

You can edit attributes for multiple files at the same time.

NOTE

If you edit a large number of files simultaneously, the processing of your edits may take some time.

Editing attributes is executed in the background so that you can continue with your work as usual. The **Attribute Counter** in the **MediaBay** toolbar displays how many files are still being updated.

RELATED LINKS

[MediaBay Toolbar](#) on page 709

Editing Attributes of Write-Protected Files

Media files can be write-protected due to a number of reasons: the content could have been provided by someone who write-protected the files, the file format could restrict write operations by the **MediaBay**, etc.

In the **MediaBay**, the write protection status of files is shown as an attribute in the **Attribute Inspector** and in the **Write Protection** column in the **Results** list.

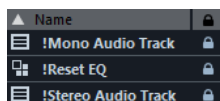

IMPORTANT

You can define attribute values of write-protected files in the **MediaBay**. These changes are only saved in the **MediaBay** database file, they are not saved to disk. This means that if you delete the preferences, these changes are lost.

NOTE

If the **Write Protection** and/or the **Pending Tags** columns are not visible, activate the corresponding attributes for the file type in the **Attribute Inspector**.

- To set or remove the write protection attribute for a file, right-click the file in the **Results** list and select **Set Write Protection/Remove Write Protection**.
This is only possible if the file type allows write operations and if you have the necessary operating system permission.
- When you specify attribute values for a file that is write-protected, this is reflected in the **Pending Tags** column next to the **Write Protection** column in the **Results** list.
If you rescan the **MediaBay** content and a media file on your hard disk has changed since the last scan, the pending tags for this file are lost.
- If a file has pending tags, and you want to write the corresponding attributes to the file, you must remove the write protection, then right-click the file, and select **Write Tags to File**.

NOTE

If you use other programs than Nuendo to change the write-protection status of files, you must rescan the files in the **MediaBay** to reflect these changes.

RELATED LINKS

[Disabling the Preferences](#) on page 1348
[Editing Attributes](#) on page 729

Managing Attribute Lists

In the **Attribute Inspector**, you can define which attributes are displayed in the **Results** list and in the **Attribute Inspector** itself. For different media types, you can configure individual attribute sets.

PROCEDURE

1. In the **Attribute Inspector**, click **Defined**.
2. Click **Configure Defined Attributes** to enter configuration mode.

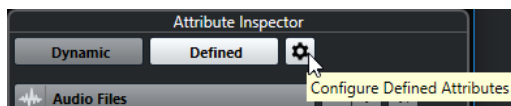

3. Open the **Select Media Types** pop-up menu, activate the media types that you want to display, and click anywhere in the **MediaBay**.
The **Attribute Inspector** now shows a list of all attributes available for these media types.
 - If you have activated more than one media type, your settings affect all selected types. An orange checkmark indicates that the current display settings for an attribute differ for the selected media types.
 - The display settings made for the **Mixed Media Types** option are applied if you select files of different media types in the **Results** list or in the **Attribute Inspector**.
4. Activate the attributes that you want to be displayed.

You can edit several attributes simultaneously.

5. Click **Configure Defined Attributes** again to exit the configuration mode.
-

Defining User Attributes

You can define your own attributes and save these in the **MediaBay** database and the corresponding media files. Nuendo recognizes all user attributes that are included in media files.

PROCEDURE

1. In the **Attribute Inspector**, click **Defined**.
2. Click **Configure Defined Attributes** to enter configuration mode.

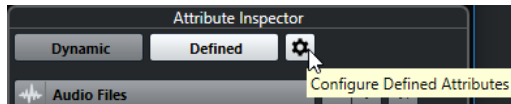

3. Click +.
 4. In the **Add User Attribute** dialog, specify the **Attribute Type** and the **Display Name**.
The display name must be unique in the attribute list. The **Database Name** field indicates if a certain name is valid or not.
 5. Click **OK**.
-

RESULT

The new attribute is added to the list of available attributes and is displayed in the **Attribute Inspector** and the **Results** list.

Working with the MediaBay

When you work with many music files, the **MediaBay** helps you to find and organize your content. After scanning your folders, all found media files of the supported formats are listed in the **Results** section.

You can set up **Favorites**, that is, folders or directories on your system that contain media files. Usually, files are organized in a specific way on your computer. You might have folders reserved for audio content, folders for special effects, folders for combinations of sounds making up the ambience noise that you need for a certain film take, etc. These can all be set as different **Favorites** in the **MediaBay**, allowing you to limit the files available in the **Results** list according to context.

By using the search and filter options, you can narrow down the results.

You can insert the files into your project by using drag and drop, by double-clicking, or by using the context menu options.

Using Media Files

The **MediaBay** window and the **Media** rack in the right zone of the **Project** window offer you multiple possibilities to search for specific files, loops, samples, presets, and patterns that you can use in your project.

Once you have found the media files that you were looking for, you can load them into your project.

Loading Loops and Samples

PROCEDURE

1. Do one of the following:
 - In the **MediaBay**, open the media types selector, click **MIDI Files**, **Audio Files**, or **MIDI Loops**, and select a media file.
 - In the **Media** rack in the right zone, click the **Loops & Samples** tile, and click the following tiles until you can select the media files in the **Results** list.
 2. Do one of the following:
 - Double-click a media file to create a new instrument or an audio track with the loaded file.
 - Drag the media file to a track in the event display.
-

RESULT

The media file is inserted on the new track or at the insert position.

RELATED LINKS

[Show Media Types Selector](#) on page 715

Loading Track Presets

PROCEDURE

1. Do one of the following:
 - In the **MediaBay**, open the media types selector, click **Track Presets**, and select a preset.
 - In the **Media** rack in the right zone, click **Presets > Track Presets**, and click the following tiles until you can select the preset in the **Results** list.
 2. Do one of the following:
 - Double-click the track preset to create a new track with the loaded preset.
 - Drag the track preset to a track to apply the preset to the track.
-

RESULT

The preset is applied to the track, and all settings of the preset are loaded.

RELATED LINKS

[Show Media Types Selector](#) on page 715

Loading Instrument Presets

PROCEDURE

1. Do one of the following:
 - In the **MediaBay**, open the media types selector, click **Plug-in Presets**, and select a preset for an instrument plug-in.
 - In the **Media** rack in the right zone, click the **VST Instruments** tile, and click the following tiles until you can select the preset in the **Results** list.
2. Do one of the following:
 - Double-click the instrument preset to create a new instrument track with the loaded instrument preset.

- Drag the instrument preset to the track list to create a new instrument track with the loaded instrument preset.
 - Drag the instrument preset to the event display to create a new instrument track with the loaded instrument preset.
 - Drag the instrument preset to an instrument track to apply the preset to the track.
-

RESULT

The instrument is loaded as a track instrument, and the preset is applied to the instrument track.

RELATED LINKS

[Adding VST Instruments to Projects](#) on page 705

[Show Media Types Selector](#) on page 715

Loading Effect Plug-In Presets

PROCEDURE

1. Do one of the following:
 - In the **MediaBay**, open the media types selector, click **Plug-in Presets**, and select a preset.
 - In the **Media** rack in the right zone, click **Presets > VST FX Presets**, and click the following tiles until you can select the preset in the **Results** list.
 2. Do one of the following:
 - Drag the plug-in preset to an audio track or its **Inserts** section in the **Inspector**.
 - Drag the plug-in preset to an empty area of the track list.
-

RESULT

If you dragged the plug-in preset to an audio track, the first free insert slots are filled with the corresponding plug-in. If there are no more free slots available, a warning is shown.

If you dragged the plug-in preset to an empty area of the track list, a new FX channel track is created and the first insert slots of this new track are filled.

RELATED LINKS

[Show Media Types Selector](#) on page 715

[Adding VST Effects to Projects](#) on page 705

Loading FX Chain Presets

PROCEDURE

1. Do one of the following:
 - In the **MediaBay**, open the media types selector, click **FX Chain Presets**, and select a preset.
 - In the **Media** rack in the right zone, click **Presets > FX Chain Presets**, and click the following tiles until you can select the preset in the **Results** list.
 2. In the **Project** window, select an audio track.
 3. Drag the preset from the **MediaBay** or **Media** rack and drop it on the open **Inserts** section of the **Inspector**.
-

RESULT

The **FX Chain Preset** is applied to the track, and all settings of the preset are loaded. Any inserts that have previously been loaded are overwritten.

RELATED LINKS

[Show Media Types Selector](#) on page 715

Loading Strip Presets

PROCEDURE

1. Do one of the following:
 - In the **MediaBay**, open the media types selector, click **Strip Presets**, and select a preset.
 - In the **Media** rack in the right zone, click **Presets > Strip Presets**, and click the following tiles until you can select the preset in the **Results** list.
 2. In the **Project** window, select an audio track.
 3. Drag the preset from the **MediaBay** or **Media** rack and drop it on the open **Strip** section of the **Inspector**.
-

RESULT

The strip preset is applied to the track, and all settings of the preset are loaded.

RELATED LINKS

[Show Media Types Selector](#) on page 715
[Saving/Loading Strip Presets](#) on page 452

Loading Pattern Banks

PROCEDURE

1. Do one of the following:
 - In the **MediaBay**, open the media types selector, click **Pattern Banks**, and select a preset.
 - In the **Media** rack in the right zone, click **Presets > Pattern Banks**, and click the following tiles until you can select the preset in the **Results** list.
 2. Do one of the following:
 - Double-click the pattern bank to create a new instrument track with the loaded preset.
 - Drag the pattern bank and drop it on an instrument track to apply the pattern bank to the track.
 - Drag the pattern bank and drop it on the track list to create a new instrument track with the loaded pattern bank.
-

RESULT

Groove Agent is loaded as a track instrument. A drum map is loaded for the instrument track, and an instance of the **Beat Designer** is loaded as an insert effect.

RELATED LINKS

[Show Media Types Selector](#) on page 715

MediaBay Aspects

You can create configurations of the **MediaBay** window and save them as aspects. These can be recalled via the **Media** menu.

This is helpful if you only want to work with certain sound effect files that reside in a particular location, for example. Every item in the **MediaBay** that can be configured can be part of a **MediaBay** aspect. You can specify which sections are visible, which media types are browsed for, which locations are being scanned, and so on. You can also enter a search string and save it with the aspect.

Creating a New Aspect

PROCEDURE

1. Select **Media > MediaBay Aspects > New Aspect**.
 2. In the **Add MediaBay Aspect** dialog, enter the name for the new aspect and click **OK**.
The new **MediaBay** aspect window opens.
 3. Configure the **MediaBay** window to your liking.
-

RESULT

The **MediaBay** aspect is automatically saved when you close the window or the program. Once the aspect is created, you can access it via the **Media** menu.

Creating a New Aspect Based on an Existing Aspect

You can create a new **MediaBay** aspect that is based on an existing aspect.

PROCEDURE

1. Select **Media > MediaBay Aspects > Duplicate Aspect** and select the aspect that you want to duplicate.
 2. In the **Add MediaBay Aspect** dialog, enter the name for the new aspect and click **OK**.
The new **MediaBay** aspect window opens.
 3. Configure the **MediaBay** window to your liking.
-

RESULT

The **MediaBay** aspect is automatically saved when you close the window or the program. Once the aspect is created, you can access it via the **Media** menu.

Removing MediaBay Aspects

PROCEDURE

- Select **Media > MediaBay Aspects > Remove Aspect**.
-

Working with Volume Databases

Nuendo saves all media file information that is used in the **MediaBay**, such as paths and attributes, in a local database file on your computer. However, in some cases, it might be necessary to browse and manage this kind of metadata on an external volume.

For example, a sound editor might have to work both at home and in a studio, on two different computers. Therefore, the sound effects are stored on an external storage medium. To be able to

connect the external device and directly browse its contents in the **MediaBay** without having to scan the device, you have to create a volume database for the external device.

Volume databases can be created for your computer drives or for external storage media. They contain the same kind of information about the media files on these drives as the regular **MediaBay** database.

NOTE

When you launch Nuendo, all available volume databases are automatically mounted. Databases that are made available while the program is running have to be mounted manually.

Rescanning Volume Databases

If you have modified the data on your external volume on a different system, you must rescan the **MediaBay**.

RELATED LINKS

[Refresh Views](#) on page 713

Creating Volume Databases

PROCEDURE

- In the **File Browser** section, right-click the external storage medium, drive, or partition of your computer system for which you want to create a database, and select **Create Volume Database**.

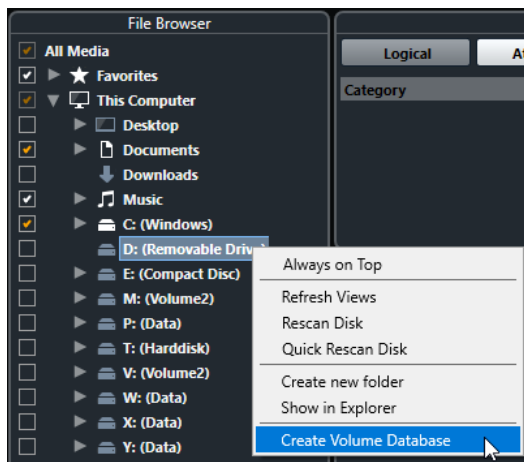

IMPORTANT

You must select the topmost directory level for this. You cannot create a database file for a lower-level folder.

NOTE

If you create a volume database on a network drive, multiple users can access it. However, this can lead to write conflicts as only one user can write to the database at a time.

RESULT

The file information for this drive is written into a new database file. Volume databases are indicated by the symbol  to the left of the drive name.

NOTE

If the drive contains a large amount of data, this process may take some time.

Volume databases are automatically mounted when Nuendo is launched. They are shown in the **File Browser** section and their data can be viewed and edited in the **Results** list.

RELATED LINKS

[Locked Volume Databases on Network Drives](#) on page 738

Locked Volume Databases on Network Drives

You can unlock volume databases on network drives. This can be necessary, if the system of another user who also used the volume database on the network drive crashed or was not properly disconnected. In this case, Nuendo creates a file in a hidden folder that indicates that the database is still in use.

If this happens, you get a warning message when you launch the program. It shows the name of the user or system.

Do one of the following:

- Ask the other user to restart Nuendo so that the lock is automatically released.
- If you cannot get hold of the other user, and you do not need to access the database, click **Ignore Database**.
- If you cannot get hold of the other user, and you want to use the database, click **Force unlock** to remove the lock.

Removing Volume Databases

If you have worked on another computer using an external hard disk and return to your own computer and connect the external device again as part of your system setup, you no longer need a separate volume database for it. Any data on this drive can be included in the local database file again, by removing the extra database file.

PROCEDURE

- In the **File Browser** section, right-click the volume database and select **Remove Volume Database**.
-

RESULT

The metadata is integrated in the local **MediaBay** database file, and the volume database file is deleted.

NOTE

If the drive contains a large amount of data, this process may take some time.

Mounting and Unmounting Volume Databases

Volume databases that are made available while Nuendo is running must be mounted manually.

- To mount a volume database manually, right-click the external storage medium, drive, or partition of your computer system that you want to mount and select **Mount Volume Database**.
- To unmount a volume database, right-click it and select **Unmount Volume Database**.

MediaBay Settings

- To open a pane with settings for the **MediaBay**, click **MediaBay Settings**.

The following options are available:

Hide Folders That Are Not Scanned

Hides all folders that are not scanned for files. This keeps the tree view in the **File Browser** less cluttered.

Show Only Selected Folder

Shows only the selected folder and its subfolders.

Scan Folders Only When MediaBay Is Open

Scans folders for media files when the **MediaBay** window is open.

If this option is deactivated, the folders are scanned in the background even when the **MediaBay** window is closed. However, Nuendo never scans folders while playing back or recording.

Maximum Items in Results List

Allows you to specify the maximum number of files that are displayed in the **Results** list. This avoids unmanageably long lists of files.

NOTE

The **MediaBay** does not warn you if the maximum number of files has been reached. There might be situations where a certain file cannot be found because the maximum number of files was reached.

Allow Editing in Results List

Allows you to edit attributes in the **Results** list. If this option is deactivated, attributes can only be edited in the **Attribute Inspector**.

Show File Extensions in Results List

Shows file name extensions in the **Results** list.

Scan Unknown File Types

When scanning for media files, the **MediaBay** ignores files with an unknown file extension. If this option is activated, the **MediaBay** tries to open and scan any file in the search location and ignores those files that cannot be recognized.

Surround Sound

Nuendo provides integrated surround sound features with support for several formats. All audio-related channels and busses can handle multi-channel speaker configurations. A channel in the **MixConsole** can contain either complete surround mixes or an individual speaker channel which is part of a surround setup.

Nuendo offers the following surround-related features:

- You can route audio-related tracks, that is, audio, instrument, and sampler tracks, to surround channels.
- The **VST MultiPanner** plug-in is automatically applied to audio-related tracks with a supported surround configuration, and to output channels with any kind of multi-channel configuration other than stereo. The **VST MultiPanner** plug-in is available in the **Inspector** and **MixConsole** and can be used to position channels in the surround field.
- You can create complete mixes with object-based audio content for Dolby Atmos® without additional software or hardware, and create fully compliant ADM Broadcast Wave files for playback through a Dolby Atmos Renderer.
- Nuendo supports the recording, playback, and mixing of object-based live ADM productions in OSC format, and allows for live position tracking when working within an OSC network environment.
- For virtual reality (VR) or augmented reality (AR) productions, you can create mixes in first-order, second-order, and third-order Ambisonics format. Nuendo allows you to monitor Ambisonics mixes on headphones or loudspeaker systems, and supports VR controllers and head-mounted displays when working with 360° video.
- Third-party panner plug-ins are supported.
- The ISONO **Anymix Pro** plug-in can be used as an alternative to the default surround panner, the **VST MultiPanner**. For detailed information about **Anymix Pro**, see the separate document **Plug-in Reference**.
- The **MixConvert V6** plug-in is used to convert a surround channel into a different format if the corresponding input/output configuration is not handled by **VST MultiPanner**. Nuendo places **MixConvert V6** automatically where needed.
- Plug-ins with multi-channel support specifically designed for surround sound mixing tasks are supported, for example, the **Mix6to2** plug-in. Furthermore, any VST 3 plug-in features multi-channel support and can therefore be used in a surround configuration, even if it was not specifically designed for surround. For detailed information about all included plug-ins, see the separate document **Plug-in Reference**.
- You can export surround mixes in different formats using the **Export Audio Mixdown** function.

RELATED LINKS

[Preparations for Creating Surround Mixes](#) on page 744

[VST MultiPanner](#) on page 747

[Object Audio in Nuendo](#) on page 769

[Authoring and Mixing for Dolby Atmos](#) on page 770

[Authoring and Mixing Object-Based Productions Using Open Sound Control \(OSC\)](#) on page 788

[Ambisonics Mixes](#) on page 792

[Switching the Channel Panner](#) on page 764

[MixConvert V6](#) on page 764

[Insert Effects in Multi-Channel Configurations](#) on page 509

[Surround Mix Export](#) on page 769

Deliverables

A surround mix in Nuendo can be sent as multi-channel audio from the surround output bus to a recorder, or can be exported to audio files on your hard disk.

Exported surround mixes can either be split to one mono file per speaker channel, or interleaved to a single file containing all the surround channels.

RELATED LINKS

[Export Audio Mixdown](#) on page 1162

Available Surround Channel Configurations

Nuendo supports several 2D and 3D surround channel configurations.

The following surround channel configurations are supported:

LRC

This format uses the channels left, right, and center.

Quadro

This is the original quadraphonic format for music, with one speaker in each corner. This format was intended for vinyl record players.

5.1

This format, also referred to as Dolby Digital, AC-3, DTS, and MPEG-2 Multichannel, uses the front channels left, center, and right, the surround channels left and right, and an additional LFE (Low Frequency Effects) channel.

The center channel is mainly used for speech, the front and surround channels left and right for music and sound effects, and the LFE channel for boosting low-frequency content.

7.1

This format, also referred to as 7.1 Music (Dolby), uses the front channels left, center, and right, the side channels left and right, the surround channels left and right, and an LFE channel.

7.0.2

This is the same format as 7.1.2 but without an LFE channel.

7.1.2

This format, also referred to as 9.1, is used for channel-based beds in 3D Dolby Atmos[®] mixes. In addition to the front channels left, center, and right, the side channels left and right, the surround channels left and right, and an LFE channel, the 7.1.2 Dolby Atmos speaker setup provides top channels left and right.

7.1.4

This format is used for 3D mixes. In addition to the front channels left, center, and right, the side channels left and right, the surround channels left and right, and an LFE channel, this speaker setup provides top front channels left and right and top back channels left and right.

7.1.6

This format is used for 3D mixes. In addition to the front channels left, center, and right, the side channels left and right, the surround channels left and right, and an

LFE channel, this speaker setup provides top front channels left and right, top side channels left and right, and top back channels left and right.

5.0

This format uses the front channels left, center, and right, and the surround channels left and right.

7.1 SDDS

This format uses the front channels left, left center, center, right center, and right, the surround channels left and right, and an LFE channel. This arrangement is used in the Sony Dynamic Digital Sound (SDDS) format.

7.0 SDDS

This format uses the front channels left, left center, center, right center, and right, and the surround channels left and right. This arrangement is used in the Sony Dynamic Digital Sound (SDDS) format.

7.0

This format uses the front channels left, center, and right, the surround channels left and right, and the side channels left and right.

7.1 Proximity

This format uses the front channels left, center, and right, the surround channels left and right, an LFE channel, and additional Proximity channels left and right.

NOTE

For detailed information about the Proximity format, see the chapter “Anymix Pro” in the separate document **Plug-in Reference**.

6.0 Cine

This format uses the front channels left, center, and right, and the surround channels left, center, and right.

6.0 Music

This format uses the front channels left and right, the surround channels left and right, and the side channels left and right.

6.1 Cine

This is the same format as 6.0 Cine but with an LFE channel added. This channel configuration is used in the Dolby Digital EX and DTS-ES formats.

6.1 Music

This is the same format as 6.0 Music but including an LFE channel.

5.0.4

This format is used for 3D mixes. In addition to the front channels left, center, and right, and the surround channels left and right, this speaker setup provides top front channels left and right and top back channels left and right.

5.1.4

This format is used for 3D mixes. In addition to the front channels left, center, and right, the surround channels left and right, and an LFE channel, this speaker setup provides top front channels left and right and top back channels left and right.

9.1.4

This is the same format as 7.1.4 but with additional left and right center channels.

9.1.6

This is the same format as 7.1.6 but with additional left and right center channels.

10.0 to 13.1 Auro-3D

The Auro-3D formats are surround formats, in which the channels are arranged on 2 or 3 levels, thereby creating a 3D effect. The Auro formats are available with and without LFE channels.

22.2

This format allows for creating 3D mixes for ultra-high-definition television formats. It uses 22 channels arranged in 3 layers (9 upper layer channels, 10 middle layer channels, 3 lower layer channels) plus 2 LFE channels.

1st Order Ambisonics/2nd Order Ambisonics/3rd Order Ambisonics

These 3D formats allow for creating a spherical sound field. They use an encoded bundle of audio signals to position sound sources at any place in the sound sphere. The available Ambisonics formats differ in the number of audio signals that are used. Higher-order Ambisonics provide more signals and allow for a higher precision of positioning.

LRCS

This format uses the channels left, right, center, and surround. The surround channel is center-rear positioned. This is the original surround format that first appeared as Dolby Stereo in cinema and later as the home cinema format Dolby ProLogic.

LRCS+LFE

This is the same format as LRCS but with an additional LFE channel.

Quadro+LFE

This is the same format as Quadro but with an additional LFE channel.

LRS

This format uses the channels left, right, and surround. The surround channel is positioned at center-rear.

LRC+LFE

This is the same format as LRC but with an additional LFE channel.

LRS+LFE

This is the same format as LRS but with an additional LFE channel.

8.0 Cine

This is the same format as 7.0 Cine but including a center surround channel.

8.0 Music

This is the same format as 7.0 Music but including a center surround channel.

8.1 Cine

This is the same format as 8.0 Cine but including an LFE channel.

8.1 Music

This is the same format as 8.0 Music but including an LFE channel.

9.0 Cine

This is the same format as 7.0 Cine but with additional left and right side channels.

9.1 Cine

This is the same format as 7.1 Cine but with additional left and right side channels.

10.0 Cine

This is the same format as 9.0 Cine but with an additional center surround channel.

10.1 Cine

This is the same format as 9.1 Cine but with an additional center surround channel.

10.2 Experimental

This is an experimental format with 10 surrounding speakers and 2 LFE channels (2 combined 5.1 setups, 1 at the top and 1 at the bottom of the room).

IMPORTANT

In Nuendo, the order of surround channels and side channels follows the specification of Microsoft Inc. To meet the Dolby specification for side surround channels and surround rear channels, swap the device ports of surround channels and side channels.

RELATED LINKS

[Authoring and Mixing for Dolby Atmos](#) on page 770

[Ambisonics Mixes](#) on page 792

Preparations for Creating Surround Mixes

You must prepare Nuendo for surround sound by defining input and output busses in a surround format and specifying which audio inputs and outputs are used for the different channels in the busses.

Output Bus Configuration

Before you can start working with surround sound, you must configure a surround output bus through which all the speaker channels of the selected surround format are routed.



Output bus in 5.1 channel configuration

RELATED LINKS

[Adding Input and Output Busses](#) on page 35

Child Busses

Child busses allow you to route tracks to particular channels within a surround bus. Creating stereo busses within your surround bus allows you to route stereo tracks directly to a pair of stereo speakers. You can also add child busses in other surround formats with fewer channels than the parent bus.

- Once you have created a surround bus, you can add one or several child busses to it by right-clicking the bus and selecting **Add Child Bus**.

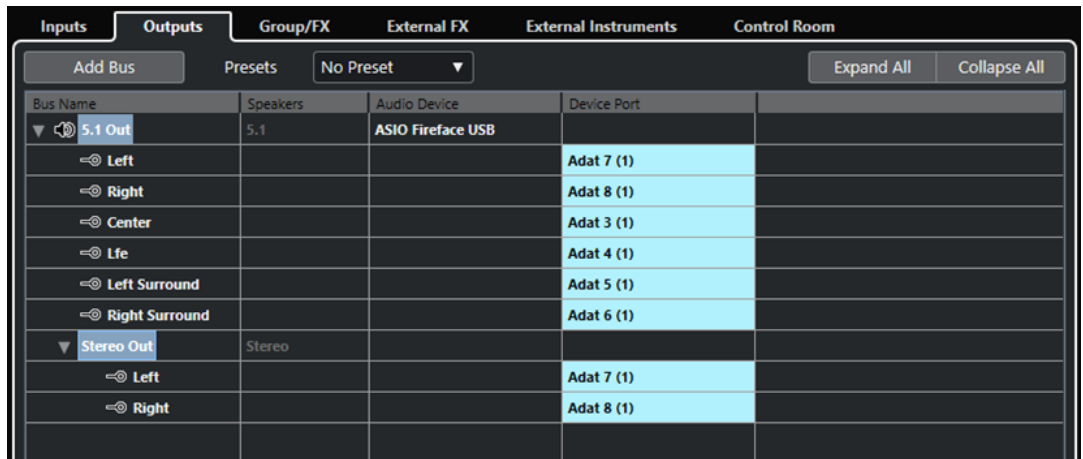

Output bus in 5.1 channel configuration with stereo child bus

RELATED LINKS

[Adding Child Busses](#) on page 35

Surround Routing

The processing format of **VST MultiPanner** depends on the channel routing. You can use the **Routing** and the **Direct Routing** racks in the **MixConsole** to route audio-related tracks to output busses or group channels with a surround configuration.



For example, if a mono source channel is routed to a 5.1 bus, the panner works in 5.1 mode. For channel-based 3D mixing, the source channel must be routed to an output bus that provides top channel speakers.

RELATED LINKS

[VST MultiPanner](#) on page 747

[Routing](#) on page 437

[Setting up Direct Routing](#) on page 454

[Setup for Dolby Atmos Mixes](#) on page 771

[Object Busses](#) on page 778

[Channel Routing for Ambisonics Mixes](#) on page 793

Routing Channels to Individual Surround Channels

If you want to place an audio source in one separate speaker channel, you can route it directly to that speaker channel. This is useful for premixed material or multi-channel recordings that do not require panning.

- To route a channel to an individual surround channel, select the corresponding output bus of that speaker channel in the **Routing** rack.

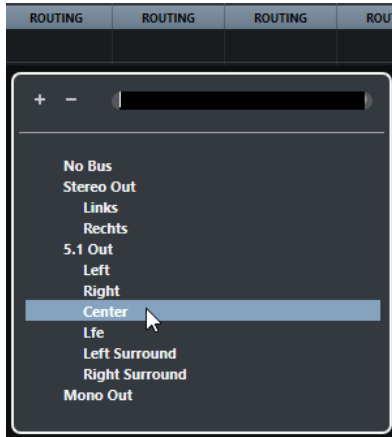

NOTE

If a stereo audio channel is routed directly to a speaker channel, the left and the right channels are mixed to mono. The pan control for the audio channel determines the balance between the left and the right channel in the resulting mono mix. Center pan produces a mix of equal proportion.

Routing Channels to Child Busses

If you add a child bus within a surround bus, it appears as a subentry of the surround bus on the routing selector. Select this option to route a stereo audio channel directly to that stereo speaker pair of the surround bus, for example, to route a music track directly to the left and right front speakers in a surround channel.

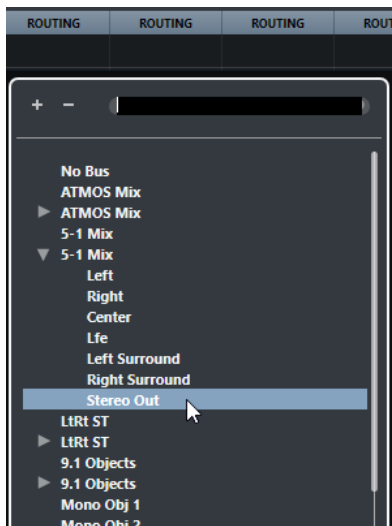

RELATED LINKS

[Child Busses](#) on page 744

Input Bus Configuration

In most cases you do not need to configure a surround format input bus in order to work with surround sound in Nuendo. You can record audio files via standard inputs, and easily route the resulting audio channels to surround outputs at any stage. You can also directly import multi-channel files of a specific surround format to audio tracks of the same format.

However, you must add a surround input bus in the following cases:

- You have existing audio material in a specific surround format, and you want to transfer this material to Nuendo as a single, multi-channel file.
- You want to make a live recording with a surround setup.
- You have prepared surround premixes, for example, stems, that you want to record on a new audio track with a surround configuration.

RELATED LINKS

[Audio File Import](#) on page 311

[Adding Input and Output Busses](#) on page 35

VST MultiPanner

The **VST MultiPanner** plug-in allows you to position a sound source in the surround field or to modify existing premixes. The plug-in distributes the incoming audio in various proportions to the output surround channels.

In the pan area, the sound sources are shown as blue panning handles. In stereo or multi-channel configurations, the left and right front channels are shown as a yellow and a red handle. You can position the sound sources within the room by dragging the panning handles.

To perform rotating movements that you cannot achieve by dragging, you can use the rotation and orbit controls below the pan area. To adjust the size of the sound source, use the controls for distributing the signal to the different speaker channels and for advanced scaling.

For 3D channel configurations, object-based audio, and Ambisonics audio, **VST MultiPanner** offers additional settings and an additional 3D pan area.

NOTE

Whether you can use **VST MultiPanner** for a specific input/output configuration depends on whether this configuration can be mapped by the panner.

RELATED LINKS

[VST MultiPanner Plug-in Panel](#) on page 748

[Position of the Sound Source](#) on page 755

[VST MultiPanner Plug-in Panel for 3D Channel Configurations](#) on page 751

[VST MultiPanner Plug-in Panel in Object Mode](#) on page 787

[VST MultiPanner Plug-in Panel in Ambisonics Mode](#) on page 794

[MixConvert V6](#) on page 764

Constant Power Panning

The **VST MultiPanner** plug-in uses constant power panning laws. This means that the power of a source channel is identical to the power of the corresponding output signal.

Constant power laws ensure that the overall volume as perceived by the listener is always the same, regardless of the signal panning. This allows you to move the sound source in the pan

area, disable specific speaker channels, or use the divergence controls without experiencing any volume changes.

RELATED LINKS

[VST MultiPanner Plug-in Panel](#) on page 748

VST MultiPanner Plug-in Panel

The **VST MultiPanner** plug-in panel allows you to position any supported mono, stereo, or multi-channel sound source.

- To open the **VST MultiPanner** plug-in panel in a separate window, double-click a miniature view of **VST MultiPanner** in the **Inspector** or the **MixConsole**.



The following settings and options are available:

Show/Hide Extended Display

Shows/Hides additional settings and the **Rear View** pan area for 3D channel configurations.

Bed Mode

Sets the panner to bed mode. This mode allows you to create the channel-based bed mix.

Object Mode

Sets the panner to object mode. This mode allows you to create mixes for object-based content, for example, in Dolby Atmos format.

NOTE

If VST MultiPanner is used as an insert plug-in, **Object Mode** is not available.

Movement restriction buttons

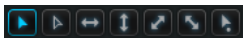

Allow you to restrict the movement to one axis when moving the sound source with the mouse.

NOTE

- The movement restrictions only affect the graphic presentation in the two pan areas. This means, activating **Vertical Movements Only** allows movements only on the y-axis in the **Top View** area, and movements only on the z-axis in the **Rear View** area.
 - The movement restriction buttons do not affect the controls in the positioning section below the pan area.
-

Reset Parameters

Alt/Opt-click this button to reset all panner parameters to their default values.

Input level meter

Shows the input level for all speaker channels. The numeric values above the meters indicate the peak levels registered for the channels.

Position Left/Right Channels Independently

Activate this option to adjust the front left and right input channels independently by dragging.

Top View

Shows the room from the top and allows you to position the sound source by dragging the panning handles.

To zoom out of the pan area, activate **Overview Mode**.

Speaker channel buttons

The speaker buttons around the pan area represent the output configuration. The buttons allow you to solo, mute, and disable the corresponding channels.

NOTE

You cannot automate the soloing of output channels.

Output level meter

Shows the output level for all speaker channels. The numeric values above the meters indicate the peak levels registered for the channels.

Left-Right Pan

Sets the position of the signal on the x-axis.

Rear-Front Pan

Sets the position of the signal on the y-axis.

Rotate Signal around Z-Axis

Rotates the sound source around its positioning handle. This option is only available for stereo and multi-channel signals.

Orbit Center

Rotates the sound source including all input channels and the positioning handle signal around the center of the room.

Click **Counter Shot** to rotate the sound source by exactly 180 degrees.

Radius

Sets the distance of the sound source from the center of the room when using **Orbit Center**.

Center Distribution

Distributes part or all of the center signal to the left and right front speakers.

NOTE

If **Front Divergence** is set to 100 %, **Center Distribution** has no effect.

Front Divergence

Determines the attenuation curve that is used when positioning the sound source on the front x-axis.

Front/Rear Divergence

Determines the attenuation curve that is used when positioning the sound source on the y-axis.

Rear Divergence

Determines the attenuation curve that is used when positioning the sound source on the rear x-axis.

Signal Width

Sets the expansion of the sound source on the x-axis. This parameter is only available for channels with stereo or multi-channel output configurations.

Signal Depth

Sets the expansion of the sound source on the y-axis. This parameter is only available for channels with multi-channel output configurations.

LFE Level

Sets the signal amount that is sent to the LFE (Low Frequency Effects) channel.

- If the selected input already contains an LFE channel (x.1 configuration), it is routed through **VST MultiPanner**, and **LFE Level** is used to control the volume of this channel.
- If the selected input does not contain an LFE channel (x.0 configuration), all input channels are distributed evenly to the output LFE channel. In this case, it might be useful to raise the volume of this downmix using **LFE Level**.

NOTE

The LFE channel is used as a full-range channel, no low-pass filtering is applied.

RELATED LINKS

[Movement Restriction Modes](#) on page 756

[Overview Mode](#) on page 758

[Soloed, Muted, and Disabled Speaker Channels](#) on page 762

[Pan Controls](#) on page 758

[Rotate and Tilt Controls](#) on page 759

[Orbit Controls](#) on page 759

[Center Distribution Control](#) on page 760

[Divergence Controls](#) on page 760

[Scale Controls](#) on page 761

[VST MultiPanner Plug-in Panel for 3D Channel Configurations](#) on page 751

[VST MultiPanner Plug-in Panel in Object Mode](#) on page 787

[VST MultiPanner Plug-in Panel in Ambisonics Mode](#) on page 794

VST MultiPanner Plug-in Panel for 3D Channel Configurations

The **VST MultiPanner** plug-in panel offers additional settings and a 3D pan area for channels that are routed to an output bus or group channel with a 3D channel configuration such as 7.1.2 Dolby Atmos.

NOTE

The processing mode of the panner is determined by the routing of the audio channels. If an audio channel is routed to a 7.1.2 output bus or group channel, the panner operates in 7.1.2 bed mode. If the channel is routed to an output bus or group channel in 2D channel configuration, the 3D panning functions are disabled.

- To open the **VST MultiPanner** plug-in panel in a separate window, double-click a miniature view of **VST MultiPanner** in the **Inspector** or the **MixConsole**.



- To show/hide the additional settings and the 3D pan area, click **Show/Hide Extended Display** .

Elevation Pattern buttons



Allow you to activate/deactivate predefined elevation patterns for the height parameter.

If no elevation pattern is active, you can adjust **Bottom-Top Pan** manually.

Top View

Shows the room from the top. The position on the z-axis is represented by the size of the panning handles: the bigger the panning handle, the higher the sound source is positioned in the room. To adjust the position on the z-axis, middle-click and drag.

Rear View

Shows the room from the rear and allows you to position the sound source on the x-axis and z-axis by dragging the panning handles. The position on the y-axis is represented by the size of the panning handles: the bigger the panning handle, the nearer the sound source is positioned to the rear of the room. To adjust the position on the y-axis, middle-click and drag.

Bottom-Top Pan

Sets the position of the signal on the z-axis. If you move this control all the way to the right, the sound comes from the top speakers only.

Elevation On/Off

Activates/Deactivates the height parameter.

NOTE

If elevation is deactivated, **Bottom-Top Pan** is set to bottom, even if automation for bottom-top panning is present. **Elevation On/Off** can also be automated.

Tilt Signal around Y-Axis

Tilts the sound source around its own y-axis. This option is only available for stereo and multi-channel signals.

Tilt Signal around X-Axis

Tilts the sound source around its own x-axis. This option is only available for stereo and multi-channel signals.

Height Divergence

Determines the attenuation curve that is used when positioning sound sources on the z-axis.

RELATED LINKS

[VST MultiPanner Plug-in Panel](#) on page 748

[Authoring and Mixing for Dolby Atmos](#) on page 770

[Elevation Patterns for 3D Mixing](#) on page 761

[Pan Laws for 3D Mixing](#) on page 762

[Divergence Controls](#) on page 760

Miniature Views

In the **MixConsole**, in the **Channel Settings** window, and in the **Inspector**, miniature views of **VST MultiPanner** allow basic panning operations.

While you must open the plug-in panel to access all of the panner features, you can perform basic panning operations also in the following areas:

- In the **MixConsole** and in the **Channel Settings** window, a miniature view of the panner is displayed at the top of the fader section.



- In the **Inspector**, a miniature view of the panner is displayed in the **Surround Pan** section.

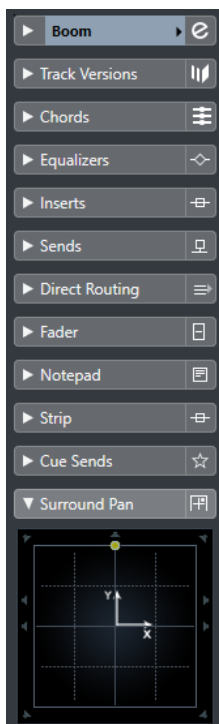

In the miniature views, the following applies:

- To move the signal source in the surround field, click and drag.
- To adjust the position of the panning handles on the z-axis, middle-click and drag.
- In the **Inspector** miniature view, you can also solo, mute, and disable channels.

NOTE

In all miniature panner views, you can hold **Shift** while moving the sound source to allow for more accurate positioning.

RELATED LINKS

[Soloed, Muted, and Disabled Speaker Channels](#) on page 762

[Movement Restriction Modes](#) on page 756

Pinned Panner Window

When you pin the panner window, you can select individual channels and display their panning settings in that window.

- To show the **VST MultiPanner**, the **Standard Panner**, or the **MixConvert V6** plug-in panel of the selected channel or bus in one single instance of the panner window, activate **Pinned window follows VST channel selection** at the top of the panner plug-in panel.

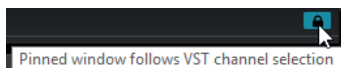

If **Pinned window follows VST channel selection** is activated, the following applies:

- If you select a channel for which no panner view is available, the pinned window continues to show the last available panner view. In this case the panner view is not consistent with the selected channel.
- You can still open additional panner windows by double-clicking the corresponding miniature panner view in the **MixConsole**, in the **Channel Settings** window, or in the **Inspector**.

NOTE

You can only open one panner instance for each channel.

RELATED LINKS

[Miniature Views](#) on page 752

General Plug-in Controls

Bypass Effect

Bypass Effect  at the top of the plug-in panel allows you to bypass **VST MultiPanner**.

The following applies:

- If the input and output configurations are identical, the input signals are directly routed to the output channels.
- If the input and output configurations differ, the panner attempts to route the input signals to the appropriate output channels. For example, if you pan a stereo signal to a 5.1 configuration, the left and right front speakers are used.

NOTE

If you use **VST MultiPanner** as an insert effect, the **Bypass Effect** button works in the same way it does for audio plug-ins.



Mute/Solo

Mute  and **Solo**  at the top of the plug-in panel are identical to the corresponding channel controls.

IMPORTANT

These buttons are not available if **VST MultiPanner** is used as an insert effect.

Read/Write

Read  and **Write**  at the top of the **VST MultiPanner** window allow you to apply and record automation data. If the panner is used on an output channel, these buttons are identical to the corresponding channel controls. If used as an insert effect, automation data for this insert is written separately.

RELATED LINKS

[Bypassing Insert Effects](#) on page 508

[Using Solo and Mute](#) on page 432

[Automation Parameters in the VST MultiPanner](#) on page 755

Automation Parameters in the VST MultiPanner

Most of the parameters in the **VST MultiPanner** plug-in can be automated just like any other channel or insert parameter.

Recording automation for the orbit controls and the independent positioning mode, however, is handled differently. Automation data for these parameters is written as a combination of the front-rear panning, left-right panning, and the **Rotate Signal** parameters. For the independent positioning mode, scaling is added. Therefore, modifying existing automation data is quite troublesome, since it involves changing many different parameters. If an automation pass does not meet your expectations, we recommend to start from scratch.

RELATED LINKS

[Orbit Controls](#) on page 759

[Movement Restriction Modes](#) on page 756

[Writing Automation Data](#) on page 806

Position of the Sound Source

The pan area of the **VST MultiPanner** plug-in shows you the position of the sound source and allows you to move it.

In the pan area, the virtual position of the sound source is shown as a circle. The left and right front channels are shown in yellow and red. All other input channels are shown in blue.

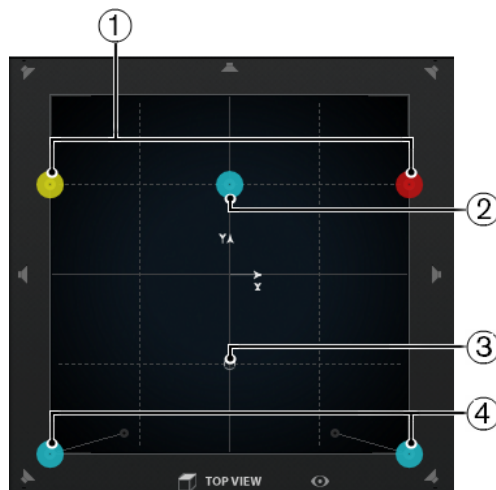

The pan area showing a 5.1 sound source

- 1 Left and right front channels
- 2 Center channel
- 3 The virtual position of the sound source
- 4 Left and right rear channels

You can position the sound source anywhere inside the room and even move it out of the pan area. This can be useful for extreme panning positions, such as panning all channels hard right. To show the position outside the pan area, activate **Overview Mode**.

NOTE

If you work with mono channels, the sound source corresponds to the mono channel.

RELATED LINKS

[Positioning a Sound Source in the Pan Area](#) on page 756

[Overview Mode](#) on page 758

Positioning a Sound Source in the Pan Area

The pan area of the **VST MultiPanner** plug-in allows you to use the mouse for positioning the sound source.

PROCEDURE

- To position the sound source, do one of the following:
 - Click at the exact position where you want the sound source to be placed.
 - Click and drag the positioning handle to the exact position where you want the sound source to be placed.
-

RELATED LINKS

[Position of the Sound Source](#) on page 755

[Movement Restriction Modes](#) on page 756

Movement Restriction Modes

VST MultiPanner allows you to restrict the movement within the pan area. This way, you can move the sound source along a specific axis, for example, from bottom left to top right.

The following positioning modes and modifier keys are available:

Standard Positioning Mode



Mouse movements are not restricted.

Fine-Scaled Positioning Mode



Mouse movements are scaled to allow very fine movements. This is useful when panning in one of the miniature displays, for example.

Modifier key: **Shift**

Horizontal Movements Only



Mouse movements are restricted to horizontal.

Modifier key: **Ctrl/Cmd**

Vertical Movements Only



Mouse movements are restricted to vertical.

Modifier key: **Ctrl/Cmd - Shift**

Diagonal Movements - Bottom Left to Top Right



Mouse movements are restricted to diagonal from bottom left to top right.

Modifier key: **Alt/Opt**

Diagonal Movements - Bottom Right to Top Left



Mouse movements are restricted to diagonal from bottom right to top left.

Modifier key: **Alt/Opt - Shift**

Jump to Positioning Handle



In this mode, the mouse pointer jumps immediately to the positioning handle, even if it is located outside the pan area.

Modifier key: **Ctrl/Cmd - Alt/Opt - Shift**

NOTE

If **Position Left/Right Channels Independently** is activated, clicking anywhere in the pan area always moves the mouse pointer to the closest panning handle.

Position Left/Right Channels Independently



Mouse movements are restricted to left channels or right channels only.

IMPORTANT

- If **Position Left/Right Channels Independently** is activated, automation data is written for several parameters. Due to this, specific automation rules apply.
 - Automation data for the independent positioning mode is always written for the complete sound source, not for individual channels. This means it is not possible to record automation for one stereo channel and then add automation for the other stereo channel in a second go, for example.
-

NOTE

The movement restriction buttons do not affect the controls in the positioning section at the bottom of the window.

RELATED LINKS

[Restricting Movements When Dragging the Sound Source](#) on page 757

Restricting Movements When Dragging the Sound Source

When dragging the sound source within the pan area, different movement restriction modes allow you to limit the movement to a specific axis, allowing for very accurate positioning.

PROCEDURE

- To restrict the movement within the pan area, do one of the following:
 - Press the corresponding modifier key. The corresponding movement restriction button is highlighted, indicating that this mode is active.
As soon as you release the modifier key, you return to **Standard Positioning Mode**.
 - Click the corresponding button to activate a positioning mode permanently.
To deactivate the selected positioning mode, click **Standard Positioning Mode** or another movement restriction button.
-

RELATED LINKS

[Movement Restriction Modes](#) on page 756

Overview Mode

Overview Mode visualizes panning movements outside the pan area. However, the actual panning is done in the standard view.

If you have moved the sound source to outside of the pan area, **Overview Mode** allows you to see where the positioning handle and the panning handles are located. A thin line connects these theoretical positions with their acoustically effective positions.

- To activate/deactivate overview mode, click **Overview Mode**  below the pan area.

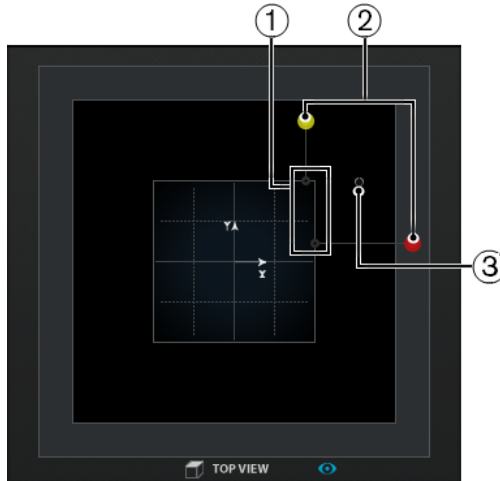

- 1 Acoustically effective positions of the left and right channel within the pan area
- 2 Theoretical positions of the left and right panning handle outside the pan area
- 3 Positioning handle outside the pan area

Pan Controls

Left-Right Pan and **Rear-Front Pan** allow you to pan the sound source on the x-axis and on the y-axis. For 3D channel configurations, **Bottom-Top Pan** allows you to pan the sound source on the z-axis.



NOTE

The panning controls are not affected by the movement restriction buttons.

RELATED LINKS

[Movement Restriction Modes](#) on page 756

Rotate and Tilt Controls

Rotate Signal around Z-Axis allows you to rotate the sound source. For 3D channel configurations, **Tilt Signal around Y-Axis** and **Tilt Signal around X-Axis** allow you to tilt the sound source around its own axes.



Rotating and tilting the sound source is useful if you work with premixed surround stems. You can rotate the surround sound source within the surround field of the output bus, and use this for a scene where the camera turns around, for example.

Orbit Controls

The orbit controls allow you to rotate the sound source, including all input channels, around the center of the surround field.

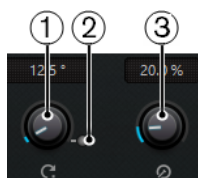

1 Orbit Center

This is the main control that allows you to perform the rotation. You can use this for a scene where a person moves around and can still be heard when behind the audience.

2 Counter Shot

This button allows you to rotate the sound source by exactly 180°, so that all positions in the surround image change sides.

You can use this for a close-up scene with people sitting face to face, and a lot of reverse shots. With **Counter Shot** you can flip the surround field each time that the camera switches from perspective A to perspective B and back.

NOTE

- **Counter Shot** is useful if you work with premixes, for example, the ambience stem, so that you only have to click the button once for each cut.
- If you pan a scene with reverse shots with less than 180°, so that you cannot use the **Counter Shot** button, make the adjustments for the first perspective of the reverse shot manually, write this as automation and use the **Punch Log** function to save this setup. Repeat this for the second perspective, and afterwards use the **Punch Log** entries to switch between the 2 perspectives with just one click.

3 Radius

If you use **Orbit Center**, **Radius** allows you to control the distance of the sound source from the center of the surround field without changing the angle.

IMPORTANT

In terms of automation, **Orbit Center**, **Counter Shot**, and **Radius** are not independent parameters as such. Instead, a combination of different automation parameters is used.

RELATED LINKS

[Punch Log](#) on page 829

Center Distribution Control

Center Distribution distributes part or all of the center signal to the left and right front speakers.

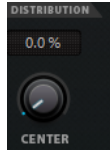

If you pan the center signal directly to the center speaker and set **Center Distribution** to 0 %, you may get a signal that is too discrete. In this case you can add part of the signal to the left and right front speakers to widen it. By raising the **Center Distribution** value you can distribute the signal to the 3 speakers. At 100 %, the center source is provided entirely by the phantom image created by the left and right speakers.

A line at the top of the surround field indicates the distance up to which a phantom signal is added:

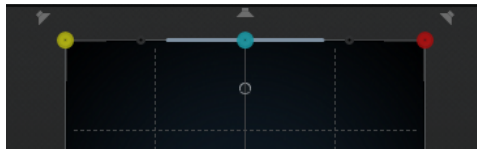

If you position the source signal inside this range, the signal is sent to all 3 channels.

Divergence Controls

Front Divergence, **Front/Rear Divergence**, and **Rear Divergence** determine the attenuation curves used when positioning sound sources for x-axis front, y-axis front/rear, and x-axis rear. For 3D channel configurations, **Height Divergence** allows you to determine the attenuation curve when positioning on the z-axis.



If all divergence controls are set to 0 %, positioning a sound source on a speaker sets all other speakers to level zero. With higher values, the other speakers receive a percentage of the sound source.

Horizontal and vertical lines show the effect of changing the divergence settings:

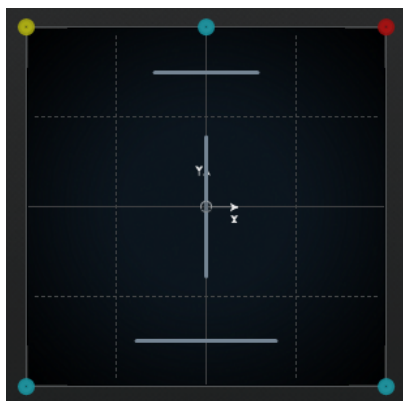

- At 0 %, a moving sound source is concentrated in one spot. You can use this to create the impression that something is taking place right in front of the spectator.
- At 100 %, a moving sound source is very diffuse and hard to locate. You can use this to create the impression that something is taking place far away from the spectator.

NOTE

- **Center Distribution** and **Front Divergence** are combined. If the front divergence is set to 100 %, the center distribution has no effect.
 - The setting of the **Height Divergence** is not shown in the pan areas.
-

Scale Controls

The scale controls allow you to control the horizontal (**Width**) and vertical (**Depth**) expansion of the sound source.



The scale controls influence the perception of spatiality and ambience, as well as the traceability of signals.

- 100 % corresponds to the complete width, depth, or height of the surround field.
- If you reduce all values to 0 %, the distance is reduced to zero and all source channels are centered in one spot.

NOTE

Depth is only available for configurations with front and rear channels.

Height is only available for configurations with top channels.

Elevation Patterns for 3D Mixing

You can use elevation patterns to let the height parameter automatically follow a predefined curve while positioning a sound in the 2D pan area. The active pattern is shown in the **Rear View** pan area.

- To activate/deactivate an elevation pattern, click one of the **Elevation Pattern** buttons.

NOTE

If an elevation pattern is active, **Bottom-Top Pan** cannot be adjusted manually.

The following elevation patterns are available:

Wedge, Ceiling, Sphere

These patterns correspond to the elevation modes that are defined by Dolby for Dolby Atmos authoring.

Cup, Tunnel, Half-Pipe

These patterns make use of the bottom of the 3D room.

NOTE

This might not have the expected effect in a small room speaker setup with close distance between side and top speakers.

Ridge

This pattern is similar to **Wedge** but more suitable for 7.1.2 bed-only mixes without an additional object mix.

Automation Rules for Elevation Patterns

- An active elevation pattern overrides any automation for **Bottom-Top Pan**, however, the automation remains intact.
- If elevation is deactivated, **Bottom-Top Pan** is set to bottom, even if automation for bottom-top panning is present. **Elevation On/Off** can also be automated.

Pan Laws for 3D Mixing

When an audio signal is moving through the room at a changing height, Nuendo makes use of a complex set of pan laws that ensures smooth and gapless transitions.

The following applies:

- The pan laws can cause a difference between the graphical position of a panning handle and the audible position of the sound source. If the graphical position of the sound source differs from the audible position, in the **Top View** pan area, the audible position is shown as a gray circle and the distance between both positions as a gray line.

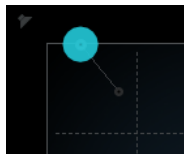

- If you move the **Bottom-Top Pan** control all the way to the right, the sound comes from the top speakers only.

Soloed, Muted, and Disabled Speaker Channels

The speaker buttons around the **Top View** and the **Rear View** represent the output configuration and allow you to disable, solo, or mute channels.

Enabled speaker



This channel is enabled.

Disabled speaker



This channel is disabled. Its signal is distributed to the other channels instead.

Soloed speaker



This channel is soloed.

Muted speaker



This channel is muted.

Disabled and muted speaker



This channel is disabled and muted.

- To disable a channel, **Alt/Opt**-click on the corresponding speaker button. That way, no audio is routed to this channel. The signal that would otherwise be sent to this channel is distributed to the other channels instead. For example, you can disable the center channels for all stems of a film mix except the dialogue stem to make sure that only dialogue is sent to the center speaker.

NOTE

If the signal of a disabled channel is distributed to other channels, the power level stays constant.

- To solo a channel, click the corresponding speaker button. That way, you only hear the signal sent to this channel while all other channels are muted. This can be useful for testing purposes, for example, to make sure that a signal is sent to a specific channel as intended.

NOTE

You can solo several channels at the same time by clicking on the corresponding speaker buttons one after the other. If you **Ctrl/Cmd**-click a speaker button, this channel is soloed exclusively and all other channels are muted.

IMPORTANT

Solo and mute cannot be automated.

RELATED LINKS

[Constant Power Panning](#) on page 747

Remote Controlling VST MultiPanner

You can control the **VST MultiPanner** plug-in remotely with several control devices. To control all panner functions, you may need updated software for your device.

Yamaha Nuage

To control 3D sound mixing functions of **VST MultiPanner** remotely on a Nuage system, you must install "Tools for Nuage V1.8" or later.

Avid

The parameters of **VST MultiPanner** are mapped on the following devices:

- System 5-MC
- S6
- Artist Series

Panning with a Joystick

You can use a joystick to remote-control **Rear-Front Pan** and **Left-Right Pan** in **VST MultiPanner**.

PREREQUISITE

You have connected a joystick to your computer and restarted Nuendo.

PROCEDURE

- To position the sound source in the room, pull the joystick trigger and move the joystick.
-

RELATED LINKS

[Joysticks](#) on page 879

Switching the Channel Panner

VST MultiPanner is the default panner plug-in for audio channels in Nuendo. Depending on the channel configuration, you can also use other panner plug-ins.

PROCEDURE

- In the **MixConsole**, in the **Channel Settings** window, or in the **Inspector**, right-click the miniature view of the panner plug-in **VST MultiPanner**, and from the context menu select a panner plug-in.
-

RELATED LINKS

[Miniature Views](#) on page 752

MixConvert V6

MixConvert V6 is a plug-in that converts one multi-channel audio source into another multi-channel destination. It is most frequently used to downmix a multi-channel surround mix into a format with fewer channels, for example, a 5.1 surround mix into a stereo mix.

MixConvert V6 can be used as an insert effect in the **MixConsole** like other plug-ins, but it also has special functions.

Nuendo automatically inserts **MixConvert V6** instead of **VST MultiPanner** if the channel, for example, an audio track or a group channel, is routed to a destination with fewer audio channels. **MixConvert V6** is also inserted in place of any cue send panner if the destination has a different channel configuration than the source.

NOTE

There is one exception to this behavior. If a stereo channel is routed to a mono destination through the channel routing or a cue send routing, a normal stereo panner is inserted. However, this stereo panner controls the balance of the left and right channels as they are blended into the mono destination. The center position blends both channels together by equal amounts. With the pan set all the way to the left, only the left channel can be heard, and vice versa.

The following table gives you an overview of which plug-in is used in a specific configuration:

Mono Tracks

Routing Destination	Surround Pan Option
Mono	<ul style="list-style-type: none"> • n.a.
Stereo	<ul style="list-style-type: none"> • Mono - Standard Panner
Surround	<ul style="list-style-type: none"> • VST MultiPanner • MixConvert V6
3D	<ul style="list-style-type: none"> • VST MultiPanner • MixConvert V6

Stereo Tracks

Routing Destination	Surround Pan Option
Mono	<ul style="list-style-type: none"> • Stereo - Standard Panner
Stereo	<ul style="list-style-type: none"> • Stereo - Balance Panner • Stereo - Combined Panner
Surround	<ul style="list-style-type: none"> • VST MultiPanner • MixConvert V6
3D	<ul style="list-style-type: none"> • VST MultiPanner • MixConvert V6

Surround Tracks

Routing Destination	Surround Pan Option
Mono	<ul style="list-style-type: none"> • MixConvert V6
Stereo	<ul style="list-style-type: none"> • MixConvert V6
Surround	<ul style="list-style-type: none"> • VST MultiPanner • MixConvert V6
Surround with larger channel width	<ul style="list-style-type: none"> • VST MultiPanner • MixConvert V6
Surround with smaller channel width	<ul style="list-style-type: none"> • MixConvert V6
3D	<ul style="list-style-type: none"> • VST MultiPanner • MixConvert V6

3D Tracks

Routing Destination	Surround Pan Option
Mono	<ul style="list-style-type: none"> MixConvert V6
Stereo	<ul style="list-style-type: none"> MixConvert V6
Surround	<ul style="list-style-type: none"> MixConvert V6
Surround with larger channel width	<ul style="list-style-type: none"> MixConvert V6
Surround with smaller channel width	<ul style="list-style-type: none"> MixConvert V6
3D	<ul style="list-style-type: none"> VST MultiPanner MixConvert V6

You can select the surround pan option in the context menu of the panner miniature views in the **MixConsole**, in the **Channel Settings** window, and in the **Inspector**.

RELATED LINKS

[MixConvert V6 Plug-in Panel](#) on page 766

[VST MultiPanner](#) on page 747

[Input and Output Channel Configurations](#) on page 768

[Miniature Views](#) on page 752

MixConvert V6 Plug-in Panel

The **MixConvert V6** plug-in panel allows you to set the levels of the surround channels, and to solo or mute channels for input and output channels.

- To show/hide the **Input** or **Output** sections, click the corresponding arrow button.



The plug-in panel is divided into three sections: the **Input** section, the **Output** section, and the center section. The **Input** and **Output** sections are hidden by default.

Input section

Shows all input channels and allows you to solo or mute channels.

Output section

Shows all output channels and allows you to solo or mute channels.

The center section contains the main plug-in parameters as well as buttons for soloing several speaker channels in one go.

Input Channel Configuration

Shows the input channel configuration.

Output Channel Configuration/Select Output Channel Configuration

Shows the output channel configuration.

If **MixConvert V6** is used as an insert effect, the pop-up menu allows you to set the output channel configuration.

Solo Channel buttons

Solos all front channels, the LFE channel, or all surround channels in the input or output display. All other channels are muted.

Listen to Solo Channels on Center Channel

Routes all soloed channels to the center channel. If no center channel is present, the signal from the soloed channels is distributed equally to the left and right speakers.

Listen to Surround Channels on Front Channels

Solos all surround channels, including the side channels, and routes or downmixes them to the front speakers.

Center Level

Sets the level of the front center channel.

LFE Fader Level

Sets the level of the LFE channel.

Surround Level

Sets the level of the surround channels. The level of the surround channels cannot be adjusted individually.

Side Level

Sets the level of the side channels. The level of the side channels cannot be adjusted individually.

Top Level

Sets the level of the top channels. The level of the top channels cannot be adjusted individually.

Global Gain Level

Sets the level of all output channels.

Activate/Deactivate Low-Pass Filter

Activates/Deactivates the low-pass filter that is applied to the LFE channel.

Reset Parameters

Alt/Opt -click this button to reset all panner parameters to their default values.

RELATED LINKS

[Input and Output Channel Configurations](#) on page 768

Input and Output Channel Configurations

The input channel configuration is determined by the channel width of the track, group, or output bus on which **MixConvert V6** is inserted. The output channel configuration depends on whether **MixConvert V6** is used.

- If **MixConvert V6** replaces the panner, the output configuration is determined by the destination of the channel or cue send.
- If **MixConvert V6** is used as an insert effect, the output configuration can be modified using the **Select Output Channel Configuration** pop-up menu. You can select any configuration from the VST 3 specification that contains speakers that are also present in the input configuration.

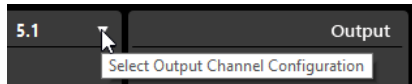

NOTE

You can also modify the output configuration by loading a preset.

Soloing Channels

You can click the speaker icons in the input and output channel displays or the solo channel buttons in the center section to solo or mute channels.

Soloing an input channel allows you to hear the influence of the soloed channel on the downmix. Soloing an output channel allows you to hear only the soloed channel in the downmix.

To solo channels, do one of the following:

- To solo a channel, click the corresponding speaker icon.
You can solo several channels at the same time. All other channels are muted.
To deactivate the solo state of a channel, click the corresponding speaker icon again.
- To solo a channel exclusively, **Ctrl/Cmd**-click the corresponding speaker icon.
- To solo all front channels, all surround channels, all side channels, or all top channels, click the corresponding button in the center section.
- To solo the LFE channel, click the corresponding cross-hair icon in the center of the channel display.

NOTE

Alternatively, click the **Solo Input/Output LFE Channel** button in the center section.

- To mute a channel, **Shift**-click the corresponding speaker icon.

RELATED LINKS

[MixConvert V6 Plug-in Panel](#) on page 766

MixConvert 3D Downmix Rules

The downmix function in Nuendo supports channel-based 3D mixing. If the **Control Room** mix is different from the main mix output bus, or if the signal is routed to an output bus with a lower number of channels, the signal is converted automatically using the **MixConvert V6** plug-in.

MixConvert V6 allows you to solo or mute the top and side channels, and to adjust the top and side channel level.

For Dolby Atmos 3D mixing, the following downmix rule applies:

- If a 9.1 mix is converted to a 7.1 mix, the top channel signals are attenuated by 1.5 dB and added to the side channel signals.

RELATED LINKS

[Authoring and Mixing for Dolby Atmos](#) on page 770

Surround Mix Export

Nuendo allows you to export a surround mix using the **Export Audio Mixdown** function.

You have the following export options when working with a surround configuration:

- Split channels, resulting in one mono audio file for each surround channel.
- Export to interleaved format, resulting in a single multi-channel audio file, for example, a 5.1 file containing all 6 surround channels.

RELATED LINKS

[Export Audio Mixdown](#) on page 1162

[Wave Files](#) on page 1178

Object Audio in Nuendo

Nuendo provides a complete suite of tools for authoring, recording, mixing, and playing back object-based audio content using the Audio Definition Model (ADM).

Object audio generally consist of two parts: a pure audio stream that is directly sent to a renderer, and separate metadata providing the renderer with information on how to play back the audio on a dedicated playback system. This can be a movie theater, a home entertainment or gaming setup, or the public address system for a live show.

Nuendo supports two object-based audio contexts:

- Dolby Atmos®
- Open Sound Control (OSC)

For both contexts, you can set up complex object-based projects and play them back using an appropriate renderer, or export the complete object structure to an ADM Broadcast Wave file, for example, to use it as a master file.

Objects contain static and dynamic metadata for playback. Static metadata spans settings for acoustical trimming and downmixing for playback on dedicated speaker setups, settings for binaural playback, or the assignment to object groups. The panning information for the audio stream is provided as dynamic metadata. When exported to an ADM file, audio stream and metadata are also stored separately within this file.

Objects receive object IDs, either automatically or manually. These IDs determine the renderer input port to which the audio stream is sent.

When working with object audio in Nuendo, you must consider some aspects compared to channel-based audio:

- In Nuendo, objects can be understood as logical instances in the object structure. Therefore, any audio, group, or VST track can become an object by selecting it as source track for an object in the object structure. You do this in the **ADM Authoring for Dolby Atmos** window. As source track, you can select any track that uses the **VST MultiPanner** plug-in as channel panner. This switches the corresponding **VST MultiPanner** to **Object Mode**.
- Panning data for objects is sent or stored separately as dynamic metadata and only used when played back through a renderer. Therefore, objects are not summed up and played back through the **Main Mix** channel. For Dolby Atmos content, you can use the **Renderer for**

Dolby Atmos plug-in as internal renderer, which allows you to monitor an object-based mix within Nuendo.

- The object audio stream is automatically routed through send slot 8 to the object bus. For channels that are in object mode, do not use send slot 8 for other purposes.
- Objects are generally meant to be mono, but in Nuendo, you can also create multi-objects. If you export multi-objects to an ADM file or play it back through an external renderer, they are split to a corresponding number of mono objects, containing their own panning metadata.

RELATED LINKS

[Authoring and Mixing for Dolby Atmos](#) on page 770

[Authoring and Mixing Object-Based Productions Using Open Sound Control \(OSC\)](#) on page 788

[Renderer for Dolby Atmos Plug-in Panel](#) on page 775

[Object Mapping for External Renderers](#) on page 777

[Object Busses](#) on page 778

[Object Mixes with VST MultiPanner](#) on page 787

[VST MultiPanner Plug-in Panel in Object Mode](#) on page 787

Authoring and Mixing for Dolby Atmos®

Nuendo allows you to mix fully compliant audio content for Dolby Atmos and to create ADM files in Broadcast Wave Format (BWF) with object audio and channel-based beds for playback through the Dolby Atmos Renderer.

Nuendo supports the creation, import, and export of Audio Definition Model (ADM) files with Dolby Atmos content. You can either set up Dolby Atmos projects from scratch, or import ADM BWF files, for example, complete Dolby Atmos premixes with objects and beds, into existing projects, preserving the ADM file structure and pan automation. Objects are generally meant to be mono, but in Nuendo, you can also create stereo or multi-channel objects.

ADM authoring for Dolby Atmos in Nuendo involves the following features and functions:

- The **ADM Authoring for Dolby Atmos** window allows you to set up and edit the object structure by adding and configuring objects and beds.
- The **Renderer for Dolby Atmos** plug-in is an internal renderer that allows you to monitor Dolby Atmos projects with up to 128 objects without using an external renderer.
- The **External Dolby Atmos Renderer Setup** dialog allows you to establish a connection to an external Dolby Atmos Renderer. In this dialog, you can define your audio objects by mapping audio outputs to object IDs. Mapped audio outputs that are connected to output busses in the **Audio Connections** window serve as your object busses.
- The **VST MultiPanner** plug-in provides 3D panning for channel-based bed mixes in **Bed Mode** and for object-based mixes with up to 118 objects in **Object Mode**.

RELATED LINKS

[Object Audio in Nuendo](#) on page 769

[Setup for Dolby Atmos Mixes](#) on page 771

[ADM Files](#) on page 1304

[Renderer for Dolby Atmos Plug-in Panel](#) on page 775

[External Dolby Atmos Renderer Setup Dialog](#) on page 780

[Requirements for Beds](#) on page 772

[Object Mixes with VST MultiPanner](#) on page 787

Setup for Dolby Atmos Mixes

For creating Dolby Atmos mixes, you need a renderer and must define audio tracks as beds and objects in your project.

Generally, we recommend that you start a new Dolby Atmos project by creating a group track as bed. Start with routing all tracks that you want to use as source tracks for beds or objects to this bed group. This signal routing is later automatically modified when you define beds and objects in the **ADM Authoring for Dolby Atmos** window.

All audio objects in your object structure – beds as well as objects – need a source track that sends an audio signal to it. Any audio track, group track, or instrument track in your project can act as a source track for audio objects. If a track is selected as source track, its **VST MultiPanner** channel panner is switched to object mode and its audio signal is automatically re-routed from the bed to the renderer.

As renderer, you can either use the internal **Renderer for Dolby Atmos** plug-in or connect your system to the external Dolby Atmos Renderer.

Internal Renderer

If you use the internal **Renderer for Dolby Atmos** plug-in, selecting source tracks for beds and objects in the **ADM Authoring for Dolby Atmos** window automatically routes the audio through the renderer plug-in via side-chaining.

When using the **Renderer for Dolby Atmos** plug-in, the following applies:

- The plug-in should generally be inserted in the **Main Mix** output channel. It supports the following output channel configurations: 2.0, 5.1, 5.1.4, 7.1, and 7.1.4.

NOTE

We recommend that you activate solo defeat in the **Main Mix** channel. This avoids unintentional muting of the main mix when soloing channels in your project.

If you have activated the **Control Room**, you can alternatively use **Renderer for Dolby Atmos** as insert plug-in in the **Main** section. In this case, however, you cannot use the **Renderer for Dolby Atmos** for exporting a channel-based downmix of your Dolby Atmos mix via the **Export Audio Mixdown** dialog.

- The usage of the **Renderer for Dolby Atmos** plug-in requires a multi-channel output bus in your project. If you use a stereo main mix, you must add at least one additional multi-channel output bus to make **VST MultiPanner** available as channel panner.
- You can use only one instance of the plug-in in your project.
- Your audio system must be set to an ASIO buffer size of 512 samples and to a sample rate of 48 kHz.
- The plug-in does not support binaural rendering.
- The plug-in supports the following bed channel configurations: 2.0, 3.0, 5.0, 5.1, 7.0, 7.1, 7.0.2, and 7.1.2.
- When defining beds and objects in the **ADM Authoring for Dolby Atmos** window, object IDs are assigned automatically.

External Renderer

If you use an external Dolby Atmos Renderer, such as the Dolby Atmos Production Suite, Dolby Atmos Mastering Suite, or Cinema RMU (Dolby Rendering and Mastering Unit), you must first create object busses. In Nuendo, an object bus is an output bus that is connected to a device port, which in turn is mapped to an object ID. The mapping is done in the **External Dolby Atmos Renderer Setup** dialog. We recommend that you use the **Auto-Connect Object Busses** option in

the **ADM Authoring for Dolby Atmos** window when adding objects, which creates object busses automatically.

RELATED LINKS

- [ADM Authoring for Dolby Atmos Window](#) on page 782
- [Renderer for Dolby Atmos Plug-in Panel](#) on page 775
- [Setting the Default Output Bus \(Main Mix\)](#) on page 35
- [Using Solo and Mute](#) on page 432
- [Ambisonics Mixes](#) on page 792
- [Monitoring Ambisonics Audio Binaurally via the Phones Channel](#) on page 799
- [Connecting the Dolby Atmos Renderer](#) on page 780
- [Requirements for Beds](#) on page 772
- [Object Busses](#) on page 778
- [VST MultiPanner Plug-in Panel in Object Mode](#) on page 787

Requirements for Beds

When working with channel-based beds in Dolby Atmos mixes, you must respect several requirements regarding channel configurations and routing.

Beds for Dolby Atmos projects are in fact channel-based sub-mixes, comparable to stems. When mixing for a Dolby Atmos audio bed using the internal **Renderer for Dolby Atmos** plug-in, the following applies:

- We recommend that you use group tracks for beds. You can then route mono, stereo, or surround channels to a bed group.

NOTE

- If a track is routed to a bed in 3D format, its **VST MultiPanner** channel panner offers additional settings and parameters for 3D mixing.
 - If you route a 7.1.2 channel to a bus or group channel in 7.1.2 or another 3D channel configuration, **MixConvert V6** is used for panning.
-
- The following bed channel configurations are supported by the internal **Renderer for Dolby Atmos** plug-in and the external Dolby Atmos Renderer: 2.0, 3.0, 5.0, 5.1, 7.0, 7.1, 7.0.2, and 7.1.2.
 - Plug-ins that are used in a 3D bus or group channel must support a corresponding number of channels.

If you use an external renderer, you must also consider the following:

- You must route the source channel of the bed to a group channel or output bus with a channel width that is supported by the used renderer.
- When setting up the routing of your Dolby Atmos project manually, we recommend that you route the first 10 device ports of your audio interface to the bed bus to ensure the correct routing for the Dolby Atmos mix. You can select the device ports in the **Audio Connections** window.

IMPORTANT

In Nuendo, the order of surround channels and side channels differs from the Dolby specification for side surround channels (Lss, Rss) and surround rear channels (Lsr, Rsr). To meet the specification for the external Dolby Atmos Renderer, swap the device ports of surround channels and side channels.

Inputs		Outputs	Group/FX	External FX	External Instruments	Control Room
Add Bus		Presets	No Preset ▼			
				Expand All		Collapse All
Bus Name	Speakers	Audio Device	Device Port			
▼ BED MIX	7.1.2	ASIO HDSPe FX				
Left			MADI 1			
Right			MADI 2			
Center			MADI 3			
Lfe			MADI 4			
Left Surround			MADI 5			
Right Surround			MADI 6			
Side Left			MADI 7			
Side Right			MADI 8			
Top Side Left			MADI 9			
Top Side Right			MADI 10			
▼ OBJECT 001	Mono	ASIO HDSPe FX				
Mono			MADI 11			
▼ OBJECT 002	Mono	ASIO HDSPe FX				
Mono			MADI 12			
▼ OBJECT 003	Mono	ASIO HDSPe FX				
Mono			MADI 13			
▼ OBJECT 004	Mono	ASIO HDSPe FX				
Mono			MADI 14			
▼ OBJECT 005	Mono	ASIO HDSPe FX				

RELATED LINKS

- [VST MultiPanner Plug-in Panel for 3D Channel Configurations](#) on page 751
- [MixConvert 3D Downmix Rules](#) on page 768
- [Available Surround Channel Configurations](#) on page 741

Setting up a Dolby Atmos Project Using the Renderer for Dolby Atmos Plug-in

This example shows the recommended way to set up a Dolby Atmos project that contains a channel-based 7.1.2 bed for music and effects and 4 mono objects for dialogue, and uses the **Renderer for Dolby Atmos** plug-in as internal renderer.

PREREQUISITE

- You have created a new project.
- Your audio system is set to an ASIO buffer size of 512 samples and to a sample rate of 48 kHz.

PROCEDURE

- In the **Audio Connections** window, on the **Outputs** tab, add an output bus in a channel configuration that matches your speaker setup as **Main Mix**.

NOTE

The **Renderer for Dolby Atmos** plug-in supports the following output channel configurations: 2.0, 5.1, 7.1, 5.1.4, and 7.1.4.

- In the main mix channel, add **Renderer for Dolby Atmos** as an insert plug-in.
- In the **ADM Authoring for Dolby Atmos** window, select the **Renderer for Dolby Atmos** plug-in from the **Renderer** pop-up menu.
- In the main mix channel, **Alt/Opt**-click **Solo** to activate solo defeat. This avoids unintentional muting of the main mix when soloing channels in your project.

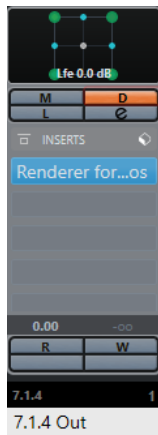

5. In the **Project** window, add a group track in 7.1.2 channel configuration, named **Bed**, and route it to the main mix output bus.
This group serves as bed in your Dolby Atmos project.
6. Route all tracks with music or effects that you want to use as bed audio to the **Bed** group track.
7. Add 4 mono audio tracks to your project, named **DIA 1** to **DIA 4**, and route them to the **Bed** group track.
8. In the **ADM Authoring for Dolby Atmos** window, click **Add Bed**.
A bed is added to the list of audio objects.
9. For this bed, select **Bed** as **Source Track**.
You have now established a bed in the object structure of your Dolby Atmos project. The signal of this bed is automatically routed via side-chaining through the **Renderer for Dolby Atmos** plug-in.

NOTE

Make sure that the 4 mono tracks, the main mix channel, and the bed channel all use **VST MultiPanner** as channel panner.

10. In your project, select the audio tracks **DIA 1** to **DIA 4**.
11. In the **ADM Authoring for Dolby Atmos** window, select **Create Objects from Selected Tracks** from the **Functions** pop-up menu.
Four objects are added to the list of audio objects, automatically connected to the corresponding source tracks.

RESULT

The object structure of your example Dolby Atmos project is shown in the **ADM Authoring for Dolby Atmos** window as follows:

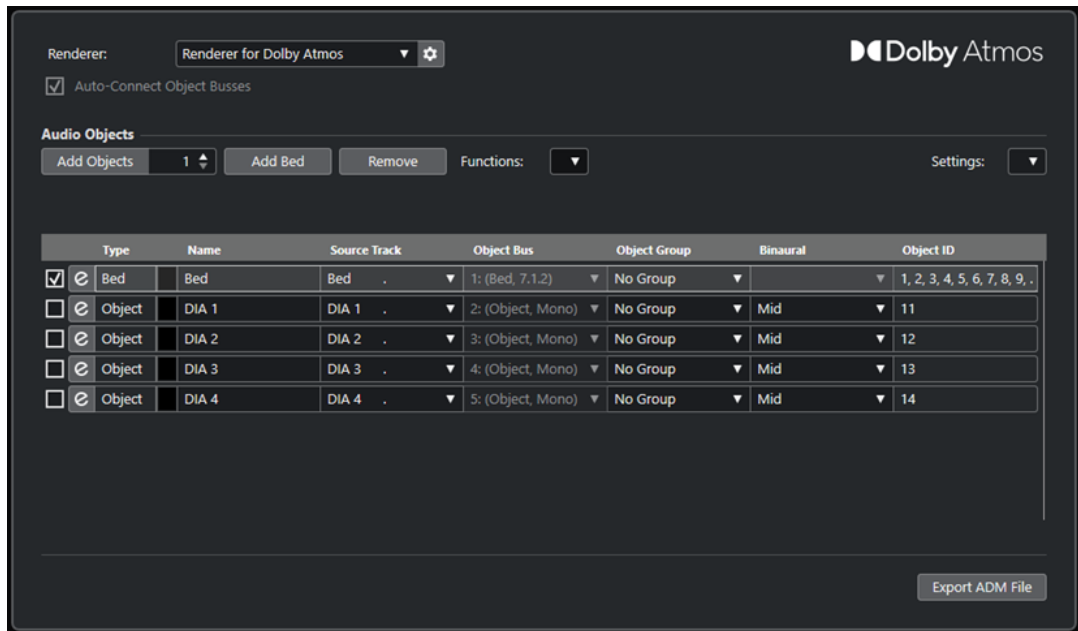

- All audio that is routed to the **Bed** group track serves as premix for the 7.1.2 bed.
- The mono tracks **DIA 1** to **DIA 4** have become objects, using **VST MultiPanner** as channel panner in **Object Mode**.
- All items in the object structure, bed and objects, automatically received object IDs.
- On playback, you can hear the output signal of the **Renderer for Dolby Atmos** plug-in.
- Pan automation of all object audio is passed to the renderer as dynamic metadata.

AFTER COMPLETING THIS TASK

Add audio events to music, effect, and dialogue tracks and to the source tracks of your objects, and create your Dolby Atmos mix using **VST MultiPanner** for panning.

When you have finished your mix, you can click **Export ADM File** in the **ADM Authoring for Dolby Atmos** window to export it as an ADM Broadcast Wave file, including the complete object structure and all panning automation as dynamic metadata.

RELATED LINKS

- [Renderer for Dolby Atmos Plug-in Panel](#) on page 775
- [Adjusting the Buffer Size](#) on page 1351
- [Project Setup Dialog](#) on page 108
- [Audio Connections Window](#) on page 28
- [Setting the Default Output Bus \(Main Mix\)](#) on page 35
- [Switching the Channel Panner](#) on page 764
- [Using Solo and Mute](#) on page 432
- [ADM Authoring for Dolby Atmos Window](#) on page 782
- [Object Mixes with VST MultiPanner](#) on page 787
- [VST MultiPanner Plug-in Panel in Object Mode](#) on page 787
- [Exporting ADM Files](#) on page 1306

Renderer for Dolby Atmos Plug-in Panel

The **Renderer for Dolby Atmos** plug-in allows you to monitor and downmix your Dolby Atmos mix without using an external renderer.

- To open the plug-in panel, select **Renderer for Dolby Atmos** from the **Renderer** pop-up menu in the **ADM Authoring for Dolby Atmos** window, and then click **Renderer Setup**.

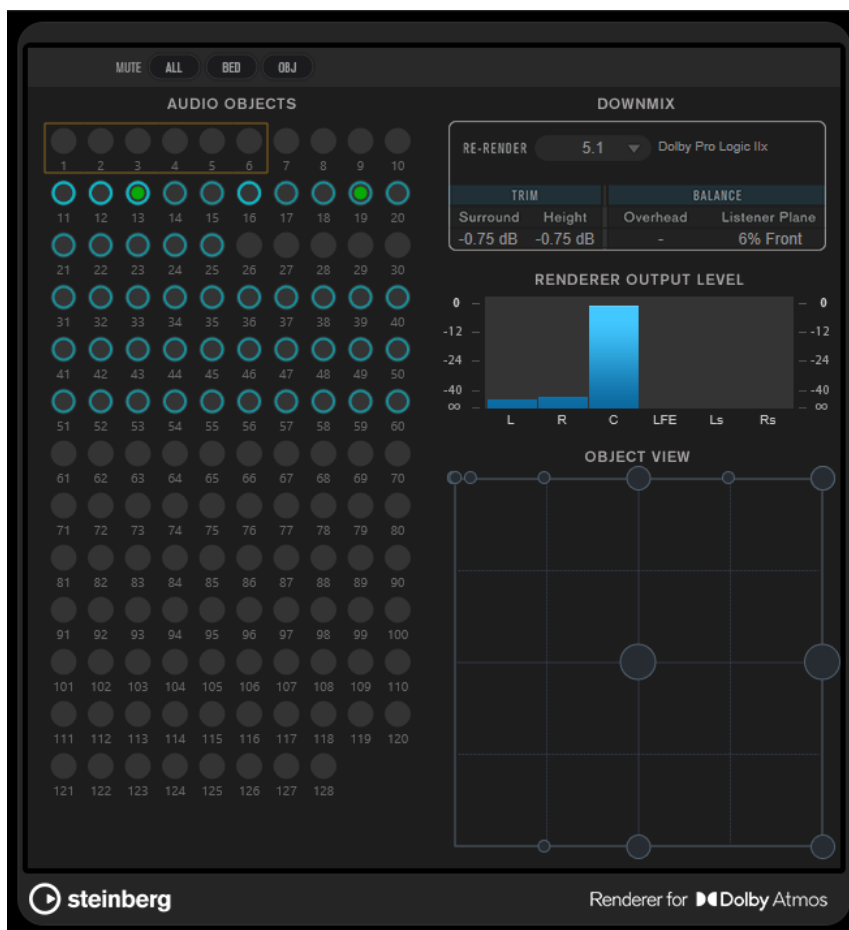

Mute

These buttons allow you to mute all beds, all objects, or all beds and objects at the same time.

Audio Objects

Displays the mapping of object IDs to audio objects. Object IDs that are mapped to a bed are spanned by a square. Object IDs that are mapped to objects are circled. Audio signals on the corresponding source tracks are indicated by a level LED.

Trim and Downmix

Displays the current settings received from the **Trim and Downmix Editor**. **Downmix** allows you to select the downmix channel configuration.

Renderer Output Level

Displays the renderer output level for all channels.

Object View

Displays the positions for all audio objects in the room.

RELATED LINKS

[Trim and Downmix Editor](#) on page 784

Adding Multi-Objects

In Nuendo, you can create multi-objects in addition to standard mono objects. This allows you to tilt and rotate pre-panned multi-channel signals in the Dolby Atmos surround field, for example, a 5.1 channel background mix.

PREREQUISITE

You have set up a valid routing and an ADM structure for Dolby Atmos content, containing objects.

PROCEDURE

1. Add a stereo or multi-channel track.
 2. In the **ADM Authoring for Dolby Atmos** window, add an object and select the created track as the source track.
-

RESULT

- The audio of the source track is sent to the object, which now acts as a multi-object. Each channel of the source track now has an individual object ID.

AFTER COMPLETING THIS TASK

You can export multi-objects to an ADM file or play it back through an external renderer. In both cases, the multi-objects are split to a corresponding number of mono objects that contain their own panning metadata.

Object Mapping for External Renderers

If you use an external renderer, you must define which of the audio streams that are sent to the renderer are objects.

Objects consist of an audio stream that is sent to the external renderer plus a metadata stream transporting the panning information. Objects are always sent in real time, and they are monitored in the renderer.

The audio connection from Nuendo to the external renderer may be a MADI cable, a Dante patch, or, if used on the same computer, the Dolby Audio Bridge software. In any case, this connection is handled like a physical audio connection to the device ports of Nuendo.

NOTE

We recommend that you customize the names of the device ports according to your system setup. You can do this on the ASIO driver setup page in the **Studio Setup** dialog.

Signals running through device ports that are connected to an external renderer are treated as objects when mixing. In the **External Dolby Atmos Renderer Setup** dialog, you can map the output device ports of Nuendo and the input device ports of the external renderer. This mapping must follow the input configuration of the renderer. The renderer input device port defines the ID of an object.

- To open the setup for an external renderer, select the renderer from the **Renderer** pop-up menu in the **ADM Authoring for Dolby Atmos** window, and then click **Renderer Setup**. Alternatively, you can select the setup for external renderers from the **Studio** menu.

In the **External Dolby Atmos Renderer Setup** dialog, you can map objects to audio outputs either manually or automatically:

- To map objects to all available audio outputs automatically, click **Map All**.

NOTE

- You can use up to 118 objects. However, in the **External Dolby Atmos Renderer Setup** dialog, the first 10 objects are reserved for the 7.1.2 Dolby Atmos bed and are excluded from mapping. Therefore, for Dolby Atmos projects, we recommend that you configure the first 10 device ports of your audio interface for the bed bus.
 - You can define further device ports as bed channels by activating the corresponding checkbox in the **Bed** column.
 - Objects that are already mapped remain unchanged.
-
- To map an object to an audio output manually, click the corresponding **Renderer Input Device Port** pop-up menu, and select an object ID.

NOTE

- In the **External Dolby Atmos Renderer Setup** dialog, manual mapping of objects is necessary if the bed bus does not use the first 10 output device ports of your audio interface.
 - Objects that are already mapped to an audio output are shown as in use in the pop-up menu. If you select an object that is already in use, the previous mapping is lost.
-
- To discard the mappings between all device ports and objects, click **Unmap All**.

RELATED LINKS

[External Dolby Atmos Renderer Setup Dialog](#) on page 780

[External OSC Renderer Setup Dialog](#) on page 789

[ASIO Driver Setup Page](#) on page 21

Object Busses

In Nuendo, object busses are used to send audio from source tracks in your project as object audio to an external renderer.

An object bus is defined as an output bus that is connected to a device port, which in turn is mapped with a renderer input device port, provided with an object ID.

This connection can be established either automatically or manually when selecting source tracks for objects in the **ADM Authoring for Dolby Atmos** window. If **Auto-Connect Object Busses** is activated, an object bus is automatically created and connected to the external renderer for each object in the object structure. You can also manually select object busses in the **VST MultiPanner** of the corresponding source track if the panner works in **Object Mode**.

When working with object busses, the following applies:

- Only object busses with a matching channel configuration can be selected. For example, if you want to pan a stereo channel as an object, you can only connect the channel to a stereo object bus.
- Each object bus can only be used by the **VST MultiPanner** of one channel in object mode at the same time. The connection between panner and object bus is broken if the object bus is selected in the panner of another channel.

IMPORTANT

To avoid unwanted results when working with object audio, we recommend the following:

- Do not use object busses as routing destinations for normal audio channels.
 - The object audio stream is automatically routed through send slot 8 to the object bus. For channels that are in object mode, do not use send slot 8 for other purposes.
-

RELATED LINKS

- [Object Mapping for External Renderers](#) on page 777
- [Multi-Object Busses](#) on page 779
- [Creating Object Busses Automatically](#) on page 779
- [Creating Object Busses Manually](#) on page 780
- [VST MultiPanner Plug-in Panel in Object Mode](#) on page 787

Multi-Object Busses

You can make stereo and multi-channel busses available as multi-object busses.

Generally, objects in Dolby Atmos content are meant to be mono, but Nuendo also allows you to create stereo or multi-channel busses and make them available as multi-object busses. This allows you to tilt and rotate pre-panned multi-channel signals in the Dolby Atmos surround field, for example, a 5.0 channel background mix.

NOTE

- Due to the proximity between side and top speakers in a Dolby Atmos system, tilting of multi-channel signals allows for a signal panning that may not always be perfectly reproducible.
 - In **Object Mode**, there is no LFE channel. If you want to use a surround bus with an LFE channel, for example 5.1, as multi-object bus, we recommend that you downmix the LFE channel first.
 - For multi-object busses in a channel configuration with LFE, for example 5.1 or 7.1, the LFE channel is not shown as object.
-

RELATED LINKS

- [Object Busses](#) on page 778
- [Object Mixes with VST MultiPanner](#) on page 787
- [Adding Multi-Objects](#) on page 777

Creating Object Busses Automatically

Nuendo allows you to create object busses automatically when adding objects to your ADM project.

PROCEDURE

1. In the project zone, select the tracks that you want to become objects.
 2. In the **ADM Authoring for Dolby Atmos** window, select **External Dolby Atmos Renderer** from the **Renderer** pop-up menu.
 3. Activate **Auto-Connect Object Busses**.
 4. Select **Create Objects from Selected Tracks** from the **Functions** pop-up menu.
-

RESULT

- The selected tracks are added as objects to the list of audio objects.
- For each object, an object bus is created and connected to the external renderer.

NOTE

For stereo or multi-channel tracks, multi-object busses are created.

- The panning automation of the tracks is passed to the renderer as dynamic metadata.
- Objects can be played back through the renderer.

RELATED LINKS

[Object Busses](#) on page 778

[ADM Authoring for Dolby Atmos Window](#) on page 782

Creating Object Busses Manually

This example shows you how to manually create 16 object busses for an object-based Dolby Atmos mix if using the external Dolby Atmos Renderer.

PROCEDURE

1. In the **External Dolby Atmos Renderer Setup** dialog, map 16 of 64 available output device ports to object IDs by selecting from the corresponding **Renderer Input Device Port** pop-up menu.
2. In the **Audio Connections** window, create 16 mono output busses.
3. Connect the 16 mono output busses one by one to the 16 mapped output streams.

RESULT

The 16 mono output busses are defined as your object busses. In the **VST MultiPanner** plug-in, you can select these 16 object busses in the **Select Object Bus** pop-up menu for mono channels.

RELATED LINKS

[Object Busses](#) on page 778

Connecting the Dolby Atmos Renderer

If you want to use the external Dolby Atmos Renderer, you must connect it to your system. The last used connection to the renderer is saved and restored when you restart the application.

PROCEDURE

1. In the **ADM Authoring for Dolby Atmos** window, select **External Dolby Atmos Renderer** from the **Renderer** pop-up menu.
2. Click the **Renderer Setup** button to the right of the pop-up menu.
3. In the **External Dolby Atmos Renderer Setup** dialog, enter the IP address of the Dolby Atmos Renderer in the **Renderer** field.
4. Make your settings in the **Device Port Mapping** section.

RELATED LINKS

[External Dolby Atmos Renderer Setup Dialog](#) on page 780

External Dolby Atmos Renderer Setup Dialog

The **External Dolby Atmos Renderer Setup** dialog allows you to establish the connection to the Dolby Atmos Renderer and to map the input ports of the renderer to ASIO output device ports of your system.

- To open the **External Dolby Atmos Renderer Setup** dialog, select **Studio > External Dolby Atmos Renderer Setup**.

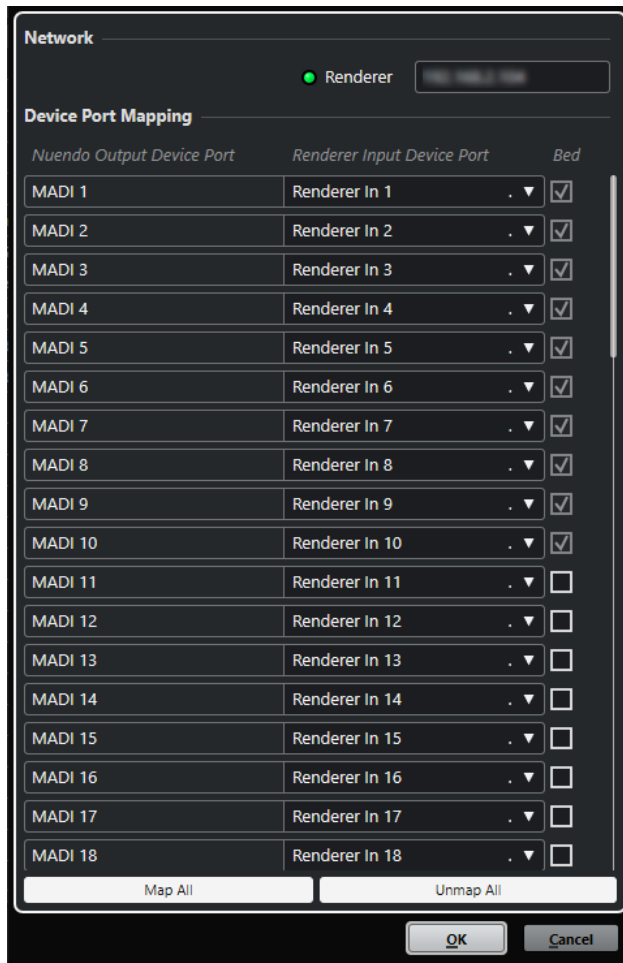

Renderer

Allows you to enter the IP network address of the Dolby Atmos Renderer.

NOTE

The last used connection to a renderer is saved and restored when you restart the application.

Nuendo Output Device Port

Lists the available ASIO output device ports.

Renderer Input Device Port

Allows you to map your ASIO output device ports to input device ports of your renderer.

Bed

If this option is activated, the corresponding device port is defined as bed.

NOTE

The first 10 output device ports are reserved for a channel-based 7.1.2 bed mix. For these ports, this option is always activated.

Map All

Maps all available ASIO output device ports to renderer input device ports automatically.

NOTE

- The first 10 output device ports are reserved for a channel-based 7.1.2 bed mix and are therefore excluded from automatic mapping.
- Existing mappings between ASIO output device ports to renderer input device ports remain unchanged.

Unmap All

Discards the mapping between all ASIO output device ports and renderer input device ports.

ADM Authoring for Dolby Atmos Window

In the **ADM Authoring for Dolby Atmos** window, you can create, edit, and export the object structure of your Dolby Atmos project. It allows you to select a renderer and provides direct access to further related settings.

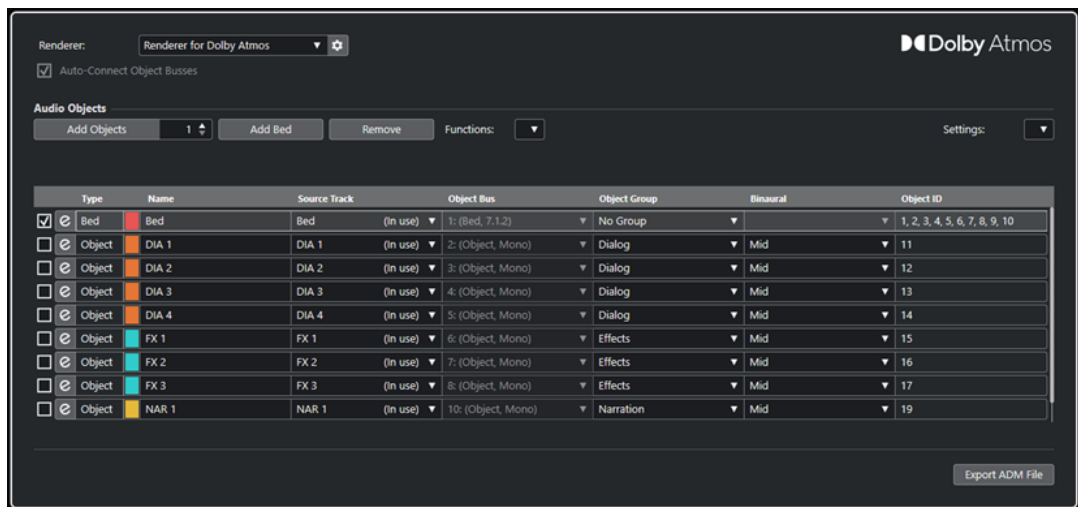

- To open the **ADM Authoring for Dolby Atmos** window, select **Project > ADM Authoring for Dolby Atmos**.

Renderer

Allows you to select a renderer. **Renderer Setup** opens the corresponding setup dialog for the selected renderer.

Auto-Connect Object Busses

If this option is activated, all objects in your ADM are automatically connected to object busses. In this case, object busses with the corresponding channel configuration are created automatically.

If this option is deactivated, you can manually select object busses by clicking in the **Object Bus** column. For this to work, you must create output busses with the corresponding channel configuration in the **Audio Connections** window first.

NOTE

This option is only available for external renderers.

Add Objects

Adds the set number of objects to the list of audio objects.

Add Bed

Adds a bed to the list of audio objects.

Remove

Removes selected items from the list.

Functions

This pop-up menu provides the following functions:

- **Create Objects from Selected Tracks** allows you to add objects that use the selected tracks in your project as **Source Track**.
- **Apply Source Track Name** applies the name of the corresponding source track as **Name** for selected audio objects.

Settings

This pop-up menu allows you to open the following dialogs:

- **Trim and Downmix Editor**
- **Binaural Render Mode for Beds**
- **Object Group Editor**

The list shows the object structure and the settings for all audio objects and allows you to edit them:

Open/Close Source Track Panner

Opens/Closes the panner of the corresponding source track.

Name

Allows you to enter a name.

Source Track

Allows you to select a source track.

Object Bus

Allows you to select an object bus.

NOTE

Objects that are not connected to an object bus are not exported.

Object Group

Allows you to assign the audio object to an object group.

Binaural

Allows you to select a mode for binaural rendering for playback on headphones or to deactivate binaural rendering for playback on speakers.

NOTE

- Static metadata for binaural rendering is stored in the ADM file when exporting but not sent to an external Dolby Atmos Renderer in real time.
 - For beds, you can make the binaural rendering settings in the **Binaural Render Mode for Beds** dialog.
-

Object ID

Shows the object ID that a renderer uses to identify the audio object.

Export ADM File

Allows you to export your Dolby Atmos project as an ADM Broadcast Wave file according to the current settings in this window.

RELATED LINKS

[External Dolby Atmos Renderer Setup Dialog](#) on page 780

- [External OSC Renderer Setup Dialog](#) on page 789
- [Renderer for Dolby Atmos Plug-in Panel](#) on page 775
- [Trim and Downmix Editor](#) on page 784
- [Binaural Render Mode for Beds Dialog](#) on page 785
- [Object Group Editor Dialog](#) on page 786

Trim and Downmix Editor

The **Trim and Downmix Editor** dialog allows you to specify the trim and downmix settings for playing back your Dolby Atmos project.

The settings made in this editor are part of the static metadata in your Dolby Atmos project and are stored in the ADM file when exporting. A renderer uses these settings for playback or encoding.

NOTE

Static metadata for trimming and downmixing is not sent to an external Dolby Atmos Renderer in real time.

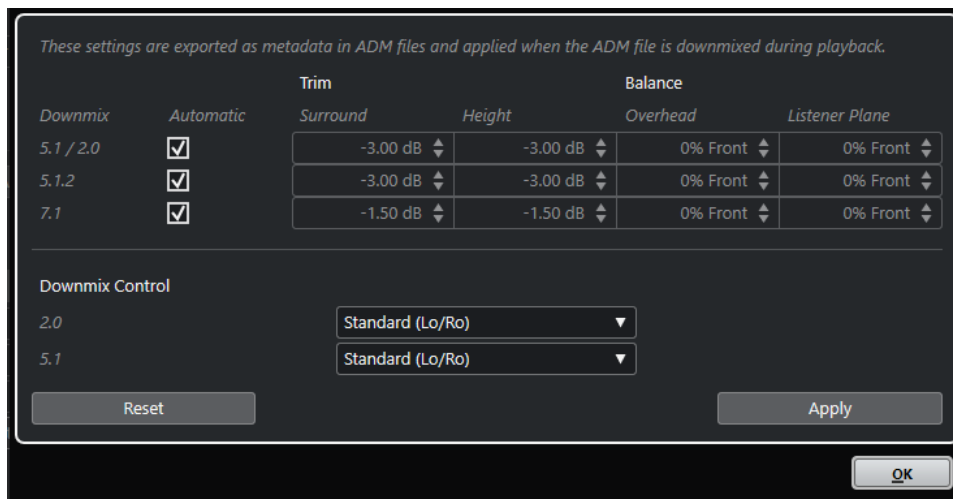

- To open this dialog, select **Trim and Downmix Editor** from the **Settings** pop-up menu in the **ADM Authoring for Dolby Atmos** window.

Trim and Balance Settings

In this section, you can make individual trim and balance settings for 5.1/2.0, 5.1.2, and 7.1 downmixes.

Automatic

If this option is activated, the default **Trim** and **Balance** values of the Dolby Atmos Renderer are used.

Trim (Surround/Height)

Allows you to lower the level for surround and height channels.

Balance (Overhead/Listener Plane)

Allows you to set the balance for overhead and listener plane.

Downmix Control Settings

In this section, you can specify the rendering mode for downmixes to 5.1 and 2.0 according to the specifications for Dolby Atmos.

2.0

Allows you to set a rendering mode for 2.0 downmixes from Dolby Atmos 5.1 downmixes.

5.1

Allows you to set a rendering mode for Dolby Atmos downmixes to 5.1.

Reset

Resets all trim, balance, and downmix settings to default.

Apply

Applies all trim, balance, and downmix settings.

NOTE

For details about object-based mixing for Dolby Atmos content, refer to the documentation that comes with the Dolby Atmos Mastering Suite.

RELATED LINKS

[ADM Authoring for Dolby Atmos Window](#) on page 782

Binaural Render Mode for Beds Dialog

The **Binaural Render Mode for Beds** dialog allows you to individually define the binaural render mode for each subchannel of a bed. These settings apply to all beds of your ADM.

NOTE

Static metadata for binaural rendering is stored in the ADM file when exporting but not sent to an external Dolby Atmos Renderer in real time.

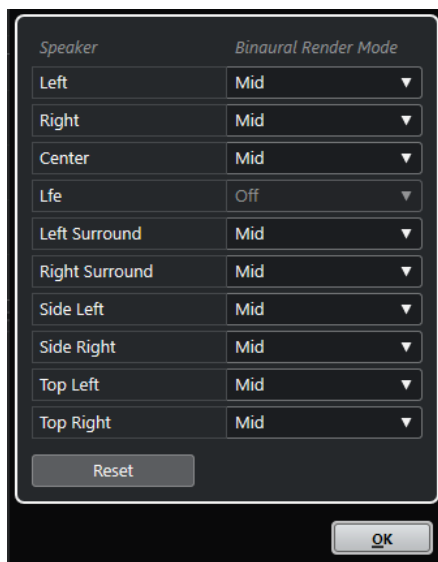

- To open this dialog, select **Binaural Render Mode for Beds** from the **Settings** pop-up menu in the **ADM Authoring for Dolby Atmos** window.

Speaker

Shows the bed channel.

Binaural Render Mode

Allows you to select a mode for binaural rendering or to deactivate it for the corresponding channel.

NOTE

For the LFE channel, binaural rendering is always deactivated.

Reset

Resets all **Binaural Render Mode** settings to default.

NOTE

For details about object-based mixing for Dolby Atmos content, refer to the documentation that comes with the Dolby Atmos Mastering Suite.

RELATED LINKS

[ADM Authoring for Dolby Atmos Window](#) on page 782

[Setting the Default Output Bus \(Main Mix\)](#) on page 35

Object Group Editor Dialog

The **Object Group Editor** dialog allows you to create and edit the groups that are available for objects and beds in the **ADM Authoring for Dolby Atmos** window.

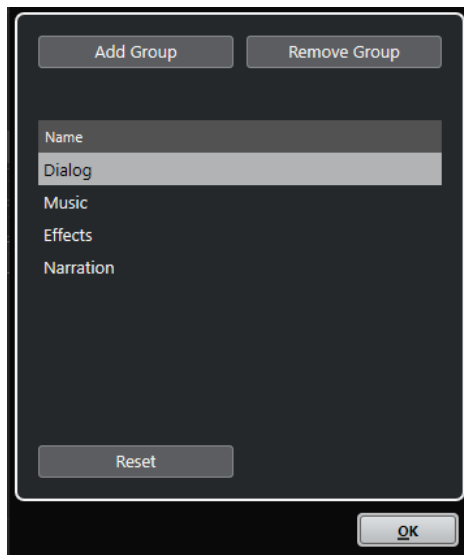

- To open this dialog, select **Object Group Editor** from the **Settings** pop-up menu in the **ADM Authoring for Dolby Atmos** window.

Add Group

Adds a new group to the list.

Remove Group

Removes selected groups from the list.

Group list

Shows all groups that are available in the **ADM Authoring for Dolby Atmos** window. To edit the name of a group, click it. To select multiple groups, **Ctrl/Cmd**-click or **Shift**-click them.

Reset

Resets the list to the default groups (**Dialog**, **Music**, **Effects**, and **Narration**).

RELATED LINKS

[ADM Authoring for Dolby Atmos Window](#) on page 782

Object Mixes with VST MultiPanner

When you select a track as source track for an object, its **VST MultiPanner** channel panner plug-in automatically switches to **Object Mode**.

When **VST MultiPanner** is used in **Object Mode**, the following applies:

- The plug-in panel offers additional settings and parameters for object-based mixing.
- The audio stream is sent directly to the renderer that is selected in the **ADM Authoring for Dolby Atmos** window.
- All object metadata, including the panning information, is directly sent to the renderer. Therefore, panning functions are always provided, regardless of the audio routing.

NOTE

If **VST MultiPanner** is used as an insert plug-in, **Object Mode** is not available.

NOTE

When using an external renderer, objects cannot be monitored within the **Control Room** of Nuendo. However, if you want to monitor the result of your object mix, you can route a 7.1 downmix from the Dolby Atmos Renderer to an external input of the **Control Room**.

RELATED LINKS

[VST MultiPanner](#) on page 747

[ADM Authoring for Dolby Atmos Window](#) on page 782

[Control Room](#) on page 479

[MixConvert 3D Downmix Rules](#) on page 768

VST MultiPanner Plug-in Panel in Object Mode

The **VST MultiPanner** plug-in panel offers additional settings and parameters for object-based mixing.

- To open the **VST MultiPanner** plug-in panel in a separate window, double-click a miniature view of **VST MultiPanner** in the **Inspector** or the **MixConsole**.



Select Object Bus

Allows you to connect the channel to an object bus if an external renderer is selected in the **ADM Authoring for Dolby Atmos** window. If the LED lights up in green, a valid

object bus is selected. If the LED lights up in red, at least one output bus of a selected multi-object bus is unmapped. To display a tooltip that shows which output busses are unmapped, move the mouse pointer over the LED.

Renderer

If the LED lights up in green, a renderer, for example the Dolby Atmos Renderer, is connected to the system. If the LED lights up in red, no renderer is connected.

Select Object Zone

Determines which speaker zones are active for the object. Active speaker zones are shown as small blue squares around the **Top View** pan field.

Active speaker zones are also shown in the miniature view in the **Inspector**.

Speaker Snap

Moves the object audio to the active speaker that is nearest to its established location during playback.

Object Size

Spreads the audio for an object in the room, based on the object position and the active speakers. This parameter is deactivated if **Speaker Snap** is activated.

NOTE

For details about object-based mixing for Dolby Atmos content, refer to the documentation that comes with the Dolby Atmos Mastering Suite.

RELATED LINKS

[VST MultiPanner](#) on page 747

Authoring and Mixing Object-Based Productions Using Open Sound Control (OSC)

Nuendo supports the recording, playback, and mixing of object-based live productions using the Open Sound Control (OSC) network protocol to control a renderer.

You can play back and record object-based audio and metadata at live performances, when connected to an OSC environment, for example, an OSC network using position tracking devices.

Nuendo can receive position data from tracking devices in the OSC network in normalized or absolute format, and writes automation data for **VST MultiPanner** along with the corresponding object audio being recorded.

ADM authoring and mixing for object-based productions using the OSC protocol involves the following features and functions:

- The **ADM Authoring for Dolby Atmos** window, where you must select **External OSC Renderer** as renderer. The list allows you to set up the object structure by adding objects.

NOTE

Unlike the creation of content for Dolby Atmos, the object structure of productions using the OSC protocol usually does not include channel-based beds. Also, the settings for trim and downmix and for binaural rendering only refer to authoring for Dolby Atmos content and are not applied in OSC context.

- The **External OSC Renderer Setup** dialog allows you to establish a connection to the OSC renderer in your network. In this dialog, you can define your audio objects by mapping audio outputs to object IDs. Mapped audio outputs that are connected to output busses in the **Audio Connections** window serve as your object busses.

- The **OSC Object Position Tracking** dialog allows you to activate and set up the reception of position data from tracking devices.
- The **VST MultiPanner** plug-in provides 3D panning for object audio.

RELATED LINKS

[Object Audio in Nuendo](#) on page 769

[Setup for Object-Based Audio in OSC Networks](#) on page 789

[External OSC Renderer Setup Dialog](#) on page 789

[OSC Object Position Tracking Dialog](#) on page 791

[Object Mixes with VST MultiPanner](#) on page 787

[VST MultiPanner Plug-in Panel in Object Mode](#) on page 787

Setup for Object-Based Audio in OSC Networks

When working with object-based audio in networks using the OSC protocol, you must connect your system to an OSC renderer and define audio tracks as objects in your project.

To define objects, you must first create object busses. In Nuendo, an object bus is an output bus that is connected to a device port, which in turn is mapped to an object ID.

The **External OSC Renderer Setup** dialog allows you to establish a connection to the external renderer and to define your audio objects by mapping audio outputs to object IDs. Mapped outputs that are connected to output busses in the **Audio Connections** window now serve as object busses in your OSC project.

The mapping is done in the **External OSC Renderer Setup** dialog first. We recommend that you use the **Auto-Connect Object Busses** option in the **ADM Authoring for Dolby Atmos** window afterwards when adding objects, which creates object busses automatically.

NOTE

For details about object mapping and using object busses, refer to the corresponding description for setting up projects with object-based content for Dolby Atmos.

RELATED LINKS

[Object Mapping for External Renderers](#) on page 777

[Object Busses](#) on page 778

[External OSC Renderer Setup Dialog](#) on page 789

[OSC Object Position Tracking Dialog](#) on page 791

External OSC Renderer Setup Dialog

The **External OSC Renderer Setup** dialog allows you to establish the connection to the external OSC renderer and to map the input ports of the renderer to ASIO output device ports of your system. Mapped device ports that are connected to output busses in the **Audio Connections** window serve as your object busses in your OSC project.

- To open the **External OSC Renderer Setup** dialog, select **Studio > External OSC Renderer Setup**.

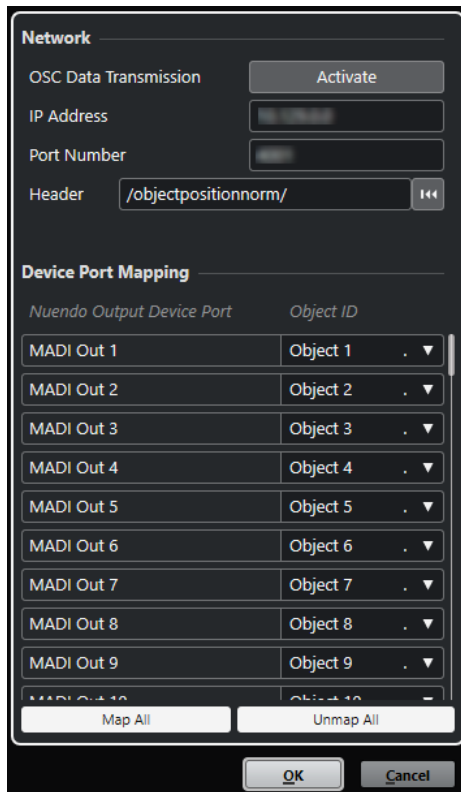

OSC Data Transmission

Activates/Deactivates the transmission of OSC data.

IP Address

Allows you to enter the IP network address of the OSC renderer.

Port Number

Allows you to enter the port number of the OSC renderer.

Header

Allows you to define the OSC message header. The reset button to the right allows you to reset the OSC message header to default.

Nuendo Output Device Port

Lists the available ASIO output device ports.

Object ID

Allows you to map your ASIO output device ports to input device ports of your renderer.

Map All

Maps all available ASIO output device ports to object IDs automatically.

Unmap All

Discards the mapping between all ASIO output device ports and object IDs.

NOTE

The last used connection to a renderer is saved. It is restored when you start the application.

OSC Object Position Tracking Dialog

In the **OSC Object Position Tracking** dialog, you can activate and set up how tracking devices in the OSC network receive position data.

- To open the **OSC Object Position Tracking** dialog, select **Studio > OSC Object Position Tracking**.

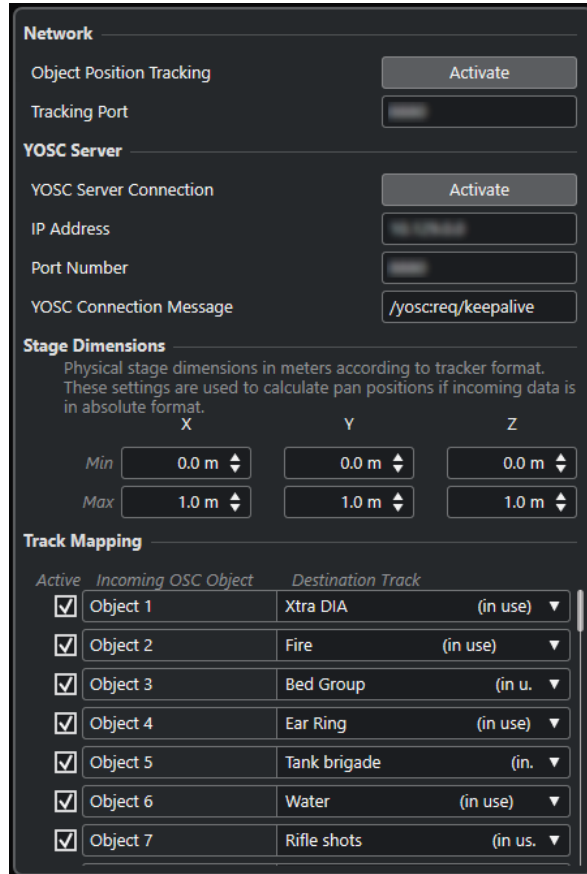

Object Position Tracking

Activates/Deactivates the reception of position tracking data.

Tracking Port

Allows you to enter the port number Nuendo uses to receive position tracking data.

YOSC Server Connection

Activates/Deactivates the visibility of Nuendo as client in the OSC network.

IP Address

Allows you to enter the IP address of the OSC server.

Port Number

Allows you to enter the port number the OSC server uses to send position tracking data.

YOSC Connection Message

Allows you to enter the connection message that is added to the OSC data header. This parameter is necessary to register Nuendo as client on the OSC server.

Stage Dimensions

Allows you to enter the physical stage dimensions in meters for tracking systems that send position data in absolute format. If incoming position data is in absolute format,

these settings are used to convert it to normalized format. If incoming position data is already normalized, these settings are ignored.

Active

Activates/Deactivates the processing of position tracking data for the corresponding OSC object.

Incoming OSC Object

Lists the OSC object IDs that are received from the OSC server.

Destination Track

Allows you to map audio tracks in your project to OSC object IDs.

Ambisonics Mixes

Nuendo allows you to create 3D mixes in Ambisonics format for virtual reality (VR) or augmented reality (AR) content. You can use the integrated functions and plug-ins for spatial mixing or head-tracking monitoring, or use dedicated third-party plug-ins.

Ambisonics is a technology that creates a spherical sound field. In contrast to traditional immersive sound formats, it is not channel-based but utilizes an encoded bundle of multiple audio signals that allows you to place sound sources at any position in the sound sphere.

Nuendo supports first-order, second-order, and third-order Ambisonics. These formats differ in the number of audio signals that are used. Higher-order Ambisonics provide more signals and allow for a higher positioning precision.

To play back the sound sphere, the signals of an Ambisonics file must be decoded. You can play back the sound sphere in the following ways:

- Using headphones and binaural decoding.
Using a properly matched head-related transfer function (HRTF) configuration creates a realistic, full spherical 360° sound field. The sound is perceived even more realistically if the binaural encoding takes the head movements of the listener into account using head-tracking technology.
- Using a stereo or multi-channel speaker setup.
The more spherical the speaker setup, the more precise the positioning. However, the sphere can be projected on a 5.1.4 channel configuration, for example.

When working with Ambisonics audio in Nuendo, the following applies:

- You can record from an Ambisonics-capable microphone system.
- You can import pre-produced Ambisonics files in WAV format.
- You can edit Ambisonics events like any other audio in the **Project** window, the **Sample Editor**, or the **Direct Offline Processing** window, for example. All signals of an Ambisonics file are edited simultaneously.

NOTE

Not every editing operation is suited for Ambisonics audio. For example, avoid operations that change the phase and levels of the audio signals against each other.

- The **VST AmbiDecoder** plug-in decodes Ambisonics audio for monitoring on your headphones or loudspeaker system. When monitoring via the **Phones** channel, Ambisonics audio is automatically decoded for binaural stereo.
- If **VST AmbiDecoder** is used as channel panner for Ambisonics channels, you can adjust the rotation angles and focus settings when mixing Ambisonics audio. This allows you, for example, to emphasize the sound that comes from the viewing direction when using a VR controller with head-tracking or to re-balance the sound field of premixed Ambisonics audio.

- You can use **VST MultiPanner** to create Ambisonics mixes from mono, stereo, or multi-channel sources. To use **VST MultiPanner** in Ambisonics mode, you must route the signal to a group track or an output bus in Ambisonics format.
- Cue sends do not work for Ambisonics channels.
- Nuendo can use tracking data from external VR controller devices like head-mounted displays or 3D mouse devices to change the listening direction. This allows for realistic monitoring of 360° mixes.
For background music tracks that must not be affected by head movements, you can bypass the tracking by sending a head-locked signal via side-chain.
- Nuendo only supports AmbiX format. You can use the **VST AmbiConverter** insert plug-in to convert between Furse-Malham (FuMa) and AmbiX format.
- You can preview Ambisonics audio in the **MediaBay**, the **Pool**, in the **Direct Offline Processing** window, or the file import dialog if your project is set up for playing back Ambisonics audio.
- You can use dedicated third-party Ambisonics plug-ins for mixing, converting, head-tracking, or binauralization.

NOTE

- We recommend that you use only VST 3 Ambisonics plug-ins to ensure a correct channel routing.
 - If you use an Ambisonics panner that is only suited as insert plug-in, all audio channels in the mix must be in Ambisonics format, even if they only contain mono or stereo audio.
 - For details on how to use a third-party plug-in, refer to the documentation that comes with it.
-

RELATED LINKS

- [Channel Routing for Ambisonics Mixes](#) on page 793
- [Playback of Ambisonics Audio](#) on page 795
- [VST AmbiDecoder Panel](#) on page 795
- [Monitoring a Head-Locked Signal in VST AmbiDecoder](#) on page 801
- [VST AmbiConverter Panel](#) on page 804

Channel Routing for Ambisonics Mixes

You can route any channel to an Ambisonics channel.

Which channel configurations are allowed in an Ambisonics mix depends on the position of the Ambisonics panner plug-in in the signal path:

- If you use the panner plug-in as a channel panner in the **MixConsole**, you can use any audio channel format.
- If you use the panner as an insert plug-in, all audio channels in the mix must be in Ambisonics format, even if they only contain mono or stereo audio.

NOTE

Cue sends do not work for Ambisonics channels.

RELATED LINKS

- [Available Surround Channel Configurations](#) on page 741
- [Switching the Channel Panner](#) on page 764

VST MultiPanner Plug-in Panel in Ambisonics Mode

The **VST MultiPanner** plug-in panel offers additional settings and parameters for Ambisonics mixing.

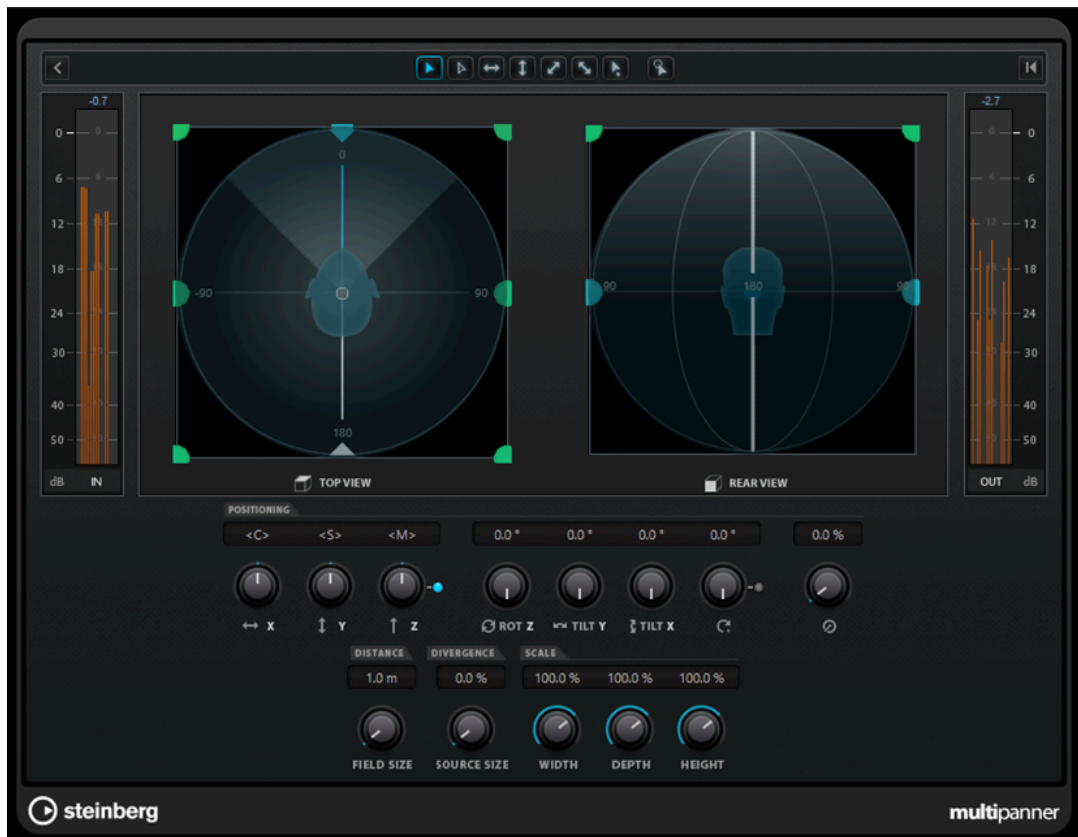

- To use **VST MultiPanner** in Ambisonics mode for an audio channel, you must route the channel to an output bus in Ambisonics format.

Show/Hide Extended Display

Shows/Hides the **Rear View** pan area.

Top View/Rear View

Shows the sound field from the top and the rear, and allows you to position the sound source by dragging the panning handles. The orientation is bound to the head-tracking viewing angle. This means, what you see in front of you when using a VR display is also in front of the head symbol in both views.

Field Size

Sets the perceived size of the sound field. It is indicated by the size of the head symbol in **Top View** and **Rear View**. The smaller the size, the bigger the distance between listener and sound source. The volume of the sound is attenuated accordingly. Moving the mouse pointer over the scale knob displays the simulated distance in meters in both panning views.

Source Size

Spreads the source audio in the sound field by making it more diffuse.

RELATED LINKS

[VST MultiPanner Plug-in Panel](#) on page 748

Playback of Ambisonics Audio

Nuendo allows you to decode Ambisonics audio for monitoring via headphones or speakers. For decoding, you can use **VST AmbiDecoder** or suitable third-party decoder plug-ins.

When working with **VST AmbiDecoder**, the following applies:

- In the **Control Room Phones** channel, **VST AmbiDecoder** is automatically used for decoding Ambisonics audio. Alternatively, you can use suited third-party decoder plug-ins.
- In the **Control Room Main** channel, **VST AmbiDecoder** is automatically used for decoding Ambisonics audio.
- You can use third-party Ambisonics decoders as insert plug-ins in the **Control Room Main** channel.
- **VST AmbiDecoder** allows you to send a head-locked signal into your monitor mix via side-chain.

NOTE

To monitor your Ambisonics project, an output bus in Ambisonics format must be set as **Main Mix**.

VST AmbiDecoder supports the following output channel configurations:

- Mono
- Stereo
- 5.0
- 5.1
- 7.1
- 7.1.2
- 5.1.4
- 7.1.4
- 10.1 Auro-3D
- 22.2

RELATED LINKS

[Setting the Default Output Bus \(Main Mix\) on page 35](#)

[Monitoring Ambisonics Audio Binaurally via the Phones Channel on page 799](#)

[Monitoring Ambisonics Audio Binaurally Using Third-Party Insert Plug-ins on page 800](#)

[Monitoring Ambisonics Audio via a Stereo or Multi-Channel Speaker Setup on page 800](#)

[Monitoring a Head-Locked Signal in VST AmbiDecoder on page 801](#)

[Available Surround Channel Configurations on page 741](#)

VST AmbiDecoder Panel

The **VST AmbiDecoder** plug-in converts Ambisonics audio for playback on headphones or stereo and multi-channel speaker setups. It is used automatically in the **Control Room Phones** and

Control Room Main channels, and can also be used as an insert plug-in for mixing Ambisonics channels.



Input Format > Output Format

Shows the audio formats of the input and output signals.

Output

Allows you to select between **Headphones** mode for binaural playback via headphones or **Speakers** mode for playback via a stereo speaker setup.

HRTF Mode

Allows you to set the head-related transfer function (HRTF) mode for binaural playback. This option is only available in **Headphones** mode.

The following HRTF modes are available:

- **Standard** mode uses the standard HRTF algorithm of Nuendo.
- **Facebook** mode uses the HRTF algorithm that is used for VR video playback at [facebook.com](https://www.facebook.com).
The availability of this mode depends on the Ambisonics order of the **Main Mix** bus.
- **YouTube** mode uses the HRTF algorithm that is used for VR video playback at [youtube.com](https://www.youtube.com).
The availability of this mode depends on the Ambisonics order of the **Main Mix** bus.
- **SOFA** mode allows you to use an HRTF saved in SOFA file format.
This mode is only available if you have loaded a SOFA file. To select a SOFA file, click the triangle on the right of the **SOFA** button.
- **IMMERSE** mode allows you to use HRTF profiles with the **IMMERSE with VST AmbiDecoder** application.
To select an IMMERSE profile or check for profile updates, click the triangle on the right of the **IMMERSE** button.

This mode requires a valid license of **IMMERSE with VST AmbiDecoder**. For details on how to get a license and use the application, visit steinberg.net.

NOTE

The HRTF settings are only available if **VST AmbiDecoder** is used in the **Phones** channel of the **Control Room** and if the binaural **Headphones** output mode is selected.

Head Tracking

If this button is activated, **VST AmbiDecoder** receives head-tracking data from the **Head Tracking** window. If this button is deactivated, you can use the **Yaw**, **Pitch**, and **Roll** controls on the **VST AmbiDecoder** panel for setting the rotation angles.

Yaw

Sets the yaw rotation angle.

Pitch

Sets the pitch rotation angle.

Roll

Sets the roll rotation angle.

Head-Locked Signal

Sets the gain of the head-locked signal that is sent into the side-chain input of **VST AmbiDecoder**.

Front Focus

Activates/Deactivates the emphasis of a defined sector of the Ambisonics sphere.

Off-Focus

Sets the attenuation of sound that is located out of the **Front Focus** sector.

Size

Sets the **Front Focus** angle, that is, the sector of the Ambisonics sphere that is not attenuated by the amount of the **Off-Focus** value.

Follow Head

If this option is activated, **Front Focus** follows the settings in the **Head Tracking** section above. This allows you, for example, to emphasize the sound that comes from the viewing direction when using a VR controller with head-tracking.

If deactivated, you can control **Azimuth** and **Elevation** manually. This allows you, for example, to re-balance the sound field of premixed Ambisonics audio.

Azimuth

Sets the azimuth angle of the **Front Focus** range. This parameter is only available if **Follow Head** is deactivated.

Elevation

Sets the elevation angle of the **Front Focus** range. This parameter is only available if **Follow Head** is deactivated.

RELATED LINKS

[Head Tracking Window](#) on page 798

[Monitoring a Head-Locked Signal in VST AmbiDecoder](#) on page 801

Head-Tracking Data from VR Controller Devices

Nuendo can receive tracking data from external VR controller devices like head-mounted displays or 3D mouse devices.

When using head-tracking data while monitoring an Ambisonics mix, the following applies:

- Movements of the head or with a 3D mouse are acoustically replicated in real time.
- In **VST MultiPanner**, the Ambisonics mode pan views rotate in sync with the audible front.
- The tracking data is transmitted to the VR video player and the 360° video is panned accordingly.

NOTE

For this to work, you must connect the VR player to Nuendo and activate **Send Head-Tracking Data** in the **GoPro VR Player Remote** window.

RELATED LINKS

[Head Tracking Window](#) on page 798

[VST MultiPanner Plug-in Panel in Ambisonics Mode](#) on page 794

[360° Video Playback](#) on page 802

[GoPro VR Player Remote Window](#) on page 802

Head Tracking Window

In the **Head Tracking** window, you can set up Nuendo for receiving positioning data from an external VR controller device. Alternatively, you can control the rotation angles manually.



- To open the **Head Tracking** window, select **Project > Head Tracking**.

Yaw

Sets the yaw rotation angle.

Pitch

Sets the pitch rotation angle.

Roll

Sets the roll rotation angle.

Reset

Resets all rotation angles.

Tracking Source

Allows you to select a source for positioning data. Select **Manual** to control head tracking via the **Yaw**, **Pitch**, and **Roll** controls. Select **VR Controller** to receive data from an external VR device.

VR Controller Type

Allows you to select the type of the connected VR controller device.

VR controller device information



Moving the mouse pointer over this field provides information about the connected VR controller device.

Tracking

Enables/Disables the transmission of head-tracking data to the VR player.

Calibrate Yaw

Defines the current yaw rotation angle as center.

Monitoring Ambisonics Audio Binaurally via the Phones Channel

The **Control Room Phones** channel allows you to listen to Ambisonics audio binaurally via headphones, automatically using **VST AmbiDecoder** for decoding.

PREREQUISITE

- In the **Audio Connections** window, you have set an Ambisonics output bus as main mix and enabled the **Control Room**.
- For the audio preview function to work, you must activate **Use Phones Channel as Preview Channel** in the **Preferences** dialog on the **VST - Control Room** page.

PROCEDURE

1. In the **MixConsole**, route your audio tracks to the Ambisonics output bus.
2. Click **Open/Close Ambisonics Decoder**.

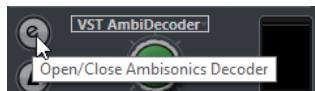

3. On the **VST AmbiDecoder** panel, select **Headphones** as output.
4. Make your changes for the **HRTF Mode**.

RESULT

You can play back Ambisonics audio binaurally via headphones.

NOTE

Instead of **VST AmbiDecoder**, you can also use third-party binaural decoding plug-ins that are suited for use within the **Control Room Phones** channel. Select the decoder from the pop-up menu in the **Control Room Phones** section.

RELATED LINKS

- [Inputs/Outputs Tab](#) on page 28
- [Setting the Default Output Bus \(Main Mix\)](#) on page 35
- [Control Room Tab](#) on page 32
- [VST - Control Room](#) on page 1380
- [VST AmbiDecoder Panel](#) on page 795

Monitoring Ambisonics Audio Binaurally Using Third-Party Insert Plug-ins

Third-party Ambisonics plug-ins for binaural decoding that are not suited for use within the **Control Room Phones** channel can be used as insert plug-ins in the **Main** channel instead.

PREREQUISITE

In the **Audio Connections** window, you have done the following:

- You have set an Ambisonics output bus as main mix.
- You have enabled the **Control Room**.
- For the **Control Room Monitor** channel, you have selected the correct device port to send the signal to your headphones.

NOTE

For details on how to use a third-party Ambisonics decoder plug-in, refer to the documentation that comes with it.

PROCEDURE

1. In the **MixConsole**, route your audio tracks to the Ambisonics output bus.
 2. In the **Downmix Presets** section of the **Control Room**, select a preset with the same Ambisonics format as the main mix.
 3. In the **Channels** section, disable **Head Tracking** on the miniature view of **VST AmbiDecoder**.
 4. In the **Main** channel of the **Control Room**, insert the Ambisonics decoder plug-in.
-

RESULT

You can play back Ambisonics audio binaurally via the **Control Room Main** channel.

RELATED LINKS

[Available Surround Channel Configurations](#) on page 741

[Control Room Tab](#) on page 32

[Inputs/Outputs Tab](#) on page 28

[Setting the Default Output Bus \(Main Mix\)](#) on page 35

[Insert Effects](#) on page 490

Monitoring Ambisonics Audio via a Stereo or Multi-Channel Speaker Setup

The **Control Room Main** channel allows you to listen to Ambisonics audio via a stereo or multi-channel speaker setup. For decoding Ambisonics audio to a stereo or multi-channel format, the **Main** channel automatically uses **VST AmbiDecoder**.

PREREQUISITE

- You use a stereo or multi-channel studio monitor system.

NOTE

The more spherical the speaker setup, the more precise the positioning. However, the sphere can be projected on a 5.1.4 channel configuration, for example.

- In the **Audio Connections** window, you have set an Ambisonics output bus as main mix, and enabled the **Control Room**.
-

PROCEDURE

1. In the **MixConsole**, route your audio tracks to the Ambisonics output bus.

2. In the **Downmix Presets** section of the **Control Room**, select the preset that matches your speaker setup.
 3. In the **Channels** section, make your changes on the miniature view of **VST AmbiDecoder** or double-click it to open the plug-in panel.
 4. For stereo playback, select **Speakers** as output.
-

RESULT

You can listen to Ambisonics audio via your stereo or multi-channel speaker setup.

RELATED LINKS

[Inputs/Outputs Tab](#) on page 28

[Setting the Default Output Bus \(Main Mix\)](#) on page 35

[Control Room Tab](#) on page 32

[Downmix Presets](#) on page 486

[Playback of Ambisonics Audio](#) on page 795

[Control Room Channel](#) on page 487

Monitoring a Head-Locked Signal in VST AmbiDecoder

You may not want some audio, for example, background music tracks, to be affected by head movements. **VST AmbiDecoder** allows you to bypass tracking by sending a head-locked signal via side-chain.

PREREQUISITE

In the **Audio Connections** window, you have set an Ambisonics output bus as main mix and enabled the **Control Room**.

PROCEDURE

1. In your project, create a stereo or multi-channel group track and route your background music tracks to this group.
 2. Route the output of the group track to the side-chain input of **VST AmbiDecoder**.
 3. On the **VST AmbiDecoder** panel, right-click and select **Activate/Deactivate Side-Chain Inputs**.
 4. Set **Head-Locked Signal** to the required gain.
-

RESULT

You can listen to decoded Ambisonics audio and your music tracks via the **Control Room**. The music tracks are not affected by head-tracking data that Nuendo receives from a VR controller.

NOTE

When listening to Ambisonics audio via speakers, the head-locked signal is added after the **Control Room** volume control. Use **Control Room Level** and **Head-Locked Signal** to retain a proper balance between Ambisonics mix and head-locked signal.

RELATED LINKS

[Head Tracking Window](#) on page 798

[VST AmbiDecoder Panel](#) on page 795

360° Video Playback

For playing back 360° videos, Nuendo can use the Kolor GoPro VR player. The player can run locally or on another computer connected via network.

You can remote-control GoPro VR Player with Nuendo using the **GoPro VR Player Remote** function. It allows you to control the GoPro VR Player transport and to send head-tracking data to the player.

NOTE

- The minimum required version of GoPro VR Player is version 3.0. You can download the latest version at <http://www.kolor.com/gopro-vr-player/download/>.
- For details on how to use GoPro VR Player, refer to the documentation that comes with it.

RELATED LINKS

[GoPro VR Player Remote Window](#) on page 802

[Connecting Nuendo to GoPro VR Player](#) on page 803

GoPro VR Player Remote Window

GoPro VR Player Remote allows Nuendo to control the transport and viewing angle of GoPro VR Player.

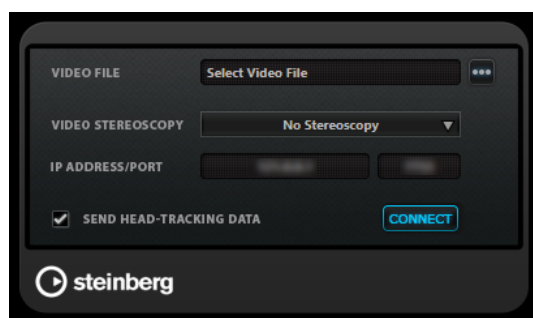

- To open the **GoPro VR Player Remote** window, select **Project > GoPro VR Player Remote**.

Video File

Shows the selected video file for playback in GoPro VR Player.

Select Video File

Allows you to select a video file that is located on your local computer or on a remote computer in your network.

Video Stereoscopy

Allows you to select the stereoscopy format of the selected video file.

IP Address/Port

Allows you to enter the IP address of the host computer running GoPro VR Player and the UDP port GoPro VR Player is listening to.

Send Head-Tracking Data

Enables Nuendo to transmit head-tracking data from an external VR controller device to GoPro VR Player.

Connect

Connects Nuendo to GoPro VR Player.

Connecting Nuendo to GoPro VR Player

This example shows you how to connect Nuendo to GoPro VR Player version 3.0.5.

PREREQUISITE

You have downloaded GoPro VR Player version 3.0.5 from <http://www.kolor.com/gopro-vr-player/download/> and installed it on your local computer or on another computer in your network.

PROCEDURE

1. In GoPro VR Player, select **File > Preferences**.
2. On the **Video Decoding** page, select **Windows Media Foundation** as **Backend**.
3. On the **Primary/Secondary** page, select **Secondary** as **Communication Mode**.
4. On the **Controllers** page, change the settings for **Head-Mounted Display SDK** as required.
In most cases, **Auto** mode is suitable.
5. Close the GoPro VR Player preferences menu.
6. In Nuendo, select **Project > GoPro VR Player Remote**.
7. In the **GoPro VR Player Remote** window, click **Select Video File**, and select the video file in the file dialog.
This allows Nuendo to remote-control GoPro VR Player. The file selection is saved in your Nuendo project.

NOTE

If the video file is located on a remote computer in your network that you cannot access through the file dialog, you can click the video file field and manually enter the full file path.

-
8. Select the **Video Stereoscopy** format of the selected video file.
 9. Enter the **IP Address/Port** of the computer where the GoPro VR Player is running.
By default, **IP Address/Port** is set to the local computer.
 10. Optional: If no head-mounted display is used, activate **Send Head-Tracking Data**.
This allows you to send tracking information from the **Head Tracking** window to GoPro VR Player.
 11. Activate **Connect** to sync the transport of GoPro VR Player with Nuendo.

RESULT

GoPro VR Player is controlled by the transport of Nuendo and head-tracking data that is sent from a VR controller connected to your system.

Ambisonics Audio Export

You can create Ambisonics files from Ambisonics tracks using the **Export Audio Mixdown** function.

The following applies:

- Use only file formats that are suited for Ambisonics audio. We recommend that you only create Ambisonics files in WAV format.
- Before exporting, make sure that you only use Ambisonics decoding plug-ins in the **Control Room** but not in the channel inserts.
- Even though the resulting files look like multi-channel WAV files, they must be played back with a dedicated Ambisonics player or converted into another platform-specific format using an external application.

- Head-locked signals must be exported from a separate output bus. You can export from multiple busses at once.

RELATED LINKS

[Export Audio Mixdown](#) on page 1162

[Mixing Down to Audio Files](#) on page 1171

[Monitoring a Head-Locked Signal in VST AmbiDecoder](#) on page 801

VST AmbiConverter Panel

When working with Ambisonics audio, Nuendo supports AmbiX format only. The **VST AmbiConverter** plug-in allows you to convert Ambisonics audio between Furse-Malham (FuMa) and AmbiX format.

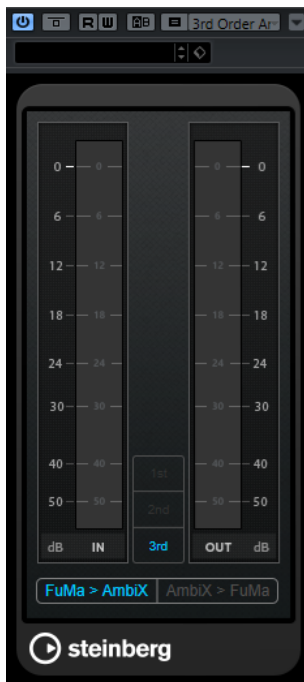

Input level meter

Shows the input level for all speaker channels.

Ambisonics format display

Shows the order of the Ambisonics audio format.

Output level meter

Shows the output level for all speaker channels.

FuMa > AmbiX

Converts audio from FuMa to AmbiX format.

AmbiX > FuMA

Converts audio from AmbiX to FuMa format.

Automation

In essence, automation means recording the values for a particular **MixConsole** or effect parameter. When you create your final mix, Nuendo can adjust this particular parameter control.

Automation Curves

Within a Nuendo project, the changes in a parameter value over time are reflected as curves on automation tracks.

There are different kinds of automation curves:



1 Ramp curves

Ramp curves are created for any parameter that generates continuous multiple values, such as fader or encoder movements.

2 Step curves

Step curves are created for on/off parameters, such as mute.

Static Value Line

When you open an automation track for the first time, it does not contain any automation events. This is reflected in the event display as a dotted horizontal line, the static value line. This line represents the current parameter setting.

If you manually added any automation events or used write automation for the corresponding parameter and then disable the reading of automation data, the automation curve is grayed out in the event display and the static value line is used instead.

As soon as **Read** is enabled, the automation curve is used.

Write/Read Automation

You can automation-enable tracks and **MixConsole** channels by activating their automation write **W** and read **R** buttons.

- If you activate **W** for a channel, virtually all **MixConsole** parameters that you adjust during playback for that specific channel are recorded as automation events.
- If **R** is activated for a channel, all your recorded **MixConsole** actions for that channel are performed during playback.

The **R** and **W** buttons for a track in the track list are the same as the **R** and **W** buttons in the **MixConsole**.

NOTE

R is automatically enabled when you enable **W**. This allows Nuendo to read existing automation data at any time. You can separately deactivate **W** if you only want to read existing data.

There are also global read and write indicator buttons **Activate/Deactivate Read/Write for All Tracks** on the **Project** window toolbar and the **MixConsole** toolbar. These buttons light up as soon as there is an enabled **R** or **W** button on any channel/track within your project. Furthermore, they can be clicked to activate or deactivate **R/W** of all tracks simultaneously.

NOTE

R/W are also available on the **Automation Panel**.

RELATED LINKS

[Read/Write/Suspend Buttons](#) on page 818

Writing Automation Data

You can create automation curves manually or automatically.

- Manual writing makes it easy to quickly change parameter values at specific points without having to activate playback.
- Automatic writing lets you work almost as if you were using a real mixer.

With both methods, any applied automation data is reflected in both the **MixConsole** by a moved fader, for example, and in the corresponding automation track curve.

RELATED LINKS

[Manual Writing of Automation Data](#) on page 807

Automatic Writing of Automation Data

Every action that you perform is automatically recorded on automation tracks which you can later open for viewing and editing.

PROCEDURE

1. In the track list, click **Show/Hide Automation** for a track to open its automation track.

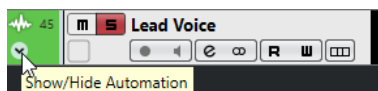

2. Click **W** to enable the writing of automation data on this track.
 3. Start playback.
 4. Adjust the parameters in the **MixConsole**, in the **Channel Settings** window, or on the effect control panel.
The value settings are recorded and displayed as a curve on the automation tracks. When automation data is being written, the color of the automation track changes and the delta indicator in the automation track shows the relative amount by which the new parameter setting deviates from any previously automated value.
 5. Stop playback and return to the position where you started playback.
 6. Click **W** to disable the writing of automation data.
 7. Start playback.
-

RESULT

All actions that you recorded are reproduced exactly. When you drag a plug-in to a different insert slot on the same channel, any existing automation data moves with the plug-in. When you drag it to an insert slot on a different channel, any existing automation data is not transferred to the new channel.

Manual Writing of Automation Data

You can add automation events manually by drawing automation curves on an automation track.

PROCEDURE

1. In the track list, click **Show/Hide Automation** for a track to open its automation track.

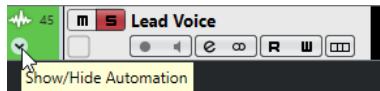

2. Click the automation parameter name and select the parameter from the pop-up menu.
3. Select the **Draw** tool.
4. Click on the static value line.

An automation event is added, read automation mode is automatically activated, and the static value line changes to a colored automation curve.

5. Click and hold to draw a curve by adding many automation events.
When you release the mouse button, the number of automation events is reduced.

NOTE

To adjust the thinning out of events, open the **Automation Panel**, open the **Settings** page, and enter a value for **Reduction Level**.

6. Start playback.
-

RESULT

The automated parameter changes with the automation curve, and the corresponding fader in the **MixConsole** moves accordingly.

AFTER COMPLETING THIS TASK

Repeat the procedure if you are not happy with the result. If you draw over existing events, a new curve is created.

Tools for Drawing Automation Data

Apart from the **Draw** tool, you can use the **Object Selection** tool and the **Line** tool to draw automation events. If you click with any of these tools on the automation track, **R** is activated automatically.

- **Object Selection**

If you click on an automation track with the **Object Selection** tool, an automation event is added. If you hold down **Alt/Opt**, you can draw several automation events.

NOTE

Events that are introduced between existing events and do not deviate from the existing curve are removed as soon as you release the mouse button.

To activate the **Line** tool in any other available mode, click the **Line** tool and click again to open a pop-up menu where you can select the **Line** tool mode.

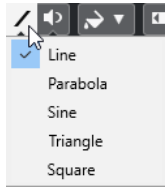

The following **Line** tool modes are available:

Line

If you click on the automation track and drag with the **Line** tool in **Line** mode, you can create automation events in a line. This is a quick way to create linear fades, etc.

Parabola

If you click and drag on the automation track with the **Line** tool in **Parabola** mode, you can create more natural curves and fades.

NOTE

The result depends on the direction from which you draw the parabolic curve.

Sine/Triangle/Square

If you click and drag on the automation track with the **Line** tool in **Sine**, **Triangle**, or **Square** mode and the **Snap Type** is set to **Grid**, the period of the curve, that is, the length of one curve cycle, is determined by the grid setting. If you press **Shift** and drag, you can set the period length manually, in multiples of the grid value.

NOTE

The **Line** tool can only be used for ramp type automation curves.

Editing Automation Events

Automation events can be edited much like other events.

NOTE

If you move an event or part on a track and you want the automation events to follow automatically, select **Edit > Automation Follows Events**. Any automation events at the new position are overwritten.

- You can use the tools on the **Project** window toolbar to edit automation events.
- You can use the automation event editor to edit selected automation events on ramp automation curves.

RELATED LINKS

[Project Window Toolbar](#) on page 48

[Automation Event Editor](#) on page 810

Creating Smooth Transitions Between Automation Events (Bézier Automation Curves)

Nuendo supports bézier automation curves that allow you to create smooth transitions between automation events. This way, you can edit linear ramp curves with much more precision, flexibility, and intuition.

PREREQUISITE

The **Object Selection** tool is active.

PROCEDURE

1. Move the mouse pointer on the linear ramp curve segment that you want to edit. A handle is shown on the curve segment.



NOTE

If the automation events are next to each other on an almost horizontal or vertical line, or if they are too close to each other, the handle is not available.

2. Click and drag with the mouse button pressed to modify the shape of the curve segment.



3. When you are satisfied with the result, release the mouse button.
-

RESULT

A smooth transition curve according to your edits is created.

If you are not satisfied with the result and want to start over again from the original linear curve segment, double-click the handle.

You can use bézier automation curves with tracks that are connected to VCA faders.

AFTER COMPLETING THIS TASK

For even more precise editing, add new automation events to your bézier curve segment.



This creates new segments that you can smoothen.



RELATED LINKS

[VCA Fader Settings](#) on page 474

[VCA Fader Automation](#) on page 476

Selecting Automation Events

- To select an automation event, click it with the **Object Selection** tool.
- To select multiple events, drag a selection rectangle with the **Object Selection** tool or **Shift**-click the events.

- To select multiple events, select a range with the **Range Selection** tool or **Shift**-click the events.
- To select all automation events on an automation track, right-click the automation track and select **Select All Events** from the context menu.

Selected events are indicated by a dark color.

NOTE

If you select several events of a ramp automation curve, the automation event editor becomes available.

RELATED LINKS

[Automation Event Editor](#) on page 810

Automation Event Editor

The automation event editor allows you to edit selected events on the automation track. The automation event editor is only available for automation ramp curves.

NOTE

All editing in the automation event editor only affects the automation events that are part of the selection.

To open the automation event editor, do one of the following:

- Activate the **Object Selection** tool and drag a selection rectangle on a ramp type automation track.
- Activate the **Range Selection** tool and select a range on a ramp type automation track.

NOTE

If you work with the **Range Selection** tool, the smart control for **Stretch** is not available.

The automation event editor features the following smart controls for specific editing modes:

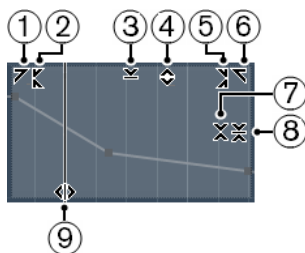

1 Tilt Left

If you click in the upper left corner of the editor, you can tilt the left part of the curve. This allows you to tilt the event values at the start of the curve upwards or downwards.

2 Compress Left

If you **Alt/Opt**-click in the upper left corner of the editor, you can compress or expand the left part of the curve. This allows you to compress or expand the event values at the start of the curve.

3 Scale Vertically

If you click in the middle of the upper border of the editor, you can scale the curve vertically. This allows you to raise or lower the event values of the curve in percent.

4 Move Vertically

If you click on the upper border of the editor, you can move the entire curve vertically. This allows you to raise or lower the values of the event values of the curve.

5 Compress Right

If you **Alt/Opt**-click in the upper right corner of the editor, you can compress or expand the right part of the curve. This allows you to compress or expand the event values at the end of the curve.

6 Tilt Right

If you click in the upper right corner of the editor, you can tilt the right part of the curve. This allows you to tilt the event values at the end of the curve upwards or downwards.

7 Scale Around Relative Center

If you **Alt/Opt**-click in the middle right border of the editor, you can scale the curve relative to its center. This allows you to raise or lower the event values horizontally around the center of the editor.

8 Scale Around Absolute Center

If you click in the middle right corner of the editor, you can scale the curve absolute to its center. This allows you to raise or lower the event values horizontally around the center of the editor.

9 Stretch

If you click on the lower border of the editor, you can stretch the curve horizontally. This allows you to move the event values of the curve to the left or to the right.

NOTE

To edit the automation curves on several tracks simultaneously, select the automation events using the **Object Selection** tool or the **Range Selection** tool on the corresponding automation tracks, and hold down **Ctrl/Cmd** while using the smart controls.

NOTE

If you select automation events using the **Range Selection** tool, additional automation events are automatically created at the start and the end of the selection. This ensures that the entire selection is edited.

RELATED LINKS

[Automation Curves](#) on page 805

Quick Vertical Scaling of Automation Events

You can scale the curve segment between two automation events vertically without any need to select the events first.

PROCEDURE

1. Move the mouse pointer to the upper border of the automation track above the linear ramp curve segment that you want to scale.

A handle is shown.



2. Click and drag up or down with the mouse button pressed.
 3. When you are satisfied with the result, release the mouse button.
-

RESULT

The curve segment between the two automation events is scaled.

Moving Automation Events

Moving Single Automation Events

- To move a selected automation event, click it and drag to the left or to the right.
- To restrict the direction of the movement, press **Ctrl/Cmd** and drag.

NOTE

Snap is taken into account when you move automation curves horizontally. To turn it off temporarily, hold down **Ctrl/Cmd** and any other modifier, and drag.

Moving Multiple Automation Events

- To move a selection of automation events, click inside the selection rectangle and drag to the left or to the right.
If you made a continuous selection of automation events, events at the destination range are overwritten. However, if you move the same selection range past already existing events, they appear again. If a selection range contains automation events that are deselected, dragging is restricted. You cannot move this selection past existing events.
- To copy a continuous selection of automation events, click inside the selection rectangle, hold down **Alt/Opt**, and drag to the left or to the right.

NOTE

If you press **Esc** while dragging the selection rectangle, the selection jumps back to its original position.

RELATED LINKS

[Selecting Automation Events](#) on page 809

Removing Automation Events

- To remove an automation event, click on it with the **Erase** tool.
- To remove multiple automation events, select them and press **Backspace** or **Delete** or select **Edit > Delete**.
- If **Use Virgin Territory** is enabled, this creates a gap. When disabled, the events within the range are removed.
- To remove all automation events from the automation track and close the automation track, click the automation parameter name in the track list and select **Remove Parameter** from the pop-up menu.

NOTE

When removing automation events, the curve is redrawn to connect the remaining events.

RELATED LINKS

[Virgin Territory vs. Initial Value](#) on page 815

Cleaning Automation

You can delete redundant automation points or unwanted automation spikes that are caused by editing automation points or inaccurate writing of automation data.

Reducing Automation Events

Editing automation points can result in redundant automation points. The **Reduce Automation Events** function allows you to reduce the number of redundant points and to smoothen the automation curve.

NOTE

On the **Settings** tab of the **Automation Panel**, you can set the **Reduction Level**.

PROCEDURE

1. On the toolbar, click **Open Automation Panel**.

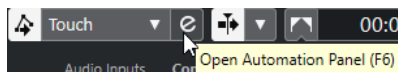

2. Open the **Operations** tab, and click **Automation Functions**.
 3. On the pop-up menu, select one of the following options:
 - To reduce the number of automation points for all tracks in the active project, select **Reduce Automation Events**.
 - To reduce the number of automation points for selected tracks only, select **Reduce Automation Events of Selected Tracks**.
-

RELATED LINKS

[Reduction Level](#) on page 833

Deleting Automation Spikes

The **Delete Automation Spikes** function allows you to delete unwanted spikes in the automation curve.

Editing automation points or inaccurate writing of automation data can provoke short sections where the automation values return to their initial level. These situations are visible as spikes in the automation curve or as jumping faders.

NOTE

On the **Settings** tab of the **Automation Panel**, you can set a **Spike Detection Range** from 0 to 200 ms.

PROCEDURE

1. On the **Project** window toolbar, click **Open Automation Panel**.

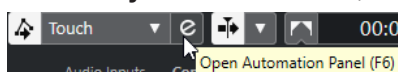

2. Open the **Operations** tab, and click **Automation Functions**.
3. On the pop-up menu, select one of the following options:
 - To delete automation spikes for all tracks in the active project, select **Delete Automation Spikes**.

- To delete automation spikes for selected tracks only, select **Delete Automation Spikes of Selected Tracks**.
-

RELATED LINKS

[Settings Tab](#) on page 832

Automation Tracks

Most of the tracks in your project have automation tracks, one for each automated parameter.

To show automation tracks, you must open them.

Showing/Hiding Automation Tracks

- Position the mouse pointer over the lower left corner of the track and click the arrow icon (**Show/Hide Automation**) that appears.
- Right-click the track in the track list and select **Show/Hide Automation** from the context menu.
- To open another automation track, position the mouse pointer over the lower left corner of an automation track and click + (**Append Automation Track**).
- To show all used automation tracks in the track list, right-click any track and select **Show All Used Automation** from the context menu.
- To open the corresponding automation track on writing automation parameters, select **Project > Automation Panel**, and on the **Settings** page, activate **Reveal Parameter on Write**.

Removing Automation Tracks

- To remove an automation track together with all automation events, click the parameter name, and from the pop-up menu, select **Remove Parameter**.
- To remove all automation tracks from a track that do not contain automation events, select **Remove Unused Parameters** from any of its automation parameter name pop-up menus.
- To remove automation tracks, you can also open the **Automation Functions** pop-up menu on the **Automation Panel**, and select one of the options to delete automation.

Assigning a Parameter to an Automation Track

Parameters are already assigned to automation tracks when you open them, according to their order in the parameter list.

PROCEDURE

1. Open an automation track and click on the automation parameter name.
A parameter list is shown. The content depends on the track type.
 2. From the pop-up menu, select the parameter or select **More** to open the **Add Parameter** dialog that lists all parameters that can be automated, and select the parameter there.
-

RESULT

The parameter replaces the current parameter in the automation track.

NOTE

The replacement of the automation parameter is non-destructive. If the automation track contains any automation data for the parameter that you just replaced, this data is there, although it is not visible. By clicking on the automation parameter name in the track list, you can switch back to the replaced parameter. On the pop-up menu, an asterisk (*) is shown after the parameter name for hidden automation tracks.

Muting Automation Tracks

By muting an automation track, you turn off automation for a single parameter.

- To mute individual automation tracks, click **Mute Automation** in the track list.

Virgin Territory vs. Initial Value

For parameter automation, Nuendo works either with an initial value or with virgin territory.

When no automation data exists for a particular parameter, the starting point of an automation pass is saved as the initial value. When you punch out of the automation pass, it is this initial value to which the parameter will return. This has one important consequence: As soon as the initial value is set, the corresponding parameter is fully automated for the complete track, at any given timecode position of the project – even if your automation pass lasted only 2 seconds. When you release a control, it returns to the value that is defined by the automation curve – even when in stop mode.

When you enable **Use Virgin Territory**, no automation curve is displayed on the automation track, and you find automation data only where you actually perform an automation pass. After an automation pass, you will find virgin territory only to the right of the last automation event.

Creating Gaps

Gaps are empty sections between automation curves. You can create gaps inside a section with automated values.

PROCEDURE

1. Select **Project > Automation Panel**.
 2. Open the **Settings** page, and activate **Use Virgin Territory**.
 3. With the **Range Selection** tool, select a range on an automation track with existing automation data and press **Delete** or **Backspace**.
-

RESULT

A gap is created and new events at the beginning and the end of the selection range are created. These mark the end point of the automation curve to the left and the start of the next automation curve to the right of the gap.

Defining a Terminator Point

You can define any automation event on the automation curve as the terminator point of this part of the curve. This will automatically delete the line between this event and the next one, creating a gap.

PROCEDURE

1. In the automation curve, click the event that you want to define as the last point to select it.

- In the **Project** window info line, set **Terminator** to **Yes**.
The line between this event and the next one is deleted and a gap is created.

NOTE

If you define the last automation event of an automation curve as terminator point, any automation data to the right of this event (as defined by an initial value) is deleted.

Automation Panel

The **Automation Panel** is a floating window, and can be left open while you work.

To open the **Automation Panel**, do one of the following:

- Select **Project > Automation Panel**.
- On the **Project** window toolbar, click **Open Automation Panel** .
- Press **F6**.

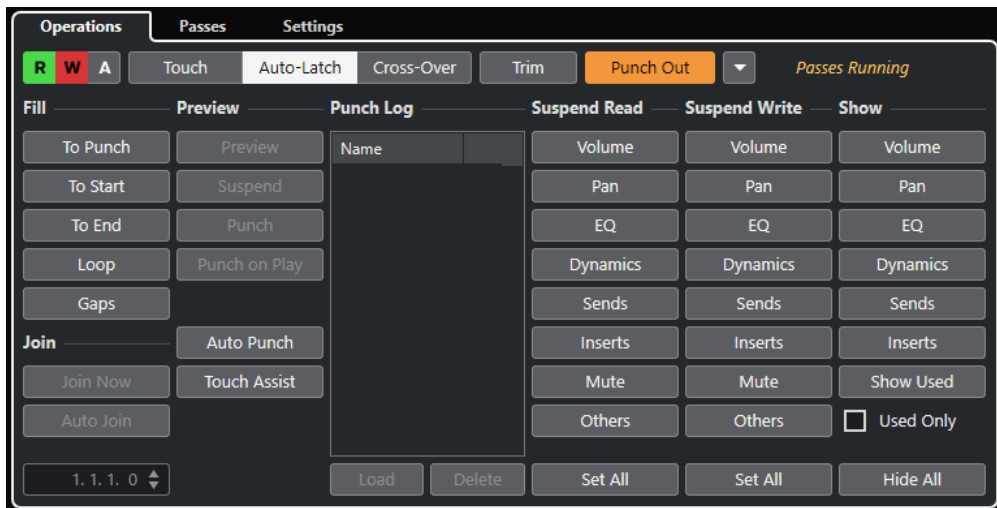

RELATED LINKS

[Operations Tab](#) on page 817

Operations Tab

The **Operations** tab contains all functions that you need to perform automation operations.

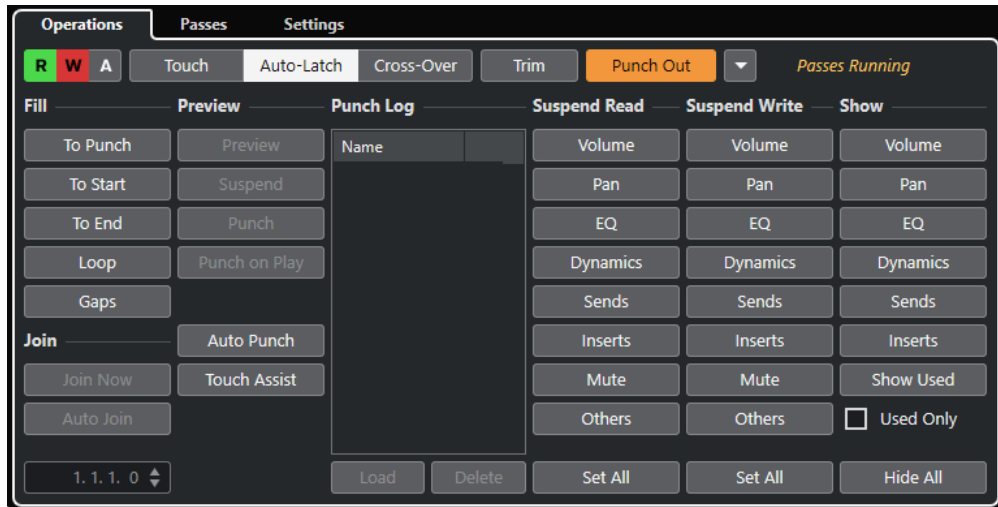

In the topmost section, the following options are available:

Read/Write/Suspend

Activate/Deactivates read/write for all tracks, or suspends read/write for all tracks.

Touch

Writes automation data as long as you touch a parameter control, punches out when you release the control, and then sets the control to the previously set value.

Auto-Latch

Continues writing automation data for as long as playback lasts or **Write** is enabled, and keeps the last value when you release the control.

Cross-Over

Continues writing automation data for as long as playback lasts or **Write** is enabled, and continues with the same value setting when you release the control.

When you re-touch the fader and move it towards the original value, punch out occurs automatically as soon as you cross the original curve.

Trim

Allows you to modify the automation curve from a previous pass.

Punch Out

Allows you to punch out of latch automation. This is only active in **Auto-Latch** mode.

Automation Functions

Gives you access to a number of general automation functions.

Passes Running

Indicates that an automation pass is running.

In the main section, the following options are available:

Fill

These options define what happens in a specific section of your project when you punch out of a running automation pass.

Join

These options help you to resume write automation after an automation pass was interrupted.

Preview

These options allow you to find new settings without recording the steps needed to locate them.

Punch Log

Displays a list of the recent punch in operations that you performed in **Preview** mode.

Suspend Read

Suspends the reading for the activated parameter during automation so that you get full manual control of it.

Suspend Write

Suspends the writing for the activated parameter during automation so that this parameter punches out of the automation pass.

Show

Shows all automation tracks for the activated parameter so that you get an overview of the automated parameter.

RELATED LINKS

[Read/Write/Suspend Buttons](#) on page 818

[Touch](#) on page 819

[Auto-Latch](#) on page 820

[Cross-Over](#) on page 820

[Trim](#) on page 821

[Automation Functions Menu](#) on page 822

[Passes Tab](#) on page 830

[Join Options](#) on page 823

[Fill Options](#) on page 825

[Preview Options](#) on page 827

[Punch Log](#) on page 829

[Suspend Options](#) on page 829

[Show Options](#) on page 830

Read/Write/Suspend Buttons

The **Read** and **Write** buttons in the upper part of the **Automation Panel** are global for all tracks.

- To open the **Automation Panel** select **Project > Automation Panel**.

Activate/Deactivate Read for All Tracks

Activates/Deactivates all **Read** buttons for all tracks.

Activate/Deactivate Write for All Tracks

Activates/Deactivates all **Write** buttons for all tracks.

Suspend All Read/Write Automation

Suspends the reading/writing of automation data for all parameters/parameter groups.

Automation Modes

Nuendo provides different punch out modes for automation: **Touch**, **Auto-Latch**, and **Cross-Over**. In all modes, automation data is written as soon as a parameter control is touched in play mode. They differ in their punch out behavior.

The automation modes are available on the upper part of the **Automation Panel** and on the **Project** window toolbar on the **Global Automation Mode** pop-up menu.

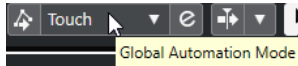

NOTE

The automation mode set on the **Automation Panel** or the **Project** window toolbar is used globally for all tracks of your project. If you want to select a different automation mode for individual tracks, select the track, and on the **Track Automation Mode** pop-up menu in the **Inspector**, select the corresponding option.

You can change the automation mode at any time, for example, in play or stop mode or during an automation pass. You can also assign key commands to the automation modes.

The current automation pass always punches out as soon as one of the following conditions is met, independent of which automation mode is selected:

- If you disable **Write**.
- If you stop playback.
- If you activate **Fast Forward/Rewind**.
- If the project cursor reaches the right locator in **Cycle** mode.
- If you click in the ruler to move the project cursor. This is user-definable and can be controlled via the **Automation Panel**.
- If you manually punch out of the automation by clicking **Punch Out** button.

NOTE

In **Auto-Latch** mode, you can punch out by using the **Punch Out of Latch Automation** key command in the **Automation** category.

RELATED LINKS

[Settings Tab](#) on page 832

Touch

Touch mode is useful in situations where you want to make a change lasting only a few seconds to an already set up parameter.

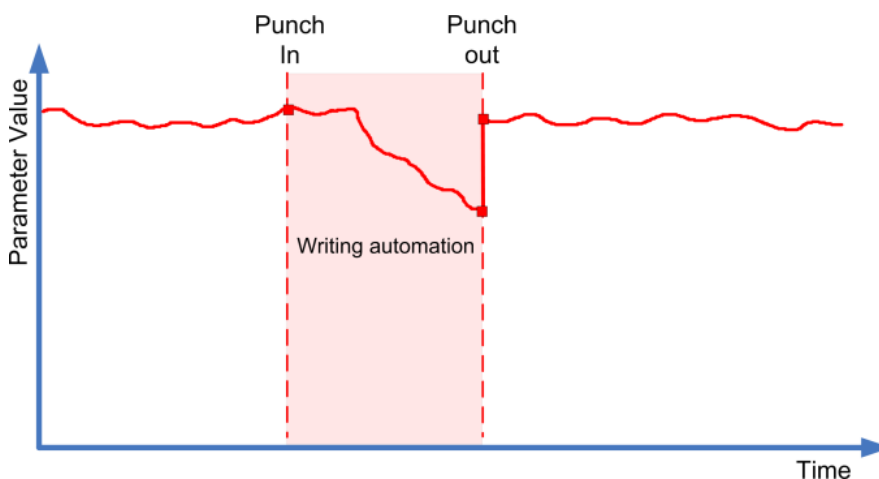

- **Touch** writes automation data only for as long as you actually touch a parameter control. Punch out occurs as soon as you release the control.
- After punch out, the control returns to the previously set value.

NOTE

You can set the time it takes for the parameter to reach the previously set value with the **Return Time** setting on the **Settings** page of the **Automation Panel**.

RELATED LINKS

[Settings Tab](#) on page 832

Auto-Latch

Auto-Latch is useful in situations where you want to keep a value over a longer period of time – for example when making EQ settings for a particular scene.

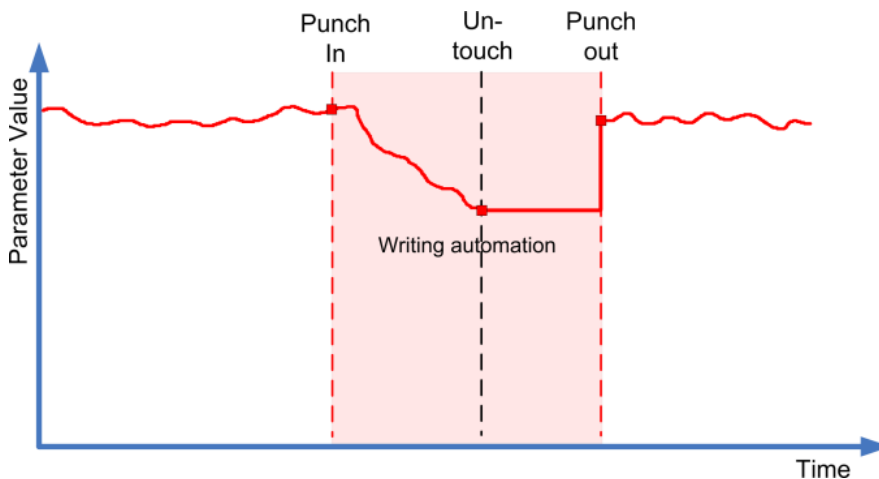

- Once your pass has started, the writing of automation data continues for as long as playback lasts or **Write** is enabled.
- When you release the control, the last value is kept until you punch out.

NOTE

You can also punch out by clicking **Punch Out** in the **Automation Panel**, or by using the **Punch Out of Latch Automation** key command in the **Automation** category.

Punch out also occurs, if one of the general punch out conditions is met.

NOTE

The automation mode for on/off switches is always **Auto-Latch** even if another mode is selected globally or for the track.

RELATED LINKS

[Automation Modes](#) on page 818

Cross-Over

Cross-Over mode allows you to perform a manual return to ensure smooth transitions between new and existing automation settings. For **Cross-Over**, the punch out condition is crossing over an already existing automation curve after touching the parameter for a second time. The **Cross-Over** mode can be used in situations where you are not satisfied with an automation curve or with the automatically applied return settings.

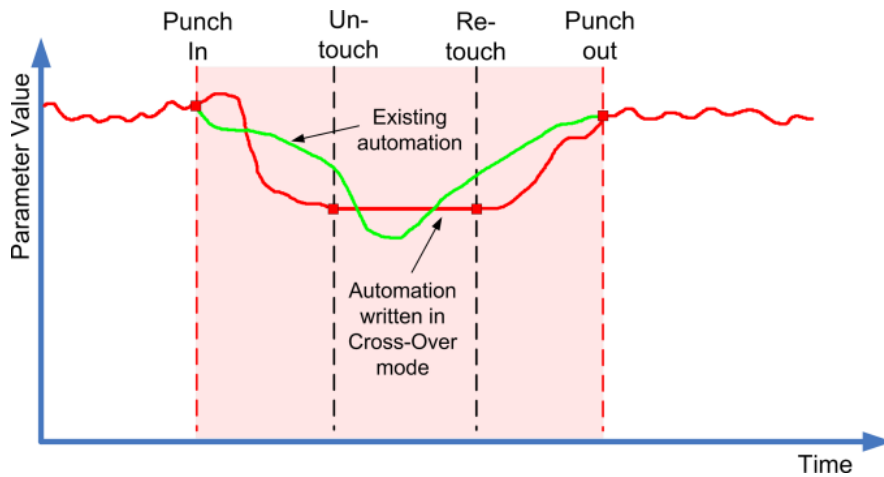

- Once your pass has started, the writing of automation data continues for as long as playback lasts or **Write** is enabled.
- When you release the control, the automation pass continues, with the value setting remaining the same.
- When you re-touch the fader and move it towards the original value, punch out occurs automatically as soon as you cross the original curve.

RELATED LINKS

[Settings Tab](#) on page 832

Trim

Trim allows you to modify the automation curve from a previous pass. If you activate **Trim**, a trim curve is positioned in the middle of the automation track.

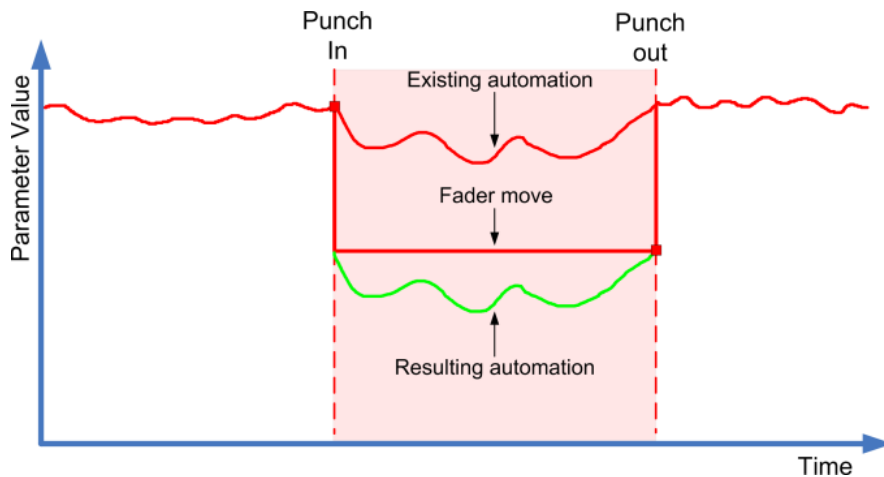

NOTE

Trim works for channel volume and cue send level adjustments.

If you activate **Trim**, all editing and recording affects the trim curve. If you deactivate **Trim**, it affects the original automation curve instead.

You can edit trim data like any other automation data. It is stored with the project.

- Drag the trim curve up or down and add automation events to it. These increase or decrease the values of the original automation curve, but allow you to preserve the original data.

You can use **Trim** either in stop or in play mode:

- In stop mode, you can select one of the **Fill** options and edit the trim curve manually by clicking on it and moving it up or down. The original automation curve is displayed in a lighter color and its values are merged with the trim curve. The resulting automation curve is displayed in a darker color.
- In play mode, the events of the original automation curve are trimmed as the project cursor passes over them.

NOTE

Trim also works with bézier automation curves.

RELATED LINKS

[Creating Smooth Transitions Between Automation Events \(Bézier Automation Curves\)](#) on page 809

Freeze Trim

You can freeze your trim curve automatically or manually. This renders all trim data into a single automation curve.

- To freeze your trim curve automatically whenever a write operation is finished, open the **Settings** page of the **Automation Panel**, and select **On Pass End** in the **Freeze Trim** pop-up menu.
- To freeze your trim curve automatically when **Trim** mode is switched off, open the **Settings** page of the **Automation Panel**, and select **On Leaving Trim Mode** in the **Freeze Trim** pop-up menu.
- To freeze your trim curve manually, open the **Settings** page of the **Automation Panel**, and select **Manually** in the **Freeze Trim** pop-up menu. To freeze a specific parameter for the track, click the parameter name, and from the pop-up menu, select **Freeze Trim**.
- To freeze the trim automation for all tracks in the project, open the **Functions** pop-up menu of the **Automation Panel**, and select **Freeze All Trim Automation in Project**.
To freeze the trim automation of all selected tracks, open the **Functions** pop-up menu of the **Automation Panel**, and select **Freeze Trim Automation of Selected Tracks**.

Automation Functions Menu

A number of general functions are available for automation.

- To open the **Automation Functions** menu, select **Project > Automation Panel**, and click **Automation Functions**.

Delete All Automation in Project

Removes all automation data from your project.

Delete Automation of Selected Tracks

Removes all automation data on selected tracks.

Delete Automation in Range

Deletes all automation data between the left and right locators on all tracks.

Fill Gaps on Selected Tracks

This option is used with virgin territories. Select this option to fill any gaps in the automation curves of the selected tracks with a continuous value. The value of the last event (the end point) of a section is used to fill the gap. This value is written across the gap up to one millisecond before the first event of the next automated section. A new event is inserted here; the value will be ramped to the next automated section.

Fill Gaps with Current Value (Selected Tracks)

This option is used with virgin territories. Select this option to fill any gaps in the automation curves of the selected tracks. The gaps are filled with the current value of the corresponding control.

Create Initial Parameter Events

This function creates and stores the initial automation values for each automatable parameter in the **MixConsole**. For parameters that have not been automated yet, automation events are created at the current parameter position, for example, at value 0. As initial parameter events are created on all channels, all channels will have automation data, even if you did not add automation to them. If this is not what you want, use the **Global Snapshot** function instead.

Freeze All Trim Automation in Project

Freezes all trim automation for all tracks in the project.

Freeze Trim Automation of Selected Tracks

Freezes all trim automation for the selected tracks.

Global Snapshot: Store

Use this function to save a backup copy of all automatable **MixConsole** parameters as a snapshot so that you can reapply them later. The snapshot is saved with the project. You can only save one snapshot at a time. By storing a snapshot, a previously stored snapshot may be overwritten.

Global Snapshot: Apply

Applies the stored snapshot.

Global Snapshot: Remove

Removes the stored snapshot.

Reduce Automation Events

Allows you to delete redundant automation points and smoothen the automation curve for all tracks in the active project.

Reduce Automation Events of Selected Tracks

Allows you to delete redundant automation points and smoothen the automation curve for the selected tracks.

Delete Automation Spikes

Allows you to delete automation spikes in the automation curve for all tracks in the active project.

Delete Automation Spikes of Selected Tracks

Allows you to delete automation spikes in the automation curve for the selected tracks.

Join Options

The **Join** options help you to resume write automation. This is useful if several editors work on the same project simultaneously, and running automation passes are interrupted.

NOTE

The **Join** options are not available in **Touch** mode.

Activating Join Now

Join Now allows you to resume automation manually.

PROCEDURE

1. Start playback and watch the automation curve.
2. When the cursor reaches the desired position, click **Join Now**.

All parameters from the last pass are punched in and the last value is written for the whole section. All previous automation events are overwritten.

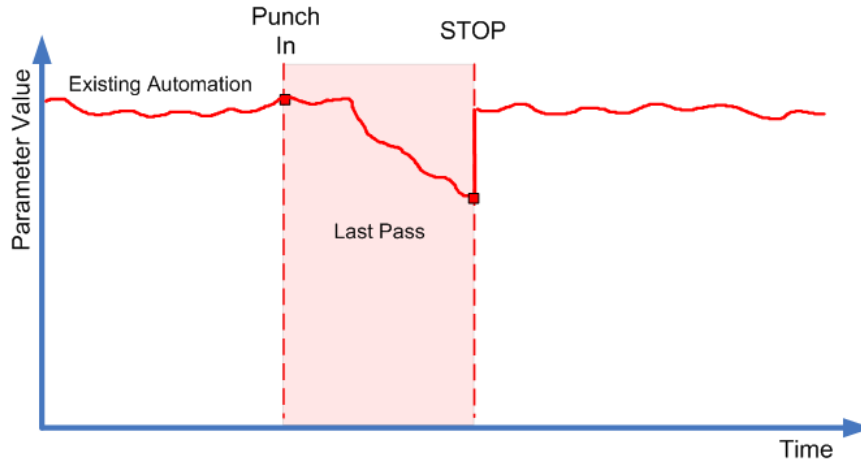

Activating Auto Join

Auto Join allows you to resume automation automatically.

PROCEDURE

1. On the **Automation Panel**, activate **Auto Join**.
2. Start playback and watch the automation curve.

All parameters from the last pass are punched in automatically at the position where you hit stop. The position is indicated by the join indicator.

NOTE

The join indicator shows the timecode position where the last automation pass was stopped, for example, the point where the **Auto Join** will automatically occur. When automation is resumed, this indicator is updated.

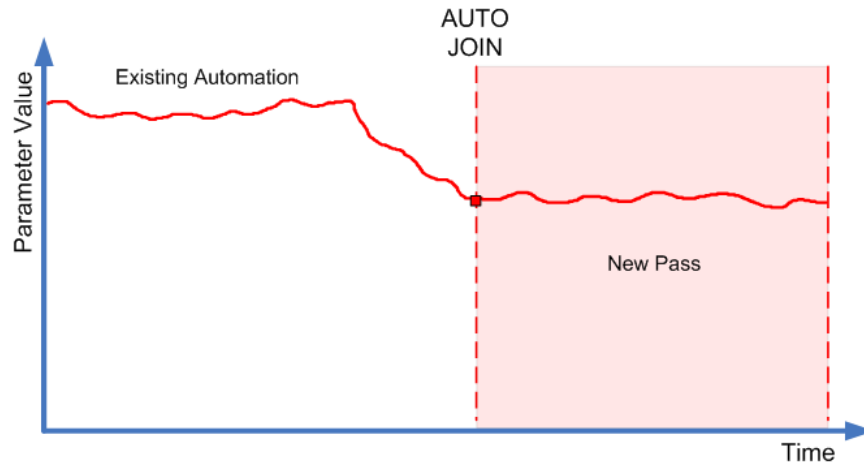

Fill Options

The **Fill** options define what happens in a specific section of your project when you punch out of a running automation pass.

The **Fill** options write one particular value across a defined section of your automation track. Any previously created data within this section is overwritten.

You can also combine the various **Fill** options.

Activating To Punch

PROCEDURE

1. On the **Automation Panel**, activate **Touch**, and activate **To Punch** as **Fill** option.
2. Start playback.
3. Move the fader until you have found the volume setting that you want and release the fader to punch out.
The volume curve is set from the point of punch out back to where you punched in. The values written while moving the fader to find the right value are deleted, and the volume jumps at exactly the right moment from the value set in the first scene to the value found for the second scene.

Activating To Start

PROCEDURE

1. On the **Automation Panel**, activate **Touch**, and activate **To Start** as **Fill** option.
2. Start playback.
3. Move the fader until you have found the volume setting that you want and release the fader to punch out.
The automation track is filled from where you punched out to the start of the project.

Activating To End

PROCEDURE

1. On the **Automation Panel**, activate **Touch**, and activate **To End** as **Fill** option.
2. Start playback and touch the parameter control to punch in the automation pass.

3. Move the fader until you have found the setting that you want and release it.
This will punch out the writing of automation data. As you let go of the fader, the automation curve takes the found value setting, from where you punched out to the end of the project.
-

Activating Loop

PREREQUISITE

You have set up a loop range with the left and right locators.

PROCEDURE

1. On the **Automation Panel**, activate **Touch**, and activate **Loop** as **Fill** option.
 2. Start playback.
 3. Move the fader until you have found the volume setting that you want and release the fader to punch out.
The found value is set within the range that is defined by the left and right locators.
-

Activating Gaps

PREREQUISITE

You have set up virgin territories.

NOTE

When **Trim** is active, **Gap** has no effect. This is because **Trim** only modifies already existing data.

PROCEDURE

1. On the **Automation Panel**, activate **Touch**, and activate **Gaps** as **Fill** option.
 2. Start playback.
 3. Move the fader until you have found the volume setting that you want and release the fader to punch out.
Any gaps between previously written automation events are filled with the last value that was found during the last automation pass.
-

RELATED LINKS

[Virgin Territory vs. Initial Value](#) on page 815

One Shot vs Continuous Fill

You can use the **Fill** options in different ways:

- **One shot**
When you click one of the **Fill** buttons, it is highlighted, and will be enabled during the next automation pass. Afterwards, the option is disabled again.
- **Continuous fill**
If you click a **Fill** button a second time, a lock symbol is displayed on the highlighted button, indicating that you are in continuous fill mode and that the operation can be repeated as many times as you want. Click the button a third time to disable the corresponding **Fill** option.

Drawing Fill Manually

You can use the **Fill** options on the **Automation Panel** in combination with the **Draw** tool. This provides you with a powerful method for writing automation data manually.

PROCEDURE

1. Open an automation track and select the **Draw** tool.
2. On the **Automation Panel**, select **To End** as **Fill** option.
3. Click and draw to create an automation curve.
4. Release the mouse button.

At the moment of release, a final automation event is created. The automation curve is written from this last event through to the end of the project.

NOTE

This procedure can be used with all the **Fill** options.

Preview Options

The **Preview** options allow you to find new settings without recording the steps needed to locate them.

This is useful if you want to audition changes on automation values without deleting any of the original automation data. When you have found the settings, you can punch the previewed value.

When changing a preset of a VST plug-in while in **Preview** mode, the change in the parameter settings caused by the preset change is recorded automatically as automation. Note that the plug-in must have 32 or fewer parameters for this to work.

Activating Preview

PROCEDURE

1. On the **Automation Panel**, in the **Preview** section, activate **Preview**.

NOTE

To set the **Preview** mode permanently, click **Preview** 2 times. A lock symbol is displayed on the highlighted button. You can disable this by clicking the button a third time.

2. Touch a parameter control.
The **Suspend**, **Punch**, and **Punch on Play** options are displayed. You now have full manual control of the touch-collected parameter and can suspend any previously recorded automation data.
3. Optional: Touch-collect another parameter if you want to write data for several parameters during the same automation pass.
4. Play back the scene to find the parameter settings that you want.
5. Touch the required parameter, start playback, find the value, and activate **Punch** to start the new automation pass.
6. Optional: If you want to compare the value that was found during preview with previously automated values, activate the **Suspend** option.
This plays back your audio material using the parameter values set before activating **Preview**. You can use the delta indicator in the automation track as an additional visual aid for comparing the values.
7. When you are happy with the values found, click **Punch** to start the new automation pass.

The new value setting is recorded from the point where you punched in to your punch out position as defined by the automation mode setting.

Punch vs. Punch on Play

When using the **Punch** option, starting playback and punching in are separate actions. If you want to punch in when starting playback, activate **Punch on Play**.

- Use **Punch on Play** when you cannot punch in on the fly, for example in situations where you need to find the punch in position in stop mode. Once you have found the exact position, enable **Punch on Play** and start playback from there.
- **Punch** is the option to use if you need to listen to the section before your punch in point and if this section already contains automation data that you do not want to overwrite. Roll through this section and then punch in the automation pass.
- You can also use **Punch** in stop mode. To create automation data in this way, **Punch** must be combined with one of the **Fill** modes.

Auto Punch

Auto Punch allows you to begin and end the automation pass at defined positions.

- Activate **Preview** mode and set the left and right locators at the positions where you want to automatically punch in and out.

Auto Punch allows you to set up a safe zone for previously written automation data.

- Place the right locator at the beginning of an area that you want to protect and enable cycle mode.

This ensures that a running automation pass always punches out before reaching this section of your project.

Touch Assist

When you use **Preview** mode, you may get into a situation where you change some parameters, but not others, although they belong to the same group of parameters (for example EQ settings).

Touch Assist allows you to avoid forgetting some parameters while touch-collecting parameters for Preview.

When **Touch Assist** is enabled, the parameters of the following features are treated as groups:

- Channel EQ module (21 parameters)
- Aux send on/off and send level
- Stereo panner
- Surround panner (Left-Right, Front-Rear, LFE)
- Insert plug-ins (only available for plug-ins with 32 or fewer parameters)

Touch Assist ensures that touching one parameter in a group will touch all other parameters in that group as well.

However, if you want to automate only one particular parameter, disable **Touch Assist** to avoid inadvertently overwriting any previously created automation data.

NOTE

Enabling **Touch Assist** may lead to the creation of a large amount of automation data, causing a higher CPU load. Only use **Touch Assist** if the performance is still acceptable.

Punch Log

The **Punch Log** section displays a list of the recent punch in operations that you performed in **Preview** mode. You can load one of these log entries for the current track to recall the corresponding touch-collected parameters and their values at the moment of punch in.

- To load an entry in the punch log, select it in the list and click **Load**.

The **Preview** button on the **Automation Panel** and on the corresponding automation track lights up.

NOTE

When loading a log entry, you add the corresponding parameters to any other parameters that you have touch-collected during the current preview session. However, if you manually touch-collect the volume parameter, for example, and then add volume again by loading a punch log entry, the settings for volume from the punch log are used, replacing any values set manually.

- To rename any log, double-click it and enter a new name.
- To delete an entry, select it and click **Delete**.
- To specify how many log entries are displayed, open the **Settings** tab and activate **Max Punch Logs**.

If this value is set to 10 entries, the eleventh punch event overwrites the entry created for the first event, the twelfth replaces the second entry, etc. The maximum possible number of punch log entries is 100.

- To prevent a particular entry from being overwritten, click in the right section for this entry, so that a checkmark is displayed.

Punch log entries are saved with the current project.

Punch log data is always project-specific. You cannot export log entries to another project.

Suspend Options

This section on the **Automation Panel** allows you to exclude specific parameters from the reading or writing of automation data. This way, you have full manual control of these parameters.

Suspend Read

Suspending the reading for a specific parameter during automation gives you full manual control of it.

- To suspend the reading of automation data for a specific parameter, click the corresponding parameter.
- To suspend the reading of automation data for all parameters/parameter groups, click **Set All**.

NOTE

When any of the options in the **Suspend Read** category are enabled, clicking **Set All** disables all buttons.

EXAMPLE

Imagine that you have already automated several tracks. While working on the current track, you want one of the other tracks to be louder, to better identify a particular position in your audio material.

By suspending **Read** for the volume parameter, you regain full manual control and can set the volume to the required level.

Suspend Write

Suspending the writing for a specific parameter during automation punches this parameter out of the automation pass.

- To suspend the writing of automation data for a specific parameter, click the corresponding parameter.
- To suspend the writing of automation data for all parameters/parameter groups, click **Set All**.

NOTE

When any of the options in the **Suspend Write** category are enabled, clicking **Set All** disables all buttons.

EXAMPLE

Imagine the following situation: To help you concentrate while working on a particular track, you mute several other tracks. However, because write automations are active on these tracks, this mute state is also automated during the next automation pass – a classic situation in mixing.

To avoid inadvertently excluding whole tracks from your mix in this way, you can exclude **Mute** from all automation writing by clicking **Mute** in the **Suspend Write** category on the **Automation Panel**.

Show Options

The **Show** options allow you to open all automation tracks for a specific parameter. This gives you an overview of the automated parameter.

- To open the volume, pan, EQ, sends, or inserts automation tracks for all tracks, click the corresponding parameter.

The automation tracks are opened even if no automation data was recorded on these tracks.

- To step through the individual parameter sets of parameter groups, for example pan, EQ, sends, and inserts, click the respective button repeatedly.
- To show only the automation tracks for which automation data has already been written, activate **Used Only** and click one of the options.
- To show all automation tracks that contain automation data, activate **Show Used**.
- To hide all open automation tracks, activate **Hide All**.

NOTE

The **Show** options on the **Automation Panel** affect all tracks.

Passes Tab

Shows the history of the recorded automation passes.

To record automation passes, the **Activate Automation Passes** option must be activated on the **Settings** tab.

An automation pass begins with the first parameter that is written after activating **Write** automation and starting playback. It ends when playback stops, either when you click **Stop** or when the position cursor jumps to another position. This occurs when cycle or arranger mode is activated. You can undo automation passes in the automation pass history.

Activating Automation Passes

PROCEDURE

1. On the **Automation Panel**, open the **Settings** tab, and activate **Activate Automation Passes**.
2. Activate **Write** automation and perform some actions.
The **Activate Automation Passes** button indicates that an automation pass is running and the pass is written to the history.

NOTE

Automation passes are only created when you write automation automatically. If you want to undo manually written automation events use the **Edit History** instead.

RESULT

The automation pass is recorded and written into the automation pass history on the **Passes** tab.

Undoing Automation Passes

PROCEDURE

1. Open the **Passes** tab and in the automation pass history, drag the horizontal line upwards.
The corresponding automation events on the automation track are removed and the entries in the automation pass history are grayed out. The **State** column displays **Undone**.

NOTE

All automation that you performed manually as well as other edits and processes performed during or after the automation passes are also undone.

2. If you want to redo automation passes again, drag the horizontal line downwards.
The corresponding automation events on the automation track are inserted and the **State** column shows **Executed** again.
-

Undoing Branches

A branch is a sequence of automation passes.

In a branch, each automation pass is represented by a rectangle with the number of the automation pass. Automation that you perform manually, as well as other edits and processes in between automation passes, are represented by smaller rectangles. These rectangles only serve as indicators, they cannot be used to undo the edits.

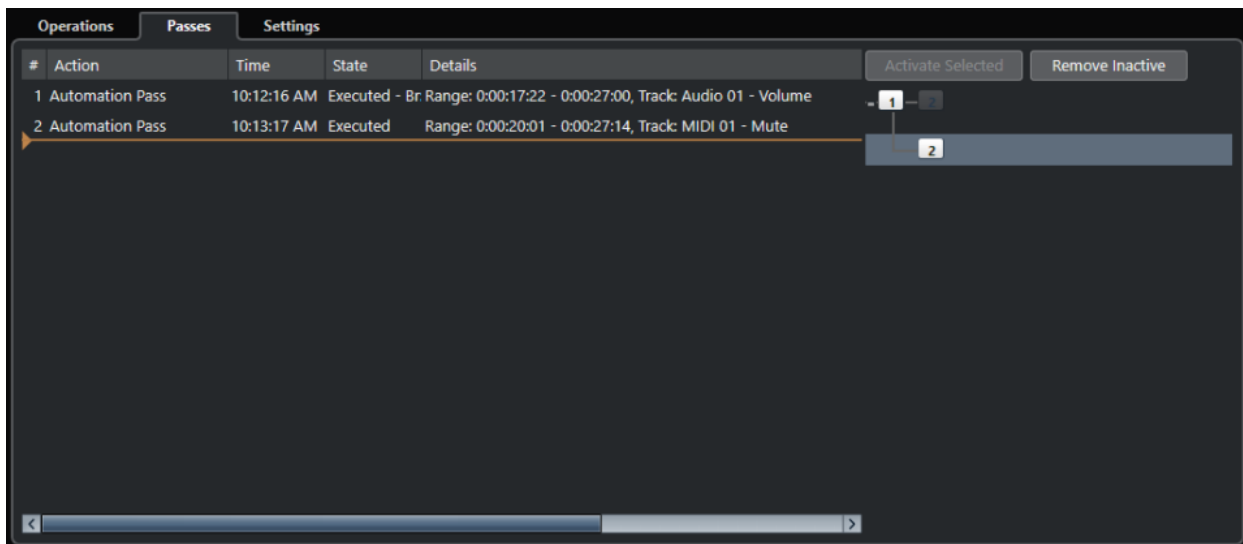

When you undo an automation pass and subsequently write new automation, a new branch is created and all following automation passes are gathered in the new branch.

If you have 2 or more branches, you can choose to undo the automation passes of the separate branches in the automation pass history by activating and deactivating specific branches.

Deactivating Undo Branches

PROCEDURE

1. Open the **Settings** tab of the **Automation Panel**, and activate **Activate Automation Passes**.
2. Open the **Passes** tab to open the automation pass history.
3. Click a branch to select it.
The actions of the selected branch are displayed in the left section of the dialog.
4. Click **Activate Selected** to deactivate all subsequent branches.
All automation passes from the subsequent branches are undone. The automation passes of the activated branch are redone until the branch ends. For example, the first edits of a following branch are merged back into it.
5. To undo and delete a branch, click **Remove Inactive**.
All branches are removed. The actions of the inactive branch disappear completely whereas the actions of the active branches are merged.

RESULT

The automation pass history is not saved with the project. If you close your project, the history is deleted.

Settings Tab

You can make general automation settings for your project.

- To open the automation settings, select **Project > Automation Panel**, and open the **Settings** page.

Activate Automation Passes

Activates automation passes.

Use Undo Branches

Activate this to gather automation passes in branches.

Show Data on Tracks

Activate this to show audio waveforms or MIDI events on automation tracks.

The events are displayed only if **Show Waveforms** is enabled in the **Preferences** dialog (**Event Display—Audio** page), and if **Part Data Mode** is set to an option other than **No Data, Event Display—MIDI** page.

Use Virgin Territory

Activate this if you want to use virgin territories.

Continue Writing on Transport Jump

If you activate this option, the recording of automation is not blocked when locating to a new position. This can be used to perform multiple automation passes in cycle mode or if you are using the arranger functions.

If this option is deactivated and you write automation data and locate to another position in the project, writing is stopped until the mouse button is released or until a stop command is received.

Reveal Parameter on Write

If you activate this option, the corresponding automation track is revealed on writing automation parameters. This is useful if you want to have a visual control of all parameters changed on writing.

Return Time

This determines how fast the automated parameter returns to any previously automated value when you release the mouse button. Set this to a value higher than 0 to prevent sudden jumps in your parameter settings which may lead to crackles.

Reduction Level

Punching out or using the **Reduce Automation Events** function removes all superfluous automation events. This results in an automation curve that contains only the events necessary to reproduce your actions. A reduction level value of 0 % removes repeated automation points only. A reduction level value between 1 to 100 % smoothens the automation curve. The default value of 50 % should reduce the automation data amount significantly without touching the sound result of the existing automation.

Spike Detection Range

Defines a period of time in which sudden changes in the automated parameter are considered to be unwanted spikes. The spikes can be removed using the **Delete Automation Spikes** function. You can set values from 0 to 200 ms.

Max Punch Logs

This specifies how many log entries are displayed. You can set values from 5 to 100.

Freeze Trim

In this pop-up menu, you can specify how to freeze your trim curve.

- **Manually**
Freezes your trim curve manually.
- **On Pass End**
Performs a freeze whenever a write operation is finished.
- **On Leaving Trim Mode**
Freezes trims data automatically when the trim mode is switched off (globally or individually for a track).

RELATED LINKS

[Passes Tab](#) on page 830

[Virgin Territory vs. Initial Value](#) on page 815

[Punch Log](#) on page 829

VST Instruments

VST instruments are software synthesizers or other sound sources that are contained within Nuendo. They are played internally via MIDI. You can add effects or EQ to VST instruments.

Nuendo allows you to make use of VST instruments in the following ways:

- By adding a VST instrument and assigning one or several MIDI tracks to it.
- By creating an instrument track.

This is a combination of a VST instrument, an instrument channel, and a MIDI track. You play and record MIDI note data directly for this track.

NOTE

Some VST instruments are included with Nuendo. These are described in the separate document **Plug-in Reference**.

RELATED LINKS

[Instrument Tracks](#) on page 132

Adding VST Instruments

PROCEDURE

1. On the **Studio** menu, select **VST Instruments**.
2. Right-click on an empty area of the **VST Instruments** window.
3. From the context menu, select **Add Rack Instrument**.
4. From the instrument selector, select an instrument.
5. Click **Create**.

RESULT

The instrument control panel opens, and the following tracks are added to the track list:

- A MIDI track with the name of the instrument. The output of the MIDI track is routed to the instrument.

NOTE

In the **Preferences** dialog (**VST—Plug-ins** page), you can specify what happens when you load a VST instrument.

- A folder with the name of the instrument that is added within a **VST Instruments** folder. The instrument folder contains two automation tracks: one for the plug-in parameters and one for the synth channel in the **MixConsole**.

VST Instrument Control Panel

The VST instrument control panel allows you to set up the parameters of the selected instrument. The contents, design, and layout of the control panel depend on the selected instrument.

The following controls are available:



- 1 Activate Instrument**
Activates/Deactivates the instrument.
- 2 Read Automation/Write Automation**
Allows you to read/write automation for the instrument parameter settings.
- 3 Switch between A/B Settings**
Switches to setting B when setting A is active, and to setting A when setting B is active.
- 4 Apply current settings to A and B**
Copies the instrument parameters of instrument setting A to instrument setting B, and vice versa.
- 5 Activate/Deactivate Side-Chaining**
Activates the side-chain functionality for VST 3 instruments that support side-chaining.
- 6 Set up Side-Chain Routing**
Allows you to set up the side-chain routing for the selected plug-in.
- 7 Event Received Indicator**
Lights up on receiving note-on and controller messages.
- 8 Preset browser**
Opens the preset browser where you can select another preset.
- 9 Load previous Program/Load next Program**
Loads the previous/next program in the preset browser.
- 10 Preset Management**
Opens a pop-up menu that allows you to save, rename, or remove a preset.
- 11 Add VST Plug-in Picture to Media Rack**
Adds a picture of the VST plug-in to the **Media** rack. This is only available for plug-ins of other vendors.

12 VST Instrument context menu

Opens a context menu with specific functions and settings.

RELATED LINKS

[Adding Pictures of VST Instruments to the Media Rack](#) on page 707

[VST Instrument Context Menu](#) on page 841

[Hiding/Showing VST Instrument Control Panels](#) on page 837

[Side-Chaining for VST Instruments](#) on page 850

Hiding/Showing VST Instrument Control Panels

When you add a VST instrument, the respective plug-in control panel opens automatically. You can hide the control panels from view. This is useful to get a better overview if you added a number of plug-ins to your project whose control panels clutter up the screen.

PROCEDURE

- Select **Window > Hide Plug-in Windows**.

NOTE

This also hides VST effect control panels.

RESULT

The plug-in windows are hidden and sent to the back of the application. To show them again, select **Show Plug-in Windows**.

RELATED LINKS

[VST Instrument Control Panel](#) on page 835

Closing All Control Panels

When you add a VST instrument, the respective plug-in control panel opens automatically. You can close all control panels at once.

PROCEDURE

- Select **Window > Close All Plug-in Windows**.

NOTE

This also closes VST effect control panels.

RESULT

The control panels are closed.

RELATED LINKS

[VST Instrument Control Panel](#) on page 835

VST Instrument Selector

The VST instrument selector allows you to select VST instruments of the active collection.

To open the VST instrument selector, do one of the following:

- Select **Studio > VST Instruments**, and click **Add Rack Instrument**.
- Select **Studio > VST Instruments**, click **Add Track Instrument**, and open the **Instrument** pop-up menu.

The following controls are available:

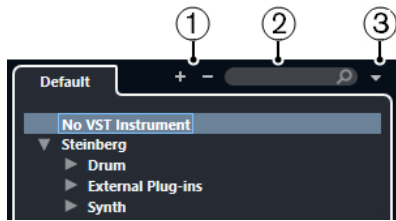

- 1 Expand Tree/Collapse Tree**
Expands/Collapses the tree.
- 2 Search VST Instrument**
Allows you to search for VST instruments by typing in the name or parts of the name or the category.
- 3 Plug-in Collections and Options**
Allows you to select a collection.
If you select the **Default** collection, the options **Sort By Category** and **Sort by Vendor** become available. These allow you to sort the default collection.

Creating Instrument Tracks

You can create instrument tracks that hold dedicated VST instruments.

PROCEDURE

1. In the global track controls area of the track list, click **Add Track** .
2. Click **Instrument**.
3. Open the **Instrument** pop-up menu and select a VST instrument.
4. Click **Add Track**.

RESULT

The selected VST instrument is loaded for the instrument track. In the **MixConsole**, an instrument channel is added.

VST Instruments in the Right Zone

The **VST Instruments** in the right zone of the **Project** window allow you to add VST instruments for MIDI and instrument tracks.

All instruments that are used in your project are shown. You can access up to 8 quick controls for each added instrument.

To open the **VST Instruments** in the right zone, click **Show/Hide Right Zone** on the **Project** window toolbar, and at the top of the right zone, click the **VSTi** tab.



NOTE

The **VST Instruments** in the right zone are just another representation of the **VST Instruments** window. All features are the same.

RELATED LINKS

[Showing/Hiding Zones](#) on page 47
[Project Window Toolbar](#) on page 48

VST Instruments Window

The **VST Instruments** window allows you to add VST instruments for MIDI and instrument tracks.

All instruments that are used in your project are shown. You can access up to 8 quick controls for each added instrument.

To open the **VST Instruments** window, select **Studio > VST Instruments**.

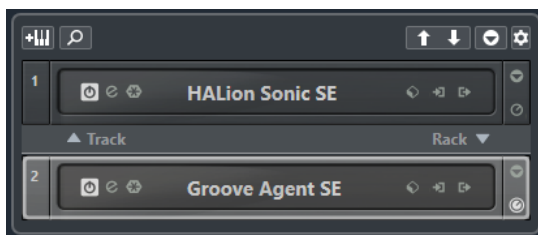

RELATED LINKS

[Instrument Tracks](#) on page 132

VST Instruments Window Toolbar

The **VST Instruments** window toolbar contains controls that allow you to add and set up VST instruments and **VST Quick Controls**.

Add Track Instrument



Opens the **Add Track** dialog that allows you to select an instrument and add an instrument track that is associated to this instrument.

Find Instruments



Opens a selector that allows you to find a loaded instrument.

Set Remote-Control Focus for VST Quick Controls to Previous Instrument



Allows you to set the remote-control focus to the previous instrument.

Set Remote-Control Focus for VST Quick Controls to Next Instrument



Allows you to set the remote-control focus to the next instrument.

Show/Hide all VST Quick Controls



Shows/Hides the default quick controls for all loaded instruments.

Settings



Opens the **Settings** pop-up menu where you can activate/deactivate the following modes:

- **Show VST Quick Controls for One Slot Only** shows the **VST Quick Controls** exclusively for the selected instrument.
- **MIDI Channel follows track selection** ensures that the **Channel** selector follows the MIDI track selection in the **Project** window. Use this mode if you work with multitimbral instruments.
- **Remote-Control Focus for VST Quick Controls follows track selection** ensures that the **VST Quick Controls** remote-control focus follows the track selection.

VST Instrument Controls

The VST instrument controls allow you to make settings for a loaded VST instrument.

The following controls are available on each instrument:

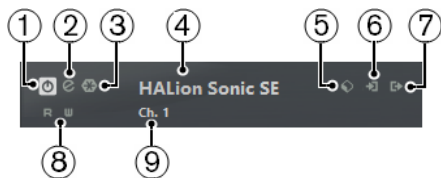

- 1 Activate Instrument**
Activates/Deactivates the instrument.
- 2 Edit Instrument**
Opens the instrument panel.
- 3 Freeze Instrument**
Freezes the instrument. This allows you to save CPU power.
- 4 Instrument selector**
Allows you to select another instrument. Double-click to rename the instrument. The name is shown in the window in the **Output Routing** pop-up menu for MIDI tracks. This is useful when you work with several instances of the same instrument.
- 5 Preset Browser**
Allows you to load or save an instrument preset.
- 6 Input Options**

This lights up when MIDI data is received by the instrument. Click this button to open a pop-up menu that allows you to select, mute/unmute, and solo/unsolo for tracks that send MIDI to the instrument (inputs).

NOTE

If you resize the **VST Instruments** window, you can access this option by using an **Input/Output Options** pop-up menu.

7 Activate Outputs

This control is only available if the instrument provides more than one output. It allows you to activate one or more outputs for the instrument.

NOTE

If you resize the **VST Instruments** window, you can access this option by using an **Input/Output Options** pop-up menu.

8 Read Automation/Write Automation

Allows you to read/write automation for the instrument parameter settings.

9 Select Quick Control Layer

Allows you to select a program.

RELATED LINKS

[Freezing Instruments](#) on page 845

VST Instrument Context Menu

The VST instrument control panel context menu and the **Functions** menu on the VST instrument control panel show functions and settings that are specific for the instrument.

Do one of the following:

- Right-click an empty area of the VST instrument control panel.
- Open the **Functions** pop-up menu on the VST instrument control panel.

The following functions are available:

Copy <VST instrument name> Setting/Paste <VST instrument name> Setting

Allows you to copy the instrument settings and paste them to another instrument.

Load Preset/Save Preset

Allows you to load/save a preset.

Default Preset

Allows you to define and save a default preset.

Switch to A Setting/Switch to B Setting

Switches to setting B when setting A is active, and to setting A when setting B is active.

Apply Current Settings to A/Apply Current Settings to B

Copies the instrument parameters of instrument setting A to instrument setting B, and vice versa.

Activate Outputs

Allows you to activate one or more outputs for the instrument.

Activate/Deactivate Side-Chaining

Activates/Deactivates side-chaining for the instrument.

NOTE

This option is only available for VST 3 instruments that support side-chaining.

Remote Control Editor

Opens the **Remote Control Editor**.

Switch to Generic Editor

Opens the generic editor for the instrument.

Allow Window to be Resized

Allows the dynamic resizing of third-party plug-in windows in Nuendo. This is useful if you activated **Enable HiDPI** (Windows only) in the **Preferences** dialog (**General** page), and your plug-in does not support dpi settings.

NOTE

Allow Window to be Resized is a plug-in-specific setting. You must activate/deactivate it for every plug-in that requires it.

RELATED LINKS

[General](#) on page 1365

[Side-Chaining for VST Instruments](#) on page 850

Presets for Instruments

You can load and save presets for instruments. These contain all the settings that are required for the sound that you want.

The following presets for instruments are available:

- **VST Presets**

VST presets include the parameter settings of a VST instrument.

These are available from the **VST Instruments** window, from the instrument control panels, and from the **Programs** field in the **Inspector**.

- **Track Presets**

Track presets include the instrument track settings and the settings for the corresponding VST instrument.

These are available from the **Inspector** or the track list context menu.

Loading VST Presets

You can load **VST Presets** from the **VST Instruments** window, from the control panel or from the **Inspector**.

PROCEDURE

1. Do one of the following:

- Select the track that contains the VST instrument, and in the **Inspector**, click the **Programs** field.
- In the **VST Instruments** window, click **Preset Browser** for the instrument, and select **Load Preset**.
- In the control panel for the VST instrument, click **Preset Browser**, and select **Load Preset**.

2. In the preset browser, select a preset from the list and double-click it to load it.
-

RESULT

The preset is applied. To return to the previously loaded preset, open the preset browser again and click **Revert to Last Setting**.

Saving VST Presets

You can save your settings on VST instruments as VST presets for further use.

PROCEDURE

1. Do one of the following:
 - In the **VST Instruments** window, click **Preset Browser** for the instrument, and select **Save Preset**.
 - In the control panel for the VST instrument, click **Preset Browser**, and select **Save Preset**.
 2. In the **Save <VST instrument name> Preset** dialog, enter a name for the preset.
 3. Optional: Click **Show Attribute Inspector** and define attributes for the preset.
 4. Click **OK** to save the preset and close the dialog.
-

Loading Track Presets

You can load track presets for instrument tracks from the **Inspector**.

PROCEDURE

1. Do one of the following:
 - Select the instrument track, and in the **Inspector**, click the **Load Track Preset** field.
 - Right-click the instrument track, and from the context menu, select **Load Track Preset**.
 2. In the preset browser, select a preset from the list and double-click it to load it.
-

RESULT

The track preset is applied. To return to the previously loaded preset, open the preset browser again and click **Revert to Last Setting**.

Instrument Presets Results Browser

The **Results** browser for instrument track presets allows you to preview VST presets and apply them to your instrument track.

- To open the **Results** browser, right-click an instrument track, and select **Load Track Preset**.

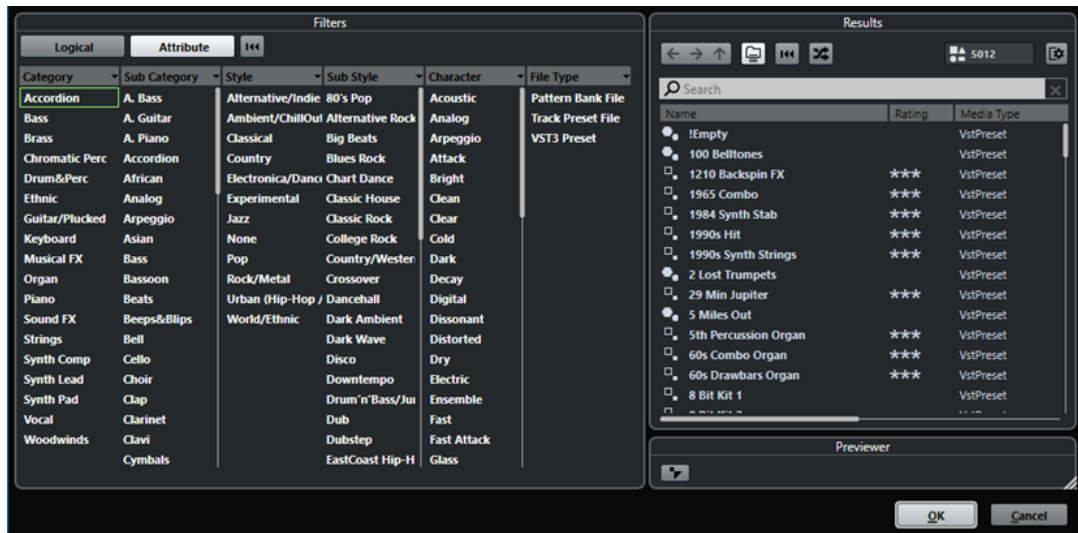

VST presets for instruments can be divided into the following groups:

Presets

Presets contain the settings of the entire plug-in. For multitimbral instruments, this includes the settings for all sound slots as well as the global settings.

Programs

Programs contain only the settings for one program. For multitimbral instruments, this includes only the settings for one sound slot.

Saving Track Presets

You can save your settings on instrument tracks as track presets for further use.

PROCEDURE

1. Right-click the instrument track, and from the context menu, select **Save Track Preset**.
2. In the **Save Track Preset** dialog, enter a name for the preset.
3. Optional: Click **Show Attribute Inspector** and define attributes for the preset.
4. Click **OK** to save the preset and close the dialog.

Playing Back VST Instruments

After you have added a VST instrument and selected a sound, you can play back the VST instrument using the instrument or MIDI track in your project.

PROCEDURE

1. In the track list, activate **Monitor** for the track that has the VST instrument loaded.
2. Press one or more keys on your MIDI keyboard or use the **On-Screen Keyboard**.
The corresponding sounds are triggered on your VST instrument.
3. Select **Studio > MixConsole** to open the **MixConsole** and adjust the sound, add EQ and effects, assign another output routing, etc.

VST Instruments and Processor Load

VST instruments can consume a lot of CPU power. The more instruments you add, the more likely you will run out of processor power during playback.

If the CPU overload indicator in the **Audio Performance** window lights up or you get crackling sounds, you have the following options:

- Activate **Freeze Instrument Channel**.
This renders the instrument into an audio file and unloads it.
- Activate **Suspend VST 3 plug-in processing when no audio signals are received** for VST 3 instruments.
This ensures that your instruments do not consume CPU power on silent passages.

RELATED LINKS

[Freezing Instruments](#) on page 845

[Suspend VST 3 plug-in processing when no audio signals are received](#) on page 1380

Freezing Instruments

If you are using a moderately powerful computer or a large number of VST instruments, your computer may not be able to play back all instruments in real time. At this point, you can freeze instruments.

PROCEDURE

1. Do one of the following:
 - Select **Studio > VST Instruments**.
 - Select the instrument track and open the top **Inspector** section.
2. Click **Freeze**.
3. In the **Freeze Instrument Options** dialog, make your changes.
4. Click **OK**.

RESULT

- The instrument is rendered to an audio file, and on playback you hear the same sound as before freezing.
- Less CPU load is used.
- The **Freeze** button lights up.
- The MIDI/instrument track controls are grayed out.
- The MIDI parts are locked.

NOTE

To edit the tracks, parameters, or synth channels again, and to delete the rendered file, unfreeze the instrument by clicking **Freeze** again.

Freeze Instrument Options Dialog

The **Freeze Instrument Options** dialog opens when you click **Freeze**. It allows you to specify exactly what should happen if you freeze an instrument.

The following controls can be found in the **Freeze Instrument Options** dialog:

Freeze Instrument Only

Activate this option if you still want to be able to edit insert effects on the synth channel after freezing the instrument.

Freeze Instrument and Channels

Activate this option if you do not need to edit the insert effects on your synth channels.

NOTE

You can still adjust level, pan, sends, and EQ.

Tail Size

Allows you to set a tail size time to let sounds complete their normal release cycle.

Unload Instrument when Frozen

Activate this option to unload the instrument after freezing. This makes the RAM available again.

Latency

The term latency stands for the time it takes for the instrument to produce a sound when you press a key on your MIDI controller. It can be an issue when using VST instruments in real time. Latency depends on your audio hardware and its ASIO driver.

In the **Studio Setup** dialog (**Audio System** page), the input and output latency values should ideally be a few milliseconds.

If the latency is too high to allow comfortable real time VST instrument playback from a keyboard, you can use another MIDI sound source for live playback and recording, and switch to the VST instrument for playback.

RELATED LINKS

[Selecting an Audio Driver](#) on page 18

Delay Compensation

During playback, Nuendo automatically compensates any delay inherent in the VST plug-ins you use.

You can specify a **Delay Compensation Threshold** in the **Preferences** dialog (**VST** page), so that only plug-ins with a delay higher than this threshold setting are affected.

Constrain Delay Compensation

To avoid that Nuendo adds latency when you play a VST instrument in real time or record live audio, you can activate **Constrain Delay Compensation**. This minimizes the latency effects of the delay compensation, while maintaining the sound of the mix as far as possible.

Constrain Delay Compensation is available on the **Project** window toolbar and in the **Transport** zone. You can also find it as a menu item in the **MixConsole** on the **Functions Menu**.

Activating **Constrain Delay Compensation** turns off VST plug-ins that are activated for VST instrument channels, audio track channels that are record-enabled, group channels, and output channels. VST plug-ins that are activated for FX channels are disregarded. After recording or using a VST instrument, **Constrain Delay Compensation** should be deactivated again in order to restore full delay compensation.

RELATED LINKS

[Project Window Toolbar](#) on page 48

Import and Export Options

Importing MIDI Loops

You can import MIDI loops (file extension `.midiloop`) in Nuendo. These files contain MIDI part information (MIDI notes, controllers, etc.) and all the settings that are saved in instrument track presets. This way, you can reuse instrument patterns in other projects or applications, for example.

PROCEDURE

1. Select **Media > MediaBay**.
2. Optional: On the toolbar, open the **Select Media Types** menu, and activate **MIDI Loops** and **Plug-in Presets**.

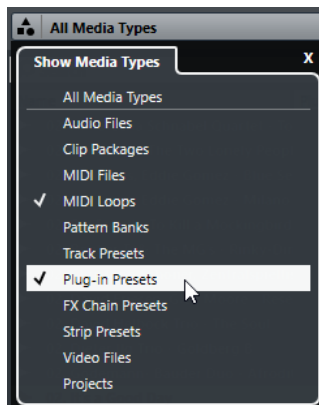

3. In the **Results** list, select a MIDI loop and drag it to an empty section in the **Project** window.

RESULT

An instrument track is created and the instrument part is inserted at the position where you dragged the file. The **Inspector** reflects all settings that are saved in the MIDI loop, for example, the VST instrument that was used, applied insert effects, track parameters, etc.

NOTE

You can also drag MIDI loops onto existing instrument or MIDI tracks. However, this only imports the part information. This means this part only contains the MIDI data (notes, controllers) that is saved in the MIDI loop, but no **Inspector** settings or instrument parameters.

RELATED LINKS

[Presets for Instruments](#) on page 842

[Filtering According to Media Type](#) on page 715

Exporting MIDI Loops

You can export MIDI loops to save a MIDI part together with its instrument and effect settings. This allows you to reproduce patterns that you created without having to search for the correct sound, style, or effect. MIDI loops have the file extension `.midiloop`.

PROCEDURE

1. Select an instrument part.
2. Select **File > Export > MIDI Loop**.
3. In the **Save MIDI Loop** dialog, enter a name for the MIDI loop.
4. Optional: To save attributes for the MIDI loop, click the button below the **New MIDI Loop** section at the bottom left.
The **Attribute Inspector** section opens, allowing you to define attributes for your MIDI loop.
5. Click **OK**.

RESULT

MIDI loop files are saved in the following folder:

Windows: `\Users\\AppData\Roaming\Steinberg\MIDI Loops`

macOS: `/Users/<user name>/Library/Application Support/Steinberg/MIDI Loops/`

The default folder cannot be changed. However, you can create subfolders within this folder to organize your MIDI loops. To create a subfolder, click **New Folder** in the **Save MIDI Loop** dialog.

Exporting Instrument Tracks as MIDI Files

You can export instrument tracks as standard MIDI files.

PROCEDURE

1. Select an instrument track.
2. Select **File > Export > MIDI File**.
3. In the **Export MIDI File** dialog, select a location and enter a name for the MIDI file.
4. Click **Save**.
5. In the **Export Options** dialog, make your changes.
If you activate **Export Inspector Volume/Pan**, volume and pan information of the VST instrument are converted and written into the MIDI file as controller data.
6. Click **OK**.

RESULT

The instrument track is exported as standard MIDI file. As there is no MIDI patch information in an instrument track, this information is missing in the resulting MIDI file.

RELATED LINKS

[Exporting MIDI Tracks as Standard MIDI Files](#) on page 177

VST Quick Controls

VST Quick Controls allow you to remote-control a VST instrument from within the **VST Instruments** window.

To show the **VST Quick Controls** on the **VST Instruments** window, activate **Show/Hide all VST Quick Controls**.

The following controls are available on each rack:



1 Show/Hide VST Quick Controls

Allows you to show/hide the **VST Quick Controls** for the instrument.

2 VST Quick Controls

Allow you to remote-control the parameters of the instrument.

NOTE

The number of **VST Quick Controls** that are shown depends on the size of the **VST Instruments** window.

3 Set Remote-Control Focus for VST Quick Controls

Allows you to activate the **VST Quick Controls** to remote-control the instrument.

RELATED LINKS

[Remote Controlling Nuendo](#) on page 865

[Connecting VST Quick Controls with Remote Controllers](#) on page 849

[Activating Pick-up Mode for Hardware Controls](#) on page 864

Connecting VST Quick Controls with Remote Controllers

VST Quick Controls become powerful if you use them together with a remote controller.

PREREQUISITE

The MIDI output on your remote unit is connected to a MIDI input on your MIDI interface.

PROCEDURE

1. Select **Studio > Studio Setup**.
2. In the **Devices** list, select **VST Quick Controls**.
3. Open the **MIDI Input** pop-up menu, and select a MIDI input.
4. Optional: Open the **MIDI Output** pop-up menu, and select a MIDI output.
5. Click **Apply**.
6. Activate **Learn**.
7. In the **Control Name** column, select **QuickControl 1**.
8. On your MIDI device, move the control that you want to connect with the first quick control.
9. Select the next slot in the **Control Name** column and repeat the previous steps.
10. Click **OK**.

RESULT

The **VST Quick Controls** are now connected with control elements on your MIDI device. If you move a control element, the value of the parameter that is assigned to the corresponding **VST Quick Controls** changes accordingly.

NOTE

The remote controller setup for **VST Quick Controls** is saved globally, that is, it is independent of any projects.

RELATED LINKS

[Generic Remote Page](#) on page 869

Side-Chaining for VST Instruments

You can send audio into VST 3 instruments that support side-chaining. Side-chaining allows you to use the output of one track to control the action of an instrument on another track.

Depending on the instrument, activating side-chaining allows you to:

- Use the instrument as an effect plug-in on audio events.
- Use the side-chain signal as a modulation source.
- Apply ducking to the instrument, that is, reduce the volume of the instrument track when a signal is present on the audio track.

You can route the audio signal to the side-chain input of an instrument in different ways:

- To process the audio signal completely through the instrument, route the output of the audio track to the side-chain input of an instrument.
- To use both the clean audio signal and the signal processed by the instrument, route a send to the instrument side-chain.

NOTE

To hear the audio played through the instrument, you must trigger a note, either by playing MIDI events or by playing notes on your external MIDI keyboard.

RELATED LINKS

[Using Instruments as Effects on Audio Tracks](#) on page 850

Using Instruments as Effects on Audio Tracks

You can use instruments that support side-chaining to modify the audio on audio tracks. The following example shows you how to apply the parameters in Retrologue to a drum loop.

PREREQUISITE

You have a drum loop on an audio track. You have created an instrument track with Retrologue loaded.

PROCEDURE

1. On the Retrologue control panel, click **Activate/Deactivate Side-Chaining**.
2. On the control panel, click **Set up Side-Chain Routing**.
3. Click **Add Side-Chain Source**, and select the audio track from the selector.
4. In the **Project** window, select the audio track.
5. In the **Inspector** for the audio track, open the **Output Routing** pop-up menu and select Retrologue as a side-chain input.
6. On the Retrologue panel in the **Oscillator Mix** section, adjust the **Input Level** control.
7. Optional: Deactivate oscillators **OSC 1**, **OSC 2**, and **OSC 3**.

8. Do one of the following:

- On the instrument track, create a MIDI event, set up a cycle with the left and right locators, and activate cycle mode.
- Play notes on your MIDI keyboard.

NOTE

For this to work, your MIDI keyboard must be installed and set up.

RESULT

When a note is played, the drum loop is played back through Retrologue.

AFTER COMPLETING THIS TASK

Use Retrologue to modify the sound of your drum loop. For example, you can do the following:

- Use the filter and distortion settings on the **Synth** page.
- Modulate the input signal. To do this, select **Modulation Matrix > Destination > Oscillator > Audio Input**.
- Set up a rhythmical modulation on the **Arp** page.
- Use the effects on the **FX** page, for example the **Resonator**.

NOTE

For detailed information about Retrologue and its parameters, see the separate document **Retrologue**.

External Instruments

An external instrument bus is an input (return) to your audio hardware, along with a MIDI connection via Nuendo and additional settings.

External instrument busses are created in the **Audio Connections** window. All external instrument busses that you have created appear on the **VST Instrument** pop-up menus and can be selected in the same way as any VST instrument plug-in.

If you select an external instrument, you must create a MIDI device to play it via MIDI. The sound that is output by the synth audio output will come in to the VST environment where you can apply processing, etc.

RELATED LINKS

[Setting up External Instruments](#) on page 41

Installing and Managing VST Plug-ins

Nuendo supports the VST 2 and VST 3 plug-in standards. You can install effects and instruments that comply with these formats.

NOTE

Nuendo only supports 64-bit plug-ins.

A plug-in is a piece of software that adds a specific functionality to Nuendo. The audio effects and instruments that are used in Nuendo are VST plug-ins.

VST effect or VST instrument plug-ins normally have their own installation application. Read the documentation or readme files before installing new plug-ins.

When you scan for newly installed plug-ins or relaunch Nuendo, the new plug-ins are shown on the VST effect or VST instrument selectors, respectively.

Nuendo comes with a number of effect plug-ins included. These effects and their parameters are described in the separate document **Plug-in Reference**.

Plug-ins and Collections

The **VST Plug-in Manager** shows the VST effects and VST instruments that are installed on your computer.

In Nuendo, plug-ins are arranged in collections. Only one collection can be active at the same time. The plug-ins contained in the active collection are shown in the selectors all over the program.

When you launch Nuendo, all plug-ins that are found are automatically placed in the **Default** collection. This is the collection of plug-ins that is active by default.

The **Default** collection is created each time you start Nuendo or you initiate a rescan.

You can, however, add your own VST effect or VST instrument collections. This is useful if you only want to see the specific plug-ins that are used in a specific project, for example. When you activate this collection, all VST effects and VST instruments of this collection are shown in the selectors for VST effects or VST instruments.

NOTE

If an installed VST effect or a VST instrument could not be loaded by Nuendo, it is not shown on the **VST Effects** tab or the **VST Instruments** tab, and grayed out in any collection. In this case, verify if that plug-in is copy-protected.

RELATED LINKS

[VST Plug-in Manager Window](#) on page 853

[Adding New Plug-in Collections](#) on page 855

VST Plug-in Manager Window

You can manage VST effects and VST instruments in the **VST Plug-in Manager** window.

- To open the **VST Plug-in Manager** window, select **Studio > VST Plug-in Manager**.

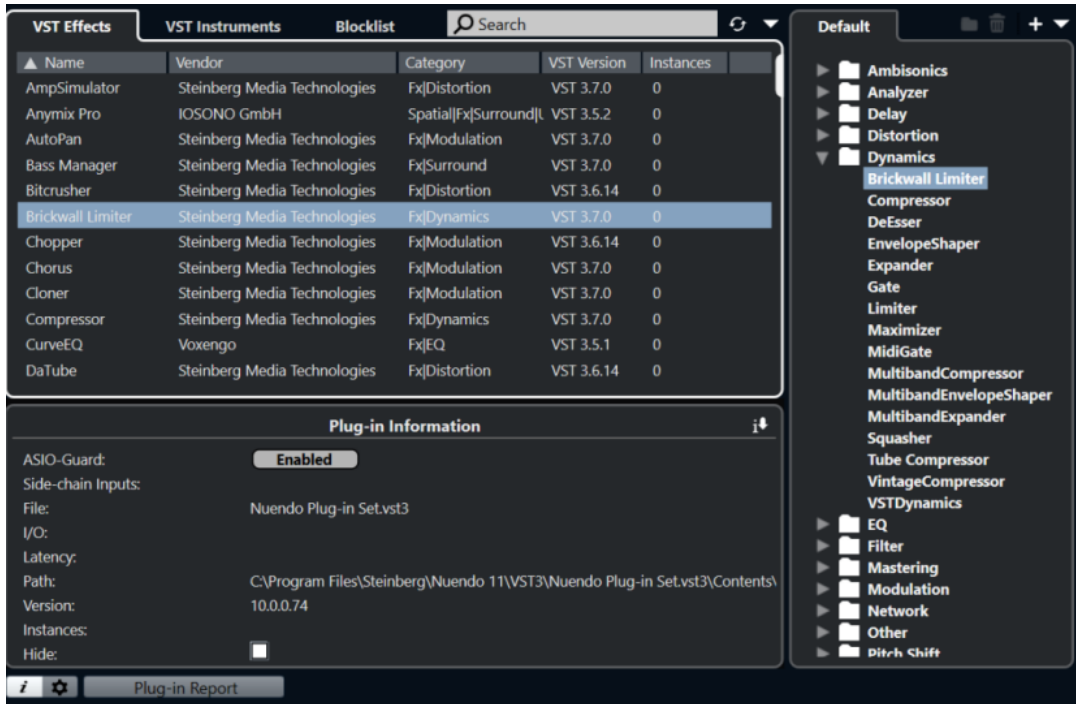

The **VST Plug-in Manager** is divided into the following sections:

VST Effects

Lists all VST effects that are loaded in Nuendo. To sort the list by a specific attribute, click the corresponding column header.

VST Instruments

Lists all VST instruments that are loaded in Nuendo. To sort the list by a specific attribute, click the corresponding column header.

Blocklist

Lists all VST effects and VST instruments that are installed on your system but not loaded in Nuendo, because they might lead to stability problems or even cause the program to crash.

Toolbar

Shows tools and shortcuts for functions in the **VST Plug-in Manager**.

Active collection

Shows the active collection. The plug-ins of the active collection are shown in the selectors for VST effects and VST instruments.

Show VST Plug-in Information

Shows information about the selected plug-in.

VST 2 Plug-in Path Settings

Shows the path of the selected VST 2 plug-in.

Plug-in Report

Opens the File Explorer/macOS Finder that allows you to save a text file that contains information about your system as well as plug-in information. This is useful for troubleshooting, for example.

RELATED LINKS

[Plug-ins and Collections](#) on page 852

[Audio System Page](#) on page 19

[VST Plug-in Manager Toolbar](#) on page 854

[VST 2 Plug-in Path Settings](#) on page 855

[Hiding Plug-ins](#) on page 856

[Reactivating Plug-ins from the Blocklist](#) on page 857

VST Plug-in Manager Toolbar

Shows tools and shortcuts for functions in the **VST Plug-in Manager**.

- To open the **VST Plug-in Manager** window, select **Studio > VST Plug-in Manager**.

Search field



Allows you to search for specific plug-ins on the **VST Effects** tab or on the **VST Instruments** tab by typing in their name.

Rescan All

Rescans the plug-in list.

Display Options



Allows you to choose which plug-ins are shown:

- **Show All Plug-ins** shows all loaded plug-ins.
- **Hide Plug-ins That Are in Active Collection** hides all plug-ins that are part of the active collection.
- **Show Plug-ins That Support 64-Bit Float Processing** shows all VST 3 plug-ins that support 64-bit float processing.

New Folder



Creates a new folder in the current collection.

Delete



Deletes the selected item in the current collection.

New Collection



Creates a new collection.

- **Empty** creates a new, empty collection.
- **Add All Plug-ins** creates a new collection that contains all VST effects or VST instruments respectively.
- **Copy Current Collection** creates a new collection that contains the current collection.

Plug-in Collections and Options



- **Default** activates the default collection.

- **New Collection** allows you to create a new collection.
- **Remove Unavailable Plug-ins from All Collections** removes all plug-ins that are not available from all user-created collections.
- **Sort By Category** sorts the collection by category.

NOTE

This option is only available for the **Default** collection.

- **Sort By Vendor** sorts the collection by vendor.

NOTE

This option is only available for the **Default** collection.

VST 2 Plug-in Path Settings

Shows information about the selected VST 2 plug-in path.

- To open the **VST 2 Plug-in Path Settings**, select **Studio > VST Plug-in Manager**, and click **VST 2 Plug-in Path Settings**.

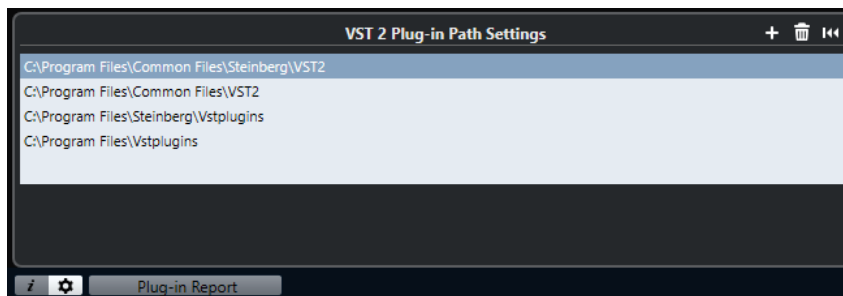

VST 2 Plug-in path list

Shows all VST 2 plug-in paths.

Add Path

Allows you to add a new VST 2 plug-in path.

Delete Path

Deletes the selected VST 2 plug-in path.

Reset

Resets the list to default.

Adding New Plug-in Collections

You can add new collections of VST effects or VST instruments.

PREREQUISITE

A number of effect plug-ins is installed on your computer, and these plug-ins are listed in the **VST Plug-in Manager** on the **VST Effects** tab and the **VST Instruments** tab.

PROCEDURE

1. In the **VST Plug-in Manager** toolbar, click **New Collection**, and select an option.

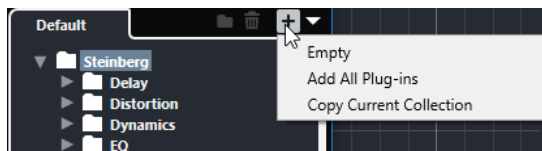

2. In the **New Collection** dialog, enter a name for the new collection and click **OK**.
3. Optional: Click **New Folder**.
You can then move your plug-ins into these folders to organize them by categories, for example.
4. Enter a name for the new folder and click **OK**.
5. On the **VST Effects** tab or the **VST Instruments** tab, select the plug-ins that you want to add to the collection, and drag them in the new collection.
If you created folders, you can drag the plug-ins directly into folders.

RESULT

The new collection is saved. If you select it, its plug-ins are shown in the plug-in selectors.

AFTER COMPLETING THIS TASK

To remove a plug-in from a collection, select it and click **Remove**.

RELATED LINKS

[Plug-ins and Collections](#) on page 852

[VST Plug-in Manager Window](#) on page 853

Hiding Plug-ins

You can hide plug-ins from all collections. This is useful if you have plug-ins installed on your computer that you do not want to use in Nuendo.

PROCEDURE

1. Select **Studio > VST Plug-in Manager**.
2. On the **VST Effects** tab or on the **VST Instruments** tab, select the plug-ins that you want to hide from view.
3. Click **Show VST Plug-in Information** to show information about the selected plug-in.
4. Activate **Hide**.

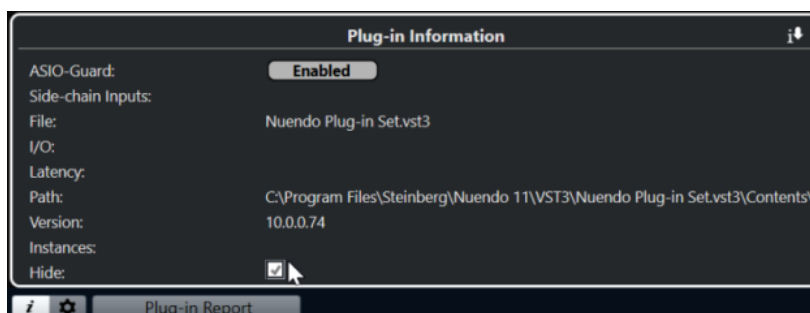

RESULT

The selected plug-in is hidden from view.

RELATED LINKS

[ASIO-Guard](#) on page 1352

Reactivating Plug-ins from the Blocklist

You can reactivate 64-bit plug-ins that are on the blocklist.

PROCEDURE

1. On the **Blocklist** tab, select the plug-ins that you want to reactivate.

NOTE

You cannot reactivate 32-bit plug-ins, because they are not supported.

2. Click **Reactivate**.
-

RESULT

Nuendo rescans the plug-in and removes it from the blocklist.

AFTER COMPLETING THIS TASK

If you want to move the plug-in back to the blocklist, click **Rescan All** in the **VST 2 Plug-in Path Settings**, and restart Nuendo.

RELATED LINKS

[VST Plug-in Manager Window](#) on page 853

Track Quick Controls

Nuendo allows you to set up 8 different track parameters or settings as **Track Quick Controls** for quick access.

Track Quick Controls are available for the following track types:

- Audio
- MIDI
- Instrument
- Sampler
- FX Channel
- Group Channel
- VCA Fader

For instrument tracks and for MIDI tracks for which you assigned a VST instrument on creation, that is, that you created by loading a rack instrument, **Track Quick Controls** are automatically assigned to the **Quick Controls** of the VST instrument.

For sampler tracks, **Track Quick Controls** are automatically assigned to the sound parameters of **Sampler Control**.

NOTE

You can change the default assignment by assigning different track parameters or by loading a preset.

Assigning parameters to **Quick Controls** is done in the **Inspector** or the **MixConsole**.

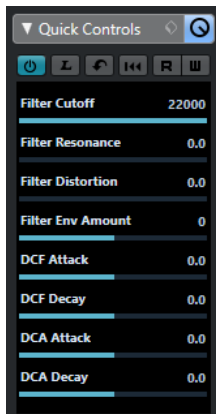

Quick Controls section in the **Inspector**



Track Quick Controls rack in the **MixConsole**

Quick Controls assignments are saved with the project.

You can assign **Track Quick Controls** to an external remote control device. For this to work, you must connect **Track Quick Controls** with your remote controller.

You can automate parameter settings in the **Quick Controls** section using the **Read/Write** buttons (**R** and **W**).

RELATED LINKS

[Track Presets](#) on page 201

[Automation](#) on page 805

[Channel Racks Selector](#) on page 422

Parameter Assignment

You can assign track, effect, and instrument parameters to **Quick Controls**.

For the parameter assignment, you can use the **Inspector** or the **MixConsole**. You can assign parameters manually, use the **QC Learn Mode**, or load an assignment preset.

RELATED LINKS

[Assigning Track Parameters to Quick Controls](#) on page 859

[Assigning Effect Parameters to Quick Controls](#) on page 860

[Using QC Learn Mode](#) on page 860

[Adding Track Quick Controls in the MixConsole](#) on page 456

[Setting Instrument Parameter Assignments to Default](#) on page 861

[Removing Parameter Assignments](#) on page 861

[Loading Track Quick Control Assignments as Presets](#) on page 862

Assigning Track Parameters to Quick Controls

You can assign track parameters manually.

NOTE

For instrument tracks and MIDI tracks for which you assigned a VST instrument on creation, the main parameters of the instrument are automatically assigned to the slots in the **Quick Controls** section in the **Inspector**.

PROCEDURE

1. In the **Inspector** for your track, open the **Quick Controls** section.
2. In the **Quick Controls** section, click the first slot to open a selector that lists all parameters for the track.

3. Select the parameter that you want to assign to the first **Quick Control**.
The parameter name and its value are displayed in the slot. You can change the value by dragging the slider.

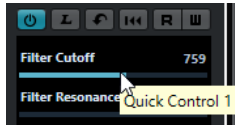

4. Repeat these steps for all slots for which you want to assign track parameters.
-

RESULT

You can now control the track parameters via the **Quick Controls** section in the **Inspector** or via the **Track Quick Controls** rack in the **MixConsole**.

AFTER COMPLETING THIS TASK

You can rename a **Quick Control** by double-clicking on the name and entering a new one. This is useful if a parameter name is very long, for example.

Assigning Effect Parameters to Quick Controls

You can assign effect parameters to **Quick Control** slots directly from within plug-in panels.

NOTE

This is only available for VST 3 plug-ins that support this function.

PROCEDURE

- In the effect plug-in panel, right-click the parameter.
 - Select **Add "x" to Quick Controls** (where x is the name of the parameter) to assign the parameter to the next empty slot.
 - Select **Add "x" to Quick Controls Slot** (where x is the name of the parameter), and select the slot from the submenu to assign the parameter to a specific slot.
-

RESULT

You can now control the effect parameters via the **Quick Controls** section in the **Inspector** or via the **Track Quick Controls** rack in the **MixConsole**.

Using QC Learn Mode

The **QC Learn Mode** allows you to assign a parameter by moving controls. This applies to all automatable controls.

PROCEDURE

1. In the **Inspector** for your track, open the **Quick Controls** section.
 2. Activate **QC Learn Mode**.
 3. Select the slot to which you want to assign a parameter.
 4. Move the control.
-

RESULT

The track parameter is assigned to the corresponding control.

RELATED LINKS

[Controlling Automatable Parameters](#) on page 862

Setting Instrument Parameter Assignments to Default

If you have changed the parameter assignment or if you manually routed a MIDI track to a VST instrument, you can retrieve the default assignments.

PROCEDURE

1. In the **Inspector** for the instrument or MIDI track, open the **Quick Controls** section.
2. Click **Get Default QCs from Plug-in**.

RESULT

The instrument parameter assignments are set to default.

Removing Parameter Assignments

You can remove parameter assignments for individual **Quick Controls** or for all **Quick Controls** at once.

PROCEDURE

- Do one of the following:
 - To remove a parameter from a slot, click in the corresponding slot and select **No parameter** from the pop-up menu.

NOTE

You can also double-click the parameter name, press **Delete** or **Backspace**, and confirm with **Return**.

- To remove the **Quick Control** assignments for all slots, click **Remove All QC Assignments**.

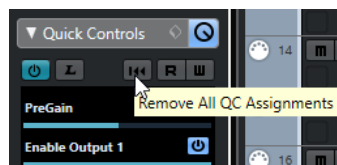

Saving Track Quick Control Assignments as Presets

You can save **Quick Control** assignments as track presets.

PREREQUISITE

You have assigned track parameters to **Quick Controls**.

PROCEDURE

1. In the **Inspector** for your track, open the **Quick Controls** section.
 2. In the **Quick Controls** section, click **Preset Management**.
 3. Click **Save Preset**.
 4. Enter a name in the **Type in Preset Name** dialog.
 5. Click **OK**.
-

RESULT

The **Quick Control** assignment is saved as a preset.

RELATED LINKS

[Assigning Track Parameters to Quick Controls](#) on page 859

Loading Track Quick Control Assignments as Presets

You can load presets for **Quick Control** assignments.

PROCEDURE

1. In the **Inspector** for your track, open the **Quick Controls** section.
2. In the **Quick Controls** section, click **Preset Management** .
3. Select one of the presets in the upper list of the menu.

RESULT

The preset is loaded and allows you to access the channel parameters.

Controlling Automatable Parameters

You can use **Quick Controls** to control all automatable parameters. This allows you to control parameters on other tracks using **Quick Controls**.

IMPORTANT

Use this function with caution, as you might accidentally modify parameters on other tracks.

PROCEDURE

1. Create a new, empty audio track and open the **Quick Controls** section.
2. Hold down **Ctrl/Cmd** and click the first **Quick Control** slot.
The selector lists all automatable parameters.
3. Open the **VST Mixer** folder.
The selector lists all channels that are available in the **MixConsole** of your project.

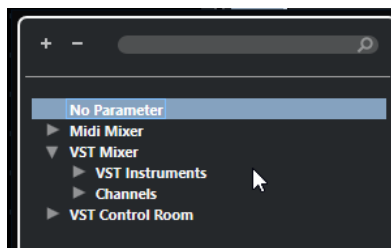

4. Assign a parameter of one particular channel to **Quick Control 1**, and another parameter of another channel to **Quick Control 2**.

RESULT

The **Quick Controls** section now allows you to control automatable parameters on different tracks.

IMPORTANT

You cannot save **Quick Control** assignments for automatable parameters on different tracks as track presets.

Showing Automated Quick Control Assignments

You can show all **Quick Control** assignments that have been automated for one track.

PROCEDURE

1. Click the track for which you want to show automated **Quick Control** assignments.
 2. In the **Inspector** for your track, open the **Quick Controls** section.
 3. In the **Quick Controls** section, click **Preset Management** .
 4. Select **Show Automated QC Assignments**.
-

RESULT

The automation tracks of the automated **Quick Control** parameters open for the selected track.

NOTE

- If **Volume** is assigned as a **Quick Control** parameter, it is always shown as automated, independent of whether it is automated or not.
 - You can also show automated **Quick Control** assignments via the **Track Quick Controls** rack in the **MixConsole**.
-

Connecting Track Quick Controls with Remote Controllers

Track Quick Controls become powerful if you use them together with a remote controller.

PREREQUISITE

The MIDI output on your remote unit is connected to a MIDI input on your MIDI interface.

PROCEDURE

1. Select **Studio > Studio Setup**.
 2. In the **Devices** list, select **Track Quick Controls**.
 3. Open the **MIDI Input** pop-up menu, and select a MIDI input.
 4. Optional: Open the **MIDI Output** pop-up menu, and select a MIDI output.
 5. Click **Apply**.
 6. Activate **Learn**.
 7. In the **Control Name** column, select **QuickControl 1**.
 8. On your MIDI device, move the control that you want to connect with the first quick control.
 9. Select the next slot in the **Control Name** column and repeat the previous steps.
 10. Click **OK**.
-

RESULT

The **Track Quick Controls** are now connected with control elements on your MIDI device. If you move a control element, the value of the parameter that is assigned to the corresponding **Track Quick Controls** changes accordingly.

NOTE

The remote controller setup for **Track Quick Controls** is saved globally, that is, it is independent of any projects.

RELATED LINKS

[Generic Remote Page](#) on page 869

Activating Pick-up Mode for Hardware Controls

Pick-up Mode allows you to change configured **Quick Control** parameters without accidentally modifying the previous values. This is useful if you want the control to pick up the parameter at the value to which it was last set. If you move a hardware control, the parameter only changes once the control reaches the previous value.

NOTE

This only applies to hardware controllers whose controls use specific ranges.

PROCEDURE

1. Select **Studio > Studio Setup**.
 2. In the **Devices** list, select **Track Quick Controls** or **VST Quick Controls**.
 3. Activate **Pick-up Mode**.
 4. Click **OK**.
-

Remote Controlling Nuendo

You can control Nuendo via MIDI with a connected MIDI device.

The supported devices are described in the separate document **Remote Control Devices**. You can also use a generic MIDI controller to remote-control Nuendo.

NOTE

Most remote-control devices are able to control both MIDI and audio channels in Nuendo, but the parameter setup may be different. Audio-specific controls such as EQ are disregarded when controlling MIDI channels.

RELATED LINKS

[Generic Remote Page](#) on page 869

Connecting Remote Devices

You can connect your remote device via USB or via MIDI.

PROCEDURE

- Do one of the following:
 - If your remote device provides a USB MIDI port, use a USB cable to connect it to the USB port of your computer.
 - If your remote device provides a MIDI output, use a MIDI cable to connect it to a MIDI input on your MIDI interface.

NOTE

If the remote unit features feedback devices such as indicators, motorized faders, etc., connect a MIDI Out on the interface to a MIDI In on the remote unit.

RELATED LINKS

[MIDI Connections](#) on page 25

Removing the Remote Input from All MIDI Inputs

To avoid that you accidentally record data from the remote unit when you record MIDI, you must remove the remote input from **All MIDI Inputs**.

PROCEDURE

1. Select **Studio > Studio Setup**.
2. In the **Devices** list, select **MIDI Port Setup**.
3. In the table on the right, deactivate **In 'All MIDI Inputs'** for the MIDI input to which you have connected the MIDI remote unit.
The **State** column reads **Inactive**.
4. Click **OK**.

RESULT

The remote unit input is removed from the **All MIDI Inputs** group.

RELATED LINKS

[MIDI Port Setup Page](#) on page 25

Setting up Remote Devices

PROCEDURE

1. Select **Studio > Studio Setup**.
2. Click **Add** in the top left corner and select a remote device from the pop-up menu to add it to the **Devices** list.

NOTE

If your device is not available in the pop-up menu, select **Generic Remote**.

3. In the **Devices** list, select the device.
Depending on the selected device, either a list of programmable function commands or a blank panel is shown in the right half of the dialog window.

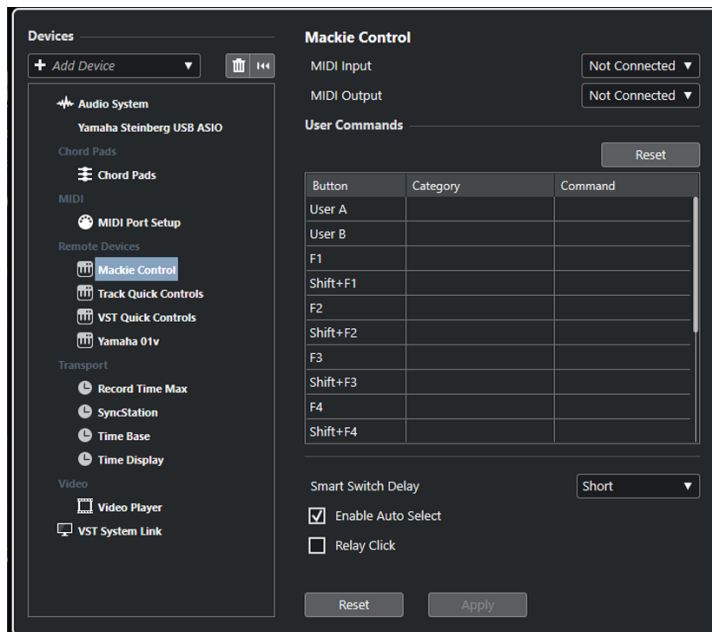

4. Open the **MIDI Input** pop-up menu and select a MIDI input.
 5. Optional: Open the **MIDI Output** pop-up menu and select a MIDI output.
 6. Click **OK**.
-

RESULT

You can now use the MIDI device to control Nuendo functions.

A bright stripe in the **Project** window and in the **MixConsole** indicates which channels are linked to the remote-control device.

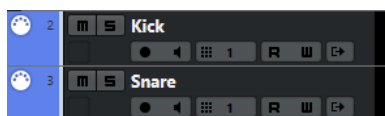

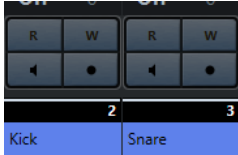

You can open a panel for the added device by selecting **Studio > More Options**.

AFTER COMPLETING THIS TASK

Depending on your external MIDI control device, you might need to configure the parameters.

Resetting Remote Devices

Sometimes you must reset remote devices, because the communication between Nuendo and a remote device was interrupted or the handshaking protocol fails to create a connection.

PROCEDURE

1. Select **Studio > Studio Setup**.
2. In the **Devices** list, select the remote device.
3. Click **Reset** in the lower part of the **Studio Setup** dialog to reset the selected remote device.

NOTE

To reset all devices in the **Devices** list, click **Reset** in the top left of the dialog.

Global Options for Remote Controllers

On the page for your remote device, global functions may be available.

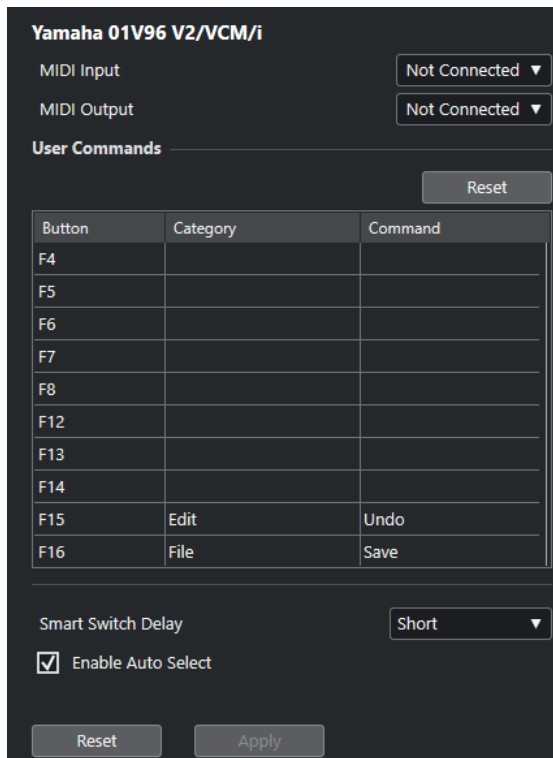

MIDI Input

Allows you to select a MIDI input.

MIDI Output

Allows you to select a MIDI output.

User Commands

Lists the controls or buttons of your remote device.

Smart Switch Delay

Allows you to specify a delay for the smart switch function. Functions that support the smart switch behavior are activated for as long as the button is pressed.

Enable Auto Select

On touch-sensitive remote control devices, this automatically selects a channel when you touch a fader. On devices without touch-sensitive faders, the channel gets selected as soon as you move the fader.

Remote Devices and Automation

You can write automation using remote devices.

If your remote device does not have touch-sensitive controls and you want to replace existing automation data in **Write** mode, consider the following:

- Make sure that you move only the controller that you want to replace.
- Stop playback to deactivate **Write** mode.

This way, all data for the corresponding parameter is replaced from the position where you moved the control, up to the position where you stop playback.

Assigning Commands to Remote Devices

You can assign any Nuendo command to which a key command can be assigned to remote devices.

PROCEDURE

1. Select **Studio > Studio Setup**.
2. In the **Devices** list, select your remote device.
In the **User Commands** section, the controls or buttons of your remote device are listed in the **Button** column.

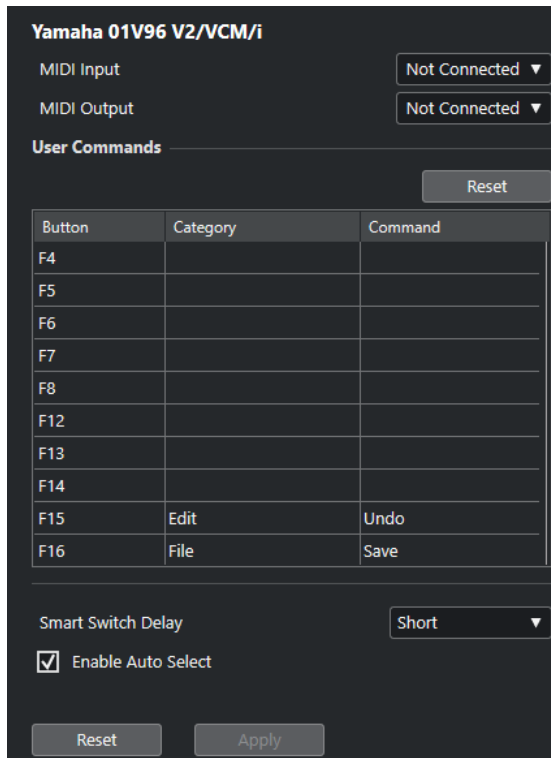

3. Click in the **Category** column for the control to which you want to assign a Nuendo command, and select the category from the pop-up menu.
The categories correspond to the categories in the **Key Commands** dialog.
4. Click in the **Command** column, and select the Nuendo command from the pop-up menu.
The available items on the pop-up menu depend on the selected category.
5. Click **Apply**.

RESULT

The selected function is assigned to the button or control on the remote device.

RELATED LINKS

[Key Commands](#) on page 1313

Generic Remote Page

You can use a generic MIDI controller to remote-control almost any function in Nuendo. After setting up the **Generic Remote** device, you can control the specified parameters from the MIDI remote device.

- To open the **Generic Remote** page, select **Studio > Studio Setup**, and from the **Devices** list, select **Generic Remote**.

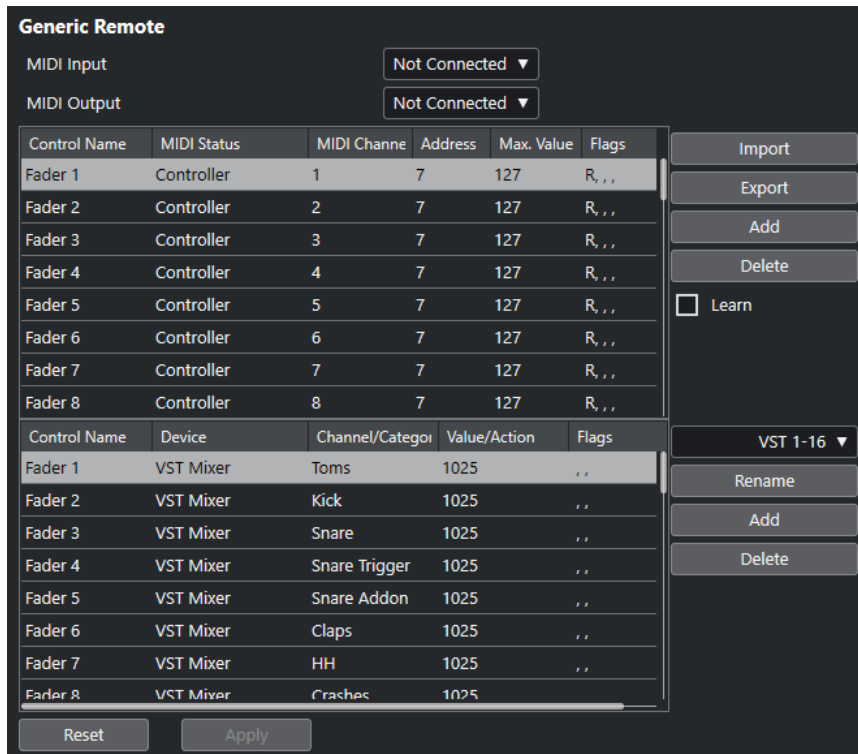

The following options are available:

MIDI Input

Allows you to select the MIDI input port to which your remote device is connected.

MIDI Output

Allows you to select the MIDI output port to which your remote device is connected.

MIDI Remote Control Configuration

The upper table shows the MIDI remote-control configuration of your remote device.

Nuendo Control Assignment

The lower table allows you to assign Nuendo controls to your remote device.

RELATED LINKS

[MIDI Remote Control Configuration Section](#) on page 870

[Nuendo Control Assignment Section](#) on page 872

MIDI Remote Control Configuration Section

The MIDI remote-control configuration section is shown in the upper table of the **Generic Remote** setup page.

- To open the **Generic Remote** settings, select **Studio > Studio Setup**, and from the **Devices** list, select **Generic Remote**.

Control Name	MIDI Status	MIDI Channe	Address	Max. Value	Flags
Fader 1	Controller	1	7	127	R, , ,
Fader 2	Controller	2	7	127	R, , ,
Fader 3	Controller	3	7	127	R, , ,
Fader 4	Controller	4	7	127	R, , ,
Fader 5	Controller	5	7	127	R, , ,
Fader 6	Controller	6	7	127	R, , ,
Fader 7	Controller	7	7	127	R, , ,
Fader 8	Controller	8	7	127	R, , ,

Buttons: Import, Export, Add, Delete, Learn

The following options are available in the upper table:

Control Name

Double-click this field to change the name for the control, and enter the one written on the console, for example. This name is automatically reflected in the lower table.

MIDI Status

Allows you to specify the type of MIDI message sent by the control.

MIDI Channel

Allows you to select the MIDI channel on which the controller is transmitted.

Address

Allows you to specify the continuous controller number, the pitch of a note, or the address of an NRPN/RPN continuous controller.

Max. Value

Allows you to specify the maximum value that the control transmits. This value is used by the program to scale the value range of the MIDI controller to the value range of the program parameter.

Flags

Allows you to select one of the following flags:

- **Receive**
Activate this if the MIDI message should be processed on reception.
- **Transmit**
Activate this if a MIDI message should be transmitted when the corresponding value in the program changes.
- **Relative**
Activate this if the control is an endless rotary encoder, which reports the number of turns instead of an absolute value.
- **Pick-up**
Activate this if you want the control to pick up the parameter at the value to which it was last set.

The buttons and options to the right of the table have the following function:

Import

Allows you to import saved remote setup files.

Export

Allows you to export the current setup with the file extension **.xml**.

Add

Adds controls to the bottom of the table.

Delete

Deletes the selected control from the table.

Learn

Allows you to assign MIDI messages by learning.

Nuendo Control Assignment Section

You can specify the Nuendo control assignment section in the lower table of the **Generic Remote** setup page. Each row in the table is assigned to the controller in the corresponding row in the MIDI remote-control configuration table.

- To open the **Generic Remote** settings, select **Studio > Studio Setup**, and from the **Devices** list, select **Generic Remote**.

Control Name	Device	Channel/Category	Value/Action	Flags
Fader 1	VST Mixer	Toms	1025	..
Fader 2	VST Mixer	Kick	1025	..
Fader 3	VST Mixer	Snare	1025	..
Fader 4	VST Mixer	Snare Trigger	1025	..
Fader 5	VST Mixer	Snare Addon	1025	..
Fader 6	VST Mixer	Claps	1025	..
Fader 7	VST Mixer	HH	1025	..
Fader 8	VST Mixer	Crashes	1025	..

The following options are available:

Control Name

Reflects the control name selected in the upper table.

Device

Allows you to select the Nuendo device that you want to control.

Channel/Category

Allows you to select the channel or the command category that you want to control.

Value/Action

Allows you to select the parameter of the channel that you want to control. If the **Command** device is selected, this is where you specify the **Action** of the category.

Flags

Allows you to select one of the following flags:

- **Push Button**
Activate this if the parameter should only be changed if the received MIDI message shows a value unequal to 0.
- **Toggle**
Activate this if the parameter value should be switched between minimum and maximum value each time a MIDI message is received.
You can combine **Push Button** and **Toggle** for remote controls which do not latch the state of a button. This is useful if you want to control the mute status with a device on which pressing the mute button turns it on, and releasing the mute button turns it off.
- **Not Automated**
Activate this if the parameter value should not be automated.

The buttons to the right of the table have the following function:

Bank pop-up menu

Allows you to switch banks. This is necessary if your MIDI control device has 16 volume faders, and you are using 32 **MixConsole** channels in Nuendo, for example.

Rename

Allows you to rename the selected bank.

Add

Adds banks to the pop-up menu.

Delete

Deletes the selected bank from the pop-up menu.

RELATED LINKS

[Assignable Devices and Functions](#) on page 873

Assignable Devices and Functions

The **Device** column in the Nuendo control assignment section lists the Nuendo devices that you can control.

Command

Allows you to assign the Nuendo commands to which a key command can be assigned. If you select **Add Track** in the **Channel/Category** column, and **Audio** in the **Value/Action** column, you can add audio tracks using your MIDI device, for example.

VST Quick Controls Manager

Allows you to assign **VST Quick Controls**. If you select **Device** in the **Channel/Category** column, and one of the **Quick Control** options in the **Value/Action** column, you can control that **VST quick control** using your MIDI device.

Midi Mixer

Allows you to control the functions of the **Midi Mixer** panel. If you select **Device** in the **Channel/Category** column, and one of the options in the **Value/Action** column, you can control that function using your MIDI device.

MMC Master

Allows you to control the functions of the **MMC Master** panel. If you select **Device** in the **Channel/Category** column, and one of the options in the **Value/Action** column, you can control that function using your MIDI device.

Mixer

Allows you to control **MixConsole** functions. If you select one of the available channels or **Selected** in the **Channel/Category** column, and one of the options in the **Value/Action** column, you can control that function of that specific channel or of the selected channel using your MIDI device.

Transport

Allows you to control the transport functions. If you select **Device** in the **Channel/Category** column, and one of the options in the **Value/Action** column, you can control that function using your MIDI device.

Metronome

Allows you to control metronome functions. If you select **Device** in the **Channel/Category** column, and one of the options in the **Value/Action** column, you can control that function using your MIDI device.

VST Mixer

Allows you to control **MixConsole** functions. If you select one of the available channels or **Selected** in the **Channel/Category** column, and one of the options in the **Value/Action** column, you can control that function of that specific channel or of the selected channel using your MIDI device.

VST Control Room

Allows you to control the functions of the **Control Room**. If you select **Device** in the **Channel/Category** column, and one of the options in the **Value/Action** column, you can control that function using your MIDI device.

NOTE

You can also control all **VST Instruments** that you added in the **Project** window, and that are listed in the **Device** column.

Assigning MIDI Messages in Learn Mode

You can assign MIDI messages in **Learn** mode.

PROCEDURE

1. Select **Studio > Studio Setup**.
 2. In the **Devices** list, select **Generic Remote**.
 3. Activate **Learn**.
 4. Select the control in the upper table, and move the corresponding control on your MIDI device.
-

RESULT

The values for **MIDI Status**, **MIDI Channel**, and **Address** are automatically set to those of the moved control.

NOTE

If you use the **Learn** function for a control that sends a program change value, **Prog. Change Trigger** is automatically selected in the **MIDI Status** pop-up menu. This allows you to use the different values of a program change parameter to control different parameters in Nuendo.

If this does not give you the result you want, try using the **Prog. Change** value instead.

Remote Control Editor

The **Remote Control Editor** allows you to define your own mapping of VST plug-in parameters to the controls of the supported hardware controllers. This is useful if you think that the automatic mapping of plug-in parameters to remote control devices is not too intuitive.

- To open the **Remote Control Editor**, right-click the plug-in panel of the plug-in that you want to remote-control, and select **Remote Control Editor**.

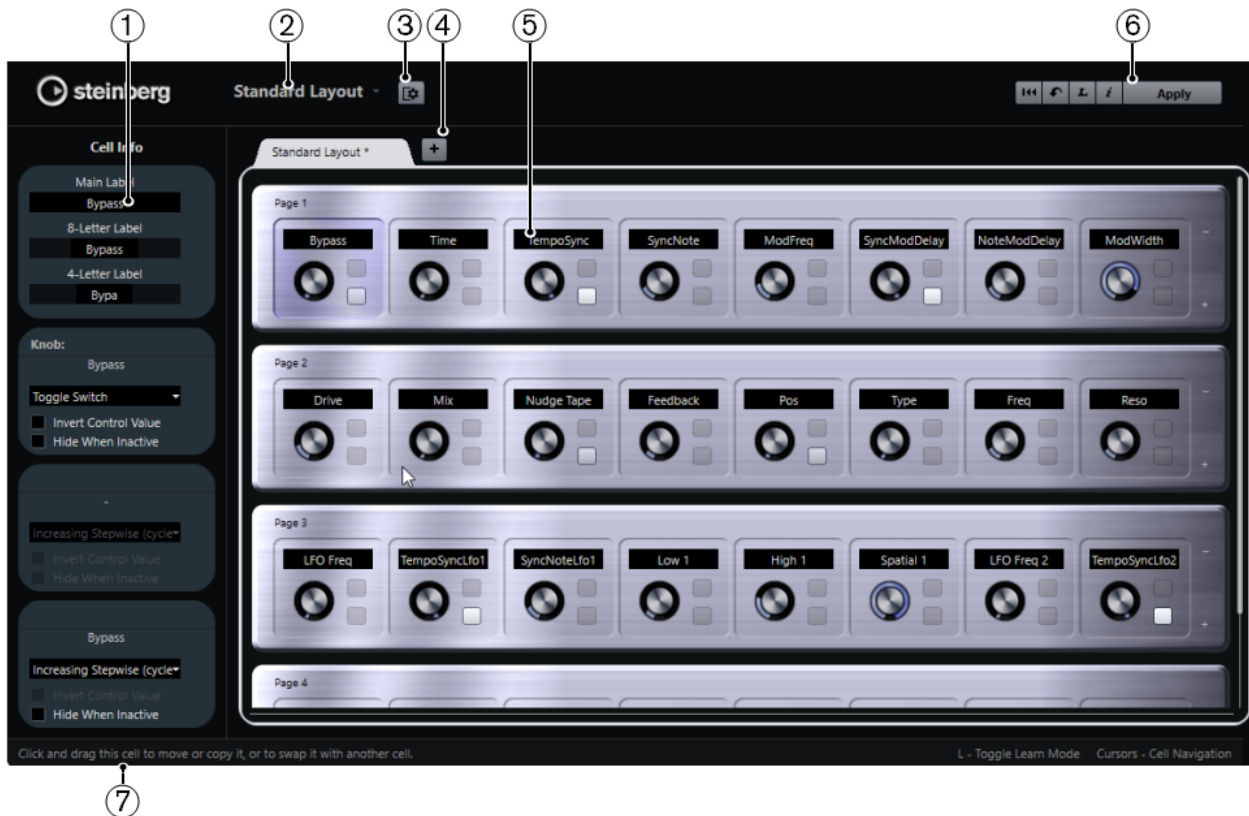

1 Inspector

Contains the settings and the parameter assignment for the selected cell. The upper section contains settings for the text label. The lower section contains settings for the knob and the switches.

2 Layout Selection

Shows the name of the layout. Click to select a different layout.

3 Set up Cell Layout

Opens the **Cell Layout Configuration**, where you can specify the number of cells per page, and select the switch layout that you want to use for the pages. To specify the number of switches for a cell, activate/deactivate them.

4 Add New Hardware Layout

Adds a new layout for a particular hardware type. To remove a hardware layout, click its **Close** button.

5 Layout section

Shows layouts that represent the hardware devices that are used to remote-control the plug-in parameters. Here you can change the parameter assignments, the name in the text label, the cell setup, and the order of cells and pages.

6 Toolbar

Shows tools for setting up the layout.

7 Status Bar

Shows information on an element when you position the mouse pointer over it in the editor window.

RELATED LINKS

[Remote Control Editor Toolbar](#) on page 876

Remote Control Editor Toolbar

Shows tools for setting up the layout.

Remove All Assignments



Removes all parameter assignments.

Get Default Factory Layout/Copy Layout from Other Tab



Reverts to the default settings for the current layout or copies the settings of one layout page to another.

Activate/Deactivate Learn Mode



Activates/Deactivates **Learn** mode for the **Remote Control Editor**.

Activate/Deactivate Assignment Inspection View



Shows the current assignment of all cells in a layout.

Apply Current Layout

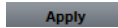

Saves the settings. If the hardware supports this function, the changes are immediately reflected on the hardware controllers.

Control Settings

You can define the control style for switches or knobs to which you have assigned a function. This includes changing the LED ring or changing its behavior, from continuous value representation to on/off, for example.

To open the **Control Settings** panel, right-click the control.

NOTE

Not all hardware devices support all control type settings.

Control Type Settings for Knobs

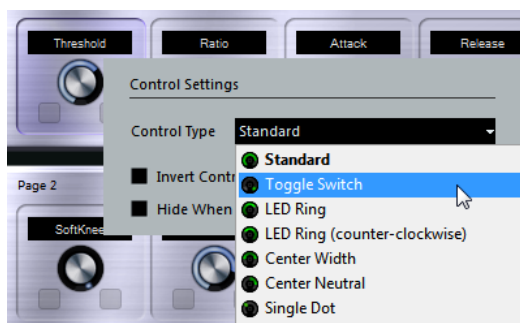

The following control types are available for knobs:

Standard

A standard knob with undefined LED style.

Toggle Switch

A knob with 2 states.

LED Ring

An LED ring around the knob. The setting increases clockwise.

LED Ring (counter-clockwise)

An LED ring around the knob. The setting increases counter-clockwise.

Center Width

An LED ring that starts at the top center position, and when the settings increase, an LED is shown growing in both directions.

Center Neutral

A dial that starts at the top center position and can be moved left or right, like a pan control, for example.

Single Dot

An LED ring around the knob. The setting increases clockwise with a dot indicating the current value.

Control Type Settings for Switches

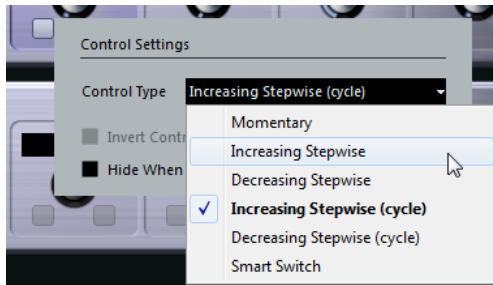

The following options are available for switches:

Momentary

Activates the assigned function as long as you hold the switch.

Increasing Stepwise

Steps through the available settings until the maximum is reached.

Decreasing Stepwise

Steps through the available settings in reverse order until the minimum is reached.

Increasing Stepwise (cycle)

Steps through the available settings, starting over with the minimum value when the maximum is reached.

Decreasing Stepwise (cycle)

Steps through the available settings in reverse order, starting over with the maximum value when the minimum is reached.

Smart Switch

Switches between 2 states every time you press the switch. Enters **Momentary** mode if you hold the switch.

Invert Control Value

Inverts the control state/value.

Hide When Inactive

Hides plug-in parameters when they are inactive or disabled.

Assigning Parameters to Controls

PROCEDURE

1. On the **Remote Control Editor** toolbar, click **Activate/Deactivate Learn Mode**.
 2. Select the control that you want to assign to a plug-in parameter.
 3. Do one of the following:
 - Click a parameter on the plug-in panel.
 - Double-click on a control in the **Remote Control Editor**, and select a parameter from the list of available plug-in parameters.
 4. Press **Esc** to end **Learn** mode.
-

RESULT

The parameter is assigned to the control.

NOTE

To remove the parameter assignment for a cell, activate **Learn** mode, select the cell, and press **Delete** or **Backspace**.

RELATED LINKS

[Remote Control Editor Toolbar](#) on page 876

Editing the Layout

In the layout section, you can perform a number of editing operations and arrange the pages to your liking.

- To navigate from cell to cell, use the cursor keys.
- To step through the controls within the cells in **Learn** mode, press **Shift** and use the cursor keys.
- To step through the different layouts, use **Tab** and **Shift-Tab**.
- To copy the settings of one cell to another, select a cell, press **Alt** and drag it to another cell.
- To move a cell, drag it to an empty cell.
- To swap the contents of 2 cells, press **Ctrl/Cmd** and drag one cell to the other.

NOTE

Drag and drop also works between different pages.

- To add a page to a layout, click **Add New Page**.



- To remove a page, click **Remove Current Page**.
- To specify the label for a cell, use the top 3 text fields in the **Inspector**.

The first text field shows the long name, as it is shown in the cell. In the second field, you can enter a name that can contain up to 8 characters, and up to 4 characters in the third.

NOTE

This is useful if your hardware devices have value fields that only display a limited number of characters, for example.

Joysticks

You can use a joystick to remote-control panning operations in Nuendo. This can be useful, for example, for creating smooth automation curves.

- To use a joystick for remote-controlling, connect it to your computer and restart Nuendo. After restarting the application, the joystick is automatically activated.

RELATED LINKS

[Panning with a Joystick](#) on page 764

[Deactivating Joysticks](#) on page 879

Deactivating Joysticks

If you have a joystick connected to your system, but do not want to use it with Nuendo, you can deactivate it.

PROCEDURE

1. Select **Studio > Studio Setup**.
 2. In the **Devices** list, select the joystick device.
The available device settings are shown to the right.
 3. Deactivate the respective option.
-

Track Quick Controls

If you have an external remote control device, you can set it up to control up to 8 parameters of each audio track, MIDI track or instrument track, using the **Track Quick Controls** feature in Nuendo.

RELATED LINKS

[Connecting Track Quick Controls with Remote Controllers](#) on page 863

VST Quick Controls

If you have an external remote control device, you can control up to 8 parameters of a VST instrument, using the **VST Quick Controls** feature in Nuendo.

RELATED LINKS

[Connecting Track Quick Controls with Remote Controllers](#) on page 863

[VST Quick Controls](#) on page 848

MIDI Realtime Parameters and MIDI Effects

MIDI realtime means that you can change or transform MIDI events on MIDI or instrument tracks before they are sent to the MIDI outputs. This allows you to change the way MIDI data is played back.

The actual MIDI events on the track are not affected. Therefore, MIDI realtime changes are not reflected in any MIDI editor.

The following functions allow you to change MIDI events in real time:

- MIDI track parameters
- MIDI modifiers
- MIDI effects
- **Transpose** and **Velocity** on the info line

NOTE

If you want to convert the track settings to real MIDI events, select **MIDI > Freeze MIDI Modifiers** or **MIDI > Merge MIDI in Loop**.

RELATED LINKS

[Merging MIDI Events into a New Part](#) on page 902

MIDI Track Parameters

The MIDI track parameters are located in the topmost **Inspector** section for MIDI and instrument tracks.

These settings either affect the basic functionality for the track (mute, solo, enable record, etc.) or send out additional MIDI data to the connected devices (program change, volume, etc.).

The following track parameters allow you to change MIDI events in real time:

- MIDI Volume
- MIDI Pan
- Track Delay
- Input Transformer

RELATED LINKS

[MIDI Track Inspector](#) on page 140

[Input Transformer](#) on page 880

Input Transformer

The **Input Transformer** allows you to filter out and change MIDI data coming to a MIDI track before it is recorded.

Use the **Input Transformer** for the following purposes:

- Set up split keyboard combinations for recording left and right hands separately.
- Convert a controller, such as a foot pedal, into MIDI notes (for playing bass drum the right way).
- Filter out a specific type of MIDI data on one MIDI channel only.
- Turn aftertouch into any controller and vice versa.
- Invert velocity or pitch.

Input Transformer Window

To open the **Input Transformer** window, do one of the following:

- Select a MIDI or instrument track, click **Input Transformer** , and select **Global**. This allows you to make settings that affect all MIDI inputs and all MIDI tracks.
- Select a MIDI or instrument track, click **Input Transformer**, and select **Local**. This allows you to make settings for the selected track only.

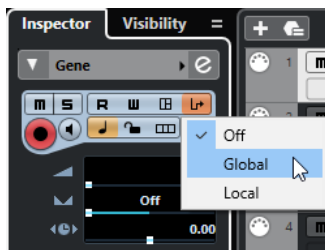

The **Input Transformer** window contains the following parameters:

Select Preset

Allows you to select a preset for the **Input Transformer**.

Module selector

Allows you to view and edit a module.

Filter conditions list

Allows you to set up the filter conditions, determining which elements to find. The list can contain one or several conditions, each on a separate line.

Action list

Allows you to specify any changes that are made to the found events.

Function pop-up menu

Allows you to select between **Filter** and **Transform** as a basic type of editing to be performed.

Specifying Filter Conditions

PROCEDURE

1. Select a MIDI or instrument track.
2. Perform one of the following actions:
 - To make settings that affect all MIDI tracks, open the **Inspector**, click **Input Transformer**, and select **Global** from the pop-up menu.
 - To make settings that affect the selected MIDI track, open the **Inspector**, click **Input Transformer**, and select **Local** from the pop-up menu.
3. Open the **Function** pop-up menu, and perform one of the following actions:
 - Select **Filter** if you want to filter the found events.
 - Select **Transform** if you want to transform the found events.
4. Click **+** to add a line to the filter conditions list.
5. In the filter conditions list, specify the conditions to match by clicking the **Filter Target**, **Condition**, and **Parameter** columns and selecting options from the pop-up menu.
6. In the action list, specify how the found events are transformed or filtered by clicking the **Action Target**, **Operation**, and **Parameter** columns and selecting options from the pop-up menu.

NOTE

You can also select a preset from the **Select Preset** pop-up menu to specify conditions and actions.

RESULT

The settings affect all MIDI events that you record on the track.

AFTER COMPLETING THIS TASK

In the **Inspector**, click **Input Transformer**, and select **Off**. Otherwise the **Input Transformer** is still active.

MIDI Modifiers

MIDI modifiers allow you to modify MIDI events during playback.

You can use them for the following purposes:

- To modify already existing MIDI events on MIDI or instrument tracks.
- To modify MIDI events that you play live.

NOTE

For live playing, select and record-enable the track, and activate **MIDI Thru Active** in the **Preferences** dialog (**MIDI** page).

MIDI Modifiers Section

- To open the **MIDI Modifiers** section, select a MIDI track, and in the **Inspector**, click **MIDI Modifiers**.

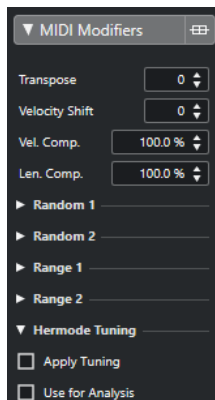

NOTE

If you want to compare the result of your modifier settings with the unprocessed MIDI, you can use the bypass button in the MIDI modifiers section. If this button is activated, the MIDI modifiers settings are temporarily disabled.



Transpose

Allows you to transpose all notes on the track in semitones. Extreme transpositions can give rather strange and unwanted results.

Velocity Shift

Allows you to add a velocity value to all notes on the track. Positive values increase the velocity while negative values lower the velocity.

Length Compression

Allows you to add a multiplier to the length of all notes on the track. The value is set with a numerator and a denominator.

Velocity Compression

Allows you to add a multiplier to the velocity of all notes on the track. The value is set with a numerator and a denominator. This parameter also affects the velocity differences between the notes, thus compressing or expanding the velocity scale. Values smaller than 1/1 compress the velocity range. Values greater than 1/1 together with negative **Velocity Shift** values expand the velocity range.

IMPORTANT

The maximum velocity is always 127, no matter how much you try to expand.

NOTE

Combine this setting with the **Velocity Shift** parameter.

Random 1/Random 2

Allows you to introduce random variations to various properties of MIDI notes.

Range 1/Range 2

Allows you to specify a pitch or velocity range and either force all notes to fit within this range, or exclude all notes outside this range from playback.

HMT: Apply Tuning

Activate this option to apply Hermode tuning to the notes played on this track.

HMT: Use for Analysis

Activate this option to use the notes you played on this track to calculate retuning.

RELATED LINKS

[Musical Scale Setup Dialog](#) on page 1061

Setting up Random Variations

You can set up random variations for position, pitch, velocity, and length of MIDI events using one or two random generators.

PROCEDURE

1. Select a MIDI or instrument track.
2. In the **Inspector**, open the **MIDI Modifiers** section.
3. Open one of the **Random** sections and in the **Random Target** pop-up menu, select the note property you want to randomize.
4. Specify the limits of the randomization in the value fields.
The values will vary between the minimum and maximum value. You cannot set the minimum value higher than the maximum value.
5. Optional: Repeat for other random values.
6. Play back the track to hear the randomized events.

RESULT

The corresponding properties are randomized.

NOTE

Depending on the track content, certain changes might not be immediately noticeable or might have no effect at all.

AFTER COMPLETING THIS TASK

Deactivate the random function by opening the **Random Target** pop-up menu and selecting **Off**.

Setting up Ranges

You can filter out pitches or velocities that do not match a specified range, or force them to fit a specified range.

PROCEDURE

1. Select a MIDI or instrument track.
2. In the **Inspector**, open the **MIDI Modifiers** section.
3. Open one of the **Range** sections, and in the **Range Target** pop-up menu and select a mode.
4. Set the minimum and maximum values with the two fields to the right.

NOTE

You can make independent settings for the two **Range** sections.

AFTER COMPLETING THIS TASK

To deactivate the function, open the **Range Target** pop-up menu and select **Off**.

Range Modes

On the **Range Target** pop-up menu, you can select different range modes. Values are shown as numbers, from 0 to 127, for the velocity modes and as note numbers, from C-2 to G8, for the pitch modes.

Vel. Limit

Allows you to force all velocity values to fit within the range that you specify with the **min** and **max** values. Values below the lower limit are set to the **min** value, velocity values above the higher setting are set to the **max** value.

Vel. Filter

Allows you to filter out notes with velocity values below the **min** value or above the **max** value.

Note Limit

Allows you to transpose all notes below the **min** value upwards and all notes above the **max** value downwards in octave steps.

Note Filter

Allows you to filter out notes that are lower than the **min** value or higher than the **max** value.

Applying Hermode Tuning

Hermode tuning changes the tuning of notes that you play. It creates clear frequencies for every fifth and third interval, for example. Retuning only affects individual notes and maintains the pitch relationship between keys and notes. The retuning is a continuous process and takes the musical context into account.

PROCEDURE

1. Select a MIDI or instrument track.
2. In the **Inspector**, open the **MIDI Modifiers** section.
3. Activate **HMT: Apply Tuning**.
4. Activate **HMT: Use for Analysis** to use the notes you play to calculate retuning.

NOTE

If you use tracks with acoustic piano, activate **HMT: Use for Analysis** and deactivate **HMT: Apply Tuning**. This excludes the piano from being tuned which would sound unnatural.

5. Select **Project > Project Setup** to open the **Project Setup** dialog.
6. Open the **HMT Type** pop-up menu and select one of the options.
7. Play some notes.

It may take a moment until all notes are recalculated and you hear the results of the retuning.

NOTE

Notes that are produced by MIDI plug-ins are not taken into account.

RESULT

If you use a VST 3 instrument that supports Micro Tuning and Note Expression, notes are retuned dynamically while you play them. For VST instruments that support Note Expression, this also works in **MIDI Thru** mode.

If you use a track that has a VST 2 instrument loaded, the notes you play are retuned on every keystroke.

RELATED LINKS

[Hermodé Tuning](#) on page 886

Hermodé Tuning

You can select different Hermodé tuning types.

- To select a Hermodé tuning type, select **Project > Project Setup** and select an option from the **HMT Type** pop-up menu.

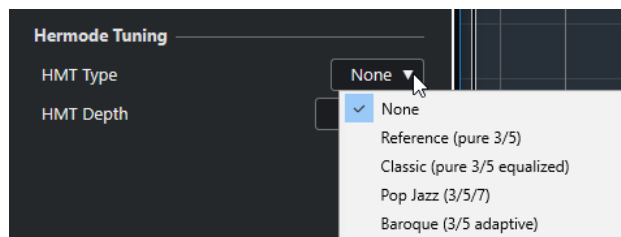

The following options are available:

None

No tuning is applied.

Reference (pure 3/5)

Tunes pure thirds and fifths.

Classic (pure 3/5 equalized)

Tunes pure thirds and fifths. In conflict situations, a slight equalization is applied. This tuning type is suitable for all kinds of music.

Pop Jazz (3/5/7)

Tunes pure thirds and fifths, and natural sevenths. This tuning type should not be applied to polyphonic music. Try this with pop or jazz.

Baroque (3/5 adaptive)

Tunes pure thirds and fifths. The degree of purity changes according to the sequence of harmonies. This tuning type is suitable for church organ and polyphonic music.

Freezing MIDI Modifiers

You can apply all filter settings permanently to the selected track. The settings are applied to the events on the track, and all modifiers are set to zero.

PROCEDURE

1. Select the MIDI track.

2. Select **MIDI > Freeze MIDI Modifiers**.

RESULT

The following settings are frozen:

- Several settings in the top section of the **Inspector**, such as **Delay**, **Program Selector**, and **Bank Selector**.
- The settings in the **MIDI Modifiers** section, such as **Transpose**, **Vel. Shift**, **Vel. Comp.**, and **Len. Comp.**.
- The settings in the **MIDI Inserts** section, such as arpeggiators.
- The info line settings **Transpose** and **Velocity**.

RELATED LINKS

[MIDI Track Inspector](#) on page 140

MIDI Effects

MIDI effects allow you to transform the MIDI data played back from the track in real time.

You can add new events by using MIDI effects, or change MIDI event properties like pitches, for example.

NOTE

The included MIDI effect plug-ins are described in the separate document **Plug-in Reference**.

MIDI Inserts

MIDI insert effects are inserted in the signal chain of MIDI channels. If you add an insert effect to a MIDI track, the MIDI events on the track are sent to the effect and processed by it. The whole signal passes through the effect.

- To open the **MIDI Inserts** section, select a MIDI track, and in the **Inspector**, click **MIDI Inserts**.

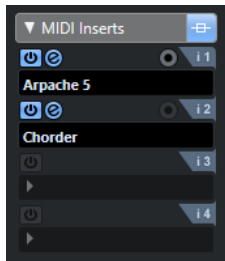

You can add up to four MIDI insert effects. The following parameters are available:

Bypass

Allows you to bypass all insert effects for the track.

Activate Insert

Allows you to activate/deactivate the selected effect.

Open/Close Insert Effect Editor

Allows you to open/close the control panel for the selected effect. Depending on the effect, this may appear in a separate window or below the insert slot in the **Inspector**.

Select Effect Type

Allows you to select and activate an effect and open its control panel. To remove an effect, select **No Effect**.

Record Output to Track

Allows you to record the output of the MIDI insert effect on a MIDI or instrument track.

NOTE

To open a separate control panel for effects that display their controls in the **Inspector**, press **Alt** and click **Open/Close Insert Effect Editor**.

Applying a MIDI Insert Effect

You can apply MIDI insert effects to a MIDI track.

PROCEDURE

1. Select the MIDI track.
 2. In the **Inspector**, open the **MIDI Inserts** section.
 3. Click **Select Effect Type** to open the MIDI effect pop-up menu.
 4. Select a MIDI effect from the pop-up menu.
-

RESULT

The effect is automatically activated and its control panel is opened, allowing you to make settings for the effect. All MIDI from the track is routed through the effect.

NOTE

The included MIDI effects are described in the separate document **Plug-in Reference**.

Recording a MIDI Insert Effect

You can record the output of a MIDI insert effect, that is, the events are created directly on a MIDI or instrument track.

PROCEDURE

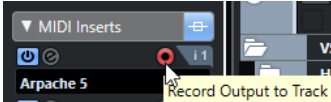
1. In the global track controls area of the track list, click **Add Track** .
 2. Click **Instrument**.
 3. Open the **Instrument** pop-up menu and select a VST instrument.
 4. Click **Add Track**.
The instrument track is added to the track list, and the control panel of the selected VST instrument is opened.
 5. On the instrument track, activate **Record Enable**.
 6. In the **Inspector**, open the **MIDI Inserts** section.
 7. Click the first insert effect slot and select a MIDI insert effect.
 8. Activate **Record Output to Track**.

 9. On the **Transport** panel, activate **Record** and use your MIDI keyboard or the **On-Screen Keyboard** to play some notes.
-

RESULT

The notes that you play are modified by the MIDI insert effect and recorded directly on the track.

AFTER COMPLETING THIS TASK

You can edit the recorded MIDI events in the **Key Editor**, for example.

MIDI Sends

If you use a send effect, the MIDI events are sent both to the output of the MIDI track and to the send effect. This way, you get both the unprocessed MIDI events and the output of the MIDI effect. Note that the effect can send its processed MIDI data to any MIDI output, not necessarily to the one used by the track.

- To open the **MIDI Sends** section, select a MIDI track, and in the **Inspector**, click **MIDI Sends**.

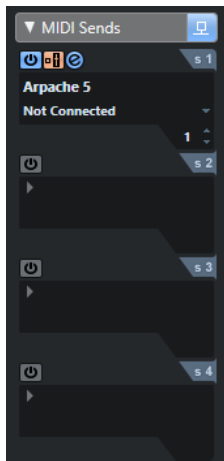

You can add up to four MIDI send effects.

Bypass

Allows you to bypass all send effects for the track.

Activate Send

Allows you to activate/deactivate the selected effect.

Pre/Post

Activate this to send the MIDI signals to the send effects before the MIDI modifiers and insert effects.

Open/Close Send Effect Editor

Allows you to open/close the control panel for the selected effect. Depending on the effect, this may appear in a separate window or below the sends slot in the **Inspector**.

Select Effect Type

Allows you to select and activate an effect and open its control panel. To remove an effect, select **No Effect**.

MIDI Send Destination

Allows you to determine to which MIDI output the processed MIDI events are sent.

MIDI Send Channel

Allows you to determine on which MIDI channel the processed MIDI events are sent.

NOTE

To open a separate control panel for effects that display their controls in the **Inspector**, press **Alt** and click **Open/Close Send Effect Editor**.

Presets

Some of the MIDI effects come with a number of presets for instant use.

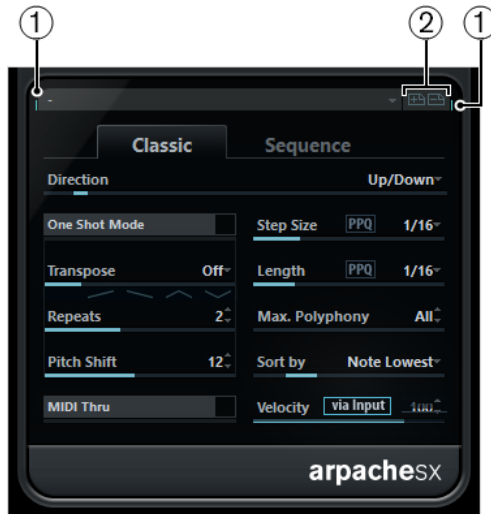

1 MIDI In/MIDI Out Activity

Indicates if the plug-in receives or transmits MIDI data.

2 Save Preset/Remove Preset

Allows you to save your settings as a preset or to remove saved presets. Saved presets are available in the **Select Preset** pop-up menu for all instances of that MIDI plug-in, and in all projects.

Transpose and Velocity on the Info Line

You can edit the transposition and the velocity for selected MIDI parts on the info line. This only affects the notes in playback.

- Use the **Transpose** field to transpose the selected parts in semitone steps. The value is added to the transposition set for the whole track.
- Use the **Velocity** field to offset the velocity for the selected parts. The value is added to the velocities of the notes in the parts.

RELATED LINKS

[Transpose Functions](#) on page 360

Using MIDI Devices

The **MIDI Device Manager** allows you to work with MIDI devices, that is, representations of external MIDI hardware.

You can install preset MIDI devices or define new ones. This is useful for global control and patch selection.

You can create MIDI device panels, and create device maps where every parameter of an external device or a VST instrument can be controlled and automated from inside Nuendo.

RELATED LINKS

[Device Panels](#) on page 897

Program Change Messages and Bank Select Messages

To select a patch, that is, a sound in your MIDI device you must send a program change message to that device.

Program Change Messages

You can record program change messages, or enter them in a MIDI part. You can open the **Inspector** for the MIDI track and select a value in the **Program Selector** field.

Program change messages allow you to select between 128 different patches in your MIDI device.

Bank Select Messages

Many MIDI instruments, however, contain a larger number of patch locations. To make these available from within Nuendo, you must send bank select messages.

Bank select messages allow you to select between 128 different programs in your MIDI device.

If your device supports MIDI bank select, you can open the **Inspector** for the MIDI track and select a value in the **Bank Selector** field to select a bank, and then use the **Program Selector** field to select a program in this bank.

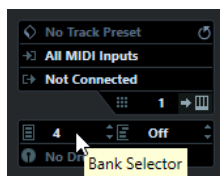

Unfortunately, different instrument manufacturers use different schemes for how bank select messages are constructed, which can lead to some confusion and make it hard to select the correct sound. Also, selecting patches by numbers seems unnecessarily cumbersome, when most instruments use names for their patches nowadays.

The **MIDI Device Manager** allows you to specify which MIDI devices you are using, and to select to which device each MIDI track is routed. This allows you to select patches by name in the track list or **Inspector**.

RELATED LINKS

[MIDI Device Manager](#) on page 892

Patch Banks

The **Patch Banks** list can have two or more main banks, depending on the selected device.

This is due to the fact that different types of patches are handled differently in the instruments. Patches, for example, typically are regular programs that you play one at a time. Performances, however, may be combinations of programs, which could be split across the keyboard, layered, or used for multitimbral playback, and so on.

For devices with several banks you can select **Bank Assignment** to specify which bank a specific MIDI channel should use.

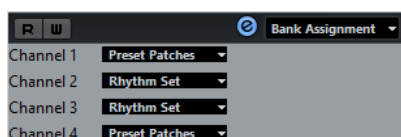

The **Bank Assignment** affects which bank is displayed when you select programs by name for the device in the track list or **Inspector**.

Many instruments use MIDI channel 10 as an exclusive drum channel, for example. If this is the case, select the **Drums** or **Rhythm Set** or **Percussion** bank for channel 10 in this list. This allows you to choose between different drum kits in the track list or **Inspector**.

Limitations

There is no easy way to import a patch name script into an existing MIDI device. For a complex workaround based on XML editing, see the separate document **MIDI Devices**.

MIDI Device Manager

The **MIDI Device Manager** allows you to install preset MIDI devices or define new ones.

- To open the **MIDI Device Manager**, select **Studio > More Options > MIDI Device Manager**.

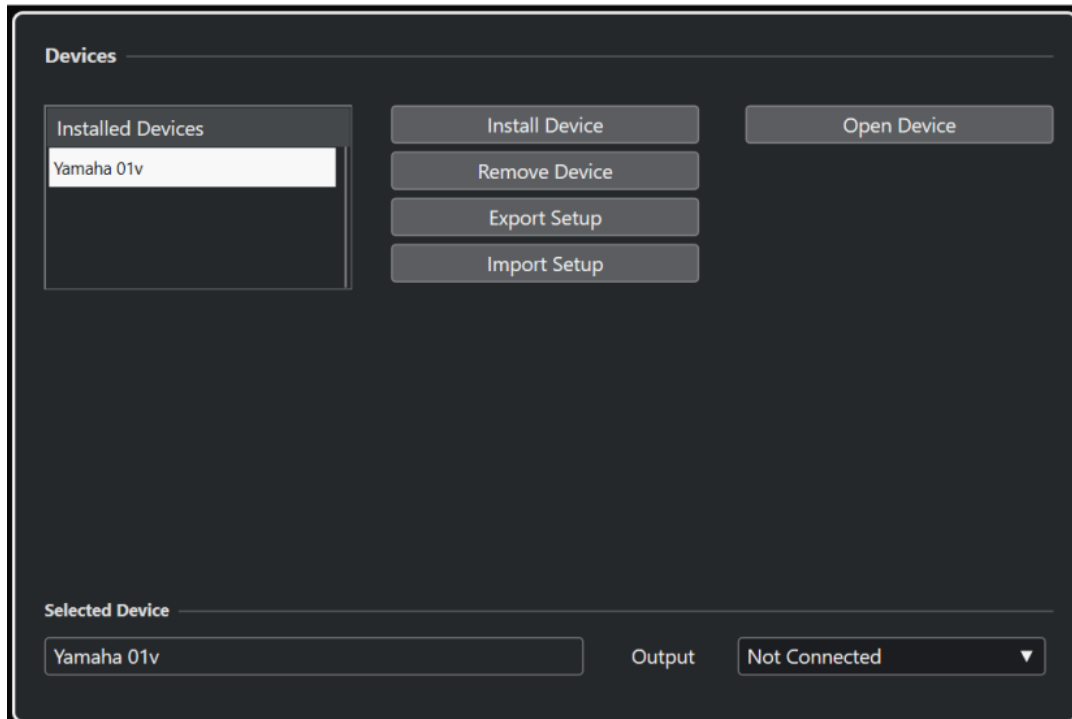

Installed Devices list

Lists the connected MIDI devices and the imported device setups.

Install Device

Allows you to install a preset device. These presets are simple patch name scripts that do not include any device mapping of parameters and controls and no graphic panels.

For more information about patch name scripts, see the separate document **MIDI Devices**.

Remove Device

Removes the selected device.

Export Setup

Exports the MIDI device setup as XML file.

Import Setup

Allows you to import an XML file of a MIDI device setup. Device setups can include device mapping, panels and/or patch information.

Open Device

Opens the selected device.

Output

Allows you to select a MIDI output for the selected device.

RELATED LINKS

[Device Panels](#) on page 897

Commands for Patches

In the **MIDI Device Manager**, patches can be structured in banks, folders, and presets.

NOTE

Activate **Enable Edit** to use the commands pop-up menu for the selected device.

The commands pop-up menu contains the following items:

Create Bank

Creates a new bank in the **Patch Banks** list. You can rename this by clicking on it and typing a new name.

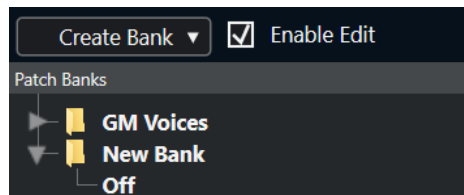

New Folder

Creates a new subfolder in the selected bank or folder. This could correspond to a group of patches in the MIDI device, or just be a way for you to categorize sounds.

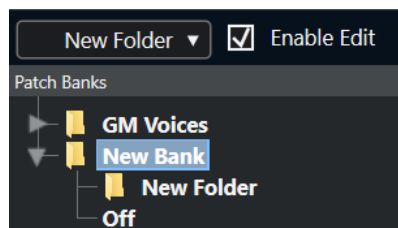

New Preset

Adds a new preset in the selected bank or folder. If you select it, the corresponding MIDI events are shown to the right. The default program change value for a new preset is 0, but you can adjust the number in the **Value** column.

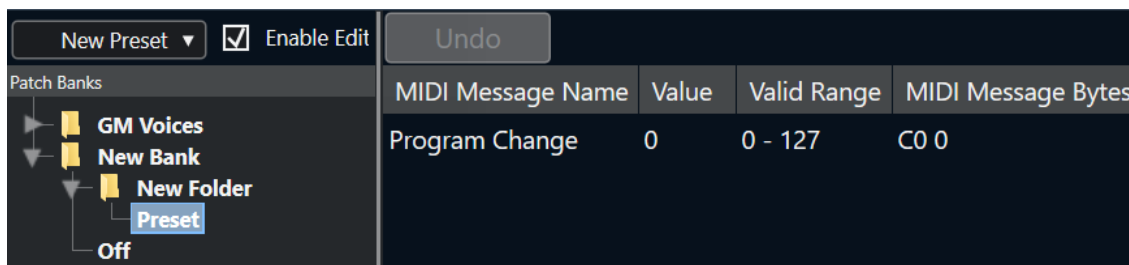

You can move presets between banks and folders via drag and drop.

Add Multiple Presets

Allows you to set up a range of presets and add them to the selected bank or folder.

NOTE

You can remove banks, folders, and presets by selecting them and pressing **Backspace**.

IMPORTANT

For details on which MIDI events are used for selecting patches in the MIDI device, consult its documentation.

RELATED LINKS

[Add Preset Functions](#) on page 895

[Patch Banks](#) on page 892

Add Preset Functions

If you add or select a preset for the selected bank or folder, further functions become available to the right. If you add multiple presets, the **Add Multiple Presets** dialog opens with further functions.

The following columns are available:

MIDI Message Name

The name of the MIDI message.

- To change an event, click it, and select another option from the pop-up menu.
- To add another event, click below the last event, and select an option from the pop-up menu.
- To remove an event, select it and press **Delete** or **Backspace**.

IMPORTANT

If you insert a **Bank Select** event, keep in mind that, depending on your device, you must choose **CC: BankSelect MSB**, **Bank Select 14 Bit**, **Bank Select 14 Bit MSB-LSB Swapped** or some other option.

Value

The value of the event.

MIDI Message Bytes

The message bytes of the event.

Valid Range

The valid range of the event.

Default Name

For multiple presets you can specify a default name. The added events will get this name, followed by a number.

Installing Preset MIDI Devices

You can install preset MIDI devices, that is, patch name scripts that do not include device mapping.

PROCEDURE

1. Select **Studio > More Options > MIDI Device Manager**.
2. Click **Install Device**.
3. In the **Add MIDI Device** dialog, do one of the following:
 - Select the script of the device in the list.
 - Select **GM Device** or **XG Device** if your device is not listed, but compatible with these standards, and type in the name of your instrument in the next dialog.
4. Click **OK**.
5. Select the device in the **Installed Devices** list, and open the **Output** pop-up menu.
6. Select the MIDI output that the device is connected to.
7. Click **Open Device**.

A window showing a node structure for the selected device opens. For more information, see the separate PDF document **MIDI Devices**.

8. Open the pop-up menu at the top of the window, and select **Patch Banks**.

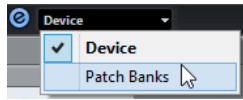

RESULT

The structure of the patch name script is shown. It usually has one or several layers of banks or groups with patches.

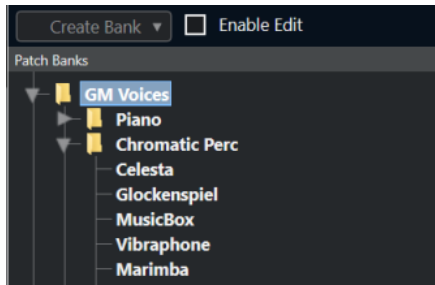

Selecting Patches for Installed Devices

If you installed a device and you select it from the **Output Routing** pop-up menu for the MIDI track, you can select patches by name.

PROCEDURE

1. Select the MIDI track that you want to associate to the installed device, and open the top section of the **Inspector**.
2. Open the **Output Routing** pop-up menu, and select the installed device.
This routes the MIDI track to the MIDI output specified for the device in the **MIDI Device Manager**. The **Bank Selector** and the **Program Selector** fields are replaced by a single **Program Selector** field that reads **Off**.
3. Open the **Program Selector**.

A program list, similar to the one in the **MIDI Device Manager**, is shown.

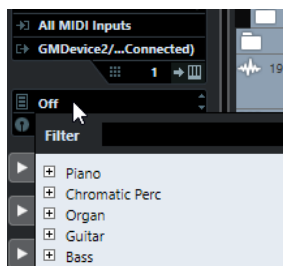

4. Select an entry in the list.

RESULT

The corresponding MIDI message is sent to the device.

Renaming Patches in Devices

If you have replaced some of the factory presets with your own patches, you can modify the device so that the patch name list matches the actual device.

PROCEDURE

1. Select **Studio > More Options > MIDI Device Manager**.
2. Select the device in the **Installed Devices** list.
3. Click **Open Device**.
4. Activate **Enable Edit**.
5. In the **Patch Banks** list, locate the patch you want to rename and click the name.
6. Type in the new name and press **Return**.

RESULT

The patch is renamed.

AFTER COMPLETING THIS TASK

To avoid modifying the device by accident, deactivate **Enable Edit**.

Defining New MIDI Devices

You can define new MIDI devices.

PROCEDURE

1. Select **Studio > More Options > MIDI Device Manager**.
2. Click **Install Device**.
3. In the **Add MIDI Device** dialog, select **Define New**.
4. Click **OK**.
5. In the **Create New MIDI Device** dialog, enter the name of the device.
6. In the **Identical Channels** section, activate the MIDI channels you would like to use.
For a description of **Identical Channels** and **Individual Channels**, see the separate document **MIDI Devices**.
7. Click **OK**.
8. Select the device in the **Installed Devices** list.
9. In the pop-up menu at the top of the window, select **Patch Banks**.
10. Activate **Enable Edit** and use the commands pop-up menu to organize the patch structure of the new device.

Device Panels

The **MIDI Device Manager** allows you to build device maps complete with control panels, including all parameters controllable from within Nuendo.

You can create simple device panels by assigning MIDI Control Change messages to control objects.

If you want to build more complex device maps, you must make yourself familiar with SysEx programming (see the separate document **MIDI Devices**).

Device panels are saved in XML format. For more information, see the separate document **MIDI Devices**.

Importing Device Setups

PROCEDURE

1. Select **Studio > More Options > MIDI Device Manager**.
 2. Click **Import Setup**.
 3. In the file dialog, select a setup file.
Setup files are saved in XML format, for more information see the separate document **MIDI Devices**.
 4. Click **Open**.
 5. In the **Import MIDI Devices** dialog, select one or several devices for import, and click **OK**.
-

RESULT

The device is added to the **Installed Devices** list in the **MIDI Device Manager**.

Opening Device Panels

PROCEDURE

1. Select **Studio > More Options > MIDI Device Manager**.
 2. In the **Installed Devices** list, select the device.
 3. From the **Output** pop-up menu, select the correct MIDI output.
 4. Click **Open Device**.
-

RESULT

The device panel opens in a separate window.

To edit the panel, click the **Edit** button, see the separate document **MIDI Devices**.

Showing Device Panels in the Inspector

PROCEDURE

1. In the **Project** window, select a MIDI track and from the **Output Routing** pop-up menu, select the device.
2. Optional: Set the MIDI channel to **Any**.
This is required for some devices.
3. In the **Inspector**, open the **Device Panel** section and click the arrow to the right.
A **Panels** folder is shown with the selected device in a node structure below it.

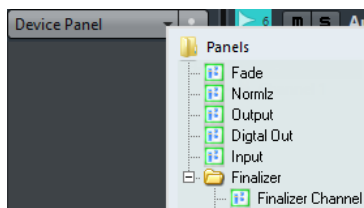

NOTE

If you cannot see any panels in the **Panels** folder, although you have successfully set up a MIDI device with several panels, make sure that you selected the correct channel from the **Channel** pop-up menu, preferably **Any** to see all device panels. Also make sure that the panels fit into the space, otherwise they will not be available in the **Panels** folder.

4. Select a panel from the list.
The panel opens in the **Inspector**.



RESULT

Now you can open the device panel by clicking **Open Device Panels** in the **Inspector** or in the channel for the corresponding track in the **MixConsole**.

NOTE

Note that **Ctrl/Cmd**-clicking the **Open Device Panels** button allows you to open a subpanel via the panel browser pop-up menu.

Showing Device Panels in the MixConsole

PROCEDURE

1. Select **Studio > MixConsole**.
 2. Click **Racks** to open the rack selector and activate **Device Panels**.
 3. Click the arrow button to the right of the **Panel** header.
A **Panels** folder is shown with the selected device in a node structure below it.
 4. Select a panel from the list.
The panel is shown in the **Channel Racks** section of the **MixConsole**.
-

Automating Device Parameters

You can automate device panels just like regular audio and MIDI tracks.

PROCEDURE

1. In the **Inspector**, click **Open Device Panels** to open the device panel.
2. On the device panel, activate **Write Automation**.

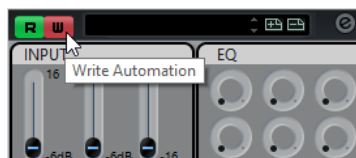

3. Move the knobs and sliders on the device panel.
-

RESULT

In the **Project** window, a **MIDI Device Automation** track is added to the track list.

NOTE

If the track is hidden, select **Project > Track Folding**, and select **Show All Used Automation**.

If you open the name field, all automation parameters in the device are shown and can be selected.

NOTE

If you wrote automation but your MIDI device is not yet connected, the panel will not display any parameter changes when playing back the track with the **Read** button activated.

MIDI Functions

MIDI functions allow you to permanently edit MIDI events or MIDI parts in the **Project** window or from within a MIDI editor.

Which events are affected when you use a MIDI function depends on the function, the active window, and the current selection:

- In the **Project** window, the MIDI functions apply to all selected parts, affecting all events of the relevant types in them.
- In the MIDI editors, MIDI functions apply to all selected events. If no events are selected, all events in the edited parts are affected.

NOTE

Some MIDI functions only apply to MIDI events of a certain type. For example, **Delete Controllers** only applies to MIDI controller events.

RELATED LINKS

[MIDI Realtime Parameters and MIDI Effects](#) on page 880

Transpose Setup Dialog

The **Transpose Setup** dialog contains settings for transposing the selected events.

- To open the **Transpose Setup** dialog, select the MIDI notes that you want to transpose, and select **MIDI > Transpose Setup**.

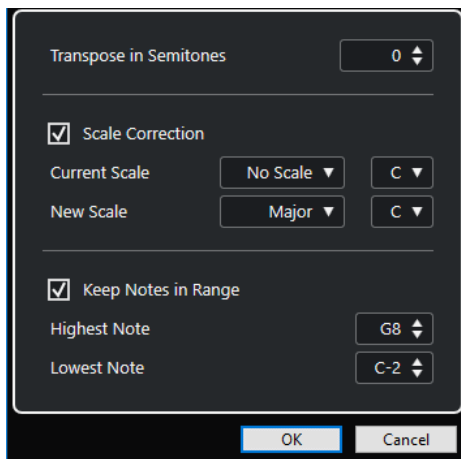

The following settings are available:

Transpose in Semitones

Sets the amount of transposition.

Scale Correction

Transposes the selected notes to the closest note of a specific scale type. This allows you to change the key and the tonality.

- Select a root note and a scale type for the current scale in the **Current Scale** pop-up menus.

- Select a root note and a scale type for the new scale in the **New Scale** pop-up menus.

NOTE

If the new root note differs from the current root note, this leads to an entirely different key.

Keep Notes in Range

Limits the transposition of notes to the note values that you specify with the **Highest Note** and **Lowest Note** settings.

NOTE

Notes that would be outside the range after transposition are shifted to another octave, keeping the correct transposed pitch if possible. If the range between the upper and lower limit is very narrow, the note is transposed as far as possible, that is, to notes specified with the **Highest Note** and **Lowest Note** values. If you set **Highest Note** and **Lowest Note** to the same value, all notes are transposed to this pitch.

NOTE

You can also use the transpose track for transposing.

RELATED LINKS

[Transpose Functions](#) on page 360

[Musical Scale Setup Dialog](#) on page 1061

Merging MIDI Events into a New Part

You can merge all MIDI events, apply MIDI modifiers and effects, and generate a new part.

PROCEDURE

1. Do one of the following:
 - Mute the tracks or parts that you do not want to include in the merge.
 - Solo the track that contains the events that you want to include in the merge.
2. Set up the left and right locators to encompass the area that you want to merge.

NOTE

Only events starting within this area will be included.

3. Optional: Select a track for the new part.
If you do not select a track, a new MIDI track is created. If several MIDI tracks are selected, the new part is inserted on the first selected track.
 4. Select **MIDI > Merge MIDI in Loop**.
 5. In the **MIDI Merge Options** dialog, make your changes.
 6. Click **OK**.
-

RESULT

A new part is created between the locators on the destination track, containing the processed MIDI events.

RELATED LINKS

[MIDI Merge Options Dialog](#) on page 903

[Freezing MIDI Modifiers](#) on page 886

MIDI Merge Options Dialog

- To open the **MIDI Merge Options** dialog, select a MIDI part, and select **MIDI > Merge MIDI in Loop**.

The following options are available:

Include Inserts

Applies MIDI insert effects and MIDI modifiers.

Include Sends

Applies MIDI send effects.

Erase Destination

Deletes MIDI data between the left and right locators on the destination track.

Include Chase

Includes events placed outside the selected part but relating to it in the processing, for example, a program change right before the left locator.

Convert VST 3

Converts all VST 3 data within the selected area to MIDI data.

RELATED LINKS

[Chase](#) on page 287

Applying Effects to a Single Part

You can apply MIDI modifiers and effects to a single part.

PROCEDURE

1. Set up your MIDI modifiers and MIDI effects the way you want them for the part.
 2. Set the locators to encompass the part.
 3. In the track list, select the track with the part.
 4. Select **MIDI > Merge MIDI in Loop**.
 5. In the **MIDI Merge Options** dialog, activate **Erase Destination**.
 6. Click **OK**.
-

RESULT

A new part is created on the same track, containing the processed events. The original part is deleted.

AFTER COMPLETING THIS TASK

Turn off or reset all MIDI modifiers and effects, so that the track plays back as before.

Dissolve Part Dialog

You can separate MIDI events in a part according to channels or pitches and dissolve the part to different tracks or lanes.

- To open the **Dissolve Part** dialog, select the MIDI part you want to dissolve and select **MIDI > Dissolve Part**.

The following settings are available:

Separate Channels

Separates MIDI events according to their channel. This is useful for MIDI parts on MIDI channel **Any** that contain events on different MIDI channels.

Separate Pitches

Separates MIDI events according to their pitch. This is useful for drum and percussion tracks, where different pitches usually correspond to separate drum sounds.

Optimized Display

Automatically removes silent areas of the resulting parts.

NOTE

This option is not available when **Dissolve to Lanes** is activated.

Dissolve to Lanes

Dissolves the part to lanes.

Dissolving Parts into Separate Channels

You can dissolve MIDI parts that contain events on different MIDI channels, and distribute the events into new parts on new tracks, one for each MIDI channel found.

PROCEDURE

1. Select the parts that contain MIDI events on different channels.
 2. Select **MIDI > Dissolve Part**.
 3. Activate **Separate Channels**.
 4. Click **OK**.
-

RESULT

For each MIDI channel used in the selected parts, a new MIDI track is created and set to the corresponding MIDI channel. Each event is copied into the part on the track with the corresponding MIDI channel, and the original parts are muted.

MIDI Channel Setting

Setting a track to MIDI channel **Any** causes each MIDI event to play back on its original MIDI channel, rather than a channel set for the whole track.

There are two main situations when **Any** channel tracks are useful:

- When you record several MIDI channels at the same time.
You may for example have a MIDI keyboard with several keyboard zones, where each zone sends MIDI on a separate channel. Setting the channel to **Any** allows you to play back the recording with different sounds for each zone (since the different MIDI notes play back on separate MIDI channels).
- When you have imported a MIDI file of Type 0.

MIDI files of Type 0 contain only one track, with notes on up to 16 different MIDI channels. If you were to set this track to a specific MIDI channel, all notes in the MIDI file would be played back with the same sound. Setting the track to **Any** causes the imported file to play back as intended.

Dissolving Parts into Separate Pitches

You can dissolve MIDI parts that contain events of different pitches and distribute the events into new parts on new tracks, one for each MIDI pitch found. This is useful if the different pitches are used for separating different sounds such as MIDI drum tracks or sampler sound FX tracks. By dissolving such parts, you can work with each sound individually, on a separate track.

PROCEDURE

1. Select the parts that contain MIDI events of different pitches.
 2. Select **MIDI > Dissolve Part**.
 3. Activate **Separate Pitches**.
 4. Click **OK**.
-

RESULT

For each MIDI pitch used in the selected parts, a new MIDI track is created. Each event is copied into the part on the track for the corresponding pitch, and the original parts are muted.

Dissolve to Lanes Option

You can dissolve MIDI parts that contain events on different MIDI channels of different pitches and distribute the events into new parts on new lanes of the original track.

Dissolving to lanes has the following advantages:

- You get a better overview of what MIDI material belongs together.
- It allows you to split a part into different drum sounds and edit these independently.
- It allows you to split instrument parts and still route them to the same VST instrument instance.

NOTE

To reassemble all events into one part, use **Bounce MIDI**.

RELATED LINKS

[Bouncing MIDI Parts](#) on page 905

Bouncing MIDI Parts

You can combine MIDI parts on different lanes to one MIDI part. This is useful if you want to reassemble a drum part that you dissolved to lanes, for example.

PROCEDURE

1. Select the MIDI parts on the different lanes that you want to combine.
 2. Select **MIDI > Bounce MIDI**.
-

RESULT

The selected MIDI parts are combined to one part. Any muted parts are removed. Transpose and velocity values that are set for the parts are taken into account.

Repeating MIDI Events of Independent Track Loops

You can repeat the MIDI events inside an independent track loop to fill up a MIDI part. This is useful if you want to convert the events of an independent track loop to actual MIDI events.

PREREQUISITE

You have set up an independent track loop and the **Key Editor** is open. The part ends after the end of the independent track loop.

PROCEDURE

- Select **MIDI > Repeat Loop**.

RESULT

The events of the independent track loop are repeated to the end of the part. Events that are located to the right of the independent track loop in the part are replaced.

RELATED LINKS

[Setting up the Independent Track Loop](#) on page 647

Extending MIDI Notes

You can extend MIDI notes so that they reach the next notes.

PREREQUISITE

A MIDI part with some note events is open in the **Key Editor**.

PROCEDURE

1. Select the note events that you want to extend to the next notes.
2. Select **MIDI > Functions > Legato**.

RESULT

The selected note events are extended to the start of the next notes.

NOTE

To specify a gap or overlap for this, adjust the **Legato Overlap** setting in the **Preferences** dialog (**Editing—MIDI** page).

RELATED LINKS

[Key Editor Inspector](#) on page 955

Fixing MIDI Note Lengths

You can set the length of selected MIDI notes to the **Length Quantize** value.

PREREQUISITE

A MIDI part with some note events is open in the **Key Editor**.

PROCEDURE

1. On the **Key Editor** toolbar, open the **Length Quantize** pop-up menu and select the desired note length.
 2. Select the note events that you want to fix.
 3. Select **MIDI > Functions > Fixed Lengths**.
-

RESULT

The selected note events are set to the specified **Length Quantize** value.

RELATED LINKS

[Key Editor Toolbar](#) on page 948

Fixing MIDI Note Velocities

You can set the velocity of selected MIDI notes to the **Note Insert Velocity** value.

PREREQUISITE

A MIDI part with some note events is open in the **Key Editor**.

PROCEDURE

1. On the **Key Editor** toolbar, open the **Set up Insert Velocities** pop-up menu and select a velocity value.
 2. Select the note events that you want to fix.
 3. Select **MIDI > Functions > Fixed Velocity**.
-

RESULT

The selected note events are set to the specified **Note Insert Velocity** value.

RELATED LINKS

[Key Editor Toolbar](#) on page 948

Rendering Sustain Pedal Data to Note Lengths

You can render sustain pedal data to note lengths. This is useful if you recorded MIDI data with a MIDI keyboard and a sustain pedal, and you want to extend the actual MIDI notes for as long as you held the pedal, in order to edit the notes later.

PREREQUISITE

You recorded MIDI using a MIDI keyboard and a sustain pedal. The MIDI part is open in the **Key Editor**.

PROCEDURE

1. Select the note events.
 2. Select **MIDI > Functions > Pedals to Note Length**.
-

RESULT

The selected notes are lengthened to match the sustain pedal off position, and the sustain controller on/off events are removed.

Deleting Overlaps

You can delete overlaps of notes that have the same or different pitches. This is useful if your MIDI instruments cannot handle overlapping events.

PROCEDURE

1. Select the note events.
2. Do one of the following:
 - Select **MIDI > Functions > Delete Overlaps (mono)**.
 - Select **MIDI > Functions > Delete Overlaps (poly)**.

RESULT

The overlapping MIDI notes are shortened, so that no note begins before another ends.

Editing Velocity

You can manipulate the velocity of notes.

PROCEDURE

1. Select the note events.
2. Select **MIDI > Functions > Velocity**.
3. Open the **Type** pop-up menu and select an option.
4. Depending on the **Type**, enter a **Ratio**, an **Amount** or an **Upper** and **Lower** value.
5. Click **OK**.

RESULT

The note velocities are changed according to your settings.

RELATED LINKS

[Velocity Dialog](#) on page 908

Velocity Dialog

- To open the **Velocity** dialog, select a MIDI part, and select **MIDI > Functions > Velocity**.

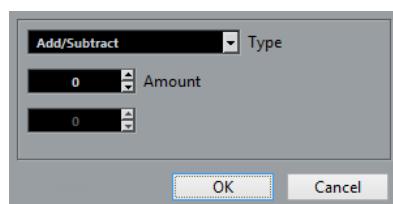

Add/Subtract

Adds the **Amount** value to the velocity value. You can enter positive or negative values.

Compress/Expand

Uses the **Ratio** setting (0 to 300 %) to compress or expand the dynamic range of MIDI notes. A factor higher than 1 (over 100 %) expands the differences between velocity values, while using a factor lower than 1 (under 100 %) compresses them.

- To compress the dynamic range, use ratio values below 100 %.

After compression, you can add a velocity amount to maintain the average velocity level.

- To expand the dynamic range, use ratio values above 100 %.
Before expansion, you can adjust the velocity to the middle of the range.

Limit

Limits the velocity values so that they stay between the **Lower** and the **Upper** values.

Deleting Double Notes

You can delete double notes of the same pitch on the exact same position from selected MIDI parts. Double notes can occur when recording in cycle mode, after quantizing, for example.

PROCEDURE

1. Select the MIDI part that contains the double notes.
2. Select **MIDI > Functions > Delete Doubles**.

RESULT

The double notes are automatically deleted.

Deleting Controller Data

You can delete controller data from selected MIDI parts.

PROCEDURE

1. Select the MIDI parts that contain the controller data.
2. Select **MIDI > Functions > Delete Controllers**.

RESULT

The controller data is automatically deleted.

Deleting Continuous Controller Data

You can delete continuous controller data from selected MIDI parts.

PROCEDURE

1. Select the MIDI parts that contain the controller data.
2. Select **MIDI > Functions > Delete Continuous Controllers**.

RESULT

The continuous controller data is automatically deleted. However, On/Off events, such as sustain pedal events, are kept.

Restricting Polyphonic Voices

You can restrict polyphonic voices in selected MIDI notes or parts. This is useful if you have an instrument with limited polyphony and want to make sure all notes are played.

PROCEDURE

1. Select the MIDI notes or parts that contain the voices.
2. Select **MIDI > Functions > Restrict Polyphony**.
3. Specify how many voices you want to use.
4. Click **OK**.

RESULT

The notes are shortened as required, so that they end before the next note starts.

Thinning Out Controller Data

You can thin out controller data in selected MIDI parts. Use this to ease the load on your external MIDI devices if you have recorded very dense controller curves.

PROCEDURE

1. Select the MIDI parts that contain the controllers that you want to thin out.
2. Select **MIDI > Functions > Thin Out Data**.

RESULT

The controller data is thinned out.

NOTE

This also thins out MIDI controller and VST 3 events that form part of Note Expression data.

Extracting MIDI Automation

You can convert continuous controllers of your recorded MIDI parts into MIDI track automation data, so that you can edit them in the **Project** window.

PROCEDURE

1. Select the MIDI part that contains the continuous controller data.
2. Select **MIDI > Functions > Extract MIDI Automation**.
3. Right-click the MIDI or instrument track in the **Project** window and select **Show All Used Automation (Selected Tracks)**.

This shows the MIDI controller data on the automation track.

RESULT

In the **Project** window, an automation track is created for each of the continuous controllers in the MIDI part.

In the MIDI editors, the controller data is removed from the controller lane.

NOTE

This only works for continuous controllers. Data such as aftertouch, pitchbend, or SysEx cannot be converted to MIDI track automation data.

MIDI controller automation is also affected by the **Automation Merge Mode**.

RELATED LINKS

[MIDI Controller Automation](#) on page 940

[Creating a Tempo Track from Tapping](#) on page 911

Reversing the Playback Order of MIDI Events

You can invert the order of the selected events or of all events in selected part rhythmically. This causes the MIDI to play backwards. However, this is different from reversing an audio recording. The individual MIDI notes still play as usual, but the playback order changes.

PROCEDURE

1. Select the MIDI events or the MIDI part.
 2. Select **MIDI > Functions > Reverse**.
-

RESULT

The playback order of the events is reversed while the individual notes still play as usual in the MIDI instrument. Technically, this function reverses the Note On message of a note within a part or selection.

Inverting the Order of Selected MIDI Events

This function inverts the order of the selected events, or of all events in the selected parts, graphically. Technically, this function turns a Note On message into a Note Off message and vice versa, which can lead to rhythmic inaccuracies if the Note Off position of a note has not been quantized.

PROCEDURE

1. Select the MIDI events or the MIDI part.
 2. Select **MIDI > Functions > Mirror**.
-

RESULT

The order of the events is inverted while the individual notes still play as usual in the MIDI instrument. Technically, this function turns a Note On message into a Note Off message and vice versa which can lead to rhythmic inaccuracies if the Note Off position of a note has not been quantized.

Creating a Tempo Track from Tapping

You can create a complete tempo track based on your tapping.

PREREQUISITE

You recorded some MIDI notes by tapping the tempo on your MIDI keyboard.

PROCEDURE

1. Select the recorded MIDI events or the whole part.
 2. Select **MIDI > Functions > Merge Tempo from Tapping**.
-

RESULT

The tempo that you tapped is calculated, and a tempo curve is created in the **Tempo Track Editor**.

RELATED LINKS

[Tempo Track Editor](#) on page 1133

MIDI Editors

There are several ways to edit MIDI in Nuendo. You can use the tools and functions in the **Project** window for large-scale editing or the functions on the **MIDI** menu to process MIDI parts in various ways. To manually edit your MIDI data on a graphical interface, you can use the MIDI editors.

- The **Key Editor** presents notes graphically in a piano roll-style grid. The **Key Editor** also allows for detailed editing of non-note events such as MIDI controllers.
- The **Score Editor** shows MIDI notes as a musical score and provides advanced tools and functions for notation, layout, and printing.
- The **Drum Editor** is similar to the **Key Editor**, but each key corresponds to a separate drum sound.

You can use the **Drum Editor** to edit drum or percussion parts.

- The **List Editor** shows all events in the selected MIDI parts as a list and allows you to view and edit their properties numerically. It also allows you to edit SysEx messages.
- The **In-Place Editor** allows you to edit MIDI parts directly in the **Project** window so that you can edit MIDI in context with other track types.

You can also edit MIDI in the Project Browser.

RELATED LINKS

[Key Editor](#) on page 945

[Drum Editor](#) on page 979

[List Editor](#) on page 998

[Project Browser](#) on page 1152

[In-Place Editor](#) on page 1012

Common MIDI Editor Functions

You can use the tools and functions within the MIDI editors to process MIDI parts in various ways.

Changing the Ruler Display Format

You can change the display format for the ruler. By default, the ruler shows the timeline in the display format that is selected on the **Transport** panel.

PROCEDURE

- Click the arrow button to the right of the ruler and select an option from the pop-up menu.
-

RELATED LINKS

[Ruler Display Format Menu](#) on page 60

Zooming in MIDI Editors

The MIDI editors provide several zooming options:

- The zoom sliders.



- The **Zoom** tool.
- The **Zoom** submenu in the **Edit** menu.

When you use the **Zoom** tool for zooming, you can determine if you want to zoom horizontal only or horizontal and vertical at a time.

- To activate/deactivate the corresponding option, activate/deactivate **Zoom Tool Standard Mode: Horizontal Zooming Only** in the **Preferences** dialog (**Editing—Tools** page).

Using Cut and Paste

You can use the **Cut**, **Copy**, and **Paste** options from the **Edit** menu to move or copy material within a part or between different parts.

- To insert note events at the project cursor position without affecting existing notes, select **Edit > Paste**.
- To insert note events at the project cursor position, move, and if necessary split the existing note events to make room for the pasted notes, select **Edit > Range > Paste Time**.

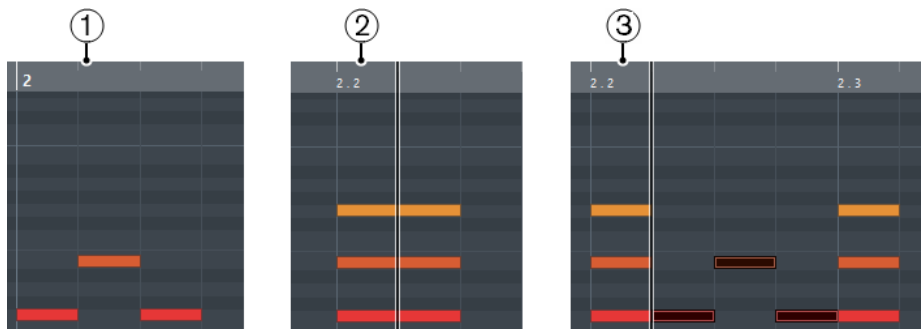

- 1 Data on clipboard
- 2 Cursor position
- 3 Pasted data at cursor position

Handling Note Events

Event Colors Menu

You can select different color schemes for the note events in the MIDI editor.

- To open the **Event Colors** pop-up menu, click **Event Colors** on the toolbar.

The following options are available:

Velocity

The note events get different colors depending on their velocity values.

Pitch

The note events get different colors depending on their pitch.

Channel

The note events get different colors depending on their MIDI channel value.

Part

The note events get the same color as their corresponding part in the **Project** window. Use this option if you are working with 2 or more tracks in an editor, to see which note events belong to which track.

Grid Match

The note events get different colors depending on their time position. For example, this mode enables you to see if the notes of a chord start at the exact same beat.

Sound Slot

The note events get different colors depending on the articulation that has been assigned to the note in the **Expression Map Setup** dialog.

Voice

The note events get different colors depending on their voice (soprano, alto, tenor, etc.).

Scale/Chords

The note events get different colors depending on whether they match the current chord, scale, or both.

For all of the options except **Part** and **Sound Slot**, the pop-up menu also contains a **Setup** option. This option opens a dialog in which you can specify the colors that are associated with velocities, pitches, or channels.

RELATED LINKS

[Selecting Note Events](#) on page 916

[Expression Maps](#) on page 1015

[Color Picker](#) on page 101

[Event Colors Setup Dialog](#) on page 915

Event Colors Setup Dialog

The event **Colors Setup** dialog allows you to set up colors for event properties such as velocities, pitches, channels or chords and scales.

- To open the event **Colors Setup** dialog for the selected color scheme option, open the **Event Colors** pop-up menu in the **Key Editor**, **Drum Editor**, **List Editor** or **In-Place Editor** toolbar, and select **Setup**.

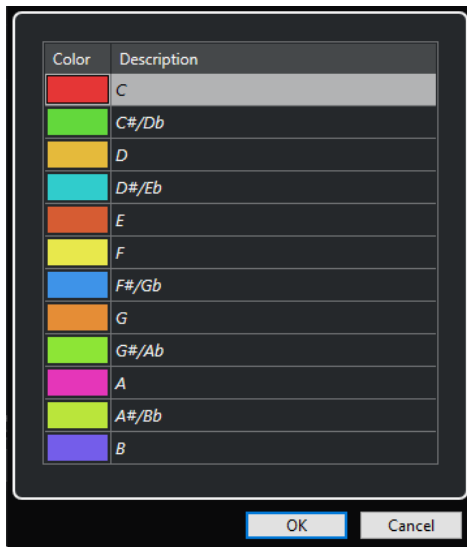

Pitch Color Setup dialog

The following options are available:

Color fields

Click a field to open the **Color Picker** that allows you to specify a new color.

Description

Shows further information about the usage of the color.

OK

Applies your changes and closes the dialog.

RELATED LINKS

[Event Colors Menu](#) on page 914

[Color Picker](#) on page 101

Selecting Note Events

The selected MIDI editor determines which of the following methods apply.

Do one of the following:

- Use the **Object Selection** tool to drag a selection rectangle around the note events that you want to select. You can also click individual events.
- Select **Edit > Select** and select one of the options.
- To select the previous or next note event, use the **Left Arrow / Right Arrow** key.
- To select several notes, press **Shift** and use the **Left Arrow / Right Arrow** key.
- To select all notes of a certain pitch, press **Ctrl/Cmd** and click on a key in the keyboard display to the left.
- To select all the following note events of the same pitch/staff, press **Shift** and double-click a note event.

NOTE

If you select the notes in the event display, the note event is shown in black and only its outline is shown in color. On the keyboard display, the keys that correspond to the note pitches of the selected notes are also shown in color.

RELATED LINKS

[Event Colors Menu](#) on page 914

[Select Submenu for Note Events](#) on page 917

[Editing](#) on page 1356

Select Submenu for Note Events

The **Select** submenu offers you several options to select note events.

- To open the **Select** submenu for a note event, select the note event, and select **Edit > Select**.

All

Selects all note events in the edited part.

None

Deselects all note events.

Invert

Inverts the selection. All selected note events are deselected and all notes that were not selected are selected instead.

In Loop

Selects all note events that are partially or completely inside the boundaries of the left and right locators (only visible if locators are set).

From Start to Cursor

Selects all note events that begin to the left of the project cursor.

From Cursor to End

Selects all note events that end to the right of the project cursor.

Equal Pitch - all Octaves

Selects all note events of the highlighted part that have the same pitch (in any octave) as the selected note event.

NOTE

This function requires that a single note event is selected.

Equal Pitch - same Octave

Selects all note events of the highlighted part that have the same pitch (same octave) as the selected note event.

NOTE

This function requires that a single note event is selected.

Select Controllers in Note Range

Selects the MIDI controller data within the range of the selected note events.

RELATED LINKS

[Deleting Note Events](#) on page 918

Muting Note Events

You can mute individual note events in a MIDI editor. Muting individual notes allows you to exclude note events from playback.

Do one of the following:

- Click on a note event with the **Mute** tool.
- Drag a rectangle with the **Mute** tool, enclosing all note events that you want to mute.
- Select the note events and select **Edit > Mute**.
- To unmute a note event, click it or enclose it with the **Mute** tool. You can also select a note event and select **Edit > Unmute**.

Muted notes are dimmed in the note display.

Toggle Selections

- To toggle selected elements within a selection rectangle, press **Ctrl/Cmd** and enclose the same elements within a new selection rectangle.

Once you release the mouse button, the previous selection is deselected and vice versa.

Deleting Note Events

- To delete note events, click on them with the **Erase** tool or select them and press **Backspace**.

Delete Notes Dialog

The **Delete Notes** dialog allows you delete note events that do not match a specific length or velocity.

- To open the **Delete Notes** dialog, select a MIDI part in the **Project** window, and select **MIDI > Functions > Delete Notes**.

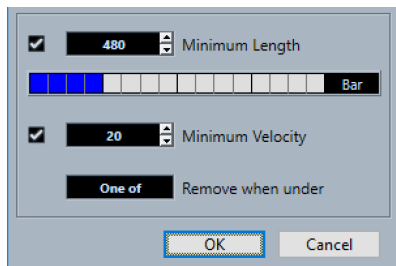

The following options are available:

Minimum Length

Allows you to set a minimum note length in ticks. Notes that are shorter than the set value are deleted. You can use the value field or the graphical length display. If you click the field to the right of the graphical length display the scale for the display changes. You can set it to 1/4 bar, one bar, two bars or four bars.

Minimum Velocity

Allows you to set a minimum note velocity. Notes with a lower velocity than the set value are deleted.

Remove when under

This option is only available if **Minimum Velocity** and **Minimum Length** are both activated. It allows you to select if both or just one of the criteria must be met for notes to be deleted.

Trimming Note Events

The **Trim** tool allows you to cut off the end or the beginning of note events.

PROCEDURE

1. Select the **Trim** tool on the toolbar.
 2. Do one of the following:
 - To trim the end of a single note event, click on the note event.
 - To trim the beginning of a single note event, press **Alt** and click the note event.
 - To trim several note events, click and drag across the note events.
 - To set the same start and end time for all edited note events, press **Ctrl/Cmd** and vertically drag along the note events.
-

Editing Note Events on the Info Line

You can move, resize, or change the velocity of note events on the info line using regular value editing.

- To apply a value change to all selected note events, press **Ctrl/Cmd** and change a value on the info line.
 - To adjust the pitch or velocity of note events via your MIDI keyboard, click in the **Pitch** or **Velocity** fields on the info line, and play a note on your MIDI keyboard.
- If you have several note events selected and change a value, all selected events are changed by the set amount.

Duplicating and Repeating Note Events

You can duplicate and repeat note events in the same way as events in the **Project** window.

- To duplicate the selected note events, hold down **Alt/Opt** and drag the note events to a new position.

If **Snap** is activated, it determines to which positions you can copy notes.

- To copy the selected note events and place them directly behind the original, select **Edit > Functions > Duplicate**.

If several note events are selected, all of them are copied as one unit, maintaining the relative distance between the note events.

- To create a number of copies of the selected note events, select **Edit > Functions > Repeat**, specify the number, and click **OK**.

You can also press **Alt/Opt** and drag the right edge of the note events to the right to create copies of the note events.



Finding Exact Positions with Snap

The **Snap** function restricts horizontal movement and positioning to certain positions. This helps you find exact positions in the note display when editing note events in a MIDI editor. Affected operations include moving, duplicating, drawing, sizing, etc.

- To activate/deactivate snap, click **Snap**.

If you select the **Bars+Beats** display format, the snap grid is set by the quantize value on the toolbar. This makes it possible to snap to straight note values and to swing grids that have been set up in the **Quantize Panel**.

- If you select any of the other display formats, positioning is restricted to the displayed grid.

Setting Velocity Values

When you draw note events in the MIDI editor, the note events get the velocity value that is set in the **Note Insert Velocity** field on the toolbar. There are different methods to set the velocity.

- Use the **Edit Velocity** tool modifier. The cursor changes into a speaker, and next to the note, a field with the Note Velocity slider shows the value. Move the mouse pointer up or down to change the value.



Value changes are applied to all selected notes.

For this, a tool modifier must be assigned for the **Edit Velocity** action. You can edit the tool modifier in the **Preferences** dialog (**Tool Modifiers** page).

- Open the **Note Insert Velocity** pop-up menu and select a velocity value. On this menu, you can also select **Setup** and specify custom velocity values for the pop-up menu.
- Double-click the **Note Insert Velocity** field on the toolbar and enter a velocity value.
- Assign key commands to **Insert Velocity 1-5** and use them. This allows you to quickly switch between different velocity values when you enter note events.

Handling Several MIDI Parts

- To activate a part for editing, open the **Currently Edited Part** pop-up menu and select a part. When you select a part from the list, it is automatically active and centered in the note display.
- To zoom in on an active part, select **Edit > Zoom > Zoom to Event**.
- To display defined borders for the active part, activate **Show Part Borders**. If this option is activated, all parts, except the active part, are grayed out.
- To restrict editing operations to the active part, activate **Edit Active Part Only**.
- To change the size of the part, drag the part borders. The part borders display the name of the active part.

NOTE

If the part that you open for editing is a shared copy, any editing that you perform affects all shared copies of this part. In the **Project** window, shared copies are indicated by an equal sign in the top right corner of the part.

Looping MIDI Parts

The **Independent Track Loop** function allows you to loop a MIDI part independent of the project playback.

When you activate the loop, the MIDI events within the loop are repeated continuously while other events on other tracks are played back as usual. Every time the cycle restarts, the independent track loop also restarts.

PROCEDURE

1. Activate **Independent Track Loop** on the toolbar.

NOTE

If you activate **Independent Track Loop**, the **Link Project and Lower Zone Editor Cursors** function is automatically deactivated in the **Editor** tab in the lower zone of the **Project** window.

If the button is not visible, right-click the toolbar and select **Independent Track Loop** from the context menu.

If you have set up a loop range in the **Project** window, it is hidden from the ruler in the MIDI editor.

2. **Ctrl/Cmd**-click in the ruler to specify the start of the independent track loop.
3. **Alt/Opt**-click in the ruler to specify the end of the independent track loop.

RESULT

The independent loop range is indicated in a different color.

The start and end of the loop range are displayed on the status line.

AFTER COMPLETING THIS TASK

To repeat the events of the loop range and fill up the active MIDI part, select **MIDI > Repeat Loop**.

Controller Display

The controller display is the area at the bottom of the **Key Editor**, the **Drum Editor**, and the **In-Place Editor**.

To show the controller display, do one of the following:

- Open the **Controller Lane Setup** pop-up menu in the **Key Editor**, the **Drum Editor**, or the **In-Place Editor**, and select **Show/Hide Controller Lanes**.
- On the **Key Editor** or the **Drum Editor** toolbar, click **Set up Window Layout**, and activate **Controller Lanes**.

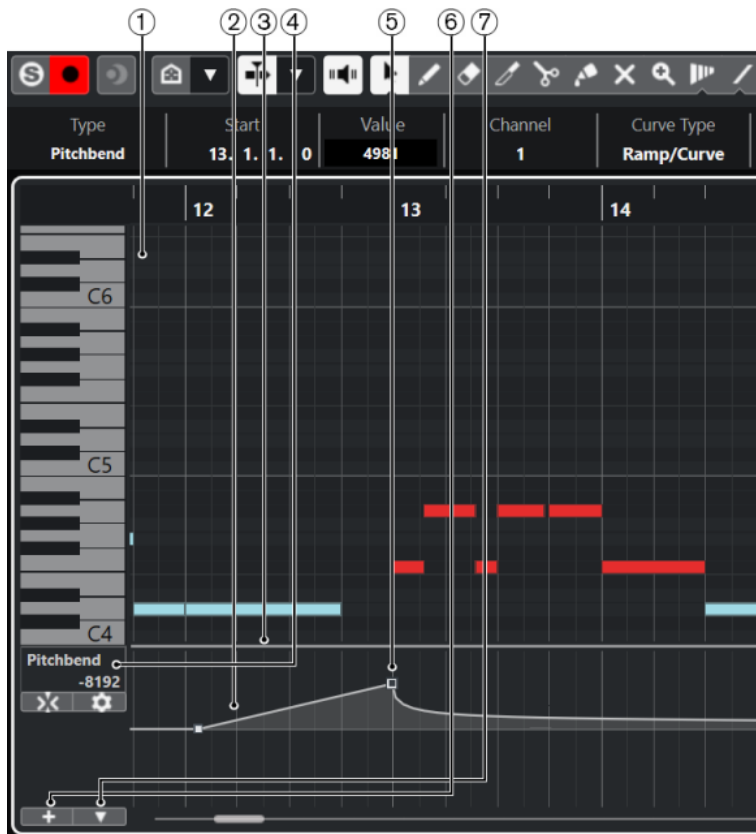

The following options are available:

1 Note display

Contains a grid in which MIDI notes are displayed as boxes.

2 Controller display

Shows one or multiple controller lanes.

3 Divider

Drag the divider between the note display and the controller display to resize the display areas.

4 Controller Selection and Functions menu

Allows you to select which controller type is displayed, and contains editing functions for controller lanes and events.

5 Controller events

The controller display shows the added controller events of the selected controller type and their current values. Controller events have no length. Their values are valid until the start of the next event.

Velocity values are shown as vertical bars, with higher bars corresponding to higher velocity values. Each velocity bar corresponds to a note in the note display.

All other controller events are shown as steps, with heights corresponding to the values of the events.

6 Create Controller Lane

Allows you to add controller lanes so that you can view and edit different controllers at the same time. Each controller lane can show one of the following properties or event types:

- Velocity
- Pitchbend
- Aftertouch

- Poly Pressure
- Program Change
- System Exclusive events
- Continuous Controllers
- Articulations/Dynamics

7 Controller Lane Setup

Contains setup functions for controller lanes, and allows you to add and organize presets.

Controller Lane Setup Menu

The **Controller Lane Setup** pop-up menu allows you to add lanes and select which event type is displayed.

- To open the **Controller Lane Setup** pop-up menu, click **Controller Lane Setup**  at the bottom left of the controller display.

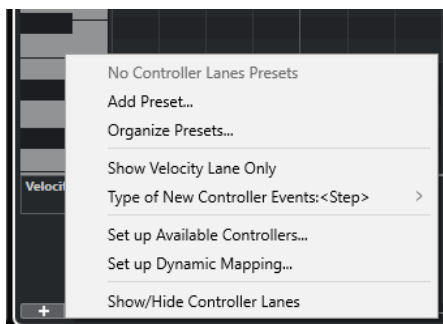

The following options are available:

Add Preset

Opens the **Type in Preset Name** dialog that allows you to save a preset and enter a name for it.

Organize Presets

Opens the **Organize Presets** dialog that allows you to rename and delete presets.

Show Velocity Lane Only

Resets the controller display to show only the velocity lane.

Type of New Controller Events

Allows you to specify whether new controller events should change gradually (**Ramp**) or instantly (**Step**) from the previous curve point to the new one.

NOTE

This only affects new events that you create manually. Recorded MIDI CC events are always added as steps. This setting is saved with the program.

Set up Available Controllers

Opens the **MIDI Controller Setup** dialog that allows you to specify which MIDI controllers are visible/hidden in the pop-up menu.

Set up Dynamic Mapping

Opens the **Dynamics Mapping Setup** dialog that allows you to map dynamics symbols to MIDI controllers.

Show/Hide Controller Lanes

Shows/Hides the last displayed controller lanes.

Controller Lane Context Menu

- To open the controller lane context menu, right-click in the left area of the controller display.

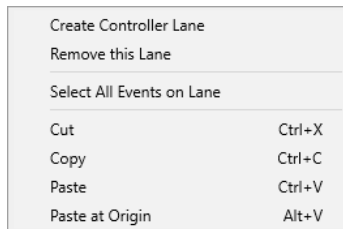

The following options are available:

Create Controller Lane

Creates a controller lane.

Remove This Lane

Removes the current controller lane.

Select All Events on Lane

Selects all controller events on the current lane.

Cut

Cuts the selected events.

Copy

Copies the selected events to the clipboard.

Paste

Pastes the clipboard data at the cursor position.

Paste at Origin

Pastes the clipboard data back at its original position. Existing events are replaced.

NOTE

You can copy data between different CC lanes.

RELATED LINKS

[Controller Display](#) on page 921

Controller Selection and Functions Menu

The **Controller Selection and Functions** pop-up menu that is shown to the left of a controller lane allows you to select the displayed controller type. This pop-up menu is only available if at least one controller lane is shown. It also contains editing functions for controller lanes and events.

- To open the **Controller Selection and Functions** pop-up menu, click **Controller Selection and Functions** to the left of a controller lane.

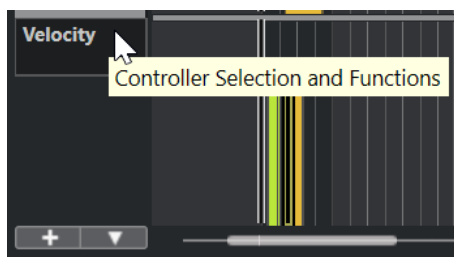

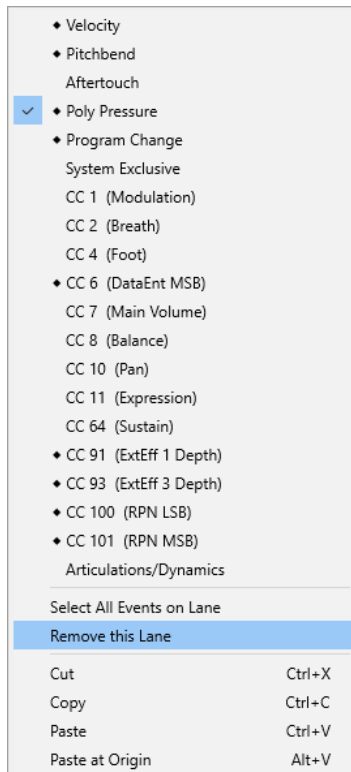

The following options are available:

Controller event types

Lists the event types that you can display on the controller lanes. If automation data already exists for a controller, this is indicated by a rhombus that is displayed to the left of the controller name.

Select All Events on Lane

Selects all controller events on the current lane.

Remove This Lane

Hides the current controller lane from view.

RELATED LINKS

[MIDI Controller Setup Dialog](#) on page 928

Create Controller Lane Menu

The **Create Controller Lane** pop-up menu allows you to create a new controller lane and select which controller type is displayed.

- To open the **Create Controller Lane** pop-up menu, click **Create Controller Lane**  to the left of the controller display.

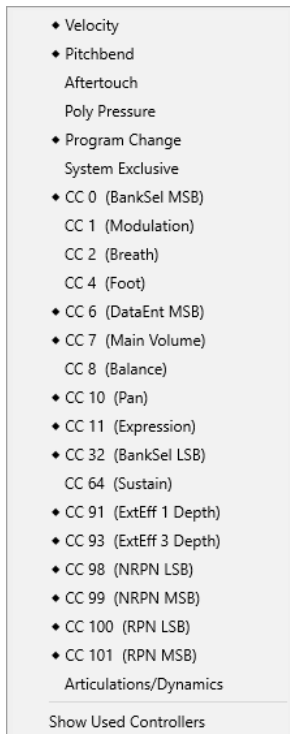

The following options are available:

Controller event types

Lists the event types that you can display on the controller lanes. If automation data already exists for a controller, this is indicated by a rhombus that is displayed to the left of the controller name.

Select an event type to add the corresponding controller lane to the controller display.

Show Used Controllers

Opens all controller lanes that have controller events.

Adding Controller Lanes

You can add controller lanes to the controller display. Controller lanes allow you to select a specific controller type for display, so that you can add and edit controller events of that type.

PROCEDURE

1. Click **Create Controller Lane** .
2. Select the controller event type from the pop-up menu.

NOTE

If the controller event type that you want to show is not available, open the **Controller Lane Setup** pop-up menu and select **Set up Available Controllers**. You can then set up the available controller event types in the **MIDI Controller Setup** dialog.

RESULT

A new controller lane is created.

NOTE

- To hide a controller lane from view, open the **Controller Selection and Functions** pop-up menu and select **Remove This Lane**. This does not affect the events in any way.

- If you hide all lanes, the controller display is hidden. You can bring it back by clicking **Create Controller Lane** or by opening the **Controller Lane Setup** pop-up menu and selecting **Show/Hide Controller Lanes**.
-

RELATED LINKS

[Controller Selection and Functions Menu](#) on page 924

[Setting up Available Continuous Controllers](#) on page 928

Displaying a Different Controller Event Type

You can select which event type to display on a controller lane. Each controller lane shows one event type at a time.

PROCEDURE

- Open the **Controller Selection and Functions** pop-up menu and select a different event type.

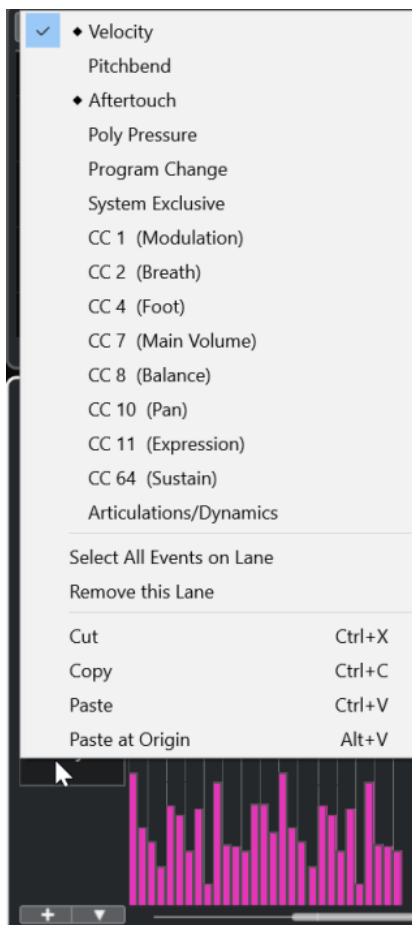

RELATED LINKS

[Controller Selection and Functions Menu](#) on page 924

Setting up Available Continuous Controllers

In the **MIDI Controller Setup** dialog, you can specify which continuous controllers are available for selection.

PROCEDURE

1. Select **Controller Lane Setup > Set up Available Controllers**.
2. In the **MIDI Controller Setup** dialog, do one of the following:
 - In **Hidden** column, select all controllers that you want to show, and click **Add**.
 - In **Visible** column, select all controllers that you want to hide and click **Remove**.
3. Click **OK**.

RESULT

The corresponding continuous controllers are now available for selection.

NOTE

The **MIDI Controller Setup** dialog is available in different areas of the program. The settings are global, that is, the setup you choose here affects all areas of the program where MIDI controllers can be selected.

RELATED LINKS

[Setting up Available Continuous Controllers](#) on page 928

MIDI Controller Setup Dialog

The **MIDI Controller Setup** dialog allows you to specify which MIDI controllers are visible/hidden.

- To open the **MIDI Controller Setup** dialog, click **Controller Lane Setup** to the left of the controller display, and select **Set up Available Controllers**.



Visible

Lists the MIDI controllers that are visible.

Hidden

Lists the MIDI controllers that are hidden.

Add >>>

Select an item in the **Hidden** list, and click **Add >>>** to make it visible.

Remove <<<

Select an item in the **Visible** list, and click **Remove <<<** to hide it.

Saving Controller Lane Presets

You can save a controller lane setup as a controller lane preset. This way, you can have a preset with one velocity lane and another preset with a combination of several controller lanes, such as velocity, pitchbend, or modulation.

PREREQUISITE

You have added at least one controller lane and selected a controller event type for display.

PROCEDURE

1. Click **Controller Lane Setup**.
2. Select **Add Preset**.
3. In the **Type in Preset Name** dialog, enter a name for the preset.
4. Click **OK**.

RESULT

Your controller lane setup is now available as a controller lane preset. The number of lanes and the displayed event types are saved in the preset.

To load, remove, or rename presets, open the **Controller Lane Setup** menu, and select **Organize Presets**.

RELATED LINKS

[Controller Lane Setup Menu](#) on page 923

Editing Velocity Events

Each note event automatically gets a velocity event. You can edit the velocity values of these events.

PREREQUISITE

You have added a controller lane and set it up to display velocity events. You have added velocity events for several notes.

PROCEDURE

1. Optional: On the toolbar, activate **Acoustic Feedback**.
This plays back the notes when you adjust the velocity so that you can audition your changes.
2. Do one of the following:
 - On the toolbar, select the **Object Selection** or the **Draw** tool and click a velocity bar in the controller display.
 - On the toolbar, select the **Object Selection** tool, press **Alt** and click a velocity bar in the controller display to select it. Change the **Velocity** value on the info line.
 - On the toolbar, select the **Line** tool and drag in the velocity display to change the velocity values of several notes.

The velocity value at the project cursor position is displayed below the **Controller Selection and Functions** pop-up menu.

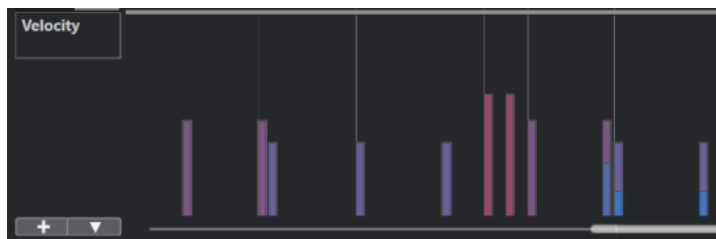

NOTE

If there is more than one note at the same position, their velocity bars overlap. To edit the velocity of only one of these notes, select the note in the note display. If no note is selected, all velocity events get the same velocity value.

RESULT

The velocity values change according to your edits.

RELATED LINKS

[Adding Velocity Events](#) on page 930

[Controller Selection and Functions Menu](#) on page 924

Adding Velocity Events

You can add velocity events by adding note events.

PREREQUISITE

You have added a controller lane.

PROCEDURE

1. Open the **Controller Selection and Functions** pop-up menu and select **Velocity**.
 2. Select the **Draw** tool or the **Line** tool.
 3. Click in the note display to add a note event.
This adds a note event and a velocity controller event that you can edit.
-

RESULT

The velocity values are shown as vertical bars in the controller display. Each velocity bar corresponds to a note event in the note display. Higher bars correspond to higher velocity values. The value is valid until the beginning of the next event.

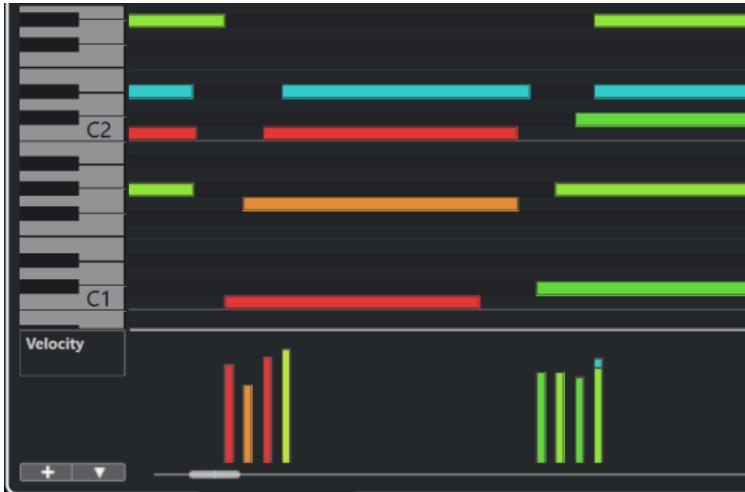

RELATED LINKS

[Adding Controller Lanes on page 926](#)

[Line Tool Modes on page 942](#)

[Controller Selection and Functions Menu on page 924](#)

Pitchbend Controller Lanes

Pitchbend controller lanes allow you to add and edit pitchbend controller events.

- To add a pitchbend controller lane, open the **Controller Selection and Functions** menu, and select **Pitchbend**.

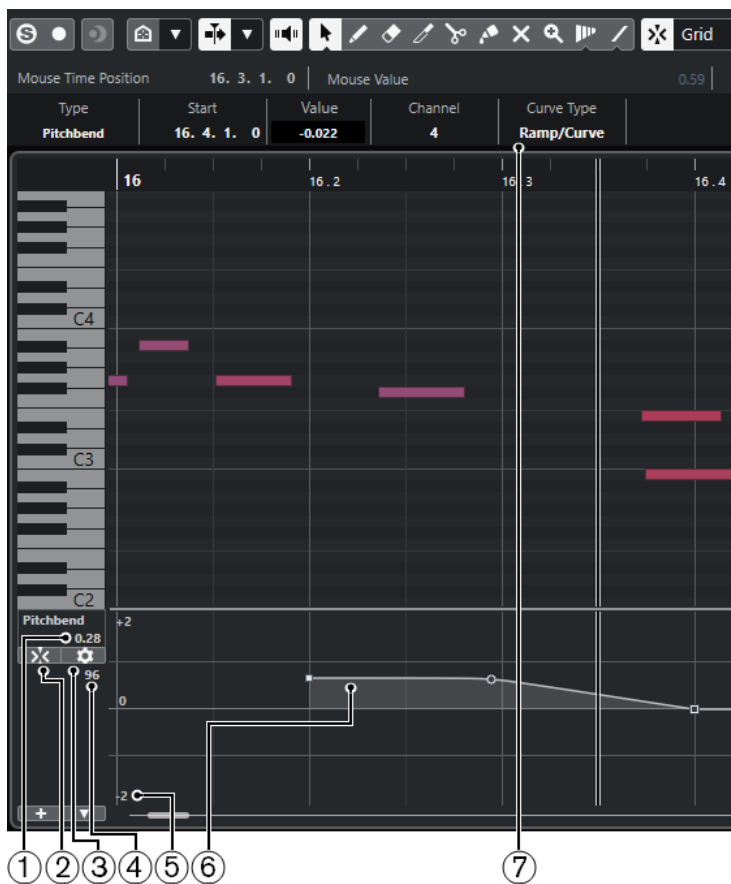

1 Value at project cursor

Displays the pitchbend value at the project cursor position. What exactly is shown depends on the **Show Semitones Grid** setting in the **Grid Settings** pane:

- If **Show Semitones Grid** is activated, this value shows the semitones value at the project cursor position. The range goes from +96 semitones to -96 semitones. The value is shown in semitones and cents.
- If **Show Semitones Grid** is deactivated, this value shows the pitchbend MIDI value at the project cursor position. The range goes from +8191 steps to -8192 steps.

2 Snap Pitchbend Events

Restricts vertical movement and positioning of controller events to the semitones grid. By default, activating **Snap Pitchbend Events** also activates **Show Semitones Grid** to show the grid that the events are snapping to.

NOTE

Snap Pitchbend Events is not effective in the controller event editor.

3 Set up Grid

Opens the **Grid Settings** pane that allows you to set up the semitones grid for the pitchbend controller lane.

4 Controller value from MIDI device

This value shows up if you input MIDI data for this controller lane from your MIDI device.

5 Semitones grid

The semitones grid shows the semitone values. The amount of grid lines and their width depends on the settings for **Pitchbend Range: Down** and **Pitchbend Range: Up**. By default, the range is set to +/- 2 semitones, that is, a major second.

NOTE

You can show the grid even if **Snap Pitchbend Events** is deactivated.

6 Controller curve

The pitchbend controller curve.

7 Curve Type field

Shows the controller curve type. You can set this to **Step** or to **Ramp/Curve**.

RELATED LINKS

[Controller Event Editor](#) on page 944

[Grid Settings](#) on page 932

Grid Settings

The **Grid Settings** pane allows you to set up a semitones grid for the pitchbend controller lane. As grid settings only affect the corresponding track, you can set up different grid settings for different MIDI or instrument tracks. All grid settings are saved with the project.

- To show the **Grid Settings** for pitchbend controller lanes, add a pitchbend controller lane, and click **Set up Grid**.

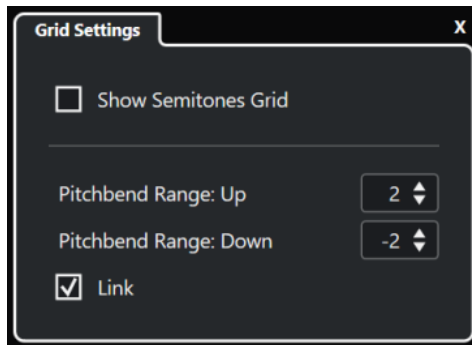

Show Semitones Grid

The semitones grid shows the semitone values that the events snap to. The amount of grid lines and their width depends on the settings for **Pitchbend Range: Down** and **Pitchbend Range: Up**.

NOTE

The grid is a visual help that allows you to find exact semitone positions for pitchbends easier. Changing the grid does not change the values of pitchbend events.

Pitchbend Range: Up

Allows you to specify a value between 1 and 96 semitones for the upper grid. By default, the upper pitchbend range for the grid is set to 2 semitones, allowing you to specify upward bends from 1 to up to 2 semitones.

Pitchbend Range: Down

Allows you to specify a value between 1 and -96 semitones for the lower grid. By default, the lower pitchbend range for the grid is set to -2 semitones, allowing you to specify downward bends from 1 to up to -2 semitones.

Link

Allows you to link the pitchbend ranges. You can deactivate this if you want to set up a higher value for the upper range than for the lower range, for example.

NOTE

The actual pitchbend range depends on the settings of the VST or MIDI instrument and the sound or preset that you are using. To make the most of this feature, make sure to adjust the pitchbend range settings of your instrument to the settings of the pitchbend controller lane, or vice versa.

RELATED LINKS

[Pitchbend Controller Lanes](#) on page 931

Adding Pitchbend Events

You can add pitchbend events to your note events.

PROCEDURE

1. Open the **Create Controller Lane** pop-up menu and select **Pitchbend**.
2. Optional: Click **Set up Grid** to open the **Grid Settings** pane, and set up the grid according to your needs.
3. Optional: Activate **Snap Pitchbend Events** to snap the pitchbend controller events to the set grid.

4. Select the **Draw** tool and click in the controller display to enter as many pitchbend events as you need.
-

RESULT

The pitchbend controller events are added.

RELATED LINKS

- [Pitchbend Controller Lanes](#) on page 931
- [Create Controller Lane Menu](#) on page 925
- [Grid Settings](#) on page 932
- [Creating Smooth Transitions between Continuous Controller Events](#) on page 939
- [Editing Pitchbend Events](#) on page 934

Editing Pitchbend Events

PREREQUISITE

You have added a pitchbend controller lane and added pitchbend events.

PROCEDURE

1. On the toolbar, select the **Object Selection** tool.
2. Optional: Click **Set up Grid** to open the **Grid Settings** pane, and set up the grid according to your needs.
3. In the controller display move the mouse pointer over a pitchbend controller event. The mouse pointer becomes a pointing hand symbol.

NOTE

You can create smooth transitions between the pitchbend controller events by selecting a pitchbend controller event and switching the **Curve Type** on the info line to **Ramp/Curve** and editing the curve handles.

4. Click the pitchbend controller event to select it and drag it to another position.
-

RELATED LINKS

- [Grid Settings](#) on page 932
- [Adding Pitchbend Events](#) on page 933
- [Pitchbend Controller Lanes](#) on page 931

Adding Articulations

You can add and edit musical expressions or articulations in the controller lane.

RELATED LINKS

- [Inserting Articulations on Controller Lanes](#) on page 1024

Adding Dynamics

You can add dynamics to your note events.

PREREQUISITE

You have set up the dynamics mapping and activated it for the track.

PROCEDURE

1. Open the **Controller Selection and Functions** pop-up menu and select **Articulations/Dynamics**.
2. Select the **Draw** tool and click in the controller display.
A mezzo forte symbol is inserted.
3. Click the triangle in the upper left corner of the event and select another dynamics symbol from the pop-up menu.

NOTE

If you select several dynamics for editing, all events change in increments, that is, relative to the original values.

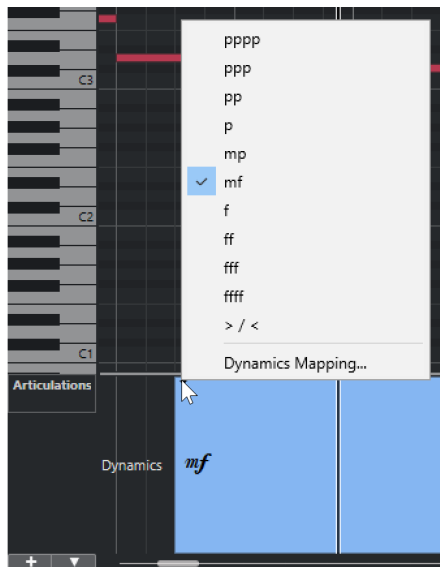

NOTE

You can step through the available dynamics symbols with the mouse wheel or the **One down** and **One up** key commands.

RESULT

The selected dynamics symbol is inserted.

RELATED LINKS

- [Dynamics Mapping Setup Dialog](#) on page 935
- [Moving Events in the Controller Display](#) on page 945

Dynamics Mapping Setup Dialog

The **Dynamics Mapping Setup** dialog allows you to map dynamics symbols to MIDI controllers.

To open the **Dynamics Mapping Setup** dialog, do one of the following:

- In the controller display, open the **Controller Selection and Functions** pop-up menu, select **Articulations/Dynamics**, open the **Controller Lane Setup** pop-up menu, and select **Set up Dynamic Mapping**.
- In the **Score Editor**, open the **Dynamics Mapping** section, right-click a dynamics symbol, and select **Dynamics Mapping**.

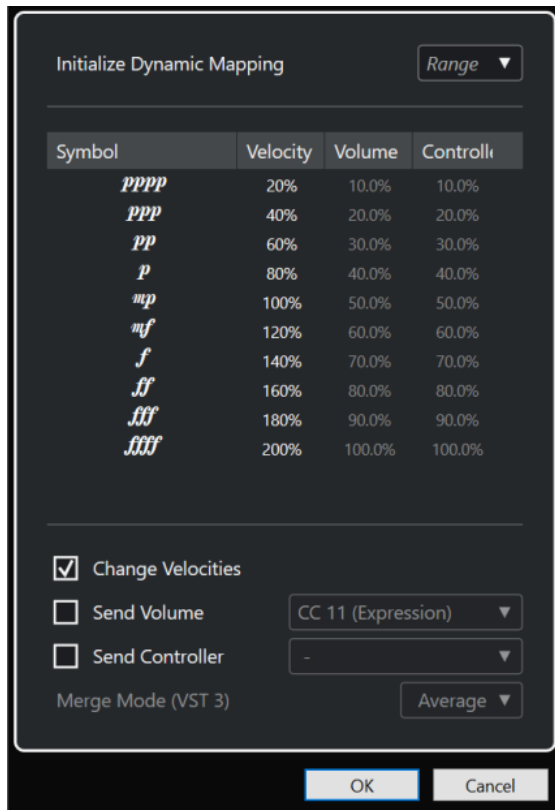

Initialize Dynamic Mapping

Allows you to specify the dynamic range for the work with mapped dynamic symbols. Open the pop-up menu to the right and activate **pp-ff** if you do not want the extreme dynamic symbols (**pppp**, **ppp**, **ffff**, and **fff**) to have an effect. Activate **pppp-ffff** to use the whole dynamic range.

Symbol

Lists the different dynamic symbols.

Velocity

Allows you to set the velocity change for the selected dynamic symbol.

Volume

Allows you to set the volume change for the selected dynamic symbol.

Controller

Allows you to set the controller change for the selected dynamic symbol. To select the MIDI controller that is sent, activate **Send Controller**, and select a controller from the pop-up menu.

Change Velocities

Activate this to modify velocities by the percentage that is set in the **Velocity** column.

Send Volume

Activate this to choose which volume events are sent: **CC 11 (Expression)**, **CC 7 (Main Volume)**. If the MIDI track is routed to a VST instrument, you can also select **VST 3 Volume**.

Send Controller

Allows you to select the MIDI controller that is sent.

Adding Poly Pressure Events

You can add poly pressure events to your note events. Poly pressure events are events that belong to a specific note number, that is, key. For each poly pressure event, you can edit the note number and the amount of pressure.

PROCEDURE

1. Click **Create Controller Lane** .
2. Select **Poly Pressure** from the menu.
A **Poly Pressure** controller lane is added. It shows a note number value field to the left of the controller display.
3. Do one of the following:
 - Select a note event in the note display to set the note number for the corresponding pitch. This only works for the topmost of several poly pressure controller lanes.
 - If you work with several poly pressure controller lanes, use the pop-up menu in the note number value field to the left of the controller display to select the note pitch for that controller lane.

The selected note number is displayed in the upper value field to the left of the controller display.
4. On the toolbar, select the **Draw** tool, and add a new poly pressure event.
You can determine the value by moving the mouse up or down in the controller display.

AFTER COMPLETING THIS TASK

Select a different note number and add poly pressure events for this.

RELATED LINKS

[Controller Selection and Functions Menu](#) on page 924

Editing Poly Pressure Events

PREREQUISITE

You have added a controller lane and set it up to display poly pressure events. You have added poly pressure events for several note numbers.

PROCEDURE

1. Click the arrow button next to the note number to the left of the controller lane.
A pop-up menu with a list of all note numbers for which you inserted poly pressure events opens.
2. Select a note number from the pop-up menu.
The poly pressure events for the selected note number are shown in the controller lane.
3. On the toolbar, select the **Draw** tool.
4. Hold down **Ctrl/Cmd - Alt/Opt** and edit the events in the controller display.

RELATED LINKS

[Adding Poly Pressure Events](#) on page 937

Adding Continuous Controllers

You can add continuous controllers to your note events.

PREREQUISITE

You have added a controller lane.

PROCEDURE

1. Open the **Controller Selection and Functions** pop-up menu and select a continuous controller.
2. Select the **Draw** tool or the **Line** tool.
3. Do one of the following:
 - To add a single event, click in the controller display.
 - To add a multiple events, click and drag in the controller display.
 - To add a **Modulation (CC1)** event, copy note events from the **Key Editor** note display and paste them on a controller lane in the controller display.

When you move the **Draw** tool on the controller lane, a tooltip shows the position and the controller value at the mouse position.

RESULT

The added events are added as steps that correspond to the event values. The beginning of an event is marked by a curve point. Controller events have no length. The value of a controller event in the display is valid until the beginning of the next controller event.

RELATED LINKS

[Adding Controller Lanes](#) on page 926

[Line Tool Modes](#) on page 942

[Controller Selection and Functions Menu](#) on page 924

Editing Continuous Controllers

You can edit the values of the continuous controller events that you added or recorded.

PREREQUISITE

You have added a controller lane and set it up to display controller events. You have added controller events for several notes.

PROCEDURE

1. On the toolbar, select the **Object Selection**, the **Draw**, or the **Line** tool.
 2. Do one of the following:
 - If you selected the **Draw**, or the **Line** tool, drag in the controller display.
 - If you selected the **Object Selection** tool, press **Alt** and drag in the controller display.
-

RESULT

The controller event is edited.

RELATED LINKS

[Line Tool Modes](#) on page 942

Creating Smooth Transitions between Continuous Controller Events

By default, when recording or drawing MIDI continuous controller events, these are inserted as steps. If this is not what you want, you can create smooth transitions between the events.

PREREQUISITE

You have recorded MIDI data with continuous controller events.

PROCEDURE

1. In the **Project** window, double-click the MIDI part.
2. In the **Key Editor**, open the **Create Controller Lane** menu, and select **Show Used Controllers**.
The controller lanes for all controller events that you have recorded are shown in the controller display.
3. Locate the controller lane of the continuous controller that you want to edit, and select a controller event.
The info line of the **Key Editor** displays information about the selected controller event, such as **Type**, **Start** position, **Value**, **Channel**, and **Curve Type**.

Type	Start	Value	Channel	Curve Type
CC 1 (Modulation)	25. 1. 1. 0	54	1	Ramp/Curve

4. Do one of the following:
 - On the info line, change the option in the **Curve Type** field from **Step** to **Ramp/Curve**.
5. Move the mouse pointer over the ramp, click the handle, and move it upwards or downwards to change the ramp into a curve shape.

NOTE

You can change the curve type for several controller events by selecting them and then changing the value in the **Curve Type** field.

- In the controller display, move the mouse pointer between two controller events and double-click the handle that appears to change the curve type from **Step** to **Ramp/Curve**.

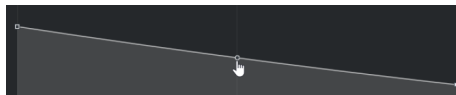

RESULT

The ramp changes into a curve.

When you play back ramps/curves, the data between two MIDI continuous controller events are interpolated to a suitable MIDI data resolution. You can visualize this by selecting **MIDI > Merge MIDI in Loop** or **MIDI > Freeze MIDI Modifiers**, or by exporting the part as a MIDI file.

NOTE

Ramp/Curve controller curves are more demanding on the performance of the application.

AFTER COMPLETING THIS TASK

You can use the controller lane context menu to cut, copy, and paste controller events.

RELATED LINKS

[Controller Lane Context Menu](#) on page 924

Continuous Controllers and MIDI Automation

You can not only record or enter MIDI controller data for a MIDI part in the controller lane, but also for an automation track in the **Project** window.

To show and edit MIDI controller data on the automation track, you must extract the MIDI automation from the MIDI part.

MIDI controller data from the automation track is also displayed on the controller lane. However, you cannot edit this data on the controller lane.

If conflicting controller data exists, you must specify what should happen on playback by selecting an option from the **Automation Merge Modes** in the **MIDI Controller Automation Setup** dialog.

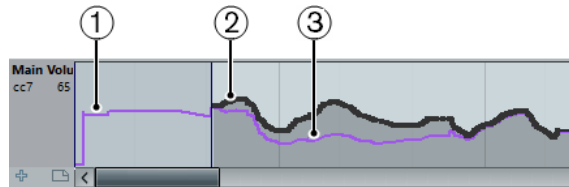

- 1 The controller curve before the part starts. This curve depends on the existing controller data and on the selected merge mode.
- 2 Controller curve entered on the controller lane.
- 3 Resulting controller curve if controller automation was also recorded on a track. These values depend on the selected automation merge mode.

On the controller lane, you can also see the controller curve that is applied before the part starts. This tells you which controller value is being used at the starting point of the part so that you can choose the start value accordingly.

The start value also depends on the automation merge mode.

RELATED LINKS

[Extracting MIDI Automation](#) on page 910

[Automation Merge Modes](#) on page 942

[MIDI Controller Automation](#) on page 940

MIDI Controller Automation

When working with Nuendo, it is possible to record automation data for MIDI controllers as MIDI part data and as data on an automation track.

If you have such conflicting automation data, you can specify separately for every parameter how these are combined during playback. This is done by selecting an **Automation Merge Mode** in the track list for the automation track.

MIDI Controller Automation Setup Dialog

In the **MIDI Controller Automation Setup** dialog, you can specify how existing MIDI automation is handled on playback and new automation data is recorded in a MIDI part or as track automation. All settings that you make in this dialog are saved with the project.

- To open the **MIDI Controller Automation Setup** dialog, select **MIDI > CC Automation Setup**.

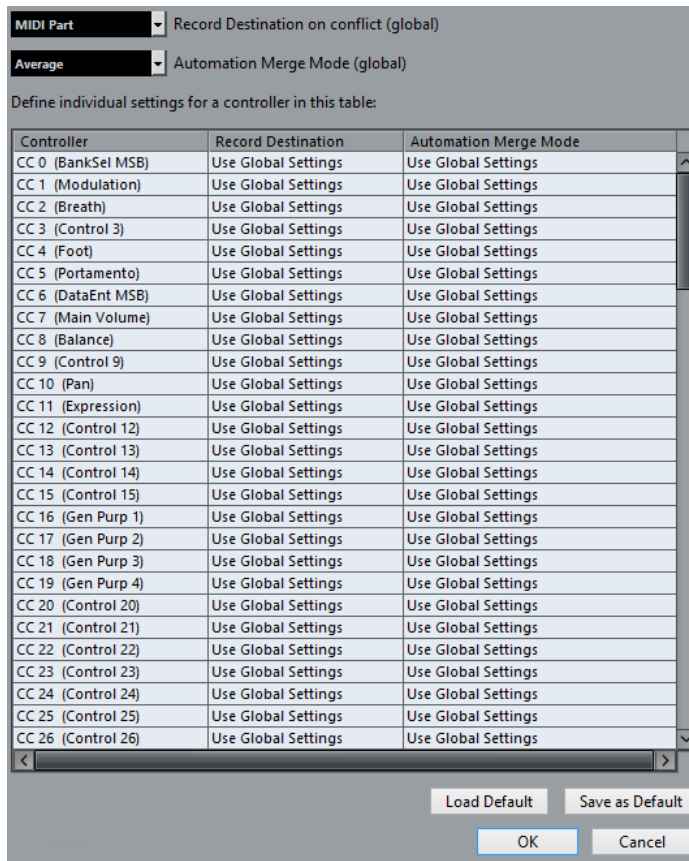

Record Destination on Conflict (global)

Allows you to determine which destination is used if MIDI controller data is received by Nuendo and both the **Record** and the **Write Automation** buttons are enabled. Select **MIDI Part** to record MIDI part automation. Select **Automation Track** to record the controller data on an automation track in the **Project** window.

Automation Merge Mode (global)

Allows you to specify the global merge mode for automation.

Controller list

Lists all MIDI controllers for which you can specify the record destination and the merge mode for automation separately. This gives you full control over the MIDI automation (destination as well as merge mode) in your project.

Record Destination

Click in the **Record Destination** column for a MIDI controller to open a pop-up menu where you can choose where you want recorded data of this particular MIDI controller to be saved.

Automation Merge Mode

Click in the **Automation Merge Mode** column for a MIDI controller to specify what happens with data for this specific controller on playback.

Save As Default

Allows you to save the current settings as default settings. When you create a new project, the default settings are used.

Load Default

Allows you to load the default settings.

Automation Merge Modes

Automation Merge Modes in the **MIDI Controller Automation Setup** dialog are only available for controllers that can be recorded both for a part and a track.

- To open the **MIDI Controller Automation Setup** dialog, select **MIDI > CC Automation Setup**.

Use Global Settings

When this is selected, the automation track uses the global automation **Merge Mode** that is specified in the **MIDI Controller Automation Setup** dialog.

Replace 1 - Part Range

When this option is selected, the part data has playback priority over the automation track data. At the left and right part borders, for example, the automation mode switches abruptly from part to track automation, and vice versa.

Replace 2 - Last Value Continues

Similar to **Replace 1 - Part Range**, but part automation only begins when the first controller event within the part is reached. At the end of the part, the last controller value is kept until an automation event is reached on the automation track.

Average

When this option is selected, the average values between part and track automation are used.

Modulation

In this mode, the automation track curve modulates the existing part automation, with higher curve points emphasizing the automation values and lower curve points reducing the automation values even further.

NOTE

The settings that you make for a controller are applied to all MIDI tracks that use this controller.

Line Tool Modes

You can use the different **Line** tool modes to edit controller events.

- To select a line mode, click the **Line** tool on the **Key Editor** or the **Drum Editor** toolbar, and click again to open a pop-up menu with the available modes.

The following modes are available:

Line

In this mode you can draw events in a straight line by clicking in the controller display and dragging the cursor to where you want the ramp to end.



NOTE

If **Snap** is activated, the **Length Quantize** value determines the density of created controller curves. For very smooth curves, use a small **Length Quantize** value or deactivate **Snap**. Beware that very dense controller curves can cause MIDI playback to stutter.

Parabola

In this mode you can draw events on a parabola curve. This gives more natural curves and fades.

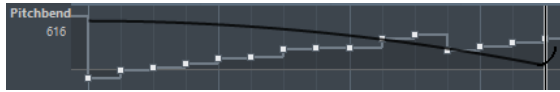

You can use modifier keys to determine the shape of the parabola curve.

- To reverse the parabola curve, press **Ctrl/Cmd**.
- To change the position of the whole curve, press **Alt/Opt**.
- To increase or decrease the exponent, press **Shift**.

NOTE

If **Snap** is activated, the **Length Quantize** value determines the density of created controller curves. For very smooth curves, use a small **Length Quantize** value or deactivate **Snap**. Beware that very dense controller curves can cause MIDI playback to stutter.

Sine, Triangle, and Square

These modes create different periodic waveform curves.

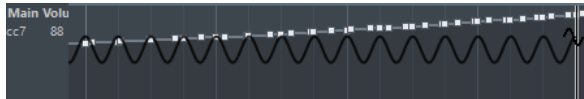

The quantize value determines the period of the curve that is the length of one curve cycle. The **Length Quantize** value determines the density of the events.

NOTE

If you set **Length Quantize** to **Quantize Link** and you enter data in **Sine, Triangle** or **Square** mode, the density of the events depends on the zoom factor.

You can use modifier keys to determine the shape of the curve.

- To change the phase of the beginning of the curve, press **Ctrl/Cmd**.
- To change the position of the whole curve, press **Alt/Opt - Ctrl/Cmd**.
- To change the maximum position of the triangle curve or the pulse of the square curve in **Triangle** and **Square** mode, press **Shift - Ctrl/Cmd**. This creates sawtooth curves.
- You can also set the curve period freely by holding down **Shift** when you insert events in **Sine, Triangle**, or **Square** mode. Activate **Snap**, **Shift**-click and drag to set the length of one period. The period length will be a multiple of the quantize value.

Paint

In this mode, you can draw in multiple notes.

NOTE

If **Snap** is activated, the **Length Quantize** value determines the density of created controller curves. For very smooth curves, use a small **Length Quantize** value or deactivate **Snap**. Beware that very dense controller curves can cause MIDI playback to stutter.

Controller Event Editor

The controller event editor allows you to perform additional scaling operations for selection ranges on existing controller curves.

- To open the controller event editor, activate the **Object Selection** tool and drag a selection rectangle on the controller lane.
- To open the controller event editor for velocity lanes, select multiple MIDI notes in the note display or activate the **Object Selection** tool, press **Alt** and drag a selection rectangle on the controller lane or to get the **Object Selection** tool.

NOTE

The controller event editor is not available for **Articulation** or **Dynamics** lanes.

The controller event editor features the following smart controls for specific editing modes:

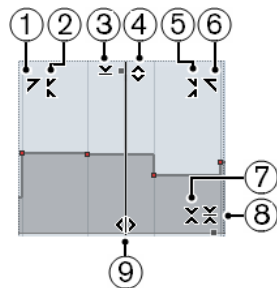

1 Tilt Left

If you click in the upper left corner of the editor, you can tilt the left part of the curve. This allows you to tilt the event values at the start of the curve upwards or downwards.

2 Compress Left

If you **Alt/Opt**-click in the upper left corner of the editor, you can compress or expand the left part of the curve. This allows you to compress or expand the event values at the start of the curve.

3 Scale Vertically

If you click in the middle of the upper border of the editor, you can scale the curve vertically. This allows you to raise or lower the event values of the curve in percent.

4 Move Vertically

If you click on the upper border of the editor, you can move the entire curve vertically. This allows you to raise or lower the values of the event values of the curve.

5 Compress Right

If you **Alt/Opt**-click in the upper right corner of the editor, you can compress or expand the right part of the curve. This allows you to compress or expand the event values at the end of the curve.

6 Tilt Right

If you click in the upper right corner of the editor, you can tilt the right part of the curve. This allows you to tilt the event values at the end of the curve upwards or downwards.

7 Scale Around Relative Center

If you **Alt/Opt**-click in the middle right border of the editor, you can scale the curve relative to its center. This allows you to raise or lower the event values horizontally around the center of the editor.

8 Scale Around Absolute Center

If you click in the middle right corner of the editor, you can scale the curve absolute to its center. This allows you to raise or lower the event values horizontally around the center of the editor.

9 Stretch

If you click on the lower border of the editor, you can stretch the curve horizontally. This allows you to move the event values of the curve to the left or to the right.

Auto Select Controllers

Auto Select Controllers automatically selects controller data of the selected MIDI notes. This is useful as selected controllers for notes will be moved when you move the corresponding notes.

- To show **Auto Select Controllers**, right-click the **Key Editor** or the **Drum Editor** toolbar, and select **Auto Select Controllers**.



If you activate **Auto Select Controllers**, controllers that belong to a note event are automatically selected when you select the note event.

RELATED LINKS

[Key Editor Toolbar](#) on page 948

Moving Events in the Controller Display

You can move events of a controller curve in the controller display. This only works for curve type controller events such as continuous controllers, pitchbend, aftertouch, poly pressure, and program change.

PROCEDURE

1. Do one of the following:
 - With the **Object Selection** tool, drag to create a selection rectangle that encompasses the events that you want to move.
 - On the toolbar, activate **Auto Select Controllers**. In the note display, select the notes whose controllers you want to move.
 - In the note display, select the notes whose controllers you want to move, and select **Edit > Select > Select Controllers in Note Range** to select the controllers within the range of the selected notes.
2. Move the note/controller events.

RESULT

The controller events are moved to the new position. Snap is taken into account.

RELATED LINKS

[Select Controllers in Note Range: Use Extended Note Context](#) on page 1359

Key Editor

The **Key Editor** is the default MIDI editor. It displays notes graphically in a piano roll-style grid. The **Key Editor** allows for detailed editing of notes and non-note events, such as MIDI controllers.

You can open the **Key Editor** in a separate window or in a tab in the lower zone of the **Project** window. Opening the **Key Editor** in the lower zone of the **Project** window is useful if you want to access the **Key Editor** functions from within a fixed zone of the **Project** window.

To open a MIDI part in the **Key Editor**, do one of the following:

- Double-click a MIDI part in the **Project** window.
- Select a MIDI part in the **Project** window and press **Return** or **Ctrl/Cmd - E**.
- Select a MIDI part in the **Project** window and select **MIDI > Open Key Editor**.
- In the **Key Commands** dialog in the **Editors** category, assign a key command for **Open Key Editor**. Select a MIDI part in the **Project** window and use the key command.

NOTE

If you select **MIDI > Set up Editor Preferences**, the **Preferences** dialog opens on the **Editors** page. Make your changes to specify if you want the editors to open in a separate window or in the lower zone of the **Project** window.

The **Key Editor** window:

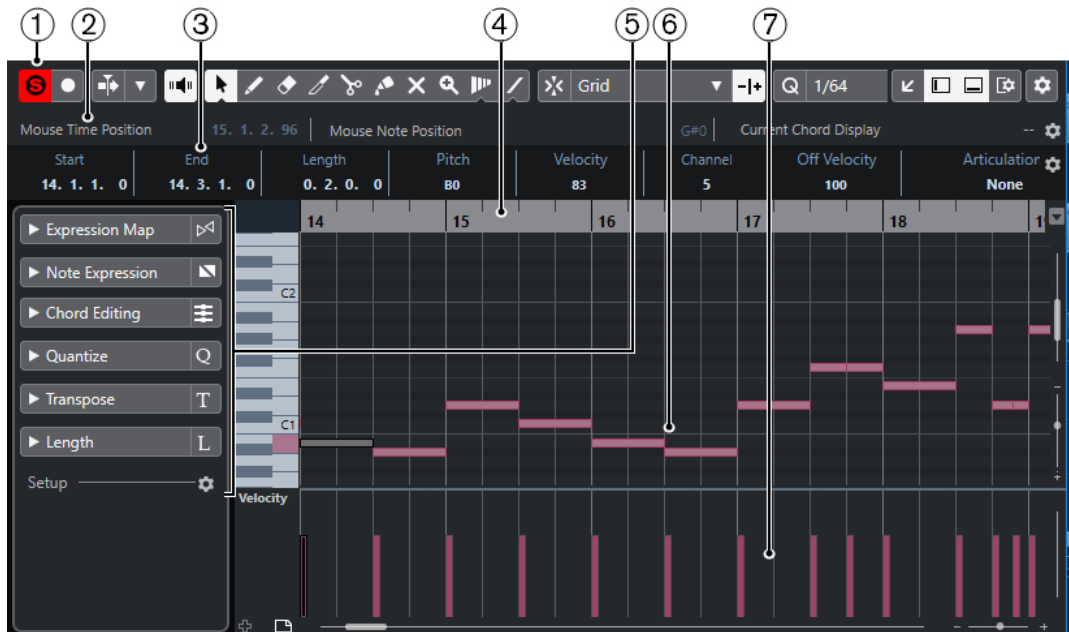

The **Key Editor** is shown in the **Editor** tab in the lower zone of the **Project** window:

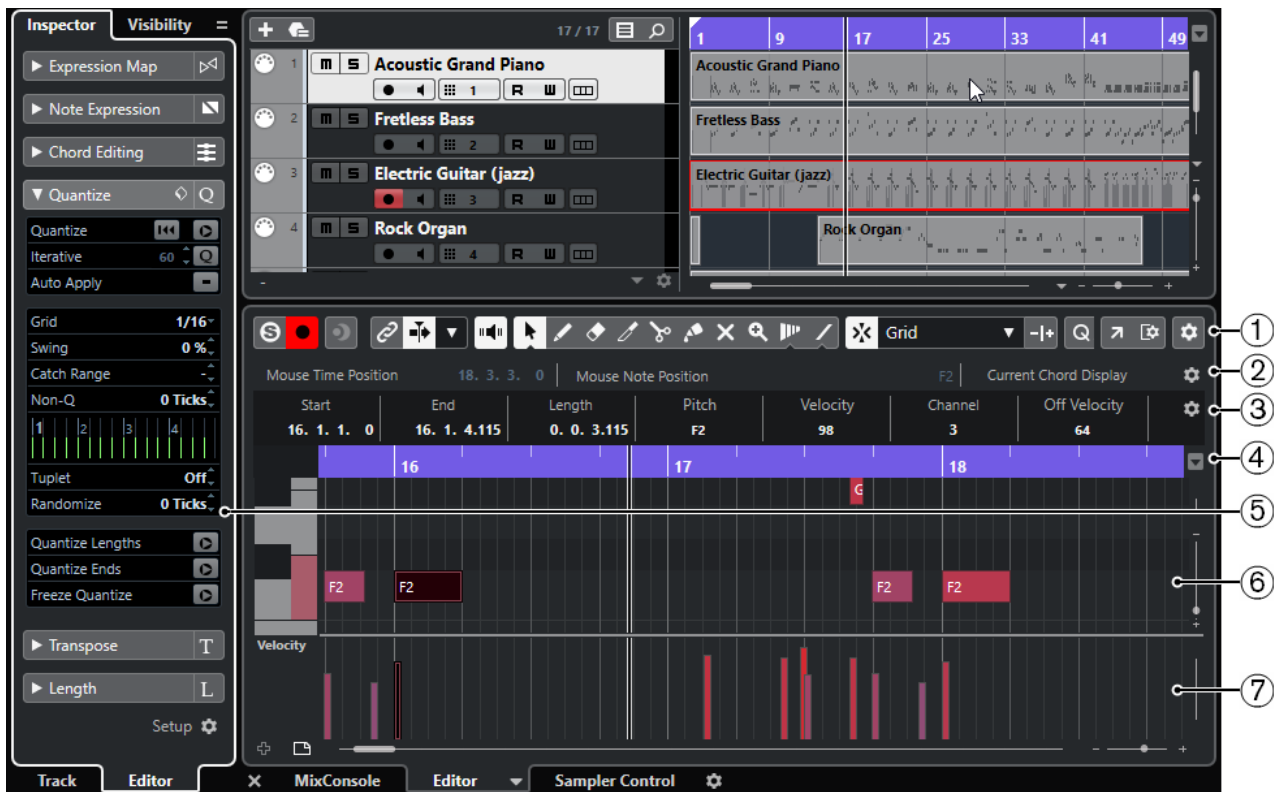

The **Key Editor** is divided into several sections:

- 1 Toolbar**
Contains tools and settings.
- 2 Status line**
Informs about the mouse time position, the mouse value, and the current chord.
- 3 Info line**
Displays note event information about a selected MIDI note.
- 4 Ruler**
Displays the timeline.
- 5 Key Editor Inspector**
Contains tools and functions for working with MIDI data.
- 6 Note display**
Contains a grid in which MIDI notes are displayed as boxes.
- 7 Piano keyboard display**
Helps you to find the right note number.
- 8 Controller display**
The area below the note display consists of one or multiple controller lanes.

NOTE

You can activate/deactivate the status line, the info line, and the controller lanes by clicking **Set up Window Layout** on the toolbar and activating/deactivating the corresponding options.

RELATED LINKS

- [Key Editor Toolbar](#) on page 948
- [Status Line](#) on page 954
- [Key Editor Inspector](#) on page 955

[Note Display](#) on page 959
[Piano Keyboard Display](#) on page 960
[Controller Display](#) on page 921

Key Editor Toolbar

The toolbar contains tools and settings for the **Key Editor**.

- To show or hide the toolbar elements, right-click the toolbar and activate or deactivate the elements.

Default Items

Solo Editor



Solos the editor during playback if the editor has the focus.

Record in Editor



Enables the recording of MIDI data in the editor if the editor has the focus.

NOTE

This only works if **MIDI Record Mode** is set to **Merge** or **Replace**.

Retrospective Record

Insert MIDI Retrospective Recording in Editor



Allows you to recover MIDI notes that you played in stop mode or during playback.

Left Divider

Left Divider

Allows you to use the left divider. Tools that are placed to the left of the divider are always shown.

Pitch Visibility

Pitch Visibility On/Off



Deactivate this to show all pitches in the note display. Activate this to reduce the pitches in the note display according to the selected pitch visibility option.

Select Pitch Visibility Options



Allows you to determine which pitches are displayed in the note display:

- **Show Pitches with Events** shows only the pitches for which events are available in the note display.
- **Show Pitches from Scale Assistant** shows only the pitches that match the musical scale that is selected in the **Scale Assistant** section of the **Inspector**.

Auto-Scroll

Link Project and Lower Zone Editor Cursors



Links timelines, cursors, and zoom factors of the **Editor** tab in the lower zone and the **Project** window.

NOTE

You cannot activate **Link Project and Lower Zone Editor Cursors** if **Independent Track Loop** is active.

Auto-Scroll



Keeps the project cursor visible during playback.

Select Auto-Scroll Settings



Allows you to activate **Page Scroll** or **Stationary Cursor** and to activate **Suspend Auto-Scroll When Editing**.

Acoustic Feedback

Acoustic Feedback



Automatically plays back events when you move or transpose them, or when you create them by drawing.

Tool Buttons

Object Selection



Selects events and parts.

Draw



Draws events.

Erase



Deletes events.

Trim



Trims events.

Split



Splits events.

Glue



Glues together events of the same pitch.

Mute



Mutes events.

Zoom



Zooms in. Hold **Alt/Opt** and click to zoom out.

Time Warp



Adjusts musical positions of events to time positions.

Line



Creates a series of contiguous events.

Auto Select Controllers

Auto Select Controllers



Automatically selects controller data of the selected MIDI notes.

Independent Track Loop

Independent Track Loop



Activates/Deactivates the independent track loop.

NOTE

If you activate **Independent Track Loop**, the **Link Project and Lower Zone Editor Cursors** function is automatically deactivated in the **Editor** tab in the lower zone.

Indicate Transpositions

Indicate Transpositions



Allows you to display the transposed pitches of MIDI notes.

Insert Velocity

Note Insert Velocity



Allows you to specify a velocity value for new notes.

Nudge Palette

Trim Start Left



Increases the length of the selected event by moving its start to the left.

Trim Start Right



Decreases the length of the selected event by moving its start to the right.

Move Left



Moves the selected event to the left.

Move Right



Moves the selected event to the right.

Trim End Left



Decreases the length of the selected event by moving its end to the left.

Trim End Right



Increases the length of the selected event by moving its end to the right.

Transpose Palette

Move Up



Transposes the selected event up by a half note.

Move Down



Transposes the selected event down by a half note.

Move Up More



Transposes the selected event up by an octave.

Move Down More



Transposes the selected event down by an octave.

Snap

Snap On/Off



Activates/Deactivates the **Snap** function.

Snap Type



Allows you to select one of the following snap types:

- **Grid** snaps events to the grid that is selected in the **Quantize Presets** pop-up menu.
- **Grid Relative** keeps the relative positions when snapping events to the grid.
- **Events** snaps events to the start or end of other events.
- **Shuffle** changes the order of events if you drag one event to the left or right of other events.
- **Cursor** snaps events to the cursor position.
- **Grid + Cursor** snaps events to the quantize grid that is selected in the **Quantize Presets** pop-up menu or to the cursor position.
- **Events + Cursor** snaps events to the start or end of other events, or to the cursor position.

- **Grid + Events + Cursor** snaps events to the quantize grid that is selected in the **Quantize Presets** pop-up menu, to the start or end of other events or to the cursor position.

Grid Type



Allows you to select one of the following grid types:

- **Use Quantize** activates a grid where events snap to the value that is selected in the **Quantize Presets** pop-up menu.
- **Adapt to Zoom** activates a grid where events snap to the zoom level.

Quantize

Apply Quantize



Applies the quantize settings.

Quantize Presets



Allows you to select a quantize or a groove preset.

Soft Quantize On/Off



Activates/Deactivates soft quantize.

Open Quantize Panel



Opens the **Quantize Panel**.

Length Quantize

Length Quantize

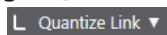

Allows you to set a value for quantizing event lengths.

Multiple Part Controls

Show Part Borders



Shows/Hides part borders for the active MIDI part within the left and right locators.

Edit Active Part Only



Restricts editing operations to the active part.

Currently Edited Part

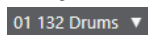

Lists all parts that were selected when you opened the editor, and allows you to activate a part.

Step/MIDI Input

Step Input



Activates/Deactivates MIDI step input.

MIDI Input/Note Expression MIDI Input



Activates/Deactivates MIDI input and note expression MIDI input.

Move Insert Mode



Moves all note events to the right of the step input position to the right to make room for the inserted event when you insert notes.

NOTE

This only works if **Step Input** is activated.

Record Pitch



Includes the pitch when you insert notes.

Record NoteOn Velocity



Includes the NoteOn velocity when you insert notes.

Record NoteOff Velocity



Includes the NoteOff velocity when you insert notes.

Event Colors

Event Colors

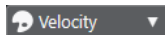

Allows you to select event colors.

Edit VST Instrument

Edit VST Instrument



Opens the VST instrument that the track is routed to.

Right Divider

Right Divider

Allows you to use the right divider. Tools that are placed to the right of the divider are always shown.

Window Zone Controls

Open in Separate Window



This button is available in the **Editor** tab in the lower zone. It opens the editor in a separate window.

Open in Lower Zone



This button is available in the editor window. It opens the **Editor** tab in the lower zone of the **Project** window.

Set up Window Layout



Allows you to set up the window layout.

Set up Toolbar



Opens a pop-up menu where you can set up which toolbar elements are visible.

RELATED LINKS

[Zooming in MIDI Editors](#) on page 913

Status Line

The status line shows information about the mouse time position, the mouse value, and the current chord.

- To show the status line, click **Set up Window Layout** on the toolbar, and activate **Status Line**.



The on/off status of the status line in the **Key Editor** window and in the **Editor** tab in the lower zone of the **Project** window are independent of each other.

Mouse Time Position

Displays the exact time position of the mouse pointer, depending on the selected ruler display format. This lets you edit or insert notes at exact positions.

Mouse Value

Displays the exact pitch of the mouse pointer position in the event display. This facilitates finding the right pitch when entering or transposing notes.

If you move the mouse in the controller display, the controller event value at the mouse cursor position is displayed.

Current Chord Display

When the project cursor is positioned over notes that form a chord, the chord is displayed here.

RELATED LINKS

[Looping MIDI Parts](#) on page 921

Info Line

The info line shows values and properties of the selected events. If several notes are selected, the values for the first note are displayed in color.

- To show the info line, click **Set up Window Layout** on the toolbar, and activate **Info Line**.

Start	End	Length	Pitch	Velocity	Channel	Off Velocity	Articulations	Release Length
11. 3. 4.101	13. 1. 1. 15	1. 1. 0. 34	A3	100	1	64	None	0. 0. 0. 0

Length and position values are displayed in the selected ruler display format.

The on/off status of the info line in the **Key Editor** window and in the **Editor** tab in the lower zone of the **Project** window are independent of each other.

RELATED LINKS

[Editing Note Events on the Info Line](#) on page 919

[Changing the Ruler Display Format](#) on page 913

Key Editor Inspector

In a MIDI editor, the **Inspector** is located left of the note display. The **Key Editor Inspector** contains tools and functions for working with MIDI data.

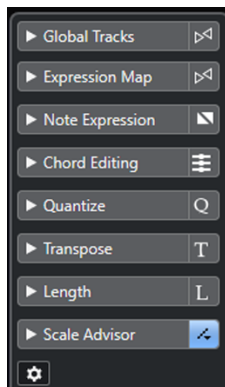

Global Tracks

Allows you to show/hide global tracks in the **Key Editor**. This allows for a better overview of the project context that you are working on.

Expression Map

Allows you to load an expression map. Expression maps are useful for working with articulations.

Note Expression

Contains functions and settings related to Note Expression.

Chord Editing

Allows you to enter chords instead of single notes.

Quantize

Allows you to access the main quantize parameters. These are identical with the functions on the **Quantize** panel.

Transpose

Allows you to access the main parameters for transposing MIDI events.

Length

Contains length-related options, similar to the **Functions** submenu of the **MIDI** menu.

- To change the length of the selected MIDI events or all events of the active part if no events are selected, use the **Scale Length/Scale Legato** slider.
At the maximum value the notes reach the beginning of the next note.
- To make the new length settings permanent, click **Freeze MIDI Lengths**.
- To fine-tune the distance between consecutive notes, use the **Overlap** slider.
At **0 Ticks**, the **Scale Length/Scale Legato** slider extends each note so that it reaches the next note exactly. Positive values cause the notes to overlap and negative values allow you to define a small gap between the notes.
- To use the **Legato** function or slider to extend a note until the next selected note, activate **Extend to Next Selected**.
This is identical with activating the **Legato Mode: Between Selected Notes Only** option in the **Preferences** dialog.

Scale Assistant

Allows you to select a musical scale that highlights all note events whose pitches belong to this scale.

Set up Inspector

Allows you to open a dialog to edit the **Inspector** settings for the editor. Click **Set up Inspector**, and from the pop-up menu, select **Setup**.

NOTE

If you open the **Key Editor** in the lower zone, these sections are shown in the **Editor Inspector** in the left zone.

RELATED LINKS

[Expression Maps](#) on page 1015

[Note Expression Inspector Section](#) on page 1033

[Quantize Panel](#) on page 326

[Transpose Functions](#) on page 360

[Opening the Editor Inspector](#) on page 66

[Global Tracks in the Key Editor](#) on page 956

[Scale Assistant in the Key Editor](#) on page 958

Global Tracks in the Key Editor

The **Global Tracks** section of the **Key Editor Inspector** allows you to show events on global tracks in the **Key Editor** so that you can see them together with MIDI events.

You can show events from global tracks, such as the tempo, signature, chord, ruler, arranger, video, marker, and transpose track in the **Key Editor**. This way, you can edit MIDI events and view the project context at the same time without having to switch to the **Project** window.

NOTE

The **Global Tracks** section of the **Inspector** is only available if you open the **Key Editor** as a separate window. It is not available in the lower zone editor.

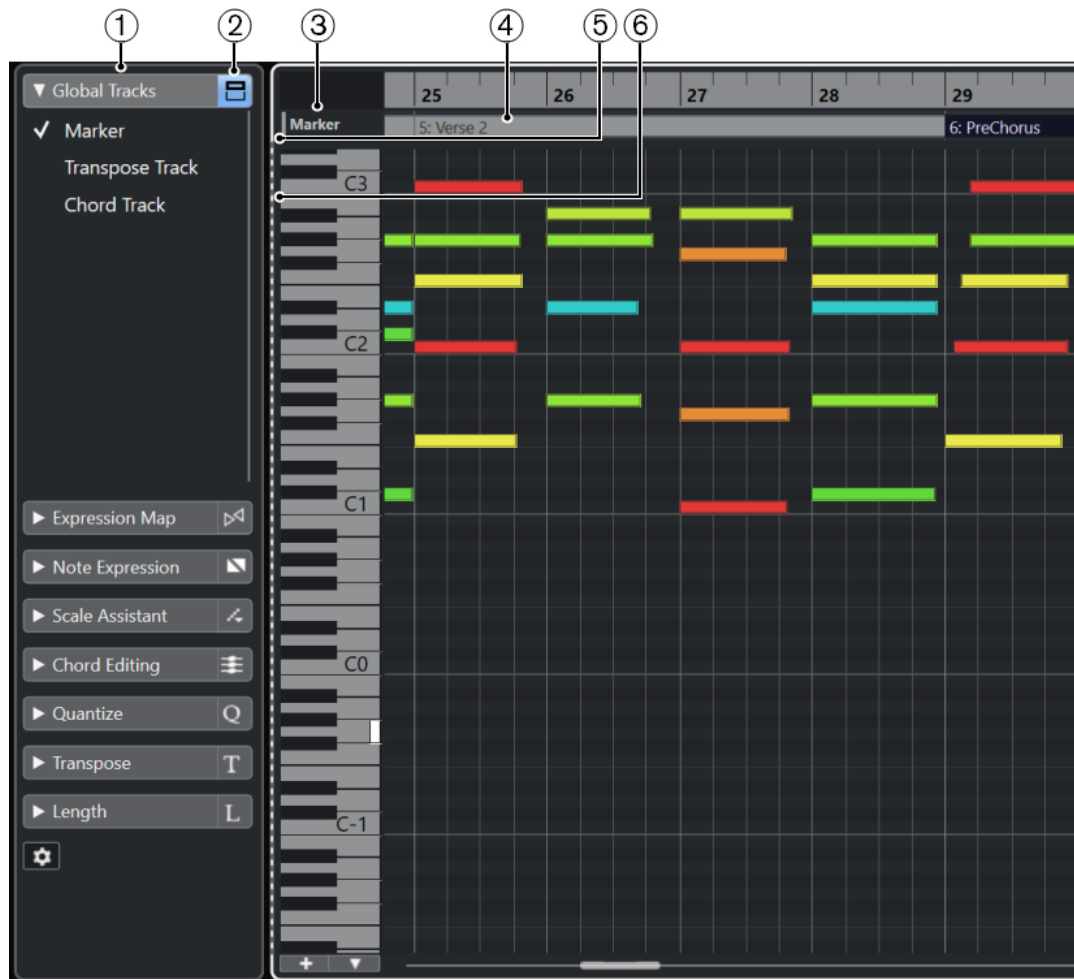

1 Global Tracks section

The **Global Tracks** section of the **Key Editor Inspector** lists all global tracks that you added to your project. To show a global track in the dedicated zone of the **Key Editor**, you must activate it in the **Global Tracks** section.

2 Show/Hide Global Tracks

Allows you to show/hide the track list and the event display for global tracks in the **Key Editor**.

3 Track list for global tracks

Shows the track names and the track colors that are assigned to the global tracks. The global tracks are shown in the same order as in the **Project** window. This also applies if you work with a divided track list.

4 Event display for global tracks

The upper zone of the **Key Editor** shows the event display for the global tracks.

5 Event display with keyboard focus

The event display that has the keyboard focus, in this case the global tracks event display, is indicated by a highlighted and solid frame.

6 Non-active event display

The non-active event display, in this case the **Key Editor** note event display, is shown with a dashed frame.

RELATED LINKS

[Showing/Hiding Global Tracks in the Key Editor](#) on page 963

[Dividing the Track List](#) on page 57

[Keyboard Focus in the Key Editor](#) on page 965

Scale Assistant in the Key Editor

The **Scale Assistant** section of the **Key Editor Inspector** helps you to match note events to a musical scale.

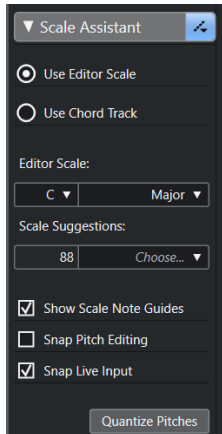

Scale Assistant Status Indicator

Shows the on/off status of the **Scale Assistant**.

Use Editor Scale

Allows you to select a scale for the notes in the **Key Editor** note display.

- **Editor Scale**
Allows you to select a scale.
- **Scale Suggestions**
Shows the number of scale suggestions. Open the pop-up menu to select a scale suggestion. To get scale suggestions for specific notes, you must select them. If no note is selected, the scale suggestions are made for all notes.

Use Chord Track

Allows you to select a scale based on the chord track.

- **Chord Track Mode**
Allows you to select whether you want to use the scale events of the chord track, the chord events, or both to find a scale.

Show Scale Note Guides

Changes the note event display background according to the selected scale. Pitches that do not belong to the selected scale are shown with a darker background.

Snap Pitch Editing

Snaps the pitches or the notes to the selected scale when you add, edit, or move them.

NOTE

Snap Pitch Editing does not apply when you change pitches using the **Pitch** value field on the info line or if you record notes via MIDI input.

Snap Live Input

Automatically corrects the pitches of incoming notes according to the selected scale.

NOTE

This only works if **Record in Editor** is activated.

Quantize Pitches

Quantizes the pitches of the selected notes to the nearest pitch of the selected scale.

RELATED LINKS

[Note Display](#) on page 959

[Using Live Input](#) on page 1068

[Event Colors Menu](#) on page 914

[Musical Scale Setup Dialog](#) on page 1061

[Matching Note Events to a Musical Scale](#) on page 966

[Using the Chord Track to Match Note Events to a Musical Scale](#) on page 967

[Quantizing MIDI Note Pitches to Musical Scales](#) on page 968

[Chord Track](#) on page 1052

[Mapping Incoming MIDI Note Pitches to Musical Scales](#) on page 968

[Snapping MIDI Note Pitches to Musical Scales While Editing](#) on page 969

Note Display

The note display is the main zone in the **Key Editor**. It contains a grid in which note events are shown as boxes.



The width of a box corresponds to the note length. The vertical position of a box corresponds to the note number (pitch), with higher note events higher up in the grid.

Depending on the zoom factor, the note events show the note names.

NOTE

You can change the naming format and the note names of the pitches in the **Pitch Notation** section of the **Preferences** dialog (**Event Display—Chords&Pitches** page).

You can activate **Pitch Visibility On/Off** on the **Key Editor** toolbar to show only the pitches with events or the pitches suggested by the **Scale Assistant**. This hides the keyboard keys whose pitches are not used and shows note names on the remaining keys.

RELATED LINKS

[Piano Keyboard Display](#) on page 960

[Zooming in MIDI Editors](#) on page 913

[Pitch Notation](#) on page 1363

[Pitch Visibility Options](#) on page 962

Piano Keyboard Display

The piano keyboard display is shown to the left of the note display in the **Key Editor**.

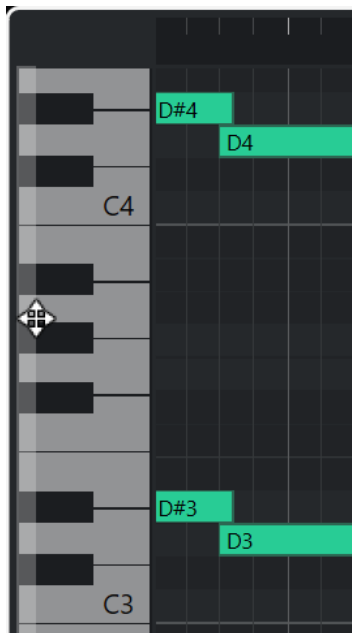

The piano keyboard gives you a visual orientation over the pitch positions in the note display, helping you to find specific note pitches.

You can click a key to listen to the pitch and the sound of the connected instrument.

If you move the mouse to the far left of the piano keyboard display, the mouse pointer changes, allowing you to scroll up and down and to zoom in and out of the keyboard display:

- Drag upwards/downwards to scroll up/down in the piano keyboard display.
- Drag to the right/left to zoom in on/out of the piano keyboard display.

The C keys show the note names of the corresponding pitches.

You can activate **Pitch Visibility On/Off** on the **Key Editor** toolbar to show only the pitches with events or the pitches suggested by the **Scale Assistant**. This hides the keyboard keys whose pitches are not used and shows note names on the remaining keys.

NOTE

You can change the naming format and the note names of the pitches in the **Pitch Notation** section of the **Preferences** dialog (**Event Display—Chords&Pitches** page).

If you select note events in the event display, the corresponding keys on the piano keyboard display are shown in the same color as the note event.

If you move the mouse pointer in the event display, the corresponding pitch position on the piano keyboard display is highlighted.

RELATED LINKS

[Note Display](#) on page 959

[Key Editor](#) on page 945

[Pitch Notation](#) on page 1363

[Pitch Visibility Options](#) on page 962

Showing Specific Pitches in the Key Editor

You can define which pitches are visible in the event display and the piano keyboard display of the **Key Editor**. By hiding pitches that you do not need, you can save screen space. This is useful if you add note events that span more than one octave and you want to display all of them, for example.

PROCEDURE

1. On the **Key Editor** toolbar, open the **Select Pitch Visibility Options** pop-up menu.
 2. Do one of the following:
 - To show only the pitches for which events are available in the note display, select **Show Pitches with Events**.
- NOTE**
- If you edit multiple MIDI parts, the pitches of all note events in the different MIDI parts are taken into account. The visible pitches are updated according to the MIDI part selection in the **Project** window.
-
- To show only the pitches that match the musical scale that is selected in the **Scale Assistant** section of the **Key Editor Inspector**, select **Show Pitches from Scale Assistant**.

RESULT

The note display and the piano keyboard display are changed according to your settings.

EXAMPLE

If you selected **Show Pitches from Scale Assistant** in the **Select Pitch Visibility Options** pop-up menu and the **Scale Assistant** uses a specific scale, but some of the notes in the note display do not match the scale, this is indicated by the color of the note events, and by the exclamation mark on the corresponding keys on the keyboard display.



RELATED LINKS

- [Pitch Visibility Options](#) on page 962
- [Key Editor Toolbar](#) on page 948
- [Note Display](#) on page 959
- [Piano Keyboard Display](#) on page 960

Pitch Visibility Options

The pitch visibility options allow you to show or hide specific pitches from the **Key Editor** event display and the piano keyboard display. Pitch visibility options are saved with the program. If a setting leads to a situation where no pitches would be shown, all pitches are shown instead.

- To open the pitch visibility options, click **Select Pitch Visibility Options** on the **Key Editor** toolbar.



The following options are available:

Show Pitches with Events

Allows you to show only the pitches for which events are available in the note display.

NOTE

If you edit multiple MIDI parts, the pitches of all note events in the different MIDI parts are taken into account. The visible pitches are updated according to the MIDI part selection in the **Project** window.

Show Pitches from Scale Assistant

Allows you to show only the pitches that match the musical scale that is selected in the **Scale Assistant** section of the **Key Editor Inspector**.

- Use Editor Scale**

Shows only notes that match the editor scale.

NOTE

If the note display contains note events on pitches that do not match the selected scale, the corresponding keys on the keyboard display are shown with an exclamation mark. If you activate the **Scale/Chords** option in the **Event Colors**

pop-up menu on the **Key Editor** toolbar, the non-matching note events are shown in a different color.

- **Use Chord Track**
Shows only notes that match the chord track. The **Chord Track Mode** that you selected for the **Scale Assistant** determines if the pitches of the scale, the chord, or both are visible.

RELATED LINKS

[Event Colors Menu](#) on page 914

[Piano Keyboard Display](#) on page 960

[Note Display](#) on page 959

[Showing Specific Pitches in the Key Editor](#) on page 961

Pitch Editing with Reduced Pitch Visibility

If you edit pitches and you reduced the pitch visibility using one of the **Select Pitch Visibility Options**, you must consider some general program behavior.

As a general rule, you can only move note events to pitch positions that are visible. This applies to moving note events upwards/downwards with the mouse, using the corresponding key command, or using the cursor keys.

Exceptions

If you want to access specific pitch positions that are not displayed, you have the following possibilities:

- To move note events to pitch positions that are not visible, use the **Pitch** value field on the info line.
- To move note events by octaves, select the note event and press **Shift - Up Arrow** to move it up an octave or **Shift - Down Arrow** to move it down an octave.
- To move chord notes, open the **Chord Editing** section and activate an option in the **Inversions** or **Drop Notes** section.

In all these cases, the note display and the piano keyboard display extend to show the new pitches.

RELATED LINKS

[Pitch Visibility Options](#) on page 962

[Note Display](#) on page 959

[Piano Keyboard Display](#) on page 960

Key Editor Operations

This section describes the principal editing operations within the **Key Editor**.

Showing/Hiding Global Tracks in the Key Editor

You can show global tracks and their events in the **Key Editor**.

PREREQUISITE

- In the **Project** window, you have added at least one global track, such as the tempo, signature, chord, ruler, arranger, video, marker, or the transpose track.

- In the track list, you have set up the order of the tracks as you want them to be shown in the **Key Editor**.
- Optional: In the **Project** window, you have activated **Show Scales** for the chord track.
- Optional: In the **Project** window, you have defined a **Visible Tempo Upper Limit** and a **Visible Tempo Lower Limit** for the tempo track.

PROCEDURE

1. Select a MIDI part in the **Project** window.
2. Select **MIDI > Open Key Editor** to open the **Key Editor** in a separate window.
The **Global Tracks** section is shown in the **Inspector**. Its track list shows a list of the available global tracks of your project.

NOTE

The **Global Tracks** section of the **Inspector** is not available in the lower zone editor.

3. In the track list of the **Global Tracks** section, activate the tracks that you want to show in the **Key Editor**.

RESULT

The global tracks that you activated are shown above the note display.

The global track setup in the **Key Editor** is saved with the project.

NOTE

If your project contains global tracks, you can also activate and show them and their events in the **Key Editor** by clicking **Set up Window Layout** on the toolbar and activating **Global Tracks**.

RELATED LINKS

- [Key Editor Inspector](#) on page 955
- [Global Tracks in the Key Editor](#) on page 956
- [Chord Track Controls](#) on page 161
- [Tempo Track Controls](#) on page 164
- [Editing Events on Global Tracks](#) on page 964

Editing Events on Global Tracks

You can select, add, and edit events in the global tracks event display of the **Key Editor**. All changes that you perform are synchronized with the **Project** window event display.

PROCEDURE

1. Optional: Make sure that the global tracks event display has the keyboard focus and zoom in on/out of the global tracks using **Shift-H** or **Shift-G**.
2. Optional: Change the height of a global track by clicking its lower border in the track list and dragging up or down.

NOTE

The tracks that are shown in the global tracks event display have a default track height of 1 row, except for the tempo track and the chord track that have a height of 2 rows, and the video track that has a height of 3 rows. You can adapt these heights according to your needs. The height of the ruler track cannot be changed.

3. Do one of the following:

- Apply the usual editing methods on one or several events in the global tracks event display.
- Use the tool buttons in the **Key Editor** toolbar.
- Select an event in the global tracks event display and use the info line to edit specific event parameters.

RESULT

All changes that you perform including the track selection are synchronized with the **Project** window event display.

RELATED LINKS

[Keyboard Focus in the Key Editor](#) on page 965

[Tool Buttons](#) on page 949

[Setting the Track Height](#) on page 185

[Track Handling](#) on page 170

Keyboard Focus in the Key Editor

The different zones in the **Key Editor** window can be controlled by using key commands. To make sure that a key command has effect on a specific zone, you must make sure that this zone has the keyboard focus.

The following **Key Editor** zones can have the keyboard focus:

- Global tracks event display
- **Key Editor** note display

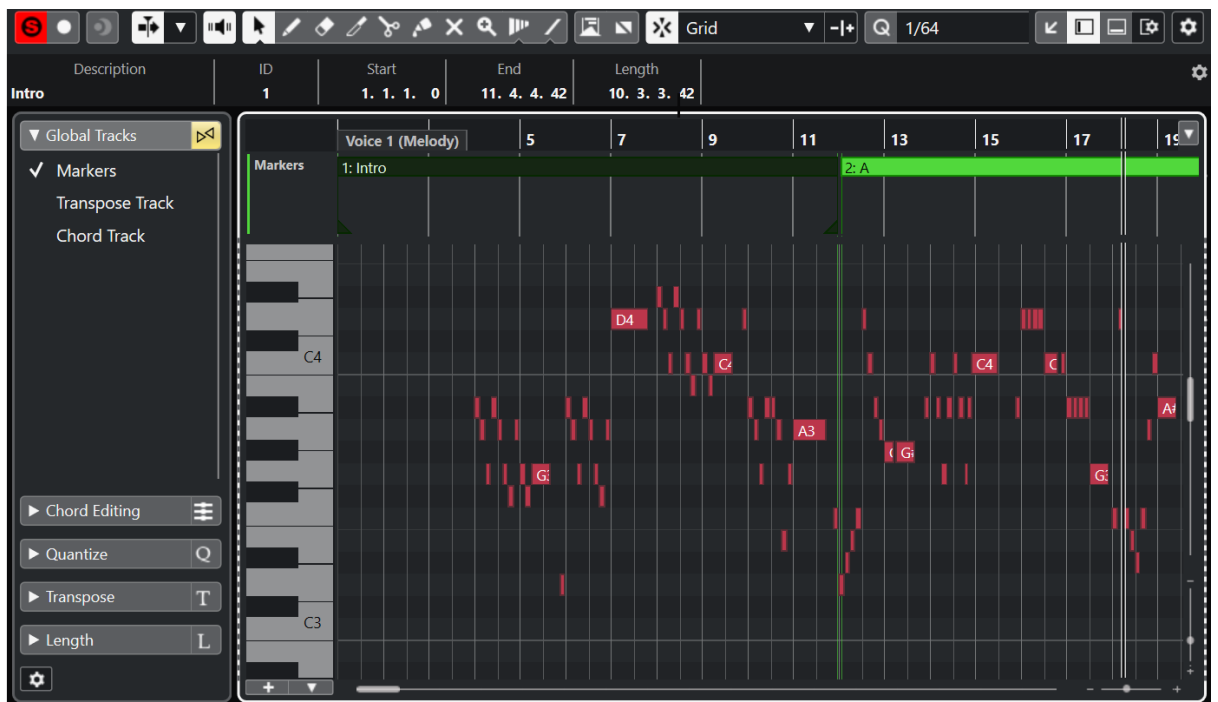

The global tracks event display has the keyboard focus.

If a zone has the keyboard focus, it is indicated by a highlighted and solid focus frame. The non-active zone is shown with a dashed frame.

NOTE

You can change the focus color in the **Preferences** dialog (**User Interface—Color Schemes** page).

RELATED LINKS

- [Editing Events on Global Tracks](#) on page 964
- [Showing/Hiding Global Tracks in the Key Editor](#) on page 963
- [Global Tracks in the Key Editor](#) on page 956
- [Keyboard Focus in the Project Window](#) on page 84
- [Activating Keyboard Focus for a Zone](#) on page 85

Matching Note Events to a Musical Scale

You can select a musical scale that is based on all or selected note events in the **Key Editor** and match note events to it.

PROCEDURE

1. Open a MIDI part in the **Key Editor**.
2. Open the **Scale Assistant** section of the **Inspector**, and activate **Use Editor Scale**.
3. Do one of the following:
 - Select some note events in the note display if you want to get suggestions of musical scales that match those notes.
 - Deselect all note events in the note display if you want to get suggestions of musical scales that match all notes of the MIDI part.
4. Activate **Show Scale Note Guides**.

This changes the background of the event display according to the selected scale so that pitches that do not belong to the scale are shown with a darker background.
5. On the **Key Editor** toolbar, set **Event Colors** to **Scale/Chords**.

This changes the colors of the note events in the event display according to whether or not the pitches match the selected musical scale.

NOTE

To view the color scheme of the selected color mode, open the **Event Colors** pop-up menu and select **Setup**.

6. Open the **Scale Suggestions** pop-up menu, and select one of the options.
 7. Optional: On the **Key Editor** toolbar, open the **Select Pitch Visibility Options** pop-up menu, and select **Show Pitches from Scale Assistant**.

This filters the note display and the piano keyboard display so that they show only the pitches that match the selected musical scale.
-

RESULT

The coloring of the event display background and the note events gives you a visual guide for editing note pitches.

AFTER COMPLETING THIS TASK

If you need more assistance to match note events to the nearest pitches of the selected musical scale, you can click **Quantize Pitches** to quantize pitches of already existing MIDI notes, activate **Snap Pitch Editing** to snap the note pitches of MIDI notes while editing, or **Snap Live Input** to map the note pitches of incoming MIDI.

RELATED LINKS

[Using the Chord Track to Match Note Events to a Musical Scale](#) on page 967

[Scale Assistant in the Key Editor](#) on page 958

[Showing Specific Pitches in the Key Editor](#) on page 961

[Snapping MIDI Note Pitches to Musical Scales While Editing](#) on page 969

[Mapping Incoming MIDI Note Pitches to Musical Scales](#) on page 968

[Quantizing MIDI Note Pitches to Musical Scales](#) on page 968

Using the Chord Track to Match Note Events to a Musical Scale

You can select a musical scale that is defined by chords or scales on the chord track and match note events to it.

PREREQUISITE

You have added a chord track with chord events to your project.

PROCEDURE

1. Open a MIDI part in the **Key Editor**.
2. Optional: Open the **Global Tracks** section and activate the chord track as a global track. This allows you to see chord and scale events in the **Key Editor**.
3. Open the **Scale Assistant** section of the **Inspector**, and activate **Use Chord Track**.
4. Open the **Chord Track Mode** pop-up menu and do one of the following:
 - Select **Scales** if you want to match note events to the scale events on the chord track.
 - Select **Chords** if you want to match note events to the chord events on the chord track.
 - Select **Chords & Scales** if you want to match note events to both scale and chord events on the chord track.
5. Activate **Show Scale Note Guides**.
This changes the background of the event display according to the selected scale so that pitches that do not belong to the scale are shown with a darker background.
6. On the **Key Editor** toolbar, set **Event Colors** to **Scale/Chords**.
This changes the colors of the note events in the event display according to whether or not the pitches match the selected musical scale.

NOTE

To view the color scheme of the selected color mode, open the **Event Colors** pop-up menu and select **Setup**.

-
7. Optional: On the **Key Editor** toolbar, open the **Select Pitch Visibility Options** pop-up menu, and select **Show Pitches from Scale Assistant**.
This filters the note display and the piano keyboard display so that they show only the pitches that match the selected musical scale.

RESULT

The coloring of the event display background and the note events gives you a visual guide for editing note pitches.

NOTE

As you might have added different scale/chord events at specific time positions, the scale indications in the event display background and on the note events change along the timeline.

AFTER COMPLETING THIS TASK

If you need more assistance to match note events to the nearest pitches of the selected musical scale, you can click **Quantize Pitches** to quantize pitches of already existing MIDI notes, activate **Snap Pitch Editing** to snap the note pitches of MIDI notes while editing, or activate **Snap Live Input** to map the note pitches of incoming MIDI.

RELATED LINKS

- [Event Colors Menu](#) on page 914
- [Matching Note Events to a Musical Scale](#) on page 966
- [Scale Assistant in the Key Editor](#) on page 958
- [Showing Specific Pitches in the Key Editor](#) on page 961
- [Chord Track](#) on page 1052
- [Showing/Hiding Global Tracks in the Key Editor](#) on page 963

Quantizing MIDI Note Pitches to Musical Scales

You can quantize MIDI note pitches to the nearest pitch of the selected scale.

PREREQUISITE

In the **Key Editor**, you have selected a scale for your MIDI notes or you have selected a **Chord Track Mode**.

PROCEDURE

1. Open the **Scale Assistant** section of the **Inspector**.
2. Optional: Activate **Show Scale Note Guides**.
3. Do one of the following:
 - Select the notes in the note event display whose pitches you want to quantize.
 - Deselect all notes in the note event display to quantize all note pitches of the MIDI part.
4. Click **Quantize Pitches**.

RESULT

All note pitches that do not match the selected scale are quantized to the nearest pitches in the scale.

RELATED LINKS

- [Matching Note Events to a Musical Scale](#) on page 966
- [Using the Chord Track to Match Note Events to a Musical Scale](#) on page 967
- [Scale Assistant in the Key Editor](#) on page 958
- [Snapping MIDI Note Pitches to Musical Scales While Editing](#) on page 969
- [Mapping Incoming MIDI Note Pitches to Musical Scales](#) on page 968
- [Quantizing MIDI Note Pitches to Musical Scales](#) on page 968

Mapping Incoming MIDI Note Pitches to Musical Scales

When monitoring or recording in the **Key Editor**, you can map the note pitches of incoming MIDI to the nearest pitches of the selected scale.

PREREQUISITE

In the **Key Editor**, you have selected a scale for the MIDI notes or you have selected a **Chord Track Mode**.

PROCEDURE

1. Open the **Scale Assistant** section of the **Inspector**.
 2. Activate **Show Scale Note Guides**.
 3. On the **Key Editor** toolbar, activate **Record in Editor**.
 4. Click **Start** on the **Transport** panel or in the **Transport Bar** to start playback.
 5. Activate **Snap Live Input**.
 6. Play or record some notes on your MIDI keyboard.
-

RESULT

The pitches of the played or recorded notes are automatically mapped to the selected scale.

RELATED LINKS

- [Matching Note Events to a Musical Scale](#) on page 966
- [Using the Chord Track to Match Note Events to a Musical Scale](#) on page 967
- [Scale Assistant in the Key Editor](#) on page 958
- [Using Live Input](#) on page 1068

Snapping MIDI Note Pitches to Musical Scales While Editing

You can snap the note pitches of MIDI notes to the nearest pitches of the selected scale while editing in the **Key Editor**.

PREREQUISITE

In the **Key Editor**, you have selected a scale for your MIDI notes or you have selected a **Chord Track Mode**.

PROCEDURE

1. Open the **Scale Assistant** section of the **Inspector**.
 2. Activate **Show Scale Note Guides**.
 3. Activate **Snap Pitch Editing**.
 4. Do one of the following:
 - Insert a note event with the **Draw** tool, the **Object Selection** tool, or with the **Line** tool.
 - Drag a note event upwards or downwards with the mouse.
 - Select a note event and use the **Up Arrow**/**Down Arrow** keys.
-

RESULT

The notes snap to pitches of the selected scale. You cannot place notes on pitches outside of the scale. If you select multiple notes and move them to different pitches, all selected notes snap to the pitches of the selected scale.

NOTE

Snap Pitch Editing does not apply when you change pitches using the **Pitch** value field on the info line or if you record notes via MIDI input.

RELATED LINKS

- [Matching Note Events to a Musical Scale](#) on page 966
- [Using the Chord Track to Match Note Events to a Musical Scale](#) on page 967
- [Scale Assistant in the Key Editor](#) on page 958
- [Drawing Note Events with the Draw Tool](#) on page 970

[Inserting Note Events with the Object Selection Tool](#) on page 970

[Drawing Note Events with the Line Tool](#) on page 971

[Moving and Transposing Note Events](#) on page 972

[Modifying Note Values while Inserting Notes](#) on page 971

Inserting Note Events with the Object Selection Tool

You can insert note events with the **Object Selection** tool.

PREREQUISITE

You have set up the length for the note events quantize value in the **Length Quantize** pop-up menu of the toolbar.

PROCEDURE

- In the note display, double-click with the **Object Selection** tool at the position where you want to insert a note.

RESULT

A note is inserted at the position where you double-clicked with the length that you have set up in the **Length Quantize** pop-up menu.

Deleting Note Events

PROCEDURE

- Perform one of the following actions:
 - Select the **Erase** tool and click the event.
 - Select the **Object Selection** tool and double-click the event.

NOTE

If **Double-click Opens Note Expression Editor** is activated on the **Key Editor** toolbar, double-clicking a note event opens the note expression editor instead.

RESULT

The note event is deleted.

RELATED LINKS

[Key Editor Toolbar](#) on page 948

[Note Expression Event Editor](#) on page 1042

Drawing Note Events with the Draw Tool

The **Draw** tool allows you to insert single note events in the note display.

When you move the cursor inside the note display, its position is indicated on the status line. Its pitch is indicated both on the status line and on the piano keyboard to the left.

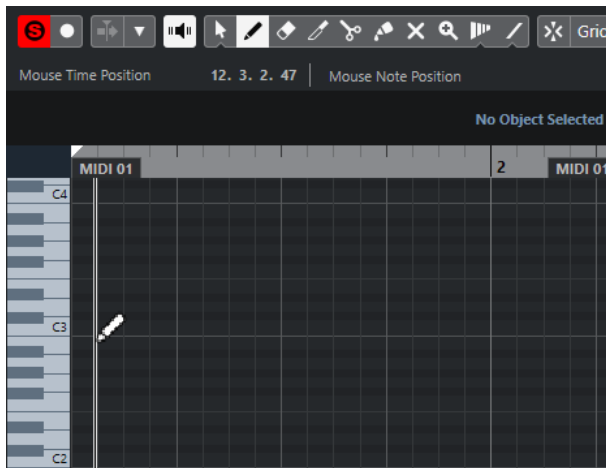

- To draw a note, click in the note display.
The note event has the length that is set on the **Length Quantize** pop-up menu.
- To draw longer note events, click and drag in the note display.
The length of the note event is a multiple of the Length Quantize value. If **Length Quantize** is set to **Quantize Link**, the note value is determined by the quantize grid. The **Snap** function is taken into account.

NOTE

To temporarily switch from the **Object Selection** tool to the **Draw** tool, hold down **Alt/Opt**.

Modifying Note Values while Inserting Notes

When inserting note events, you can modify specific note values on the fly.

- To edit the note velocity, drag upwards or downwards.
- To edit the note pitch, hold down **Alt/Opt** and drag upwards or downwards.
- To edit the note length, drag to the left or to the right.
- To edit the time position, hold down **Shift** and drag to the left or to the right.

NOTE

You can activate/deactivate **Snap** temporarily by holding down **Ctrl/Cmd**.

Drawing Note Events with the Line Tool

In the note display, the **Line** tool allows you to draw a series of contiguous note events along different line shapes.

- To create contiguous note events, click and drag in the note display.
- To restrict movement to horizontal, press **Ctrl/Cmd** and drag.
The notes have the same pitch.

If **Snap** is activated, the note events and controller events are positioned and sized according to the **Quantize** and **Length Quantize** values.

RELATED LINKS

[Line Tool Modes](#) on page 972

Line Tool Modes

The **Line** tool allows you to create a series of contiguous note events along different line shapes. You can also edit multiple controller events simultaneously.

- To open the **Line** tool modes, click **Line**.

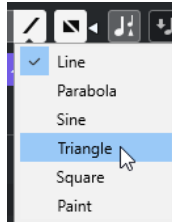

The following line modes are available:

Line

If this option is activated, you can click and drag to insert note events in the note display along a straight line in any angle. Use this option to edit controller data along a straight line in the controller display.

Parabola, Sine, Triangle, Square

These modes insert note events along different curve shapes.

Paint

This mode allows you to insert note events by painting in the note display.

Moving and Transposing Note Events

There are several options to move and transpose note events.

- To move note events in the editor, select the **Object Selection** tool and drag them to a new position.
All selected note events are moved, maintaining their relative positions. **Snap** is taken into account.
- To allow only horizontal or only vertical movement, hold down **Ctrl/Cmd** while dragging.
- To move note events via the **Nudge Palette** buttons on the toolbar, select the note events and click a **Nudge Palette** button.
This moves the selected note events by the **Snap** value in the drum sound list.
- To move note events to the project cursor position, select the note events and select **Edit > Move to > Cursor**.
- To move a note event via the info line, select a note event and edit the **Position** or **Pitch** on the info line.
- To transpose note events, select the note events and use the **Transpose Palette** buttons on the toolbar or the **Up Arrow / Down Arrow** keys.
Transpose is also affected by the global transpose setting.
- To transpose note events via the **Transpose Setup** dialog, select the note events and select **MIDI > Transpose Setup**.
- To transpose note events in steps of one octave, press **Shift** and use the **Up Arrow / Down Arrow** keys.

NOTE

- When you move selected note events to a different position, any selected controllers for these note events move accordingly.
- You can also adjust the position of note events by quantizing.

RELATED LINKS

[Transpose Setup Dialog](#) on page 901

Resizing Note Events

Do one of the following:

- To resize the note event, position the **Object Selection** tool at the start or the end of a note event and drag the mouse cursor to the left or right.
- To apply time-stretching and note expression data to a controller that is associated with the note event that you resize, activate **Sizing Applies Time Stretch** for the **Object Selection** tool before you resize the note.
- To move the start or end positions of the selected notes in steps according to the **Length Quantize** value on the toolbar, use the **Trim Start/End** buttons on the **Nudge Palette**.
- Select the note and adjust its length on the info line.
- Select **Draw** and drag left or right within the note display to draw a note. The resulting note event length is a multiple of the **Length Quantize** value on the toolbar.
- Select **Trim** and cut off the end or the beginning of note events.

RELATED LINKS

[Setup Options](#) on page 1338

[Value Editing Rules on the Info Line](#) on page 62

[Using the Trim Tool](#) on page 973

[Resizing Events with the Object Selection Tool - Sizing Applies Time Stretch](#) on page 230

Using the Trim Tool

The **Trim** tool allows you to change the length of note events by cutting off the end or the beginning of notes. Using the **Trim** tool means moving the note-on or the note-off event for one or several notes to a position defined with the mouse.

PROCEDURE

1. Select **Trim** on the toolbar.
The mouse pointer changes to a knife symbol.
2. To edit a single note, click it.
The range between the mouse pointer and the end of the note is removed. Use the mouse note info on the status line to find the exact position for the trim operation.
3. To edit several notes, click and drag with the mouse across the notes.



By default, the **Trim** tool cuts off the end of notes. To trim the beginning of notes, press **Alt** while dragging. When dragged across several notes, a line is displayed. The notes are trimmed along this line. If you press **Ctrl/Cmd** while dragging, you get a vertical trim line, allowing you to set the same start or end time for all edited notes. You can change the **Trim** tool key commands in the **Preferences** dialog (**Editing—Tool Modifiers** page).

Splitting Note Events

- To split the note at the position that you point, select **Split**, and click on a note.
If several notes are selected, they are all split at the same position. The snap setting is taken into account.
- To split all notes that are intersected by the project cursor position, select **Edit > Functions > Split at Cursor**.
- To split all notes that are intersected by the left or right locator at the locator positions, select **Edit > Functions > Split Loop**.

Gluing Note Events

You can glue together note events of the same pitch.

- To glue note events, select **Glue** and click on a note event.
The note event is glued together with the next note event of the same pitch. The result is a long note event that spans from the start of the first note to the end of the second note. The properties (velocity, pitch, etc.) of the first note event apply.

Changing the Pitch of Chords

You can use the chord type buttons to change the pitch of chords.

PROCEDURE

1. In the **Key Editor Inspector**, open the **Chord Editing** section.
 2. In the note display, select the notes that you want to edit.
If the chord is recognized, the root note, chord type, and tensions are indicated in the **Chord Type** field. This also works with arpeggiated notes.
 3. In the **Chord Editing** section, activate one of the **3-Note Chords/Triads** buttons or **4-Note Chords** buttons.
The selected notes are transposed so that they fit the selected chord type.
 4. Use the **Up Arrow** / **Down Arrow** keys to change the pitch of the chord.
-

Changing the Voicing of Chords

PROCEDURE

1. In the **Key Editor Inspector**, open the **Chord Editing** section.
 2. In the note display, select the notes that you want to edit.
 3. In the **Chord Editing** section, use the **Inversions** buttons and the **Drop Notes** buttons to change the voicing.
-

RESULT

The selected notes are transposed so that they fit the selected chord type.

Chord Editing Section

The **Chord Editing** section in the **Key Editor Inspector** allows you to insert and edit chords, and change voicings.

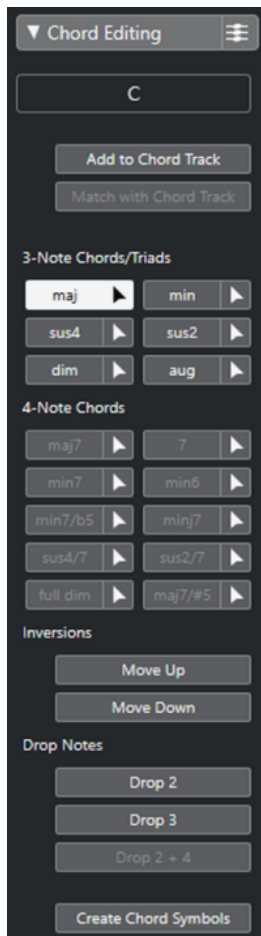

Chord type of selected notes

Shows the chord type of the selected chords.

Add to Chord Track

Adds the chord indicated in the **Chord type of selected notes** field to the chord track. The chord event is inserted at the position on the chord track that corresponds to the position of the MIDI notes. Any existing chord events at this position are overwritten.

Match with Chord Track

Applies the chord events from the chord track to the selected notes in the MIDI editor. The chord event that is effective at the position of the first selected note is applied to the selected notes, which are then transposed. Only the basic chord type is applied. Tensions are not taken into account.

Only the first effective chord event is applied.

3-Note Chords/Triads

Allows you to insert triads to the note display. You can also click one of the **3-Note Chords/Triads** buttons to transpose the selected notes so that they fit to the selected chord type.

4-Note Chords

Allows you to insert 4-note chords to the note display. You can also click one of the **4-Note Chords** buttons to transpose the selected notes so that they fit to the selected chord type.

Inversions - Move Up



Inverts the lowest note of a chord. The corresponding notes are transposed by as many octaves as needed.

Inversions - Move Down



Inverts the highest note of a chord. The corresponding notes are transposed by as many octaves as needed.

Drop Notes - Drop 2



Moves the second highest note of a chord down by one octave.

Drop Notes - Drop 3



Moves the third highest note of a chord down by one octave.

Drop Notes - Drop 2 + 4



Moves the second and fourth highest notes of a chord down by one octave.

Create Chord Symbols

Performs a chord analysis of the selected notes. If nothing is selected, the whole MIDI part is analyzed.

Inserting Chords

You can use the tools in the **Chord Editing** section of the **Key Editor Inspector** to insert and edit chords.

PROCEDURE

1. In the **Key Editor Inspector**, open the **Chord Editing** section.
 2. Select the **Insert** tool  to the right of the chord type that you want to insert.
 3. Click in the note display and drag to the left or right to determine the length of the chord. Drag up or down to determine its pitch.
To change the chord type while you insert chords, hold **Alt** and drag up or down.
If **Acoustic Feedback** is activated, you hear the chord while dragging. A tooltip indicates the root note and chord type of the inserted chord. **Snap** and **Length Quantize** are taken into account.
-

Applying Chord Events to Note Events

You can apply chord events from the chord track to notes in the MIDI editor.

PREREQUISITE

Create a chord track and add chord events.

PROCEDURE

1. Open the MIDI editor.

2. In the **Key Editor Inspector**, open the **Chord Editing** section.
 3. Select **Match with Chord Track**.
-

RESULT

The first chord event of the chord track is applied to the selected notes. Only the basic chord type is applied. Tensions are not taken into account.

Drum Map Handling

When a drum map is assigned to a MIDI or instrument track, the **Key Editor** displays the drum sound names as defined by the drum map. This allows you to use the **Key Editor** for drum editing, for example, when editing drum note lengths or when editing several parts to identify drum events.

The name of the drum sound is displayed in the following locations:

- On the info line in the **Pitch** field.
- On the status line in the **Mouse Value** field.
- In the note event if the zoom factor is high enough.
- When dragging a note event.

Expression Map Handling

When an expression map is assigned to a MIDI track, the musical articulations that are defined for that map are displayed in the following locations of the **Key Editor**:

- On the info line in the **Articulations** field.
- On the controller lane.
- In the note event if the vertical zoom factor is high enough.

Note Expression Data

The **Key Editor** is the main editor for working with Note Expression.

RELATED LINKS

[Expression Maps](#) on page 1015

Editing Note Events via MIDI Input

You can directly hear your editing results. Editing the properties of note events via MIDI can be a quick way to, for example, set the velocity value of a note event.

PROCEDURE

1. In the **Key Editor**, select the note event that you want to edit.
2. Click **MIDI Input** on the toolbar.
Editing via MIDI is enabled.
3. Use the note buttons on the toolbar to decide which properties are changed by the MIDI input.

You can enable editing of pitch, note-on and/or note-off velocity. For example, you can get the pitch and velocity values of the notes input via MIDI, but the note-off velocities remain as they are.

4. Play a note on your MIDI instrument.
-

RESULT

The selected note gets the pitch, note-on velocity and/or note-off velocity of the played note. The next note in the edited part is automatically selected to allow quick editing of a series of notes.

AFTER COMPLETING THIS TASK

To try another setting, select the note again and play a note on your MIDI instrument.

Step Input

Step input, or step recording, allows you to enter note events or chords one at a time without worrying about the exact timing. This is useful, for example, when you know the part that you want to record but are not able to play it exactly as you want it.

PROCEDURE

1. On the toolbar, activate **Step Input**.
2. Use the note buttons to the right to determine which properties are included when you insert the note events.
For example, you can include the note-on velocity and/or note-off velocity of the played notes. You can also deactivate the pitch property, in which case all notes get a pitch C3, no matter what you play.
3. Click anywhere in the note display to set the start position of the first note event or chord. The step input position is shown as a vertical line in the note display.

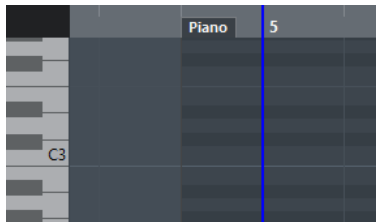

4. Specify the note event spacing and length with the **Quantize** and **Length Quantize** pop-up menus.
The note events that you insert are positioned according to the **Quantize** value and have the length of the **Length Quantize** value.

NOTE

If **Length Quantize** is set to **Quantize Link**, the note length is also determined by the **Quantize** value.

5. Play the first note event or chord on your MIDI instrument.
The note event or chord appears in the editor and the step input position advances by one quantize value step.

NOTE

If **Move Insert Mode** is activated, all note events to the right of the step input position are moved to make room for the inserted note event or chord.

6. Continue in the same way with the rest of the note events or chords.
You can adjust the **Quantize** or **Length Quantize** values to change the timing or note event lengths. You can also move the step input position manually by clicking anywhere in the note display.
To insert a rest, press the **Right Arrow** key. This advances the step input position by one step.

- When you are done, click **Step Input** again to deactivate step input.

Drum Editor

The **Drum Editor** is the editor to use when you are editing drum or percussion parts.

You can open the **Drum Editor** in a separate window or in the lower zone of the **Project** window. Opening the **Drum Editor** in the lower zone of the **Project** window is useful if you want to access the **Drum Editor** functions from within a fixed zone of the **Project** window.

To open a MIDI part in the **Drum Editor**, do one of the following:

- Select a MIDI part in the **Project** window and select **MIDI > Open Drum Editor**.

If the MIDI track has a drum map assigned and **Editor Content Follows Event Selection** and **Use Drum Editor when Drum Map is assigned** are activated in the **Preferences** dialog (**Editors** page), you can do the following to open a MIDI part in the **Drum Editor**:

- Double-click a MIDI part in the **Project** window.
- Select a MIDI part in the **Project** window and press **Return** or **Ctrl/Cmd - E**.
- Select a MIDI part in the **Project** window and select **MIDI > Open Drum Editor**.
- In the **Key Commands** dialog in the **Editors** category, assign a key command for **Open Drum Editor**. Select a MIDI part in the **Project** window and use the key command.

NOTE

If you select **MIDI > Set up Editor Preferences**, the **Preferences** dialog opens on the **Editors** page. Make your changes to specify if you want the **Drum Editor** to open in a separate window or in the lower zone of the **Project** window.

The **Drum Editor** window:

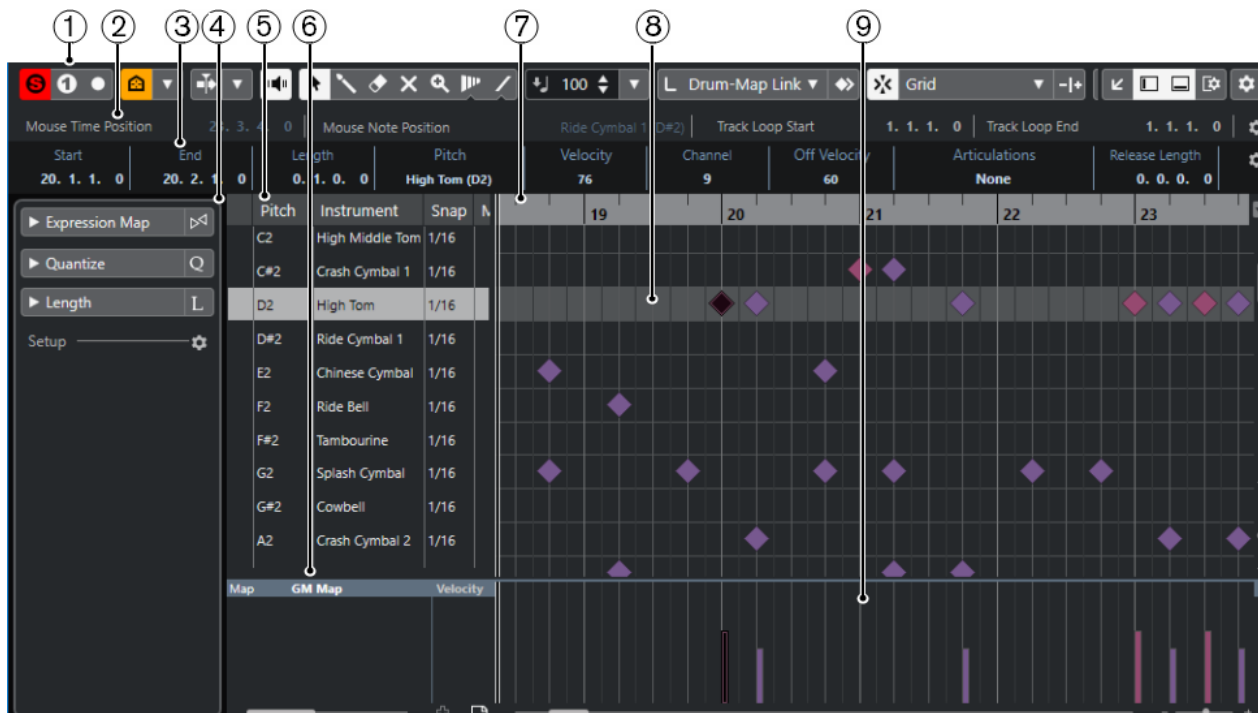

The **Drum Editor** is shown in the **Editor** tab in the lower zone of the **Project** window:

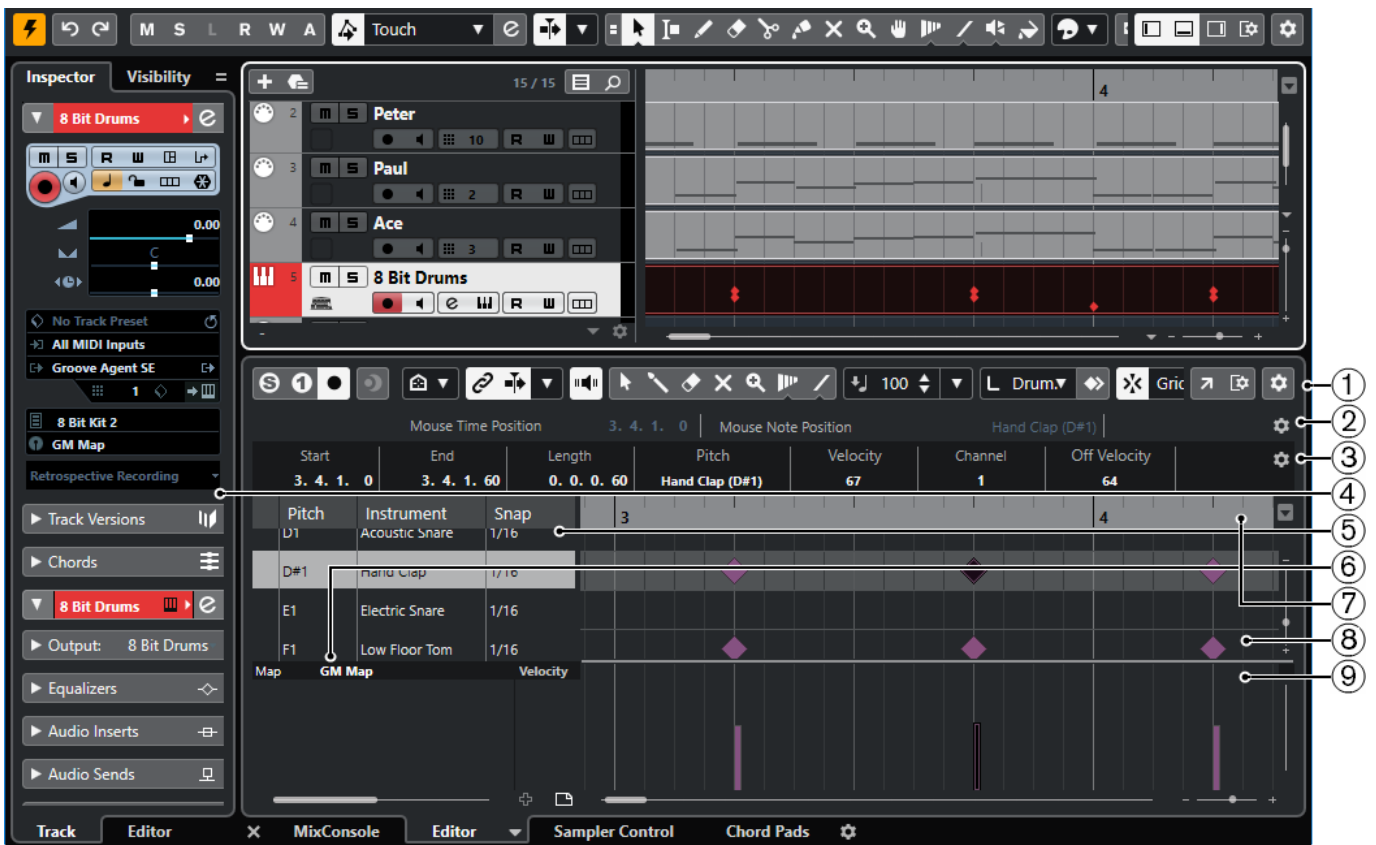

The **Drum Editor** is divided into several sections:

- 1 **Toolbar**
Contains tools and settings.
- 2 **Status line**
Informs about the mouse time position and the mouse value.
- 3 **Info line**
Displays information about the selected event.
- 4 **Drum Editor Inspector**
Contains tools and functions for working with MIDI data.
- 5 **Drum sound list**
Lists all drum sounds.
- 6 **Drum map**
Lets you select the drum map for the edited track or a list of drum sound names.
- 7 **Ruler**
Displays the time line.
- 8 **Note display**
Contains a grid in which notes are displayed.
- 9 **Controller display**
The area below the note display consists of one or multiple controller lanes.

NOTE

You can activate/deactivate the status line, the info line, and the controller lanes by clicking **Set up Window Layout** on the toolbar and activating/deactivating the corresponding options.

Drum Editor Toolbar

The toolbar contains tools and various settings for the **Drum Editor**.

- To show or hide the toolbar elements, right-click the toolbar and activate or deactivate the elements.

Retrospective Record

Insert MIDI Retrospective Recording in Editor



Allows you to recover MIDI notes that you played in stop mode or during playback.

Left Divider

Left Divider

Allows you to use the left divider. Tools that are placed to the left of the divider are always shown.

Pitch Visibility

Pitch Visibility On/Off



Activates the selected pitch visibility option.

Select Pitch Visibility Options



Deactivate this to show all drum sounds in the note display. Activate this to reduce the drum sounds in the note display according to the selected pitch visibility option.

- **Show Drum Sounds with Events** shows only the drum sounds for which events are available in the note display.
- **Show Drum Sounds in Use by Instruments** shows the drum sounds for which a pad, etc. is in use for the instrument. This option is only available if the instrument can provide this information.
- **Reverse Drum Sound List** reverses the order of the sounds displayed in the drum sound list.

Auto-Scroll

Link Project and Lower Zone Editor Cursors



Links timelines, cursors, and zoom factors of the **Editor** tab in the lower zone and the **Project** window.

NOTE

You cannot activate **Link Project and Lower Zone Editor Cursors** if **Independent Track Loop** is active.

Auto-Scroll



Keeps the project cursor visible during playback.

Select Auto-Scroll Settings



Allows you to activate **Page Scroll** or **Stationary Cursor** and to activate **Suspend Auto-Scroll When Editing**.

Acoustic Feedback

Acoustic Feedback



Automatically plays back events when you move or transpose them, or when you create them by drawing.

Tool Buttons

Object Selection



Selects events and parts.

Drumstick



Draws drum events.

Erase



Deletes events.

Mute



Mutes events.

Zoom



Zooms in. Hold **Alt/Opt** and click to zoom out.

Time Warp



Adjusts musical positions of events to time positions.

Line



Creates a series of contiguous events.

Auto Select Controllers

Auto Select Controllers



Automatically selects controller data of the selected MIDI notes.

Independent Track Loop

Independent Track Loop



Activates/Deactivates the independent track loop.

NOTE

If you activate **Independent Track Loop**, the **Link Project and Lower Zone Editor Cursors** function is automatically deactivated in the **Editor** tab in the lower zone.

Nudge Palette

Trim Start Left



Increases the length of the selected event by moving its start to the left.

Trim Start Right



Decreases the length of the selected event by moving its start to the right.

Move Left



Moves the selected event to the left.

Move Right



Moves the selected event to the right.

Trim End Left



Decreases the length of the selected event by moving its end to the left.

Trim End Right



Increases the length of the selected event by moving its end to the right.

Transpose Palette

Move Up



Transposes the selected event up by a half note.

Move Down



Transposes the selected event down by a half note.

Move Up More



Transposes the selected event up by an octave.

Move Down More



Transposes the selected event down by an octave.

Insert Velocity

Note Insert Velocity



Allows you to specify a velocity value for new notes.

Notes Length

Insert Length

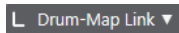

Allows you to determine a length for newly created notes.

Show Note Length On/Off



Shows drum notes as boxes that display the note length.

Snap

Snap On/Off



Activates/Deactivates the **Snap** function.

Snap Type



Allows you to select one of the following snap types:

- **Grid** snaps events to the grid that is selected in the **Quantize Presets** pop-up menu.
- **Grid Relative** keeps the relative positions when snapping events to the grid.
- **Events** snaps events to the start or end of other events.
- **Shuffle** changes the order of events if you drag one event to the left or right of other events.
- **Cursor** snaps events to the cursor position.
- **Grid + Cursor** snaps events to the quantize grid that is selected in the **Quantize Presets** pop-up menu or to the cursor position.
- **Events + Cursor** snaps events to the start or end of other events, or to the cursor position.
- **Grid + Events + Cursor** snaps events to the quantize grid that is selected in the **Quantize Presets** pop-up menu, to the start or end of other events or to the cursor position.

Grid Type



Allows you to select one of the following grid types:

- **Use Quantize** activates a grid where events snap to the value that is selected in the **Quantize Presets** pop-up menu.
- **Adapt to Zoom** activates a grid where events snap to the zoom level.
- **Use Snap from Drum Map** activates a grid where events snap to the **Snap** value that is selected in the drum map.

Quantize

Apply Quantize



Applies the quantize settings.

Quantize Presets



Allows you to select a quantize or a groove preset.

Soft Quantize On/Off



Activates/Deactivates soft quantize.

Open Quantize Panel



Opens the **Quantize Panel**.

Multiple Part Controls

Show Part Borders



Shows/Hides part borders for the active MIDI part within the left and right locators.

Edit Active Part Only



Restricts editing operations to the active part.

Currently Edited Part

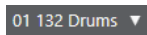

Lists all parts that were selected when you opened the editor, and allows you to activate a part.

Event Colors

Event Colors

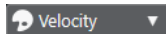

Allows you to select event colors.

Step/MIDI Input

Step Input



Activates/Deactivates MIDI step input.

MIDI Input/Note Expression MIDI Input



Activates/Deactivates MIDI input and note expression MIDI input.

Move Insert Mode



Moves all note events to the right of the step input position to the right to make room for the inserted event when you insert notes.

NOTE

This only works if **Step Input** is activated.

Record Pitch



Includes the pitch when you insert notes.

Record NoteOn Velocity



Includes the NoteOn velocity when you insert notes.

Record NoteOff Velocity



Includes the NoteOff velocity when you insert notes.

Edit VST Instrument

Edit VST Instrument



Opens the VST instrument that the track is routed to.

Right Divider

Right Divider

Allows you to use the right divider. Tools that are placed to the right of the divider are always shown.

Window Zone Controls

Open in Separate Window



This button is available in the **Editor** tab in the lower zone. It opens the editor in a separate window.

Open in Lower Zone



This button is available in the editor window. It opens the **Editor** tab in the lower zone of the **Project** window.

Show/Hide Left Zone



Shows/Hides the left zone.

Show/Hide Controller Lanes



Shows/Hides the controller lanes.

Set up Window Layout



Allows you to set up the window layout.

Set up Toolbar



Opens a pop-up menu where you can set up which toolbar elements are visible.

RELATED LINKS

[Zooming in MIDI Editors](#) on page 913

Status Line

The status line is displayed below the toolbar. It displays important mouse information.

- To show the status line, click **Set up Window Layout** on the toolbar, and activate **Status Line**.

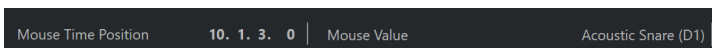

The on/off status of the status line in the **Drum Editor** window and in the **Editor** tab in the lower zone of the **Project** window are independent of each other.

Mouse Time Position

Displays the exact time position of the mouse pointer, depending on the selected ruler display format. This lets you edit or insert notes at exact positions.

Mouse Value

Displays the exact pitch of the mouse pointer position in the event display. This facilitates finding the right pitch when entering or transposing notes.

If you move the mouse in the controller display, the controller event value at the mouse cursor position is displayed.

Track Loop Start/Track Loop End

If **Independent Track Loop** is activated on the toolbar and you set up a loop, the start/end position is displayed.

RELATED LINKS

[Drum Editor Toolbar](#) on page 981

Info Line

The info line shows values and properties of the selected events. If several notes are selected, the values for the first note are displayed in color.

- To show the info line, click **Set up Window Layout** on the toolbar, and activate **Info Line**.

Start	End	Length	Pitch	Velocity	Channel
6. 4. 1. 0	6. 4. 2. 0	0. 0. 1. 0	Vibraslap (Bb2)	56	10
Off Velocity	Articulations	Release Length	Voice	Text	
60	None	0. 0. 0. 0	--		

Length and position values are displayed in the selected ruler display format.

The on/off status of the info line in the **Drum Editor** window and in the **Editor** tab in the lower zone of the **Project** window are independent of each other.

RELATED LINKS

[Editing Note Events on the Info Line](#) on page 919

Drum Editor Inspector

The **Drum Editor Inspector** is located to the left of the note display. It contains tools and functions for working with MIDI data.

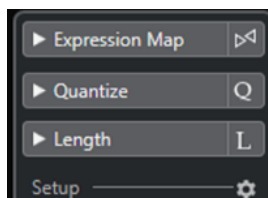

Expression Map

Allows you to load an expression map. Expression maps are useful for working with articulations.

Quantize

Allows you to access the main quantize parameters. These are identical with the functions on the **Quantize Panel**.

Length

Contains length-related options, similar to the **Functions** submenu of the **MIDI** menu.

- To change the length of the selected MIDI events or all events of the active part if no events are selected, use the **Scale Length/Scale Legato** slider.

At the maximum value the notes reach the beginning of the next note.

- To make the new length settings permanent, click **Freeze MIDI Lengths**.
- To fine-tune the distance between consecutive notes, use the **Overlap** slider.

At **0 Ticks**, the **Scale Length/Scale Legato** slider extends each note so that it reaches the next note exactly. Positive values cause the notes to overlap and negative values allow you to define a small gap between the notes.

- To use the **Legato** function or slider to extend a note until the next selected note, activate **Extend to Next Selected**.

This is identical with activating the **Legato Mode: Between Selected Notes Only** option in the **Preferences** dialog.

Setup

Allows you to open a dialog to edit the **Drum Editor Inspector** settings. Click **Setup Inspector**, and from the pop-up menu, select **Setup**.

NOTE

If you open the **Drum Editor** in the lower zone, these sections are shown in the **Editor Inspector** in the left zone.

RELATED LINKS

- [Expression Maps](#) on page 1015
- [Note Expression Inspector Section](#) on page 1033
- [Quantize Panel](#) on page 326
- [Transpose Functions](#) on page 360
- [Opening the Editor Inspector](#) on page 66

Note Display

The note display of the **Drum Editor** contains a grid in which note events are shown.

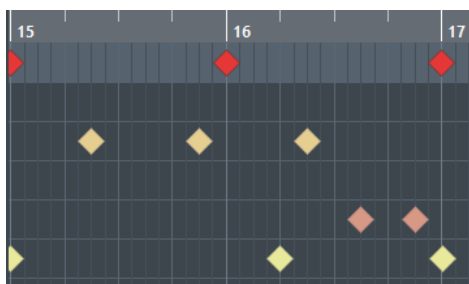

The notes are displayed as diamond symbols. If you activate **Show Note Length On/Off** on the toolbar, notes are displayed as boxes and show the note length.

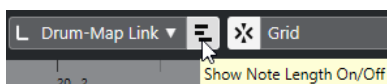

The vertical position of the notes corresponds to the drum sound list to the left, while the horizontal position corresponds to the note's position in time.

RELATED LINKS

[Drum Editor Toolbar](#) on page 981

Drum Sound List

The drum sound list lists all drum sounds by name and allows you to adjust and manipulate the drum sound setup in various ways.

	Pitch	Instrument	Snap	Mute	I-Note	O-Not	Chan	Output
	C1	Bass Drum	1/16		C1	C1	10	Track
	C#1	Side Stick	1/16		C#1	C#1	10	Track
	D1	Acoustic Snare	1/16	●	D1	D1	10	Track
	D#1	Hand Clap	1/16		D#1	D#1	10	Track
	E1	Electric Snare	1/16		E1	E1	10	Track
	F1	Low Floor Tom	1/16		F1	F1	10	Track
	F#1	Closed Hi-Hat	1/16		F#1	F#1	10	Track
	G1	High Floor Tom	1/16		G1	G1	10	Track
	G#1	Pedal Hi-Hat	1/16		G#1	G#1	10	Track
	A1	Low Tom	1/16		A1	A1	10	Track
Map	GM Map							Velocity

NOTE

The number of columns in the list depends on whether a drum map is selected for the track or not.

Pitch

Note number of the drum sound.

Instrument

Name of the drum sound.

Snap

This is used when entering and editing notes.

Mute

Allows you to mute drum sounds.

I-Note

Input note for the drum sound. When you play this note, it is mapped to the corresponding drum sound and automatically transposed according to the **Pitch** setting for the sound.

O-Note

The MIDI output note that is sent out every time the drum sound is played back.

Channel

The MIDI channel, on which the drum sound is played back.

Output

MIDI output on which the drum sound is played back.

RELATED LINKS

[Muting Notes and Drum Sounds](#) on page 993

[Drum Maps](#) on page 993

Select Pitch Visibility Options Menu

The **Select Pitch Visibility Options** pop-up menu on the drum editor toolbar allows you to determine which drum sounds are shown in the drum sound list.

- Activate **Pitch Visibility On/Off**, and click **Select Pitch Visibility Options** on the toolbar.

NOTE

If **Pitch Visibility On/Off** is deactivated, all drum sounds of the selected drum map are shown, and you can edit the order of the drum sound list manually.

Show Drum Sounds with Events

Shows only the drum sounds for which events are available in the selected MIDI part.

Show Drum Sounds in use by Instrument

Shows all drum sounds for which a pad, etc. is in use for the instrument. This option is only available if the instrument can provide this information.

Reverse Drum Sound List

Reverses the order of the sounds displayed in the drum sound list.

Drum Map and Names Menus

Below the drum sound list are pop-up menus that are used for selecting a drum map for the edited track or, if no drum map is selected, a list of drum sound names.



RELATED LINKS

[Drum Maps](#) on page 993

Drum Editor Operations

This section describes the general editing operations within the **Drum Editor**.

Inserting Drum Note Events

You can insert note events with the **Object Selection** tool or the **Drumstick** tool.

PREREQUISITE

You have set up the **Insert Length** on the toolbar to determine the length of the inserted note. If **Insert Length** is set to **Drum-Map Link**, the note gets the length of the **Snap** value set for the sound in the drum sound list. You have activated **Snap**.

NOTE

If you want to snap positions according to the **Quantize Presets** setting on the toolbar, activate **Use Quantize**.

PROCEDURE

- Perform one of the following actions:
 - Select the **Object Selection** tool and double-click in the event display.
 - Select the **Drumstick** tool and click in the event display.

NOTE

To temporarily switch from the **Object Selection** tool to the **Drumstick** tool, hold down **Alt/Opt**.

RESULT

A note event is inserted.

Inserting Multiple Drum Note Events

You can insert multiple note events of the same pitch with the **Object Selection** tool or the **Drumstick** tool.

PREREQUISITE

You have set up the **Insert Length** on the toolbar to determine the length of the inserted note. If **Insert Length** is set to **Drum-Map Link**, the note gets the length of the **Snap** value set for the sound in the drum sound list. You have activated **Snap**.

NOTE

If you want to snap positions according to the **Quantize Presets** setting on the toolbar, activate **Use Quantize**.

PROCEDURE

- Perform one of the following actions:
 - On the toolbar, select the **Object Selection** tool, double-click in the event display and drag to the right.
 - On the toolbar, select the **Drumstick** tool, click in the event display and drag to the right.
-

RESULT

The note events are inserted.

RELATED LINKS

[Drum Editor Toolbar](#) on page 981

Modifying Note Values While Inserting Notes

When inserting note events, you can modify specific note values on the fly.

- To edit the note velocity, drag upwards or downwards.
- To edit the note pitch, hold down **Alt/Opt** and drag upwards or downwards.
- To edit the note length, drag to the left or to the right.

NOTE

If you want to edit the note length in the **Drum Editor**, you must deactivate **Snap** and activate **Show Note Length On/Off**. Otherwise, the note is repeated.

- To edit the time position, hold down **Shift** and drag to the left or to the right.

NOTE

You can activate/deactivate **Snap** temporarily by holding down **Ctrl/Cmd**.

Changing the Note Length

You can change the note length in the drum editor with the **Object Selection** tool or with the **Drumstick** tool.

PREREQUISITE

You have activated **Show Note Length On/Off** on the drum editor toolbar.

PROCEDURE

1. Move the mouse pointer to the beginning or the end of the note that you want to edit.
The mouse pointer turns into a double arrow.
2. Drag to the left or to the right to adjust the length.
An info box with the current length value is displayed.
3. Release the mouse button.

RESULT

The note length is changed. **Snap** is taken into account.

Deleting Drum Note Events

PROCEDURE

- Perform one of the following actions:
 - Select the **Erase** tool and click the event.
 - Select the **Object Selection** tool and double-click the event.
 - Select the **Drumstick** tool and click the event.

RESULT

The note event is deleted.

Deleting Multiple Drum Note Events

You can delete multiple note events of the same pitch with the **Object Selection** tool or the **Drumstick** tool.

PREREQUISITE

To delete multiple note events with the **Object Selection** tool, **Snap** must be activated.

PROCEDURE

- Do one of the following:

- On the toolbar, select the **Object Selection** tool, double-click the first event you want to delete, and drag to the right.
- On the toolbar, select the **Drumstick** tool, click the first event you want to delete, and drag to the right.

RESULT

The note events are deleted.

Muting Notes and Drum Sounds

IMPORTANT

The mute state for drum sounds is part of the drum map. All other tracks using this map are affected.

- To mute individual notes, click or enclose them with the **Mute** tool, or select **Edit > Mute**.
- To mute a drum sound in a drum map, click in the **Mute** column for the drum sound.

Pitch	Instrument	Snap	Mute	I-Note	O-Not	Chan	Output
C1	Bass Drum	1/16	■	C1	C1	10	Track
C#1	Side Stick	1/16		C#1	C#1	10	Track
D1	Acoustic Snare	1/16		D1	D1	10	Track
D#1	Hand Clap	1/16	●	D#1	D#1	10	Track

- To mute all other drum sounds, click **Solo Instrument (Requires Drum Map)** on the toolbar.

RELATED LINKS

[Selecting a Drum Map for a Track](#) on page 996

Drum Maps

A drum kit in a MIDI instrument is most often a set of different drum sounds with each sound placed on a separate key. For example, the different sounds are assigned to different MIDI note numbers. One key plays a bass drum sound, another a snare, and so on.

Different MIDI instruments often use different key assignments. This can be troublesome if you have made a drum pattern using one MIDI device and then want to try it on another. When you switch devices, it is very likely that your snare drum becomes a ride cymbal or your hi-hat becomes a tom, etc., because the drum sounds are distributed differently in the instruments.

To solve this problem and to simplify several aspects of MIDI drum kits, such as using drum sounds from different instruments in the same drum kit, Nuendo features drum maps. A drum map is a list of drum sounds with a number of settings for each sound. When you play back a MIDI track for which you have selected a drum map, the MIDI notes are filtered through the drum map before they are sent to the MIDI instrument. The map determines which MIDI note number is sent out for each drum sound and which sound is played on the receiving MIDI device.

When you want to try your drum pattern on another instrument, you simply switch to the corresponding drum map, and your snare drum sound remains a snare drum sound.

If you want to have the same drum maps included in your projects, you can load these into the template.

NOTE

Drum maps are saved with the project files. If you have created or modified a drum map, use the **Save** function to save it as a separate XML file to make it available for loading into other projects.

RELATED LINKS

[Saving a Project Template File](#) on page 107

Drum Map Setup Dialog

This dialog allows you to load, create, modify, and save drum maps.

- To open the **Drum Map Setup** dialog, select **Drum Map Setup** from the **Map** pop-up menu or the **MIDI** menu.



The list on the left shows the loaded drum maps. The sounds and settings of the selected drum map are displayed on the right.

NOTE

The settings for the drum sounds are the same as in the **Drum Editor**.

Use Head Pairs

If this option is activated, 2 head symbols for each drum sound are displayed in the drum sound list.

Edit in Scores

If this option is activated, you can change the settings for the score drum map directly in the score.

Output

Allows you to select the output for the drum map sounds.

Drum Sound list

Lists all drum sounds and their settings. To audition a drum sound, click the leftmost column.

NOTE

If you audition a sound in the **Drum Map Setup** dialog and the sound is set to MIDI output **Default**, the output that is selected on the **Output** pop-up menu in the lower

left corner is used. When auditioning a default output sound in the **Drum Editor**, the MIDI output selected for the track is used.

The **Functions** pop-up menu contains the following options:

New Map

Adds a new drum map to the project. The drum sounds are named “Sound 1, Sound 2, etc.” and have all parameters set to default values. The map is named “Empty Map”.

To rename the drum map, click the name in the list and type in a new name.

New Copy

Adds a copy of the selected drum map to create a new drum map. You can then change the drum sound settings of the copy and rename the drum map in the list.

Remove

Removes the selected drum map from the project.

Load

Allows you to load drum maps into your project.

Save

Allows you to save the drum map that is selected in the list on disk. Drum map files have the extension .drm.

Edit head pairs

Allows you to customize the note pairs.

RELATED LINKS

[Drum Map Settings](#) on page 995

[Channel and Output Settings](#) on page 996

Drum Map Settings

A drum map consists of settings for 128 drum sounds, one for each MIDI note number.

- To get an overview of the drum map settings, open the **Drum Editor** and use the **Map** pop-up menu below the drum sound list to select the **GM Map** drum map.

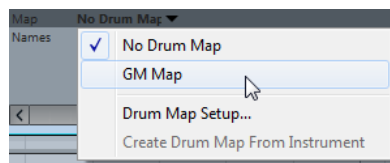

The GM map is set up according to the General MIDI standard.

You can change all drum map settings except the pitch directly in the drum sound list or in the **Drum Map Setup** dialog. These changes affect all tracks that use the drum map.

RELATED LINKS

[Drum Sound List](#) on page 989

[Drum Map Setup Dialog](#) on page 994

Importing Drum Maps from Virtual Instruments

You can import your drum map settings to an instrument track that is routed to Groove Agent SE.

PREREQUISITE

To import your drum map settings to an instrument track, the track has to be routed to Groove Agent SE or another drum instrument that supports drum maps.

PROCEDURE

1. Load a drum kit in Groove Agent SE.
2. In the **Inspector** for the track, open the **Drum Maps** pop-up menu and select **Create Drum Map from Instrument**.
The drum map is created for the kit that is assigned to the MIDI port and channel selected in the **Inspector**.
3. Open the **Drum Maps** pop-up menu again and select **Drum Map Setup**.
4. In the list on the left, select the kit that you have loaded in the instrument.

RESULT

The sounds and settings of the instrument are displayed in the **Drum Map Setup**.

NOTE

Instrument and pattern pads are both exported to the drum map. If they share keys, the pattern pads get priority, that is, their settings are included in the drum map.

Channel and Output Settings

You can set separate MIDI channels and/or MIDI outputs for each sound in a drum map. When a drum map is selected for a track, the MIDI channel settings in the drum map override the MIDI channel setting for the track.

You can select different channels and/or outputs for different sounds. This allows you to construct drum kits with sounds from several different MIDI devices, etc.

- To make a drum sound use the channel of the track, set the channel in the drum map to **Any**.
- To make the sound use the MIDI output that is selected for the track, set the MIDI output for a sound in a drum map to **Default**.
- To send the sound to a specific MIDI output, select any other option.
- To select the same MIDI channel or MIDI device for all sounds in a drum map, click in the **Channel** column, press **Ctrl/Cmd**, and select a channel or output.
- If you make specific MIDI channel and output settings for all sounds in a drum map, you can switch between drum maps to send your drum tracks to another MIDI instrument.

Selecting a Drum Map for a Track

- To select a drum map for a MIDI track, open the **Map** pop-up menu in the **Inspector** or in the **Drum Editor** and select a drum map.
- To deactivate the drum map functionality in the **Drum Editor**, open the **Map** pop-up menu in the **Inspector** or in the **Drum Editor** and select **No Drum Map**.

Even if you do not use a drum map, you can still separate sounds by name using a name list.

NOTE

Initially, the **Map** pop-up menu only contains **GM Map**.

I-Notes, O-Notes, and Pitches

Going through the following theory helps you make the most out of the drum map concept – especially if you want to create your own drum maps.

A drum map is a kind of filter that transforms notes according to the settings in the map. It does this transformation twice; once when it receives an incoming note, that is when you play a note on your MIDI controller, and once when a note is sent from the program to the MIDI sound device.

The following example shows a modified drum map with a bass drum sound that has different pitch, I-note, and O-note values.

	Pitch	Instrument	Snap	Mute	I-Note	O-Note	Channel	Output
	C1	Bass Drum	1/16		A1	B0	10	Track
	C#1	Side Stick	1/16		C#1	C#1	10	Track
	D1	Acoustic Snare	1/16		D1	D1	10	Track
	D#1	Hand Clap	1/16		D#1	D#1	10	Track

I-Notes (Input Notes)

When you play a note on your MIDI instrument, the program looks for this note number among the I-notes in the drum map. If you play the note A1, the program finds that this is the I-note of the bass drum sound.

This is where the first transformation happens: the note gets a new note number according to the pitch setting for the drum sound. In our case, the note is transformed to a C1 note, because that is the pitch of the bass drum sound. If you record the note, it is recorded as a C1 note.

For example, you can place drum sounds near each other on the keyboard so that they can be easily played together, move sounds so that the most important sounds can be played from a short keyboard, play a sound from a black key instead of a white. If you never play your drum parts from a MIDI controller but draw them in the editor, you do not need the I-note setting.

O-Notes (Output Notes)

The next step is the output. This is what happens when you play back the recorded note, or when the note you play is sent back out to a MIDI instrument in real time (MIDI Thru):

The program checks the drum map and finds the drum sound with the pitch of the note. In our case, this is a C1 note and the drum sound is the bass drum. Before the note is sent to the MIDI output, the second transformation takes place: the note number is changed to that of the O-note for the sound. In our example, the note sent to the MIDI instrument is a B0 note.

The O-note settings let you set things up so that the bass drum sound really plays a bass drum. If you are using a MIDI instrument in which the bass drum sound is on the C2 key, you set the O-note for the bass drum sound to C2. When you switch to another instrument (in which the bass drum is on C1) you want the bass drum O-note set to C1. Once you have set up drum maps for all your MIDI instruments, you can select another drum map when you want to use another MIDI instrument for drum sounds.

Setting Pitches of Notes According to their O-Note Settings

You can set the pitch of notes according to their O-note settings. This is useful if you want to convert a track to a regular MIDI track with no drum map and still have the notes play back the correct drum sound.

It is a typical use case to export your MIDI recording as a standard MIDI file. If you first perform an O-note conversion, you make sure that your drum tracks play back as intended when they are exported.

- To perform an O-note conversion, select **MIDI > O-Note Conversion**.

RELATED LINKS

[Exporting MIDI Tracks as Standard MIDI Files](#) on page 177

List Editor

The **List Editor** shows all events in the selected MIDI parts as a list, allowing you to view and edit their properties numerically. It also allows you to edit SysEx messages.

- To open a MIDI part in the **List Editor**, select a MIDI part in the **Project** window and select **MIDI > Open List Editor**.

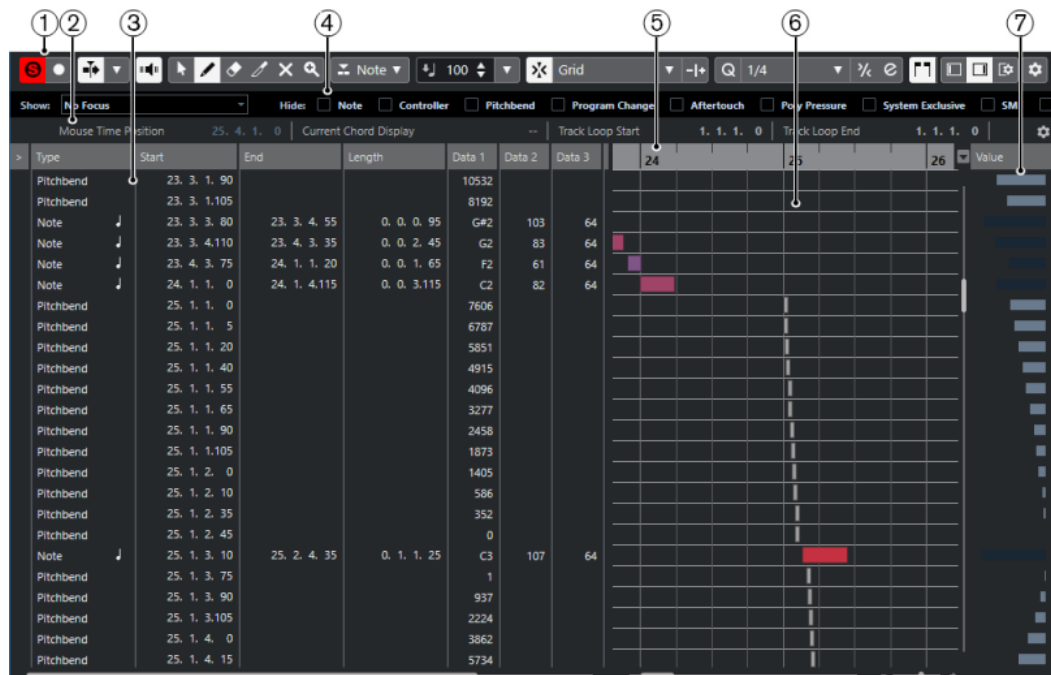

The **List Editor** is divided into several sections:

- 1 Toolbar
- 2 Status line
- 3 Event list
- 4 Filters bar
- 5 Ruler
- 6 Event display
- 7 Value display

NOTE

The filters, the status line, and the value display can be activated/deactivated by clicking **Set up Window Layout** on the toolbar and activating/deactivating the corresponding options.

List Editor Toolbar

The toolbar contains tools and various settings for the **List Editor**.

- To show or hide the toolbar elements, right-click the toolbar and activate or deactivate the elements.

Default Items

Solo Editor



Solos the editor during playback if the editor has the focus.

Record in Editor



Enables the recording of MIDI data in the editor if the editor has the focus.

NOTE

This only works if **MIDI Record Mode** is set to **Merge** or **Replace**.

Retrospective Record

Insert MIDI Retrospective Recording in Editor



Allows you to recover MIDI notes that you played in stop mode or during playback.

Auto-Scroll

Auto-Scroll



Keeps the project cursor visible during playback.

Select Auto-Scroll Settings



Allows you to activate **Page Scroll** or **Stationary Cursor** and to activate **Suspend Auto-Scroll When Editing**.

Acoustic Feedback

Acoustic Feedback



Automatically plays back events when you move or transpose them, or when you create them by drawing.

Tool Buttons

Object Selection



Selects events and parts.

Draw



Draws events.

Erase



Deletes events.

Trim



Trims events.

Mute



Mutes events.

Zoom



Zooms in. Hold **Alt/Opt** and click to zoom out.

Independent Track Loop

Independent Track Loop



Activates/Deactivates the independent track loop.

Insert Type

Insert Event Type

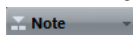

Allows you to determine an event type for newly created events.

Insert Velocity

Note Insert Velocity

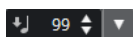

Allows you to specify a velocity value for new notes.

Nudge Palette

Trim Start Left



Increases the length of the selected event by moving its start to the left.

Trim Start Right



Decreases the length of the selected event by moving its start to the right.

Move Left



Moves the selected event to the left.

Move Right



Moves the selected event to the right.

Trim End Left



Decreases the length of the selected event by moving its end to the left.

Trim End Right



Increases the length of the selected event by moving its end to the right.

Snap

Snap On/Off



Activates/Deactivates the **Snap** function.

Snap Type



Allows you to select one of the following snap types:

- **Grid** snaps events to the grid that is selected in the **Quantize Presets** pop-up menu.
- **Grid Relative** keeps the relative positions when snapping events to the grid.
- **Events** snaps events to the start or end of other events.
- **Shuffle** changes the order of events if you drag one event to the left or right of other events.
- **Cursor** snaps events to the cursor position.
- **Grid + Cursor** snaps events to the quantize grid that is selected in the **Quantize Presets** pop-up menu or to the cursor position.
- **Events + Cursor** snaps events to the start or end of other events, or to the cursor position.
- **Grid + Events + Cursor** snaps events to the quantize grid that is selected in the **Quantize Presets** pop-up menu, to the start or end of other events or to the cursor position.

Quantize

Apply Quantize



Applies the quantize settings.

Quantize Presets



Allows you to select a quantize or a groove preset.

Soft Quantize On/Off



Activates/Deactivates soft quantize.

Open Quantize Panel



Opens the **Quantize Panel**.

Length Quantize

Length Quantize

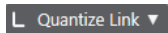

Allows you to set a value for quantizing event lengths.

Multiple Part Controls

Show Part Borders



Shows/Hides part borders for the active MIDI part within the left and right locators.

Edit Active Part Only



Restricts editing operations to the active part.

Currently Edited Part

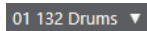

Lists all parts that were selected when you opened the editor, and allows you to activate a part.

Step/MIDI Input

Step Input



Activates/Deactivates MIDI step input.

MIDI Input/Note Expression MIDI Input



Activates/Deactivates MIDI input and note expression MIDI input.

Move Insert Mode



Moves all note events to the right of the step input position to the right to make room for the inserted event when you insert notes.

NOTE

This only works if **Step Input** is activated.

Record Pitch



Includes the pitch when you insert notes.

Record NoteOn Velocity



Includes the NoteOn velocity when you insert notes.

Record NoteOff Velocity



Includes the NoteOff velocity when you insert notes.

Event Colors

Event Colors

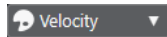

Allows you to select event colors.

Right Divider

Right Divider

Allows you to use the right divider. Tools that are placed to the right of the divider are always shown.

Edit VST Instrument

Edit VST Instrument



Opens the VST instrument that the track is routed to.

Window Zone Controls

Show/Hide Left Zone



Shows/Hides the left zone.

Show/Hide Right Zone



Shows/Hides the right zone.

Set up Window Layout



Allows you to set up the window layout.

Set up Toolbar



Opens a pop-up menu where you can set up which toolbar elements are visible.

RELATED LINKS

[Setup Options](#) on page 1338

Status Line

The status line is displayed below the toolbar. It displays important information about the mouse position.

- To show the status line, click **Set up Window Layout** on the toolbar, and activate **Status Line**.

Mouse Time Position 25. 2. 1. 0 | Current Chord Display -- | Track Loop Start 1. 1. 1. 0 | Track Loop End 1. 1. 1. 0

The on/off status of the status line in the **List Editor** window and in the **Editor** tab in the lower zone of the **Project** window are independent of each other.

Mouse Time Position

Displays the exact time position of the mouse pointer, depending on the selected ruler display format. This allows you to edit or insert notes at exact positions.

Current Chord Display

When the project cursor is positioned over notes that form a chord, this chord is displayed here.

Track Loop Start/End

If **Independent Track Loop** is activated on the toolbar, its start/end position are displayed.

RELATED LINKS

[Drum Editor Toolbar](#) on page 981

Filters Bar

The filters bar allows you to hide events from view, based on their type and other properties.

- To show the filters bar, click **Set up Window Layout** on the toolbar, and activate **Filters**.

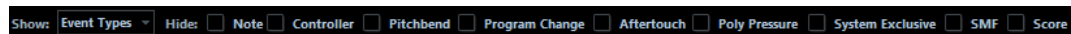

Show Section

The **Show** section allows you to set up filters.

No Focus

No filter is applied.

Event Types

Only events of the same event type as the selected type will be shown. This is the same as activating event types in the **Hide** section.

Event Types and Data 1

Only events of the same event type as the selected type and with the same **Data 1** value are shown. For example, if a note event is selected, only notes with the same pitch are shown. If a controller event is selected, only controllers of the same type are shown.

Event Channels

Only events with the same MIDI channel value as the selected event are shown.

Presets

Allows you to use a preset.

Setup

Opens the **Logical Editor**. Here you can create complex filter settings.

When you apply any of the **Logical Editor** presets or use the **Logical Editor** to create filter settings yourself, only the events that meet the specified criteria are visible.

Hide Section

The **Hide** section allows you to hide specific event types from view.

RELATED LINKS

[Filtering the Event List](#) on page 1008

[Logical Editor](#) on page 1101

Event List

The **Event List** lists all events in the selected MIDI parts, in the order in which they are played back from top to bottom. The list allows you to perform detailed numerical editing of the event properties.

The following options are available:

>

An arrow in this column indicates the event that starts closest before the project cursor position. You can use this column for auditioning when you are editing in the list.

- To move the cursor to the start of the event, click in the auditioning column of an event.
- To move the cursor position and start/stop playback, double-click in the column for an event.

Type

Event type. Cannot be changed.

Start

Starting position of the event, displayed in the format selected for the ruler. Changing it has the same effect as moving the event.

NOTE

If you move the event past any other event in the list, the list is resorted. The list always shows the events in the order in which they are played back.

End

Allows you to view and edit the end position of a note event. Editing resizes the note event.

Length

Displays the length of the note event. Changing this resizes the note event and automatically changes the **End** value.

Data 1

Data 1 or **Value 1** property of the event. Its content depends on the event type. For notes, this is the pitch, for example. Where applicable, the values are displayed in the most relevant form. For example, the **Data 1** value for notes is displayed as a note number in the format that was selected in the **Preferences** dialog.

Data 2

Data 2 or **Value 2** property of the event. The content of this depends on the event type. For notes, this is the note-on velocity value, for example.

Data 3

The **Data 3** or **Value 3** property of the event. This value is only used for note events, where it corresponds with the note-off velocity.

Channel

MIDI channel of the event. This setting is normally overridden by the channel setting for the track. To make a MIDI event play back on its own channel, set its track to the **Any** channel in the **Project** window.

Comment

Use this for **Text**, **Lyrics**, **SMF Event** or **SysEx** that require a text entry or a hexadecimal entry.

Event Display

The **Event Display** displays events graphically.

- The event display is always shown.

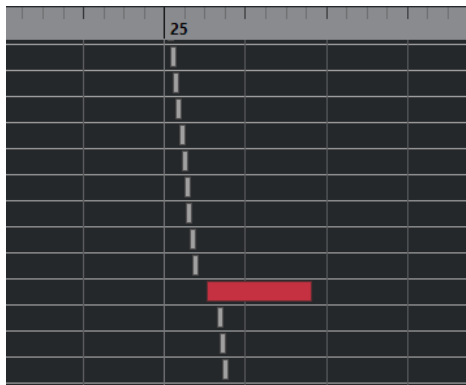

The vertical position of an event in the display corresponds to its entry in the list, that is, to the playback order. The horizontal position corresponds to the actual event position in the project. In the event display, you can add new parts or events, and drag events to another position.

Value Display

The value display to the right of the event display is a tool for quick viewing and editing of multiple values, for example, velocities or controller amounts. The values are shown as horizontal bars, with the bar length corresponding to the value.

- To show the value display, click **Set up Window Layout** on the toolbar, and activate **Value Display**.



The value that is displayed for an event depends on the event type. The following table shows what is displayed and edited in the **Data** columns and the value display:

Event type	Data 1	Data 2	Value display
Note	Pitch (note number)	Note-on velocity	Velocity
Controller	Controller type	Controller amount	Controller amount
Program change	Program number	Not used	Program number
Aftertouch	Aftertouch amount	Not used	Aftertouch amount
Pitchbend	Bend amount	Not used	Bend amount

Event type	Data 1	Data 2	Value display
SysEx	Not used	Not used	Not used

NOTE

For note events, there is also a value in the **Data 3** column, which is used for note-off velocity.

NOTE

For SMF and text events, no values are displayed.

List Editor Operations

This section describes the principal editing operations within the **List Editor**.

Drawing Events

The **Draw** tool allows you to insert single events in the event display.

When you move the cursor inside the event display, its position is indicated on the status line. The **Snap** function is taken into account.

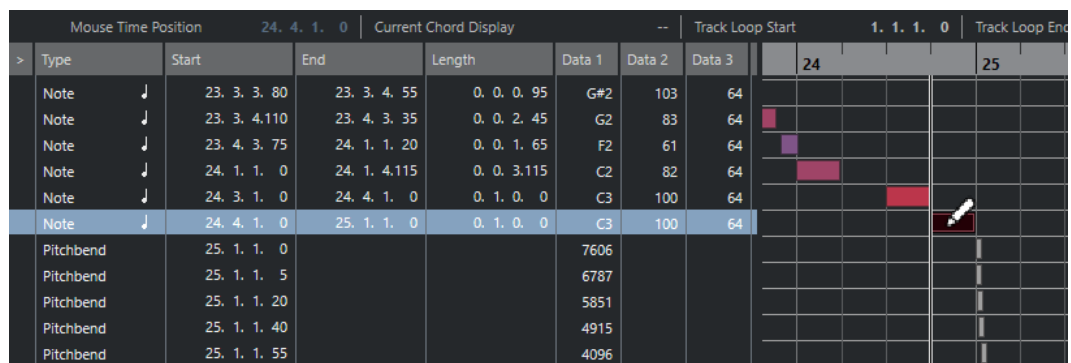

- To change the event type that you want to draw, select it from the **Insert Event Type** pop-up menu.

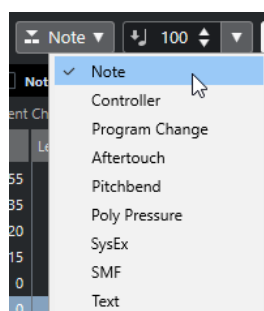

- To draw an event, click in the event display.
The note event gets the length that is set on the **Length Quantize** pop-up menu. Notes get the insert velocity value set in the **Note Insert Velocity** field on the toolbar.
- To draw longer note events, click and drag in the event display.
The length of the event is a multiple of the **Length Quantize** value. If **Length Quantize** is set to **Quantize Link**, the event value is determined by the quantize grid.

Filtering the Event List

You can filter the event list with the **Filters** bar that is displayed below the toolbar in the **List Editor**.

- To filter the event list based on complex criteria, open the **Show** pop-up menu and select a filter.
- To hide an event type, activate the corresponding checkbox on the **Filters** bar.
- To hide all event types except one, press **Ctrl/Cmd** and click the checkbox of the event type that you want to view.

If you **Ctrl/Cmd**-click again, all checkboxes are cleared.

Editing in the Event List

- To edit the values of several events, select the events and edit the value for one event. The values of the other selected events are also changed. Any initial value differences between the events are maintained.
- To set the values of all selected events to the same value, press **Ctrl/Cmd** and edit the value for one event.
- For SysEx events, you can only edit the **Start** position in the list. However, when you click the **Comment** column, the **MIDI SysEx Editor** opens, in which you can perform detailed editing of system exclusive events.

NOTE

When you trim the beginning of a note in the **List Editor**, the note may move to a different position in the list, since other events may begin earlier than the edited event.

RELATED LINKS

[SysEx Messages](#) on page 1009

Editing in the Event Display

The event display allows you to edit the events graphically using the tools on the toolbar. You can edit single events as well as several selected events simultaneously.

- To move an event, drag it to a new position.
Moving the event past any other event in the display resorts the list. The list always shows the events in the order in which they are played back. As a result, the vertical position of the event in the display also changes.
- To make a copy of an event, press **Alt/Opt** and drag it to a new position.
- To resize a note, select it and drag its end point with the **Object Selection** tool.
- To mute or unmute an event, click on it with the **Mute** tool.
You can mute or unmute several events simultaneously by enclosing them in a selection rectangle with the **Mute** tool.
- You can select a color scheme for the events with the **Event Colors** pop-up menu on the toolbar.
- To delete an event, select it and press **Backspace** or **Delete**, or click on it with the **Erase** tool.

RELATED LINKS

[Event Colors Menu](#) on page 914

Editing in the Value Display

- To edit values in the value display, click and drag.
The mouse pointer automatically takes on the shape of the **Draw** tool when you move it over the value display.

SysEx Messages

SysEx (System Exclusive) messages are model-specific messages for setting various parameters of a MIDI device. This makes it possible to address device parameters that would not be available via normal MIDI syntax.

Every major MIDI manufacturer has its own SysEx identity code. SysEx messages are typically used for transmitting patch data, for example, the numbers that make up the settings of one or more sounds in a MIDI instrument.

Nuendo allows you to record and manipulate SysEx data in various ways.

RELATED LINKS

[Using MIDI Devices](#) on page 891

Bulk Dumps

In any programmable device, the settings are saved as numbers in computer memory. If you change these numbers, you will change the settings. Normally, MIDI devices allow you to dump (transmit) all or some settings in the device's memory in the form of MIDI SysEx messages.

A dump is therefore, among other things, a way of making backup copies of the settings of your instrument: sending such a dump back to the MIDI device restores the settings.

If your instrument allows the dumping of a few or all of its settings via MIDI by activating some function on the front panel, this dump will probably be recordable in Nuendo.

Recording a Bulk Dump

IMPORTANT

If your MIDI instrument does not offer a way to initiate a dump, you have to send a Dump Request message from Nuendo to start the dump. In that case, use the **MIDI SysEx Editor** to insert the specific Dump Request message (refer to the instrument's documentation) at the beginning of a MIDI track. When you activate recording, the Dump Request message is played back (sent to the instrument), the dump starts and is recorded.

PROCEDURE

1. In the **Preferences** dialog, select **MIDI > MIDI Filter**.
 2. In the **Record** section, deactivate the **SysEx** checkbox to make sure that the recording of SysEx data is not filtered.
This way, SysEx messages are recorded but not echoed back to the instrument. This can lead to unpredictable results.
 3. Activate recording on a MIDI track and initiate the dump from the front panel of the instrument.
 4. When you have finished recording, select the new part and select **MIDI > List Editor**.
This allows you to check that the SysEx dump was recorded. There should be one or several SysEx events in the part/event list.
-

Transmitting a Bulk Dump Back to a Device

PREREQUISITE

Route the MIDI track with the System Exclusive data to the device. Check your device's documentation to find details about which MIDI channel should be used, etc.

PROCEDURE

1. Solo the track.
 2. Make sure that the device is set up to receive SysEx messages.
 3. If necessary, put the device in **Standby to Receive System Exclusive** mode.
 4. Play back the data.
-

Recording and Transmitting Bulk Dumps

- Do not transmit more data than you need. If all you want is a single program, do not send all. Otherwise, it could get too difficult to find the recognized program. Usually, you can specify exactly which data you want to send.
- If you want the sequencer to dump the pertinent sounds to your instrument whenever you load a project, put the SysEx data in a silent count-in before the project itself starts.
- If the dump is very short, for example, a single sound, you can put the dump in the middle of the project to quickly re-program a device. However, you can achieve the same effect by using Program Change. This is preferable, since less MIDI data is sent and recorded. Some devices may be set up to dump the settings for a sound as soon as you select it on the front panel.
- If you create parts with useful SysEx dumps, you can put these on a special muted track. To make use of these parts, drag them to an empty unmuted track and play them back.
- Do not transmit several SysEx dumps to several instruments at the same time.
- Make a note of the current device ID setting of the instrument. If you change this, the instrument may later refuse to load the dump.

Recording SysEx Parameter Changes

Often, you can use SysEx to remotely change individual settings in a device, for example, opening a filter, selecting a waveform, changing the decay of the reverb, etc. Many devices are also capable of transmitting changes that are made on the front panel as SysEx messages. These can be recorded in Nuendo, and thus incorporated into a regular MIDI recording.

For example, you open up a filter while playing some notes. In that case, you record both the notes and the SysEx messages that are generated when you open the filter. When you play back the recording, the sound changes exactly as it did when you recorded it.

PROCEDURE

1. In the **Preferences** dialog, select **MIDI > MIDI Filter** and make sure that **SysEx** is deactivated in the **Record** section.
 2. Make sure that the instrument is set to transmit changes of front panel controls as SysEx messages.
 3. Record.
-

AFTER COMPLETING THIS TASK

In the **List Editor**, check if the events were recorded properly.

MIDI SysEx Editor

- To open the **MIDI SysEx Editor** for a SysEx event, click in the **Comments** column for the event in the **List Editor** or the **Project Browser**.

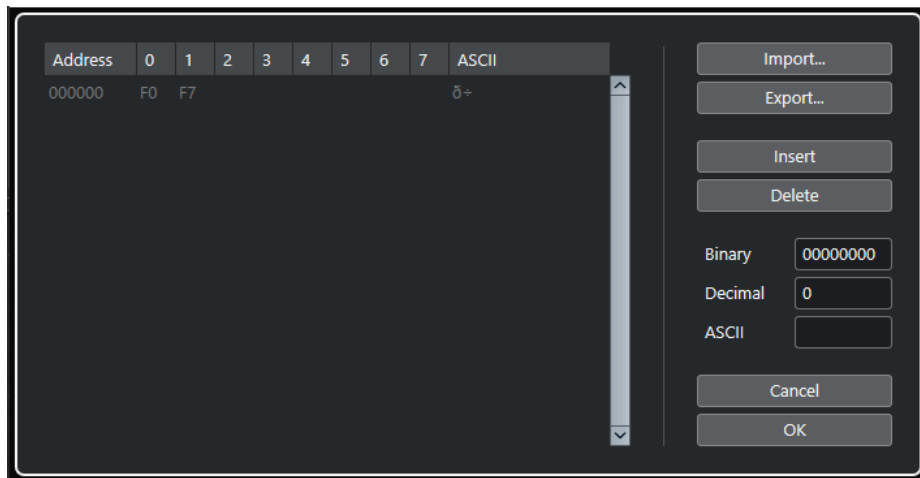

In the **MIDI SysEx Editor**, the bytes are displayed as follows:

Address

Shows at what position in the message a value is located.

0-7

Shows the entire message in hexadecimal format.

SysEx messages always begin with F0 and end with F7 and a number of arbitrary bytes in between. If the message contains more bytes, so that they do not entirely fit on one line, it continues on the next line. You can edit all values except for the first (F0) and the last ones (F7).

ASCII

Shows the selected value in ASCII format.

Adding and Deleting Bytes

- To add a byte, open the **MIDI SysEx Editor** and click **Insert**. The byte is added before the selected byte.
- To delete a byte, open the **MIDI SysEx Editor**, select a byte, and click **Delete**.
- To delete the complete SysEx message, select it in the List Editor and press **Delete** or **Backspace**.

Editing Byte Values

You can edit the selected byte value in the main display of the **MIDI SysEx Editor**, or in the ASCII, decimal, and binary displays.

- To edit the selected value, open the **MIDI SysEx Editor**, click on a byte, and type in the value.

Importing and Exporting SysEx Data

You can import SysEx data from disk and export the edited data to a file.

The file has to be in MIDI SysEx (.syx) binary format. Only the first dump in a SYX file will be loaded.

- To import SysEx data, open the **MIDI SysEx Editor** and click **Import**.

- To export SysEx data, open the **MIDI SysEx Editor** and click **Export**.

NOTE

Do not confuse this format with MIDI files, which have the extension .mid.

In-Place Editor

The **In-Place Editor** allows you to edit MIDI notes and controllers directly in the **Project** window, for quick and efficient editing in context with other tracks.

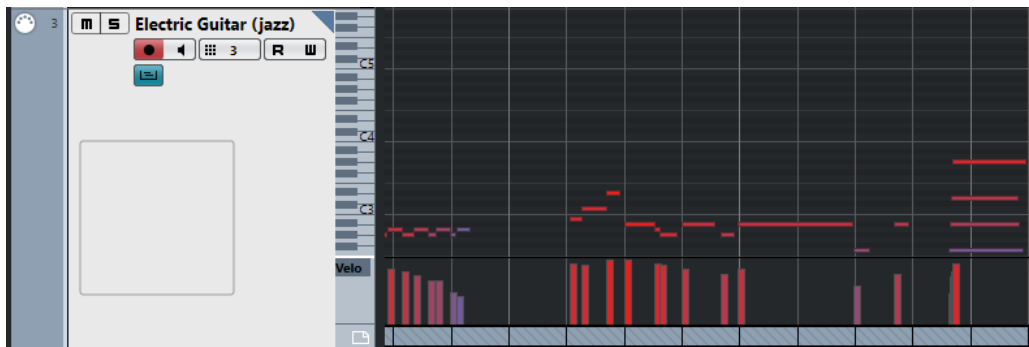

The **In-Place Editor** expands the MIDI track to show a miniature **Key Editor**. When you select a MIDI note, the **Project** window info line shows the same information about the note as the info line in the **Key Editor**. You can perform the same editing here as in the **Key Editor**.

RELATED LINKS

[Editing Note Events on the Info Line](#) on page 919

Opening the In-Place Editor

- To open the **In-Place Editor** for the selected tracks, select **MIDI > Open In-Place Editor**.
- To open the **In-Place Editor** for a single MIDI track, click **Edit In-Place** in the track list.

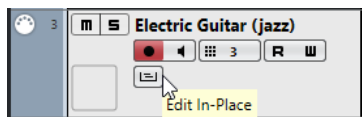

In-Place Editor Toolbar

The toolbar contains tools and settings for the **In-Place Editor**.

- To open the toolbar, click on the triangle in the upper right corner of the track list for the edited track.

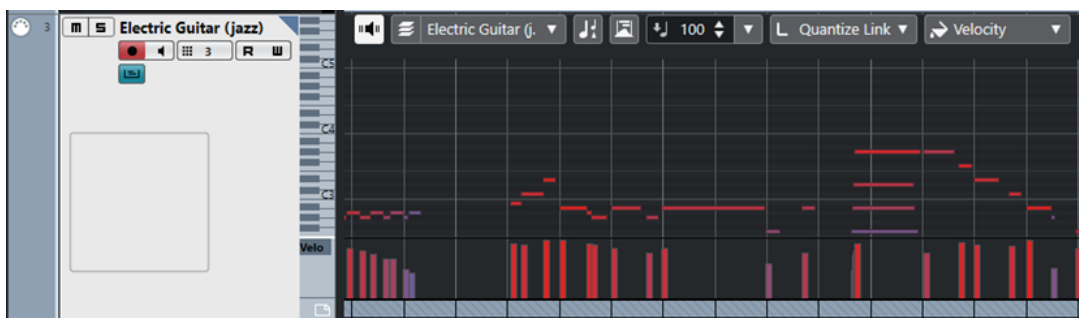

Acoustic Feedback

Acoustic Feedback



Automatically plays back events when you move or transpose them, or when you create them by drawing.

Multiple Part Controls

Edit Active Part Only



Restricts editing operations to the active part.

List of Parts in Editor

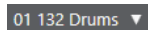

Lists all parts that were selected when you opened the editor, and allows you to activate a part.

Indicate Transpositions

Indicate Transpositions



Allows you to display the transposed pitches of MIDI notes.

Auto Select Controllers

Auto Select Controllers



Automatically selects controller data of the selected MIDI notes.

Insert Velocity

Note Insert Velocity



Allows you to specify a velocity value for new notes.

Length Quantize

Length Quantize

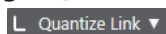

Allows you to set a value for quantizing event lengths.

Event Colors

Event Colors

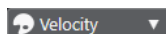

Allows you to select event colors.

Working with the In-Place Editor

- To zoom or scroll the **In-Place Editor**, point at the left part of the piano keyboard display so that the pointer changes to a hand. Then drag to the right or left to zoom in or out vertically, and drag up or down to scroll the editor.

- To add or remove controller lanes, right-click below the controller name field and select an option from the context menu.
- To close the **In-Place Editor** for one track, click **Edit In-Place** in the track list or double-click below the controller display in the **In-Place Editor**.
- To open/close the **In-Place Editor** for one or several selected tracks, use the **Edit In-Place** key command.
- You can drag notes from one **In-Place Editor** to another.

NOTE

The **Snap** button and **Snap Type** pop-up menu on the **Project** window toolbar control snapping in the **In-Place Editor**, but the snap grid is set using the **Quantize** pop-up menu.

Expression Maps

Expression maps allow you to set up a map for all your articulations. This allows you to audition a project including articulations.

You can select expression maps in the **Inspector** for MIDI or instrument tracks, and specify the sound mapping and characteristics for all your articulations.

If you select an expression map for a MIDI or instrument track, the articulations defined in the map are automatically applied during playback. Nuendo recognizes the expressions scored for the MIDI part and searches the sound slots in the expression map for a sound that matches the defined criteria.

When a matching sound slot is found, the current note is either modified, or the MIDI channel, program change, or key switch information is sent to the instrument selected on the **Output Routing** pop-up menu for the track, so that a different sound is played. When no sound slot is found that matches the articulations used in the part, the closest match is used.

When you enter articulations in a MIDI part, you must set up an expression map in a way that the right sounds in the connected VST or MIDI instrument are triggered.

Expression maps also allow you to link your articulations with remote keys on a MIDI input device and map these to sounds that can be played by a MIDI device or VST instrument. This way, you can enter notes and articulations using a remote MIDI device and have these automatically recorded and played back correctly by Nuendo.

Expression maps are useful in the following situations:

- When you want to enter musical articulations directly in the **Key Editor**, **Drum Editor**, **Score Editor**, or **In-Place Editor**, without having to record MIDI data first.
- When you want to play/record music in real time and control articulation changes while playing.
- When you open and edit projects from other users. By using expression maps, you can map the articulation information to a different instrument set or content library quickly and easily.

Expression maps are available for MIDI and instrument tracks. You can create your own expression maps or download expression maps for orchestra libraries and virtual instruments from steinberg.net.

NOTE

You can also use the **Note Expression** functions to add musical articulations directly on your MIDI notes in the **Key Editor**.

RELATED LINKS

[Articulations](#) on page 1016

[Creating and Editing Expression Maps](#) on page 1018

[Groups](#) on page 1020

[Note Expression](#) on page 1027

Articulations

Musical articulations define how specific notes are sung or performed on a given instrument. They can also define the relative volume of notes or the changes in pitch.

The following articulation types are available:

- **Directions**
Directions, such as pizzicato, are valid for all notes from their insert position, to the insert position of the next direction. They are applied to a continuous range of notes, or even an entire piece of music.
- **Attributes**
Attributes, such as accents, or staccato, are valid for single notes.

Expression Map Setup Window

The **Expression Map Setup** window allows you to load, create, and set up expression maps.

To open the **Expression Map Setup** window, do one of the following:

- Select **MIDI > Expression Map Setup**.
- In the **Inspector** for a MIDI or instrument track, open the **Expression Map** section, and click **Expression Map Setup**.

NOTE

You can also open the **Expression Map** section in the **Inspector** of the **Key Editor**, **Drum Editor** or **Score Editor**.

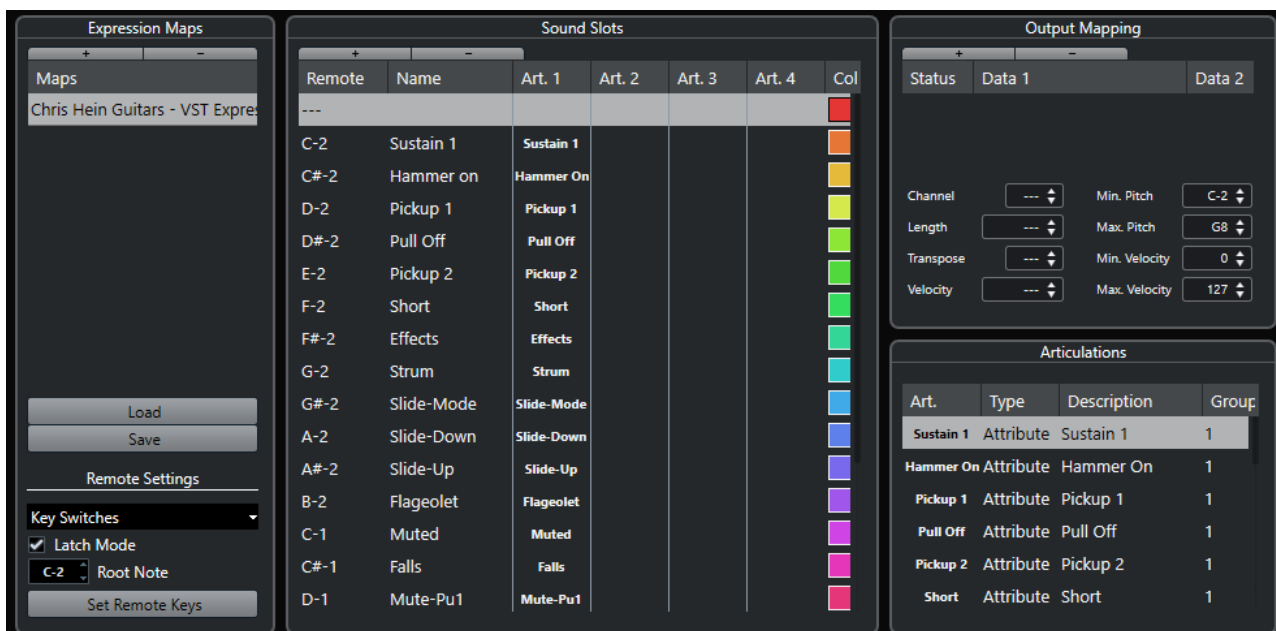

The following sections are available:

Expression Maps

Allows you to load, save, add, and remove expression maps. Loaded or added expression maps are shown in the **Expression Maps** list.

Sound Slots

Shows the sound slots that correspond to the expression map that is selected in the **Expression Maps** section.

Output Mapping

Shows the output mapping that corresponds to the sound slot that is selected in the **Sound Slots** section.

Articulations

Allows you to organize articulations in groups.

Remote Settings

Allows you to set up remote keys for triggering articulations via a MIDI input device. Here, you can also specify if you want to use key switches or program change messages to play a certain sound slot.

RELATED LINKS

[Expression Maps](#) on page 1015

[Adding Sound Slots](#) on page 1018

[Output Mapping Section](#) on page 1020

[Articulations](#) on page 1016

[Remote Settings Section](#) on page 1021

Expression Maps in the Project Window

Expression maps are available in the **Project** window, from within the **Inspector** for MIDI and instrument tracks.

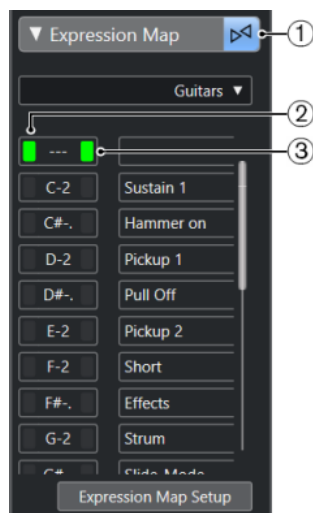

- 1 Indicates that an expression map is used for the track.
- 2 Shows which remote key is being pressed.
- 3 Marks the slot that is played back. This allows you to see whether the correct sound slot is used when you record articulations with an external device, such as a MIDI keyboard.

Creating and Editing Expression Maps

Creating Expression Maps

You can create expression maps from scratch.

PROCEDURE

1. In the **Inspector** for a MIDI or instrument track, open the **Expression Map** section.
2. Click **Expression Map Setup**.

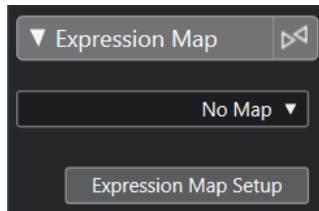

The **Expression Map Setup** opens.

3. In the **Expression Maps** section, click **Add Map** to create a new map.

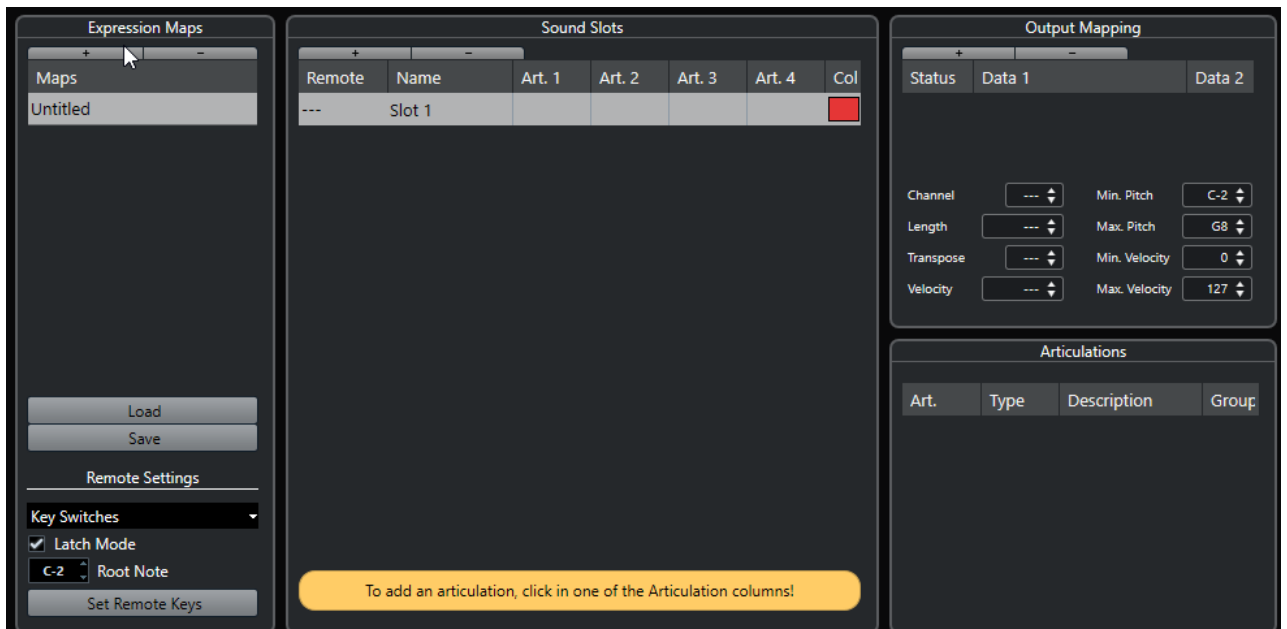

4. Optional: Click the name to enter a custom name for the expression map.

Adding Sound Slots

You must create sound slots for each articulation that you want to add.

PREREQUISITE

The **Expression Map Setup** window is open and an expression map is selected in the **Expression Maps** section.

PROCEDURE

1. Do one of the following:
 - In the **Sound Slots** section, use the first default sound slot that is added automatically when a new map is created.

- Click **Add Sound Slot** to add a new sound slot.
2. Click the articulation column **Art. 1** for the sound slot, and select an articulation from the menu.

NOTE

If a specific articulation is not available on the pop-up menu, select **Add Custom Articulation** to define your own articulations. This adds a default articulation that you can define in the **Articulations** section.

3. Optional: Click the **Name** column and enter a name for the sound slot.
The names of the sound slots are displayed in the **Inspector** for the track.
 4. Optional: Click the articulation columns **Art. 2**, **Art. 3**, or **Art. 4** for the sound slot, and select an articulation from the menu.
This allows you to create a complex articulation, made of several different single articulations for the sound slot. For each new articulation, an additional entry is added in the **Articulations** section.
 5. Click the **Remote** column for the sound slot and specify the key on your external device that triggers this sound slot.
 6. Optional: Click the **Col** column to assign a color to the sound slot.
When working in the MIDI editors, you can color your events according to the color of the sound slots.
-

RESULT

The sound slots are added and the articulations are available. You can create as many sound slots as you need.

If Nuendo finds the sound slot, the current note is either modified, for example, reduced in length or played louder, or the MIDI channel, program change, or key switch information is sent to the connected instrument (the instrument selected on the **Output Routing** pop-up menu for the track), so that a different sound is played.

If no sound slot is found that matches the articulations used in the part, the closest match is used.

RELATED LINKS

[Expression Maps in the Project Window](#) on page 1017

[Remote Settings Section](#) on page 1021

Articulations Section

You can edit the articulations that you added for the sound slots in the **Articulations** section of the **Expression Map Setup** window.

The following settings are available:

Art.

Click this column to choose whether you want to insert the articulation as a symbol or a text string. If you select **Symbol**, a dialog with the available symbols opens. If you select **Text**, you can directly enter your text.

Type

Click this column to specify whether you want to add an attribute or a direction. If you select **Attribute**, only single notes are influenced by the articulation symbol. If you select **Direction**, the articulation symbol is valid from its insertion position until the next articulation start.

Description

Click this column to enter a text such as the name of the symbol or the long name of a direction.

Group

Click this column to sort articulations in groups and prioritize them.

RELATED LINKS

[Groups](#) on page 1020

Groups

Groups allow you to sort the articulations in order to prioritize and combine them.

The groups themselves are exclusive. Articulations that are in the same group cannot be used together. You can place articulations that cannot be combined, such as arco (bowed) and pizzicato (plucked) for violin in the same group.

Groups represent the musical importance, with group 1 having the highest priority. This is useful if an expression map does not find an exact match for your data and tries to identify the sound which matches most criteria. If two sounds are found which have the same articulation in group 1, the sound that also matches group 2 is preferred and so on.

Output Mapping Section

The **Output Mapping** section allows you to map sound slots to specific sound characters of an instrument. The available sounds depend on the instrument that is selected for the MIDI or instrument track.

NOTE

Some virtual instruments require multiple key switches or combinations of key switches and controllers to select a particular articulation. In this case, click **Add Slot** to add multiple output events to a single sound slot.

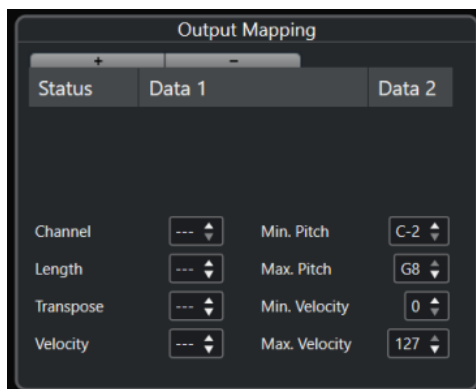

You can make the following settings for the slots:

Status

Allows you to specify a note-on, program change, or controller message for the selected sound slot.

Data 1/Data 2

Allows you to specify key switches for the selected sound slot. This allows you to switch between a bowed and a pizzicato violin, or to switch to another program containing a different articulation.

You can also create expressions by editing the incoming MIDI data:

Channel

Allows you to specify the MIDI channel for the selected sound slot. This allows you to switch to a different program.

Length

Allows you to specify the note length for the selected sound slot. This way, you can create staccato or tenuto sounds.

Transpose

Allows you to specify a transpose value for the selected sound slot. This way, you can select different articulations in some sample libraries, in which different articulations are located on different octaves.

Velocity

Allows you to specify the velocity for the selected sound slot. This way, you can create accents.

Min. Pitch/Max. Pitch

Allows you to specify a minimum and a maximum pitch for the selected sound slot.

Min. Velocity/Max. Velocity

Allows you to specify a minimum and a maximum velocity for the selected sound slot, to make sure that the sample mapped to a particular range is used. This way, you can use instruments that have different velocity ranges on the same key.

Remote Settings Section

The remote settings allow you to specify key switches or program change messages to trigger specific sound slots.

NOTE

If you do not plan to record or trigger articulations via a MIDI input device, you do not need to specify remote keys.

Active remote keys are indicated in the **Inspector** for the track.

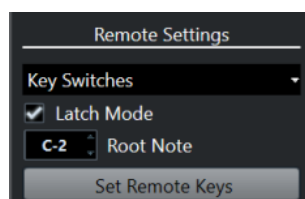

Key Switches/Program Change Messages pop-up menu

Allows you to select if you want to use **Key Switches** or **Program Change Messages** to switch sound slots.

NOTE

If you use key switches, these keys are used to insert articulations instead of notes.

Latch Mode

If this is activated, the key you press on your MIDI input device is valid until you press the next key. If this is deactivated, the key is valid for as long as you hold it. When you release it, the first sound slot is played.

IMPORTANT

Latch Mode can only be activated/deactivated globally, not for single expression maps.

Root Note

Allows you to specify the first key on your external device that you want to use as a remote key. This allows you to automatically adjust existing remote key assignments to suit your needs, for example, when you use a MIDI keyboard with a very wide or very narrow key range.

Set Remote Keys

Allows you to automatically assign a range of keys on your external device to the sound slots in the expression map.

RELATED LINKS

[Expression Maps in the Project Window](#) on page 1017

[Set Remote Keys Dialog](#) on page 1022

Set Remote Keys Dialog

The **Set Remote Keys** dialog allows you to assign a range of keys on your external device to the sound slots in the expression map.

- To open the **Set Remote Keys** dialog, click the **Set Remote Keys** button in the **Expression Map Setup** dialog.

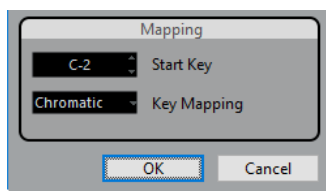

The following options are available:

Start Key

Allows you to specify the first key on the MIDI input device that you want to trigger a sound slot.

Key Mapping

Allows you to specify with which keys on your device you want to trigger the sound slots.

Extracting Expression Maps from VST Instruments

You can extract mapping information from VST 3 instruments and convert it into a new expression map. This way, you can set up expression maps for the instruments you often work with.

PROCEDURE

1. Load the VST instrument that you want to use and assign it to a MIDI or instrument track.
2. Load an instrument preset that contains key switches.
Included with Nuendo are several track presets that are pre-configured for use with expression maps. They contain sounds that make use of key switches and have different articulations. These presets have the suffix **VX**.
3. In the **Inspector** for the MIDI or instrument track, open the **Expression Map** section.
4. Click **Expression Map Setup**.

The **Expression Map Setup** opens.

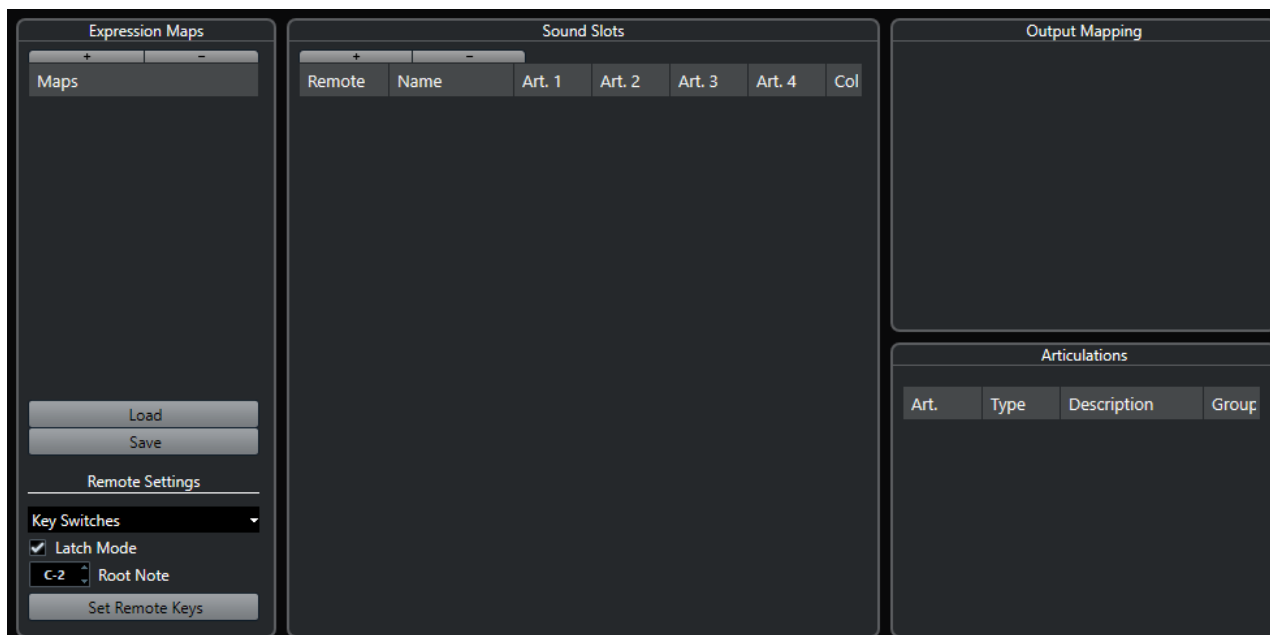

5. Make your changes, enter a name for the map, and click **Save**.
-

RESULT

The expression map is saved and you can select it in the **Expression Map** section of the **Key Editor**, **Drum Editor** or **Score Editor Inspector**.

RELATED LINKS

[Creating Expression Maps](#) on page 1018
[Track Presets](#) on page 201

Saving Expression Maps

If you have created and set up your expression map, you must save it.

PROCEDURE

1. In the **Expression Maps Setup** window, select the expression map in the **Expression Maps** section.
 2. Click **Save**.
 3. In the file dialog, specify a file name and a location for the expression map, and click **Save**.
-

RESULT

The expression map is saved.

Loading Expression Maps

PROCEDURE

1. In the **Inspector** for a MIDI or instrument track, open the **Expression Map** section.
2. Click **Expression Map Setup**.
The **Expression Map Setup** opens.
3. In the **Expression Maps** section on the left, click **Load**.

4. In the file dialog, locate and select the expression map that you want to load, and click **Open**. The expression map is now available in the **Expression Maps** section.
 5. Repeat the steps for all the maps that you want to make available, and close the dialog.
-

RESULT

All loaded maps are available on the **Expression Map** pop-up menu in the **Inspector** of the **Key Editor**, **Drum Editor** or **Score Editor**.

RELATED LINKS

[Creating and Editing Expression Maps](#) on page 1018

Inserting Articulations

Inserting Articulations on Controller Lanes

You can insert articulation symbols on the controller lane of the **Key Editor**, **Drum Editor**, and **In-Place Editor**.

PROCEDURE

1. Select the MIDI part.
 2. Open the **Key Editor**, **Drum Editor**, or **In-Place Editor**.
 3. In the controller display, open the **Controller Selection and Functions** pop-up menu and select **Articulations/Dynamics**.
All articulations that are specified for the selected expression map are shown on different rows on the controller lane. The different groups are separated by lines, and articulations that belong to the same group are shown in the same color.
 4. Select the **Draw** tool, and in the controller display, click at the exact position of the first note to which you want to apply this articulation.
The note beginnings are displayed as vertical lines on the controller display.
-

RESULT

The attribute in the controller lane is now automatically connected to the corresponding note.

NOTE

If you delete an attribute by selecting it and pressing **Delete** or **Backspace**, the note is deleted as well. If this is not what you want, deselect the articulation in the **Articulations** field on the info line instead.

IMPORTANT

When you insert articulation symbols, make sure that they do not conflict with other articulations.

RELATED LINKS

[Inserting Articulations via the Info Line](#) on page 1025

Inserting Articulations in the Score Editor

You can insert articulation symbols in the **Score Editor**.

PROCEDURE

1. Select the MIDI part.
2. Select **Scores > Open Score Editor**.
3. On the **Symbols** tab of the **Inspector**, open the **Expression Map** section.
4. Activate the articulation symbol, and click at the desired position in the note display.

IMPORTANT

When you insert articulation symbols, make sure that they do not conflict with other articulations.

RESULT

The articulation symbols inserted in the note display are shown in a different color so that you can distinguish them from other score symbols.

NOTE

You can view and change the colors in the **Preferences** dialog (**Scores-Colors for Additional Meanings** page).

To delete an articulation symbol, select it and press **Delete** or **Backspace**.

Inserting Articulations via the Info Line

You can insert articulation symbols via the info line of the **Key Editor**, **Drum Editor**, and **Score Editor**.

PROCEDURE

1. Select a MIDI note in the event display of the **Key Editor**, **Drum Editor**, or **Score Editor**.
2. On the info line, click **Articulations** to open a pop-up menu with all note attributes that are available in the expression map, and select the desired attribute.

RESULT

The name of the active attribute is now shown in the **Articulations** field.

NOTE

If you want to delete the attribute, deselect the articulation in the **Articulations** field on the info line.

IMPORTANT

When you insert articulation symbols, make sure that they do not conflict with other articulations.

RELATED LINKS

[Groups](#) on page 1020

Inserting Articulations in the List Editor

You can insert articulation symbols via the comment column of the **List Editor**. This only works if your MIDI part already contains some articulation symbols.

PROCEDURE

1. Select a MIDI note in the event display of the **List Editor**.
2. Click the **Comment** column to open a pop-up menu with all note attributes that are available in the expression map, and select the desired attribute.

RESULT

The name of the active attribute is now shown in the **Comment** column.

NOTE

If you want to delete the attribute, deselect the articulation in the **Comment** column.

IMPORTANT

When you insert articulation symbols, make sure that they do not conflict with other articulations.

Note Expression

Note expression allows you to edit MIDI notes and their expressions as one unit.

Note expression allows you to associate expression events with MIDI notes, so that they are treated as a unit. When you quantize, move, copy, duplicate, or delete MIDI notes, all their associated controller information follows. This allows for an intuitive and accurate editing of note-related data.

By expression events we understand the following events: MIDI control change, MIDI Pitchbend, MIDI Aftertouch, MIDI Poly Pressure, and VST Note Expression.

Expression event curves are shown as an overlay of the corresponding MIDI notes in the event display. All expression events for a MIDI note are shown simultaneously.

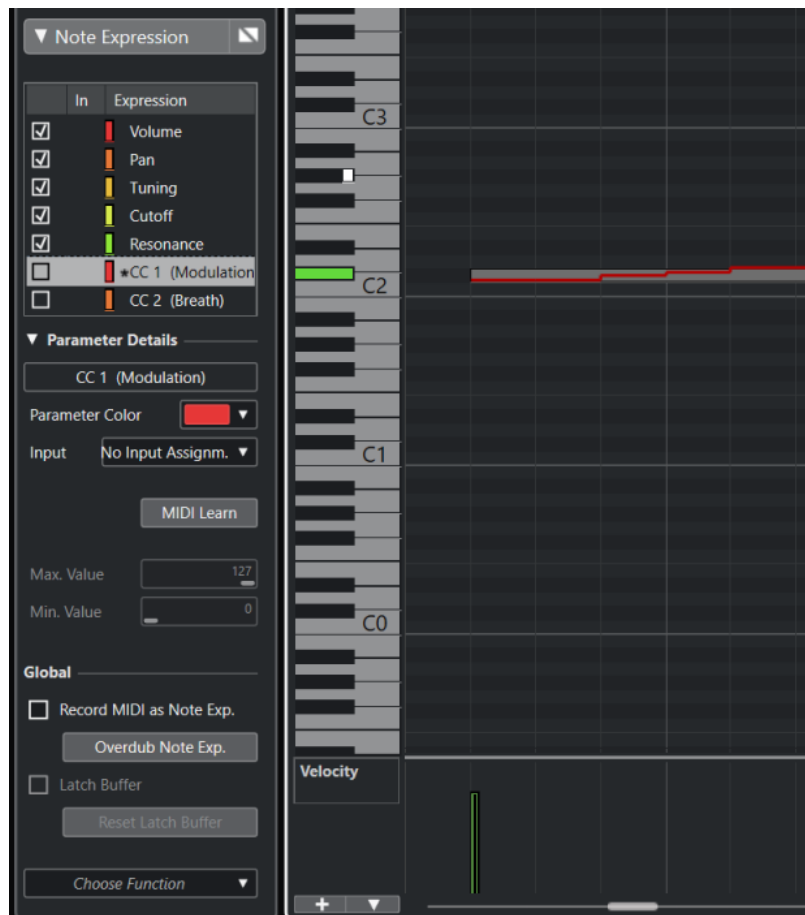

To be able to play and record expression events for MIDI notes, you must use an input controller device that supports note expression, such as MPE-compatible keyboards or MIDI guitars. If you do not have such an input controller, you can assign MIDI messages to expressions instead.

To be able to hear polyphonic performances that use expression events correctly, you must use an output controller device that supports note expression, such as MPE-compatible instruments or VST note expression-compatible VST instruments. If you do not have such a device, you must set up your MIDI instrument to play the same sound on all MIDI channels.

RELATED LINKS

[VST Note Expressions](#) on page 1028

[MIDI Controllers](#) on page 1029

[MIDI Input Devices that Support MPE](#) on page 1029

VST Note Expressions

VST note expressions are note-specific. They are suitable for polyphonic contexts, as they allow you to edit the expression of each individual note in a chord.

VST note expressions are provided by VST instruments. To be able to work with VST note expressions, you need a VST instrument that supports them, such as HALion Sonic SE.

Which VST note expressions are available depends on the instrument.

VST note expressions allow for a value range that exceeds the MIDI range of 0 to 127.

You can use all MIDI channels to separate different sounds.

NOTE

To use VST note expressions to control individual notes, you must set the MIDI channel of the track to a value between 1 and 16.

RELATED LINKS

[VST 3-Compatible VST Instruments](#) on page 1028

VST 3-Compatible VST Instruments

VST 3-compatible VST instruments that support VST note expression can be used with note expression in Nuendo.

Nuendo comes with a number of VST 3-compatible VST instruments such as HALion Sonic SE, Retrologue, or Padshop that include several presets.

Depending on the preset, Nuendo supports specific VST note expressions such as **Tuning**, **Volume** and **Pan**.

NOTE

Retrologue and Padshop come with some sounds especially made for use with MPE. For use with note expression, you can also use the preset sounds in HALion Sonic SE.

For detailed information about Retrologue and Padshop and their parameters, see the separate document **Plug-in Reference**.

For detailed information about HALion Sonic SE and its parameters, see the separate document **HALion Sonic SE**.

RELATED LINKS

[Loading MPE Instrument Presets](#) on page 1033

MIDI Controllers

MIDI controllers are channel-specific, with the exception of poly pressure messages. They affect the entire voice, regardless of whether they are inserted for a part or a note.

The fact that MIDI controllers are channel-specific limits the potential of note expression to monophonic (solo) performances. If you edit articulation data on one note, this affects all other notes of the same voice, that is, any other note playing on the same channel at the same time.

With the introduction of the MPE standard, however, you can assign each note to a different MIDI channel, and thereby control notes individually. The standard recommends to use exclusively the MIDI channel messages pitchbend, aftertouch, and CC74 to control individual notes. In this scenario, MIDI channel 1 controls all notes whereas the other 15 MIDI channels can control individual notes.

NOTE

To use MIDI controllers to control individual notes, you must set the MIDI channel of the track to **Any**.

RELATED LINKS

[MIDI Input Devices that Support MPE](#) on page 1029

[Controller Display](#) on page 921

[Recording MIDI Control Change Messages as Note Expression Data](#) on page 1049

[Converting MIDI Control Change Messages into Note Expression Data](#) on page 1050

MIDI Input Devices that Support MPE

MPE stands for MIDI Polyphonic Expression. Some MIDI devices support MPE. These are multi-dimensional MIDI controllers that allow you to vary the pitch and timbre of individual notes while playing polyphonically.

In MPE, each note is assigned its own MIDI channel. This allows you to apply expression messages to individual notes.

To be able to work with the MPE features in Nuendo, that is, polyphonically play and record expressions, you need an appropriate MPE input device. Some MPE input devices are detected and set up automatically.

Note Expression Input Device Page

The **Note Expression Input Device** page shows the settings for your connected input device.

- To open the page for your note expression input device, select **Studio > Studio Setup**, and select it in the **Devices** list. If your device is not listed, click **Add**, and select **Note Expression Input Device**.

NOTE

Nuendo automatically recognizes some supported note expression input devices and provides specific pages with preset settings in the **Studio Setup** dialog. If your device is set to the original factory settings, you do not have to change anything in this dialog. In some cases you might need to set the device to the appropriate mode. This mode is often referred to as MPE mode.

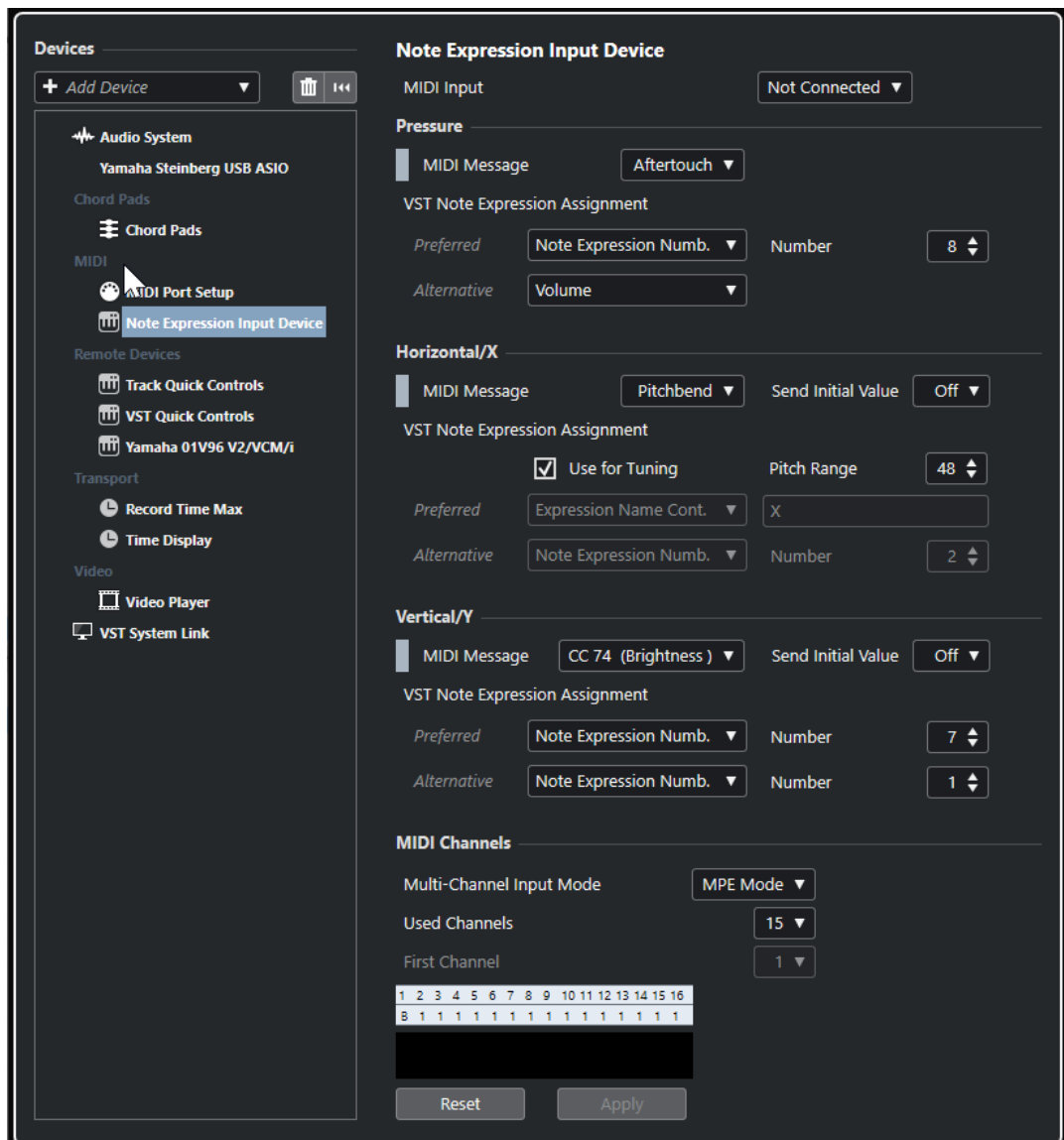

Nuendo allows you to capture three dimensions of input movements polyphonically. The **Note Expression Input Device** page provides the sections **Pressure**, **Horizontal/X**, and **Vertical/Y** that allow you to view, and if needed, edit which MIDI messages are used for these three dimensions of control.

The following options are available:

MIDI Input

Allows you to select the MIDI input port to which your input device is connected.

The following options are available in the **Pressure** section:

MIDI Message

Allows you to assign a MIDI message to the **Pressure** input movement on your note expression input device. The default assignment is **Aftertouch**.

VST Note Expression Assignment

Shows the assignment of MPE input movements to VST note expressions.

The following options are available in the **Horizontal/X** section:

MIDI Message

Allows you to assign a MIDI message to the **Horizontal/X** input movement on your note expression input device. The default assignment is **Pitchbend**.

Send Initial Value

Allows you to transmit the start position of the input movement to Nuendo.

- **Off**
Transmits the absolute position. This corresponds to the following initial values: Absolute: On (Sensel Morph), Relative: Off (LinnStrument).
- **Center (64)**
Transmits the center value first. Input movements cause the value to increase or decrease. This corresponds to the following initial values: Absolute: Off (Sensel Morph), Relative: On (LinnStrument).

Use for Tuning

Activate this for fretless note expression input devices that allow you to glide seamlessly from any pitch to any other pitch without interrupting the sound.

NOTE

If you activate **Use for Tuning**, the **VST Note Expression Assignment** is automatically set to **Tuning**.

Deactivate this for devices that do not support gliding, but that create new notes for every key instead.

Pitch Range

Allows you to specify the pitch range of your input device. If you glide from one pitch to another one, release the key, and press it again on the same position and pitch, the pitch range is set correctly.

Pressing a specific note several times always plays back the same pitch.

VST Note Expression Assignment

Shows the assignment of MPE input movements to VST note expressions.

The following options are available in the **Vertical/Y** section:

MIDI Message

Allows you to assign a MIDI message to the **Vertical/Y** input movement on your note expression input device. The default assignment is **CC74 (Brightness)**.

Send Initial Value

Allows you to transmit the start position of the input movement to Nuendo.

- **Off**
Transmits the absolute position. This corresponds to the following initial values: Absolute (Seaboard Block), Absolute: On (Sensel Morph), Relative: Off (LinnStrument).
- **Min (0)**
Transmits the minimum value first. Input movements cause the value to increase. This corresponds to the following initial values: Relative Unipolar (Seaboard Block).
- **Center (64)**
Transmits the center value first. Input movements cause the value to increase or decrease. This corresponds to the following initial values: Relative Bipolar (Seaboard Block), Absolute: Off (Sensel Morph), Relative: On (LinnStrument).
- **Max (127)**
Transmits the maximum value first. Input movements cause the value to decrease.

VST Note Expression Assignment

Shows the assignment of MPE input movements to VST note expressions.

The following options are available in the **MIDI Channels** section:

Multi-Channel Input Mode

Allows you to choose a multi-channel input mode. The following options are available:

- **MPE Mode**
Activates MPE mode, and sets channel 1 as base channel.
- **Channel Rotation**
Activates channel rotation, and assigns individual MIDI channels to incoming MIDI notes and their controller messages. This allows a 16-voice polyphony. For this to work, your input controller must support channel rotation.

Used Channels

Allows you to set up how many channels you want to use for notes.

First Channel

Only available in **Channel Rotation** mode. This allows you to set the first channel for the channel rotation.

MIDI Activity display

Allows you to monitor incoming MIDI messages.

RELATED LINKS

[VST Note Expression Assignments](#) on page 1032

VST Note Expression Assignments

The **VST Note Expression Assignments** section shows the assignment of input movements of your note expression input device to VST note expressions.

The assignments are predefined for all supported note expression input devices that have a specific page in the **Studio Setup** dialog. You can change these assignments manually.

NOTE

The assignment is renewed when you switch either the instrument, or one of its presets.

- To open the page for your note expression input device, select **Studio > Studio Setup** and select it in the **Devices** list. If your device is not listed, click **Add**, and select **Note Expression Input Device**.

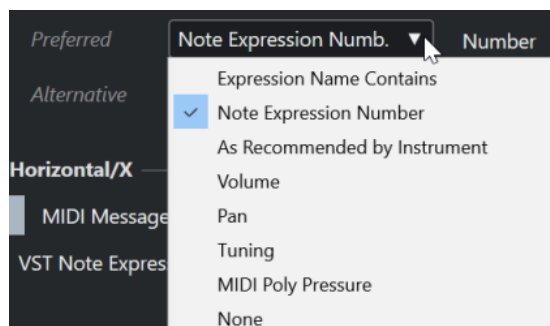

The following options are available as **Preferred** and **Alternative** assignments:

Expression Name Contains

Allows you to assign all note expressions to an input movement whose name contains the text that you specify in the field to the right.

Note Expression Number

Allows you to assign all note expressions to an input movement whose number corresponds to the one you specify in the field to the right.

As Recommended by Instrument

Automatically assigns all note expressions to input movements according to the recommendations of the instrument, if available.

Volume

Assigns the note expression **Volume** to an input movement.

Pan

Assigns the note expression **Pan** to an input movement.

Tuning

Assigns the note expression **Tuning** to an input movement.

MIDI PolyPressure

Assigns the note expression **MIDI PolyPressure** to an input movement.

None

Does not assign any note expression.

RELATED LINKS

[Note Expression Input Device Page](#) on page 1029

Loading MPE Instrument Presets

You can load preset MPE sounds for Retrologue and Padshop.

PROCEDURE

1. In the **Media** rack in the right zone, click the **VST Instruments** tile.
2. Do one of the following:
 - Click the **Padshop** tile, and click **MPE Padshop**.
 - Click the **Retrologue** tile, and click **MPE Retrologue**.

The MPE instrument presets are shown.

3. Do one of the following:
 - Drag an instrument preset to the track list to create a new instrument track with the loaded instrument preset.
 - Drag an instrument preset to the event display to create a new instrument track with the loaded instrument preset.
 - Drag an instrument preset to an instrument track to apply the preset to the track.
-

RESULT

The instrument is loaded, and the MPE preset is applied to the instrument track.

Note Expression Inspector Section

The **Note Expression Inspector** section features most of the functions that you need to work with note expression.

- To open the **Note Expression** section, select a MIDI or an instrument track, and click **Note Expression** in the **Inspector**.

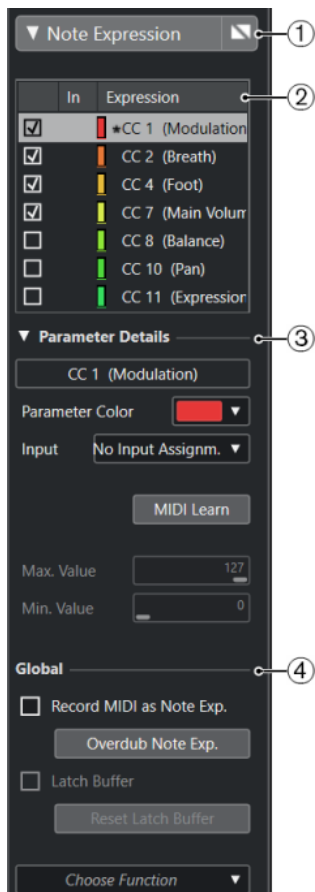

The following sections are available:

1 Section header/Bypass button

Shows the section name. The bypass button allows you to bypass all note expression data for the track.

2 Expression section

Lists the available VST note expressions, MIDI controllers, pitchbend, aftertouch and polypressure.

3 Parameter Details section

Allows you to make settings for the expression that is selected in the expression section.

4 Global section

Allows you to make global settings.

RELATED LINKS

[Expression Section](#) on page 1034

[Parameter Details Section](#) on page 1035

[Global Section](#) on page 1036

Expression Section

The expression section shows VST note expressions and MIDI controllers. Which VST note expressions are available depends on the instrument that is used. Which MIDI control change messages are available depends on the settings in the **MIDI Controller Setup** dialog.

The expression section is available in the **Note Expression** section of the **Inspector**.

- To open the **Note Expression** section, select a MIDI or an instrument track, and click **Note Expression** in the **Inspector**.

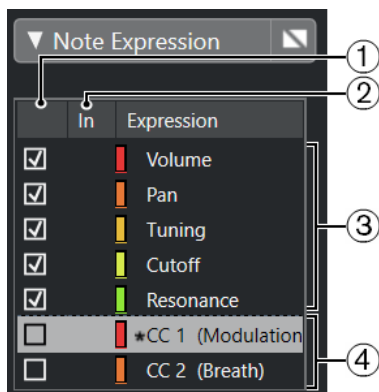

The following sections and functions are available:

1 Visibility

Shows/Hides the expression in the note expression event editor and in the event display.

2 In

Shows the abbreviation of the MIDI control change message or the input movement that is mapped to the expression for recording.

3 VST note expressions

Lists the available VST note expressions.

4 MIDI controllers

Lists the available MIDI controllers.

RELATED LINKS

[MIDI Controller Setup Dialog](#) on page 928

Parameter Details Section

In this section, you can make settings for the expression that is selected in the expression section, for example, set up the input assignment.

The parameter details are available in the **Note Expression** section of the **Inspector**.

- To open the **Note Expression** section, select a MIDI or an instrument track, and click **Note Expression** in the **Inspector**.

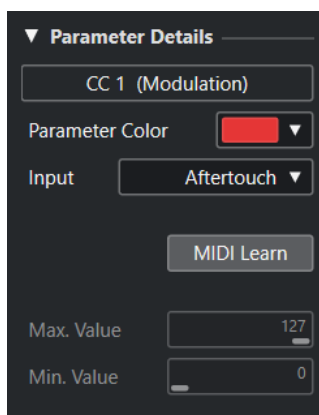

Parameter Color

Allows you to specify a color for the selected expression.

Input

Allows you to specify the input assignment for the selected expression.

MIDI Learn

Click this button and move the fader or knob on your external MIDI controller to assign the selected expression to it.

Max. Value/Min. Value

Allows you to specify a value range that is used for the selected expression.

Global Section

The settings in the **Global** section apply to all expressions in the expression section.

The **Global** section is available in the **Note Expression** section of the **Inspector**.

- To open the **Note Expression** section, select a MIDI or an instrument track, and click **Note Expression** in the **Inspector**.

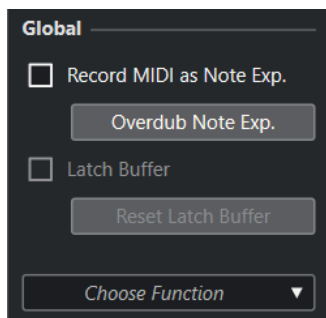

Record MIDI as Note Exp.

Activate this to record MIDI controller events as note expression data.

Overdub Note Exp.

Activate this to overdub existing note expression data.

Latch Buffer

Allows you to activate/deactivate the latch buffer that is used for overdub recording.

Show Additional Functions

Shows additional functions.

- **Show only used Expressions**
Shows only the expressions in the list for which data exists. These are marked with an asterisk (*) in front of the expression name.
- **Make all Expressions visible**
Shows all available expressions in the event display.
- **Make only edited Expression visible**
Shows only the selected expression in the event display.
- **Load Input Assignment**
Allows you to load mapping presets.
- **Save Input Assignment**
Allows you to save mapping presets.
- **MIDI Controller Setup**
Opens a dialog that allows you to add MIDI control change messages to the list.

RELATED LINKS

[Controller Mapping](#) on page 1037

Note Expression Tools

The note expression tools are available on the **Key Editor** toolbar.

Show Note Expression Data



This button is available in the **Show Note Expression Data** section of the **Key Editor** toolbar. It gives you a visual feedback of your actions. Use the slider to the right to adjust the display size of the note expression data in the event display.

Note Expression MIDI Input



This button is available in the **Step/MIDI Input** section of the **Key Editor** toolbar. It allows you to record note expression data via MIDI input.

Acoustic Feedback



This button is available in the **Acoustic Feedback** section of the **Key Editor** toolbar. It gives you an acoustic feedback of the controller events that are present at the mouse position while you enter or change note expression data.

Controller Mapping

Before you can record VST note expression events with external keyboards, you must map or assign specific MIDI controller messages, or pitchbend and aftertouch, or input movements to expressions.

You can map the controllers via the **Inspector**, via **MIDI Learn** or by using a mapping preset.

RELATED LINKS

[Mapping Controllers via the Inspector](#) on page 1037

[Mapping Controllers via MIDI Learn](#) on page 1038

[Using Mapping Presets](#) on page 1038

Mapping Controllers via the Inspector

You can use the **Inspector** to map the knobs and faders of your MIDI instrument to expressions.

PROCEDURE

1. In the expression section, select the expression that you want to map to a MIDI controller.
2. Open the **Input** pop-up menu and select the controller that you want to map to the selected note expression.

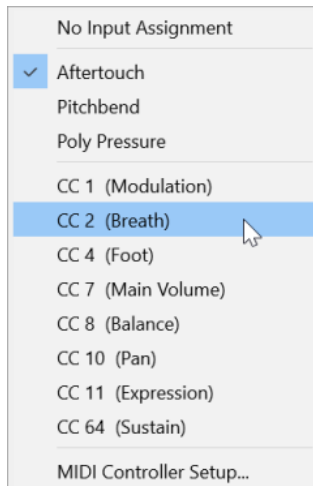

3. Optional: If the controller you are looking for is not on the list, select **MIDI Controller Setup**, and activate it in the dialog.
-

RESULT

You can now record note expression data using the controller messages that you just assigned. In the **In** column in the expression section, the number of the assigned MIDI controller message, or **PB** for pitchbend, or **AT** for aftertouch is shown if the mapping is active.

RELATED LINKS

- [Global Section](#) on page 1036
- [Expression Section](#) on page 1034

Mapping Controllers via MIDI Learn

The **MIDI Learn** function allows you to assign the knobs and faders of your MIDI device to controllers.

PROCEDURE

1. In the expression section, select the expression to which you want to assign a MIDI controller.
 2. In the **Parameter Details** section, click **MIDI Learn**.
 3. On your MIDI device, use the knob or fader that you want to assign to the selected expression.
 4. Optional: Repeat this for all the expressions that you want to control with your MIDI device.
-

RESULT

You can now record note expression data using the controls on your MIDI device that you just assigned.

Using Mapping Presets

You can save your expression mapping as a preset and load it later for use with the same MIDI device.

PROCEDURE

1. In the **Global** section, click **Show Additional Functions** to open the pop-up menu.
2. Select **Save Input Assignment**.

3. In the file dialog that opens, specify a name and a location for the file.
-

RESULT

A file with the extension ***.neinput** is created.

You can load the mapping presets you created by opening the pop-up menu and selecting **Load Input Assignment**.

RELATED LINKS

[Global Section](#) on page 1036

Recording

You can record note expression data together with MIDI notes, or you can record note expression data for existing notes.

RELATED LINKS

[Recording Notes and Note Expression Data](#) on page 1039

[Recording Note Expression Data by Overdubbing](#) on page 1041

[Recording Note Expression Data via MIDI Input](#) on page 1042

Recording and the Sustain Pedal

If you hold the sustain pedal (MIDI CC 64) of the connected MIDI device during recording, the following applies:

- When a note-off event is received (when the key on the connected keyboard is released), this message is not sent to the VST 3 instrument but is instead created by the program when the sustain pedal is released.
This makes it possible for the VST 3 instrument to play back control change messages that are sent after a key was released.
- The release phase of the recorded notes ends when the sustain pedal is released.

NOTE

This does not apply for continuous controller messages.

Recording Notes and Note Expression Data

You can use an external MIDI device to record MIDI notes together with note expression data.

PROCEDURE

1. In the global track controls area of the track list, click **Add Track** .
2. Click **Instrument**.
3. Open the **Instrument** pop-up menu and select **HALion Sonic SE**, for example.
4. Click **Add Track**.
The instrument track is added to the track list, and the control panel of the selected VST instrument is opened.
5. In the **Inspector** for the instrument track, open the **Note Expression** section.
6. In the expression section, select an expression.
7. In HALion Sonic SE, select a preset.

NOTE

In the **Presets** browser, enter **noteexp** in the search field of the **Results** section to show the presets that were created especially for use with note expression.

8. Map the expressions for recording.
 9. Use the mapped controls on your MIDI device to record MIDI notes together with note expression data.
-

RESULT

The notes are recorded together with the note expression data. If you activate **Show Note Expression Data** on the **Key Editor** toolbar, the note expression data is shown on the notes for which they were recorded.

RELATED LINKS

[Controller Mapping](#) on page 1037

[Loading MPE Instrument Presets](#) on page 1033

Recording Notes and Note Expression Data with MPE Input Devices

PREREQUISITE

Your MPE input device is connected to your computer, and correctly set up in Nuendo.

PROCEDURE

1. In the global track controls area of the track list, click **Add Track** .
2. Click **Instrument**.
3. Open the **Instrument** pop-up menu and select **HALion Sonic SE**, for example.
4. Click **Add Track**.
The instrument track is added to the track list, and the control panel of the selected VST instrument is opened.
5. In the top section of the **Inspector** for the instrument track, open the **Input Routing** pop-up menu, and select your MPE input device from the list.

NOTE

Make sure that the MIDI channel is not set to **Any**.

6. In the **Inspector**, open the **Note Expression** section.
The expressions should be correctly mapped to the input movements of your MPE device.
 7. Use your MPE input device to record MIDI notes together with note expression data.
-

RESULT

The notes are recorded together with the note expression data. If you activate **Show Note Expression Data** on the **Key Editor** toolbar, the note expression data is shown on the notes for which they were recorded.

RELATED LINKS

[MIDI Input Devices that Support MPE](#) on page 1029

[Loading MPE Instrument Presets](#) on page 1033

Recording Note Expression Data by Overdubbing

You can record or replace note expression data for existing notes by overdubbing.

PREREQUISITE

Deselect all notes in the event display before you start overdubbing. This ensures that you record control change messages for all notes touched by the position cursor.

PROCEDURE

1. In the **Inspector**, open the **Note Expression** section.
2. In the **Global** section, activate **Overdub Note Exp.**
3. Use the mapped controls on your MIDI device to record note expression data for the note that is playing.

RESULT

Only note expression data is recorded.

AFTER COMPLETING THIS TASK

Deactivate **Overdub Note Exp.** when you are done.

RELATED LINKS

[Global Section](#) on page 1036

Starting Overdub Recording at Specific Controller Values

When you record note expression data by overdubbing, you can activate a **Latch Buffer**. This is useful if you want to start recording at predefined initial knob or fader settings.

When Nuendo receives controller data from an external MIDI device, the setting of the faders and knobs on the device is automatically written to the **Latch Buffer**. This data is then added to the notes during playback.

PROCEDURE

1. Map each control to one of the available VST note expressions.
2. Activate **Latch Buffer** and set the knobs and faders on the MIDI controller to the corresponding values.
3. Activate **Overdub**.
4. Use the mapped controls on your MIDI device to record note expression data for the note that is playing.

RESULT

The values for all controls are attached to the notes that are passed during overdub recording, and replace any existing controller data of the same type.

AFTER COMPLETING THIS TASK

Remove all values from the **Latch Buffer** by clicking **Reset Latch Buffer**.

NOTE

When you record in a cycle, the **Latch Buffer** is automatically reset at the end of the cycle.

Recording Note Expression Data via MIDI Input

You can record note expression data for existing notes using the **Note Expression MIDI Input**.

PROCEDURE

1. On the **Key Editor** toolbar, in the **Step/MIDI Input** section, activate **MIDI Input** and **Note Expression MIDI Input**.



2. Select a note and move the active control on your MIDI device to replace the controller events for that note.

RESULT

The note is played in real time and incoming control change messages are recorded for it. Recording stops when the end of the note or the end of the release phase is reached, or when you deselect the note.

RELATED LINKS

[Adding Release Phases to Notes](#) on page 1047

Note Expression Event Editor

The note expression event editor offers various modes for editing and adding note expression events.

- To open the note expression event editor, activate **Double-click Opens Note Expression Editor** on the **Key Editor** toolbar, and double-click a note in the event display. If this button is not visible, right-click the toolbar and select **Show Note Expression Data** from the menu.

NOTE

- In the **Key Commands** dialog in the **Note Expression** category, you can also assign a key command for **Double-click Opens Note Expression Editor On/Off**. This way, you can quickly change the double-click function from deleting notes (**Double-Click opens Note Expression Editor** is deactivated) to opening the note expression event editor (**Double-click Opens Note Expression Editor** is activated).
 - If you select several notes in the **Key Editor**, and you double-click any of them, the note expression event editor opens for all these notes. In this case, any editing affects all the notes that are present at the time position where you perform the editing.
-
- To close the editor, click in the event display.

The note expression event editor features the following controls:

- **Note Expression controls**
These controls allow you to select parameters and add note expression events.
- **Smart controls**
These allow you to edit the note expression events.

Note Expression Controls

The note expression event editor features the following specific note expression controls:

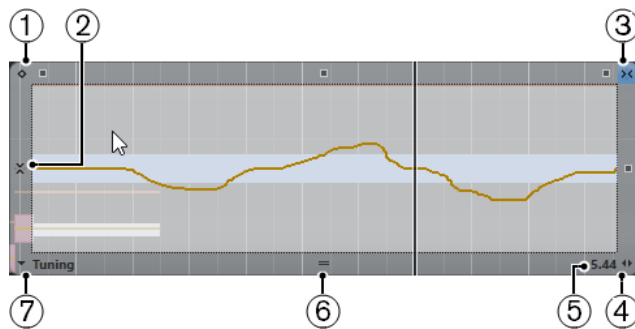

1 One-Shot Mode

If this is active and you click with the **Draw** tool anywhere in the editor, a fixed value is set.

NOTE

This mode is automatically activated for note expressions that are one-shot only.

2 Vertical Snap

Allows you to enter the pitch in semitone steps instead of as a continuous curve. This way, it is much easier to create fast pitch modulations. This is especially useful for the **Tuning** parameter.

NOTE

To temporarily switch to vertical snapping while editing, hold down **Shift**.

3 Horizontal Snap

This corresponds to the **Snap** button in the **Project** window.

4 Change Release Length

Allows you to add a release length to your note.

5 Parameter Range

Shows the current value at the cursor position. The value range differs depending on the parameter type.

6 Change Editor Size

Click this and drag up or down to change the size of the editor. This allows you to switch between 3 different window sizes.

7 Parameter Selection

Shows the selected parameter. Click this to open a pop-up menu with all the parameters that are used for the note. To make more parameters available, select them in the **Inspector**.

Smart Controls

The note expression event editor features the following smart controls for specific editing modes:

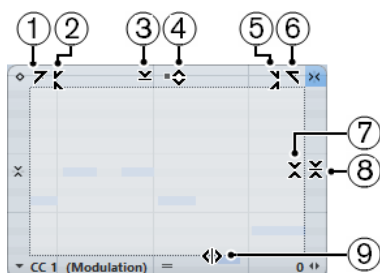

1 Tilt Left

If you click in the upper left corner of the editor, you can tilt the left part of the curve. This allows you to tilt the event values at the start of the curve upwards or downwards.

2 Compress Left

If you **Alt/Opt**-click in the upper left corner of the editor, you can compress or expand the left part of the curve. This allows you to compress or expand the event values at the start of the curve.

3 Scale Vertically

If you click in the middle of the upper border of the editor, you can scale the curve vertically. This allows you to raise or lower the event values of the curve in percent.

4 Move Vertically

If you click on the upper border of the editor, you can move the entire curve vertically. This allows you to raise or lower the values of the event values of the curve.

5 Compress Right

If you **Alt/Opt**-click in the upper right corner of the editor, you can compress or expand the right part of the curve. This allows you to compress or expand the event values at the end of the curve.

6 Tilt Right

If you click in the upper right corner of the editor, you can tilt the right part of the curve. This allows you to tilt the event values at the end of the curve upwards or downwards.

7 Scale Around Relative Center

If you **Alt/Opt**-click in the middle right border of the editor, you can scale the curve relative to its center. This allows you to raise or lower the event values horizontally around the center of the editor.

8 Scale Around Absolute Center

If you click in the middle right corner of the editor, you can scale the curve absolute to its center. This allows you to raise or lower the event values horizontally around the center of the editor.

9 Stretch

If you click on the lower border of the editor, you can stretch the curve horizontally. This allows you to move the event values of the curve to the left or to the right.

Navigation in the Note Expression Event Editor

You can navigate to the next/previous note while the note expression event editor is open.

- To navigate to the next/previous note, use the **Left Arrow** / **Right Arrow** keys.
- To step through the notes, press **Tab** and **Shift - Tab**.

Adding Note Expression Events

PROCEDURE

1. Double-click a note in the event display to open the note expression event editor.
 2. Do one of the following to select the parameter that you want to make settings for:
 - To create events for a parameter that has not been used yet, select the parameter in the **Inspector** to make it available in the editor.
 - To edit existing events, specify which parameter you want to edit by clicking on the curve, by selecting the corresponding parameter on the **Parameter Selection** pop-up menu, or by selecting the parameter in the **Inspector** in the **Note Expression** section.
 3. Select the **Draw** or the **Line** tool, and add note expression events for the selected note.
-

RELATED LINKS

[Adding Velocity Events](#) on page 930

Deleting Note Expression Events

PROCEDURE

1. On the **Key Editor** toolbar, activate **Double-Click opens Note Expression Editor**.
If this button is not visible, right-click the toolbar and select **Show Note Expression Data** from the menu.

NOTE

In the **Key Commands** dialog in the **Note Expression** category, you can also assign a key command for **Double-click Opens Note Expression Editor On/Off**. This way, you can quickly change the double-click function from deleting notes (**Double-click Opens Note Expression Editor** is deactivated) to opening the note expression event editor (**Double-click Opens Note Expression Editor** is activated).

2. Double-click the note that contains the note expression events you want to delete.
The note expression editor opens.
 3. Optional: Open the **Parameter Selection** pop-up menu, and select the corresponding note expression in the list.
 4. Drag a selection rectangle to select the range of note expression values that you want to delete.
 5. Select **Edit > Delete**.
-

RESULT

The selected note expression events are deleted from the note.

RELATED LINKS

[Adding Velocity Events](#) on page 930

Pasting Note Expression Events to Different Notes

You can copy all note expression events from one or more notes and paste them to one or more other notes.

PREREQUISITE

You have set up a key command for **Paste Note Expression** in the **Key Commands** dialog (**Note Expression** category).

PROCEDURE

1. Double-click the note that contains the note expression events.
The note expression editor opens.
 2. Select the note expression events that you want to copy.
 3. Select **Edit > Copy**.
 4. Select the note to which you want to paste the note expression events.
 5. Press the key command that you assigned to the **Paste Note Expression** command.
-

RESULT

All copied note expression events are pasted to the selected note.

If you copied note expression events from several source notes and pasted them to a number of destination notes, the following applies:

- If the number of the source and destination notes matches, the events of the first source note are pasted into the first destination note, the events of the second source note into the second destination note, etc.
- If the number of source notes is smaller than the number of destination notes, the source note events are pasted repeatedly into the destination notes in the order in which they appear.

When you copy the events from 2 source notes into 4 destination notes, for example, the first destination note gets the note expression events from the first source note, the second destination note the events of the second source note the third destination note, the events of the first source note, and the 4th destination note the events of the second source note.

RELATED LINKS

[Key Commands](#) on page 1313

Pasting Note Expression Events to Different Parameters

You can copy note expression events from one parameter and paste them to a different parameter.

PROCEDURE

1. Double-click the note that contains the note expression events to open the note expression event editor.
2. Select the note expression events of the parameter that you want to copy.
3. Select **Edit > Copy**.
4. Select the parameter to which you want to paste the note expression events.
5. Select **Edit > Paste**.

RESULT

All copied note expression events are pasted to the selected parameter.

Repeating Note Expression Events

PROCEDURE

1. Double-click the note that contains the note expression events to open the note expression event editor.
2. Open the **Parameter Selection** pop-up menu, and select the corresponding note expression from the list.
3. Drag a selection rectangle to select the events that you want to repeat.
4. Click the selection, and with the mouse button pressed, press **Alt** and drag.

RESULT

The selected events are copied.

Moving Note Expression Events

PROCEDURE

1. Double-click the note that contains the note expression events to open the note expression event editor.

2. Open the **Parameter Selection** pop-up menu, and select the corresponding note expression from the list.
3. Do one of the following:
 - Click the note expression event curve and drag to move all events.
 - Drag a selection rectangle to select events and drag to move the selected events.

NOTE

To restrict the direction to vertical or horizontal, you can press **Ctrl/Cmd** while dragging.

Adding Release Phases to Notes

You can add a release phase to a note. This allows you to work on the tail of a note which is still sounding after the note-off message was sent, for example.

PROCEDURE

1. Double-click a note in the event display to open the note expression event editor.
2. Click and drag the **Change Release Length** control in the lower right corner of the editor to add a release phase.

RESULT

The release phase is added to the note.

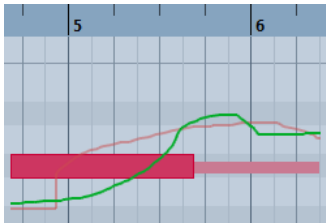

NOTE

You can change the release phase for several notes by opening the editor for these notes, and holding down **Alt** while setting the release length.

AFTER COMPLETING THIS TASK

Add controller events in the release phase by overdubbing or by manually entering note expression events in the editor. When you overdub note expression events, the length of the existing release phase is used to associate newly recorded events to the notes.

NOTE

If you hold the sustain pedal of your external device during recording, the notes automatically get a corresponding release phase.

Trimming Note Expression Data

You can trim note expression data to automatically match the note length.

PROCEDURE

1. Select the notes that contain note expression data.

2. Select **MIDI > Note Expression > Trim Note Expression to Note Length**.
-

RESULT

The note expression data is trimmed to the note length, and any data present after the end of the release phase is deleted.

Removing All Note Expression Data

You can delete all note expression data from the selected MIDI note or part.

PROCEDURE

1. Select the MIDI note or the MIDI part that contains the note expression data that you want to delete.
 2. Select **MIDI > Note Expression > Remove Note Expression**.
-

RESULT

The note expression data is removed.

Note Expression MIDI Setup Dialog

The **Note Expression MIDI Setup** dialog allows you to specify exactly which MIDI messages are used every time you record MIDI control change messages as note expression data or you convert them.

- To open the **Note Expression MIDI Setup** dialog, select **MIDI > Note Expression > Note Expression MIDI Setup**.

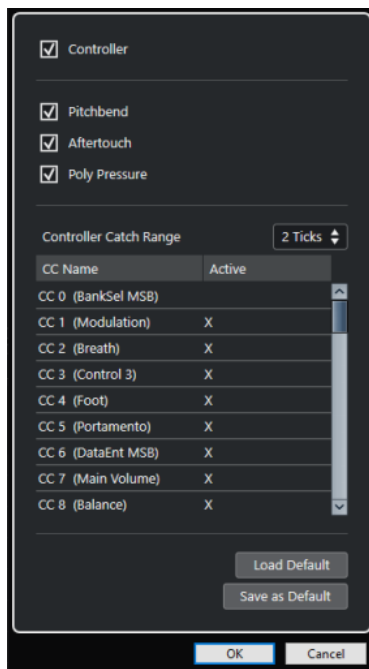

The following options are available:

Controller

Activates MIDI control change messages. Specify the MIDI control change messages that you want to use in the list below.

NOTE

MIDI controller data for deactivated MIDI control change messages will end up on the controller lane.

Pitchbend

Activates pitchbend data.

Aftertouch

Activates aftertouch data.

Poly Pressure

Activates poly pressure data.

Controller Catch Range

Allows you to enter a controller catch range in ticks. This is useful to associate control change messages with a note, even if they were sent slightly before the note-on message.

Load Default

Allows you to load the default settings.

Save as Default

Allows you to save the current settings as default settings.

Recording MIDI Control Change Messages as Note Expression Data

You can record MIDI control change messages as note expression data.

PROCEDURE

1. In the **Inspector**, open the **Note Expression** section and activate **MIDI as Note Expression**.
 2. Optional: Set the MIDI track to **Any** channel.
MIDI control change messages, with the exception of poly pressure, are channel-specific. By splitting polyphony to separate channels, you can avoid conflicting controller messages.
 3. Enter the notes and control change messages on your MIDI device.
-

RESULT

The controller data is now associated with the notes. If you copy, paste, and move the notes, the associated controller data will follow.

NOTE

If you want to edit the MIDI notes after recording, you might need to consolidate the controller data.

RELATED LINKS

[Consolidating Note Expression Overlaps](#) on page 1050

Converting MIDI Control Change Messages into Note Expression Data

You can convert the MIDI control change messages on controller lanes into note expression data.

PREREQUISITE

The MIDI control change messages that you want to record are activated in the **Note Expression MIDI Setup** dialog. You have a MIDI part with controller data written on controller lanes.

PROCEDURE

1. Open the **Key Editor** for the MIDI part.
 2. Select **MIDI > Note Expression > Convert to Note Expression**.
-

RESULT

The MIDI control messages contained in the controller lanes are converted to note expression data, and the data on the controller lanes is deleted.

Nuendo searches for notes that sound at the same time as the control change messages. If several notes play at the same time, the same note expressions are attributed to them, with the same values. Release phases are automatically created where necessary, so that no controller data is lost during this process.

IMPORTANT

If you want to edit the MIDI notes after the conversion, you might need to consolidate the controller data.

RELATED LINKS

- [Note Expression MIDI Setup Dialog](#) on page 1048
- [Adding Release Phases to Notes](#) on page 1047

Consolidating Note Expression Overlaps

If you move or quantize notes so that they overlap, and if these overlapping notes contain data for the same control change message, you might need to consolidate the note expression overlaps.

PROCEDURE

- Select **MIDI > Note Expression > Consolidate Note Expression Overlaps**.
-

RESULT

If the overlapping notes contain data for the same control change message, the controller values of the second note are used from the beginning of the overlap.

If a note is positioned entirely within a longer note and if these notes contain controller data for the same control change message, the controller values of the longer note are used until the encompassed note starts.

Distributing Notes to Different Channels

You can distribute notes to different channels. This allows you to use the note expression functions, even if you do not have a VST 3 instrument.

PREREQUISITE

You have added a multitimbral instrument and assigned the same sound to different channels.

PROCEDURE

1. In the **Inspector** for the corresponding MIDI track, open the **Channel** pop-up menu, and select **Any**.
 2. In the **Inspector**, open the **Note Expression** section.
 3. Enable **MIDI as Note Expression**.
 4. Record or enter MIDI notes with expressions as needed.
 5. Select **MIDI > Note Expression > Distribute Notes to MIDI Channels**.
-

RESULT

The MIDI notes are distributed to different channels, starting at channel 1. You can now edit note expression for each note independently without conflicts.

Converting Note Expression Data to MIDI Controller Data

You can convert note expression data of MIDI controller parameters to MIDI controller data on controller lanes.

PROCEDURE

- Select **MIDI > Note Expression > Dissolve Note Expression**.
-

RESULT

The note expression data is converted. If you open the controller display and show the controller lanes for the corresponding event type, the data is displayed.

NOTE

If you convert note expression data of VST note expressions to MIDI, the sound will change. Therefore, you must reassign the MIDI controller data to a new instrument destination.

Chord Functions

The chord functions provide you with many possibilities for working with chords.

The chord functions allow you to:

- Build chord progressions by adding chord events to the chord track.
- Convert chord events to MIDI.
- Use the chord track to control audio playback or MIDI playback.
- Use the chord track voicing to change the pitches of your MIDI.
- Extract chord events from MIDI data to get an overview of the harmonic structure of a MIDI file.
- Record chord events with a MIDI keyboard.

RELATED LINKS

[Chord Editing Section](#) on page 975

Chord Track

The chord track allows you to add chord events and scale events.

RELATED LINKS

[Scale Events](#) on page 1060

[Chord Events](#) on page 1053

[Musical Scale Setup Dialog](#) on page 1061

Adding the Chord Track

PROCEDURE

- Select **Project > Add Track > Chord**.

RESULT

The chord track is added to your project.

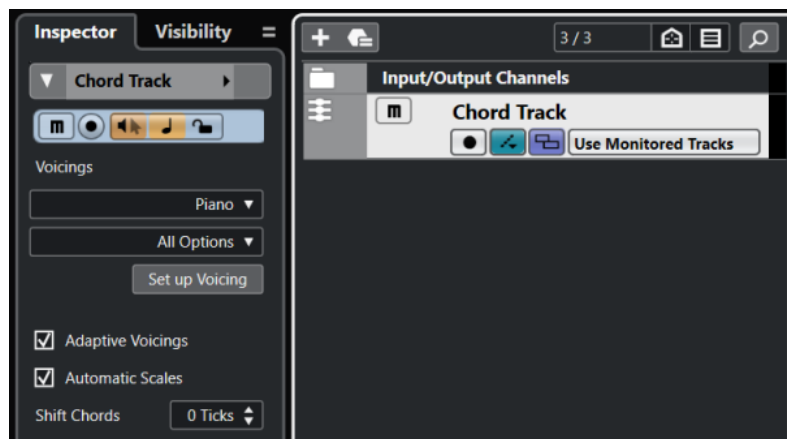

RELATED LINKS

[Chord Track](#) on page 159

Chord Events

Chord events are representations of chords that control or transpose playback on MIDI, instrument, and audio tracks.

Chord events alter the pitches of MIDI notes and VariAudio segments if their tracks are set up to follow the chord track.

Chord events have a specific start position. Their end, however, is determined by the start of the next chord event. They can have a root note, a type, a tension, and a bass note.

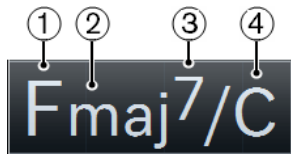

- 1 Root note
- 2 Type
- 3 Tension
- 4 Bass note

RELATED LINKS

[Controlling MIDI or Audio Playback Using the Chord Track](#) on page 1066

Chord Editor

The **Chord Editor** allows you to define or change chord events, and to add new chord events.

- To open the **Chord Editor**, double-click a chord event.

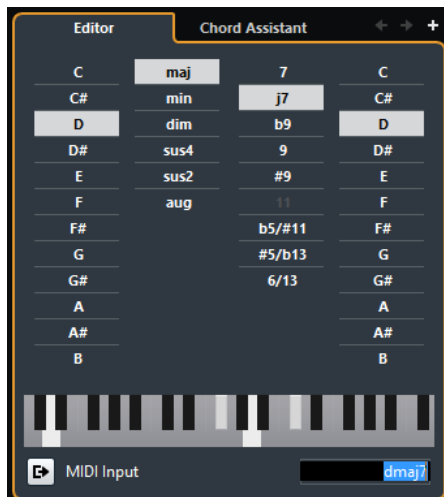

Go to Previous Chord/Go to Next Chord

Allow you to select the previous/next chord on the chord track for editing.

Add Chord

Adds a new undefined chord event on the chord track.

NOTE

This works only if the last chord event on the chord track is selected.

Chord definition buttons

Activate these buttons to define a root note, a chord type, a tension, and a bass note for your chord event.

NOTE

If you do not select a separate bass note, the setting is linked to the root note, so that no extra bass note is heard.

Keyboard display

Shows the notes of the chord event, considering the current voicing settings.

Activate MIDI Input

Allows you to define a chord by playing a chord on your MIDI keyboard. If the chord is recognized, it is reflected by the chord buttons and the keyboard display.

Define Chord by Text Input

Allows you to define a chord using the computer keyboard.

Adding Chord Events

PREREQUISITE

You have added a chord track.

PROCEDURE

1. Select the **Draw** tool and click in the chord track.
An undefined chord event named X is added.
 2. Select the **Object Selection** tool and double-click the chord event.
 3. In the **Editor**, select a root note.
 4. Optional: Select a chord type, tension, and bass note.
 5. Do one of the following:
 - To close the **Editor**, click anywhere outside the **Editor**.
 - To add a new undefined chord event, click **Add Chord**.
-

RELATED LINKS

[Adding the Chord Track](#) on page 1052

Defining Chords by Text Input

In the chord **Editor**, you can use the text input field to define a chord with the computer keyboard.

PROCEDURE

1. Double-click a chord event to open the chord **Editor**.
2. Click in the text input field at the bottom of the **Editor**.
3. Enter a chord by performing the following actions:
 - Define a root note, for example, C, D, E.

- Define accidentals, for example, # or b.
- Define the chord type, for example maj, min, dim, sus, or aug.
- Define a chord extension, for example, 7, 9, or 13.

NOTE

If you have activated **Solfège** in the **Note Name** pop-up menu in the **Preferences** dialog (**Event Display—Chords&Pitches** page), you can also enter chords in this format. You must capitalize the first letter and write “Re” instead of “re”, for example. Otherwise, the chord is not recognized.

4. Press **Tab** to add a new undefined chord and define it.
-

Chord Assistant

The **Chord Assistant** allows you to use a chord as a starting point to get suggestions for the next chord.

- To open the **Chord Assistant**, in the **Chord Editor**, click **Chord Assistant**.

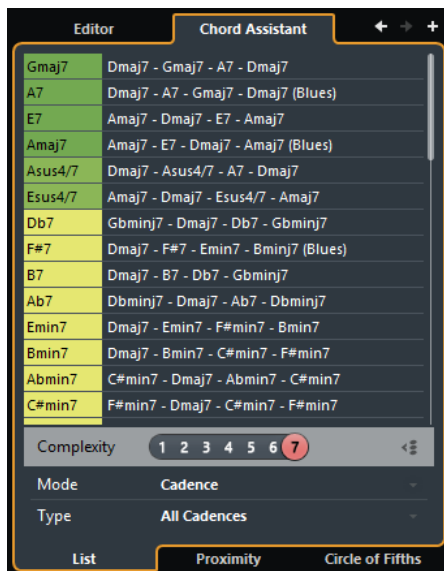

RELATED LINKS

[Chord Assistant – List](#) on page 1055

[Chord Assistant – Proximity](#) on page 1057

[Chord Assistant – Circle of Fifths](#) on page 1058

Chord Assistant – List

The **List** mode of the **Chord Assistant** allows you to create harmonic chord progressions based on harmonic rules that can be more or less complex.

- To open the **Chord Assistant**, in the **Chord Editor**, click **Chord Assistant**.

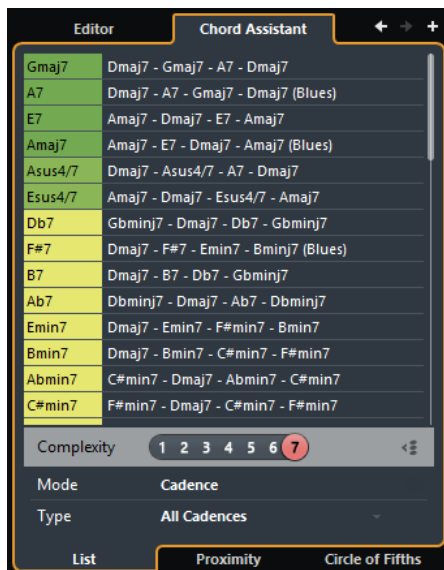

Go to Previous Chord/Go to Next Chord

Allow you to select the previous/next chord on the chord track for editing.

Add Chord

Adds a new undefined chord event on the chord track.

NOTE

This works only if the last chord event on the chord track is selected.

Suggestions list

Shows suggestions for the next chord. Click a chord suggestion to select it.

Complexity filter

Allows you to increase the complexity and thus the number of suggestions. The higher the complexity, the more suggestions you get.

Gap Mode

Activate this button to get suggestions for the chords in between 2 defined chords based on the previous and the next chord.

Deactivate this button to get suggestions for the next chord based on the previous chord.

NOTE

For this to work you must select all undefined chords in between 2 defined chords.

Algorithm Mode

Select **Cadence** to build up a chord progression based on cadences. Select **Common Notes** to build up a progression by specifying how many common notes the chords should share.

Cadence Type

NOTE

This option is only available if you selected **Cadence** as **Algorithm Mode**.

Allows you to select a cadence type for the suggestions. This way, only the chords with specific harmonic functions are suggested.

Chord Assistant tabs

Click the tabs to open one of the chord assistant modes.

Chord Assistant – Proximity

The **Proximity** mode of the **Chord Assistant** takes a set of harmonic rules into account to offer suggestions that match the origin chord.

If you open the **Chord Assistant** for a chord event, the previous event is set as origin chord. This is shown in the bottom center of the **Chord Assistant**. The further away a suggestion is situated from the origin chord in the graphic, the more complex the suggestion. The suggested chords are triads or 4-note chords.

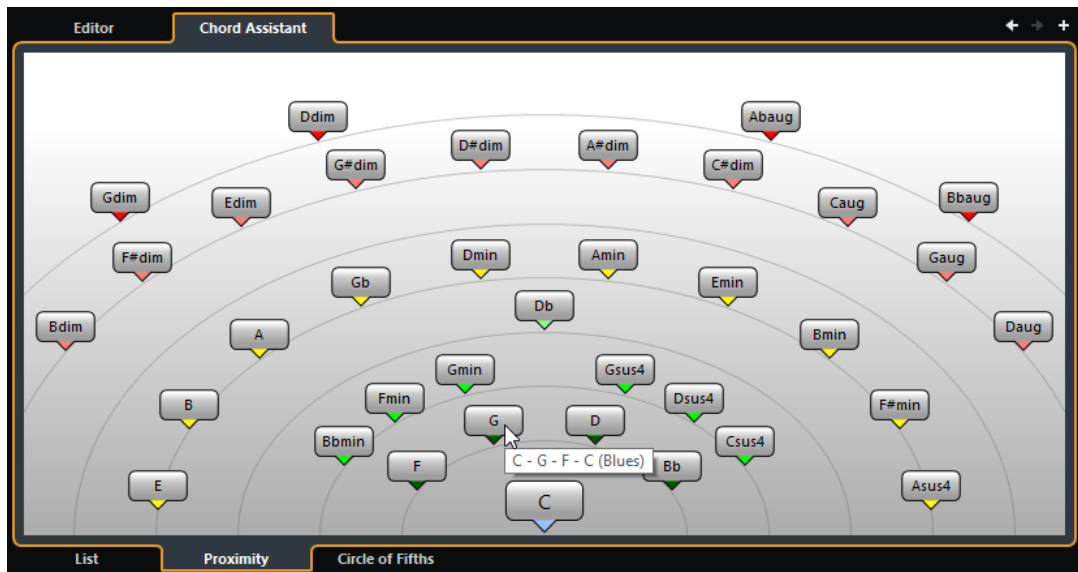

- To assign a chord to the selected chord event and play it, click it. The last 3 suggested chords that you clicked are shown in bold.

NOTE

- If you move the mouse pointer over one of the suggestions in the **Chord Assistant**, a tooltip with suggestions for progressions is shown.
- The **Proximity** mode underlies the same rules as the **List** mode.

Adding Chord Events Based on Suggestions

If you do not know what your chord progression should look like, you can use the **Chord Assistant** to get suggestions for the following chords.

PREREQUISITE

You have added a chord event on the chord track.

PROCEDURE

1. Double-click the chord event.
2. Click **Chord Assistant**.
3. Click **Add Chord**.
4. Do one of the following:
 - To display the suggestions in a list, click the **List** tab.

RESULT

The chord events on the chord track now trigger the sound of the assigned instrument on the MIDI or instrument track.

RELATED LINKS

[Chord Track](#) on page 159

[Add Track Dialog - Instrument](#) on page 132

Changing How Chord Events Are Displayed

You can change how chord events are displayed. This is useful if chord events overlap each other at low zoom levels or if you do not like the font type.

PROCEDURE

1. On the chord track, activate **Resolve Display Conflicts**.

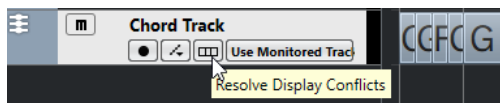

2. In the **Preferences** dialog, select **Event Display > Chords&Pitches**, and set up the chord font.

Here you can also determine the note name and naming format.

Scale Events

Scale events inform you which chord events fit in a specific sequence of notes that belong to a specific root note.

Nuendo automatically creates scale events for your chord events.

- To show the scale events, activate **Show Scales** on the chord track.

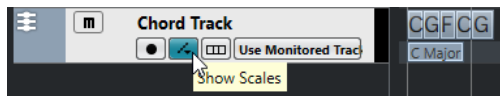

- To audition the notes that belong to a scale event, click it.

However, you can also add and edit scale events manually.

Scale events have a specific start position. Their end is determined by the start of the next scale event.

Editing Scale Events

PREREQUISITE

You have added a chord track and chord events. You have deactivated **Automatic Scales** in the chord track **Inspector**.

PROCEDURE

1. On the chord track, activate **Show Scales**.
The scale lane with scale events is displayed.
2. Select the chord event.
A scale event is shown on the scale lane.
3. Do one of the following:

- Click the first scale event on the chord track, and on the info line, select a **Root Key** and **Type**.

Start	Root Key	Type
1. 1. 1. 0	G	maj

- Double-click the scale event, and in the keyboard that appears, select a **Root Key** and **Type** of the scale.

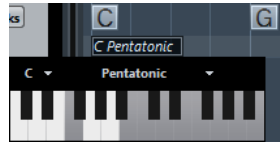

The keys that correspond to the scale are highlighted.

RELATED LINKS

[Scale Assistant in the Key Editor](#) on page 958

Musical Scale Setup Dialog

The **Musical Scale Setup** dialog allows you to set up and manage musical scales.

- To open the **Musical Scale Setup** dialog, select **Project > Chord Track > Set up Musical Scales**.

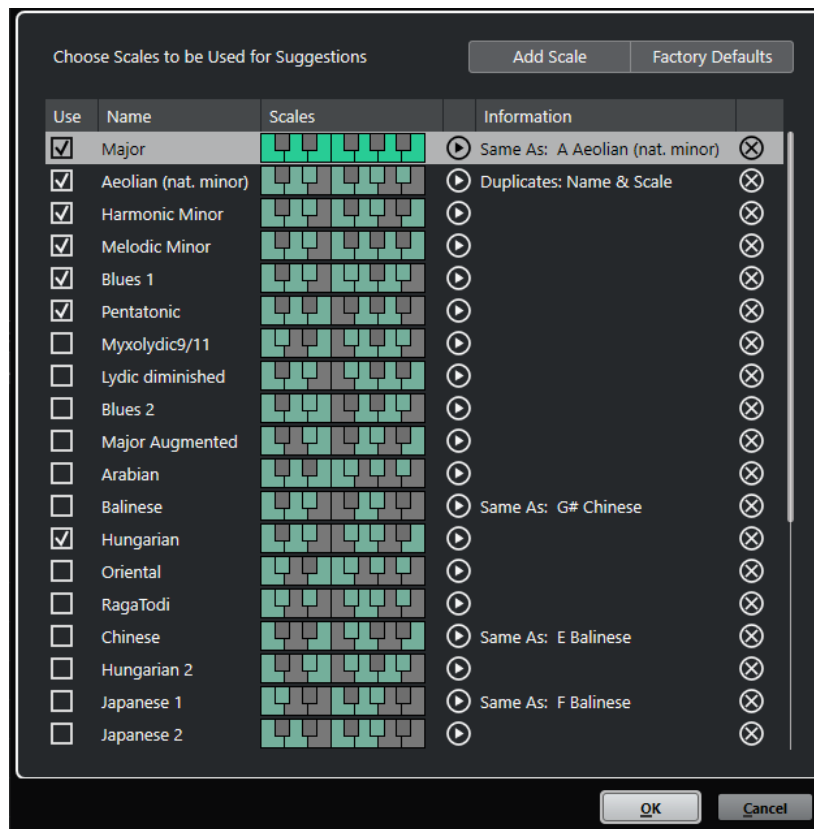

Add Scale

Adds a new scale to the list. Use the keyboard display to define the scale pitches. All scales start with C as a root note.

Factory Defaults

Resets all scales.

Use

Activates a scale.

NOTE

Activated musical scales are used in the chord track, in the **Scale Assistant** section of the **Key Editor Inspector**, in the **Transpose Setup** window, and in the **MIDI Modifiers** section of the **Inspector**.

Name

The name of the scale. Double-click to change it.

Scales

Shows a keyboard that allows you to define the scale pitches. Click a key to activate/deactivate a pitch for a scale. All scales start with C as a root note.

Preview Scale

Plays back the scale.

NOTE

For playback, the selected MIDI or instrument track must be record enabled and its output must be routed to an instrument.

Information

Informs you if the scale matches another scale or if it has the same name as another scale.

Remove Scale

Removes the corresponding scale from the scale suggestions.

NOTE

All changes apply to the entire application. This allows you to customize scales once and use them in all projects. However, if you remove or rename scales that are used in other projects, the scales cannot be retrieved.

RELATED LINKS

[Chord Track](#) on page 1052

[Scale Assistant in the Key Editor](#) on page 958

[Transpose Setup Dialog](#) on page 901

[MIDI Modifiers Section](#) on page 883

Voicings

Voicings determine how chord events are set up. They define the vertical spacing and order of the pitches in a chord, but also the instrumentation and genre of a musical piece.

For example, a C chord can be spread over a wide range of pitches, and a pianist will choose different notes than a guitarist. The pianist may also play completely different pitches for different musical genres.

- You can set up voicing for the entire chord track in the chord track **Inspector**.
- You can set up voicings for individual chord events on the **Voicing** pop-up menu on the info line.

NOTE

If **Adaptive Voicings** is activated in the chord track **Inspector**, you can only change the voicings for the first chord event on the info line.

Inspector Settings for Voicings

To set up voicings for the entire chord track, you can use the chord track **Inspector**.

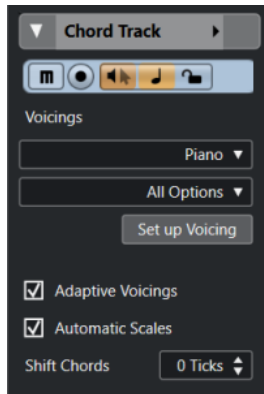

Voicing library

Allows you to select **Guitar**, **Piano**, or **Basic** as a voicing library.

Voicing library subset

NOTE

This is only available if **Guitar** or **Piano** is set as voicing library.

Allows you to select a preset voicing library subset.

Set up Voicing

Opens the **Custom Voicing** panel that allows you to configure your own voicing parameters for a specific voicing scheme.

Adaptive Voicings

Activate this to let Nuendo set the voicings automatically. This prevents the individual voices from jumping too much.

Automatic Scales

Activate this to let Nuendo set the scales automatically.

Shift Chords

If you enter a negative number of ticks, the chord events will affect the MIDI notes that have been triggered too early.

RELATED LINKS

[Custom Voicing Panel](#) on page 1063

Custom Voicing Panel

If you click **Set up Voicing** in the **Chords** section of the **Inspector**, you can configure your own voicing parameters for a specific voicing scheme.

- To open the **Custom Voicing** panel, click **Set up Voicing** in the **Chords** section of the **Inspector**.

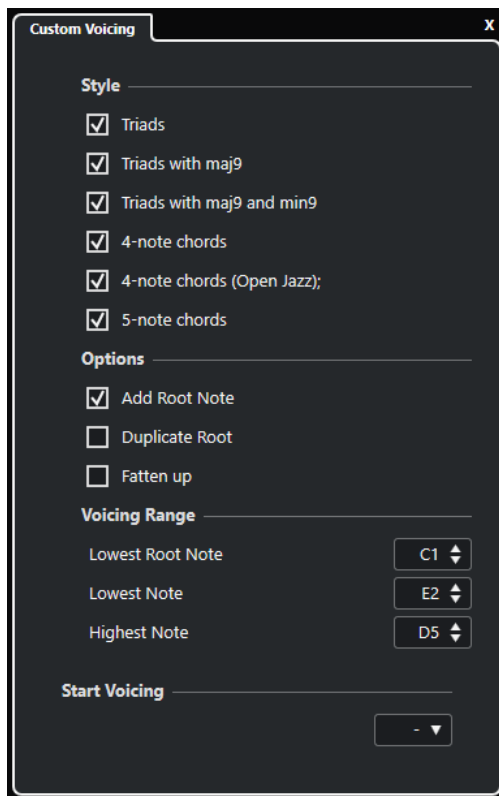

In the **Style** section for **Piano** voicings, you can set up the following parameters:

Triads

Sets a triad. Chords with more than 3 notes are not changed.

Triads with maj9

Sets a triad with a major ninth, but without root note. Chords with more than 3 notes are not changed.

Triads with maj9 and min9

Sets a triad with a major and a minor ninth, but without root note. Chords with more than 3 notes are not changed.

4-Note Chords

Sets a 4-note chord without root note. Chords with fewer than 3 notes are not changed.

4-Note Chords (Open Jazz)

Sets a 4-note chord without root note and without fifth. Chords with fewer than 3 notes are not changed.

5-Note Chords

Sets a 5-note chord with a ninth. Chords with fewer than 4 notes are not changed.

In the **Options** section for **Piano** voicings, you can set up the following parameters:

Add Root Note

Adds a root note.

Duplicate Root

Duplicates the root note.

Fatten up

Duplicates the tenor.

In the **Voicing Range** section for **Piano** voicings, you can set up the following parameters:

Lowest Root Note

Sets the limit for the lowest root note.

Lowest Note

Sets the limit for the lowest note, except the root note.

Highest Note

Sets the limit for the highest note, except the root note.

In the **Style** section for **Guitar** voicings, you can set up the following parameters:

Triads

Sets a triad with 4, 5 or 6 voices.

4-Note Chords

Sets a 4-note chord with 4, 5 or 6 voices without tensions.

3-String Triads

Sets a 3-string triad.

Modern Jazz

Sets 4-note, 5-note, and 6-note chords, partly without root note, but with tensions.

For **Basic** voicings, only **Octave Offset from C3** is available. This allows you to determine an offset value for the octave range.

In the **Start Voicing** section for **Piano**, **Guitar**, and **Basic** voicings, you can select a start voicing.

NOTE

This is only available for MIDI, instrument, and audio tracks, but not for the chord track, and only if you select **Voicings** in the **Follow Chord Track** pop-up menu.

Converting Chord Events to MIDI

You can convert chord events to MIDI for further editing or for printing a lead sheet in the **Score Editor**.

PROCEDURE

1. In the global track controls area of the track list, click **Add Track** .
 2. Do one of the following:
 - Click **Instrument** to add an instrument track.
 - Click **MIDI** to add a MIDI track.
 3. Click **Add Track**.
 4. Do one of the following:
 - To convert all chord events to MIDI, select **Project > Chord Track > Chords to MIDI**.
 - To convert only selected chords to MIDI, select the chord events and drag them to the MIDI or instrument track.
-

RESULT

A new MIDI part is created, containing the chords as MIDI events.

RELATED LINKS

[Add Track Dialog – Instrument](#) on page 132

[Add Track Dialog – MIDI](#) on page 139

Assigning Chord Events to MIDI Effects or VST Instruments

PREREQUISITE

Create a chord progression on the chord track and add a MIDI or instrument track to your project.

PROCEDURE

1. In the **Inspector** for the MIDI or instrument track, open the **MIDI Inserts** section.
 2. Click an insert slot and select **Chorder** from the **Effect Type** pop-up menu.
The **Chorder** effect is activated, and its control panel opens.
 3. On the chord track, select the chord events and drag them to the **Chorder** control panel.
The drop position determines the velocity area and the position of the first chord event. All subsequent chord events are mapped chromatically. Chord events with more than one occurrence are only assigned once.
To remap the chords, hold down **Alt/Opt** and drag again.
 4. On your MIDI keyboard, hit the corresponding keys to play back the chords.
-

Assigning Chord Events to HALion Sonic SE Pads

PREREQUISITE

Create a chord progression on the chord track and add an instrument track with HALion Sonic SE as VST instrument to your project.

PROCEDURE

1. On the chord track, select the chord events and drag them to the HALion Sonic SE pads.
The first chord event is mapped to the pad where you dropped it and all subsequent chord events are mapped to the following pads.
 2. Click the corresponding pads on the HALion Sonic SE keyboard to trigger the chords.
-

Controlling MIDI or Audio Playback Using the Chord Track

You can use the chord track to control audio playback or MIDI playback.

Chords Section for Audio Tracks

The **Chords** section in the audio track **Inspector** allows you to determine how the events on the audio track are mapped to the chord track.

- To open the **Chords** section for an audio track, select the track, and in the **Inspector**, click the **Chords** section.

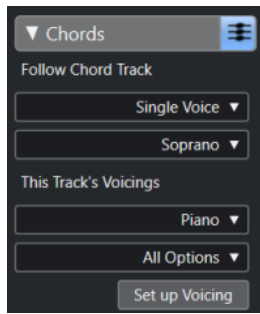

Follow Chord Track

Select an option to determine how the events on your track are mapped to the chord track.

This Track's Voicings

Allows you to select a voicing library or to use the voicings from the chord track. This is only available if you selected **Voicings** or **Single Voice** in the **Follow Chord Track** pop-up menu.

RELATED LINKS

[Using Follow Chord Track](#) on page 1068

[Follow Chord Track Modes](#) on page 1069

Chords Section for MIDI Tracks

The **Chords** section in the MIDI track **Inspector** allows you to determine how the events on the MIDI track are mapped to the chord track.

- To open the **Chords** section for a MIDI track, select the track, and in the **Inspector**, click the **Chords** section.

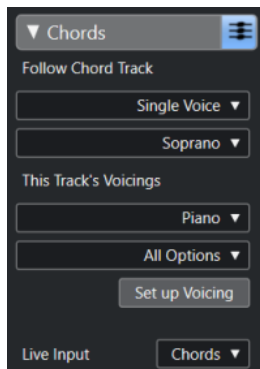

Follow Chord Track

Select an option to determine how the events on your track are mapped to the chord track.

This Track's Voicings

Allows you to select a voicing library or to use the voicings from the chord track. This is only available if you selected **Voicings** or **Single Voice** in the **Follow Chord Track** pop-up menu.

Live Input

Allows you to transpose the MIDI input live to a chord progression on the chord track.

RELATED LINKS

[Using Follow Chord Track](#) on page 1068

[Follow Chord Track Modes](#) on page 1069
[Using Live Input](#) on page 1068
[Chord Pads Zone](#) on page 1073
[Player Setup](#) on page 1087

Using Live Input

Live Input allows you to transpose the MIDI input live to a chord progression on the chord track. This way, you do not have to worry about what key you hit on your MIDI keyboard as the MIDI input is transposed to match chords or scales on your chord track in real time.

PROCEDURE

1. Create a MIDI or an instrument track and activate **Record Enable**.
2. In the **Inspector**, open the **Chords** section.
3. Open the **Live Input** pop-up menu and do one of the following:
 - To map the MIDI input to chord events, select **Chords**.
 - To map the MIDI input to scale events, select **Scales**.
4. Hit some keys on your MIDI keyboard or on the **On-Screen Keyboard**.

RESULT

Any key that you hit is mapped in real time to the chord or scale events on the chord track.

RELATED LINKS

[Scale Assistant in the Key Editor](#) on page 958
[Mapping Incoming MIDI Note Pitches to Musical Scales](#) on page 968

Using Follow Chord Track

This allows you to match an existing recording to a chord progression on the chord track.

PROCEDURE

1. Select the track that you want to match to the chord track.
2. In the **Inspector**, click **Chords**.
3. Open the **Follow Chord Track** pop-up menu and select a mode.

NOTE

If this is the first time that you open this pop-up menu for the track, the **Follow Chord Track** dialog opens.

-
4. In the **Follow Chord Track** dialog, make your changes.
 5. Click **OK**.

RESULT

The events on your track now match the chord progression on the chord track.

NOTE

If you matched your MIDI track to the chord track, some of the original MIDI notes may be muted. To hide these notes in the editors, activate **Hide Muted Notes in Editors** in the **Preferences** dialog (**Editing—Chords** page).

RELATED LINKS

[Follow Chord Track Dialog](#) on page 1070

[Follow Chord Track Modes](#) on page 1069

Follow Chord Track Modes

This section of the **Inspector** allows you to determine how your track follows the chord track.

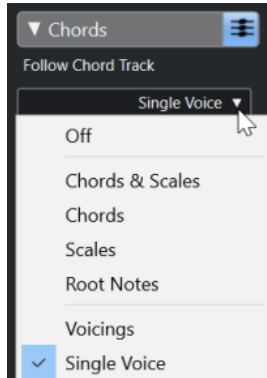

The following options are available on the **Follow Chord Track** pop-up menu:

Off

Follow Chord Track is deactivated.

Chords & Scales

This maintains the intervals of the original chord or scale as far as possible.

Chords

This transposes MIDI notes to match the key note and maps them to the current chord.

Scales

This transposes MIDI notes to match the current scale. This allows a bigger variety of notes and a more natural performance.

Root Notes

This transposes MIDI notes to match the root note of the chord event. The effect corresponds to using the transpose track. This option is suitable for bass tracks.

Voicings

This transposes MIDI notes to match the voices of the selected voicing library.

Single Voice

Maps MIDI notes and VariAudio segments to the notes of a single voice (soprano, tenor, bass, etc.) of the voicing. Use the pop-up menu below to select the voice.

NOTE

If you apply this mode to a selection of tracks that contain separate voices, you can set up one track as master and the others as voicing slaves. This way, you can change the voicing of the master and the slaves will follow automatically.

RELATED LINKS

[Assigning Voices to Notes](#) on page 1071

Follow Chord Track Dialog

This dialog opens the first time that you select an option from the **Follow Chord Track** pop-up menu on the **Chords** section of the **Inspector**.

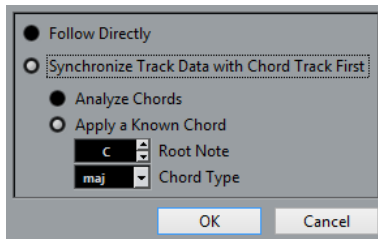

Follow Directly

Activate this if your VariAudio segments or MIDI notes are already in accordance with the chord track. This is the case if you extracted your chords from the MIDI events on the track by selecting **Project > Chord Track > Create Chord Symbols**, for example.

Synchronize Track Data with Chord Track First

Activate **Analyze Chords** if the track data has nothing in common with the chord events. This analyzes the MIDI events and matches the found chords to the chord track. This is only available for MIDI.

Activate **Apply a Known Chord** if the track data has nothing in common with the chord events and if there are no chord changes. Specify **Root Note** and **Chord Type** of your events.

Using Map to Chord Track

This allows you to match individual parts or events to a chord progression on the chord track.

PROCEDURE

1. In the **Project** window, select the events or parts that you want to map to the chord track.
2. Select **Project > Chord Track > Map to Chord Track**.
3. From the **Mapping Mode** pop-up menu, select a mapping mode.

NOTE

If you select **Voicings** and no voices are found, **Auto** mode is used instead.

4. Click **OK**.
-

RESULT

The chords and scales of each event or part are analyzed and used for mapping. If no chords are found, Nuendo assumes that the performance is in "C". The available mapping modes and voicings correspond to the **Follow Chord Track** parameters in the **Chords** section of the **Inspector**.

RELATED LINKS

[Follow Chord Track Modes](#) on page 1069

Assigning Voices to Notes

You can transpose MIDI notes to match the voices of a selected voicing library.

PROCEDURE

- Select **Project > Chord Track > Assign Voices to Notes**.

RESULT

The note pitches now match the voicing of the chord track and you can still edit the MIDI notes. If you now select a note in the **Key Editor**, you see that **Voice** on the info line is assigned.

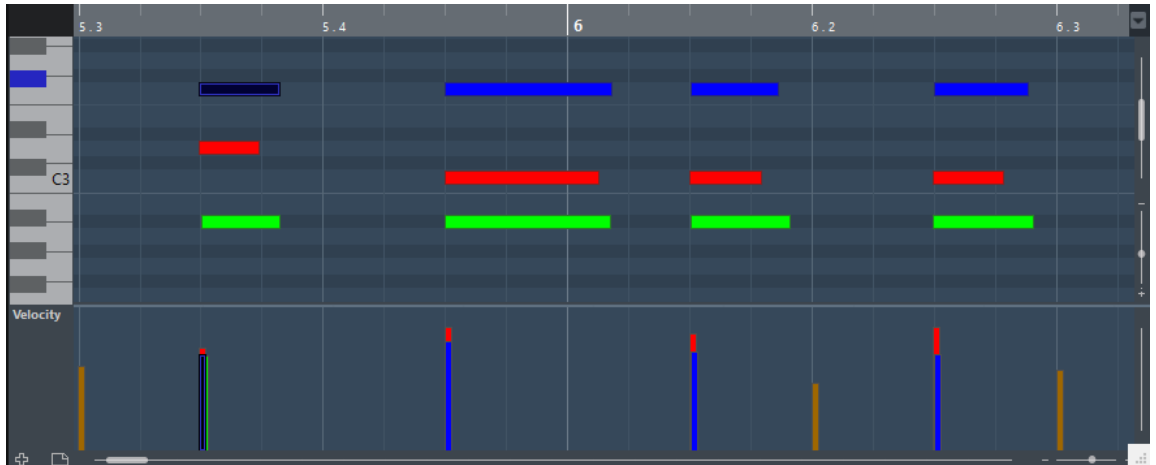

Extracting Chord Events from MIDI

You can extract chords from MIDI notes, parts, or tracks. This is useful if you have a MIDI file and want to show its harmonic structure, and use this file as starting point for further experimenting.

PREREQUISITE

Add the chord track and create MIDI notes that can be interpreted as chords. Drums, monophonic bass, or lead tracks are not suitable.

PROCEDURE

1. In the **Project** window, select a part or one or several MIDI tracks.
You can also select the MIDI tracks, parts, or notes that you want to extract in the **Key Editor**, **Score Editor**, or **In-Place Editor**.
2. Select **Project > Chord Track > Create Chord Symbols**.
3. Make your changes and click **OK**.

RESULT

The chord events are added on the chord track.

NOTE

You can now open the **Chord Assistant** to create variations.

RELATED LINKS

[Create Chord Symbols Dialog](#) on page 1072

Create Chord Symbols Dialog

This dialog allows you to determine, which MIDI data should be taken into account when extracting chord events from MIDI.

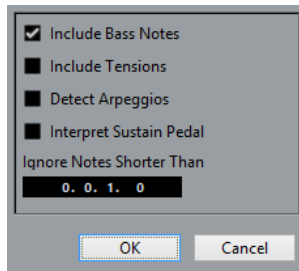

Include Bass Notes

Activate this if you want your chord events to contain a bass note.

Include Tensions

Activate this if you want your chord events to contain tensions.

Detect Arpeggios

Activate this if you want your chord events to contain arpeggiated chords, that is, chords whose notes are played one after another instead of all at once.

Interpret Sustain Pedal

Activate this if you want your chord events to contain sustain pedal chords, that is, notes that are played while the sustain pedal is held.

Ignore Notes Shorter Than

Allows you to determine the minimum length of the MIDI events that are taken into account.

Recording Chord Events with a MIDI Keyboard

You can use a MIDI keyboard to record chord events on the chord track.

PREREQUISITE

Your project contains an instrument track with **Record Enable** or **Monitor** activated.

PROCEDURE

1. On the chord track, activate **Record Enable**.
 2. On the **Transport** panel, activate **Record**.
 3. Play some chords on your MIDI keyboard.
-

RESULT

All recognized chords are recorded as chord events on the chord track.

NOTE

The chord track uses its own voicing settings. The recorded chord events may therefore sound different.

RELATED LINKS

[Adding Chord Events](#) on page 1054

Chord Pads

Chord pads allow you to play with chords, and to change their voicings and tensions. In terms of harmonies and rhythms, they allow for a more playful and spontaneous approach to composition than the chord track functions.

You can:

- Perform with chords in real time via a MIDI keyboard.
- Record your performance as MIDI events on a MIDI or instrument track or even on the chord track.

NOTE

We assume that you have a MIDI keyboard connected and set up.

RELATED LINKS

[Voicings](#) on page 1062

Chord Pads Zone

The chord pads in the lower zone of the **Project** window hold all functions that you need to work with chord pads.

To open the **Chord Pads**, select **Project > Chord Pads > Show/Hide Chord Pads**.

The chord pads hold the following controls:

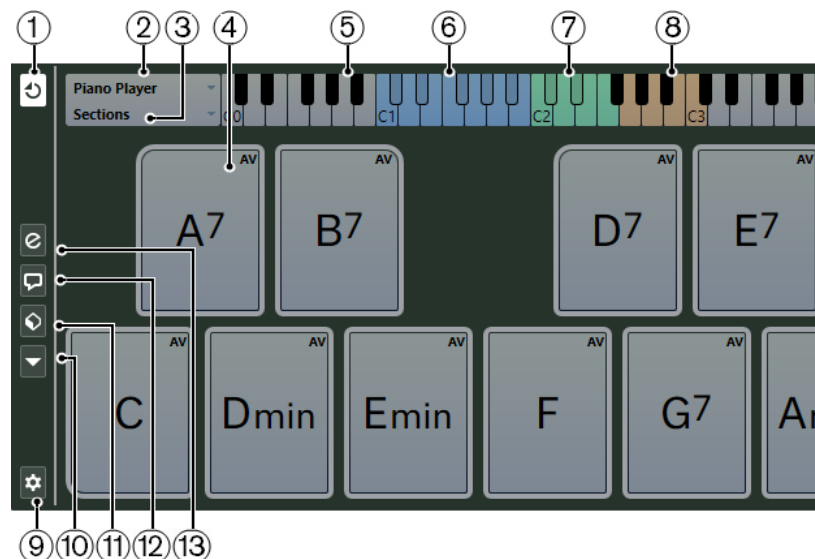

1 Chord Pad Output Mode

Activate this to send chord data to all tracks that are monitored or record-enabled.

Deactivate this to send chord data exclusively to tracks that are monitored or record-enabled and where **Input Routing** is set to **Chord Pads**.

NOTE

If **Record-Enable allows MIDI Thru** is deactivated in the **Preferences** dialog (**Record—MIDI** page), you must activate **Monitor** to use the chord pads.

2 Current Player

Shows the selected player and opens a pop-up menu where you can select another player.

3 Current Mode

Shows the selected player mode and opens a pop-up menu where you can select another player mode.

4 Chord Pad

Each chord pad can contain a chord symbol. Right-click a chord pad to open a context menu for that chord pad. To change the chord that is assigned to the chord pad, click **Open Editor** on the left edge of the chord pad.

5 Keyboard

Shows which keys are played when you trigger a chord pad. To zoom the keyboard, click a key and drag up or down. To scroll the keyboard, click and drag to the left or to the right.

6 Pads Remote Range

The keys highlighted in blue on the keyboard correspond to the keys on your MIDI keyboard that trigger the chord pads. You can define the remote range on the **Pad Remote Control** page of the **Chord Pads Setup** dialog.

7 Remote Range for Voicings/Tensions/Transpose

The keys highlighted in green on the keyboard display correspond to the keys on your MIDI keyboard that change the voicings, tensions, and transpose settings of the pads. You can activate and define these remote keys on the **Pad Remote Control** page of the **Chord Pads Setup** dialog.

8 Section Remote Range

The keys highlighted in brown on the keyboard correspond to the keys on your MIDI keyboard that trigger the sections.

NOTE

The section remote range is only shown if **Player Modes** is set to **Sections**.

9 Set up Chord Pads

Opens the **Chord Pads Setup** dialog.

10 Functions Menu

Opens a pop-up menu with specific functions and settings for the chord pads.

11 Chord Pads Presets

Allows you to save and load presets for chord pads and players.

12 Show/Hide Chord Assistant

Shows/Hides the **Chord Assistant** window that shows suggestions of chords that match the chord that you specified as the origin chord.

13 Show/Hide Player Setup

Shows/Hides the player setup options.

RELATED LINKS

[Chord Pads Setup Dialog](#) on page 1094

[Playing Back and Recording Chords](#) on page 1084

[Players and Voicings](#) on page 1088

[Opening Chord Pads](#) on page 73

[Player Modes—Sections](#) on page 1091

Chord Pad Controls

The chord pad controls allow you to edit the chord pads.

- To show the chord pad controls, move the mouse over a chord pad.

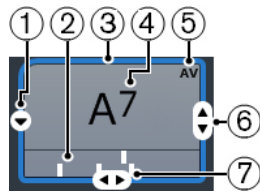

1 Open Editor

Opens the **Chord Editor** that allows you to select a chord for the chord pad.

2 Voicing indicators

Shows the voicing used for the chord. Voicing indicators can only be displayed if the horizontal zoom level for the chord pads is high enough.

3 Adaptive Voicing Reference/Use X as Origin for Chord Assistant

When the active chord pad is set as adaptive voicing reference, its borders are shown in yellow. All other chord pads follow its voicing and are set in a way that they do not get too far away from the reference.

If the chord pad is set as origin for the **Chord Assistant** window, its borders are shown in blue. This chord pad is used as a basis for the suggestions in the **Chord Assistant** window.

4 Assigned Chord

Shows the chord symbol that is assigned to the chord pad. Each chord pad can contain one chord symbol. If the name of the assigned chord is too long to display it on the chord pad, it is underlined, and the full chord name is shown in a tooltip.

5 AV (Adaptive Voicing)/L (Lock)

All chord pads follow the adaptive voicing. This is indicated by **AV**. If you change the voicing for a pad manually, however, adaptive voicing is deactivated.

An **L** indicates that the chord pad is locked for editing.

6 Voicing

Allows you to set another voicing for the chord pad.

7 Tensions

Allows you to add/remove tensions for the chord.

Chord Pad Context Menu

- To open the chord pad context menu, right-click a chord pad.

Use X as Origin for Chord Assistant

Sets the chord of the current pad as an origin chord for the chord assistant.

Assign Pad from MIDI Input

Allows you to assign a chord by pressing keys on your MIDI keyboard.

Lock

Allows you to lock a chord pad for editing.

Adaptive Voicing

All chord pads follow the adaptive voicing. This is indicated by a check mark. If you change the voicing for a pad manually, adaptive voicing is deactivated.

Adaptive Voicings Reference

Sets the current pad as adaptive voicing reference. If set, the automatic voicings for the following pads are set in a way that they do not get too far away from the reference voicing. Only one pad can be set as adaptive voicing reference.

Unassign Pad

Removes the chord assignment from the current pad.

Functions Menu

- To open the functions menu, click **Functions Menu**.



Show Voicing Indicators

Allows you to activate/deactivate the voicing indicators that can be displayed at the bottom of each chord pad.

Assign Pads from Chord Track

Assigns the chord events from the chord track to the chord pads in the same order as they appear on the chord track. Chord events that have more than one occurrence are only assigned once.

Snap Playback to Musical Grid

Allows you to delay the playback of a triggered chord pad to the next defined musical position. This is useful if you work with an arpeggiator or if you set the **Player Modes** to **Pattern**.

Transpose All Pads

Transposes all chord pads by a defined transpose value.

Lock All Pads

Locks all chord pads for editing.

Unlock All Pads

Unlocks all chord pads.

Unassign All Pads

Removes the chord assignment from all pads.

Chord Assistant

The **Chord Assistant** allows you to use a chord as a starting point for suggestions for the next chord. It assists you in finding the right chords for creating a chord progression for your song.

- Click **Show/Hide Chord Assistant** on the left side of the chord pads area to open the **Chord Assistant**.

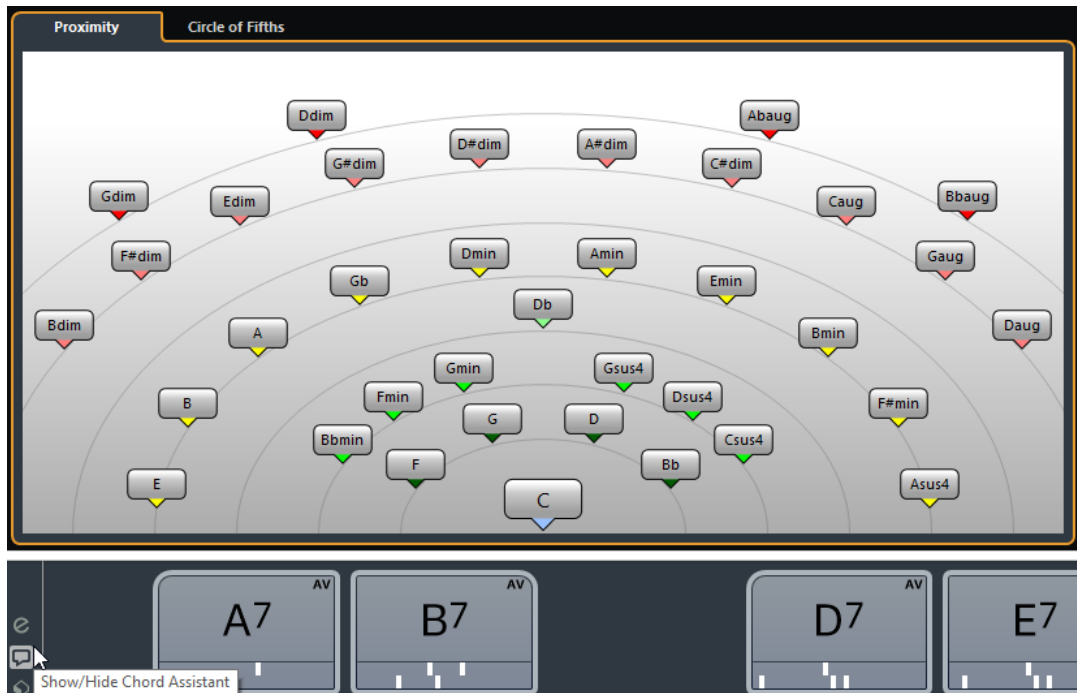

The **Chord Assistant** window has 2 modes:

- **Proximity**
- **Circle of Fifths**

You must define an origin chord as follows:

- Right-click the chord pad with the chord you want to use as origin and select **Use X as Origin for Chord Assistant**.

The **Chord Assistant** window shows suggestions for follow-on chords that you can assign to the chord pads.

Chord Assistant – List

The **List** mode of the **Chord Assistant** allows you to create harmonic chord progressions based on harmonic rules that can be more or less complex.

- To open the **Chord Assistant**, in the **Chord Editor**, click **Chord Assistant**.

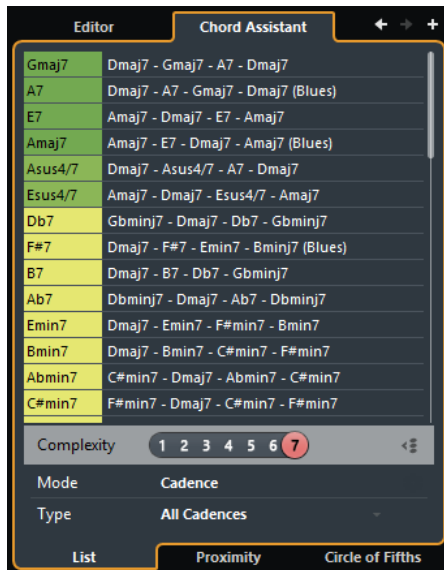

Go to Previous Chord/Go to Next Chord

Allow you to select the previous/next chord on the chord track for editing.

Add Chord

Adds a new undefined chord event on the chord track.

NOTE

This works only if the last chord event on the chord track is selected.

Suggestions list

Shows suggestions for the next chord. Click a chord suggestion to select it.

Complexity filter

Allows you to increase the complexity and thus the number of suggestions. The higher the complexity, the more suggestions you get.

Gap Mode

Activate this button to get suggestions for the chords in between 2 defined chords based on the previous and the next chord.

Deactivate this button to get suggestions for the next chord based on the previous chord.

NOTE

For this to work you must select all undefined chords in between 2 defined chords.

Algorithm Mode

Select **Cadence** to build up a chord progression based on cadences. Select **Common Notes** to build up a progression by specifying how many common notes the chords should share.

Cadence Type

NOTE

This option is only available if you selected **Cadence** as **Algorithm Mode**.

Allows you to select a cadence type for the suggestions. This way, only the chords with specific harmonic functions are suggested.

Chord Assistant tabs

Click the tabs to open one of the chord assistant modes.

Chord Assistant – Proximity Mode

The proximity mode of the **Chord Assistant** window uses a set of harmonic rules to offer suggestions that match the origin chord.

The origin chord in the bottom center of the **Chord Assistant** window marks the tonal center. The further away a chord suggestion is situated from this chord, the more complex the suggestion. The suggested chords are triads or 4-note chords.

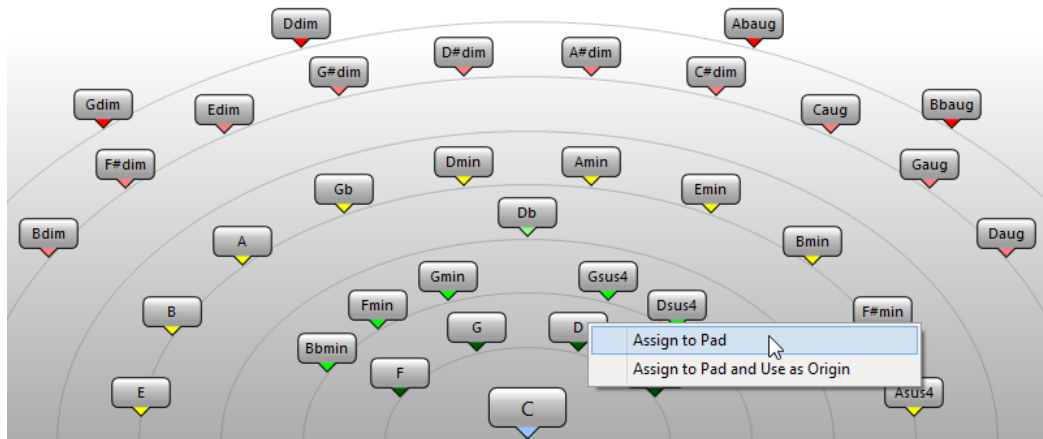

- To play a suggested chord, click it.
The last 3 suggested chords that you clicked are shown in bold.
- To assign a suggestion to the next unassigned chord pad, right-click the suggested chord and select **Assign to Pad**.
You can also drag the suggested chord and drop it on a chord pad.
- To assign a suggestion to the next unassigned chord pad and use this chord as origin for further suggestions, right-click the suggested chord and select **Assign to Pad and Use as Origin**.

NOTE

The **Proximity** mode is a different representation of the list in the **Chord Assistant** window for the chord track.

RELATED LINKS

[Chord Assistant – List](#) on page 1055

Chord Assistant – Circle of Fifths Mode

The **Circle of Fifths** mode of the **Chord Assistant** window shows the chords in an interactive visualization of the circle of fifths.

The origin chord that defines the current key is shown in the center of the **Chord Assistant** window. The tonic (I) of that key is displayed above the center. The outer circle shows the twelve major chords ordered in intervals of fifths.

The inner circle displays the corresponding parallel minor chords.

The roman numerals mark the chords of the current key with their scale degree. You can use these chords to create typical chord progressions. However, you can also use the other chords for more creative results.

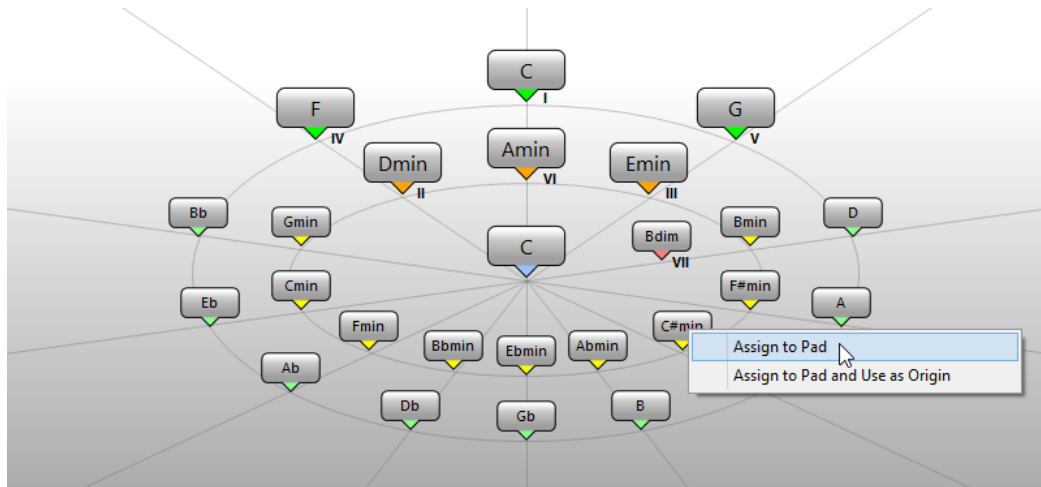

- To play a chord, click it.
The last 3 chords that you clicked are shown in bold.
- To assign a chord to the next unassigned chord pad, right-click the suggested chord and select **Assign to Pad**.
You can also drag the suggested chord and drop it on a chord pad.
- To assign a suggestion to the next unassigned chord pad and use this chord as origin, right-click the chord and select **Assign to Pad and Use as Origin**.

NOTE

The **Circle of Fifths** is also available in the **Chord Assistant** window for the chord track.

RELATED LINKS

[Chord Assistant - List](#) on page 1055

Chord Assignment

Some chords are preassigned to the chord pads. But you can also assign your own chords.

To assign chords to chord pads, you can use:

- The chord **Editor** window
- The **Chord Assistant - Proximity** window
- The **Chord Assistant - Circle of Fifths** window
- Your MIDI keyboard
- The chord events from the chord track

Unassigning Chord Pads

You can clear all chord assignments from the chord pads to start from scratch.

PROCEDURE

- To the left of the chord pads, open the **Functions Menu** and select **Unassign All Pads**.
-

Assigning Chords with the Chord Editor

If you know exactly which chord you want to assign to a specific chord pad, you can use the **Chord Editor**.

PROCEDURE

1. Move the mouse pointer to the left edge of the chord pad, and click **Open Editor**.
 2. In the **Chord Editor** window, use the chord definition buttons to define a root note, a chord type, a tension, and a bass note.
The new chord is triggered automatically to give an acoustic feedback.
-

Assigning Chords with the Chord Assistant – Proximity Mode

If you have a chord that you want to use as a starting point to find follow-on chords, you can use the **Chord Assistant – Proximity** window.

PROCEDURE

1. Right-click the chord pad that you want to use as a starting point and activate **Use X as Origin for Chord Assistant**.

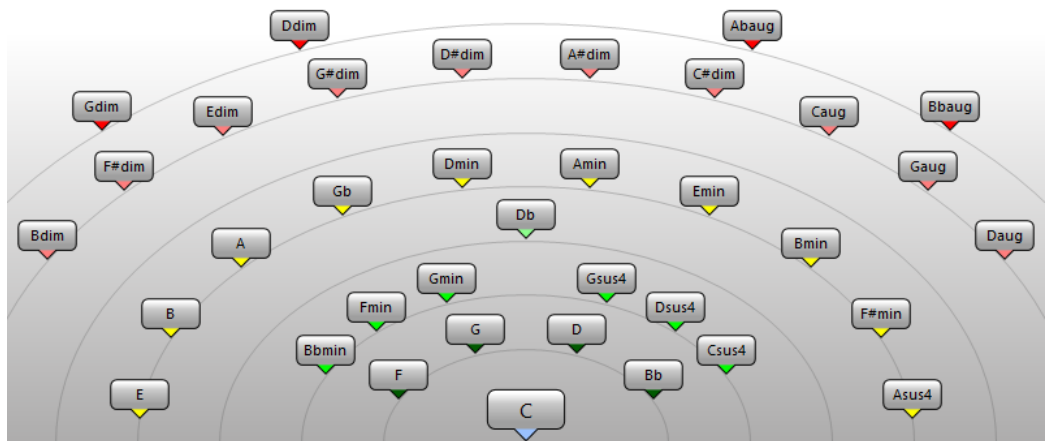

The **Chord Assistant** window opens, and the borders of the chord pad change their color to indicate that the assigned chord is now used as origin.

2. In the **Chord Assistant** window, click the chord symbols to trigger corresponding chords. The further away the chord is from the origin chord that is regarded as the tonal center, the more complex the suggestion becomes.
3. To assign a chord, drag it from the **Chord Assistant** window and drop it on a chord pad.

NOTE

If one of the next chord pads is free, you can also right-click the chord in the **Chord Assistant** window and select **Assign to Pad**. This assigns the chord to the next free pad.

RELATED LINKS

[Chord Assistant – List](#) on page 1055

Assigning Chords with the Chord Assistant – Circle of Fifths Mode

If you have a chord that you want to use as a starting point for a chord progression, but you do not know how to create such a progression, you can use the **Chord Assistant – Circle of Fifths** window.

PROCEDURE

1. Right-click the chord pad that you want to use as a starting point and activate **Use X as Origin for Chord Assistant**.

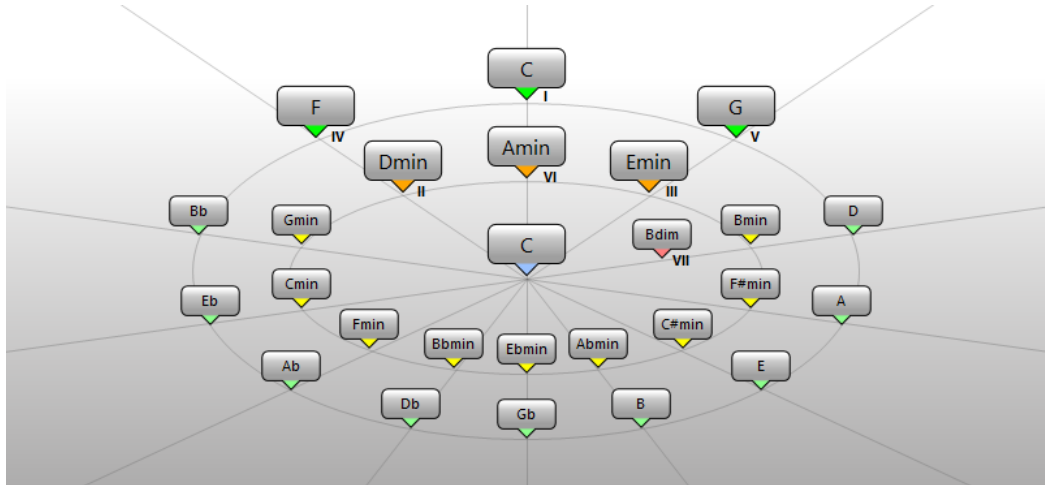

The **Chord Assistant** window opens, and the borders of the chord pad change their color to indicate that the assigned chord is now used as origin.

2. Click **Circle of Fifth** to switch to the **Circle of Fifth** mode.
The origin chord is displayed in the center, and the chords that belong to the scale are shown above it. The numerals indicate the scale degree of the chords. These help you to create chord progressions.
3. In the **Chord Assistant** window, click the chord symbols to trigger the corresponding chords.
4. To assign a chord, drag it from the **Chord Assistant** window and drop it on the chord pad.

NOTE

If one of the next chord pads is free, you can also right-click the chord in the **Chord Assistant** window and select **Assign to Pad**. This assigns the chord to the next free pad.

Assigning Chords with the MIDI Keyboard

If you know which chord you want to assign to a specific chord pad, you can use a MIDI keyboard or the **On-Screen Keyboard**.

PREREQUISITE

You have selected a MIDI track or an instrument track.

PROCEDURE

1. Right-click the chord pad that you want to use for the new chord, and select **Assign Pad from MIDI Input**.
The borders of the chord pad change their color to indicate that it is now ready for recording.
2. On your MIDI keyboard or on the **On-Screen Keyboard**, press the keys for the chord that you want to assign.

The chord and its voicing are assigned to the chord pad, and you hear an acoustic feedback of the chord.

NOTE

The assigned voicing can be changed by the **Adaptive Voicing** setting. Therefore, if you want to keep the voicing for that specific pad, right-click the chord pad and select **Lock** from the context menu.

RELATED LINKS

[Adaptive Voicing](#) on page 1088

Assigning Chords from the Chord Track

You can assign the chord events from the chord track to the chord pads.

PREREQUISITE

You have added a chord track with chord events to your project.

PROCEDURE

- To the left of the chord pads, click the **Functions Menu** button, and select **Assign Pads from Chord Track**.
If chords are already assigned to the chord pads, a warning message informs you that all previous assignments will be overwritten.
-

RESULT

The chord events are assigned to the chord pads in the same order as they appear on the chord track.

NOTE

Chord events that have more than one occurrence on the chord track are only assigned once.

RELATED LINKS

[Adding the Chord Track](#) on page 1052

[Adding Chord Events](#) on page 1054

Swapping Chord Assignments

You can swap the chord assignments of 2 pads.

PROCEDURE

- Click a chord pad and drag it to another chord pad.
While you drag, the border of the destination chord pad changes its color.
-

RESULT

When you drop the pad on another, the chord assignments are swapped together with their settings, except for the **Adaptive Voicing Reference**.

Copying Chord Assignments

You can copy the chord assignment of one pad and paste it on another pad.

PROCEDURE

- **Alt/Opt**-click a chord pad and drag it to another chord pad.
While you drag, the border of the destination chord pad changes its color.

RESULT

When you drop the pad on another, the first pad's assignment is copied to the destination chord pad together with its settings, except for the **Adaptive Voicing Reference**.

Playing Back and Recording Chords

You can play back and record chords that are assigned to chord pads using MIDI or instrument tracks.

There are two different **Chord Pad Output Modes** that determine if chords that are assigned to chord pads can be played back and recorded using any or using exclusive MIDI or instrument tracks:

- **Chord Pad Output Mode: On**
Allows you to play back and record chord pads using any MIDI or instrument track where **Record Enable** or **Monitor** is activated.
- **Chord Pad Output Mode: Off**
Allows you to play back and record chord pads using exclusive MIDI or instrument tracks where **Record Enable** or **Monitor** is activated, and where **Chord Pads** is selected as a MIDI input in the **Input Routing** pop-up menu.

NOTE

If **Record-Enable allows MIDI Thru** is deactivated in the **Preferences** dialog (**Record—MIDI** page), you must activate **Monitor** to use the chord pads.

RELATED LINKS

- [Chord Pads Zone](#) on page 1073
- [Recording Chords on the Chord Track](#) on page 1086
- [Recording Chords on Instrument Tracks](#) on page 1086
- [Playing Back Chord Pads Using Any Instrument Track](#) on page 1084
- [Playing Back Chord Pads Using Exclusive Instrument Tracks](#) on page 1085

Playing Back Chord Pads Using Any Instrument Track

You can play back chord pads using any MIDI or instrument track where **Record Enable** or **Monitor** is activated.

PREREQUISITE

You have connected and set up a MIDI keyboard.

PROCEDURE

1. In the global track controls area of the track list, click **Add Track** .
2. Click **Instrument**.
3. Open the **Instrument** pop-up menu and select a VST instrument.

4. Click **Add Track**.
The instrument track is added to the track list, and the control panel of the selected VST instrument is opened.
5. On the instrument track, click **Record Enable** or **Monitor**.

NOTE

If **Record-Enable allows MIDI Thru** is deactivated in the **Preferences** dialog (**Record—MIDI** page), you must activate **Monitor** to use the chord pads.

6. Select **Project > Chord Pads > Show/Hide Chord Pads** to open the **Chord Pads**.
 7. Activate **Chord Pad Output Mode**.
 8. Press some keys on your MIDI keyboard to trigger the chords that are assigned to the chord pads.
-

RELATED LINKS

[Add Track Dialog – Instrument](#) on page 132

[Chord Pads Setup Dialog](#) on page 1094

[Changing the Pads Remote Range](#) on page 1097

Playing Back Chord Pads Using Exclusive Instrument Tracks

You can play back chord pads using exclusive MIDI or instrument tracks where **Record Enable** or **Monitor** is activated, and where **Chord Pads** is selected as a MIDI input in the **Input Routing** pop-up menu.

PREREQUISITE

You have set up a MIDI keyboard.

PROCEDURE

1. In the global track controls area of the track list, click **Add Track** .
2. Click **Instrument**.
3. Open the **Instrument** pop-up menu and select a VST instrument.
4. Click **Add Track**.
The instrument track is added to the track list, and the control panel of the selected VST instrument is opened.
5. On the instrument track, click **Record Enable** or **Monitor**.

NOTE

If **Record-Enable allows MIDI Thru** is deactivated in the **Preferences** dialog (**Record—MIDI** page), you must activate **Monitor** to use the chord pads.

6. In the **Inspector** for the instrument track, open the **Input Routing** pop-up menu, and select **Chord Pads**.
 7. Select **Project > Chord Pads > Show/Hide Chord Pads** to open the **Chord Pads**.
 8. Deactivate **Chord Pad Output Mode**.
 9. Press some keys on your MIDI keyboard to trigger the chords that are assigned to the chord pads.
-

RESULT

The instrument track now receives MIDI data exclusively from the chord pad device. You can use a connected MIDI keyboard to trigger the chord pads. This still works if you hide the **Chord Pads** from view.

NOTE

On the **Chord Pads** page of the **Studio Setup** dialog, you can select your connected MIDI keyboard from the **MIDI Input** pop-up menu. This is useful if you want to use a specific MIDI keyboard exclusively for triggering the chord pads.

Recording Chords on Instrument Tracks

You can record chords that are triggered by chord pads on MIDI or instrument tracks.

PREREQUISITE

You have connected and set up a MIDI keyboard, you have opened and set up the chord pads, and you have added an instrument or a MIDI track for which a VST instrument is loaded.

PROCEDURE

1. On the instrument track, click **Record Enable** or **Monitor**.

NOTE

If **Record-Enable allows MIDI Thru** is deactivated in the **Preferences** dialog (**Record—MIDI** page), you must activate **Monitor** to use the chord pads.

2. On the **Transport** panel, activate **Record**.
 3. On your MIDI keyboard, press the keys that trigger the chord pads.
-

RESULT

The triggered chords are recorded on the track. The note events are automatically assigned to different MIDI channels according to their pitches. Note events that correspond to the soprano voice are assigned to MIDI channel 1, alto is assigned to MIDI channel 2, and so on.

AFTER COMPLETING THIS TASK

Open the **Key Editor** and fine-tune your recorded MIDI parts using the chord editing functions, for example. You can also use **MIDI > Dissolve Part** to dissolve the recorded chords by pitches/channels.

Recording Chords on the Chord Track

You can record chords that are triggered by chord pads on the chord track. This way, you can easily create chord events for a lead sheet, for example.

PREREQUISITE

You have connected and set up a MIDI keyboard, you have opened and set up the chord pads, and you have added an instrument or a MIDI track for which a VST instrument is loaded.

PROCEDURE

1. On the instrument track, click **Record Enable** or **Monitor**.

NOTE

If **Record-Enable allows MIDI Thru** is deactivated in the **Preferences** dialog (**Record—MIDI** page), you must activate **Monitor** to use the chord pads.

2. Select **Project > Add Track > Chord**.
The chord track is added to the track list.
3. In the **Inspector** for the chord track, click **Record Enable**.
4. On the **Transport** panel, activate **Record**.
5. On your MIDI keyboard, press the keys that trigger the chord pads.

RESULT

The chord events are recorded on the chord track.

NOTE

The recorded chord events may sound different from the chord pad playback. This is because the voicing settings for the chord track differ from the chord pad voicings.

RELATED LINKS

- [Chord Track](#) on page 159
- [Chord Functions](#) on page 1052
- [Voicings](#) on page 1062

Player Setup

The **Player Setup** allows you to select a player and a voicing setting that is typical for that kind of player, and determine if the notes of a chord are played as plain chords, as a pattern, or as sections.

- To open the **Player Setup**, click **Show/Hide Player Setup**.

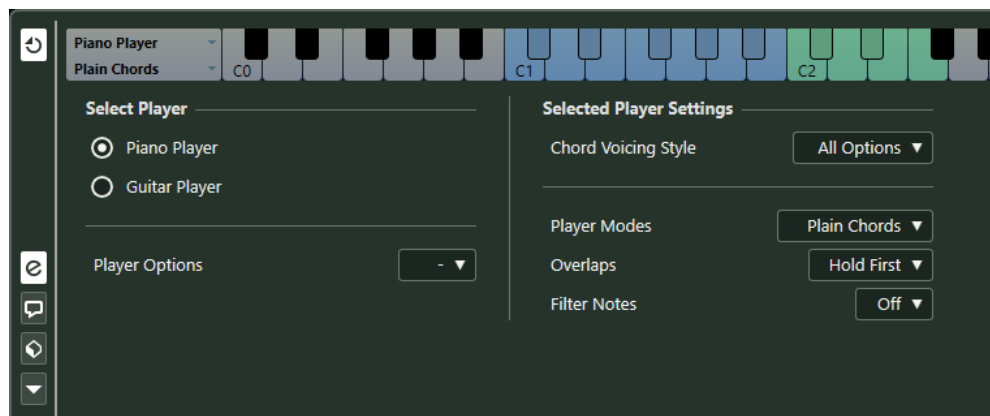

In the **Select Player** section, the following options are available:

List of Added Players

Shows the added players, and allows you to activate a player and use its voicing style and play mode for the chord pads.

Player Options

Allows you to add a player and to rename or remove the current player.

In the **Selected Player Settings** section, the following options are available:

Chord Voicing Style

Allows you to select a chord voicing style for the selected player. This determines how chords are played back, and what pitches are used.

Player Modes

- **Plain Chords** triggers all notes of a chord simultaneously.
- **Pattern** plays an arpeggio that is based on the notes of the pattern.
- **Sections** controls the playback of single notes or groups of notes of a chord.

RELATED LINKS

[Players and Voicings](#) on page 1088

[Voicings](#) on page 1062

[Player Setup](#) on page 1087

Players and Voicings

Different types of instruments and styles have different voicing libraries. These determine how the chords are played back, and which pitches are played. These voicings are referred to as players.

RELATED LINKS

[Voicings](#) on page 1062

Adaptive Voicing

In Nuendo, the adaptive voicing setting ensures that pitches in chord progressions do not change abruptly.

Adaptive voicing is activated and the voicings of the chord pads are determined automatically according to specific voice leading rules.



If you want to set the voicing of a specific chord pad manually, and do not want it changed automatically, you can use the voicing control to the right of a chord pad. When you assign your own voicing, adaptive voicing is deactivated for that chord pad, so that the pad does no longer follows the voice leading rules of the voicing reference. To activate adaptive voicing again, right-click the chord pad and activate **Adaptive Voicing**.

To lock the voicing for a chord pad, you can right-click the pad and activate **Lock**. This locks this pad for editing and remote control changes, and deactivates **Adaptive Voicing**. To unlock the chord pad again, right-click the pad and deactivate **Lock**.

Player Modes—Plain Chords

You can control the playback of plain chords.

- Click **Show/Hide Player Setup** to open the **Player Setup**, and in the **Player Modes** pop-up menu, select **Plain Chords**.



The following options are available:

Overlaps

Allows you to select what happens with the notes of the first chord when you play a chord without releasing the previous chord.

- **Hold First** holds the notes of the first chord. No note-off message is sent. If the chords have common notes, these are not triggered again.
- **Legato** releases the notes of the first chord, except for the common notes. These are held and not triggered again.
- **Stop First** releases the notes of the first chord including the common notes.

Filter Notes

Allows you to select which keys are filtered.

- **Off** filters nothing.
- **From MIDI Thru** filters unassigned keys, and keys that are assigned as remote keys for voicings, tensions, and transpose.

RELATED LINKS

[Chord Pads Setup Dialog](#) on page 1094

Player Modes—Pattern

If you select **Pattern** in the **Player Modes** pop-up menu, this allows you to play the notes that make up the chord one after another as an arpeggio based on the notes of the pattern.

- Click **Show/Hide Player Setup** to open the **Player Setup**, and in the **Player Modes** pop-up menu, select **Pattern**.

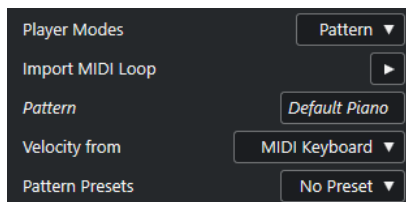

The following options are available:

In the **Selected Player Settings** section, the following options are available:

Import MIDI Loop

Allows you to select a MIDI loop that is used as a pattern.

Pattern

Allows you to drop a MIDI part from the event display that is used as a pattern. The name of the selected loop or part is shown.

Velocity from

- **Pattern** uses the velocity values from the MIDI loop or the MIDI part that is selected as a pattern.
- **MIDI Keyboard** allows you to determine the velocity values by pressing the keys on your MIDI keyboard harder or softer.

Pattern Presets

Allows you to save pattern presets.

Using the Pattern Player

You can play back the pattern of a MIDI loop or a MIDI part with chord pads. This plays back the pattern with the notes that make up the chord.

PROCEDURE

1. To the left of the chord pads, activate **Show/Hide Player Setup**.
2. In the **Selected Player Settings** section, open the **Player Modes** pop-up menu, and select **Pattern**.

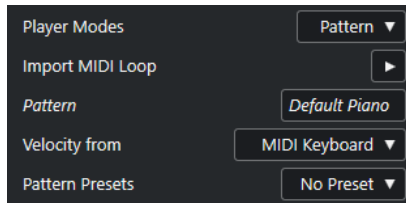

3. Perform one of the following actions:
 - Click **Import MIDI Loop** to select a MIDI loop that you want to use as a pattern.
 - Drag a MIDI part from the event display and drop it on the **Pattern** field.

NOTE

The loop or part must have between 3 and 5 voices. In the **MediaBay**, the number of voices is indicated in the **Voices** column of the **Result** list.

The loop or part is taken as a reference and defines how the chord is played.

4. In the **Velocity from** field, select a velocity source for the notes.
-

RELATED LINKS

[Assigning Voices to Notes](#) on page 1071

[Setting up the Results List Columns](#) on page 713

Using Different Players on Multiple Tracks

You can set up different players with different sounds on different tracks. If you record-enable these tracks and play the chord pads, each track uses a dedicated player.

PROCEDURE

1. In the global track controls area of the track list, click **Add Track** .
2. Click **Instrument**.
3. In the **Count** value field, select the number of tracks that you want to add.
4. Open the **Instrument** pop-up menu and select a VST instrument.
5. Click **Add Track**.

The instrument tracks are added to the track list, and the control panels of the selected VST instrument are opened.
6. Select **Project > Chord Pads > Show/Hide Chord Pads** to open the **Chord Pads**.
7. Activate **Chord Pad Output Mode**.
8. Click **Show/Hide Player Setup**.

9. Select the first instrument track, select a sound for the VST instrument, and set up a player. For example, select a piano sound and activate **Piano Player**.

NOTE

When setting up the player for a track, make sure that **Record Enable** or **Monitor** is only active for this particular track.

10. Select the second instrument track, select a sound for the VST instrument, and set up another player. For example, select a guitar sound and activate **Guitar Player**.
 11. Select the next instrument track, and proceed as for the other 2 tracks. For example, select a string sound, click **Player Options**, and select **Add Basic Player**.
 12. Select all instrument tracks, and click **Record Enable**.
-

RESULT

You can now play the chord pads and use the remote control parameters for tensions and transpose to change all chord symbols for each player simultaneously. However, if you change the **Voicing**, only the selected player is affected.

RELATED LINKS

[Add Track Dialog – Instrument](#) on page 132

Player Modes—Sections

You can control the playback of single notes or groups of notes, so called sections, of a chord that is assigned to a chord pad. Sections hold the chord notes, starting from bottom to top: the first section represents the lowest note or voicing of a chord, usually the bass. The second section represents the tenor, and so on.

- Click **Show/Hide Player Setup** to open the **Player Setup**, and in the **Player Modes** pop-up menu, select **Sections**.

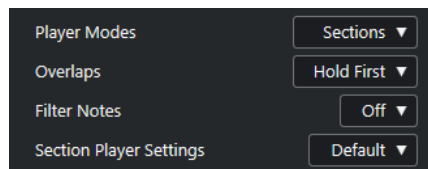

The following options are available:

Overlaps

Allows you to select what happens with the notes of the first chord when you play a chord without releasing the previous chord.

- **Hold First** holds the notes of the first chord. No note-off message is sent. If the chords have common notes, these are not triggered again.
- **Legato** releases the notes of the first chord, except for the common notes. These are held and not triggered again.
- **Stop First** releases the notes of the first chord including the common notes.

Filter Notes

Allows you to select which keys are filtered.

- **Off** filters nothing.
- **From MIDI Thru** filters unassigned keys, and keys that are assigned as remote keys for voicings, tensions, and transpose.

Section Player Settings

Opens the **Custom Section Player Settings** dialog.

RELATED LINKS

[Chord Pads Setup Dialog](#) on page 1094

[Custom Section Player Settings Dialog](#) on page 1092

Custom Section Player Settings Dialog

The custom settings for the section player allow you to determine how the sections are triggered, how they are distributed, or if they are played at all. Only sections with remote keys assigned are available.

- In the **Player Setup**, open the **Player Modes** pop-up menu and select **Sections**, then open the **Section Player Settings** pop-up menu and select **Custom**.

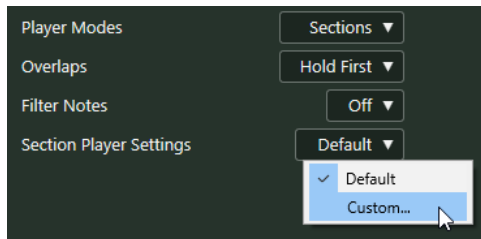

The following settings are available:

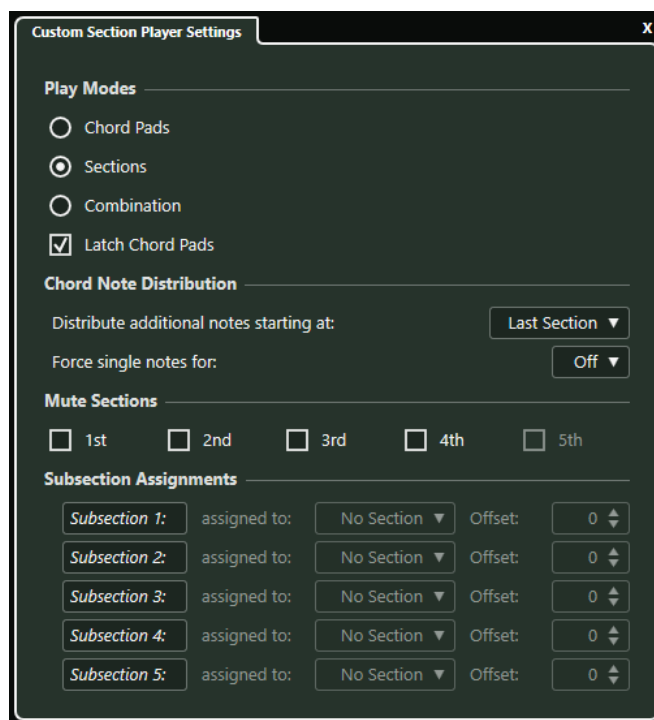

Play Modes

- **Chord Pads**
Allows you to hear the chord notes that correspond to the section if you press the remote key for a specific section on your MIDI keyboard.
- **Sections**
On your MIDI keyboard, first press a key that is assigned to a chord pad, then press the remote key for a specific section to hear the chord notes that correspond to the section.

- **Combination**

Combines sections and chord pads so that it does not matter whether you first press the remote key for the chord pad or for the section.

- **Latch Chord Pads**

Activate this for sections and combination modes. This way, if you release the remote key for the chord pad, you will still hear the sections if you keep the section remote keys pressed.

Chord Note Distribution

Allows you to determine how chord notes are distributed among the sections if the chord that is assigned to the chord pad has more notes than sections.

Mute Sections

Excludes a section from being played. This is useful if you want to exclude specific voicings from playback.

Subsection Assignments

These are available if you have set up remote keys for subsections on the **Player Remote Control** tab.

- Open the **assigned to** pop-up menu to assign a subsection to a section.
- Use the **Offset** controls to specify an offset from the section. This way, when you press the remote key for the subsection, you will hear the chord notes that correspond to the section, transposed by the specified offset.

Playing Back Chord Sections

You can play back chord sections of a chord pad. You can play the sections and their corresponding chord notes by using the remote keys that are assigned to them together with the remote keys that are assigned to a chord pad. To view and edit the remote key assignment for the sections, you can open the **Player Remote Control** tab.

PREREQUISITE

You have added an instrument track with an instrument assigned to your project. You have record-enabled the instrument track. You have a MIDI keyboard connected and set up. In the chord pads zone, you have activated **Chord Pad Output Mode**.

PROCEDURE

1. Click **Show/Hide Player Setup**, and in the **Player Modes** pop-up menu activate **Sections**. On the keyboard, the section remote range is highlighted in brown.



2. On your MIDI keyboard, press any key that corresponds to the pads remote range. This normally triggers the chord pad, however, in **Sections** mode, you do not hear anything until you press a section remote key.
3. On your MIDI keyboard, press any key that corresponds to the section remote range.

RESULT

The chord section of the chord whose chord pad you triggered is played back. You can press any other key in the section remote range to play different sections of the same chord, or press them all at once. You can use the remote keys for voicing, tension, and transpose to add variety.

Chord Pads Setup Dialog

The **Chord Pads Setup** dialog allows you to change the remote key assignments and the layout of the chord pads.

- To open the **Chord Pads Setup** dialog, click **Set up Chord Pads**.

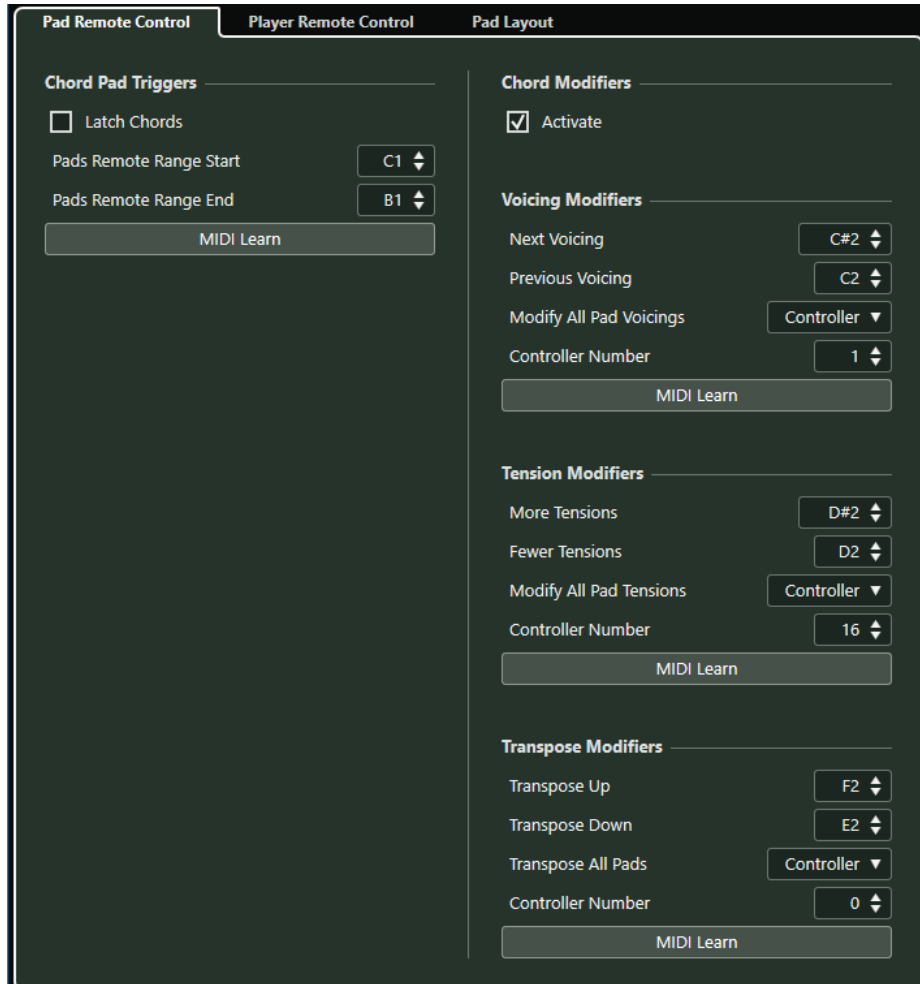

Pad Remote Control

Allows you to specify a range of remote keys that trigger the chords that are assigned to the chord pads. Here, you can also set up chord modifiers that allow you to specify how the chords are played back.

Player Remote Control

Allows you to specify a range of remote keys that trigger the chord notes, and that select or mute players.

Pad Layout

Allows you to change the layout that is used for the chord pads.

RELATED LINKS

[Pad Remote Control Tab](#) on page 1095

[Player Remote Control Tab](#) on page 1097

[Pad Layout Tab](#) on page 1099

Pad Remote Control Tab

The **Pad Remote Control** tab in the **Chord Pads Setup** dialog allows you to specify a range of remote keys that trigger the chords that are assigned to the chord pads.

- To open the **Pad Remote Control** tab, click **Set up Chord Pads**, and in the **Chord Pads Setup** dialog, click **Pad Remote Control**.

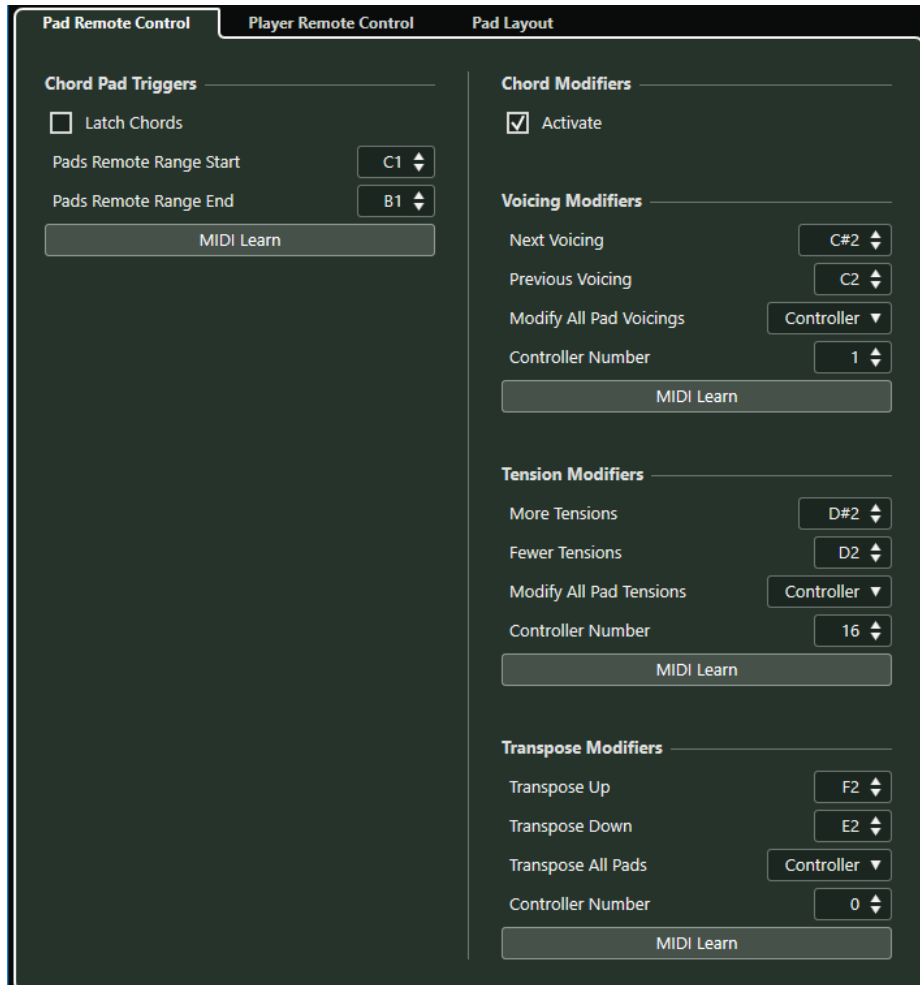

In the **Chord Pad Triggers** section, the following options are available:

Latch Chords

Activate this if you want the chord pad to play back until it is triggered again.

Pads Remote Range Start

Allows you to set the start note for the remote range. By default, this is set to C1.

Pads Remote Range End

Allows you to set the end note for the remote range. By default, this is set to B1.

MIDI Learn

Activates/Deactivates the **MIDI Learn** function to assign MIDI input to the pads remote range.

In the **Chord Modifiers** section, the following options are available:

Activate

Activates/Deactivates the remote key assignment for the parameters voicings, tensions, and transpose. If this option is deactivated, only the remote key assignment for the pads remote range is active.

NOTE

If you use the remote keys for voicings, tensions, or transposition after releasing the remote key for the chord pad, the chord pad that you last played is affected.

NOTE

If you use MIDI controllers that are already assigned to other remote control features, for example, the **Track Quick Controls** or the **VST Quick Controls**, all previous assignments are lost.

In the **Voicing Modifiers** section, the following options are available:

Next Voicing

Plays back the next voicing of the last played chord.

Previous Voicing

Plays back the previous voicing of the last played chord.

Modify All Pad Voicings

Allows you to set the voicings for all chord pads using one of the following modifiers:

- **No Modifier**
- **Aftertouch**
- **Pitchbend**
- **Controller**

If you select **Controller**, you can set the controller number in the **Controller Number** field.

MIDI Learn

Activates/Deactivates the **MIDI Learn** function to assign MIDI input to the parameters for changing voicings.

In the **Tension Modifiers** section, the following options are available:

More Tensions

Plays back the last played chord with more tensions.

Fewer Tensions

Plays back the last played chord with fewer tensions.

Modify All Pad Tensions

Allows you to set the tensions for all chord pads using one of the following modifiers:

- **No Modifier**
- **Aftertouch**
- **Pitchbend**
- **Controller**

If you select **Controller**, you can set the controller number in the **Controller Number** field.

MIDI Learn

Activates/Deactivates the **MIDI Learn** function to assign MIDI input to the parameters for changing tensions.

In the **Transpose Modifiers** section, the following options are available:

Transpose Up

Plays back the last played chord and transposes it upwards.

Transpose Down

Plays back the last played chord and transposes it downwards.

Transpose All Pads

Allows you to transpose all chord pads using one of the following modifiers:

- **No Modifier**
- **Aftertouch**
- **Pitchbend**
- **Controller**

If you select **Controller**, you can set the controller number in the **Controller Number** field.

MIDI Learn

Activates/Deactivates the **MIDI Learn** function to assign MIDI input to the parameters for changing transpose.

Changing the Pads Remote Range

You can widen the pads remote range to access more chord pads. If you want to use a wider key range on your MIDI keyboard for regular playing, you can narrow the pads remote range.

PROCEDURE

1. Click **Set up Chord Pads**.
2. Open the **Pad Remote Control** tab to open the remote control assignments.
3. Do one of the following:
 - Click **MIDI Learn** so that the button lights up, and on your MIDI keyboard, press the 2 keys that you want to assign as range start and range end.
 - Enter a new value in the **Pads Remote Range Start** and **Pads Remote Range End** fields.

RESULT

On the keyboard, the indication for pads remote range is changed.

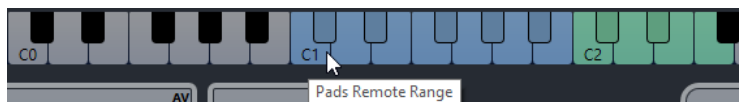

Player Remote Control Tab

The **Player Remote Control** tab in the **Chord Pads Setup** dialog allows you to specify a range of remote keys that trigger the chords that are assigned to the sections.

- To open the **Player Remote Control** tab, click **Set up Chord Pads**, and in the **Chord Pads Setup** dialog, click **Player Remote Control**.

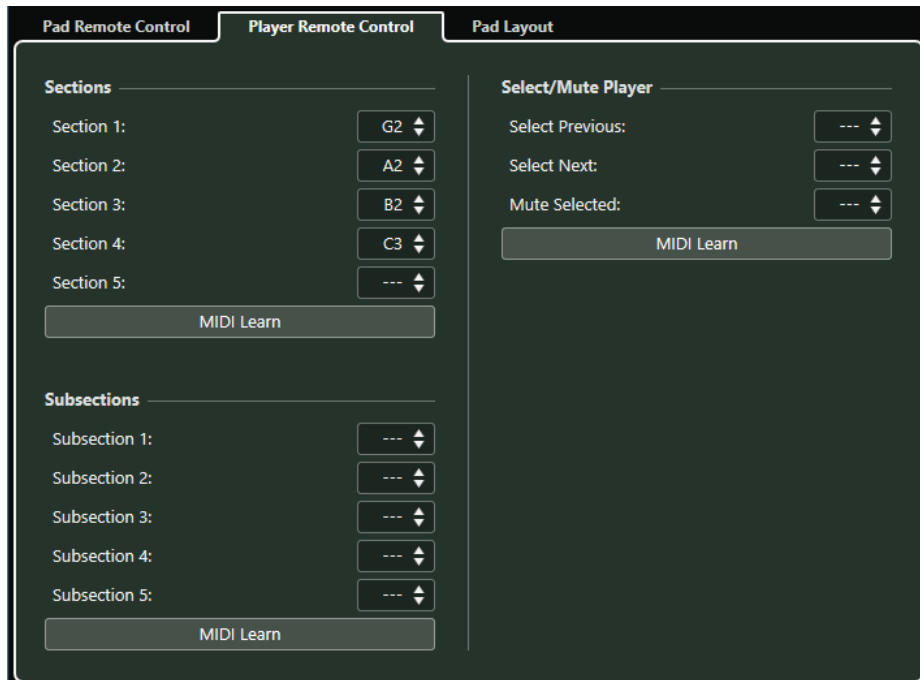

Sections

Allows you to assign remote keys for up to 5 sections. You can use the section remote keys together with a pad remote key to trigger the chord notes that correspond to the sections.

By default, **Section 1** is set to G2, **Section 2** is set to A2, **Section 3** is set to B2, and **Section 4** is set to C3.

MIDI Learn

Activates/Deactivates the **MIDI Learn** function to assign MIDI input to the sections.

Select/Mute Player

Allows you to assign remote keys for player navigation and muting if you use different players on multiple tracks.

MIDI Learn

Activates/Deactivates the **MIDI Learn** function to assign MIDI input to the parameters for selecting and muting players.

Subsections

Allows you to assign remote keys for up to 5 subsections. You can use the subsection remote keys together with a pad remote key to trigger the chord notes that correspond to the section transposed by the offset that is specified by its subsection.

MIDI Learn

Activates/Deactivates the **MIDI Learn** function to assign MIDI input to subsections.

RELATED LINKS

[Player Modes—Sections](#) on page 1091

Pad Layout Tab

The **Pad Layout** tab in the **Chord Pads Setup** dialog allows you to change the layout that is used for the chord pads.

NOTE

By default, the keyboard layout is active, but you can change to a grid layout if you prefer. After changing the pad layout, you may need to adjust the remote setup.

- To open the **Pad Layout** tab, click **Set up Chord Pads**, and in the **Chord Pads Setup** dialog, click **Pad Layout**.

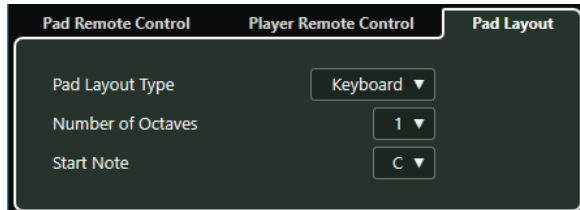

Pad Layout Type

Activate **Keyboard** to show the chord pads in a keyboard layout.

Activate **Grid** to show the chord pads in a grid layout.

Number of Octaves/Number of Rows

In **Keyboard** mode, you can select the number of octaves that you want to display.

In **Grid** mode, you can select the number of rows that you want to display.

Start Note

In **Keyboard** mode, you can select the start note for the first chord pad.

Number of Columns

In **Grid** mode, you can select the number of columns that you want to display.

Chord Pads Presets

Chord Pads Presets are templates that can be applied to newly created or to existing chord pads.

Chord Pads Presets contain the chords that are assigned to the chord pads, as well as the player configurations including any pattern data that you have imported via the **MediaBay** or by using drag and drop. **Chord Pads Presets** allow you to quickly load chords, or reuse player settings. The **Chord Pads Presets** pop-up menu is located to the left of the chord pads. **Chord Pads Presets** are organized in the **MediaBay**, and you can categorize them with attributes.

- To save/load a chord pads preset, click **Chord Pads Presets** and select **Save Chord Pads Preset/Load Chord Pads Preset**.

You can also load only the assigned chords from a preset, without loading the player configurations. This is useful if you want to use specific chords that you have saved as a preset, but do not want to alter your current player setting.

- To load only the chords of **Chord Pads Presets**, click **Chord Pads Presets** and select **Load Chords from Preset**.

In the same way, you can also load only the player configurations of **Chord Pads Presets**. This is useful if you have saved very complex player settings and want to reuse them on other chord pads without changing the assigned chords.

- To load only the player settings of **Chord Pads Presets**, click **Chord Pads Presets** and select **Load Players from Preset**.

Saving Chord Pads Presets

If you have set up the chord pads, you can save them as **Chord Pads Presets**.

PROCEDURE

1. To the left of the chord pads, click **Chord Pads Presets** and select **Save Chord Pads Preset**.
2. In the **New Preset** section, enter a name for the new preset.

NOTE

You can also define attributes for the preset.

3. Click **OK** to save the preset and exit the dialog.
-

Creating Chord Events from Chord Pads

You can use the chords assigned to the chord pads to create chord events in the **Project** window.

PROCEDURE

- Click a chord pad, and drag it on the chord track.
-

RESULT

A chord event is created.

RELATED LINKS

[Recording Chord Events with a MIDI Keyboard](#) on page 1072

Creating MIDI Parts from Chord Pads

You can use the chords assigned to the chord pads to create MIDI parts in the **Project** window.

PROCEDURE

- Click a chord pad, and drag it on a MIDI or instrument track.
-

RESULT

A MIDI part is created. It contains the MIDI events that build up the chord and has a length of one bar.

Logical Editor

The **Logical Editor** is a powerful tool for search and replace functions on MIDI data.

You can use the **Logical Editor** as follows:

- You set up filter conditions to find certain elements.
This can be elements of a certain type, with certain attributes or values, or on certain positions, in any combination. You can combine any number of filter conditions and make composite conditions using **And/Or** operators.
- You select the basic function to be performed.
The options include **Transform**, for changing properties of the found elements, **Delete**, for removing the elements, **Insert**, for adding new elements based on the found positions of other elements, and more.
- You set up a list of actions, which specify exactly what is done.
This is not necessary for all functions.

By combining filter conditions, functions, and the specific actions, you can perform very powerful processing.

To master the **Logical Editor**, you need some knowledge about how MIDI messages are structured. However, there is also a rich selection of presets, allowing you to access its processing powers without delving into its more complicated aspects.

RELATED LINKS

[Presets](#) on page 1115

Window Overview

The **Logical Editor** window allows you to combine filter conditions, functions, and actions to perform very powerful MIDI processing.

- To open the **Logical Editor**, select **MIDI > Logical Editor**.

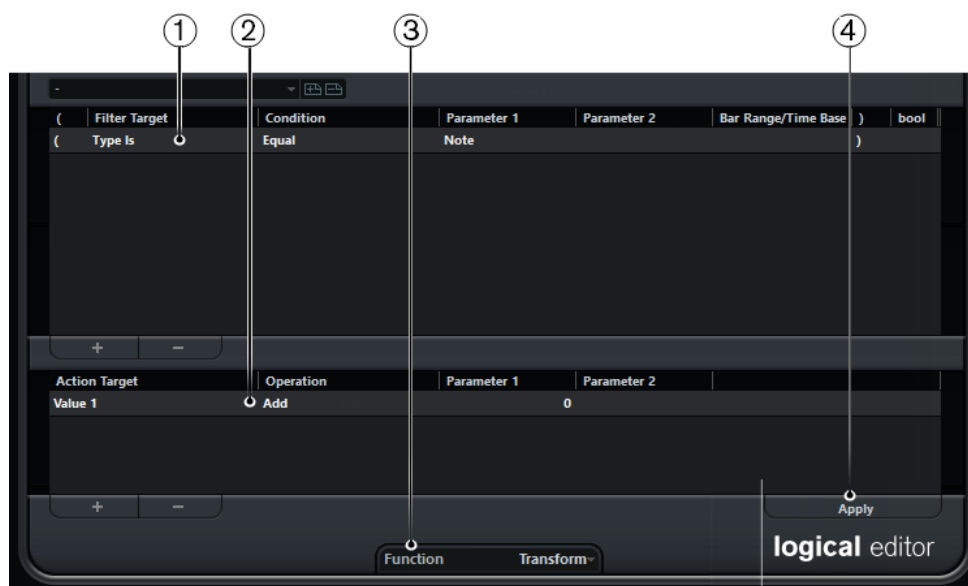

1 Filter Conditions

Allows you to specify the conditions such as type, attribute, value, or position that a specific element must meet to be found. You can combine any number of filter conditions using AND/OR operators.

2 Action list

Allows you to set up a list of actions that specifies exactly what is done. This is not necessary for all functions.

3 Function pop-up menu

Allows you to select a function.

4 Apply

Applies your settings.

Filter Conditions

The upper list is where you set up the filter conditions, determining which elements to find. The list can contain one or several conditions, each on a separate line.

To set up a filter condition, make the following settings:

Left bracket

Together with the right bracket, this allows you to combine multiple filter conditions, that is, multiple lines with the boolean operators And/Or.

Filter Target

Sets the property of the element. This setting affects the available options in the other columns.

Condition

Determines how the **Logical Editor** compares the property in the **Filter Target** column to the values in the **Parameter** columns. The available options depend on the **Filter Target** setting.

Parameter 1

Sets which value the element properties are compared to. This depends on the **Filter Target**.

Parameter 2

Only available if one of the **Range** options is set in the **Condition** column. Allows you to find all elements with values inside or outside the range between **Parameter 1** and **Parameter 2**.

Bar Range/Time Base

Only available if the **Filter Target** is set to **Position**. If one of the **Bar Range** options is selected in the **Condition** column, you use the **Bar Range/Time Base** column to specify zones within each bar. This allows you to find all elements on or around the first beat of every bar, for example. If any of the other **Condition** options is selected, you can use the **Bar Range/Time Base** column to specify a time base such as PPQ, seconds, etc.

Right bracket

Together with the left bracket, this allows you to combine several filter conditions.

bool

Allows you to insert the boolean operators And/Or, when creating conditions with multiple lines.

NOTE

If you make a mistake when combining multiple conditions with brackets, this is displayed in the status line.

NOTE

If you have already defined filter conditions and/or applied a preset, but want to start again from scratch, you can initialize the settings by selecting the **Init** option from the **Presets** pop-up menu.

NOTE

You can also set up filter conditions by dragging MIDI events directly into the upper list. If the list contains no entries, a MIDI event dragged into this section will form conditions including the state and type of the event. If it contains entries, the dragged event will initialize the matching parameters. For example, if a length condition is used, the length will be set according to the length of the event.

Depending on the **Filter Target** setting, the following options can be selected in the **Condition** column:

Equal

Has the exact same value as set up in the **Parameter 1** column.

Unequal

Has any value other than the one set up in the **Parameter 1** column.

Bigger

Has a value higher than the one set up in the **Parameter 1** column.

Bigger or Equal

Has a value that is the same as or higher than the one set up in the **Parameter 1** column.

Less

Has a value lower than the one set up in the **Parameter 1** column.

Less or Equal

Has a value that is the same as or lower than the one set up in the **Parameter 1** column.

Inside Range

Has a value that is between the values set up in the **Parameter 1** and **Parameter 2** columns. Note that **Parameter 1** should be the lower value and **Parameter 2** the higher.

Outside Range

Has a value that is not between the values set up in the **Parameter 1** and **Parameter 2** columns.

Inside Bar Range

Has a value that is within the zone set up in the **Bar Range/Time Base** column, in each bar within the current selection. This is only used if the **Filter Target** is set to **Position**.

Outside Bar Range

Has a value outside the zone set up in the **Bar Range/Time Base** column, in each bar within the current selection. This is only used if the **Filter Target** is set to **Position**.

Before Cursor

Is before the song cursor position. This is only used if the **Filter Target** is set to **Position**.

Beyond Cursor

Is after the song cursor position **Position** only.

Inside Track Loop

Is inside the set track loop. This is only used if the **Filter Target** is set to **Position**.

Inside Cycle

Is inside the set cycle. This is only used if the **Filter Target** is set to **Position**.

Exactly Matching Cycle

Exactly matches the set cycle. This is only used if the **Filter Target** is set to **Position**.

Note is equal to

Is the note specified in the **Parameter 1** column only, regardless of octave. For example, lets you find all C notes, in all octaves. This is only used if the **Filter Target** is set to **Pitch**.

NOTE

The conditions for the **Property** filter target are different.

RELATED LINKS

[Combining Multiple Condition Lines](#) on page 1125

[Searching for Properties](#) on page 1107

[Searching for Elements at Specific Positions](#) on page 1104

Searching for Elements at Specific Positions

You can search for elements starting at specific positions, either relative to the start of the project or within each bar.

PROCEDURE

1. Open the **Filter Target** pop-up menu and select **Position**.

This allows you to find elements starting at specific positions, either relative to the start of the project or within each bar.

2. Open the **Condition** pop-up menu and select one of the following options:

- To find all elements at a specific position, select a position in the **Parameter 1** column. You can set a time base such as PPQ, seconds, samples, or frames in the **Bar Range/Time Base** column.
- To find all elements inside or outside a range, select **Inside Bar Range** or **Outside Bar Range**.

You can set the bar range in the **Bar Range/Time Base** column by clicking and dragging in the bar display or by adjusting the start position of the range in the **Parameter 1** column and the end position in the **Parameter 2** column. You can change the time base using the **Bar Range/Time Base** column. The position for **Bar Range** is measured in ticks related to the start of the bar.

EXAMPLE

You can set up the **Logical Editor** to find all elements at 1.1.1.0 in the project.

Filter Target	Condition	Parameter 1
Position	Equal	1.01.01.000

You can set up the **Logical Editor** to find elements starting around the second beat in each bar.

Filter Target	Condition	Parameter 1	Parameter 2	Bar Range/Time Base
Position	Inside Bar Range	391	491	

Searching for Notes of Specific Lengths

You can search for notes of specific lengths.

PROCEDURE

1. Open the **Filter Target** pop-up menu and select **Length**.

This allows you to find notes of a specific length only.

NOTE

The **Length** parameter is interpreted via the time base setting in the **Bar Range/Time Base** column, that is, in PPQ, seconds, samples, or frames.

2. Open the **Parameter 1** pop-up menu and set the length that you want to search for.
3. Open the **Condition** pop-up menu and select an option.
If you select **Inside Range** or **Outside Range**, use **Parameter 1** and **Parameter 2** to set the start and the end of the range.
4. Click below the list to add another condition line.
Parameter 1 is automatically set to **Note** as the **Length Filter Target** is only valid for notes.

RELATED LINKS

[Combining Multiple Condition Lines](#) on page 1125

Value 1 and Value 2

MIDI events can be composed of value 1 and value 2.

Value 1 and value 2 have different meanings for different event types:

Event type	Value 1	Value 2
Notes	The Note Number/Pitch.	The velocity of the note.
Poly Pressure	The key that was pressed.	The amount of pressure for the key.
Controller	The type of Controller, displayed as a number.	The amount of Control Change.
Program Change	The Program Change number.	Not used.
Aftertouch	The amount of pressure.	Not used.
Pitchbend	The "fine-tune" of the bend. Not always used.	The coarse amount of bend.

Event type	Value 1	Value 2
VST 3 Event	Not used.	The value of the VST 3 Event parameter. The value range of the VST 3 event (0.0 to 1.0) is transformed into the MIDI value range (0-127), that is, the VST 3 event value 0.5 corresponds to 64. For some operations that require a higher resolution, you can make use of the "VST 3 Value Operation" parameter.

NOTE

System Exclusive events do not use value 1 and 2.

RELATED LINKS

[Action Target](#) on page 1112

Searching for Note Pitches or Velocities

PROCEDURE

1. Open the **Filter Target** pop-up menu and select **Value 1** for pitches, or **Value 2** for velocities.
2. Optional for pitches: In the **Parameter 1** column, enter a pitch either as note name such as C3, D#4, etc. or as a MIDI note number from 0 to 127.

NOTE

To find all notes of a certain key, in all octaves, open the **Condition** pop-up menu and select **Note is equal to**.

3. Click  below the list to add another condition line.
Parameter 1 is automatically set to **Note**. Also, **Value 1** and **Value 2** will be displayed as **Pitch** and **Velocity** respectively.
-

RELATED LINKS

[Combining Multiple Condition Lines](#) on page 1125

Searching for Controllers

PROCEDURE

1. Open the **Filter Target** pop-up menu and select **Value 1**.
 2. Click  below the list to add another condition line.
 3. Open the **Parameter 1** pop-up menu and select **Controller**.
Filter Target is automatically set to **MIDI Controller No.** and the **Parameter 1** column will show the names of the MIDI controllers.
-

RELATED LINKS

[Combining Multiple Condition Lines](#) on page 1125

Searching for MIDI Channels

Searching for MIDI channels is useful if you have recorded MIDI from an instrument sending on several different channels, or if you have imported a MIDI file of type 0 with a single track, containing MIDI events with different channel settings.

PROCEDURE

1. Open the **Filter Target** pop-up menu and select **Channel**.
 2. In the **Parameter 1** field, enter a MIDI channel from 1 to 16.
 3. Open the **Condition** pop-up menu and select an option.
-

Searching for Element Types

PROCEDURE

1. Open the **Filter Target** pop-up menu and select **Type**.
 2. Open the **Condition** pop-up menu and select an option.
 3. Open the **Parameter 1** pop-up menu and select a type such as note, poly pressure, controller, etc.
-

Searching for Properties

You can search for properties that are not part of the MIDI standard but rather Nuendo-specific settings.

PROCEDURE

1. Open the **Filter Target** pop-up menu and select **Property**.
 2. Open the **Parameter 1** pop-up menu and select the property that you want to search for.
 3. Open the **Condition** pop-up menu and select one of the following options:
 - Select **Property is set** if you want to search for events that have the specified property.
 - Select **Property is not set** if you want to search for events that do not have the specified property.
-

EXAMPLE

You can find all muted events.

Filter Target	Condition	Parameter 1	Parameter 2	Bar Range/Time Base
Property	Property is set	Event is muted		

You can find events that are selected and muted.

(Filter Target	Condition	Parameter 1	Parameter 2	Bar Range/Time Base
(Property	Property is set	Event is selected		
	Property	Property is set	Event is muted		

You can set up the **Logical Editor** to find all note expression data.

Filter Target	Condition	Parameter 1	Parameter 2	Bar Range/Time Base
Type Is	Unequal	Note		
Property	Property is set	Event inside NoteExp		

You can set up the **Logical Editor** to find all MIDI controller events that form part of note expression data.

Filter Target	Condition	Parameter 1	Parameter 2	Bar Range/Time Base
Type Is	Equal	Controller		
Property	Property is set	Event inside NoteExp		

You can set up the **Logical Editor** to find all VST 3 events that cannot be played back, because there is no note expression-compatible VST instrument on the related track.

Filter Target	Condition	Parameter 1	Parameter 2	Bar Range/Time Base
Type Is	Equal	VST3 Event	All Types	
Property	Property is set	Event is valid VST3		

Searching for Event Contexts

You can perform context-dependent searches. This is especially useful in the **Input Transformer**.

The **Filter Target Last Event** indicates the state of an event which has already passed the **Input Transformer** or the **Logical Editor**. The condition must be combined with **Parameter 1** and **Parameter 2**.

EXAMPLE

You can set up the **Logical Editor** to perform actions only when the sustain pedal is down.

(Filter Target	Condition	Parameter 1	Parameter 2	Bar Range/Time Base)	bool
	Last Event	Equal	MIDI Status	176/Controller			And
	Last Event	Equal	Value 1	64/E3			And
	Last Event	Equal	Value 2	64/E3			

You can set up the **Input Transformer** or the **Transformer** to perform actions only when the note C1 is pressed.

Filter Target	Condition	Parameter 1	Parameter 2	bool
Type Is	Equal	Note		And
Last Event	Equal	Note is playing	36/C1	

In this example, the action is performed after playing the C1.

Filter Target	Condition	Parameter 1	Parameter 2	bool
Last Event	Equal	Value 1	36/C1	

Searching for Highest/Lowest Notes in Chords

You can search for the highest or lowest note in a chord.

PROCEDURE

1. Open the **Filter Target** pop-up menu and select **Type**.
2. Open the **Condition** pop-up menu and select **Equal**.
3. Open the **Parameter 1** pop-up menu and select **Note**.
4. Click **+** below the list to add another condition line.
5. Open the **Filter Target** pop-up menu and select **Context Variable**.
6. Open the **Condition** pop-up menu and select **Bigger or Equal**.
7. Open the **Parameter 1** pop-up menu and select **Highest in Chord from at Least n Notes** or **Lowest in Chord from at Least n Notes**.
8. Open the **Parameter 2** pop-up menu and select how many notes a chord must contain to be taken into account.

Searching for Chords

You can search for chords in a MIDI part or on the chord track.

PREREQUISITE

NOTE

A note belongs to a chord if at least 2 other notes play at the same time.

PROCEDURE

1. Open the **Filter Target** pop-up menu and select **Context Variable**.
 2. Open the **Parameter 1** pop-up menu and select the property that you want to search for.
 3. Open the **Condition** pop-up menu and select an option.
-

Chords Filter

If the **Filter Target** is set to **Context Variable**, you can search for the following parameters:

Highest/Lowest/Average Pitch

Finds notes with the highest, lowest, or average pitch in the selected MIDI part.

Highest/Lowest/Average Velocity

Finds notes with the highest, lowest, or average velocity in the selected MIDI part.

Highest/Lowest/Average CC Value

Controllers with the highest, lowest, or average CC value in the selected MIDI part.

The following settings for **Parameter 1** require a **Parameter 2**:

Number of Notes in Chord (Part)

If you set **Parameter 2** to the number of notes in the chord, this finds chords with the specified number of notes in the selected MIDI part.

Number of Voices (Part)

If you set **Parameter 2** to the number of voices of the chord, this finds chords with the specified number of voices in the selected MIDI part.

Position in Chord (Part)

If you set **Parameter 2** to the position in the chord, this finds chords with the specified chord interval in the selected MIDI part.

Note Number in Chord (lowest = 0)

If you set **Parameter 2** to the voicing number of the chord, this finds chords with the specified voicing number in the selected MIDI part.

Position in Chord (Chord Track)

If you set **Parameter 2** to the position in the chord, this finds the specified chord interval in the selected MIDI part. The chord track is taken as reference.

Voice

If you set **Parameter 2** to the voice in the chord, this finds the specified voice in the selected MIDI part.

Highest in Chord from at Least n Notes

Finds the highest note of the chord in the selected MIDI part. Set **Parameter 2** to specify how many notes a chord must contain to be taken into account.

Lowest in Chord from at Least n Notes

Finds the lowest note of the chord in the selected MIDI part. Set **Parameter 2** to specify how many notes a chord must contain to be taken into account.

NOTE



The **Musical Context** presets give you an idea of the possibilities of this filter target.

RELATED LINKS

[Searching for Highest/Lowest Notes in Chords](#) on page 1108

Combining Multiple Condition Lines

You can add condition lines and combine them by using boolean **And** and **Or** operators and brackets.

- To add a new condition, click  below the list.
The new line is added at the bottom of the list.
- To remove a condition, select it and click  below the list.

Bool Column

In the **bool** column to the right in the list, you can select a boolean operator: **And** or **Or**.

A boolean operator combines 2 condition lines and determines the result in the following way:

- **And** determines that both conditions must be fulfilled for an element to be found.
- **Or** determines that at least one of the conditions must be fulfilled for an element to be found.

IMPORTANT

When you add a new condition line, its boolean setting default is **And**.

EXAMPLE

You can find elements that are notes and start at the beginning of the third bar.

(Filter Target	Condition	Parameter 1	Parameter 2	Bar Range/Time Base)	bool
(Type Is	Equal	Note)	And
	Position	Equal	3.01.01.000		PPQ)	

You can find all events that are notes (regardless of their position) and all events starting at the beginning of the third bar (regardless of their type).

(Filter Target	Condition	Parameter 1	Parameter 2	Bar Range/Time Base)	bool
(Type Is	Equal	Note)	Or
	Position	Equal	3.01.01.000		PPQ)	

Using Brackets

The bracket columns let you enclose 2 or more condition lines, dividing the conditional expression into smaller units. This is only relevant when you have 3 or more condition lines and want to use the boolean **Or** operator.

You add brackets by clicking in the bracket columns and selecting an option. Up to triple brackets can be selected.

If you add several layers of brackets, these are evaluated from the inside out, starting with the innermost brackets.

Expressions within brackets are evaluated first.

EXAMPLE

You can find all MIDI notes with the pitch C3, as well as all events (regardless of their type) set to MIDI channel 1.

(Filter Target	Condition	Parameter 1	Parameter 2	Bar Range/Time Base)	bool
(Type Is	Equal	Note)	And
	Pitch	Equal	C3)	Or
	Channel	Equal	1)	

You can find all notes that either have the pitch C3 or the MIDI channel 1 (but no non-note events).

(Filter Target	Condition	Parameter 1	Parameter 2	Bar Range/Time Base)	bool
	Type Is	Equal	Note)	And
(Pitch	Equal	C3)	Or
	Channel	Equal	1)	

Selecting a Function

The pop-up menu at the bottom of the **Logical Editor** is where you select the function, that is, the basic type of editing to be performed.

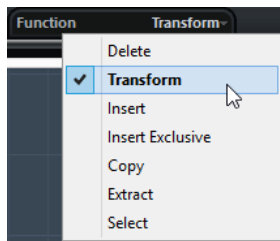

Delete

Deletes all elements found by the **Logical Editor**.

Transform

Changes one or several aspects of the found elements. You set up exactly what is changed in the action list.

Insert

Creates new elements and inserts these into the parts. The new elements will be based on the elements found by the filter conditions, but with any changes you have set up in the action list applied.

Another way of expressing this is that the **Insert** function copies the found elements, transforms them according to the action list and inserts the transformed copies among the existing elements.

Insert Exclusive

Transforms the found elements according to the action list. All elements that do not meet the filter conditions are deleted.

Copy

Copies all found elements, transforms them according to the action list, and pastes them into a new part on a new MIDI track. The original events are not affected.

Extract

Transforms all found events and moves them to a new part on a new MIDI track.

Select

Selects all found events and highlights them for further work in the regular MIDI editors.

RELATED LINKS

[Specifying Actions](#) on page 1112

Specifying Actions

You can specify actions, that is, changes that are made to the found elements, in the lower list of the **Logical Editor**. Actions are relevant for all function types except **Delete** and **Select**.

Action Target	Operation	Parameter 1	Parameter 2
Value 1	Set to fixed value		2

You can add action lines by clicking , and remove them by selecting it and clicking .

Action Target

The **Action Target** allows you to select the property that is changed in the events.

Position

Moves the events.

Length

Resizes note events.

Value 1

Adjusts value 1 in the events. What is displayed for value 1 depends on the event type. For notes, value 1 is the pitch.

Value 2

Adjusts value 2 in the events. What is displayed for value 2 depends on the event type. For notes, value 2 is the velocity value.

Channel

Allows you to change the MIDI channel setting.

Type

Allows you to change the event type, that is, transform aftertouch events to modulation events, or pitchbend events to VST 3 Tuning events.

Value 3

Adjusts value 3 in the events, which is used for handling of Note-off velocity when searching for properties.

NoteExp Operation

Allows you to specify a note expression operation in the **Operation** column.

VST 3 Value Operation

Allows you to perform common operations within the VST 3 value range (0.0 to 1.0) instead of the standard MIDI value range (0-127) for finer adjustments.

NOTE

The **Position** and **Length** parameters are interpreted via the time base setting in the **Bar Range/Time Base** column, with the exception of the **Random** setting, which uses the time base of the affected events.

RELATED LINKS

[Searching for Properties](#) on page 1107

[Value 1 and Value 2](#) on page 1105

Operation

The **Operation** column allows you to determine what to do with the **Action Target**.

The options on this pop-up menu are different depending on the selected **Action Target**.

Add

Adds the value specified in the **Parameter 1** column to the **Action Target**.

Subtract

Subtracts the value specified in the **Parameter 1** column from the **Action Target**.

Multiply by

Multiplies the **Action Target** with the value specified in the **Parameter 1** column.

Divide by

Divides the **Action Target** by the value specified in the **Parameter 1** column.

VST 3 Value Operation – Invert

Inverts note expression data containing the specified VST 3 event parameter.

Round by

Rounds the **Action Target** value using the value specified in the **Parameter 1** column.

Set Random Values between

Sets the **Action Target** value to a random value within the range specified with **Parameter 1** and **Parameter 2**.

Set to fixed value

Sets the **Action Target** to the value specified in the **Parameter 1** column.

Set Relative Random Values between

Adds a random value to the current **Action Target** value. The added random value will be within the range specified with **Parameter 1** and **Parameter 2**. Note that these can be set to negative values.

Add Length

This is only available if you set **Action Target** to **Position**. Furthermore, it is only valid if the found events are notes. If you select **Add Length**, the length of each note event is added to the **Position** value.

Transpose to Scale

This is only available if you set **Action Target** to **Value 1**, and if the filter conditions are specifically set up to find notes (a **Type = Note** filter condition line has been added). When **Transpose to Scale** is selected, you can specify a musical scale using the **Parameter 1** and **Parameter 2** columns. **Parameter 1** is the key (C, C#, D, etc.) while **Parameter 2** is the type of scale (major, melodic or harmonic minor, etc.).

Each note will be transposed to the closest note in the selected scale.

Use Value 2

This is only available if you set **Action Target** to **Value 1**. If this option is selected, the **Value 2** setting in each event will be copied to the **Value 1** setting.

Use Value 1

This is only available if you set **Action Target** to **Value 2**. If this option is selected, the **Value 1** setting in each event will be copied to the **Value 2** setting.

Mirror

This is only available if you set **Action Target** to **Value 1** or **Value 2**. When this option is selected, the values are mirrored around the value set in the **Parameter 1** column.

In the case of notes, this inverts the scale, with the key set in the **Parameter 1** column as center point.

Linear Change in Loop Range

This affects events between the left and right locators only. It creates a linear ramp of values (replacing the original values) starting at the value in the **Parameter 1** column and ending at the **Parameter 2** value.

Relative Change in Loop Range

This creates a ramp of values, affecting events in the loop range only, that is, between the locators. However, here the changes are relative, meaning that values will be added to the existing values.

In other words, you set up a value ramp starting at **Parameter 1** and ending at **Parameter 2** (note that the values can be negative). The resulting value ramp is then added to the existing values for the events within the loop range.

For example, if you apply this to note velocities with **Parameter 1** set to 0 and **Parameter 2** set to -100, you create a velocity fade-out, keeping the original velocity relations:

(Filter Target	Condition	Parameter 1	Parameter 2	Bar Range/Time Base)	bool
	Type Is	Equal	Note				
+							
-							
Action Target	Operation	Parameter 1	Parameter 2				
Value 1	Relative Change in Loop Range	0	-100				

NoteExp Operation – Remove Note Expression

This option is only available for notes. It allows you to remove all note expression data from a note.

NoteExp Operation – Create One-Shot

This option is only available for notes. It allows you to add note expression data for notes in **One Shot** mode, meaning that you add a parameter as note expression data. After having added the one-shot parameter, you have to set it to the desired value in a second go.

NoteExp Operation – Reverse

Reverses the note expression data.

RELATED LINKS

[Value 1 and Value 2](#) on page 1105

Applying the Defined Actions

Once you have set up filter conditions, selected a function, and set the required actions or loaded a preset, you apply the actions defined with the **Logical Editor** by clicking the **Apply** button.

IMPORTANT

The MIDI insert effect **Transformer** does not feature an **Apply** button. Here, the current settings are automatically applied in real time during playback or live playing.

Logical Editor operations can be undone just like any other editing.

Presets

You can load, save and manage **Logical Presets**.

To load a preset, do one of the following:

- Open the **Logical Editor**, and open the **Select Preset** pop-up menu, and select an option.
- Select **MIDI > Logical Presets**, and select an option.
- Open the **List Editor**, and in the filters bar, select a preset from the **Show** section.

NOTE

If you set up a key command for a preset, you can conveniently apply the same operation to several selected events in one go.

RELATED LINKS

[Key Commands](#) on page 1313

Storing Your Own Settings as a Preset

You can save settings that you want to use again as presets.

PROCEDURE

1. In the section in the upper left of the **Logical Editor**, click **Store Preset**.
 2. In the dialog that opens, specify a name for the preset and click **OK**.
-

RESULT

The preset is stored.

NOTE

To remove a preset, load it and click **Remove Preset**.

Organizing and Sharing Presets

The **Logical Editor** presets are stored within the application folder in the **Presets\Logical Edit Project** subfolder.

Preset files cannot be edited manually, but you can reorganize them. This also makes it easy to share presets with other Nuendo users by transferring the individual preset files.

NOTE

The list of presets is read each time the **Logical Editor** is opened.

Project Logical Editor

The **Project Logical Editor** is a powerful tool for search and replace functions in the **Project** window.

The **Project Logical Editor** allows you to specify filter conditions and combine them with actions. This way you can search for all open folder tracks in your project, for example, and close them.

It comes with a number of presets that show you the possibilities of this feature, and that you can use as a starting point for your own settings.

RELATED LINKS

[Presets](#) on page 1130

[Project Logical Editor Window Overview](#) on page 1116

Project Logical Editor Window Overview

The **Project Logical Editor** window allows you to combine filter conditions, functions, actions, and macros to perform very powerful processing.

- To open the **Project Logical Editor**, select **Project > Project Logical Editor**.

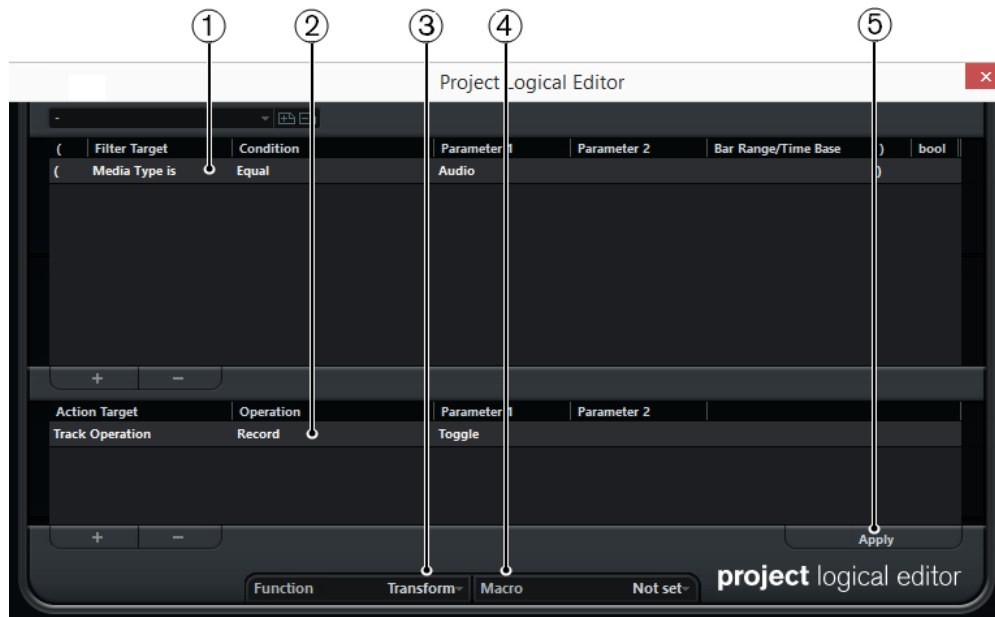

1 Filter Conditions

Allow you to specify the conditions such as type, attribute, value, position, that a specific element must meet to be found. You can combine any number of filter conditions using And/Or operators.

2 Action List

Allows you to set up a list of actions that specifies exactly what is done. This is not necessary for all functions.

3 Function pop-up menu

Allows you to select if the found elements are transformed, deleted, or selected.

4 Macro pop-up menu

Allows you to select a macro.

5 Apply

Applies your settings.

IMPORTANT

Not every combination of settings always makes sense. Experiment a bit before applying your edits to important projects.

NOTE

You can undo the operations by selecting **Edit > Undo**.

RELATED LINKS

[Presets](#) on page 1130

Filter Conditions

By setting up filter conditions you can determine which filter target, that is, what elements, you want to find.

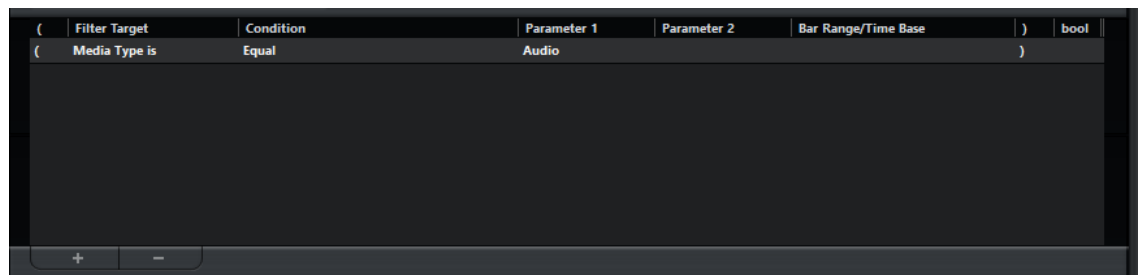

To set up a filter condition, make the following settings:

Filter Target

Sets the property of the element. This setting affects the available options in the other columns.

Condition

Determines how the **Project Logical Editor** compares the property in the **Filter Target** column to the values in the **Parameter** columns. The available options depend on the **Filter Target** setting.

Parameter 1

Sets which value the element properties are compared to. This depends on the **Filter Target**.

Parameter 2

Only available if one of the **Range** options is set in the **Condition** column. Allows you to find all elements with values inside or outside the range between **Parameter 1** and **Parameter 2**.

Bar Range/Time Base

Only available if the **Filter Target** is set to **Position**. If one of the **Bar Range** options is selected in the **Condition** column, you use the **Bar Range/Time Base** column to specify zones within each bar. This allows you to find all elements on or around the first beat of every bar, for example. If any of the other **Condition** options is selected, you can use the **Bar Range/Time Base** column to specify a time base such as PPQ, seconds, etc.

Left bracket

Together with the right bracket, this allows you to combine multiple filter conditions, that is, multiple lines with the boolean operators And/Or.

Right bracket

Together with the left bracket, this allows you to combine several filter conditions.

bool

Allows you to insert the boolean operators And/Or, when creating conditions with multiple lines.

NOTE

If you make a mistake when combining multiple conditions with brackets, you are informed in the status line.

NOTE

If you have already defined filter conditions and/or applied a preset, but want to start again from scratch, you can initialize the settings by selecting the **Init** option from the **Presets** pop-up menu.

RELATED LINKS

[Searching for Elements at Specific Positions](#) on page 1121

[Combining Multiple Condition Lines](#) on page 1125

Searching for Media Types

You can search for elements by their media type.

PROCEDURE

1. Open the **Filter Target** pop-up menu and select **Media Type**.
 2. Open the **Parameter 1** pop-up menu and select the media type that you want to search for.
 3. Open the **Condition** pop-up menu and select one of the following options:
 - Select **Equal** if you want to search for the specified media type.
 - Select **Unequal** if you want to search for any other media type than the specified.
 - Select **All Types** if you want to search for all media types.
-

Media Type Filter

When the **Filter Target** is set to **Media Type**, the pop-up menu lists the available media types.

Audio

If no container type is specified, this finds audio events, audio parts, and audio tracks.

MIDI

If no container type is specified, this finds MIDI parts and MIDI tracks.

Automation

If no container type is specified, this finds automation events and automation tracks.

Marker

If no container type is specified, this finds marker events and marker tracks.

Transpose

If no container type is specified, this finds transpose events and transpose tracks.

Arranger

If no container type is specified, this finds arranger events and arranger tracks.

Tempo

If no container type is specified, this finds tempo events and tempo tracks.

Signature

If no container type is specified, this finds signature events and signature tracks.

Chord

If no container type is specified, this finds chord events and chord tracks.

Scale Event

If no container type is specified, this finds scale events.

Video

If no container type is specified, this finds video events.

Group

If no container type is specified, this finds group tracks.

Effect

If no container type is specified, this finds FX channel tracks.

Device

If no container type is specified, this finds device tracks.

VCA

If no container type is specified, this finds VCA fader tracks.

For media types, the following **Condition** options are available:

Equal

This finds the media type set up in the **Parameter 1** column.

All Types

This finds all media types.

Searching for Container Types

PROCEDURE

1. Open the **Filter Target** pop-up menu and select **Container Type**.
 2. Open the **Parameter 1** pop-up menu and select the container type that you want to search for.
 3. Open the **Condition** pop-up menu and select one of the following options:
 - Select **Equal** if you want to search for the specified container type.
 - Select **Unequal** if you want to search for any other container type than the specified.
 - Select **All Types** if you want to search for all container types.
-

EXAMPLE

You can set up the **Project Logical Editor** to find all folder tracks in the project.

Filter Target	Condition	Parameter 1	Parameter 2	Bar Range/Time Base
Container Type is	Equal	FolderTrack		

Container Type Filter

When the **Filter Target** is set to **Container Type**, the **Parameter 1** pop-up menu lists the available container types.

Folder Track

This finds all folder tracks, included FX channel and group channel folders.

Track

This finds all track types.

Part

This finds audio, MIDI, and instrument parts. Folder parts will not be found.

Event

This finds automation points, markers, as well as audio, arranger, transpose, tempo, and time signature events.

For container types, the following **Condition** options are available:

Equal

This finds the container type set up in the **Parameter 1** column.

All Types

This finds all container types.

Combining Media Type and Container Type

The combination of the filter targets **Media Type** and **Container Type** represents a versatile tool for logical operations.

EXAMPLE

You can set up the **Project Logical Editor** to find all MIDI and instrument parts in the project.

Filter Target	Condition	Parameter 1	Parameter 2	Bar Range/Time Base	bool
(Media Type is	Equal	MIDI			And
Container Type is	Equal	Part)	

You can set up the **Project Logical Editor** to find all automation tracks (not events) in the project whose name contains **vol**.

Filter Target	Condition	Parameter 1	Parameter 2	Bar Range/Time Base	bool
(Media Type is	Equal	Automation			And
Container Type is	Equal	Track			And
Name	Contains	vol)	

You can set up the **Project Logical Editor** to find all MIDI and instrument parts (not tracks) in the project that are muted.

Filter Target	Condition	Parameter 1	Parameter 2	Bar Range/Time Base	bool
(Media Type is	Equal	MIDI			And
Container Type is	Equal	Part			And
Property	Not set	Event is muted)	

You can set up the **Project Logical Editor** to find all MIDI and instrument parts (not tracks) or all audio events (not parts or tracks) in the project that are muted.

Filter Target	Condition	Parameter 1	Parameter 2	Bar Range/Time Base	bool
((Media Type is	Equal	MIDI			And
Container Type is	Equal	Part)	Or
(Media Type is	Equal	Audio			And
Container Type is	Equal	Event)	And
Property	Property is not set	Event is muted)	

Searching for Names

PROCEDURE

1. Open the **Filter Target** value field and select **Name**.
 2. Click the **Parameter 1** pop-up menu and enter a name, or a part of a name that you want to search for.
 3. Open the **Condition** pop-up menu and select one of the following options:
 - Select **Equal** if you want to search for the exact name.
 - Select **Contains** if you want to search for a name that contains the specified name.
 - Select **Contains not** if you want to search any other name than the specified.
-

EXAMPLE

You can set up the **Project Logical Editor** to find all tracks in the project whose name contains **voc**.

(Filter Target	Condition	Parameter 1	Parameter 2	Bar Range/Time Base)	bool
(Container Type is	Equal	Track)	And
	Name	Contains	voc)	

Searching for Elements at Specific Positions

You can search for elements starting at specific positions, either relative to the start of the project or within each bar.

PROCEDURE

1. Open the **Filter Target** pop-up menu and select **Position**.
This allows you to find elements starting at specific positions, either relative to the start of the project or within each bar.
 2. Open the **Condition** pop-up menu and select one of the following options:
 - To find all elements at a specific position, select a position in the **Parameter 1** column. You can set a time base such as PPQ, seconds, samples, or frames in the **Bar Range/Time Base** column.
 - To find all elements inside or outside a range, select **Inside Bar Range** or **Outside Bar Range**.
You can set the bar range in the **Bar Range/Time Base** column by clicking and dragging in the bar display or by adjusting the start position of the range in the **Parameter 1** column and the end position in the **Parameter 2** column. You can change the time base in the **Bar Range/Time Base** column. The position for **Bar Range** is measured in ticks related to the start of the bar.
-

EXAMPLE

You can set up the **Project Logical Editor** to find all elements at the PPQ position 5.1.1. in the project.

(Filter Target	Condition	Parameter 1	Parameter 2	Bar Range/Time Base)	bool
(Position	Equal	5.01.01.000		PPQ)	

You can set up the **Project Logical Editor** to find elements starting around the second beat in each bar.

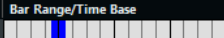
(Filter Target	Condition	Parameter 1	Parameter 2	Bar Range/Time Base)	bool
	Position	Inside Bar Range	419	541	)	

Position Filter

For positions, the following **Condition** options are available:

Equal

Has the exact same value as set up in the **Parameter 1** column.

Unequal

Has any value other than the one set up in the **Parameter 1** column.

Bigger

Has a value higher than the one set up in the **Parameter 1** column.

Bigger or Equal

Has a value that is the same as or higher than the one set up in the **Parameter 1** column.

Less

Has a value lower than the one set up in the **Parameter 1** column.

Less or Equal

Has a value that is the same as or lower than the one set up in the **Parameter 1** column.

Inside Range

Has a value that is between the values set up in the **Parameter 1** and **Parameter 2** columns. Note that **Parameter 1** should be the lower value and **Parameter 2** the higher.

Outside Range

Has a value that is not between the values set up in the **Parameter 1** and **Parameter 2** columns.

Inside Bar Range

Is within the zone set up in the **Bar Range/Time Base** column, in each bar within the current selection.

Outside Bar Range

Is outside the zone set up in the **Bar Range/Time Base** column, in each bar within the current selection.

Before Cursor

Is before the cursor position.

Beyond Cursor

Is after the cursor position.

Inside Track Loop

Is inside the set track loop.

Inside Cycle

Is inside the set cycle.

Exactly Matching Cycle

Exactly matches the set cycle.

Searching for Elements of Specific Lengths

PROCEDURE

1. Open the **Filter Target** pop-up menu and select **Length**.

This allows you to find elements of a specific length only.

NOTE

The **Length** parameter is interpreted via the time base setting in the **Bar Range/Time Base** column, that is, in PPQ, seconds, samples, or frames.

2. Open the **Parameter 1** pop-up menu and set the length that you want to search for.
3. Open the **Condition** pop-up menu and select an option.
If you select **Inside Range** or **Outside Range**, use **Parameter 1** and **Parameter 2** to set the start and the end of the range.

EXAMPLE

You can set up the **Project Logical Editor** to find all audio parts and events in the project with a length value below 200 samples.

(Filter Target	Condition	Parameter 1	Parameter 2	Bar Range/Time Base)	bool
	Container Type is	Equal	Part				Or
	Container Type is	Equal	Event				And
(Media Type is	Equal	Audio				And
	Length	Less	0200		Samples)	

RELATED LINKS

[Length Filter](#) on page 1123

Length Filter

For lengths, the following **Condition** options are available:

Equal

Has the exact same value as set up in the **Parameter 1** column.

Unequal

Has any value other than the one set up in the **Parameter 1** column.

Bigger

Has a value higher than the one set up in the **Parameter 1** column.

Bigger or Equal

Has a value that is the same as or higher than the one set up in the **Parameter 1** column.

Less

Has a value lower than the one set up in the **Parameter 1** column.

Less or Equal

Has a value that is the same as or lower than the one set up in the **Parameter 1** column.

Inside Range

Has a value that is between the values set up in the **Parameter 1** and **Parameter 2** columns. Note that **Parameter 1** should be the lower value and **Parameter 2** the higher.

Outside Range

Has a value that is not between the values set up in the **Parameter 1** and **Parameter 2** columns.

Searching for Color Names

PROCEDURE

1. Open the **Filter Target** pop-up menu and select **Color Name**.
 2. Click the **Parameter 1** value field and enter the color name for which you want to search.
 3. Open the **Condition** pop-up menu and select one of the following options:
 - Select **Equal** if you want to search for the exact color name.
 - Select **Contains** if you want to search for a color name that contains the specified color name.
 - Select **Contains not** if you want to search any other color name than the specified name.
-

Searching for Properties

PROCEDURE

1. Open the **Filter Target** pop-up menu and select **Property**.
 2. Open the **Parameter 1** pop-up menu and select the property that you want to search for.
 3. Open the **Condition** pop-up menu and select one of the following options:
 - Select **Property is set** if you want to search for events that have the specified property.
 - Select **Property is not set** if you want to search for events that do not have the specified property.
-

EXAMPLE

You can set up the **Project Logical Editor** to find all muted MIDI and instrument parts.

(Filter Target	Condition	Parameter 1	Parameter 2	Bar Range/Time Base)	bool
	Media Type is	Equal	MIDI				And
	Container Type is	Equal	Part				And
	Property	Property is set	Event is muted				

You can set up the **Project Logical Editor** to find all elements that are empty.

(Filter Target	Condition	Parameter 1	Parameter 2	Bar Range/Time Base)	bool
	Media Type is	Equal	Audio				And
	Container Type is	Equal	Part				And
	Property	Property is set	Event is selected				And
	Property	Property is set	Event is empty				

You can set up the **Project Logical Editor** to find all selected audio parts that are selected but not muted.

(Filter Target	Condition	Parameter 1	Parameter 2	Bar Range/Time Base)	bool
	Property	Property is set	Event is selected				And
	Property	Property is not set	Event is muted				

Properties Filter

For properties, the following **Condition** options are available:

Property is set

This finds all events that have the property that is set in the **Parameter 1** column.

Property is not set

This finds all events that do not have the property that is set in the **Parameter 1** column.

When the **Filter Target** is set to **Property**, the pop-up menu lists the available **Parameter 1** properties.

Event is muted

This finds all muted events.

Event is selected

This finds all selected events.

Event is empty

This finds all empty events.

Event inside NoteExp

This finds all events that form part of Note Expression automation data. These can be VST 3 or MIDI controller events.

Event is valid VST 3

This finds all VST 3 events in a note that are valid. This means that the corresponding track is routed to an instrument that supports them.

Is Hidden

This finds all hidden tracks.

Has Track Version

This finds all tracks that have track versions.

Follows Chord Track



This finds all tracks that follow the chord track.

Is Disabled

This finds all disabled tracks.

Combining Multiple Condition Lines

You can add condition lines and combine them by using boolean **And** and **Or** operators and brackets.

- To add a new condition, click  below the list. The new line is added at the bottom of the list.
- To remove a condition, select it and click  below the list.

Bool Column

In the **bool** column to the right in the list, you can select a boolean operator: **And** or **Or**.

A boolean operator combines 2 condition lines and determines the result in the following way:

- **And** determines that both conditions must be fulfilled for an element to be found.
- **Or** determines that at least one of the conditions must be fulfilled for an element to be found.

IMPORTANT

When you add a new condition line, the boolean setting default is **And**.

EXAMPLE

You can set up the **Project Logical Editor** to find MIDI tracks.

(Filter Target	Condition	Parameter 1	Parameter 2	Bar Range/Time Base)	bool
	Media Type is	Equal	MIDI				And
	Container Type is	Equal	Track				

You can set up the **Project Logical Editor** to find all parts or events that match exactly the cycle.

(Filter Target	Condition	Parameter 1	Parameter 2	Bar Range/Time Base)	bool
	Container Type is	Equal	Part				Or
	Container Type is	Equal	FolderTrack				And
	Position	Exactly Matching Cycle			PPQ		

Using Brackets

The bracket columns let you enclose 2 or more condition lines, dividing the conditional expression into smaller units. This is only relevant when you have 3 or more condition lines and want to use the boolean **Or** operator.

You can add brackets by clicking in the bracket columns and selecting an option. Up to triple brackets can be selected.

If you add several layers of brackets, these are evaluated from the inside out, starting with the innermost brackets.

Expressions within brackets are evaluated first.

EXAMPLE

You can set up the **Project Logical Editor** to find all audio parts and events whose name contains **perc** as well as other MIDI parts and events whose name contains **drums**.

(Filter Target	Condition	Parameter 1	Parameter 2	Bar Range/Time Base)	bool
	Media Type is	Equal	Audio				And
	Name	Contains	perc				Or
	Name	Contains	drums				

You can set up the **Project Logical Editor** to find all audio parts or events whose name contains **perc** or **drums**.

(Filter Target	Condition	Parameter 1	Parameter 2	Bar Range/Time Base)	bool
	Media Type is	Equal	Audio				And
(Name	Contains	perc				Or
	Name	Contains	drums)	

Specifying Actions

You can specify actions, that is, changes that are made to the found elements, in the lower list of the **Project Logical Editor**. Actions are only relevant for the function type **Transform**.

Action Target	Operation	Parameter 1	Parameter 2
Track Operation	Record	Toggle	

You can perform the following action types:

- Track-based actions, such as **Track Operation, Name**.
- Event-based actions, such as **Position, Length, Name**.
- Actions that only take effect on automation data, such as **Trim**.

You can add action lines by clicking **+**, and remove them by selecting it and clicking **-**.

Action Target

The **Action Target** allows you to select the property that is changed.

Position

Adjusting the **Position** value moves the elements.

This parameter is interpreted via the time base setting in the **Bar Range/Time Base** column, with the exception of the **Random** setting, which uses the time base of the affected events:

Add

Adds the value specified in the **Parameter 1** column to the **Position**.

Subtract

Subtracts the value specified in the **Parameter 1** column from the **Position**.

Multiply by

Multiplies the **Position** value with the value specified in the **Parameter 1** column.

Divide by

Divides the **Position** value by the value specified in the **Parameter 1** column.

Round by

This rounds the **Position** value using the value specified in the **Parameter 1** column. In other words, the **Position** value is changed to the closest value that can be divided by the **Parameter 1** value.

Set relative Random Values between

This will add a random value to the current **Position** value. The added random value will be within the range specified with **Parameter 1** and **Parameter 2**. Note that these can be set to negative values.

Set to fixed value

This sets the position to the value specified in the **Parameter 1** column.

Length

Adjusting the **Length** value allows you to resize the elements.

This parameter is interpreted via the time base setting in the **Bar Range/Time Base** column, with the exception of the **Random** setting, which uses the time base of the affected events:

Add

Adds the value specified in the **Parameter 1** column to the **Length**.

Subtract

Subtracts the value specified in the **Parameter 1** column from the **Length**.

Multiply by

Multiplies the **Length** value with the value specified in the **Parameter 1** column.

Divide by

Divides the **Length** value by the value specified in the **Parameter 1** column.

Round by

This rounds the **Length** value using the value specified in the **Parameter 1** column. In other words, the **Length** value is changed to the closest value that can be divided by the **Parameter 1** value.

Set to fixed value

This sets the **Length** to the value specified in the **Parameter 1** column.

Set Random Values between

This will add a random value to the current length. The added random value will be within the range specified with **Parameter 1** and **Parameter 2**.

Track Operation

Adjusting the **Track Operation** value allows you to change the track status.

NOTE

Track operations may also affect automation tracks. This may lead to unexpected results, especially if you use the **Toggle** action.

Folder

Opens, closes, or toggles folders.

Record

Enables, disables, or toggles the record enable status.

Monitor

Enables, disables, or toggles the monitor status.

Solo

Enables, disables, or toggles the solo status.

Mute

Enables, disables, or toggles the mute status.

Read

Enables, disables, or toggles the read enable status.

Write

Enables, disables, or toggles the write enable status.

EQ Bypass

Enables, disables, or toggles the EQ bypass status.

Inserts Bypass

Enables, disables, or toggles the inserts bypass status.

Sends Bypass

Enables, disables, or toggles the sends bypass status.

Lanes Active

Enables, disables, or toggles the lanes active status.

Hide Track

Enables, disables, or toggles the track visibility status.

Time Domain

Sets the track time domain to **Musical** or **Linear**, or toggles the status.

Name

Adjusting the **Name** value allows you to rename the found elements.

Replace

Replaces names with the text specified in the **Parameter 1** column.

Append

The name will be appended with the string specified in the **Parameter 1** column.

Prepend

The name will be prepended with the string specified in the **Parameter 1** column.

Generate Name

The name will be replaced by the text specified in the **Parameter 1** column, followed by the number set with **Parameter 2**. The number will be increased by 1 for every found element.

Replace Search String

You can specify a search string under **Parameter 1** that is replaced by the text specified in the **Parameter 2** column.

Trim

Adjusting the **Trim** value allows you to trim the found elements. This is used for automation only.

Multiply by

Multiplies the **Trim** value with the value specified in the **Parameter 1** column.

Divide by

Divides the **Trim** value by the value specified in the **Parameter 1** column.

Set Color

Adjusting the **Set Color** value allows you to set the color for an element.

For this **Action Target**, the only available option is **Set to fixed value**. To set a specific color, click the **Parameter 1** column and select the item in the pop-up menu.

Selecting a Function

The left pop-up menu at the bottom of the **Project Logical Editor** is where you select the function – the basic type of editing to be performed.

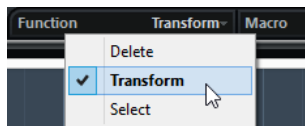

The available options are:

Delete

Deletes all elements found by the **Project Logical Editor**.

NOTE

When you delete automation tracks and undo this operation by selecting **Undo** from the **Edit** menu, the automation tracks will be restored, but the tracks will be closed.

Transform

Changes one or several aspects of the found elements. You set up exactly what is changed in the action list.

Select

This will simply select all found elements, highlighting them for further work in the **Project** window.

Applying Macros

In the **Macro** pop-up menu, you can select a macro that will be executed automatically after completing the actions defined.

To use this, you set up the macro that you need in the **Key Commands** dialog and then select it in the **Project Logical Editor** from the **Macro** pop-up menu.

RELATED LINKS

[Key Commands](#) on page 1313

Applying the Defined Actions

Once you have set up filter conditions, selected a function and set the required actions or loaded a preset, you apply the actions defined with the **Project Logical Editor** by clicking the **Apply** button.

Project Logical Editor operations can be undone just like any other editing.

Presets

The section in the upper left section of the window allows you to load, save and manage **Project Logical Editor** presets.

To load a preset, do one of the following:

- Open the **Select Preset** pop-up menu, and select an option.
- Select **Project > Apply Project Logical Editor Preset**, and select an option.

NOTE

If you set up a key command for a preset, you can conveniently apply the same operation to several selected events in one go.

RELATED LINKS

[Key Commands](#) on page 1313

Storing Your Own Settings as Presets

You can save settings that you want to use again as presets.

PROCEDURE

1. In the section in the upper left of the **Project Logical Editor**, click **Store Preset**.
 2. In the dialog that opens, specify a name for the preset and click **OK**.
-

RESULT

The preset is stored.

NOTE

To remove a preset, load it and click the **Remove Preset** button.

Organizing and Sharing Presets

The **Project Logical Editor** presets are stored within the application folder in the **Presets\Logical Edit Project** subfolder.

Preset files cannot be edited manually, but you can reorganize them. This also makes it easy to share presets with other Nuendo users, by transferring the individual preset files.

NOTE

The list of presets is read each time the **Project Logical Editor** is opened.

Setting up Key Commands for Your Presets

If you have stored **Project Logical Editor** presets, you can set up key commands for them.

PROCEDURE

1. Select **Edit > Key Commands**.
 2. In the **Commands** column, navigate to the category **Process Logical Preset** and click the plus sign to display the items in the folder.
 3. In the list, select the item to which you want to assign a key command, click in the **Type in Key** field and enter a new key command.
 4. Click the **Assign** button above the field.
The new key command is shown in the **Keys** list.
 5. Click **OK**.
-

RELATED LINKS

[Key Commands](#) on page 1313

Editing Tempo and Time Signature

You can set up a tempo and time signature for your project. By default, the tempo is set to 120 bpm, and the time signature to 4/4.

Project Tempo Modes

For every project you can set a tempo mode, depending on whether your music has a fixed tempo or if it changes throughout the project.

On the **Transport** panel, you can set the following tempo modes:

- **Fixed Tempo Mode**

If you want to work with one fixed tempo that does not change throughout the project, deactivate **Activate Tempo Track** on the **Transport** panel. You can change the tempo value to set a fixed rehearsal tempo.



- **Tempo Track Mode**

If the tempo of your music contains tempo changes, activate **Activate Tempo Track** on the **Transport** panel. You can change the tempo value to change the tempo at the cursor. If your project does not contain any tempo changes, the tempo is changed at the project start.

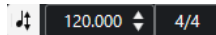

RELATED LINKS

[Setting up Projects for Tempo Changes](#) on page 1137

Track Time Base

The time base of a track determines if a track can follow the tempo changes of a project that is set to tempo track mode.

In the **Inspector** for MIDI tracks, instrument tracks, and audio-related tracks, you can activate/deactivate **Toggle Time Base** to switch the track time base.

The following time base modes are available:

- **Musical**

Use this mode for material with a musical, that is, tempo-related time base. All tracks that are set to musical time base follow any tempo changes that you add on the tempo track.

NOTE

For audio events on audio tracks that are set to musical time base, the tempo changes on the tempo track affect only the start position and not the actual audio.

- **Linear**

Use this mode for material with a linear, time-related time base.

RELATED LINKS

[Instrument Track Inspector](#) on page 134

[MIDI Track Inspector](#) on page 140

[Audio Track Inspector](#) on page 130

Tempo Track Editor

The **Tempo Track Editor** provides an overview of the project tempo settings. It allows you to add and edit tempo events.

To open the **Tempo Track Editor**, do one of the following:

- Select **Project > Tempo Track**.
- Press **Ctrl/Cmd - T**.

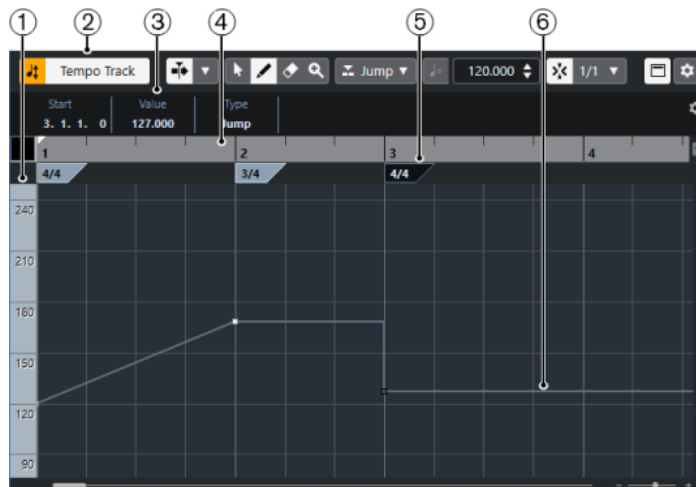

The **Tempo Track Editor** is divided into several sections:

- 1 Tempo scale**
Shows the tempo scale in BPM.
- 2 Toolbar**
Contains tools for selecting, adding, and changing tempo and time signature events.
- 3 Info line**
Shows information about the selected tempo or time signature event.
- 4 Ruler**
Shows the timeline and the display format of the project.
- 5 Time signature display**
Shows the time signature events in the project.
- 6 Tempo curve display**
If your project is set to a fixed tempo, only one tempo event and a fixed tempo is shown.
If your project is set to tempo track mode, the curve display shows the tempo curve with the tempo events in the project.

Tempo Track Editor Toolbar

The toolbar contains tools for selecting, adding, and changing tempo and time signature events.

The following tools are available:

Activate Tempo Track

Activate Tempo Track



Switches the project tempo between fixed tempo mode and tempo track mode.

Left Divider

Left Divider

Tools that are placed to the left of the divider are always shown.

Auto-Scroll

Auto-Scroll



Keeps the project cursor visible during playback.

Select Auto-Scroll Settings



Allows you to activate **Page Scroll** or **Stationary Cursor** and to activate **Suspend Auto-Scroll When Editing**.

Tool Buttons

Object Selection



Selects events.

Draw



Draws events.

Erase



Deletes events.

Zoom



Zoom in. Hold **Alt/Opt** and click to zoom out.

New Tempo Type

Type of New Tempo Points

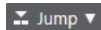

Allows you to select the type of new tempo points. Select **Ramp** if you want new tempo points to change gradually from the previous curve point to the new one. Select **Step** if you want new tempo points to change instantly. Select **Automatic** if new tempo points should have the same type as the previous curve point.

Current Tempo

Current Tempo

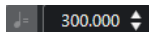

In fixed tempo mode, this allows you to change the current tempo.

Snap

Snap On/Off



Restricts horizontal movement and positioning to the positions specified by the **Snap Type**. Time signature events always snap to the beginning of bars.

Snap Type



Allows you to specify to what positions you want events to snap.

Tempo Recording

Open Tempo Recording Panel



Opens a panel that allows you to record tempo changes.

Process Tempo

Open Process Tempo Dialog

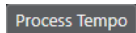

Opens the **Process Tempo** dialog.

Open Process Bars Dialog

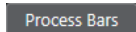

Opens the **Process Bars** dialog.

Right Divider

Right Divider

Tools that are placed to the right of the divider are always shown.

Show Info Line

Show/Hide Info



Opens/Closes the info line.

Set up Toolbar

Set up Toolbar



Opens a pop-up menu where you can set up which toolbar elements are visible.

Tempo Track

You can use the tempo track to create tempo changes within a project.

- To add a tempo track to your project, select **Project > Add Track > Tempo**.
- You can use the tools on the **Project** window toolbar to add and edit tempo events.
- You can use the tempo event editor to edit selected tempo events.
- To select a tempo event, click it with the **Object Selection** tool.

- To select multiple events, drag a selection rectangle with the **Object Selection** tool or **Shift**-click the events.
- To select all tempo events on the tempo track, right-click the tempo track and select **Select All Events** from the context menu.

RELATED LINKS

[Tempo Track Inspector](#) on page 163

[Tempo Track Controls](#) on page 164

Tempo Event Editor

The tempo event editor allows you to edit selected events on the tempo track.

- To open the tempo event editor, activate the **Object Selection** tool and drag a selection rectangle on the tempo track.

The tempo event editor features the following smart controls for specific editing modes:

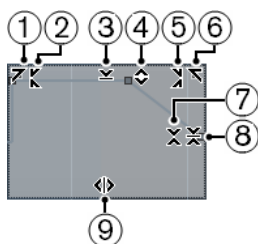

1 Tilt Left

If you click in the upper left corner of the editor, you can tilt the left part of the curve. This allows you to tilt the event values at the start of the curve upwards or downwards.

2 Compress Left

If you **Alt/Opt**-click in the upper left corner of the editor, you can compress or expand the left part of the curve. This allows you to compress or expand the event values at the start of the curve.

3 Scale Vertically

If you click in the middle of the upper border of the editor, you can scale the curve vertically. This allows you to raise or lower the event values of the curve in percent.

4 Move Vertically

If you click on the upper border of the editor, you can move the entire curve vertically. This allows you to raise or lower the values of the event values of the curve.

5 Compress Right

If you **Alt/Opt**-click in the upper right corner of the editor, you can compress or expand the right part of the curve. This allows you to compress or expand the event values at the end of the curve.

6 Tilt Right

If you click in the upper right corner of the editor, you can tilt the right part of the curve. This allows you to tilt the event values at the end of the curve upwards or downwards.

7 Scale Around Relative Center

If you **Alt/Opt**-click in the middle right border of the editor, you can scale the curve relative to its center. This allows you to raise or lower the event values horizontally around the center of the editor.

8 Scale Around Absolute Center

If you click in the middle right corner of the editor, you can scale the curve absolute to its center. This allows you to raise or lower the event values horizontally around the center of the editor.

9 Stretch

If you click on the lower border of the editor, you can stretch the curve horizontally. This allows you to move the event values of the curve to the left or to the right.

Tempo Changes for Projects

If the tempo track is activated, you can set up tempo changes for your project.

IMPORTANT

If your project is set to tempo track mode and you set up tempo changes, only tracks that are set to musical time base follow the tempo changes.

NOTE

If you work in tempo track mode, make sure that the display format in the **Project** window ruler is set to **Bars+Beats**. Otherwise, you may get confusing results.

If you activate **Activate Tempo Track** on the **Transport** panel, the tempo track curve is displayed in the tempo curve display.

If you know the tempo of your music, you can adjust the tempo value as follows:

- By adding tempo events in the **Tempo Track Editor**.
- By recording tempo changes with the **Tempo Recording** panel in the **Tempo Track Editor**.
- By adding tempo events on the tempo track.
- By importing tempo tracks.

If you do not know the tempo of your music, Nuendo offers tools to calculate and set it:

- **Tempo Detection Panel**
- **Time Warp** tool
- **Process Bars** dialog
- **Process Tempo** dialog

RELATED LINKS

[Setting up Projects for Tempo Changes](#) on page 1137

Setting up Projects for Tempo Changes

When you create a new project, the project tempo is automatically set to fixed tempo mode. If your music contains tempo changes, you must set your project to tempo track mode.

PROCEDURE

- To set your project to tempo track mode, do one of the following:
 - On the **Transport** panel, activate **Activate Tempo Track**.
 - Select **Project > Tempo Track** and activate **Activate Tempo Track**.

RESULT

The project tempo is now set up to follow the tempo track.

All tracks that are set to musical (tempo-related) time base follow any tempo changes that you add on the tempo track.

RELATED LINKS

- [Track Time Base](#) on page 1132
- [Tempo Track Controls](#) on page 164
- [Tempo Track Editor](#) on page 1133

Setting up a Tempo Track by Adding Tempo Changes

PROCEDURE

1. Select **Project > Add Track > Tempo**.
The tempo track is added to the track list.
2. On the tempo track, open the **Type of New Tempo Points** pop-up menu and select an option.
3. Do one of the following:
 - On the toolbar, select the **Object Selection** tool and click the tempo curve.
 - On the toolbar, select the **Draw** tool, and click and draw in the tempo curve display.

NOTE

If **Snap** is activated, this determines at which time positions you can insert tempo curve points.

RESULT

The tempo event is added to the tempo curve.

Setting up a Tempo Track by Recording Tempo Changes

You can set up a complete tempo track by recording tempo changes. This is useful if you want to create natural sounding ritardandos, for example.

PROCEDURE

1. Open the project for which you want to set up a tempo track and start playback.
 2. Select **Project > Tempo Track**.
 3. On the **Tempo Track Editor** toolbar, use the **Tempo Recording** panel to add tempo changes on the fly.
By moving the slider to the right, you can raise the project tempo, by moving it to the left, you can lower it.
-

RESULT

The tempo changes are recorded and added to the tempo curve in the **Tempo Track Editor**.

RELATED LINKS

- [Tempo Track Editor Toolbar](#) on page 1133

Setting up a Tempo Track from Tapping

You can create a complete tempo track based on tapping the tempo of freely recorded audio or MIDI material.

PREREQUISITE

You have opened a project with a freely recorded audio or MIDI file. You have added an instrument track and loaded an instrument. You have connected and set up a MIDI keyboard.

PROCEDURE

1. In the instrument track **Inspector**, deactivate **Toggle Time Base** to set the track time base to linear.
 2. On the instrument track, activate **Record Enable**.
 3. On the **Transport** panel, activate **Record**.
 4. On the MIDI keyboard, tap the tempo by hitting a key to the beat of your music.
 5. Stop recording and play back the recorded MIDI notes together with the original recording to check if the timing is correct.
 6. Do one of the following:
 - Select the MIDI part in the **Project** window.
 - Open the MIDI part in the **Key Editor** and select the notes that you want to use for the calculation.
 7. Select **MIDI > Functions > Merge Tempo From Tapping**.
 8. Open the **Tapping** pop-up menu to specify what type of note you tapped during the recording.
 9. Optional: To start the calculation of the tempo curve at the beginning of a bar, activate **Begin at Bar Start**.
 10. Click **OK**.
-

RESULT

The project tempo is set to the tapped tempo.

AFTER COMPLETING THIS TASK

Open the **Tempo Track Editor** to see and edit the new tempo curve.

RELATED LINKS

[Setting up All MIDI Inputs](#) on page 25

Setting up a Tempo Track from Tempo Detection

You can set up a complete tempo track using the result of a tempo detection for an audio event or a MIDI part.

PROCEDURE

1. In the **Project** window, select the audio event or the MIDI part that you want to analyze.
 2. Select **Project > Tempo Detection**.
 3. On the **Tempo Detection Panel**, click **Analyze**.
-

RESULT

- A tempo track is added to the project. On the tempo track, tempo events are created based on the analysis for the selected audio event or MIDI part.
- A signature track is added to the project. On the signature track, a signature event with the value 1/4 is added.
- On the **Project** window toolbar, the **Time Warp** tool is selected.

AFTER COMPLETING THIS TASK

Depending on the rhythmic quality of the material, the analysis may instantly lead to a perfect result. You can verify the quality of the analysis by activating the metronome click on the **Transport** panel, and playing back the project. To correct the result manually, use the functions on the **Tempo Detection Panel**.

RELATED LINKS

[Tempo Detection Panel](#) on page 1144

[Correcting the Tempo Analysis Manually](#) on page 1140

Correcting the Tempo Analysis Manually

If your music contains sections that are played in a different tempo or with special rhythmic characteristics, for example, you must adjust the tempo events manually.

PREREQUISITE

You have analyzed your material and the **Tempo Detection Panel** is still open. The metronome click is activated.

PROCEDURE

1. Play back the track with the analyzed material from the beginning and listen to the click.
2. Optional: If you work with an audio event, zoom in on the waveform so that you can compare the transients with the tempo events on the tempo track.
3. Optional: If the first tempo event that is not placed correctly is located at the beginning of the material, click the left arrow button on the **Tempo Detection Panel** to change the direction of the reanalysis.
4. Select the **Time Warp** tool and move the first tempo event that is not placed correctly to the correct position.

RESULT

The material is reanalyzed and the tempo recalculated.

AFTER COMPLETING THIS TASK

Continue listening to the material and correcting tempo events until the end. Close the **Tempo Detection Panel**.

NOTE

If your material includes multiple sections with different tempos, you can also split the material at each major tempo change and perform a tempo detection for every single resulting section. Each section must have a length of at least 7 seconds.

Editing Tempo Events

In the **Tempo Track Editor**, you can edit selected tempo events.

Use the following methods:

- With the **Object Selection** tool, click and drag horizontally and/or vertically.
- On the info line, adjust the tempo value in the **Value** field.

NOTE

When editing tempo events on tempo curves, make sure that the display format in the **Project** window ruler is set to **Bars+Beats**. Otherwise, you may get confusing results.

Use the following methods to remove tempo events:

- With the **Erase** tool, click the tempo event.
- Select the tempo event and press **Backspace**.

NOTE

You cannot remove the first tempo event.

Use the following method to change the tempo curve type:

- On the info line, adjust the tempo curve type in the **Type** field.

Adjusting the Tempo of a Range

You can adjust the tempo of a range to match a specific length or end time.

PROCEDURE

1. Set the left and right locator to specify the start and the end of the range you want to adjust.
 2. Select **Project > Tempo Track**.
 3. Click **Open Process Tempo Dialog**.
 4. Open the **Time Display Format** pop-up menu and select a time display format for the new range.
 5. In the **New Range** section, enter a new end time or a new length for the range.
 6. Click **Process**.
-

RESULT

The range is adjusted to match the new end time or the new length. The tempo track is adjusted to show the new tempo of the range.

Setting up a Fixed Project Tempo

If your music does not contain tempo changes, and the tempo track is deactivated, you can set up a fixed tempo for your project.

When the tempo track is deactivated, the tempo track curve is grayed out. The fixed tempo is displayed as a horizontal line in the tempo curve display.

If you know the tempo of your music, you can adjust the tempo value in the following areas:

- **Tempo** field on the **Transport** panel
- **Current Tempo** field on the **Tempo Track Editor** toolbar
- **Current Tempo** field on the tempo track

If you do not know the tempo of your music, use one of the following tools to calculate and set it:

- **Beat Calculator**
- **Merge Tempo From Tapping**
- **Set Project Tempo from Loop**

RELATED LINKS

[Setting the Project Tempo from a Recording](#) on page 1142

[Setting the Project Tempo by Tapping](#) on page 1142

[Setting the Project Tempo from an Audio Loop](#) on page 1143

Setting the Project Tempo from a Recording

You can calculate the tempo of freely recorded audio or MIDI material with the **Beat Calculator** and set it as the project tempo.

PREREQUISITE

The **Tempo Track** is deactivated, that is, the tempo mode is set to **Fixed**.

PROCEDURE

1. On the **Project** window toolbar, select the **Range Selection** tool.
 2. In the event display, make a selection that covers an exact number of beats of the recording.
 3. Select **Project > Beat Calculator**.
 4. In the **Beats** value field, enter the number of beats that the selection encompasses.
The calculated tempo is shown in the **BPM** field.
 5. In the **Insert Tempo into Tempo Track** section, click **At Tempo Track Start**.
-

RESULT

The project tempo is set to the tempo calculated from your recording.

RELATED LINKS

[Beat Calculator](#) on page 1143

Setting the Project Tempo by Tapping

You can set the tempo of freely recorded audio or MIDI material by tapping.

PREREQUISITE

The tempo track is deactivated, that is, tempo mode is set to **Fixed**.

PROCEDURE

1. Activate playback.
2. Select **Project > Beat Calculator**.
3. Click **Tap Tempo**.

The **Tap Tempo** window opens.

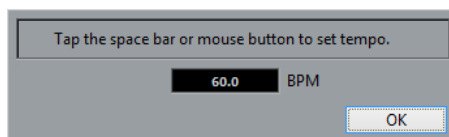

4. Use **Space** to tap the tempo of the recording that is played back.
In the **BPM** field, the calculated tempo is updated each time you tap.
 5. Click **OK** to close the window.
The tapped tempo is shown in the **BPM** field of the **Beat Calculator**.
 6. Click one of the buttons in the **Insert Tempo into Tempo Track** section to insert the calculated tempo into the tempo track.
-

RESULT

The project tempo is set to the tapped tempo.

RELATED LINKS

[Setting up a Fixed Project Tempo](#) on page 1141

Setting the Project Tempo from an Audio Loop

You can set the project tempo from the tempo of an audio loop.

PREREQUISITE

Your project contains an audio loop that is not in **Musical Mode**.

PROCEDURE

1. In the **Project** window ruler, set the left locator to the beginning of the audio loop.
 2. Set the right locator to the end of the last bar.
This does not need to match the end of the audio loop, but its number of bars.
 3. Select the audio loop.
 4. Select **Audio > Advanced > Set Tempo from Event**.
You are asked if you want to set the global project tempo.
 5. Perform one of the following actions:
 - Click **Yes** to adjust the project tempo globally.
 - Click **No** to adjust the project tempo only in the section of the audio event.
-

RESULT

The project tempo is set to the tempo calculated for the audio loop.

Beat Calculator

The **Beat Calculator** is a tool for calculating the tempo of freely recorded audio or MIDI material. It also allows you to set the tempo by tapping.

- To open the **Beat Calculator** for an audio or MIDI recording, select **Project > Beat Calculator**.

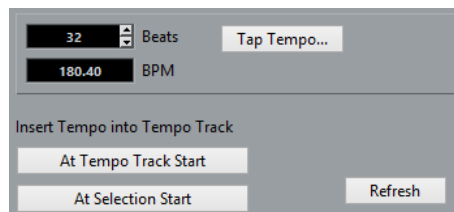

Beats

Allows you to enter the number of beats for the selected section of your recording.

BPM

Shows the tempo calculated for the selection.

Tap Tempo

Opens a window where you can specify a tempo by tapping.

At Tempo Track Start

If your project is in tempo track mode, the calculated tempo is set as the first tempo curve point. If your project is in fixed tempo mode, the calculated tempo is set for the entire project.

At Selection Start

If your project is in tempo track mode, the calculated tempo is set as a new tempo event at the start of the selection.

Refresh

Allows you to recalculate the tempo. This is useful if you adjust the selection, for example.

Tempo Detection

You can detect the tempo of any rhythmic musical content, even if it has not been recorded to a metronome click or if it contains tempo drift.

Detecting the tempo of musical material is useful for the following cases:

- If you want your audio or MIDI tracks to follow the tempo of freely recorded material.
- If you want to adjust freely recorded material to the project tempo.

To perform a tempo detection, the following requirements must be met:

- The audio event or MIDI part must be at least 7 seconds long.
- The material must have discernible beats or rhythms.

Tempo Detection Panel

The **Tempo Detection Panel** allows you to analyze the tempo of audio events or MIDI parts.

- To open the **Tempo Detection Panel** for an audio event or a MIDI part, select the event or the part and select **Project > Tempo Detection**.

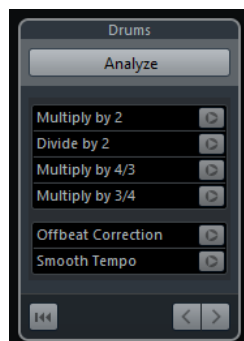

Name

Shows the name of the selected event or part.

Analyze

Starts the tempo detection.

Multiply by 2

Allows you to double the detected tempo. This is useful if your material is twice as fast as the detected tempo.

Divide by 2

Allows you to halve the detected tempo. This is useful if your material is half as fast as the detected tempo.

Multiply by 4/3

Allows you to adjust the detected tempo with a factor of 4/3. This is useful if your material contains dotted notes or triplets and the algorithm detects 3 beats where 4 are expected.

Multiply by 3/4

Allows you to adjust the detected tempo with a factor of 3/4. Combined with **Multiply by 2**, this is useful if the actual signature is 2/4 and the algorithm detects 6/8 beats or vice versa.

Offbeat Correction

Allows you to shift the detected tempo events by half a beat. This is useful for material where the offbeat is so dominant that the algorithm mistakes it for an upbeat.

Smooth Tempo

Allows you to retrigger the tempo analysis and remove irregular spikes or tempo changes for material that has a steady tempo. This is useful if irregular tempo changes were detected, even though you know that the material has a more or less steady tempo.

Reset the analysis result

Resets the analysis data.

Direction of reanalysis buttons

When you correct the detected tempo curve by reanalyzing it manually, these buttons allow you to change the direction in which the material is analyzed. To reanalyze the beginning of the tempo curve, activate the left arrow button.

Exporting a Tempo Track

You can export a tempo track as an XML file to use it in other projects.

PROCEDURE

1. Select **File > Export > Tempo Track**.
 2. In the file dialog that opens, specify a name and a location for the file.
 3. Click **Save**.
-

RESULT

The tempo track information is saved together with signature events with the file extension **.smt**.

Importing a Tempo Track

You can import a tempo track from another project.

PROCEDURE

1. Select **File > Import > Tempo Track**.
 2. In the file dialog that opens, navigate to the file you want to import.
 3. Click **Open**.
-

RESULT

The tempo track is imported to your project together with signature events. All tempo track data in the project is replaced.

Process Tempo Dialog

The **Process Tempo** dialog allows you to set a range to a specific length or to adjust its end time by automatic adjustment of the tempo track.

- To open the **Process Tempo** dialog, activate **Activate Tempo Track**, select **Project > Tempo Track** to open the **Tempo Track Editor**, and click **Open Process Tempo Dialog**.

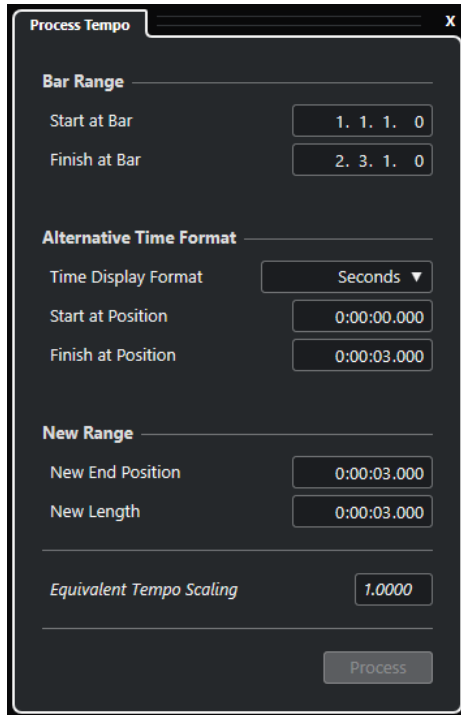

The following options are available in the **Bar Range** section:

Start at Bar

Shows the start time of the locator range in bars and beats.

Finish at Bar

Shows the end time of the locator range in bars and beats.

The following options are available in the **Alternative Time Format** section:

Time Display Format

Allows you to select the alternative time format.

Start at Position

Shows the start time of the locator range in the selected time format.

Finish at Position

Shows the end time of the locator range in the selected time format.

The following options are available in the **New Range** section:

New End Position

Shows the end time of the new range in the selected time format.

New Length

Shows the length of the new range in the selected time format.

Equivalent Tempo Scaling

Shows the scaling value.

Process

Applies the process.

Process Bars Dialog

The **Process Bars** dialog allows you to insert, delete, replace, or reinterpret the signature events by automatic adjustment of the signature and tempo events.

- To open the **Process Bars** dialog, select **Project > Tempo Track** to open the **Tempo Track Editor**, and click **Open Process Bars Dialog**.

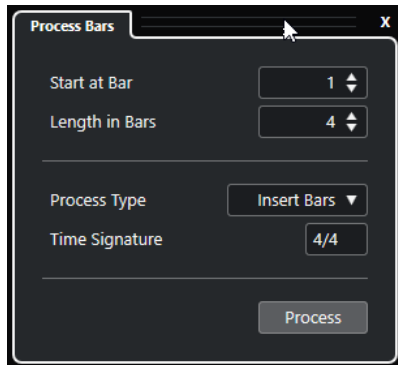

The following options are available:

Start at Bar

Allows you to set a start position for the process.

Length in Bars

Allows you to set a length for the process.

Process Type

Allows you to select a process type:

- **Insert Bars**
Inserts empty bars with the specified **Time Signature** at the **Process Start Bar Position** position.
- **Delete Bars**
Deletes the bar at the **Process Start Bar Position** position.
- **Reinterpret Bars**
Reinterprets bars with the specified **Time Signature** at the **Process Start Bar Position** position. However, the playback of the notes stays the same.
- **Replace Bars**
Replaces bars at the **Process Start Bar Position** position.

Time Signature

Allows you to specify the time signature that is used for the **Insert Bars**, **Reinterpret Bars**, and **Replace Bars** actions.

Process

Applies the specified process type.

Time Warp

The **Time Warp** tool allows you to adjust musical positions of events or parts to time positions.

- You can adjust positions in musical time-based material to positions in time.

- You can match material with a musical time base to material with a linear time base.

NOTE

The **Time Warp** tool can create tempo values up to 360 BPM.

If you activate **Time Warp** on the toolbar, the ruler shows tempo events as flags with tempo values.

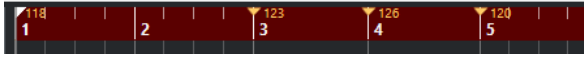

If you click **Time Warp** again, a pop-up menu opens where you can select one of the following modes:

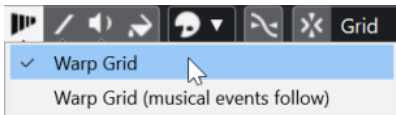

- **Warp Grid**
If you use the **Time Warp** tool in this mode, the absolute time positions for all tracks that are set to musical time base are kept.
- **Warp Grid (musical events follow)**
If you use the **Time Warp** tool in this mode, all tracks that are set to musical time base follow the changes.

When you click with the **Time Warp** tool, it snaps to the tempo grid in the window. If you want the **Time Warp** tool to snap to a marker or the start or end of an event instead, activate **Snap** and set the **Snap Type** to **Events**.

Adjusting Musical Positions to Time Positions

You can adjust musical positions to positions in time with the **Time Warp** tool.

PREREQUISITE

Tempo track mode is activated. **Snap** is activated, and you have selected an appropriate **Snap Type**.

PROCEDURE

1. On the **Project** window toolbar, click **Time Warp**.
The ruler is automatically set to **Bars+Beats** format.
 2. In the event display, locate the musical position that you want to adjust and drag the time position to match it.
This can be the event start, a certain hit within the event, etc.
 3. Release the mouse button.
-

RESULT

The musical position is adjusted to the time position, and the tempo value of the last tempo event before the click position is changed. If later tempo events exist, a new tempo event is created at the click position.

RELATED LINKS

[Project Tempo Modes](#) on page 1132
[Time Warp](#) on page 1147

Set Definition from Tempo Dialog

The **Set Definition from Tempo** dialog allows you to set up freely recorded audio material to follow a specific tempo.

- To open the **Set Definition from Tempo** dialog for an audio recording, select **Audio > Advanced > Set Definition from Tempo**.

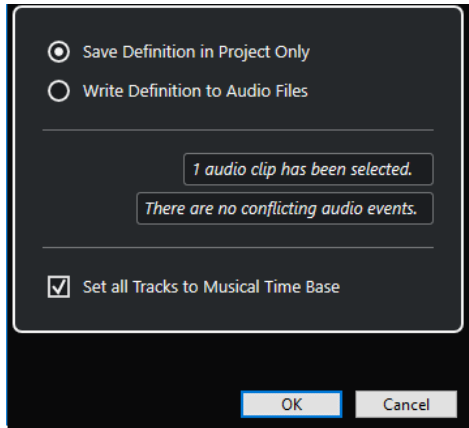

Save Definition in Project Only

Saves the tempo information in the project file only.

Write Definition to Audio Files

Writes the tempo information to the selected audio files. This is useful if you want to use them in other projects together with the tempo information.

Set all Tracks to Musical Time Base

Sets all tracks to musical time base. If this is deactivated, only the tracks with the selected events are set to musical time base.

Adjusting the Audio Tempo to the Project Tempo

You can adjust the tempo of freely recorded audio material to the project tempo.

PROCEDURE

1. Select the audio events that you want to adjust to the project tempo.
2. Select **Audio > Advanced > Set Definition from Tempo**.
3. Optional: Adjust the settings.
4. Click **OK**.

RESULT

The tempo information is copied to the audio and the tracks are set to musical time base. This is achieved by applying warping to the events. **Musical Mode** is activated for the audio events. The audio tracks now follow any tempo changes in the project.

Time Signature Events

You can set up one or more time signatures for a project.

You can set up the first time signature event of your project on the **Transport** panel. You can add further time signature events in the **Tempo Track Editor**.

Time signature events can have click patterns assigned. These allow you to create different grooves and feels for the metronome click. You can create a triplet click pattern for a 4/4 time signature, for example.

RELATED LINKS

[Project Window Toolbar](#) on page 48

[Transport Bar](#) on page 63

[Signature Track](#) on page 162

[Adding Time Signature Events in the Tempo Track Editor](#) on page 1150

[Setting up a Click Pattern for a Time Signature Event](#) on page 1151

Adding Time Signature Events in the Tempo Track Editor

PROCEDURE

1. Select **Project > Tempo Track** to open the **Tempo Track Editor**.
2. Select **Draw** on the toolbar, and in the time signature display, click at the time position where you want to insert the time signature event.
3. Edit the numerator and the denominator to change the value of the time signature event.

NOTE

You can also select the time signature event and edit the time signature value on the info line.

RESULT

The time signature event is added at the specified time position. The timeline and the event displays for the **Project** window and the editors reflect the changes.

Adding Time Signature Events on the Signature Track

You can add multiple time signature events for a project. This is useful if you want to change the time signature at a specific bar, for example.

PROCEDURE

1. Select **Project > Add Track > Signature**.
The time signature track is added to the track list.
 2. Select **Draw** on the **Project** window toolbar and on the signature track, click at the time position where you want to insert the time signature event.
 3. Edit the numerator and the denominator to change the value of the time signature event.
-

RESULT

The time signature event is added at the specified time position. The timeline and the event displays for the **Project** window and the editors reflect the changes.

RELATED LINKS

[Signature Track](#) on page 162

Setting up a Click Pattern for a Time Signature Event

For each signature event in your project, you can set up a metronome click pattern.

PROCEDURE

1. Double-click the plus sign to open the **Click Pattern Editor**.
 2. Do one of the following:
 - Open the **Pattern** pop-up menu and select one of the presets.
 - Use the **Clicks** setting to define the number of clicks that you want to hear, and click in the event display to set up a new click pattern.
 3. When you are done, click outside the **Click Pattern Editor** to close it.
 4. Repeat this for each signature event for which you want to set up a click pattern.
-

RESULT

If you play back the project and activate the metronome click, the different project parts use the defined click patterns. The **Click Pattern Editor** in the **Transport Bar** shows the pattern at the project cursor position.

RELATED LINKS

[Click Pattern Editor](#) on page 278

Project Browser

The **Project Browser** provides a list-based representation of the project. It allows you to view and edit all events on all tracks.

- To open the **Project Browser**, select **Project > Browser**.

NOTE

The **Project Browser** can be open while you are working in other windows. Any changes in the **Project** window or an editor are immediately reflected in the **Project Browser** and vice versa.

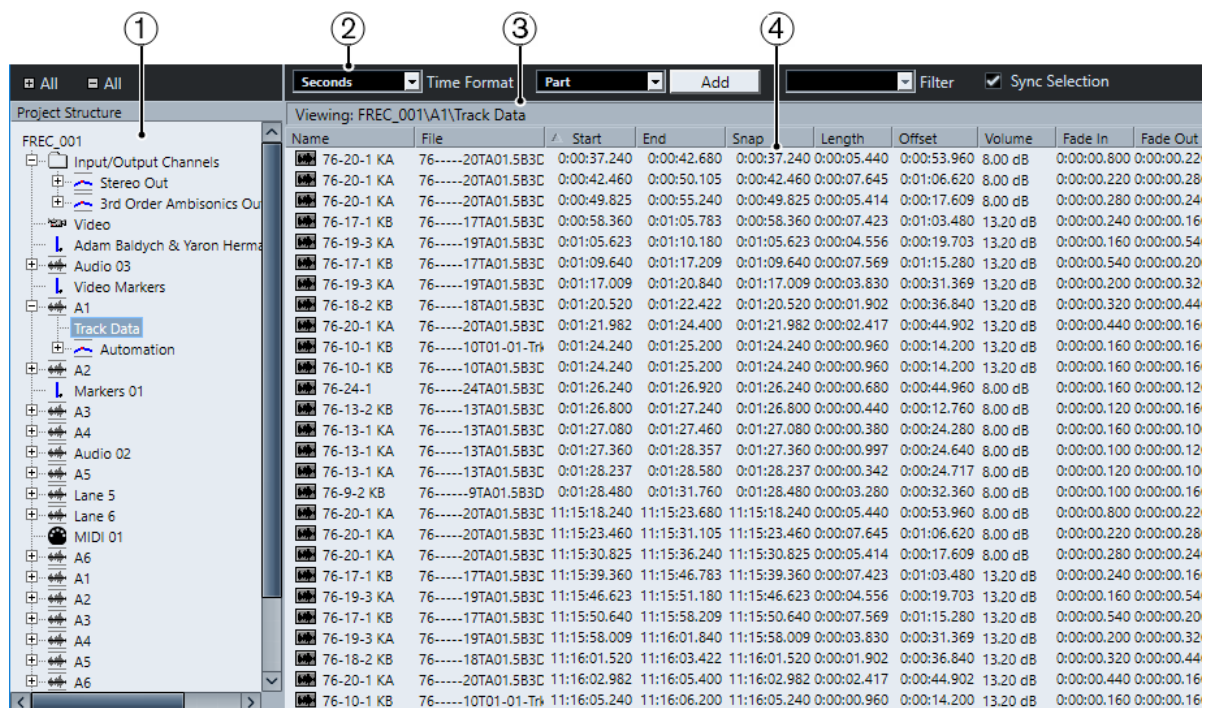

1 Project Structure

Allows you to select specific track types for viewing and editing in the event display.

2 Toolbar

Contains tools and settings for editing.

3 Info Line

Shows information about the selected item.

4 Event Display

Allows you to view and edit the selected item.

Project Browser Toolbar

The toolbar contains tools and settings for editing in the **Project Browser**.

+/- All

Opens/Closes all folders in the **Project Structure** list.

Time Format

Allows you to change the time display format in the **Project Browser**.

Track/Part/Event

Shows what is added when you click **Add**.

Add

Adds the track, part, or event type that is shown in the pop-up menu to the left.

Filter

Allows you to filter the event display by event type.

Sync Selection

Links the selection in the **Project Browser** to the selection in the **Project** window. This allows you to locate events in the two windows.

Project Structure

The **Project Structure** allows you to select specific track types for viewing and editing in the event display. Depending on what track type you select, different items can be available in the **Project Structure**.

Track Data

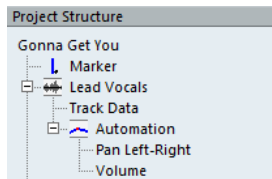

If you select **Track Data**, the **Project Structure** shows audio events and/or audio parts, which in turn can contain audio events, or MIDI parts, which in turn can contain MIDI events.

Track Data is available for audio and MIDI tracks.

Automation

Selecting **Automation** in the **Project Structure** shows the automation events of the track, if available.

Each **Automation** item in the **Project Structure** has subentries for each automated parameter.

Event Display

The **Project Browser** event display allows you to view and edit the selected item.

Name	File	Start	End	Snap	Length	Offset	Volume	Fade In	Fade Out	Mut	Image
76-11-1	76-----11TA01.5B3C	0:01:25.600	0:01:25.840	0:01:25.600	0:00:00.240	0:00:10.960	8.00 dB	0:00:00.000	0:00:00.080	-	
76-15-1 KA	76-----15TA02.5B3C	0:01:26.240	0:01:26.920	0:01:26.240	0:00:00.680	0:00:13.960	8.00 dB	0:00:00.360	0:00:00.200	-	
78-4-3	78-----4TA02.5B34	0:01:32.200	0:01:33.680	0:01:32.200	0:00:01.480	0:00:21.960	13.60 dB	0:00:00.120	0:00:00.080	-	

NOTE

Not all columns are available for all events. You can rearrange the order of the columns by clicking a header and dragging left or right.

Name

Double-click the name to change it. You cannot change the name for the left and right locator.

Audio events: Double-click the waveform image to open the event in the **Sample Editor**.

Audio parts: Double-click the waveform image to open the event in the **Audio Editor**.

MIDI parts: Double-click the part image to open the event in the **Key Editor**.

File

Audio events: The name of the audio file referenced by the audio clip of the event.

Type

MIDI events: The type of the MIDI event.

Tempo track: The type of the tempo curve.

Start

The start position of the event.

End

The end position of the event.

Position

The position of an event.

Tempo

The tempo value of a tempo event.

Signature

The time signature value of a signature event.

Bar

The bar of a signature event.

Pattern

The click pattern of a signature event.

Snap

Audio events: The position of the event snap point. Adjust this value to move the audio event.

Length

The length of the event.

Offset

The event start position in the clip.

NOTE

If the event already plays the whole clip, this value cannot be adjusted.

Volume

The volume of the event.

Fade In/Fade Out

The length of the fade-in and fade-out areas respectively.

NOTE

If you add a fade, a linear fade is created. If you adjust the length of an existing fade, the previous fade shape is maintained.

Mute

Mutes or unmutes the event.

Image

Audio events: Displays a waveform image of the event.

Editing Note Expression Data

In the **Project Browser**, you can view and edit the MIDI controller events or VST 3 events of a MIDI note with note expression data.

PROCEDURE

1. In the **Project Structure**, select the **Note Expression** subitem of the MIDI note that you want to view or edit.
In the event display, all MIDI controllers or VST 3 events within the note expression data are listed.
 2. In the event display, edit the parameter values.
-

RESULT

The event changes accordingly.

EXAMPLE

If you entered a different **Start** value, the event is moved.

RELATED LINKS

[Note Expression](#) on page 1027

Deleting events

PROCEDURE

1. Select an event or a part in the event display.
 2. Do one of the following:
 - Select **Edit > Delete**.
 - Press **Delete** or **Backspace**.
-

RESULT

The selected event is deleted.

IMPORTANT

You cannot delete the first tempo event or the first time signature event of the project.

Rendering Audio and MIDI

You can render existing material to new audio material.

You can render the following:

- Audio tracks
- Instrument tracks
- Audio events or parts on audio tracks
- MIDI parts on instrument tracks
- Range selections on audio or instrument tracks
- Range selections on multiple audio or instrument tracks

IMPORTANT

The rendering function does not support side-chain routing.

Render Tracks Dialog

The **Render Tracks** dialog allows you to customize the track render settings.

- To open the **Render Tracks** dialog, deselect all events in the **Project** window, and select one or more audio tracks, instrument tracks, or MIDI tracks, and select **Edit > Render in Place > Render Settings**.

The screenshot shows the **Render Tracks** dialog box with the following settings:

- Mode:** As One Event
- Processing:**
 - Dry (Transfer Channel Settings)
 - Channel Settings
 - Complete Signal Path
 - Complete Signal Path + Master FX
- Properties:**
 - Tail Mode:** Off
 - Tail Size:** 00.000
 - Bit Depth:** 32 bit float
- File Name Settings:**
 - Use Custom Name
 - Name:** Untitled
- File Location:**
 - File Path:** C:\
 - Mix Down to One Audio File
- Source Track Settings:**
 - Source Tracks:** Mute Source Tracks
 - Hide Source Tracks

Buttons: **Render** (highlighted), **Close**

The following settings are available in the **Mode** section:

As Separate Events

Creates one or more tracks that contain separate events or parts that are saved as separate audio files.

As Block Events

Creates one or more tracks that contain adjacent events/parts that are combined to blocks. Every block is saved as a separate audio file.

As One Event

Creates one or more tracks that contain the events/parts and combines them to one event/part. Every combination is saved as a separate audio file.

The following settings are available in the **Processing** section:

Dry

Copies all effects and panner settings to new audio tracks. The resulting audio tracks keep the formats of their source tracks. A mono track results in a mono track, for example.

Channel Settings

Renders all effects into the resulting audio files. This includes insert effects, channel strip settings, group channel settings, and FX send channel settings. Panner settings are transferred to the new audio tracks. The resulting audio tracks keep the formats of their source tracks. A mono track results in a mono track, for example.

Complete Signal Path

Renders the complete signal path into the new audio files, including all channel settings, group channel settings, FX send channel settings, and panner settings. The new audio track is created without effects. Stereo balance panner settings are activated. The resulting audio file format is determined by the output channel of the source track. A mono track that is routed to a stereo bus results in a stereo audio file.

Complete Signal Path + Master FX

Renders the complete signal path and the master bus settings into the resulting audio files. This includes all channel settings, group channel settings, FX send channel settings, and panner settings. The resulting audio file format is determined by the output channel of the source track. A mono track that is routed to a stereo bus results in a stereo audio file.

The following settings are available in the **Properties** section:

Tail Mode

Allows you to set the tail mode to **Bars & Beats**, **Seconds** or **Off**.

Tail Size

Allows you to set a tail length for the rendered files. This adds time at the end of the rendered file to allow reverb and delay tails to fully fade out.

Bit Depth

Allows you to set the bit depth for the resulting file.

The following settings are available in the **File Name Settings** section:

Use Custom Name

Activates the use of custom names for the rendered files.

Name

Allows you to enter a custom name for the rendered files.

Scheme

Click **Open Naming Scheme Window** to define naming schemes.

Preview

Shows the name with the current naming scheme settings.

The following settings are available in the **File Location** section:

File Path

Allows you to select a custom folder to which the resulting .wav files are rendered.

Mix down to One Audio File

Creates one audio file from all your source material. This option is only available if several tracks are selected and **Dry (Transfer Channel Settings)** is deactivated.

The following settings are available in the **Source Track Settings** section:

Source Tracks

- **Keep Source Tracks Unchanged**
Keeps the source tracks unchanged.
- **Mute Source Tracks**
Automatically mutes the source tracks.
- **Disable Source Tracks**
Disables the source tracks. This option releases CPU and RAM resources and is therefore similar to the **Freeze** function. To reenale the tracks, right-click the disabled track to open the context menu and select **Enable Track**.
- **Remove Source Tracks**
Removes the source tracks from the track list.

Hide Source Tracks

Hides the source tracks after rendering. To show the source tracks again, select the **Visibility** tab in the **Project** window and select the track that you want to show.

RELATED LINKS

[Pan Control](#) on page 431

Rendering Tracks

You can render selected tracks either via the **Render Tracks** dialog or by directly using the **Render (with Current Settings)** command.

PROCEDURE

1. Deselect all events.
 2. Select one or more audio, MIDI, or instrument tracks.
 3. Select **Edit > Render in Place > Render Settings**.
 4. Specify the render options.
 5. Click **Render**.
-

RESULT

All selected source material is processed according to your render settings. Your render options are saved and used for all further render operations.

NOTE

You can also start the rendering operation directly by selecting **Edit > Render in Place > Render (with Current Settings)**.

Render Selection Dialog

You can render selections of audio events and/or MIDI parts with default settings or with customized settings. The **Render Selection** dialog allows you to customize the selection render settings.

- To open the **Render Selection** dialog, select a range, and select **Edit > Render in Place > Render Settings**.

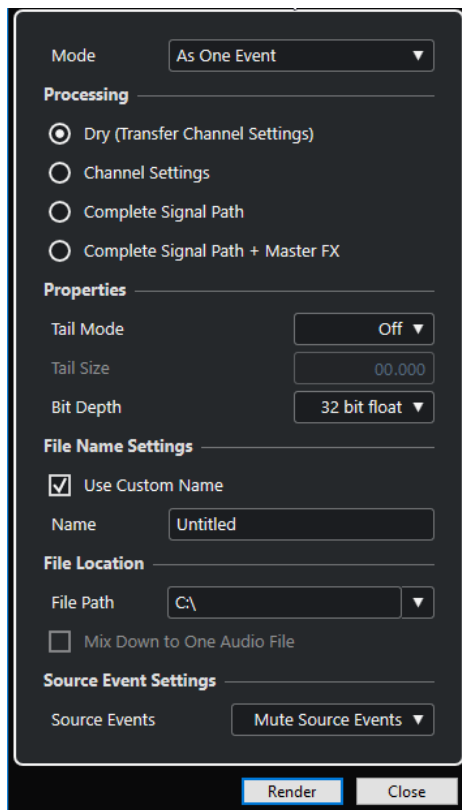

The following settings are available in the **Mode** section:

As Separate Events

Creates one or more tracks that contain separate events or parts that are saved as separate audio files.

As Block Events

Creates one or more tracks that contain adjacent events/parts that are combined to blocks. Every block is saved as a separate audio file.

As One Event

Creates one or more tracks that contain the events/parts and combines them to one event/part. Every combination is saved as a separate audio file.

The following settings are available in the **Processing** section:

Dry

Copies all effects and panner settings to new audio tracks. The resulting audio tracks keep the formats of their source tracks. A mono track results in a mono track, for example.

Channel Settings

Renders all effects into the resulting audio files. This includes insert effects, channel strip settings, group channel settings, and FX send channel settings. Panner settings are transferred to the new audio tracks. The resulting audio tracks keep the formats of their source tracks. A mono track results in a mono track, for example.

Complete Signal Path

Renders the complete signal path into the new audio files, including all channel settings, group channel settings, FX send channel settings, and panner settings. The new audio track is created without effects. Stereo balance panner settings are activated. The resulting audio file format is determined by the output channel of the source track. A mono track that is routed to a stereo bus results in a stereo audio file.

Complete Signal Path + Master FX

Renders the complete signal path and the master bus settings into the resulting audio files. This includes all channel settings, group channel settings, FX send channel settings, and panner settings. The resulting audio file format is determined by the output channel of the source track. A mono track that is routed to a stereo bus results in a stereo audio file.

The following settings are available in the **Properties** section:

Tail Mode

Allows you to set the tail mode to **Bars & Beats**, **Seconds** or **Off**.

Tail Size

Allows you to set a tail length for the rendered files. This adds time at the end of the rendered file to allow reverb and delay tails to fully fade out.

Bit Depth

Allows you to set the bit depth for the resulting file.

The following settings are available in the **File Name Settings** section:

Use Custom Name

Activates the use of custom names for the rendered files.

Name

Allows you to enter a custom name for the rendered files.

Scheme

Click **Open Naming Scheme Window** to define naming schemes.

Preview

Shows the name with the current naming scheme settings.

The following settings are available in the **File Location** section:

File Path

Allows you to select a custom folder to which the resulting .wav files are rendered.

Mix down to One Audio File

Creates one audio file from all your source material. This option is only available if several tracks are selected and **Dry (Transfer Channel Settings)** is deactivated.

The following settings are available in the **Source Event Settings** section:

Source Events

- **Keep Source Events Unchanged**
Keeps the source events unchanged.
- **Mute Source Events**
Automatically mutes the source events.

Rendering Selections

You can render selections or range selections of audio events and/or MIDI parts via the **Render Selection** dialog.

PROCEDURE

1. Select one or more audio events and/or MIDI parts or make a range selection.
 2. Select **Edit > Render in Place > Render Settings**.
 3. In the **Render Selection** dialog, specify the render options.
 4. Click **Render**.
-

RESULT

All selected source material is processed according to your render settings. Your render options are saved and used for all further render operations.

NOTE

You can also start the rendering operation directly by selecting **Edit > Render in Place > Render (with Current Settings)**.

Export Audio Mixdown

The **Export Audio Mixdown** function allows you to mix down and export all audio that is contained between the left and right locators of a project or in ranges defined by cycle markers.

- To open the **Export Audio Mixdown** dialog, select **File > Export > Audio Mixdown**.

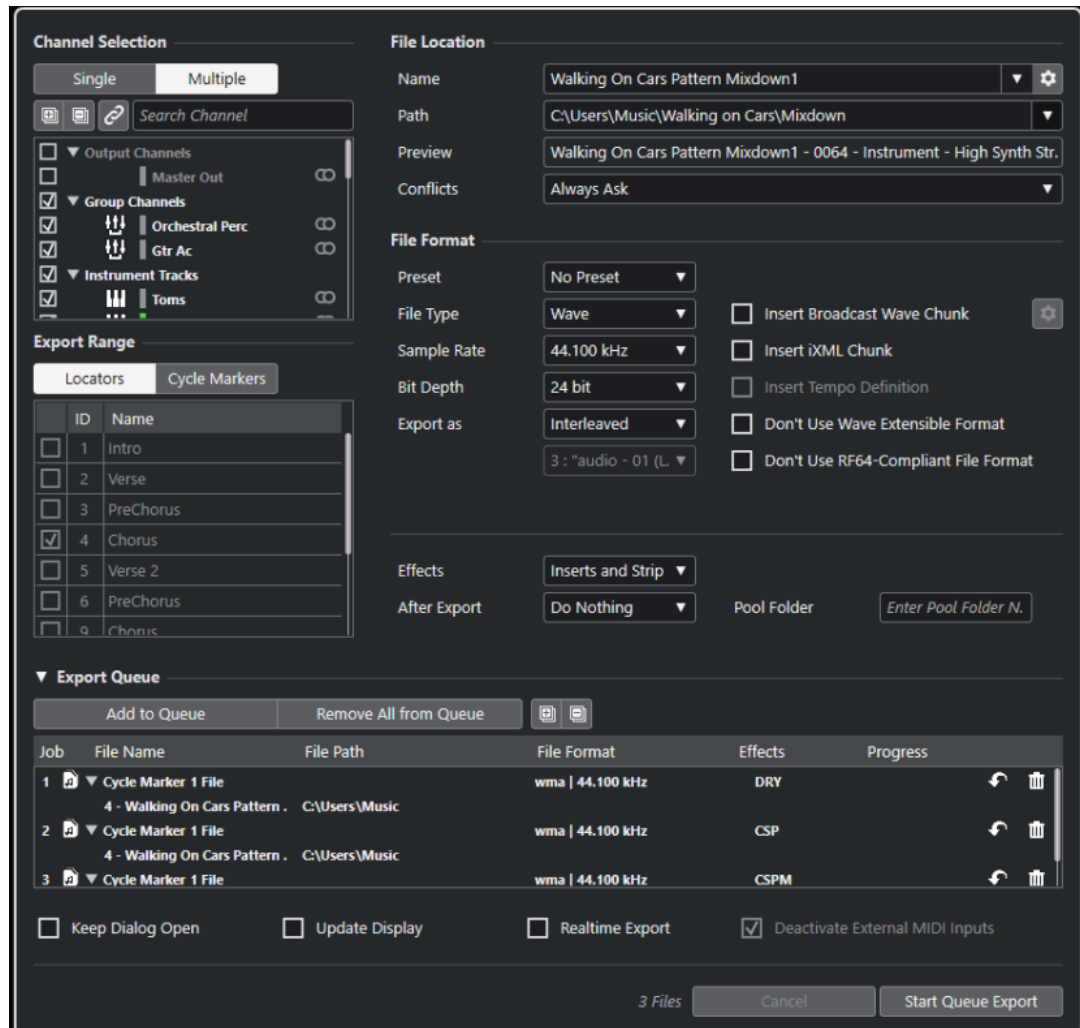

Export Audio Mixdown Dialog

The **Export Audio Mixdown** dialog allows you to set up how audio is mixed down and exported.

- To open the **Export Audio Mixdown** dialog, select **File > Export > Audio Mixdown**.

The **Export Audio Mixdown** dialog is divided into several sections.

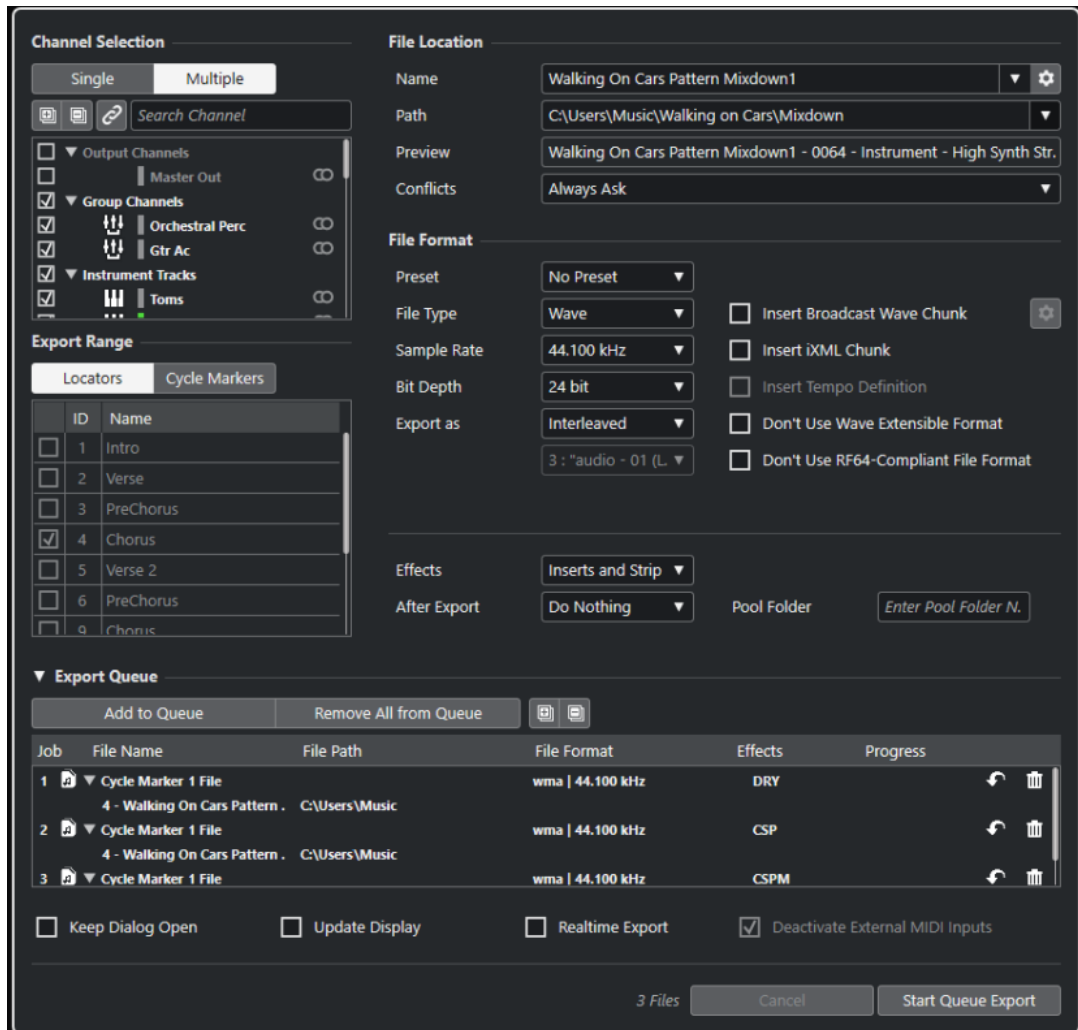

Channel Selection

In the **Channel Selection** section, the following options are available:

Single

Allows you to export a single channel.

Multiple

Allows you to export multiple channels.

Expand All

Expands all channel categories in the list.

Collapse All

Collapses all channel categories in the list.

Sync Selection to Channel/Track Selection

Filters the channel list according to the channels that are selected in the **MixConsole** or the tracks that are selected in the **Project** window track list. This is only available if you export multiple channels.

NOTE

To show channels for MIDI tracks that are connected to a VST instrument, you must select the corresponding VSTi channel in the **Project** window track list.

Search Channel

Allows you to enter text to search for a specific channel by name. This is useful if your project contains a large number of channels.

Channel list

Lists all channels that are available in your project. The channel list shows the channel type, the channel color, and the channel width. Activate a channel in the list to export it.

MixConsole settings and insert effects are taken into account. An individual file is created for each activated channel.

Export Range

In the **Export Range** section, the following options are available:

Locators

Allows you to export the locator range.

Cycle Markers

Allows you to export one or more cycle marker ranges. **MixConsole** settings, record enable, and insert effects are taken into account. Lists all cycle markers that are available in your project. Activate a cycle marker in the list to export the range that it encompasses. An individual file is created for each activated cycle marker range.

NOTE

Only the cycle markers of the active marker track can be selected.

Export Queue

In the **Export Queue** section, the following options are available:

Add to Queue

Adds a job to the job queue list. All current settings of the **Export Audio Mixdown** dialog are taken into account.

Remove All from Queue

Removes all jobs from the job queue list.

Expand All

Expands all job categories in the list.

Collapse All

Collapses all job categories in the list.

Job list

Lists all jobs that you added to the **Export Queue** section.

File Location

In the **File Location** section, the following options are available:

Name

Allows you to specify the name of the mixdown file.

Click **File Name Options** to open a pop-up menu with naming options:

- **Set to Project Name** inserts the project name into the **Name** field.
- **Auto Update Name** adds a number to the file name and increments the number every time you export a file.

Click **Set up Naming Scheme** to open a dialog where you can specify a naming scheme.

Path

Allows you to specify the file path for the mixdown file.

Click **Path Options** to open a pop-up menu with file path options:

- **Choose** opens a dialog that allows you to browse for a file location.
- **Use Project Audio Folder** sets the path to the **Audio** folder of your project.
- **Project Mixdown Folder** sets the path to the **Mixdown** folder of your project.

NOTE

If you activate **Project Mixdown Folder**, the option **Use Project Audio Folder** is automatically disabled.

The **Mixdown** folder is automatically created in your project folder. It is used by default if no export path information is available, that is, if you create a new empty project, or if you load or create a project from a template.

- **Recent Paths** allows you to select recently selected file locations.
The **Mixdown** folder is not added to the list of **Recent Paths**.
- **Clear Recent Paths** allows you to delete all recently selected file locations.

Preview

Shows the file name with the naming scheme applied.

Conflicts

Exporting audio can cause naming conflicts with existing files that have the same name. You can define how file name conflicts are resolved:

- **Always Ask** opens a warning that allows you to choose if an existing file should be overwritten or if a new unique file name should be created by adding an incremental number.
- **Create Unique File Name** creates a unique file name by adding an incremental number.
- **Always Overwrite** always overwrites the existing file.

File Format

In the **File Format** section, the following options are available:

Preset

Allows you to save presets for file format settings.

- **No Preset** allows you to export your file without applying a file format preset.
- **Preset list** allows you to select a saved file format preset from the list.
- **Save Preset** allows you to save the current file format settings as a preset.
- **Remove Preset** allows you to remove the selected preset.
- **Rename Preset** opens a dialog where you can rename the selected preset.

File Type

Allows you to select a file type for the mixdown file.

Sample Rate

Sets the sample rate for the mixdown file.

NOTE

- **Wave, AIFF files only:** If you set the value lower than the project sample rate, the audio quality degrades and the high-frequency content is reduced. If you set the value higher than the project sample rate, the file size increases without increasing the audio quality. For CD burning, select 44.100 kHz, because this is the sample rate used on audio CDs.

Bit Depth (Wave, AIFF, FLAC)

Allows you to select a bit depth for the mixdown file.

Bit Rate (MPEG 1 Layer 3)

Sets the bit rate for the MP3 file. The higher the bit rate, the better the audio quality and the larger the file. For stereo audio, 128 kBit/s is considered to be providing good audio quality results.

Export as

Allows you to select a channel mode for the mixdown file:

- **Interleaved**
Allows you to export to an interleaved file.
- **Split Channels**
Allows you to export the 2 channels of a stereo bus or all subchannels of a multi-channel bus as separate mono files.
- **Mono Downmix**
Allows you to downmix all the subchannels of a stereo or surround channel or bus to a single mono file.
For stereo, the **Stereo Pan Law** as defined in the **Project Setup** dialog is applied to avoid clipping.
For surround, the channels are summed and divided through the number of channels used (in case of a 5.1 channel = (L+R+C+LFE+Ls+Rs)/6).
- **L/R Channels from Surround**
Allows you to export only the left and right subchannels of a multi-channel bus into a stereo file.

Insert Broadcast Wave Chunk (Wave, AIFF)

Activates the embedding of additional file information in Broadcast Wave format.

NOTE

By activating this option, you create a Broadcast Wave file. Some applications may not be able to handle these files. If you get problems using the file in another application, deactivate **Insert Broadcast Wave Chunk** and export the file again.

Broadcast Wave files also contain loudness metadata according to EBU R 128 that can be shown in the **Attribute Inspector** of the **MediaBay**.

Set up Broadcast Wave Chunk (Wave, AIFF)

Opens the **Broadcast Wave Chunk** dialog where you can enter information.

Don't Use Wave Extensible Format (Wave)

Deactivates the Wave Extensible format that contains additional metadata, such as the speaker configuration.

Don't Use RF64-Compliant File Format (Wave)

Deactivates the RF64-compliant format that allows file sizes to exceed 4 GB.

Insert iXML Chunk (Wave, AIFF)

Includes additional project-related metadata, such as project name, author, and project frame rate.

Insert Tempo Definition (Wave, AIFF)

This option is only available if **Insert iXML Chunk** is activated. It allows you to include tempo information from the tempo track or from the **Definition** section of the **Sample Editor** in the iXML chunk of the exported files.

Normalize to Integrated Loudness (Wave, AIFF)

Normalizes your audio to the integrated loudness value that is specified in the field to the right.

Dialog-Gated Measurement (Wave, AIFF)

As an alternative to standard loudness normalization, you can choose a normalization based on a dialogue-gated loudness measurement according to ITU-R BS.1770.

Integrated Loudness Reference (Wave, AIFF)

Allows you to specify an integrated loudness value for the normalization of your audio.

Maximum True Peak value (Wave, AIFF)

Allows you to specify a maximum true peak value for the normalization of your audio.

High-Quality Mode (MPEG 1 Layer 3)

Sets the encoder to a different resampling mode. This may give better results depending on your settings. However, it does not allow you to select the **Sample Rate**.

Insert ID3 Tag (MPEG 1 Layer 3)

Includes ID3 Tag information in the exported file.

Edit ID3 Tag (MPEG 1 Layer 3)

Opens the **Setup ID3 Tag** dialog that allows you to enter information about the file. This information is embedded in the file and can be displayed by most MP3 playback applications.

Compression Level (FLAC)

Sets the compression level for the FLAC file. Since FLAC is a lossless format, the level has more influence on the encoding speed than on the file size.

Quality (OggVorbis)

Sets the quality for the variable bit rate encoding. This setting determines between which limits the bit rate will vary. The higher the value, the higher the sound quality but also the larger the files.

Effects

If you activate **Multiple** in the **Channel Selection** section to export multiple channels, you can select an option to specify which process to apply to the exported files.

- **Inserts and Strip**

Includes insert effects, EQ, and other channel settings. The channel configuration is exported post-panner, that is, mono channels that are routed to a stereo group are exported as stereo channels.

- **Disabled (DRY)**

Bypasses insert effects, EQ settings, etc. The channel configuration is exported in pre-panner position, that is, mono channels that are routed to a stereo group are exported as mono channels.

- **+ Groups/Sends (CSP)**

Includes insert effects, EQ, and other channel settings. Also includes effects and settings in all channels, for example, group and FX channels, towards the output

channel. The insert FX and EQ settings of the master channel are ignored. The channel configuration is exported post-panner.

- **+ Master/Groups/Sends (CSPM)**

Includes insert effects, EQ, and other channel settings. Also includes effects and settings in all channels, for example, group and FX channels towards the output channel, and the insert FX and EQ settings of the output channels. The channel configuration is exported post-panner.

After Export

- **Do Nothing** does nothing after export.
- **Open in WaveLab** opens your mixdown file in a WaveLab version after export. This requires that a WaveLab version is installed on your computer.
- **Create New Project**

NOTE

This option is only available for uncompressed file formats, and if **Use Project Audio Folder** is deactivated.

Creates a new project that contains an audio track for each of the exported channels, as well as the signature and tempo track of the original project.

The tracks will have the corresponding mixdown file as audio event. The track names will be identical with the export channel names. The new project will be the active project.

Activating this option disables the **Insert to Pool** and **Create Audio Track** options.

- **Create Audio Track**

Creates an audio event that plays the clip on a new audio track, starting at the left locator. Activating this option also activates the **Pool** option.

- **Insert to Pool**

Imports the resulting audio file automatically back into the **Pool** as a clip. Deactivating this option also deactivates the **Create Audio Track** option.

Pool Folder

Allows you to specify a **Pool** folder for the clip.

General Options

In the bottom section, the following options are available:

Keep Dialog Open

Activate this to keep the dialog open after clicking **Export Audio**.

Update Display

Updates the meters during the export process. This allows you to check for clipping, for example.

Realtime Export

Allows you to export the audio mixdown in real time. Realtime export takes at least the same time as regular playback. Activate this if you use external effects or instruments, or if you use VST plug-ins that require time to update correctly during the mixdown. For further information, refer to the documentation of the respective plug-ins.

During the realtime export of a single channel, the **Audition Volume** fader is displayed in the progress dialog. It allows you to adjust the **Control Room** volume.

NOTE

- If you export external effects or instruments in real time, you must also activate **Monitor** for the respective audio channels.
- If the CPU and disk speed of your computer do not allow you to export all channels simultaneously in real time, the program stops the process, reduces the number of channels, and starts again. Afterwards, the next batch of files is exported. This is repeated as often as needed to export all selected channels.

Deactivate External MIDI Inputs

Deactivates MIDI inputs that are performed on external devices during the export process.

Export Audio/Start Queue Export

Allows you to export your audio as specified.

RELATED LINKS

[Available Channels for Export](#) on page 1176

[Export Queue Section](#) on page 1174

[File Formats](#) on page 1177

[Saving File Format Presets](#) on page 1184

Naming Scheme Dialog

The **Naming Scheme** dialog allows you to define naming schemes for the file name of the audio material that you want to export.

The naming attributes that are available in this dialog depend on the channel that you selected for export.

- To open the **Naming Scheme** dialog, open the **Export Audio Mixdown** dialog, and in the **File Location** section, to the right of the **Name** field, click **Set up Naming Scheme**.

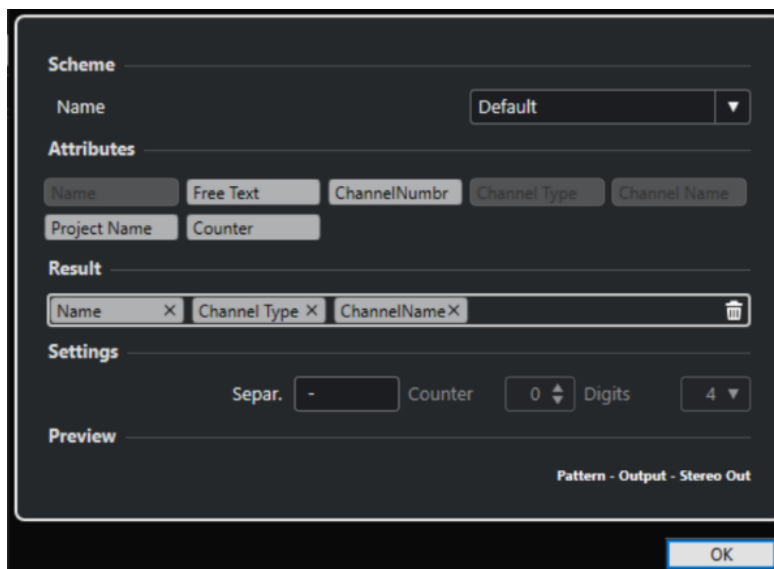

Scheme

Allows you to save and delete naming schemes.

Attributes

Holds the following naming scheme attributes:

- **Name**

Adds the name to the resulting file name.

- **Free Text**
Allows you to enter free text.
- **Channel Number**
Adds the channel number to the resulting file name.
- **Channel Type**
Adds the channel type to the resulting file name.
- **Channel Name**
Adds the channel name to the resulting file name.
- **Project Name**
Adds the project name to the resulting file name.

Result

Allows you to drop attributes for the file name and rearrange them by dragging.

Settings

Allows you to select separator and counter settings.

- **Separator**
Divides attributes from each other.
- **Counter**
The value from which the counter starts counting.
- **Digits**
The number of digits of the counter value.

Preview

Displays a preview of your current settings.

Defining Naming Schemes

You can define a naming scheme by combining attributes that determine the structure of the file names for the exported audio files.

Depending on the settings in the **Channel Selection** section and the **Export Range** section, different naming attributes are available.

PROCEDURE

1. In the **Naming Scheme** dialog, drag up to 5 attributes into the **Result** section.
You can also double-click an attribute to add it to the **Result** section.
2. Optional: In the **Settings** section, double-click the **Separator** text field to change the separator.
The **Preview** section displays the file name scheme according to your settings.
3. Optional: Set the **Counter** and the number of **Digits**.

NOTE

These options are only available if you added the **Counter** attribute.

The counter starts counting from this value. The **Digits** setting determines how many digits the counters contain.

4. Optional: Click the **Name** value field in the **Scheme** section and enter a preset name. Press **Return** to save your settings as a preset.

NOTE

The preset is only available for the channels that are selected in the **Channel Selection** section.

5. Click **OK**.
-

Entering Free Text

You can enter free text that is added to the file name of the exported audio files.

PROCEDURE

1. In the **File Location** section of the **Export Audio Mixdown** dialog, click **Set up Naming Scheme**.

The **Naming Scheme** dialog opens.

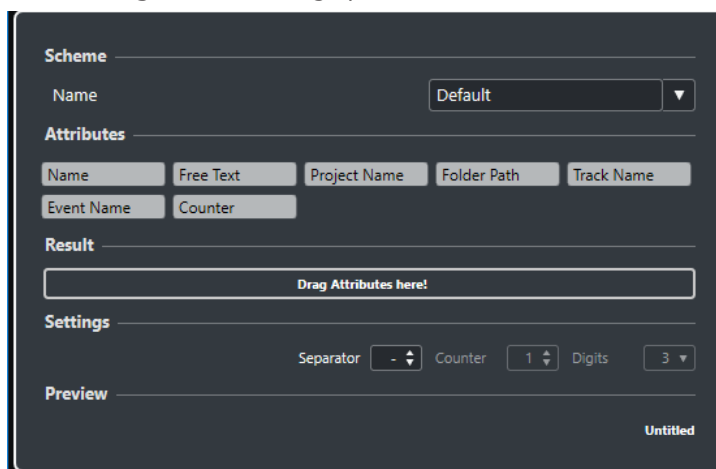

2. Open the **Scheme** pop-up menu and select **New Scheme**.
 3. Double-click the **Free Text** attribute to add it to the **Result** field.
 4. In the **Result** field, double-click the **Free Text** label and enter the text that you want to add.
 5. Press **Return** to confirm your changes.
 6. Click **OK**.
-

RESULT

The text that you entered is added to the file name scheme and will be applied on export.

Mixing Down to Audio Files

You can mix selected channels down to audio files.

PREREQUISITE

- You have set up the left and right locators or created a cycle marker that encompasses the range
- You have set up your tracks so that they play back the way you want.
This includes muting unwanted tracks or parts, making manual **MixConsole** settings, and/or activating the **R** (Read) automation buttons for **MixConsole** channels.

IMPORTANT

The setting of the **Output Routing** in the corresponding track **Inspector** determines the channel width of the **Export Audio Mixdown** export. This means if no main output bus is selected, the exported audio file only contains silence.

PROCEDURE

1. Select **File > Export > Audio Mixdown**.
2. In the **Channel Selection** section, do one of the following:
 - Click **Single** to export a single audio channel.
 - Click **Multiple** to export multiple audio channels.
3. In the channels list, select the channels that you want to export.
4. In the **Export Range** section, do one of the following:

NOTE

The locator range must not be empty or inverted.

- Click **Cycle Markers**, and in the cycle markers list, activate the cycle markers to export the corresponding ranges.

NOTE

Your project must contain at least one cycle marker.

IMPORTANT

- If you set the export range so that effects, such as reverb, that are applied to a preceding event, reach into the next, these effects are heard in the mixdown even though the event itself is not included. To avoid this, mute the first event.
-

5. Optional: Open the **Effects** pop-up menu and select an option.
This is only available if you selected **Multiple** in the **Channel Selection** section. You can export your audio with effects, channel settings, panner, and master bus settings, for example.
6. In the **File Location** section, set up a valid export path.
7. Set up the file name.

NOTE

You can define a naming scheme in the **Naming Scheme** dialog.

8. In the **File Format** section, set up the settings according to your needs.
 9. Click **Export Audio**.
-

RESULT

The audio is exported.

Mixing Down to Audio Files Using Job Queues

You can mix down multiple audio files by creating a job queue. This allows you to export stems or cues, for example, even in different file formats. You can create up to 20 export jobs and add them to the job queue. Job queues are saved with the project.

PROCEDURE

1. Select **File > Export > Audio Mixdown**.
2. In the **Channel Selection** section, do one of the following:
 - Click **Single** to export a single audio channel.
 - Click **Multiple** to export multiple audio channels.
3. In the channels list, select the channels that you want to export.
4. In the **Export Range** section, do one of the following:

NOTE

The locator range must not be empty or inverted.

- Click **Cycle Markers**, and in the cycle markers list, activate the cycle markers to export the corresponding ranges.

NOTE

Your project must contain at least one cycle marker.

5. Optional: Open the **Effects** pop-up menu and select an option.
This is only available if you selected **Multiple** in the **Channel Selection** section. You can export your audio with effects, channel settings, panner, and master bus settings, for example.
6. In the **File Location** section, set up a valid export path.
7. Set up the file name.

NOTE

You can define a naming scheme in the **Naming Scheme** dialog.

8. Open the **Export Queue** section, and click **Add to Queue**.

NOTE

If the job is not valid, for example, if the locator range is empty or no cycle marker is selected, the job cannot be added. In this case, a warning message is displayed.

9. Optional: Repeat the above steps for as many jobs as you need.
10. Optional: In the job queue list, select the individual jobs to verify one after another if everything is set up correctly.
When you select a job in the job queue list, all settings for that job are shown in the **Export Audio Mixdown** dialog. If necessary, you can change the settings for the selected job, and click **Update Job**.
11. Click **Start Queue Export**.

NOTE

You can cancel the complete queue export by clicking **Cancel**. This stops the export process and removes already exported files from your hard disk. The job queue list is kept.

RESULT

The jobs of your export queue are exported one after another. A progress bar informs you about the estimated remaining export time, the currently exported channel, the channel names, and the number of remaining jobs.

RELATED LINKS

[Export Queue Section](#) on page 1174

[Updating Jobs in a Job Queue](#) on page 1174

[Defining Naming Schemes](#) on page 1170

Updating Jobs in a Job Queue

You can update jobs that you already added to a job queue.

PROCEDURE

1. In the job queue list, select the job for which you want to change the settings.
The settings for the selected job are shown in the **Export Audio Mixdown** dialog.
 2. Make your changes in the corresponding sections of the dialog.
The **Update Job** symbol for the job changes its color to indicate that the job has been changed.
 3. In the **Export Queue** section, click **Update Job**.
-

RESULT

The export job is updated according to your settings. All other jobs in the job queue list remain unchanged and valid.

RELATED LINKS

[Export Queue Section](#) on page 1174

[Mixing Down to Audio Files Using Job Queues](#) on page 1173

Export Queue Section

The **Export Queue** section allows you to create up to 20 export jobs and add them to an export queue. A job queue is part of a project and is saved with the project.

- To expand the **Export Queue** section, click the arrow in the bottom left of the **Export Audio Mixdown** dialog.

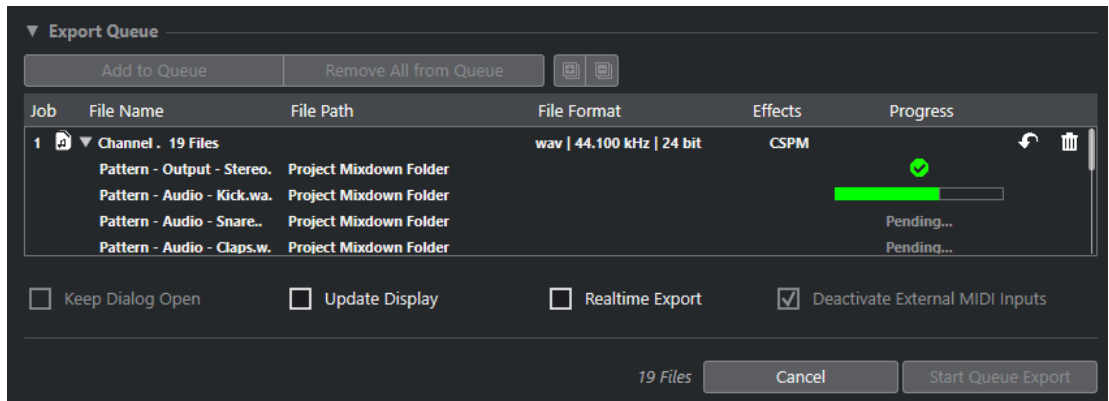

Add to Queue

Adds a job with the current settings to the job queue.

Remove All from Queue

Removes all jobs from the job queue list.

Expand All

Expands all jobs in the list.

Collapse All

Collapses all jobs in the list.

Job

The number of the job in the queue.

File Name

Shows one of the following:

- **File name**
The name of the exported file. This is shown if you add a single channel to the export queue and activate **Locators** as export range.
- **Channel Batch**
The **Channel Batch** folder that contains all channels that belong to that batch. The number of files is shown next to the folder. This is shown if you add multiple channels to the export queue and activate **Locators** as export range.
- **Cycle Marker**
The **Cycle Marker** folder that contains the cycle marker. This is shown if you add a single channel to the export queue and activate **Cycle Markers** as export range.
- **Cycle Marker + Batch**
The **Cycle Marker + Batch** folder that contains all channels that belong to that batch. The number of files is shown next to the folder. This is shown if you add multiple channels to the export queue and activate **Cycle Markers** as export range.

File Path

The file path for the exported file.

File Format

The file format settings of the exported file.

Effects

Shows the settings for the exported file. If nothing is stated, the file is exported with channel settings (post-panner):

- **DRY**

The file is exported dry (pre-panner).

- **CSP**

The file is exported via the complete signal path.

- **CSPM**

The file is exported via the complete signal path and with master effects.

Progress

Shows the status of the export job.

Update Job

Updates the selected export job.

Remove Job

Removes the selected export job from the list.

RELATED LINKS

[Updating Jobs in a Job Queue](#) on page 1174

[Export Jobs](#) on page 1176

[Mixing Down to Audio Files Using Job Queues](#) on page 1173

Export Jobs

Export jobs allow you to export multiple audio files with different settings. You can add up to 20 export jobs in a job queue.

An export job contains the **Channel Selection**, the **Export Range**, the **Name**, the **Path**, the **File Format**, and the **Effects** settings.

The current naming scheme is used for the exported audio files and the conflicts setting is automatically set to **Create Unique File Name**, that is, a number is added to each exported file.

NOTE

The **After Export** settings are not part of the job queue and will be executed after the export.

You can add up to 20 export jobs to an export queue. A job queue is part of a project and is saved with the project.

RELATED LINKS

[Export Queue Section](#) on page 1174

Available Channels for Export

The **Channel Selection** section of the **Export Audio Mixdown** dialog contains a list of channels that you can export as an audio mixdown.

The channels are organized in a hierarchical structure. Channels of the same type are grouped. This allows you to easily identify and select the channels for export.

NOTE

MIDI channels are not available for export. However, you can export the VST instrument channel of MIDI tracks that are connected to a VSTi, or you can record MIDI to audio tracks.

You can mix down the following channel types:

- Output channels

All output channels that you configured in the **Audio Connections** dialog are listed in the **Channel Selection** section. By activating an output channel in the list, you instruct Nuendo to mix down all tracks that are routed to this output channel.

- **Audio channels**

All audio channels that are available in your project are listed in the **Channel Selection** section. By activating an audio channel in the list, you instruct Nuendo to mix it down to a file.

- **Any audio-related MixConsole channels**

All VST instrument channels, instrument tracks, effect return channels (FX channel tracks), group channels, and ReWire channels of your project are listed in the **Channel Selection** section. By activating an audio-related channel in the list, you instruct Nuendo to mix it down.

RELATED LINKS

[Audio Connections](#) on page 28

File Formats

The **File Type** pop-up menu in the **File Format** section allows you to select a format and make additional settings for the mixdown file.

Wave file

This is the most common file format on the PC platform. Wave files have the extension **.wav**.

AIFF file

This is an audio file format standard defined by Apple Inc. AIFF files are used on most computer platforms. The files can contain embedded text strings. AIFF files have the extension **.aif**.

MXF file

This is a container format for digital video and audio. MXF files are used on most computer platforms. The files are often part of AAF projects and have the extension **.mxf**.

MPEG 1 Layer 3 file

This is a family of standards used for encoding audio-visual information such as movies, video, and music in a digital compressed format. Nuendo can read MPEG Layer 2 and MPEG Layer 3. MP3 files are highly compressed files that still provide good audio quality. The files have the extension **.mp3**.

FLAC file

This is an open source format that reduces the size of audio files by 50 % to 60 % compared to regular Wave files. The files have the extension **.flac**.

Ogg Vorbis file

This is an open source, patent-free audio encoding and streaming technology. The Ogg Vorbis encoder uses variable bit rate encoding. It offers compressed audio files of small size, but with comparatively high audio quality. The files have the extension **.ogg**.

RELATED LINKS

[Wave Files](#) on page 1178

[AIFF Files](#) on page 1179

[MXF files \(OP-Atom\)](#) on page 1181

[MP3 \(MPEG 1 Layer 3\) Files](#) on page 1181

[FLAC Files](#) on page 1182

[Ogg Vorbis Files](#) on page 1183

[File Format](#) on page 1165

[Saving File Format Presets](#) on page 1184

Wave Files

Wave files have the extension **.wav** and are the most common file format on the PC platform.

- To open the settings for wave files, select **Wave** in the **File Type** pop-up menu.

Sample Rate

Sets the sample rate for the mixdown file.

NOTE

If you set the value lower than the project sample rate, the audio quality degrades and the high-frequency content is reduced. If you set the value higher than the project sample rate, the file size increases without increasing the audio quality. For CD burning, select 44.100 kHz, because this is the sample rate used on audio CDs.

Bit Depth

Allows you to select a bit depth for the mixdown file. You can select 8-bit, 16-bit, 24-bit, 32-bit, 32-bit (float), or 64-bit (float). If you plan to re-import the mixdown file into Nuendo, select 32-bit (float). This is the resolution used for audio processing in Nuendo. 32-bit (float) files are twice the size of 16-bit files. For CD burning, use the 16-bit option, as CD audio is always 16 bit. In this case, we recommend dithering.

Activating the **UV-22HR** dithering plug-in reduces the effects of quantization noise and artifacts when converting the audio to 16 bit. 8-bit resolution results in limited audio quality and should only be used if required.

Export as

Allows you to select a channel mode for the mixdown file:

- **Interleaved**
Allows you to export to an interleaved file.
- **Split Channels**
Allows you to export the 2 channels of a stereo bus or all subchannels of a multi-channel bus as separate mono files.
- **Mono Downmix**
Allows you to downmix all the subchannels of a stereo or surround channel or bus to a single mono file.
For stereo, the **Stereo Pan Law** as defined in the **Project Setup** dialog is applied to avoid clipping.
For surround, the channels are summed and divided through the number of channels used (in case of a 5.1 channel = $(L+R+C+LFE+Ls+Rs)/6$).
- **L/R Channels from Surround**
Allows you to export only the left and right subchannels of a multi-channel bus into a stereo file.

Insert Broadcast Wave Chunk

Activates the embedding of additional file information in Broadcast Wave format.

NOTE

By activating this option, you create a Broadcast Wave file. Some applications may not be able to handle these files. If you get problems using the file in another application, deactivate **Insert Broadcast Wave Chunk** and export the file again.

Broadcast Wave files also contain loudness metadata according to EBU R 128 that can be shown in the **Attribute Inspector** of the **MediaBay**.

Set up Broadcast Wave Chunk

Opens the **Broadcast Wave Chunk** dialog where you can enter information.

Insert iXML Chunk

Includes additional project-related metadata, such as project name, author, and project frame rate.

Insert Tempo Definition

This option is only available if **Insert iXML Chunk** is activated. It allows you to include tempo information from the tempo track or from the **Definition** section of the **Sample Editor** in the iXML chunk of the exported files.

Don't Use Wave Extensible Format

Deactivates the Wave Extensible format that contains additional metadata, such as the speaker configuration.

Don't Use RF64-Compliant File Format

Deactivates the RF64-compliant format that allows file sizes to exceed 4 GB.

Normalize to Integrated Loudness

Normalizes your audio to the integrated loudness value that is specified in the field to the right.

Dialog-Gated Measurement

As an alternative to standard loudness normalization, you can choose a normalization based on a dialogue-gated loudness measurement according to ITU-R BS.1770.

Integrated Loudness Reference

Allows you to specify an integrated loudness value for the normalization of your audio.

Maximum True Peak value

Allows you to specify a maximum true peak value for the normalization of your audio.

RELATED LINKS

[Attribute Inspector](#) on page 728

[Saving File Format Presets](#) on page 1184

AIFF Files

AIFF stands for Audio Interchange File Format, a standard defined by Apple Inc. AIFF files have the extension **.aif** and are used on most computer platforms.

- To open the settings for AIFF files, select **AIFF** in the **File Type** pop-up menu.

Sample Rate

Sets the sample rate for the mixdown file.

NOTE

If you set the value lower than the project sample rate, the audio quality degrades and the high-frequency content is reduced. If you set the value higher than the

project sample rate, the file size increases without increasing the audio quality. For CD burning, select 44.100 kHz, because this is the sample rate used on audio CDs.

Bit Depth

Allows you to select a bit depth for the mixdown file. You can select 8-bit, 16-bit, 24-bit, 32-bit, 32-bit (float), or 64-bit (float). If you plan to re-import the mixdown file into Nuendo, select 32-bit (float). This is the resolution used for audio processing in Nuendo. 32-bit (float) files are twice the size of 16-bit files. For CD burning, use the 16-bit option, as CD audio is always 16 bit. In this case, we recommend dithering.

Activating the **UV-22HR** dithering plug-in reduces the effects of quantization noise and artifacts when converting the audio to 16 bit. 8-bit resolution results in limited audio quality and should only be used if required.

Export as

Allows you to select a channel mode for the mixdown file:

- **Interleaved**
Allows you to export to an interleaved file.
- **Split Channels**
Allows you to export the 2 channels of a stereo bus or all subchannels of a multi-channel bus as separate mono files.
- **Mono Downmix**
Allows you to downmix all the subchannels of a stereo or surround channel or bus to a single mono file.
For stereo, the **Stereo Pan Law** as defined in the **Project Setup** dialog is applied to avoid clipping.
For surround, the channels are summed and divided through the number of channels used (in case of a 5.1 channel = $(L+R+C+LFE+Ls+Rs)/6$).
- **L/R Channels from Surround**
Allows you to export only the left and right subchannels of a multi-channel bus into a stereo file.

Insert Broadcast Wave Chunk

Activates the embedding of additional file information in Broadcast Wave format.

NOTE

By activating this option, you create a Broadcast Wave file. Some applications may not be able to handle these files. If you get problems using the file in another application, deactivate **Insert Broadcast Wave Chunk** and export the file again.

Broadcast Wave files also contain loudness metadata according to EBU R 128 that can be shown in the **Attribute Inspector** of the **MediaBay**.

Set up Broadcast Wave Chunk

Opens the **Broadcast Wave Chunk** dialog where you can enter information.

Insert iXML Chunk

Includes additional project-related metadata, such as project name, author, and project frame rate.

Insert Tempo Definition

This option is only available if **Insert iXML Chunk** is activated. It allows you to include tempo information from the tempo track or from the **Definition** section of the **Sample Editor** in the iXML chunk of the exported files.

Normalize to Integrated Loudness

Normalizes your audio to the integrated loudness value that is specified in the field to the right.

Dialog-Gated Measurement

As an alternative to standard loudness normalization, you can choose a normalization based on a dialogue-gated loudness measurement according to ITU-R BS.1770.

Integrated Loudness Reference

Allows you to specify an integrated loudness value for the normalization of your audio.

Maximum True Peak value

Allows you to specify a maximum true peak value for the normalization of your audio.

RELATED LINKS

[Saving File Format Presets](#) on page 1184

MXF files (OP-Atom)

MXF stands for Material Exchange Format. This is a container format for digital video and audio. MXF files have the extension **.mxf** and are used on most computer platforms.

- To open the settings for MXF files, select **MXF** in the **File Type** pop-up menu.

MXF audio files are often part of AAF projects.

RELATED LINKS

[AAF Files](#) on page 1299

[MXF Files](#) on page 1306

[Saving File Format Presets](#) on page 1184

MP3 (MPEG 1 Layer 3) Files

MP3 files are highly compressed files that still provide good audio quality. They have the extension **.mp3**.

- To open the settings for MP3 files, select **MPEG 1 Layer 3** in the **File Type** pop-up menu.

Sample Rate

Sets the sample rate for the mixdown file.

Bit Rate

Sets the bit rate for the MP3 file. The higher the bit rate, the better the audio quality and the larger the file. For stereo audio, 128 kBit/s is considered to be providing good audio quality results.

Export as

Allows you to select a channel mode for the mixdown file:

- **Interleaved**
Allows you to export to an interleaved file.
- **Split Channels**
Allows you to export the 2 channels of a stereo bus or all subchannels of a multi-channel bus as separate mono files.
- **Mono Downmix**
Allows you to downmix all the subchannels of a stereo or surround channel or bus to a single mono file.

For stereo, the **Stereo Pan Law** as defined in the **Project Setup** dialog is applied to avoid clipping.

For surround, the channels are summed and divided through the number of channels used (in case of a 5.1 channel = $(L+R+C+LFE+Ls+Rs)/6$).

- **L/R Channels from Surround**

Allows you to export only the left and right subchannels of a multi-channel bus into a stereo file.

High-Quality Mode

Sets the encoder to a different resampling mode. This may give better results depending on your settings. However, it does not allow you to select the **Sample Rate**.

Insert ID3 Tag

Includes ID3 Tag information in the exported file.

Edit ID3 Tag

Opens the **Setup ID3 Tag** dialog that allows you to enter information about the file. This information is embedded in the file and can be displayed by most MP3 playback applications.

RELATED LINKS

[Saving File Format Presets](#) on page 1184

FLAC Files

Free Lossless Audio Codec files are audio files that are typically 50 % to 60 % smaller than regular Wave files.

- To open the settings for FLAC files, select **FLAC** in the **File Type** pop-up menu.

Sample Rate

Sets the sample rate for the mixdown file.

NOTE

If you set the value lower than the project sample rate, the audio quality degrades and the high-frequency content is reduced. If you set the value higher than the project sample rate, the file size increases without increasing the audio quality. For CD burning, select 44.100 kHz, because this is the sample rate used on audio CDs.

Bit Depth

Allows you to select a bit depth for the mixdown file. You can select 8-bit, 16-bit, 24-bit, 32-bit, 32-bit (float), or 64-bit (float). If you plan to re-import the mixdown file into Nuendo, select 32-bit (float). This is the resolution used for audio processing in Nuendo. 32-bit (float) files are twice the size of 16-bit files. For CD burning, use the 16-bit option, as CD audio is always 16 bit. In this case, we recommend dithering.

Activating the **UV-22HR** dithering plug-in reduces the effects of quantization noise and artifacts when converting the audio to 16 bit. 8-bit resolution results in limited audio quality and should only be used if required.

Export as

Allows you to select a channel mode for the mixdown file:

- **Interleaved**
Allows you to export to an interleaved file.
- **Split Channels**

Allows you to export the 2 channels of a stereo bus or all subchannels of a multi-channel bus as separate mono files.

- **Mono Downmix**

Allows you to downmix all the subchannels of a stereo or surround channel or bus to a single mono file.

For stereo, the **Stereo Pan Law** as defined in the **Project Setup** dialog is applied to avoid clipping.

For surround, the channels are summed and divided through the number of channels used (in case of a 5.1 channel = $(L+R+C+LFE+Ls+Rs)/6$).

- **L/R Channels from Surround**

Allows you to export only the left and right subchannels of a multi-channel bus into a stereo file.

Compression Level

Sets the compression level for the FLAC file. Since FLAC is a lossless format, the level has more influence on the encoding speed than on the file size.

RELATED LINKS

[Saving File Format Presets](#) on page 1184

Ogg Vorbis Files

Ogg Vorbis is an open source, patent-free audio encoding and streaming technology, offering compressed audio files of small size, but with comparatively high audio quality. Ogg Vorbis files have the extension **.ogg**.

- To open the settings for Ogg Vorbis files, select **OggVorbis** in the **File Type** pop-up menu.

Quality

Sets the quality for the variable bit rate encoding. This setting determines between which limits the bit rate will vary. The higher the value, the higher the sound quality but also the larger the files.

Export as

Allows you to select a channel mode for the mixdown file:

- **Interleaved**

Allows you to export to an interleaved file.

- **Split Channels**

Allows you to export the 2 channels of a stereo bus or all subchannels of a multi-channel bus as separate mono files.

- **Mono Downmix**

Allows you to downmix all the subchannels of a stereo or surround channel or bus to a single mono file.

For stereo, the **Stereo Pan Law** as defined in the **Project Setup** dialog is applied to avoid clipping.

For surround, the channels are summed and divided through the number of channels used (in case of a 5.1 channel = $(L+R+C+LFE+Ls+Rs)/6$).

- **L/R Channels from Surround**

Allows you to export only the left and right subchannels of a multi-channel bus into a stereo file.

RELATED LINKS

[Saving File Format Presets](#) on page 1184

Saving File Format Presets

You can create file format presets from your favorite or most used file format settings.

PROCEDURE

1. In the **File Format** section, set up the **File Type** and the file type-specific settings that you want to save in your preset.
2. Click the **Preset** field, and select **Save Preset** from the pop-up menu.

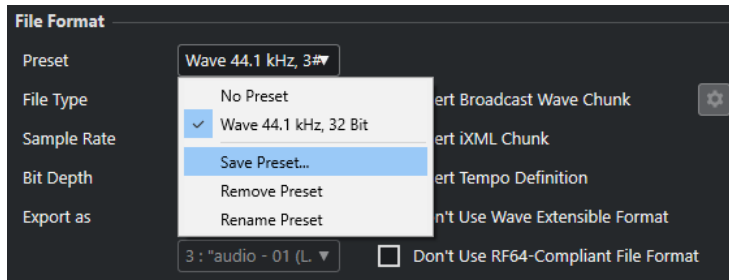

3. Enter a name for your file format preset.
 4. Click **OK**.
-

RESULT

A file format preset including the file type, sample rate, bit depth, the **Export as** settings is saved. You can select it from the **Preset** pop-up menu.

Presets are saved with the program and can be used for any project. Presets are stored in the following location:

- On Windows: “\Users\\AppData\Roaming\Steinberg\\Presets\AudioFileFormatPreset”
On macOS: “/Library/Preferences/<program name>/Presets/AudioFileFormatPreset” under your home directory

Presets are also saved in profiles in the **Profile Manager**.

RELATED LINKS

- [Profile Manager Dialog](#) on page 1342
- [Profiles](#) on page 1342
- [File Formats](#) on page 1177

Networking

The networking functions allow you to collaborate with other users of Nuendo in a peer-to-peer network.

This can be a LAN (Local Area Network) or a WAN (Wide Area Network).

Such a network allows you to share a project so that you can work on it with several users simultaneously. Shared data includes MIDI, video, and audio, as well as marker tracks and instrument tracks. You can not exchange **MixConsole** settings.

All network users must have the same version of Nuendo.

Networking Protocol and Ports

Nuendo uses 3 ports in your system for establishing communication, broadcasting messages and transferring data between users: UDP port 6990, TCP port 6991 and TCP port 6992.

These ports need to be open for network communication to be possible.

Considerations for Internet Use

The Nuendo networking functions are designed mainly for use in local area networks. You could also use them directly over the internet, but this is no secure connection. For a secure communication, a VPN is highly recommended.

- All users must use the IP addresses or domain names of the other computers in the network to establish the connection.
- Firewalls
Over the internet, connection and communication is established and handled via TCP/IP messages sent to the TCP ports 6991 and 6992. These ports must be open on all computers. If a firewall blocks messages to these ports and makes connection impossible, consult the documentation for your firewall.
- Routers and Private subnets
Only one computer in a private subnet can be connected to the internet. All computers in a NAT (Network Address Translation) subnet share the same external IP address, but the individual computers in the subnet have internal IP addresses. You must set up a port mapping from the external ports 6991 and 6992 to your internal ports 6991 and 6992, that is, the actual ports on your computer, as opposed to the ports of the subnet.

NOTE

If you want to collaborate with users whose computers reside in different subnets that use NAT, we highly recommend that you set up a VPN (Virtual Private Network). Make sure that your VPN acts as a single network and that the TCP ports 6991, 6992, and, if possible, UDP 6990 are open.

RELATED LINKS

[Setting Up WAN Connections](#) on page 1186

Network Requirements

You can set up a network with both LAN and WAN connections. While LAN connections use broadcast messages to find other computers, WAN connections must be added manually.

Your LAN network must meet the following criteria:

- All computers use the same LAN.
- All computers communicate properly via the TCP/IP protocol.
- The network is activated.
- UDP 6990 broadcasts reach all computers.
- All firewalls are configured to allow Nuendo to communicate on TCP port 6991, 6992, and if possible UDP 6990.

NOTE

If the computers are unable to communicate, contact your network administrator, or consult the network documentation for your operating system.

If no UDP 6990 broadcast is possible, you can add a WAN connection if you know the domain name or the IP address of the computer. For connections over the internet this must meet the following criteria:

- All computers have a working internet connection.
- All computers have a public IP address or port mapping is configured.

IMPORTANT

If your computer has multiple network interfaces, you must select the IP address of the interface that is connected to the Nuendo workgroup in the **Network Interface Setup** dialog. Here, you must also enter the **Sub-Net Mask** for your specific network adapter.

The **Network Interface Setup** dialog opens automatically when you start the application or when you activate the **Network** function and multiple network interfaces are available on your computer.

Setting Up WAN Connections

If you do not use a secure VPN connection, you can still set up a WAN connection to connect to other users over the internet.

PREREQUISITE

The network is activated.

PROCEDURE

1. Select **Network > Shared Projects**.
2. On the toolbar, click **Add WAN Connection**.



3. In the **Add Internet Connection** dialog, type in the IP address/domain name of the computer you want to connect to.
4. Click **OK**.

The item **Global IP Network** is now shown in the **Users and Projects** list, and the IP address of the computer to which you have connected, or the domain name of its internet service provider.

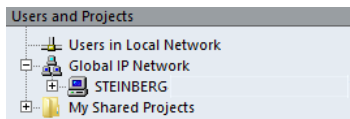

5. Repeat this procedure for every user you want to connect to over the internet.

NOTE

If a computer is dynamically allocated an IP address by its internet service provider, as opposed to having a permanent IP address, you must repeat the above procedure each time the computer receives a new IP address.

RESULT

The WAN connection is established.

If the connection cannot be established, make sure that:

- You entered the IP address correctly.
- The required ports on your computer and/or the computer you are trying to connect to are not blocked by a firewall.
- Your computer and/or the computer you are trying to connect to does have the necessary ports open.

RELATED LINKS

[Considerations for Internet Use](#) on page 1185

Activating the Network

You must establish the network communication and introduce your computer to the computers in the network by activating the network.

PROCEDURE

1. Select **Network > Active**.
2. In the dialog, enter a unique user name to identify your computer in the network.

NOTE

If you do not enter a user name at this point, the network will not be activated.

3. Click **OK**.
-

RESULT

The network is now active and you can load or create a project and share it with the other users.

Verifying the Communication

Whenever project information needs to be updated over the network, Nuendo first checks if the connection with all project participants is still working. This check is performed in the background with a preset timeout period. If participants do not respond within this period, a **Commit Failed** message is displayed. If the problem persists, you can verify the communication.

PROCEDURE

- Select **Network > Verify Communication**.

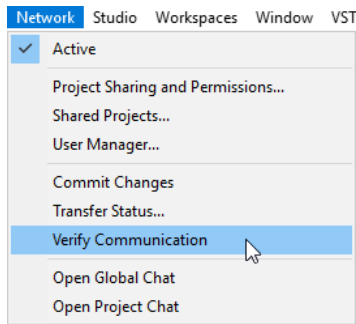

RESULT

A dialog shows the progress of the checking process.

If all project participants are found, the dialog lists all project participants and their response times.

If project participants are not found because they are offline, a dialog is shown allowing you to remove these users from the workgroup.

If the response times are longer than the standard timeout, or if a participant who is in fact online cannot be found, you can change the timeout threshold in Nuendo to a longer setting by clicking **Adjust timer**.

Changing Your User Name

You can change your user name.

NOTE

Once your user name has been established in the network, you should only change it if that is absolutely necessary.

PROCEDURE

1. Select **Network > User Manager**.
2. Enter a name in the **Network Name** text field, and press **Return**.

IMPORTANT

The user names **Guest**, **Administrator**, **Admin**, and **Anonymous** are reserved and cannot be used.

RESULT

The name is displayed in all the network dialogs to identify you to the other users in a network.

RELATED LINKS

[Adding Permission Presets](#) on page 1189

[Permissions](#) on page 1189

Permissions

If you want to share a project with others, you must give them permissions to join your project.

You can load a permission preset or set up users and permissions manually.

Permission presets allow you to apply the same list of users and their permissions in all projects where you load them. You can load the default permission preset to let all the participants in a network have access to a project or create your own permission preset.

Setting up permissions manually allows you to decide which users you want to have access to the entire project or to separate tracks.

RELATED LINKS

[Default Permissions and Guest Users](#) on page 1189

Default Permissions and Guest Users

The **Default Permissions** preset is always available, and contains a **Guest** user with both read and write permissions.

The **Default Permissions** are the easiest and quickest way to share a project with everyone in a network and let everyone have both read and write permissions for the entire project.

If this is not what you want, you can modify the **Default Permissions** by adding and removing users. However, you cannot remove the **Default Permissions** preset itself.

The **Guest** user, and thus his permissions, can be utilized by anyone in the network. Therefore, shared projects that have **Guest** user allow anyone in the network to join using the corresponding permissions.

Adding Permission Presets

You can save read and write user permissions as permission presets.

PROCEDURE

1. Select **Network > User Manager**.
2. Below the **Permission Presets** column, click the plus sign.
3. In the **Add new Permission Preset** dialog, enter a name, and click **OK** to add a new permission preset.
4. Select the new permission preset.
5. In the **User Pool** column, select the users that you want to add to the permission preset. To select several users, hold down **Shift** or **Ctrl/Cmd**.
6. Click **Add selected Users to Permission Preset**.

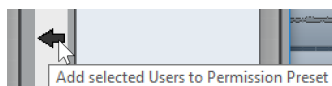

The selected users are added to the **Users** column. Added users automatically have read permission that allows them to view and play back shared projects or tracks, and write permission that allows them to make changes to shared projects or tracks.

7. Optional: Deactivate the **Write** column for a user that you only want to have read permissions.

User	Read	Write
Guest	✓	✓
candy	✓	✓

NOTE

Users cannot have write permissions without also having read permissions.

RESULT

The permission preset is available for use and applies to entire projects.

RELATED LINKS

[User Manager Dialog](#) on page 1198

[Loading Permission Presets](#) on page 1190

[Setting Up Permissions for Separate Tracks](#) on page 1191

[Permissions](#) on page 1189

Loading Permission Presets

You can load a permission preset for the active project.

PROCEDURE

1. Select **Network > Project Sharing and Permissions**.
2. Open the **Permission Presets** pop-up menu.
The menu lists all available permission presets.

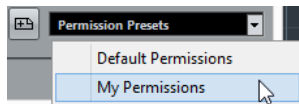

3. Select a permission preset from the pop-up menu.
-

RESULT

The users defined in the permission preset are shown in the **User Name** column, and their read and write permissions are displayed.

RELATED LINKS

[Setting Up Permissions Manually](#) on page 1190

Setting Up Permissions Manually

You can manually set up which users are allowed to join a project, and what read and write permissions they have.

PROCEDURE

1. Select **Network > Project Sharing and Permissions**.
2. In the **Project & Tracks** column, select the project name.
This way, the settings you make affect the entire project, rather than separate tracks.

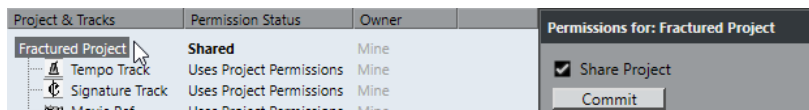

3. In the **All Users** column, select the users you want to share the project with.
4. Click **Add User to Permission List**.
The selected users are added to the **User Name** column.

5. In the **User Name** column, activate the **r** and **w** columns to activate the read and write permissions for the added users.
-

RELATED LINKS

[Adding Permission Presets](#) on page 1189

[Setting Up Permissions for Separate Tracks](#) on page 1191

Setting Up Permissions for Separate Tracks

You can specify read and write permissions separately for each track in the project.

PROCEDURE

1. Select **Network > Project Sharing and Permissions**.
2. In the **Project & Tracks** column, select the tracks for which you want to make separate settings.

The right part of the dialog now only contains the option **Override Project Permissions**.

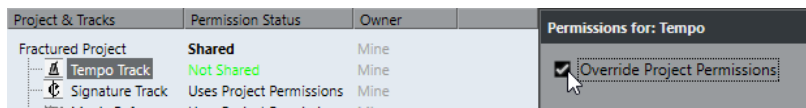

3. Activate **Override Project Permissions**.
 4. Add users and specify their read and write permissions for the tracks.
 5. When you are done, go back to the **Project & Tracks** column, and select the project name again.
-

RESULT

The separate track permissions are set up. You can also set up separate track permissions in the **Network** section of the **Inspector**.

NOTE

Permission settings for separate tracks are not saved in a permission preset.

RELATED LINKS

[Setting Up Permissions Manually](#) on page 1190

[Loading Permission Presets](#) on page 1190

[Network Inspector Section](#) on page 1201

Project Folder Location

You can save your project folder on the local hard disk or on a file server.

If you save the project folder on your local hard disk, the project files are copied to the hard disks, and project folders of the other users. All editing is done locally and updates are copied to the hard disks of the other users.

If you save the project folder on the server, the project files are accessed directly on the server. All editing is done on the server. This may be slower, but the files do not need to be copied to each hard disk every time they are updated.

RELATED LINKS

[Joining Projects](#) on page 1193

Large Media Files

If you have a fast file server, you should place large media files on this server to avoid excessive network traffic.

If you use a Windows workstation and you connect your file server using a drive letter, Nuendo treats this server as a local drive, and copies any data from over the Nuendo network.

Therefore, try placing your large files on a file server and import them into Nuendo without activating **Copy File to Project Folder/Copy All Files to Project Folder** in the **Import Options** dialog. The server path should now be displayed in the **Pool**.

RELATED LINKS

[Import Options Dialog for Audio Files](#) on page 312

Sharing Projects

You can share your project with other user in the network.

PREREQUISITE

You have set up all the users and specified their permissions.

PROCEDURE

1. Select **Network > Project Sharing and Permissions**.
2. Activate **Share Project**.

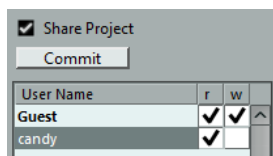

RESULT

The project is now shared and available to the users you have specified.

AFTER COMPLETING THIS TASK

If you add or remove users and change permissions, click **Commit** to update the shared project accordingly for all users.

RELATED LINKS

[Project Sharing and Permissions Dialog](#) on page 1199

Loading Shared Projects in a Disconnected Network

If you load a shared project and the network function is deactivated in Nuendo, you must decide what should happen.

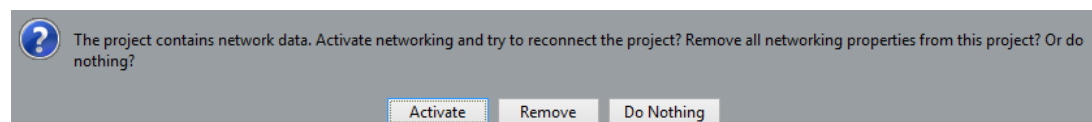

- You can activate the network in Nuendo and reconnect the project by clicking **Activate**.
- You can remove all network settings to no longer work in the network by clicking **Remove**.
- You can open the project without changing any network settings by clicking **Do Nothing**.

Joining Projects

You can join projects that other users shared in the network.

PREREQUISITE

The user that owns the project is online and you have read and/or write access to the project.

PROCEDURE

1. Select **Network > Active**.
2. Select **Network > Shared Projects**.
3. Click the plus sign next to the user name that owns the project that you want to join.
All established users in a LAN are listed under **Users in Local Network**. All users with whom you have established WAN connections are listed under **Global IP Network**. Shared projects that you can join are indicated by the label **You can join**.
4. Select a project and click **Join Project**.

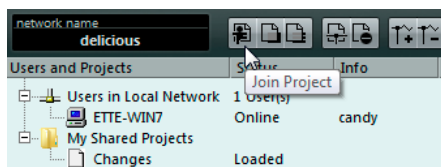

5. Select a project folder.

NOTE

- If you are connected over a LAN, and the owner of the project keeps the project files in a special, common project folder on a server, you can specify this folder as the project folder.
 - If the owner of the project keeps the project files in a project folder on a local hard disk, select a local folder on your hard disk. In this case, the project files are copied to the project folder on your hard disk.
-

RESULT

If you selected a project folder, the project and the files are copied to your hard disk, unless you're working on a server.

If you just have access to separate tracks, only the tracks for which you have read or write permission are loaded.

RELATED LINKS

[Setting Up WAN Connections](#) on page 1186

[Project Folder Location](#) on page 1191

Downloading Selected Tracks

You can select tracks from shared projects and download them to your computer.

PROCEDURE

1. Select **Network > Shared Projects**.
2. Select the tracks that you want to download, and click **Download Selected Tracks**.
3. Decide, if you want to create a new project or download the tracks to the active project.

NOTE

You cannot download tracks into a shared project.

RELATED LINKS

[Shared Projects Dialog](#) on page 1199

Merging Projects to Network Projects

You can merge the active project to a network project.

PROCEDURE

1. Activate the project that you want to merge to the network project.
 2. Select **Network > Shared Projects**.
 3. Click **Merge Active Project to Selected Network Project**.
You are asked, if you want to download the shared project before merging.
 - Click **No** to commit your tracks.
 - Click **Yes** to download all available tracks and commit your tracks after completion.
 4. In the **Project Sharing and Permissions** dialog that opens, click **Start Merge**.
-

Disconnecting from Projects

You can disconnect from projects that you no longer want to work on.

PROCEDURE

1. Select **Network > Active** to deactivate the network.
 2. In the dialog, click **Yes** to confirm that you want to disconnect from the network.
-

RESULT

Your project is now disconnected from the network. However, as long as the owner shares it with you, you still have access to the project.

AFTER COMPLETING THIS TASK

You can reactivate the network by selecting **Network > Active** again. In the dialog you must confirm that you want to reconnect to the network. If the project is accessible on the network, you will rejoin it and all the project files are loaded.

Working with Shared Projects

Any user who has write access to a shared project or separate tracks in it can make changes and commit these to the other users.

RELATED LINKS

[Setting Up Permissions for Separate Tracks](#) on page 1191

[Track Controls Settings Dialog](#) on page 121

Committing Changes to Tracks

You can commit changes to tracks to the other users in the network.

PROCEDURE

1. Select the tracks that contain the changes that you want to commit.
2. In the **Inspector** for the track, open the **Network** section.
3. Click **Commit changes on this track**.

RESULT

The changes are committed to the network.

IMPORTANT

Depending on the speed of the network, it may take some time before the changes are distributed to all users and work can continue.

RELATED LINKS

[Setting Up Permissions for Separate Tracks](#) on page 1191

[Network Inspector Section](#) on page 1201

Committing Changes to Projects

You can commit changes to projects to the other users in the network.

PROCEDURE

- Do one of the following:
 - Select **Network > Commit Changes**.
 - On the **Project** window toolbar, click **Commit Changes**.

NOTE

To show the **Network Controls** on the **Project** window toolbar, right-click in an empty area of the toolbar and activate **Network Controls**.

RESULT

The changes are committed to the network.

IMPORTANT

Depending on the speed of the network, it may take some time before the changes are distributed to all users and work can continue.

RELATED LINKS

[Network Controls on the Toolbar](#) on page 1202

Loading Changes

You can load changes from other users.

PROCEDURE

- Do one of the following:

- Click **Load available update** in the track controls or in the **Inspector** for the track.
This loads the available update for the track.
- Click **Automatically apply updates** in the track controls or in the **Inspector** for the track.
This automatically loads all changes without requiring your intervention.
- On the **Project** window toolbar, click **Sync project to network state**.
This loads new tracks, and changes made to the tempo and signature tracks.

NOTE

To show the **Network Controls** on the **Project** window toolbar, right-click in an empty area of the toolbar and activate **Network Controls**.

RESULT

The changes from the other users are loaded.

AFTER COMPLETING THIS TASK

To undo updates, select **Edit > Undo Net Update**.

RELATED LINKS

[Network Controls on the Toolbar](#) on page 1202

[Network Track Controls](#) on page 1202

[Network Inspector Section](#) on page 1201

[Track Controls Settings Dialog](#) on page 121

Showing the Transfer Status

Transfer of network data always is performed in the background, but you can check on the progress of your transfer processes, if you wish.

PROCEDURE

- Select **Network > Transfer Status**.

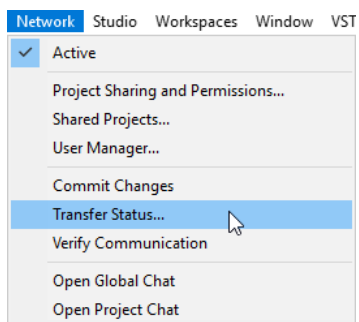

RESULT

The transfer status for every track is displayed during the upload or download of project data. You can cancel each of the transfer operations, if necessary.

Resolving Network Communication Problems

Sometimes, network communication problems occur, and the network communication with a participant fails.

PROCEDURE

1. Select **Network > Verify Communication**, to initiate a communication verification process. A dialog lists each participant with whom communication still failed.
2. Do one of the following:
 - If you believe that the communication problems are temporary, select **No**. Wait to see if communications can be restored and perform the verification process later.
 - If you believe that the communication problems are more severe, for instance if the participants have disconnected their network, select **Yes**. This removes the participants from the network until they are able to rejoin again.
 - If the verification process does not solve the problem, the communication problems are probably of a more serious nature and may require re-configuration of the network settings.

RELATED LINKS

[Verifying the Communication](#) on page 1187

[Network Requirements](#) on page 1186

Reconnecting Users to the Master Network Project

You can reconnect participants that have been unexpectedly disconnected from the network.

PREREQUISITE

NOTE

This only works if a master project exists.

PROCEDURE

1. Open the master project. The program automatically searches for the users in the network.
2. In the dialog, select **Reconnect**, to reconnect the participants.

NOTE

If you are unsure about the state of connection, select **Unshare** to unshare the project and submit it as a new network project, in order to avoid conflicts.

Chatting

You can chat with other users of shared projects. All network users can see the same chat window.

- Select **Open Global Chat**, type in your message in the window that opens and press **Return**.
- Select **Open Project Chat**, type in your message in the window that opens and press **Return** to chat only with the users working on the shared project.

NOTE

You can only see messages that were entered after you joined the chat.

User Manager Dialog

The **User Manager** dialog allows you to set up lists of users, define their read and write permissions and save the settings as a permission preset.

- To open the **User Manager** dialog, select **Network > User Manager**.

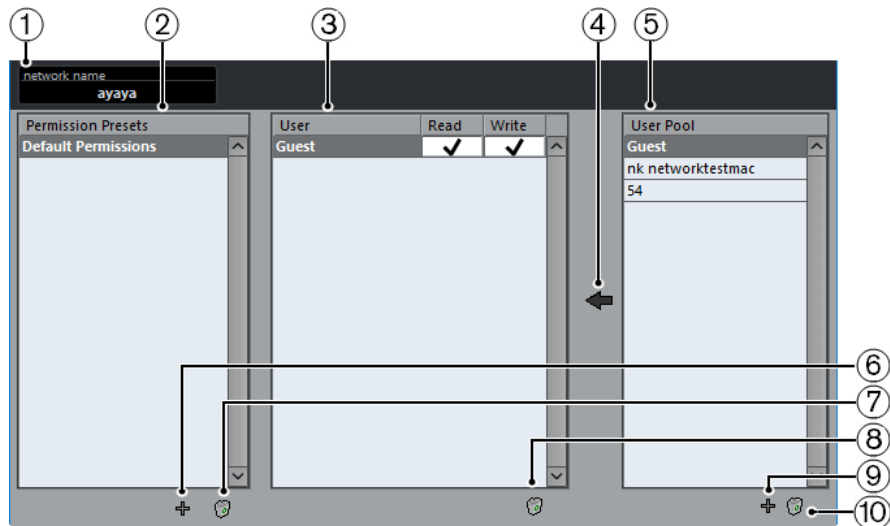

- 1 Network Name**
Shows the name of the network.
- 2 Permission Presets**
Lists the permission presets.
- 3 Users**
Lists the users that are added to the selected permission preset.
- 4 Add selected Users to Permission Preset**
Allows you to add users to the selected permission preset.
- 5 User Pool**
Lists all the users who have entered a user name, and who have been online and established in the network at some point. The users do not need to be online to be listed.
- 6 Create a new Permission Preset**
Allows you to add a new permission preset.
- 7 Delete selected Permission Preset**
Deletes the selected permission preset.
- 8 Remove selected Users from Permission Preset**
Removes the selected users from the permission preset.
- 9 Add new User to your User Pool**
Allows you to add a new user to the user pool.
- 10 Remove selected Users from the User Pool**
Removes the selected user from the user pool.

Shared Projects Dialog

The **Shared Projects** dialog shows a list of all identified users and shared projects in the network, and allows you to connect to WAN (Wide Area Network) users.

- To open the **Shared Projects** dialog, select **Network > Shared Projects**.

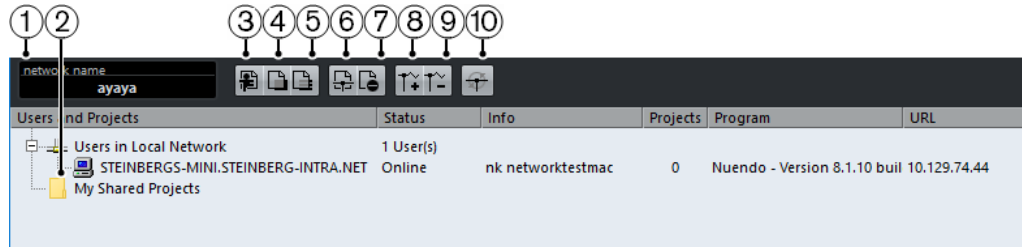

- 1 Network Name**
Shows the name of the network.
- 2 My Shared Projects**
Shows the active project that is shared.
- 3 Join Project**
Allows you to join the project that is selected in the list, and opens a dialog that allows you to specify the project folder.
- 4 Merge Active Project to Selected Network Project**
Merges the active project to the selected network project.
- 5 Download Selected Tracks**
Downloads the selected tracks to your computer.
- 6 Share Active Project**
Opens the **Project Sharing and Permissions** dialog where you can verify all permissions before sharing the project.
- 7 Unshare Selected Project**
Revokes sharing of the selected project.
- 8 Add WAN Connection**
Allows you to add a WAN connection.
- 9 Remove WAN Connection**
Removes the selected WAN connection.
- 10 Rescan Network**
Allows you to update the network information. The list of online users connected via LAN is updated and shown under **Users in Local Network**. The list of online users connected via WAN is updated and shown under **Global IP Network**.

Project Sharing and Permissions Dialog

The **Project Sharing and Permissions** dialog allows you to specify the user permissions for the active project.

- To open the **Project Sharing and Permissions** dialog, select **Network > Project Sharing and Permissions**.

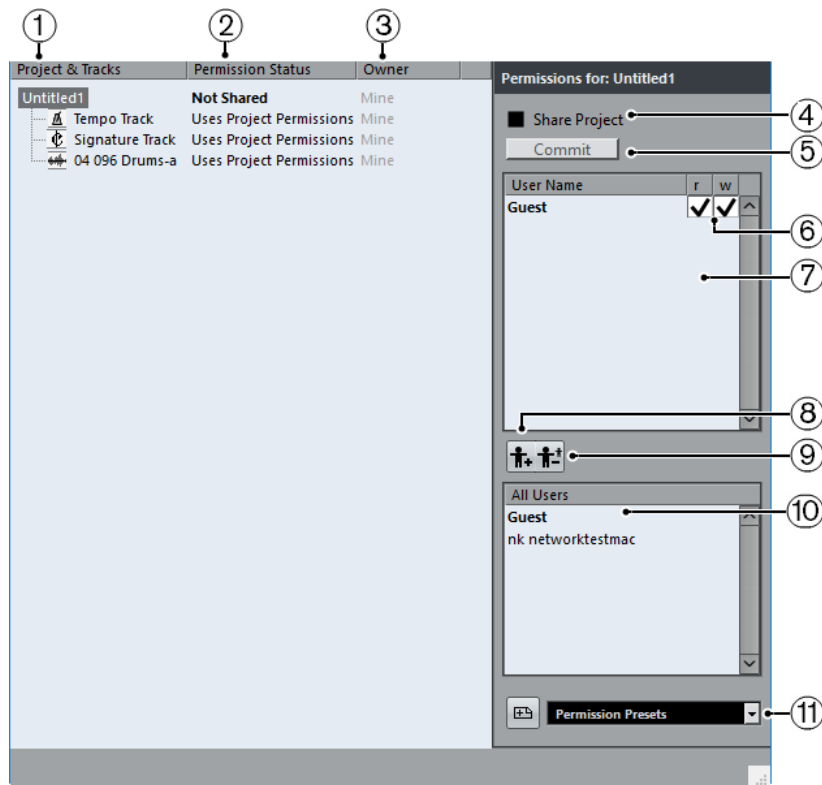

1 Project & Tracks

Lists the currently active project and its tracks.

NOTE

Select the project to make sure the settings you make affect the entire project, rather than separate tracks.

2 Permission Status

Shows the permission status of the project or track.

3 Owner

Shows the owner of the project or track.

4 Share Project

Shares the project with the specified users. This is only available, if you own the project.

5 Commit

Commits your changes to the other users.

6 Permission List

Shows the users that you added to the permission list.

7 Read/Write

Allows you to activate the project read and write permissions. Activating write permission automatically activates read permissions.

8 Add User to Permission List

Adds the users that you select in the **All Users** list to the permission list.

9 Delete User from Permission List

Removes the selected users from the permission list.

NOTE

If you do not want everyone in the network to have full access your the project, remove the **Guest** user.

10 All Users

Lists all users in the network that have entered user names and are established in the network, along with the default **Guest** user. Select the users that you want to share your project with.

11 Permission Presets

Allows you to set up which users should be allowed to join a project, and what read and write permissions they should have.

Network Inspector Section

The **Network** section in the **Inspector** shows the network connection of the track. It allows you to handle the communication and transfer of updated files.

- To show the **Network** section, right-click in the **Inspector** and activate **Network**.

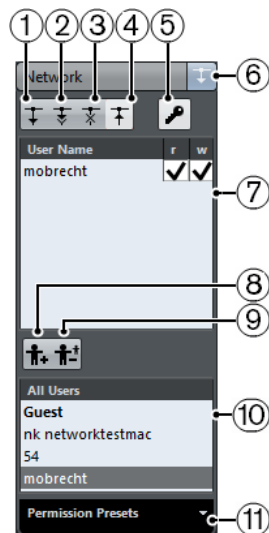

1 Load available update

Loads available updates for the track.

2 Automatically apply updates

Automatically loads all changes from other users.

3 Get exclusive access

Locks the track for your exclusive use.

NOTE

If you click **Get exclusive access** for a track that was locked by another user, a warning message appears. If you are the owner of the project or track, you can unlock it by selecting **Release Lock**.

4 Commit changes on this track

Commits your changes to the network.

5 Override Project Permissions

This is only available for track owner. Overrides the project permissions and allows you to set up permissions for the track.

6 Permission status

Shows the permission status for the track. If shown in a lighter color, you have both read and write access. If shown in orange, you have only read access.

7 Users

Lists the users that are added to the selected permission preset.

8 Add User to Permission List

Adds the users that you select in the **All Users** list to the permission list.

9 Delete User from Permission List

Removes the selected users from the permission list.

NOTE

If you do not want everyone in the network to have full access your the project, remove the **Guest** user.

10 User Pool

Lists all the users who have entered a user name, and who have been online and established in the network at some point. The users do not have to be online to be listed.

11 Permission Presets

Allows you to set up which users should be allowed to share a project, and what read and write permissions they should have.

Network Controls on the Toolbar

The network controls in the **Project** window toolbar allow you to share or synchronize your project and to commit changes.

- To show the **Network Controls** on the **Project** window toolbar, right-click in an empty area of the toolbar and activate **Network Controls**.

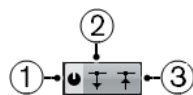

1 Share Project

Shares the project with the specified users.

2 Sync Project to Network State

Lights up if there are changes available. Click to get new tracks and changes.

3 Commit Changes

Commits your changes to the other users.

Network Track Controls

- To show the network track controls, right-click on a track and select **Track Control Settings**. In the **Track Controls Settings** dialog, add **Network Controls** to the list of visible controls.

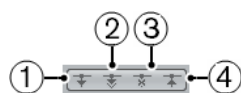

1 Load available update

Loads available updates for the track.

2 Automatically apply updates

Automatically loads all changes from other users.

3 **Get exclusive access**

Locks the track for your exclusive use.

NOTE

If you click **Get exclusive access** for a track that was locked by another user, a warning message appears. If you are the owner of the project or track, you can unlock it by selecting **Release Lock**.

4 **Commit changes on this track**

Commits your changes to the network.

RELATED LINKS

[Track Controls Settings Dialog](#) on page 121

Synchronization

Synchronization is the process of getting 2 or more devices to play back together at the same speed, position, and phase. These devices can range from audio and video tape machines to digital audio workstations, MIDI sequencers, synchronization controllers, and digital video devices.

If you know the position and speed for the master device, you can resolve the speed and position of the slave device to it, so that the 2 devices play in perfect sync with one another.

Position (Time)

The following clock signals are used to specify time positions:

- **Audio word clock**
Specifies time positions in samples.
- **Timecode**
Specifies time positions in video frames.
- **MIDI clock**
Specifies time positions in musical bars and beats.

Speed (Clock)

The following clock signals measure the speed of a device:

- **Audio word clock**
Measures the sample rate.
- **Timecode**
Measures the frame rate.
- **MIDI clock**
Measures the tempo.

Phase

Phase is the alignment of the position and speed components to each other. Each pulse of the speed component should be aligned with each measurement of the position for the most accuracy. Each frame of timecode should be perfectly lined up with the correct sample of audio. Put simply, phase is the very precise position of a synchronized device relative to the master (sample accuracy).

Master and Slave

Calling one device the master and another one the slave can lead to confusion. Therefore, the timecode relationship and the machine control relationship must be differentiated in this regard.

- **Timecode Master**
The device generating position information or timecode.
- **Timecode Slave**
Any device receiving the timecode and synchronizing or locking to it.
- **Machine Control Master**

The device that issues transport commands to the system.

- **Machine Control Slave**

The device receiving timecode commands and responding to them.

Nuendo can be the machine control master, sending transport commands to an external device which in turn sends timecode and audio clock information back to Nuendo. In that case, Nuendo would also be the timecode slave.

NOTE

In most scenarios, the machine control slave is also the timecode master. Once it receives a play command, that device starts generating timecode for all the timecode slaves to synchronize to.

Timecode Formats

The position of any device is most often described using timecode. Timecode represents time using hours, minutes, seconds, and frames to provide a location for each device. Each frame represents a visual film or video frame.

The following timecode formats are supported:

- **LTC**

Longitudinal timecode or LTC is an analog signal that can be recorded on tape. It should be used for positional information primarily. It can also be used for speed and phase information as a last resort if no other clock source is available.

- **VITC**

Vertical interval timecode or VITC is contained within a composite video signal. It is recorded onto video tape and is physically tied to each video frame.

- **MTC**

MIDI timecode or MTC is identical to LTC except that it is a digital signal transmitted via MIDI.

- **Sony P2 (9-Pin, RS-422) Machine Control**

Sony P2 machine control also has a timecode protocol that is mainly used for locating and is not nearly accurate enough for speed and phase. It can be used in certain situations where there is no alternative.

NOTE

The Steinberg **SyncStation** is capable of using 9-Pin timecode in a very accurate manner.

Timecode Standards

Timecode has several standards. The subject of the various timecode formats can be very confusing due to the use and misuse of the shorthand names for specific timecode standards and frame rates. The timecode format can be divided into 2 variables: frame count and frame rate.

Frame count (frames per second)

The frame count of timecode defines the standard with which it is labeled. There are 4 timecode standards:

24 fps Film (F)

This frame count is the traditional count for film. It is also used for HD video formats and commonly referred to as 24 p. However, with HD video, the actual frame rate or

speed of the video sync reference is slower, 23.976 frames per second, so timecode does not reflect the actual real time on the clock for 24 p HD video.

25 fps PAL (P)

This is the broadcast video standard frame count for European (and other PAL countries) television broadcast.

30 fps non-drop SMPTE (N)

This is the frame count of NTSC broadcast video. However, the actual frame rate or speed of the video format runs at 29.97 fps. This timecode clock does not run in real time. It is slightly slower by 0.1 %.

30 fps drop-frame SMPTE (D)

The 30 fps drop-frame count is an adaptation that allows a timecode display running at 29.97 fps to actually show the clock-on-the-wall-time of the timeline by dropping or skipping specific frame numbers in order to catch the clock up to real time.

NOTE

Remember to keep the timecode standard (or frame count) and frame rate (or speed) separate.

Frame rate (speed)

Regardless of the frame counting system, the actual speed at which frames of video go by in real time is the true frame rate.

Nuendo supports the following frame rates:

23.98 fps

This frame rate is used for film that is being transferred to NTSC video and must be slowed down for a 2-3 pull-down telecine transfer. It is also used for the type of HD video referred to as 24 p.

24 fps

This is the true speed of standard film cameras.

24.98 fps

This frame rate is commonly used to facilitate transfers between PAL and NTSC video and film sources. It is mostly used to compensate for some error.

25 fps

This is the frame rate of PAL video.

29.97 fps/29.97 dfps

This is the frame rate of NTSC video. The count can be either non-drop or drop-frame.

30 fps/30 dfps

This frame rate is not a video standard anymore but has been commonly used in music recording. Many years ago, it was the black and white NTSC broadcast standard. It is equal to NTSC video being pulled up to film speed after a 2-3 telecine transfer. The count can be either non-drop or drop-frame.

50 fps

This rate is also referred to as 50 p.

59.94 fps

This video frame rate is supported by high definition cameras and is compatible with NTSC.

60 fps

This video frame rate is supported by many high definition cameras. However, the NTSC compatible 59.94 fps frame rate is much more common.

IMPORTANT

Video formats with a variable frame rate (VFR) are not supported.

Frame count vs. frame rate

Part of the confusion in timecode stems from the use of frames per second in both the timecode standard and the actual frame rate. When used to describe a timecode standard, frames per second defines how many frames of timecode are counted before one second on the counter increments. When describing frame rates, frames per second define how many frames are played back during the span of one second of real time. In other words: Regardless of how many frames of video there are per second of timecode (frame count), those frames can be moving at different rates depending on the speed (frame rate) of the video format. For example, NTSC timecode (SMPTE) has a frame count of 30 fps. However, NTSC video runs at a rate of 29.97 fps. So the NTSC timecode standard known as SMPTE is a 30 fps standard that runs at 29.97 fps real time.

NOTE

When transferring material between various video formats and film, it becomes necessary to change the speed (frame rate) of one timecode standard so that video or film frames can line up in some mathematical relationship to the destination format. That is where all the various pull-ups and pull-downs come from. Certain frame rates were created as a result of applying a pull-down. For example, 23.976 fps is actually 24 fps pulled down by 0.1 %.

RELATED LINKS

[Film Transfers](#) on page 1265

[Compensating for Speed Changes](#) on page 1268

Clock Sources

Once the position is established, the next essential factor for synchronization is the playback speed. Once 2 devices start playing from the same position, they must run at exactly the same speed in order to remain in sync. Therefore, a single speed reference must be used and all devices in the system must follow that reference. With digital audio, the speed is determined by the audio clock rate. With video, the speed is determined by the video sync signal.

Audio clock

Audio clock signals run at the speed of the sample rate used by a digital audio device and are transmitted in several ways:

Word clock

Word clock is a dedicated signal running at the current sample rate that is fed over BNC coaxial cables between devices. It is the most reliable form of audio clock and is relatively easy to connect and use.

AES/SPDIF Digital Audio

An audio clock source is embedded within AES and SPDIF digital audio signals. This clock source can be used as a speed reference. Preferably, the signal itself does not contain any actual audio (digital black), but any digital audio source can be used if necessary.

ADAT Lightpipe

ADAT Lightpipe, the 8-channel digital audio protocol developed by Alesis, also contains audio clock and can be used as a speed reference. It is transmitted via optical cables between devices.

NOTE

Do not confuse the audio clock embedded in the Lightpipe protocol with ADAT Sync, which has timecode and machine control running over a proprietary DIN plug connection.

Video sync

Video sync signals are transmitted over BNC coaxial connections between devices and run at the frame rate of the video device.

There are 2 types of video sync signals:

- bi-level (also known as black burst)
- tri-level (used for HD video)

Complications arise when a video device is used as a speed reference. The video sync signal must be converted into an audio clock signal in order for audio devices to synchronize at the correct speed. This can be accomplished as follows:

- Using a dedicated synchronizer such as the **SyncStation**.
A dedicated synchronizer can take a video sync signal (among others) and generate either word clock or AES/SPDIF signals that may be used as an audio clock source.
- Using a house sync generator.
A master sync generator such as the Rosendahl Nanosync HD can simultaneously generate video sync and audio clock from the same source. This ensures that both video and audio devices fed by the sync generator will run at the same speed.

NOTE

Some audio cards and interfaces can accept a video sync signal as an audio clock source, performing a similar function to a dedicated synchronizer.

IMPORTANT

Care must be taken to ensure that the incoming video sync frame rate matches that of the Nuendo project.

MIDI clock

MIDI clock is a signal that uses position and timing data based on musical bars and beats to determine location and speed (tempo). It can perform the same function as a positional reference and a speed reference for other MIDI devices. Nuendo supports sending MIDI clock to external devices but cannot slave to incoming MIDI clock.

IMPORTANT

MIDI clock cannot be used to synchronize digital audio. It is only used for MIDI devices to play in musical sync with one another. Nuendo does not support being a MIDI clock slave.

Frame Edge Alignment

There are 1600 samples of audio in one frame of video running at 48 kHz and 29.97 fps. Phase alignment adjusts the playback of Nuendo so that the precise sample of audio is lined up with the leading edge of the timecode frame.

While it is possible to have very good sync without proper phase alignment, it will not be sample-accurate. With Nuendo there are 4 ways of achieving sample-accurate (phase aligned) sync:

- Using Steinberg's **SyncStation** synchronizer.
The **SyncStation** can resolve video sync, word clock, and timecode all in one unit with extensive machine control capabilities.
- Using VST System Link.
VST System Link connects multiple workstations together using digital audio connections. System Link uses the sample clock for position and speed references, ensuring sample-accurate synchronization.
- ASIO Positioning Protocol (APP)
Specific ASIO audio cards that have built in timecode readers support Steinberg's APP. APP is able to analyze the incoming timecode and compare that to the sample clock to provide sample-accurate synchronization.

IMPORTANT

APP is only supported when Nuendo is a timecode slave.

Project Synchronization Setup Dialog

The **Project Synchronization Setup** dialog provides a central place to configure a complex synchronized system. In addition to settings for timecode sources and machine control settings, basic transport controls are available for testing the system.

To open the **Project Synchronization Setup** dialog, do one of the following:

- Select **Transport > Project Synchronization Setup**.
- In the **Transport Bar**, **Ctrl/Cmd**-click **Sync**.

NOTE

If you activate **Steinberg SyncStation** as the input source, there are several options for how these commands are routed within the **SyncStation** itself. For details refer to the documentation that comes with the **SyncStation**.

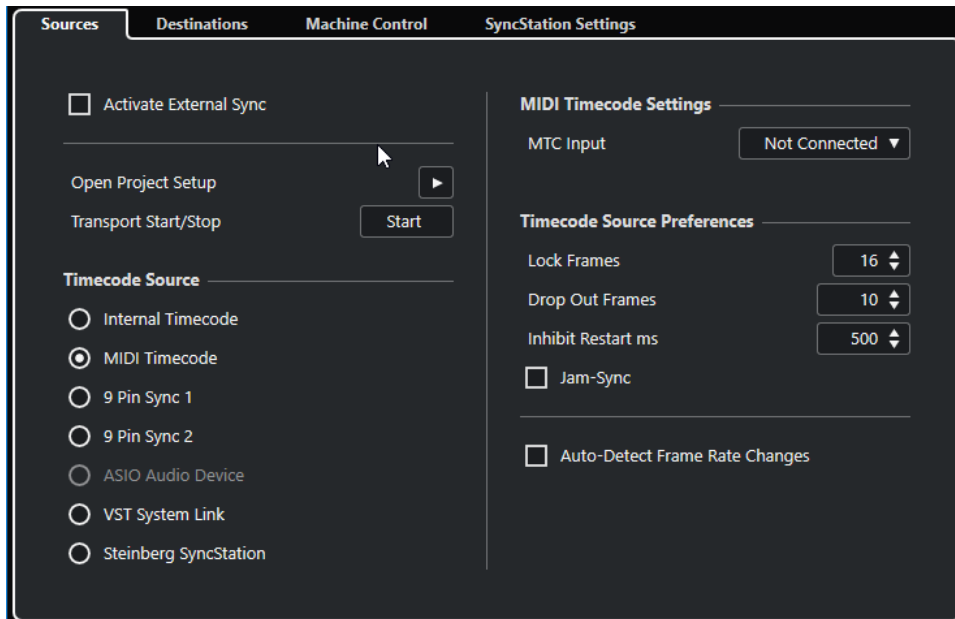

RELATED LINKS

[Sources Page](#) on page 1210

[Destinations Page](#) on page 1213

[Machine Control Page](#) on page 1214

Sources Page

The **Sources** page allows you to set up the synchronization inputs, and to determine which external signals enter the application.

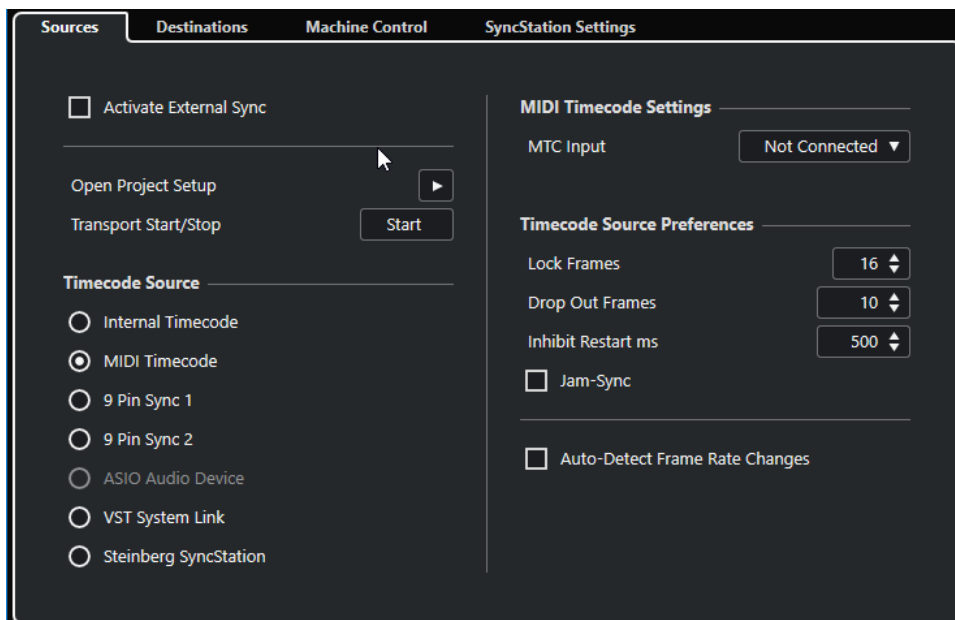

In the topmost section, the following options are available:

Activate External Sync

Activates/Deactivates the external synchronization.

Open Project Setup

Opens the **Project Setup** dialog.

Transport Start/Stop

Starts/Stops playback in Nuendo.

Timecode Source

The **Timecode Source** section allows you to determine whether Nuendo is acting as timecode master or slave. The following options are available:

Internal Timecode

Sets Nuendo as timecode master that generates all position references for any other device in the system based on the project timeline and the **Project Setup** settings.

MIDI Timecode

If **Activate External Sync** is activated, this sets Nuendo as timecode slave to any incoming MIDI timecode. You can select the **MTC Input** ports in the **MIDI Timecode Settings** section.

9 Pin Sync 1 & 2

Sets timecode polling over Sony's 9-Pin RS422 protocol as a timecode source.

IMPORTANT

When using 9-Pin timecode we recommend that you use Steinberg's **SyncStation** hardware. In other scenarios it should only be used if no other timecode source is available.

ASIO Audio Device (Windows only)

Only available for audio cards that support the ASIO positioning protocol. These cards have an integrated LTC reader or ADAT sync port and can perform a phase alignment of timecode and audio clock.

VST System Link

Sets **VST System Link** as timecode source. This allows for all aspects of sample-accurate synchronization between different computers that are connected via **VST System Link**.

Steinberg SyncStation

SyncStation is a full-featured hardware synchronizer with extensive machine control capabilities that provides sample-accurate sync with a variety of external devices. Please refer to the documentation that comes with the unit for setup instructions.

NOTE

Discrepancies between the **Project Frame Rate** and the incoming timecode can cause problems during postproduction, even if Nuendo is able to lock to that timecode.

MIDI Timecode Settings

The **MIDI Timecode Settings** become available if you activate **MIDI Timecode** as a **Timecode Source**.

MTC Input

Allows you to select the MIDI input ports. To allow Nuendo to synchronize to MIDI timecode from any MIDI connection, select **All MIDI Inputs**.

9-Pin Device Settings

If you activate **9 Pin Sync 1** or **9 Pin Sync 2** as a **Timecode Source**, the following **9-Pin Device Settings** become available:

Serial Port

Sets the serial port corresponding to the source of the 9-pin timecode. The two 9-Pin devices connect to your computer from available serial ports. Use the **Serial Port** pop-up menu to select the appropriate serial port.

IMPORTANT

PCs and Apple computers use different types of serial ports. PCs typically provide a RS232 interface on a 9-Pin Dsub connection that must be converted to RS422 in order to interface with Sony 9-Pin devices. Apple computers require a USB to RS422 serial converter such as the Keyspan USA-19W.

Control Playback Speed

Sets Nuendo to control the playback speed of the 9-pin device.

Displays follow locating device

Sets the project cursor to follow the incoming timecode's position. This is helpful with tape-based devices as they locate much slower than non-linear systems. The cursor gives you a visual indication of the position of the tape machine at all times.

Timecode Source Preferences

If you activate **MIDI Timecode** or **Steinberg SyncStation** as a **Timecode Source**, you can set up **Timecode Source Preferences** for working with external timecode. The following options are available:

Lock Frames

Determines how many full frames of timecode it takes for Nuendo to lock, that is, establish synchronization.

NOTE

If you have an external tape transport with a very short start-up time, set **Lock Frames** to a low value to make lock-up even faster.

Drop Out Frames

Sets the number of timecode frames that must be missed until Nuendo stops. Using LTC on an analog tape machine can increase the number of drop outs.

Inhibit Restart ms

Some synchronizers still transmit MTC for a short period after an external tapemachine has been stopped. These extra frames of timecode sometimes cause Nuendo to restart suddenly. **Inhibit Restart ms** allows you to control the amount of time in milliseconds that Nuendo waits before restart (ignoring incoming MTC) once it has stopped.

Jam-Sync

Sets Nuendo to ignore any changes in timecode once it has started playback. This can be useful in special situations, such as synchronizing to broken timecode.

IMPORTANT

If **Jam-Sync** is enabled, the **Drop Out Frames** value is ignored so that Nuendo does not stop if timecode is interrupted.

Auto-Detect Frame Rate Changes

Notifies you about frame rate or timecode changes and interrupts playback or recording. Activate this if you want to diagnose problems with timecode and external devices.

RELATED LINKS

[Activating VST System Link](#) on page 1228

[Project Setup Dialog](#) on page 108

Destinations Page

The **Destinations** page allows you to set up the synchronization outputs, and to determine which external signals leave the application.

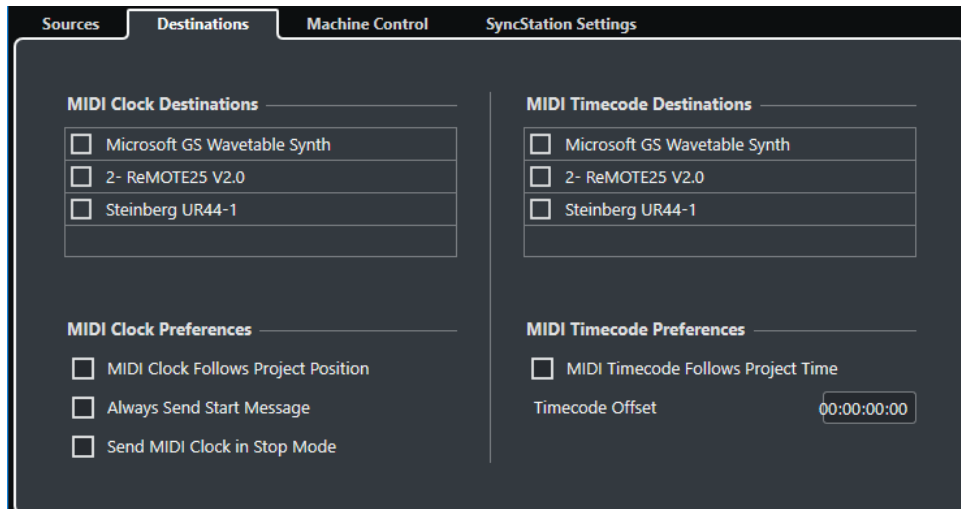

MIDI Clock Destinations

In the **MIDI Clock Destinations** section, you can select any MIDI ports that you want to output MIDI clock. Some MIDI devices, such as drum machines, can match their tempo and location to incoming MIDI clock.

MIDI Clock Preferences

In the **MIDI Clock Preferences** section, the following options are available:

MIDI Clock Follows Project Position

Ensures that the MIDI clock follows Nuendo.

Always Send Start Message

MIDI clock transport commands include start, stop, and continue. Activate this if a MIDI device does not recognize the continue command.

Send MIDI Clock in Stop Mode

Activate this if a MIDI device needs MIDI clock to run continuously in order to operate arpeggiators and loop generators.

MIDI Timecode Destinations

In the **MIDI Timecode Destinations** section, you can specify the MIDI ports to which MTC is routed.

NOTE

Some MIDI interfaces send MTC over all ports by default. If this is the case, only select one port of the interface for the MTC.

MIDI Timecode Preferences

In the **MIDI Timecode Preferences** section, the following options are available:

MIDI Timecode Follows Project Time

Ensures that the MTC output always follows the time position of Nuendo.

Timecode Offset

Allows you to specify an offset to be applied to outgoing MTC. The amount of offset is added or subtracted from the project's current position before being transmitted.

Machine Control Page

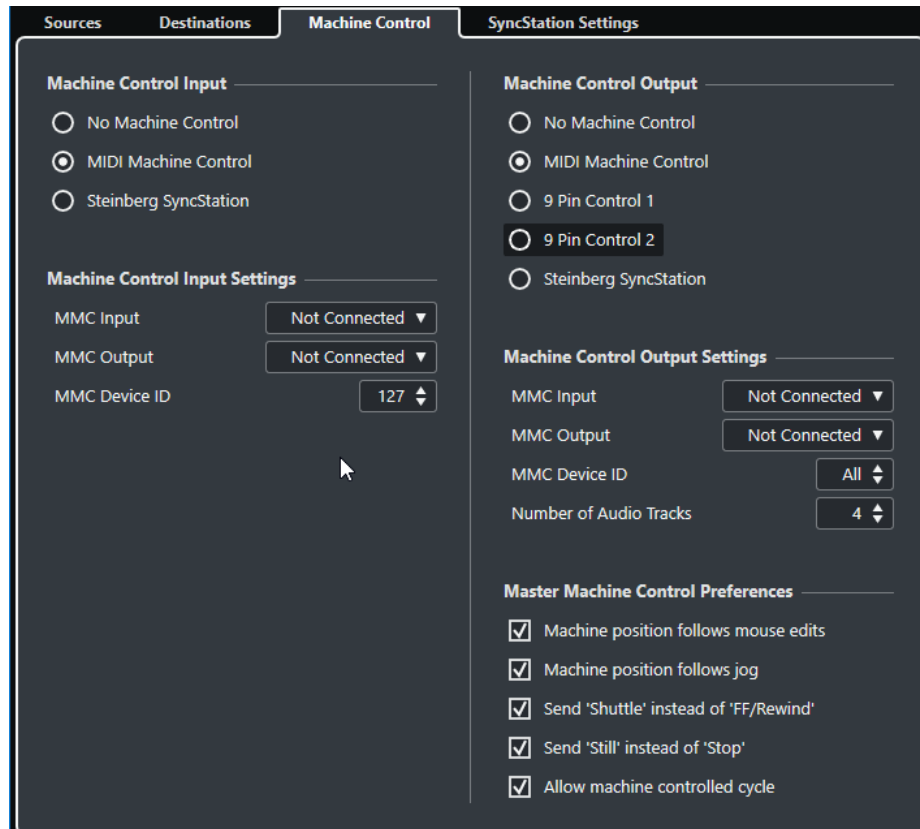

Machine Control Input

Nuendo can follow incoming transport commands and respond to record-enabling commands for audio tracks. This allows Nuendo to easily integrate into larger studio systems with centralized machine control and synchronization such as theatrical mixing stages.

No Machine Control

Deactivates machine control.

MIDI Machine Control

Sets **MIDI Machine Control** as input source. Nuendo receives transport commands from a connected MMC device.

Steinberg SyncStation

If you activate **Steinberg SyncStation** as the input source, there are several options for how these commands are routed within the **SyncStation** itself. For details refer to the documentation that comes with the **SyncStation**.

Machine Control Output

If you **Activate External Sync** on the **Sources** page, all transport commands including project cursor movements are translated into machine control commands and routed according to the settings that are made in the **Machine Control Output** section. The following options are available:

No Machine Control

Transport commands are not routed or sent to any device. This does not affect the operation of the individual 9-Pin and MMC Device panels. They can still function regardless of the machine control destination. The machine control output destination only defines the routing of transport commands from Nuendo while sync is enabled.

MIDI Machine Control

Routes all transport commands from the Nuendo transport to MMC devices connected to the MIDI ports that you defined in the **Machine Control Output Settings** section.

9-Pin Control 1 and 2

Routes transport commands from Nuendo to the 9-Pin Device 1 or 2, as configured in the **Machine Control Output Settings** section. **Activate External Sync** must be enabled on the **Sources** page.

Steinberg SyncStation

Routes transport commands from Nuendo to a connected Steinberg **SyncStation** unit. Please refer to the documentation that comes with your unit for complete information on its operation. **Activate External Sync** must be enabled on the **Sources** page.

Machine Control Output Settings

If **MIDI Machine Control** is activated as **Machine Control Output** section, the following options are available:

If **9-Pin Control 1** or **9-Pin Control 2** is activated as **Machine Control Output**, the following options are available:

Serial Port

The 2 9-Pin devices connect to your computer from available serial ports. Use this pop-up menu to select the appropriate serial port.

NOTE

PCs and Apple computers use different types of serial ports. PCs typically provide a RS232 interface on a 9-Pin D sub connection that must be converted to RS422 in order to interface with Sony 9-Pin devices. Apple computers require a USB to RS422 serial converter such as the Keyspan USA-19W.

Audio Track Count

Allows you to specify how many audio tracks are available. The 9-Pin device panel will then contain the same amount of record-enable buttons.

Mode

The RS422 9-Pin protocol can control a wide variety of devices. Each device may have differing features. Nuendo has a library of device profiles that can be used with 9-Pin devices.

Auto Edit Pre-roll

Auto Edit is a feature of 9-Pin devices that allows for automatic punch in and out on record-enabled tracks. The pre-roll and post-roll times determine where the 9-Pin device will start and stop playback during **Auto Edit**.

Auto Edit Post-roll

Auto Edit is a feature of 9-Pin devices that allows for automatic punch in and out on record-enabled tracks. The pre-roll and post-roll times determine where the 9-Pin device will start and stop playback during **Auto Edit**.

Master Machine Control Preferences

In the **Master Machine Control Preferences** section, the following options are available:

Machine position follows mouse edits

If this option is activated, moving the project cursor with the mouse results in transport commands so that the machine continuously locates to the new cursor position.

If this causes a great deal of unnecessary tape winding, you can deactivate the option. In that case transport commands are only sent to the machine when the mouse button is released.

Machine position follows jog

If this option is activated, turning the jog wheel on a remote controller results in transport commands so that the machine continuously locates to the new project cursor position.

If this causes a great deal of unnecessary tape winding, you can deactivate the option. In that case transport commands are only sent to the machine when the mouse button is released.

Send 'Shuttle' instead of 'FF/Rewind'

Many video decks respond differently to **Shuttle** commands or **FF/Rewind** commands. **FF/Rewind** commands often result in the tape being released from the heads and the motors entering a high-speed wind mode. This takes a great deal of time, and the machine cannot read the timecode on the tape while winding. Therefore position information is lost. Activate this option if shuttle commands are preferred.

Send 'Still' instead of 'Stop'

Similar to **FF/Rewind** commands, **Stop** commands result in the tape being released from the heads. **Still** commands on the other hand, also cause the transport to stop, but without releasing the tape from the heads. Activate this option if you want the picture from the video deck to be visible also in **Stop** mode or if you want the machine to enter playback mode faster.

Allow machine controlled cycle

If this option is activated, Nuendo starts playback at the left locator minus the pre-roll time and stops playback at the right locator plus the post-roll time. When repeating a section, Nuendo locates back to the pre-roll position and waits for the machine to reach that position before issuing a start command.

If this option is deactivated, the machine will not follow when Nuendo cycles. Upon reaching the right locator, Nuendo locates back to the left locator, but the machine continues playback.

MMC Master Panel

- To open the **MMC Master Panel**, select **Studio > More Options > MMC Master Panel**.

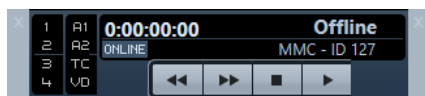

1, 2, 3, 4

Use these buttons to arm tape tracks for recording.

A1, A2, TC, VD

These buttons refer to additional tracks usually found on video tape recorders. Refer to the manual of your VTR device to see if these tracks are supported.

Online

Activate this to use the transport buttons to control the transport of the device.

NOTE

In the **Preferences** dialog, select **MIDI > MIDI Filter**, and make sure **SysEx** is activated in the **Thru** section.

This is necessary because MMC uses 2-way communication where the tape recorder replies to the MMC messages it receives from Nuendo. By filtering out SysEx Thru, you ensure that these MMC system exclusive replies are not echoed back to the tape recorder.

External Synchronization

To activate external synchronization, do one of the following:

- Select **Transport > Activate External Sync**.
- Select **Transport > Project Synchronization Setup**, and on the **Sources** page, activate **Activate External Sync**.
- Transport commands are routed to the machine control destination output as specified in the **Project Synchronization Setup** dialog.
Locate, play, stop, and record commands will now be sent to an external device.
- Nuendo awaits incoming timecode from the chosen timecode source defined in the **Project Synchronization Setup** dialog in order to play.
Nuendo will detect incoming timecode, locate to its current position, and start playback in sync with the incoming timecode.

In a typical scenario, an external tape machine, such as a VTR, has its timecode output connected to Nuendo. Nuendo is sending machine control commands to the deck. When **Activate External Sync** is activated and you click **Start** on the **Transport** panel, a play command is sent to the VTR. The VTR in turn starts playback, sending timecode back to Nuendo. Nuendo then synchronizes to that incoming timecode.

If the **Machine follows mouse edits** is activated and you change the project cursor position with the mouse or key command, machine control commands are sent to the remote deck so it will locate to the new position.

In this way, synchronized operation is somewhat invisible to the user. Just go about editing and mixing while the synchronized devices chase all movements of the cursor automatically.

IMPORTANT

With tape-based devices, synchronized operation will be slower due to the winding time necessary for the tape machine to locate to a new position.

Nuendo's **Edit Mode** will take advantage of this feature by locating the VTR to the start of the first selected event.

RELATED LINKS

[Use Video Follows Edit Mode](#) on page 1258

9-Pin Auto Edit

Most 9-Pin devices such as VTRs have the capability of performing very accurate punch-ins and punch-outs on audio tracks. These punches are tied to video frames and are programmed using timecode. This type of recording is called an **Auto Edit**.

- Select **Studio > More Options > 9-Pin Device** to open the 9-Pin device panel.

Nuendo can use its auto-punch feature to program **Auto Edit** functions of a VTR via 9-Pin control. The left and right locators in the **Project** window define the punch in and punch out of the **Auto Edit**. Provided that Nuendo is in **Sync** mode, pressing the **Auto Edit** button on the 9-Pin device panel causes the punch-in to happen automatically.

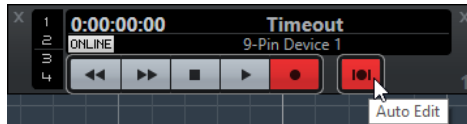

NOTE

Auto Edit can only happen on a timecode frame. Punching in or out in between video frames is not possible.

IMPORTANT

In order to use the 9-Pin device panel to control an external deck, activate **Online** and arm the tracks.

RELATED LINKS

[Machine Control Page](#) on page 1214

Setting up Synchronization for a Personal Music Studio

In a personal music studio, you might want to synchronize with an external recording device such as a portable hard disk recorder used for live remote recordings.

PREREQUISITE

Use MIDI connections for timecode and machine control and Lightpipe digital audio connections for the audio clock and audio signals.

NOTE

- Nuendo should send MMC commands to the hard disk recorder and remotely start playback of the recorder.
 - The hard disk recorder should send back MTC to Nuendo. When the recorder starts playing, MTC is sent back to Nuendo, which will sync to that timecode.
 - The hard disk recorder uses audio clock from the audio interface of Nuendo as the speed reference.
-

PROCEDURE

1. Select **Transport > Project Synchronization Setup**, open the **Sources** page, and in the **Timecode Source** section, activate **MIDI Timecode**.
If you record from the hard disk recorder into Nuendo, Nuendo is the machine control master and the timecode slave, locking to incoming MTC.
2. Open the **Machine Control** page, and in the **Machine Control Output Settings** section, activate **MMC Master Active**.

Nuendo now sends MMC commands to the hard disk recorder to locate and start playback.

3. In the **Machine Control Output Settings** section, select the **MMC Input** and **MMC Output** ports that are connected to the hard disk recorder.

Because MMC uses 2-way communication, both MIDI ports should be connected. Make sure that the MIDI filter does not echo SysEx data.

4. Open the **Sources** page and activate **Activate External Sync**.

This routes transport commands to the hard disk recorder via MIDI and sets Nuendo as the timecode slave.

5. On the hard disk recorder, enable MMC and MTC.

Follow the instructions on how to set up the unit to receive MMC commands and transmit MTC.

6. In Nuendo, start playback.

RESULT

The hard disk recorder starts playback and sends MTC to Nuendo. Once Nuendo syncs to MTC, the status on the **Transport** panel changes to **Lock** and the current frame rate of incoming MTC is shown.

Setting up Synchronization for a Postproduction Suite

In audio for video postproduction, you often need to synchronize with a 9-Pin VTR in order to work with video material. At the same time the audio clock has to be synchronized with the video clock source to ensure that both audio and video run at the same speed.

Finished audio can then be recorded back onto the digital audio tracks of a VTR in perfect sync with the video (known as layback). In this example, 9-Pin machine control is used. The audio clock is a word clock signal generated by the house sync generator that also generates the video sync signal. Timecode is handled by a SMPTE to MTC reader, such as the audio interface.

- The house sync generator creates both the video sync and audio word clock so that the VTR and Nuendo play at the same speed.
When laying back digital audio to the VTR, the AES signal will already be in sync with the VTR's digital audio inputs.
- 9-Pin machine control is used to manipulate the VTR's transport.
The VTR can shuttle, locate, play, and record from commands issued by Nuendo. Also, Nuendo can arm audio tracks on the VTR for layback.
- When the VTR enters play, LTC is fed back to Nuendo which locks to that incoming timecode.
If the LTC reader is part of an audio card that is APP compatible, sample-accurate synchronization is possible in this scenario.

To lay back finished audio to the VTR, proceed as follows:

PROCEDURE

1. Make the connections as shown in the diagram.

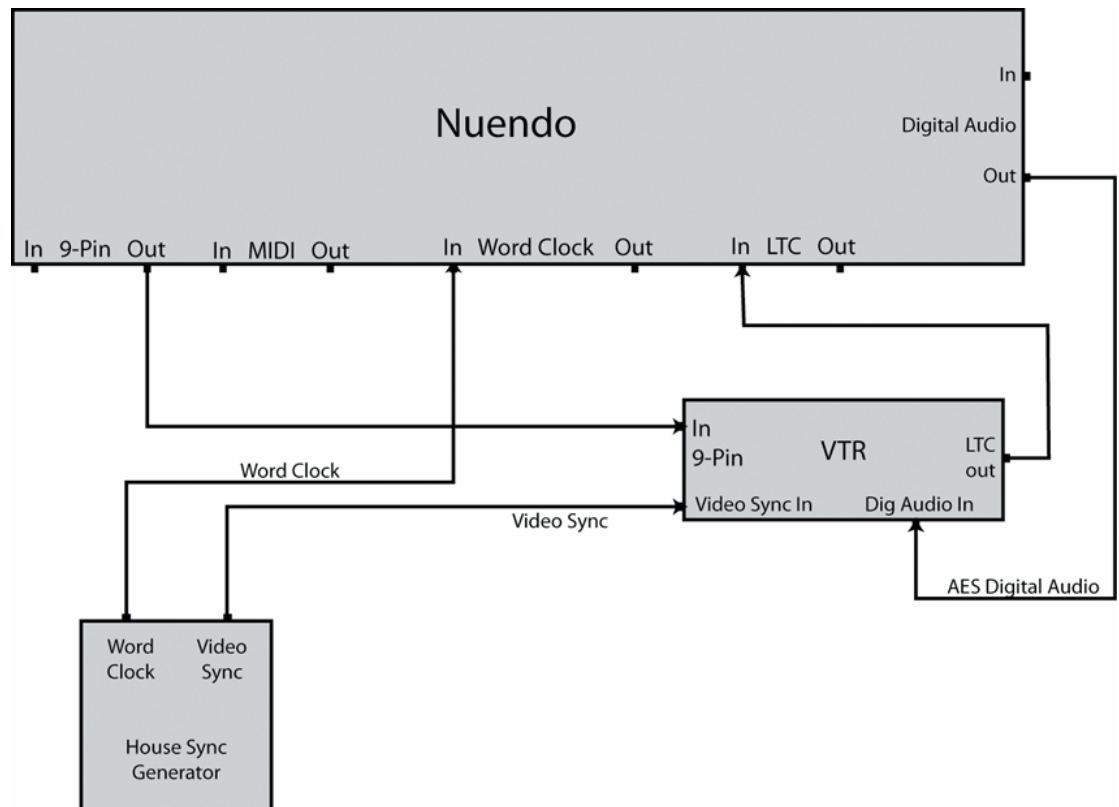

Ensure that video sync and word clock are tied to the same generating source.

2. Select **Transport > Project Synchronization Setup**.
3. On the **Sources** page in the **Timecode Source** section activate **ASIO Audio Device** or **MIDI Timecode**.
Depending on your system's configuration, the sound card might have an LTC reader built into it or you may have to use a LTC to MTC converter interface to get timecode into Nuendo.
4. Open the **Machine Control** page, and in the **Machine Control Output** section, activate **9-Pin Control 1** or **9-Pin Control 2**.
Nuendo's transport buttons will send commands to the VTR over the 9-Pin RS422 connection.
5. Select **Studio > More Options > 9-Pin Device 1** or **Studio > More Options > 9-Pin Device 2**.
Using the **Auto Edit** feature, you will be able to perform laybacks to the VTR via digital audio connections. VTRs with digital audio tracks use 48kHz as a standard sampling rate. Some decks only have 20 bit depth capacity so make sure to dither properly for the intended delivery format.
6. Click **Online**.
Now you can use the device panel to control the VTR.
7. Test the transport with the 9-Pin device panel.
Ensure that all connections are working properly by testing the various transport buttons on the panel.
8. Record-enable the audio tracks that you want to record to.
Most professional VTRs have 4 audio tracks. Many high-definition VTRs have 8 for recording 6-channel surround sound plus a stereo downmix all on the same tape.
9. Play back the project and look at the meters on the VTR to ensure that proper recording levels are set.
That way you can also make sure that the digital audio connections are working properly.
10. Set the left and right locators to the punch in and punch out points.
Auto Edit uses the left and right locators to program the record in and out points of the VTR.

11. Ensure that the pre-roll and post-roll times are appropriate for the VTR.
In most cases, the default values will be sufficient for the VTR to get up to speed before punching in.
 12. On Nuendo's **Transport** panel, activate **Sync**.
This turns Nuendo into a timecode slave. Once the VTR starts to play, Nuendo will sync to incoming timecode.
 13. On the 9-Pin device panel, click **Auto Edit**.
This starts the **Auto Edit** process. The tape transport locates to the set pre-roll position (by default, 5 seconds before the left locator) and starts playback. When the left locator is reached, the VTR enters record mode.
 14. **Auto Edit** is complete when the right locator is reached and the VTR goes out of record.
After reaching the right locator, the VTR continues playing for the set post-roll time (by default 2 seconds) before it stops.
-

Setting up Synchronization for a Theatrical Mixing Stage

A theatrical mixing stage or a dub stage is a large theater-sized room used to create the final mixdown for feature films that will be presented in theaters with surround sound. These types of studios are very complex, dealing with hundreds of audio tracks at once through large mixing consoles along with high-quality video and film playback systems.

In this example, Nuendo is only one part of a very large system of devices that need to be perfectly synchronized with one another. An external master 9-Pin controller will operate the transport of the entire system remotely from the console and timecode will be handled via 9-Pin interface through the **SyncStation**. The audio clock will be referenced to tri-level HD video sync fed to the **SyncStation** which will output dedicated word clock to both Nuendo and the digital console.

- Audio clock is generated out of the video reference signal.
In this example, video sync is being fed to the **SyncStation** as both a speed reference and a phase reference. Word clock goes from the **SyncStation** to Nuendo and the digital console.
- The console is the machine control master, sending 9-Pin control commands and status messages to the **SyncStation**.
The console controls the playback in Nuendo via the **SyncStation**. Nuendo is the timecode slave. The **SyncStation** is acting as a machine control slave.
- Timecode is fed to the **SyncStation** via 9-Pin and then via a USB connection to Nuendo (as MTC).
The **SyncStation** 9-Pin interface is capable of using 9-Pin timecode effectively for accurate synchronization. Direct serial port 9-Pin connections should not be used this way.

To configure Nuendo for this example setup, proceed as follows:

PROCEDURE

1. Make the connections as shown in the diagram.

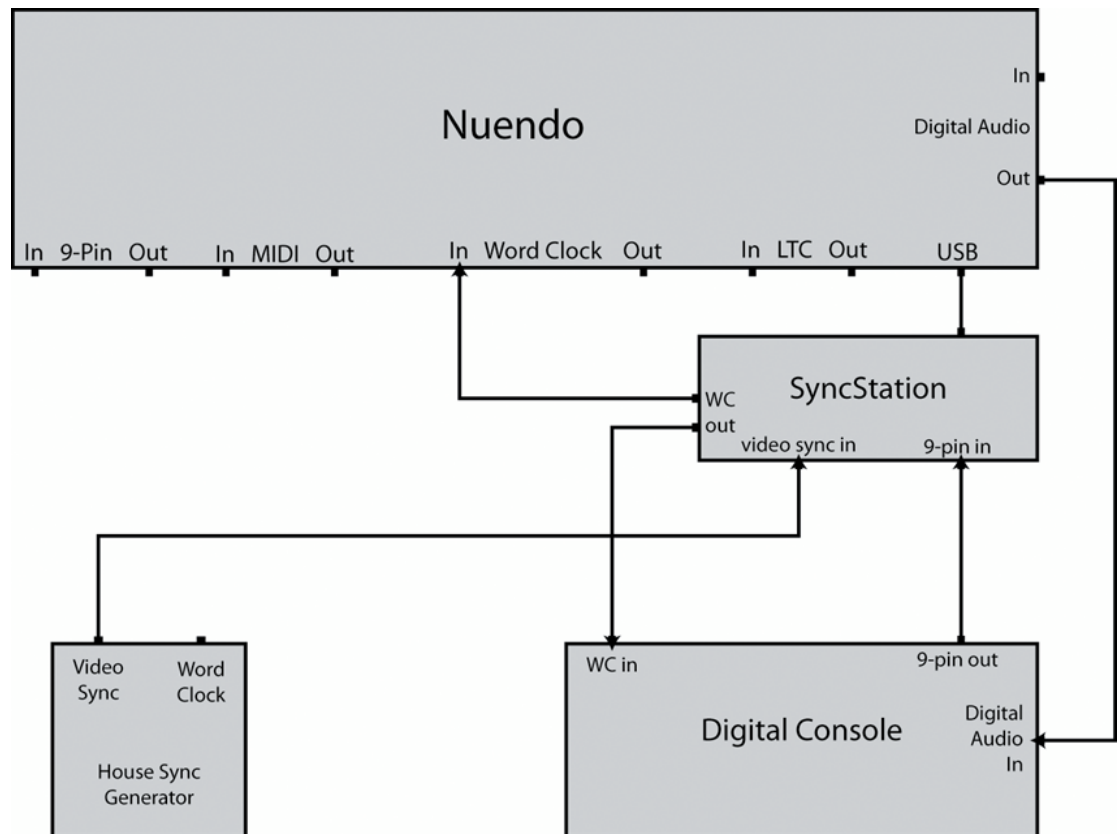

In this example, the **SyncStation** handles many of the synchronization tasks. Please refer to the documentation that comes with the **SyncStation** for complete information on its operation.

2. Select **Transport > Project Synchronization Setup**.
3. On the **Sources** page in the **Timecode Source** section activate **Steinberg SyncStation**. **SyncStation** sends MTC over the USB connection to Nuendo. It uses its **Virtual Master** mode to generate timecode.
4. Open the **Machine Control** page, and in the **Machine Control Input Source** section, activate **Steinberg SyncStation**.
Provided that the **SyncStation** is set to route record and track arming commands to Nuendo, this will allow the digital console to record-enable audio tracks in Nuendo and enter record mode via 9-Pin commands sent to the **SyncStation**.
5. On the **Transport** panel, activate **Sync**.
Nuendo will await incoming timecode from the **SyncStation**.
6. Test the record-enable buttons on the console.
If configured properly, the corresponding audio tracks in Nuendo become record-enabled.
7. Start playback on the console's transport control.
This will send the play commands to the **SyncStation** over 9-Pin and the **SyncStation** will start generating timecode to synchronize Nuendo.

VST System Link

VST System Link is a digital audio network system that allows you to link several computers using digital audio hardware and cables.

Linking up 2 or more computers allows you to split different tasks and different tracks between different computers. You can run CPU-intensive processes, such as send effect plug-ins or VST instruments on one computer, and record audio tracks on another one.

VST System Link supplies transport and sync control, as well as up to 16 MIDI ports, with 16 channels each.

With **VST System Link** the signal is passed from one machine to the next, and eventually returns to the first machine.

For this to work, you need 2 or more computers that use the same or different operating systems, and for each computer in the network, the following:

- Audio hardware with digital inputs and outputs and a specific ASIO driver.
The same digital formats and connection types.
- At least one digital audio cable, such as S/PDIF, ADAT, TDIF, or AES.
- A **VST System Link** host application.

NOTE

You might want to invest in a KVM (Keyboard, Video, Mouse) switchbox. This allows you to use the same keyboard, monitor, and mouse to control each computer in the system, and to switch between computers very rapidly.

Setting up VST System Link

To be able to work with **VST System Link**, you must first set up the network, configure the audio hardware, and set up the digital audio connections.

VST System Link Section

The **VST System Link** section allows you to set up **VST System Link**.

- To open the **VST System Link** section, select **Studio > Studio Setup** and select **VST System Link** in the **Devices** list.

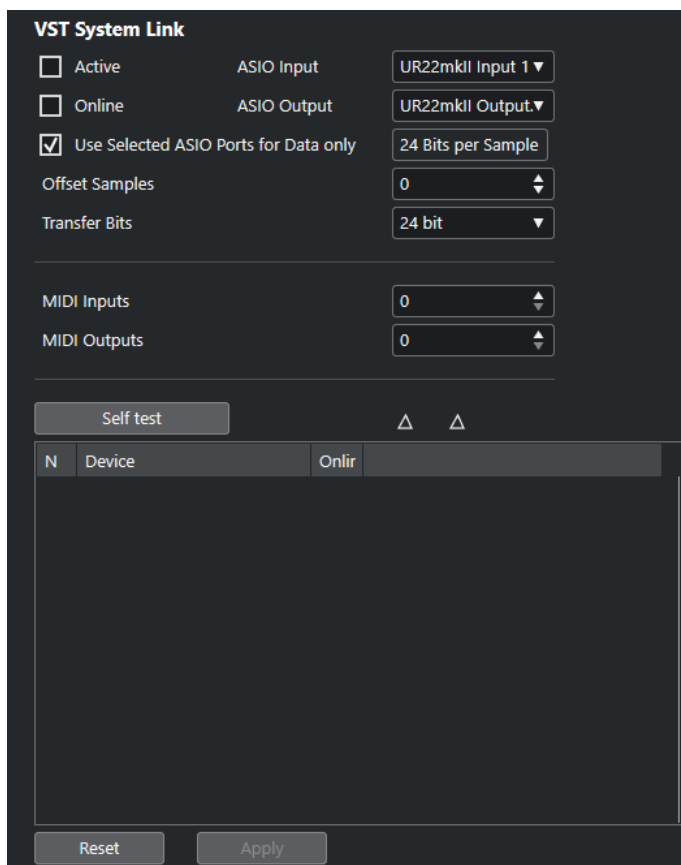

Active

Activates **VST System Link**.

Online

Puts the computer online.

ASIO Input

Allows you to define the networking input channel.

ASIO Output

Allows you to define the networking output channel.

Use Selected ASIO Ports for Data only

Activate this if you want to devote more bandwidth to MIDI, and send **VST System Link** information on the entire channel. This channel is then no longer available for audio transfer.

Offset Samples

Allows you to set an offset for the computer, so that it plays slightly ahead or behind the rest.

Transfer Bits

Allows you to specify whether you want to transfer 24 or 16 bits. This allows you to use older audio cards which do not support transfer of 24 bits.

MIDI Inputs

Allows you to set the number of MIDI input ports.

MIDI Outputs

Allows you to set the number of MIDI output ports.

Self test

Allows you to test the network.

Receiving

Lights up if the computer is active.

Sending

Lights up if the computer is active.

List

Shows the name of each computer.

Setting up a Network

You can set up a network by connecting computers.

PROCEDURE

1. Use a digital audio cable to connect the digital output of computer 1 to the digital input of computer 2.
If you have more than 2 computers, add the others one by one.
2. Use a cable to connect the digital output of computer 2 to the digital input of computer 1.
VST System Link is a daisy chain system, that means, that the output of computer 1 goes to the input of computer 2, the output of computer 2 goes to the input of computer 3, and so on around the chain. The output of the last computer in the chain must always go back into the input of computer 1, to complete the ring.

NOTE

If a card has more than one set of inputs and outputs, choose whichever one that suits you – for simplicity usually the first set is best.

Configuring the Audio Clock

To be able to use **VST System Link**, the clock signals on your ASIO cards must be synchronized correctly.

PREREQUISITE

For each computer in the network, the following must apply:

- The correct audio driver is selected in the **Studio Setup** dialog.
- The clock mode or sync mode is set up in the ASIO control panel of the audio hardware.

PROCEDURE

1. Select **Studio > Studio Setup**.
2. In the **Devices** list, select the your audio hardware.
3. Click **Control Panel**.
4. Set one audio hardware to be the clock master and all other cards to be clock slaves. Consult the documentation if required.

IMPORTANT

If you set up more than one card as clock master, the network cannot function correctly.

However, if you use an external clock from a digital mixing desk or a special word clock synchronizer, for example, you must leave all your ASIO cards in clock slave or

AutoSync mode and make sure that each of them is listening for the signal coming from the synchronizer. This signal is usually passed through your ADAT cables or word clock connectors in a daisy chain fashion.

RESULT

Typically, the ASIO control panel for an audio card contains some indication of whether or not the card receives a proper sync signal, including the sample rate of that signal. This is a good indication that you have connected the cards and set up clock sync properly. Check the documentation of your audio hardware for details.

RELATED LINKS

[Selecting an Audio Driver](#) on page 18

[ASIO Driver Setup Page](#) on page 21

Adjusting the Buffer Size

In a **VST System Link** network, adjusting the buffer size to minimize latency is extra important. This is due to the fact that the latency of a **VST System Link** network is the total latency of all the ASIO cards in the system added together.

PROCEDURE

1. Select **Studio > Studio Setup**.
2. In the **Devices** list, select your audio hardware.
3. Click **Control Panel**.
4. Lower the size of the buffers.

The lower the buffer size, the lower the latency. It is best to keep to fairly low buffer sizes if your system can handle it. About 12 ms or less is usually a good idea.

IMPORTANT

Latency does not affect the synchronization, but it can affect the time it takes to send and receive MIDI and audio signals, or make the system seem sluggish.

Audio Hardware Settings that Affect VST System Link

Specific audio hardware settings might change the digital information in a way that the correct functioning of **VST System Link** is affected.

You can find these settings in the control panel or additional application for your audio hardware. Make sure that the following conditions are met:

- Any additional format settings for digital ports that you use for **VST System Link** data must be turned off.
If you use an S/PDIF connection for **VST System Link**, for example, turn off **Professional format, Emphasis, and Dithering**.
- Any mixer application of your audio hardware that allows for level adjustments of digital inputs and outputs must be disabled.
Alternatively, you can set the levels for the **VST System Link** channels to ± 0 dB.
- Digital signal processing, such as pan or effects, must be turned off for the **VST System Link** signal.
- For RME Audio Hammerfall DSP audio hardware, select the default or plain preset for the **Totalmix** function.

Otherwise signal loops might occur and **VST System Link** cannot work.

Setting up Sample Rates

All projects on all computer must be set up to the same sample rate.

PROCEDURE

1. Select **Project > Project Setup**.
 2. In the **Project Time Displays** section, open the **Sample Rate** pop-up menu and select a sample rate.
-

Setting up Digital Audio Connections

PROCEDURE

1. Select **Studio > Audio Connections**.
 2. Click the **Inputs** tab, and click **Add Bus**.
 3. In the **Add Input Bus** dialog, configure the bus.
 4. Click **Add Bus**.
 5. Click the **Outputs** tab, and click **Add Bus**.
 6. In the **Add Output Bus** dialog, configure the bus.
 7. Click **Add Bus**.
 8. Repeat these steps for all applications.
Set up the same configuration in all applications. If you have 4 stereo output busses on computer 1, you want 4 stereo input busses on computer 2, etc.
 9. Route the applications to the digital inputs and outputs.
-

RELATED LINKS

[Audio Bus Setup](#) on page 24

[Audio Connections Window](#) on page 28

Verifying the Digital Connection

PROCEDURE

1. Connect an audio source to your audio interface.
 2. Start recording, playing back, and mixing.
 3. On computer 1, play back some audio.
 4. Select **Studio > MixConsole**, and route the channel that contains the audio material to one of the digital output busses.
 5. On computer 2, select **Studio > MixConsole**, and locate the corresponding digital input bus.
The audio that is played back should now appear in the application running on computer 2, and the input bus level meters should move.
-

RESULT

You have now verified that the digital connection works as it should. You can reverse this procedure so that computer 2 plays back and computer 1 listens.

Activating VST System Link

You must activate **VST System Link** on all network computers to be able to work with **VST System Link**.

PROCEDURE

1. Select **Transport > Project Synchronization Setup**, and on the **Sources** tab, activate **VST System Link** as the timecode source.
2. Select **Studio > Studio Setup**.
3. In the **Devices** list, select **VST System Link**.

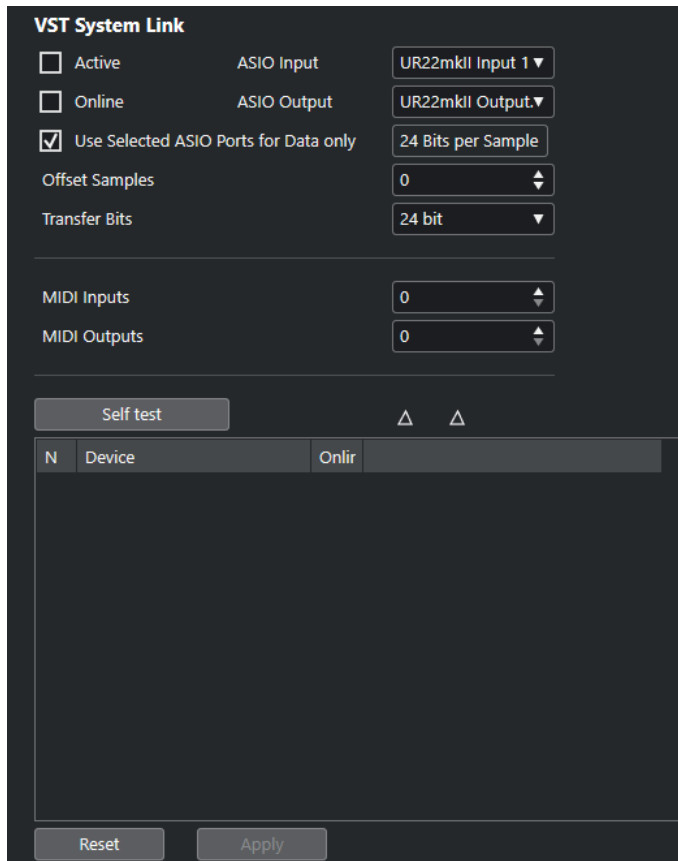

4. Use the **ASIO Input** and **ASIO Output** pop-up menus to define which channel is the networking channel that carries the **VST System Link** information.

NOTE

The networking signal is carried on only one bit of one channel. For an ADAT-based system 7 channels of 24-bit audio and 1 channel of 23-bit audio will be used for networking. You will still have around 138 dB headroom on this channel.

5. Activate **Active** at the top left of the **VST System Link** setup.
 6. Repeat the steps for each computer in the network.
-

RESULT

The sending and receiving indicators on each active computer flash, and the name of each computer appears in the list in the **Self test** section of the dialog. Each computer is assigned a random number.

The name will be shown in the **VST System Link** window of every computer on the network. You can double-click the name of the computer and enter another name.

NOTE

If you do not see the name of each computer, go through the procedure above again and make sure that all ASIO cards are listening to the digital clock signals correctly, and that each computer has the correct inputs and outputs assigned to the **VST System Link** network.

RELATED LINKS

[Sources Page](#) on page 1210

Putting Network Computers Online

You must put the network computers online so that they can send and receive transport and timecode signals, and that their sequencer applications can be started and stopped.

PREREQUISITE

All computers have their tempos set to the same value.

PROCEDURE

1. Select **Studio > Studio Setup**.
 2. In the **Devices** list, select **VST System Link**.
 3. Activate **Online**.
 4. Repeat this for each computer in the network.
-

RESULT

The computers are online now.

AFTER COMPLETING THIS TASK

Start playback on one computer to check if the system is working, and if all computers start and play perfectly in time.

VST System Link sends and understands all transport commands. This allows you to control the entire network from one computer. However, any computer can control any and all of the others. This is due to the fact that **VST System Link** is a peer-to-peer network, and that there is no absolute master computer.

Activating MIDI Ports for VST System Link

You can activate MIDI input and output ports for **VST System Link**. This allows you to route MIDI tracks to VST instruments running on another computer.

PROCEDURE

1. Select **Studio > Studio Setup**.
 2. In the **Devices** list, select **VST System Link**.
 3. Specify the number of MIDI ports you need using the **MIDI Inputs** and **MIDI Outputs** value fields.
 4. Create a MIDI track.
-

RESULT

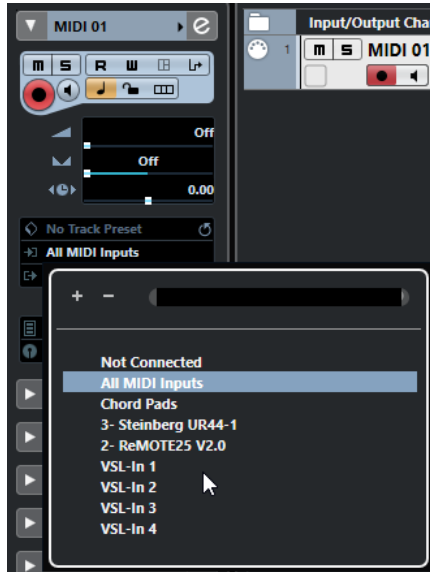

In the top section of the MIDI track **Inspector**, the **Input Routing** and **Output Routing** pop-up menu now show the specified **VST System Link** ports.

This allows you to route MIDI tracks to VST instruments running on another computer.

Application Examples

VST System Link allows you to split different tasks between 2 or more computers. The following application examples should give you an idea of what is possible.

Configuring a Main Mix Computer

Configuring one computer as a main mix computer that receives the audio from your other computers allows you to mix internally in the computer.

In the following example, we assume you are using 2 computers: computer 1 as your main mix computer and computer 2 for 2 additional stereo audio tracks, an FX channel track with a reverb plug-in and a VST instrument plug-in with stereo outputs.

PROCEDURE

1. On computer 1, use an unused set of outputs, such as an analog stereo output, connected to your monitoring equipment to listen to the audio playback.
 2. On computer 2, route each of the 2 audio tracks to a separate output bus connected to the digital outputs, bus 1 and 2, for example.
 3. Route the FX channel track to another **VST System Link** bus, bus 3, for example.
 4. Route the VST instrument channel to yet another bus, bus 4, for example.
 5. On computer 1, check the corresponding 4 **VST System Link** input busses.
If you start playback on computer 2, the audio should appear on the input busses on computer 1. However, to mix these audio sources you need actual mixer channels.
 6. Add 4 new stereo audio tracks on computer 1 and route these to the output bus you use for listening, such as the analog stereo outputs.
 7. For each of the audio tracks, select one of the 4 input busses.
Now, each computer 2 bus is routed to a separate audio channel on computer 1.
 8. Activate monitoring for the 4 tracks.
-

RESULT

If you now start playback, the audio from computer 2 will be sent live to the new tracks on computer 1, allowing you to hear them together with any tracks you play back on computer 1.

AFTER COMPLETING THIS TASK

If you notice a processing delay while you listen to signals coming from your other computers while monitoring, try the following to compensate for latency issues:

- If your audio hardware supports this, activate **ASIO Direct Monitoring** on the **Audio System** device panel for your hardware.
- Alternatively, open the **Studio Setup** dialog, and on the **VST System Link** page, change the **Offset Samples** value.

Configuring a Computer as Submixer

If you have more audio tracks than you have **VST System Link** busses, you can use a computer mixer as a submixer.

PROCEDURE

- Route several audio channels to the same output bus and adjust the output bus level if needed.

NOTE

If your audio cards have multiple sets of input and output connections, you can link up multiple ADAT cables and send audio via any of the busses on any of the cables.

Routing MIDI Tracks to VSTis on Other Computers

You can route MIDI tracks from one computer to VST instruments on another computer. This allows you to use one computer for playback and recording and the other one as a VSTi rack.

PROCEDURE

1. Record a MIDI track into computer 1.
 2. Once you have finished recording, route the MIDI output of that track to **VST System Link** MIDI port 1.
 3. On computer 2, open the **VST Instruments** window and assign an instrument to the first slot in the rack.
 4. Route the VST instrument channel to the desired output bus.
If you are using computer 1 as your main mixing computer, this would be one of the **VST System Link** output busses, connected to computer 1.
 5. Create a new MIDI track in the **Project** window of computer 2 and assign the MIDI output of the track to the VST instrument you created.
 6. Assign the MIDI input of the track to be **VST System Link** port 1.
Now, the MIDI track on computer 1 is routed to the MIDI track on computer 2, which in turn is routed to the VST instrument.
 7. Now activate monitoring for the MIDI track on computer 2, so that it will listen and respond to any MIDI commands coming in.
In Nuendo, click the **Monitor** button in the track list or **Inspector**.
 8. Start playback on computer 1.
It will now send the MIDI information on the track to the VST instrument loaded on computer 2.
-

RESULT

Even with a slow computer you should be able to stack a whole bunch of extra VST instruments this way, expanding your sound palette considerably. Do not forget that **VST System Link** MIDI is also sample-accurate, and thus has much tighter timing than any hardware MIDI interface ever invented!

Routing Audio Sends to Other Computers

The effect sends for an audio channel in Nuendo can either be routed to an FX channel track or to any activated group or output bus. This allows you to use a separate computer as a virtual effect rack.

PROCEDURE

1. On computer 2, the machine you will use as effect rack, add a new stereo audio track.
 2. Add the desired effect as an insert effect for the track.
 3. In the **Inspector**, select one of the **VST System Link** busses as input for the audio track.
 4. Route the channel to one of the **VST System Link** output busses connected to computer 1.
 5. Activate monitoring for the track.
 6. Go back to computer 1 and select a track to which you want to add some reverb.
 7. Open the **Sends** rack for the track in the **Inspector** or the **MixConsole**.
 8. Open the **Send Routing** pop-up menu for one of the sends and select the **VST System Link** bus assigned to the effect.
 9. Use the **Send** slider to adjust the amount of effect as usual.
-

RESULT

The signal will be sent to the track on computer 2 and processed through its insert effect, without using any processor power on computer 1.

You can repeat the steps above to add more effects to the virtual effect rack. The number of effects available this way is only limited by the number of ports used in the **VST System Link** connection, and by the performance of computer 2.

Recording Tracks on Other Computers

You can record tracks on another computer. This is useful if the hard drive on one computer is not fast enough to run as many audio tracks as you need.

PROCEDURE

- Add tracks on another computer and record on them.
-

RESULT

This creates a virtual RAID system, with several disks all operating together. All tracks will remain locked together just as tightly as if they were all running on the same machine.

Playing Back Video on Other Computers

You can play back video on another computer to free up resources for audio and MIDI processing on your main CPU. This is useful as playback of high-resolution video can be quite demanding on the CPU.

PROCEDURE

- Move video tracks to another computer.

RESULT

Since all transport commands respond on the **VST System Link** computers, scrubbing video is possible even when it is coming from another computer. Spotting sound effects to picture in Edit Mode will work the same way as it does on one computer. This is a viable and economic alternative to dedicated hard disk video systems like the Doremi V1.

When scrubbing, the playback on the linked systems may not be perfectly in sync. Also, there are some further restrictions when scrubbing via **VST System Link**:

- Always use the system where you started scrubbing to control the scrubbing.
Changing the scrub speed on a remote system will only change the speed on the local system.
- You can start playback on all systems.
This stops scrubbing and enters playback on all systems in sync.

Video

Nuendo is a full-featured postproduction media tool that allows you to work with video content and create complete soundtracks for your video.

You can play back video files in various formats and via different output devices from within Nuendo, extract the audio material from a video file, compensate for speed changes due to film transfers, and edit sounds and music to the video. The video export function allows you to share your videos with clients or other users.

IMPORTANT

Videos are exported with a resolution of 1920 x 1080 px (Full HD). Video files with a lower or higher resolution than Full HD are upscaled or downscaled on export.

RELATED LINKS

[Audio Editing to Picture](#) on page 1246

[Video File Compatibility](#) on page 1234

[Importing Video Files](#) on page 1236

[Preparations for Video Playback](#) on page 1238

[Film Transfers](#) on page 1265

[Export Video](#) on page 1241

[Extracting Audio from Video](#) on page 1244

Video File Compatibility

When working on a project involving a video file, you must make sure that the video file type works on your Nuendo system.

NOTE

If you are not able to play back a specific video file, use an external application to convert the file into a compatible format.

To find out which video files are supported, refer to the support area at steinberg.net.

RELATED LINKS

[Codecs](#) on page 1235

Video Container Formats

Video and other multimedia files come in a container format.

This container holds various streams of information including video and audio, but also metadata such as synchronization information required to play back audio and video together. Data regarding creation dates, authors, chapter markings, and more can also be held within the container format.

The following container formats are supported by Nuendo:

MOV

This is a QuickTime movie.

MPEG-4

This format can contain various metadata for streaming, editing, local playback, and interchange of content. Its file extension is .mp4.

AVI

This is a multimedia container format introduced by Microsoft.

Codecs

Codecs are methods of data compression used to make video and audio files smaller and more manageable for computers.

For further details, refer to the support area at steinberg.net.

Frame Rates

Nuendo supports different video and film frame rates.

Frame rate (speed)

Regardless of the frame counting system, the actual speed at which frames of video go by in real time is the true frame rate.

Nuendo supports the following frame rates:

23.98 fps

This frame rate is used for film that is being transferred to NTSC video and must be slowed down for a 2-3 pull-down telecine transfer. It is also used for the type of HD video referred to as 24 p.

24 fps

This is the true speed of standard film cameras.

24.98 fps

This frame rate is commonly used to facilitate transfers between PAL and NTSC video and film sources. It is mostly used to compensate for some error.

25 fps

This is the frame rate of PAL video.

29.97 fps/29.97 dfps

This is the frame rate of NTSC video. The count can be either non-drop or drop-frame.

30 fps/30 dfps

This frame rate is not a video standard anymore but has been commonly used in music recording. Many years ago, it was the black and white NTSC broadcast standard. It is equal to NTSC video being pulled up to film speed after a 2-3 telecine transfer. The count can be either non-drop or drop-frame.

50 fps

This rate is also referred to as 50 p.

59.94 fps

This video frame rate is supported by high definition cameras and is compatible with NTSC.

60 fps

This video frame rate is supported by many high definition cameras. However, the NTSC compatible 59.94 fps frame rate is much more common.

IMPORTANT

Video formats with a variable frame rate (VFR) are not supported.

Video Output Devices

Nuendo supports several video output devices.

Viewing video files onscreen in the **Video Player** window may work just fine for many applications, but often it is necessary to display video in a large format for viewing small details and so others involved in the session can also see the video. Nuendo provides the ability to use several types of video output devices to accomplish this.

Dedicated Video Cards

You can use a dedicated video card. Video is sent directly to the output of this video device.

The following video cards are supported:

- Blackmagic Design video output devices

IMPORTANT

- You must install the appropriate driver for the video device and set the video card output to the video file resolution used in your project.
 - Video output via FireWire is not supported.
-

RELATED LINKS

[Video Player Page](#) on page 1238

Preparations for Creating Video Projects

Before you can start working with video in Nuendo, some basic preparations must be made.

In Nuendo, you may work with multiple video files of different formats on the same video track. There can be 2 video tracks per project.

NOTE

For proper synchronization of audio and video events, make sure that the project frame rate matches the frame rate of the video file.

RELATED LINKS

[Project Setup Dialog](#) on page 108

Importing Video Files

If you have a compatible video file, you can import it into your project.

PROCEDURE

1. Select **File > Import > Video File**.
2. In the **Import Video** dialog, select the video file that you want to import.
3. Optional: Activate **Extract Audio from Video** to import any embedded audio streams.

4. Click **Open**.

RESULT

Nuendo creates a video track with a video event. If **Extract Audio from Video** was activated, an audio track with an audio event is positioned below the video track. The corresponding audio clip is saved in the **Pool Record** folder.

NOTE

You can also import video files by dragging them from the **MediaBay**, the File Explorer/macOS Finder and dropping them in your project. If you want Nuendo to automatically extract the audio, activate **Extract Audio on Import Video File** in the **Preferences** dialog (**Video** page).

RELATED LINKS

[Pool](#) on page 675

[Extracting Audio from Video](#) on page 1244

Adopting the Project Frame Rate

To ensure that the time display of Nuendo corresponds to the actual frames in the video, you must set the project frame rate to the frame rate of the imported video file.

PREREQUISITE

The frame rate of the imported video file differs from the project frame rate.

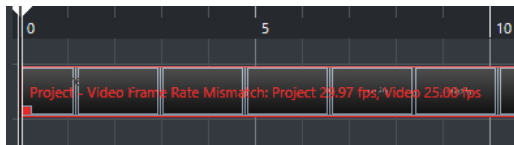

PROCEDURE

1. Select **Project > Project Setup**.
 2. In the **Project Setup** dialog, click **Get Frame Rate from Video**.
 3. Click **OK**.
-

RESULT

- If Nuendo supports the frame rate of the video, the project frame rate is adopted to it. If needed, the project start time is automatically adjusted to reflect the change in frame rate. For example, if the project frame rate is switched from 30 fps to 29.97 fps, the project start time is adopted so that all the events in the project remain at the same positions in relation to real time.

NOTE

If you want the project start time to remain the same, you must manually change it back. In this case, you must snap the video event to the timeline to ensure proper positioning and synchronization within the project.

- If your project contains several video files with different frame rates, the project frame rate is adjusted to the frame rate of the first video event on the upper video track. For proper editing of any other of the imported video files, you must set the project frame rate to the frame rate of that video file.

Thumbnail Cache Files

For every imported video file, Nuendo automatically creates a thumbnail cache file.

RELATED LINKS

[Manually Generating Thumbnail Cache Files](#) on page 1238

Manually Generating Thumbnail Cache Files

You can manually generate thumbnail cache files. This is necessary if a thumbnail cache file could not be generated during import because the folder is write-protected, or because you have edited the file with an external video editing application.

PROCEDURE

- Do one of the following:
 - In the **Pool**, right-click the video file and select **Generate Thumbnail Cache**.
 - In the **Project** window, select the video event and select **Media > Generate Thumbnail Cache**.

NOTE

You can only refresh already existing thumbnail cache files from within the **Pool**.

RESULT

The thumbnail cache file is generated in the background so that you can continue working with Nuendo.

Preparations for Video Playback

You can play back imported video files from within Nuendo by using the transport controls.

For this to work, you must activate and set up a video output device.

IMPORTANT

Your graphics card must support OpenGL 2.0 or higher.

If you work with 2 video tracks in your project, the file on the lower track is played back. To play back a video file that is positioned on the upper video track, change the order of the tracks or mute the lower video track.

Video Player Page

The **Video Player** setup page in the **Studio Setup** dialog allows you to set up your video player, and to check if your video equipment allows for video playback from within Nuendo.

- To open the **Video Player** page, select **Studio > Studio Setup** and activate **Video Player** in the **Devices** list.

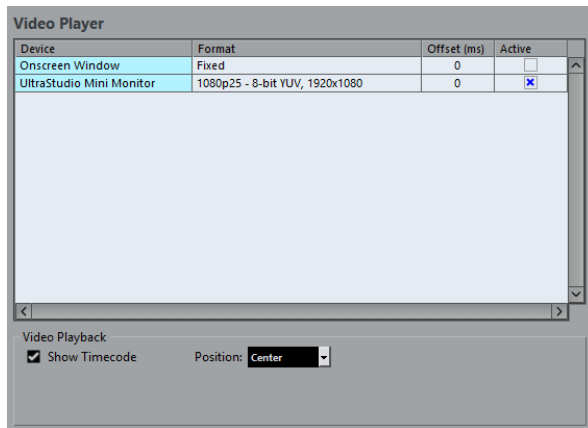

The following options are displayed:

Device

Lists the video output devices that are available on your system.

Format

Allows you to select an output format.

NOTE

The **Onscreen Window** device only supports a fixed format.

Offset

If the video image does not match the audio, you can enter an offset value in milliseconds to specify how much earlier the video should be delivered. This compensates for the display delay. The offset is only used during playback. It is saved globally for each output device and is independent of the project.

Active

Allows you to activate the device that you want to use for playing back video.

Show Timecode

Allows you to show the timecode.

Position

Allows you to determine the position for the timecode display.

Activating a Video Output Device

PROCEDURE

1. Select **Studio > Studio Setup**.
2. In the **Devices** list, activate **Video Player**.
The available video output devices are listed in the **Device** column.
3. In the **Active** column, activate the checkbox for the device that you want to use for playing back video.

NOTE

If you have no external device connected, you can use the **Onscreen Window** device that allows you to play back the video file on your computer monitor.

RELATED LINKS

[Video Output Devices](#) on page 1236

Video Player Window

The **Video Player** window provides different size options for video playback on your computer screen. However, the larger the size of the window and the higher the resolution of your video, the more processor load is needed.

- To open the **Video Player** window, select **Studio > Video Player**.



Fullscreen Mode

Sets the window to full screen mode. To exit full screen mode, open the context menu and select **Exit Fullscreen Mode** or press **Esc**.

Quarter Size

Reduces the window to a quarter of the actual size.

Half Size

Reduces the window to half the actual size.

Actual Size

Sets the window to the size of the video.

Double Size

Enlarges the window to twice the actual size.

Aspect Ratio

You can also drag the borders of the **Video Player** window to resize it. However, this might lead to a distorted image. To prevent this, you can set an option from the **Aspect Ratio** pop-up menu.

- If you select **None**, the aspect ratio of the video is not kept when you resize the window. The image is enlarged/reduced to occupy the whole Video Player window.
- **Internal** allows you to resize the window freely while keeping the aspect ratio of the video. Borders might be displayed around the video image to fill the window.

- **External** allows you to resize the window within some limits so that the video image always fills the full window and its aspect ratio is kept.
- **NOTE**

In full screen mode, the aspect ratio of the video is always kept.

Scrubbing Video

You can scrub video events, that is, play them back forwards or backwards.

PROCEDURE

1. Select **Studio > Video Player**.
 2. Do one of the following:
 - Click in the **Video Player** window and move the mouse to the left or to the right.
 - Use a jog wheel on a remote controller.
-

Editing Video

Video events are created automatically when you import a video file.

When working with video events, the following applies:

- You can view and edit video events in the **Project** window. A video event triggers the playback of the corresponding video clip.
- You can copy and trim video events. You can also lock video events in the **Project** window.
- You cannot draw, glue, and mute video events, or apply fades or crossfades.
- You can automatically search for video shot transitions and set markers at the detected video cut positions.

RELATED LINKS

[Use Video Follows Edit Mode](#) on page 1258

[Adding Markers at Video Cut Positions](#) on page 1255

Export Video

You can export a video file from your project. This allows you, for example, to share sections of intermediate results or finished videos with clients or other users.

The **Export Video** function exports the video and a stereo audio signal that are enclosed between the left and right locators. This allows you to export a specific range or your whole project by setting the locators accordingly.

Videos are exported in the following format:

- Container format: MP4
- Video compression codec: H.264 without long group of pictures (Long GOP) sequences
- Resolution: 1920 x 1080 px (Full HD)

IMPORTANT

Video with a lower or higher resolution than Full HD is upscaled or downscaled on export.

- Frame rate: Same as the project frame rate

- Audio compression codec: AAC
- Sample rate: Same as the project sample rate

IMPORTANT

Video export supports sample rates of 44.1 kHz and 48 kHz only.

- Bit depth: 16 bit

You can only add a stereo output channel to the exported video file. We recommend that you route all mono, stereo, or multi-channel channels that you want to export to a stereo output channel via send, and select this output channel in the **Export Video** dialog.

If you work with 2 video tracks in your project, the video on the lower track in the track list is exported. If you want to export video that is positioned on the upper video track, you must mute the lower video track.

RELATED LINKS

[Export Video Dialog](#) on page 1242

[Exporting Video Files](#) on page 1244

Export Video Dialog

The **Export Video** dialog provides settings for exporting a video file from your project.

- To open the **Export Video** dialog, select **File > Export > Video**.

The **Export Video** dialog is divided into several sections.

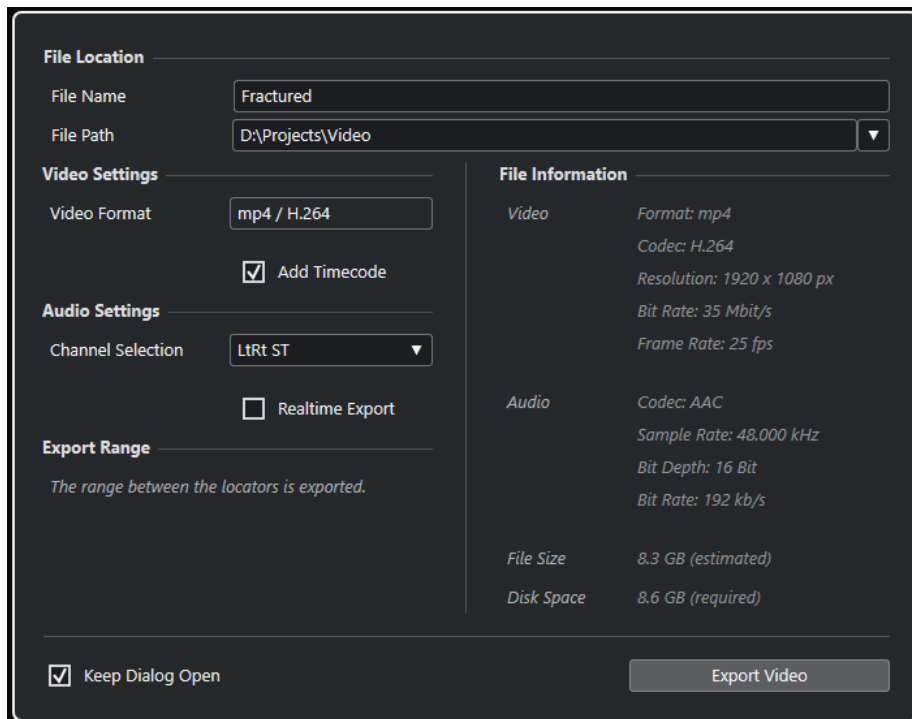

File Location

File Name

Allows you to specify the name of the exported video file.

File Path

Allows you to specify the file path of the exported video file.

Click **Path Options** to open a pop-up menu with file path options:

- **Choose** opens the File Explorer/macOS Finder allowing you to browse for a file location.
- **Recent Paths** allows you to select a recently selected file locations.
- **Clear Recent Paths** allows you to delete all recently selected file locations.

Video Settings

Video Format

Shows the format of the exported video file.

Add Timecode

Adds the project timecode to the exported video file.

Audio Settings

Channel Selection

Allows you to select a stereo output channel for export. **MixConsole** settings and insert effects are taken into account.

Realtime Export

Allows you to export the audio mixdown in real time. Realtime export takes at least the same time as regular playback. Activate this if you use external effects or instruments, or if you use VST plug-ins that require time to update correctly during the mixdown. For further information, refer to the documentation of the respective plug-ins.

NOTE

- If you export external effects or instruments in real time, you must also activate **Monitor** for the respective audio channels.
- **Realtime Export** affects only the audio export. Video is processed as usual.

Export Range

This section provides information about the exported locator range.

File Information

This section provides detailed information about the exported video file.

General Options

In the bottom section, the following options are available:

Keep Dialog Open

Activate this to keep the dialog open after clicking **Export Video**.

Export Video

Allows you to export your video as specified.

RELATED LINKS

[Export Video](#) on page 1241

Exporting Video Files

You can export a video including a stereo audio signal of your whole project or of a specific range as an MP4 video file.

PREREQUISITE

- Your project sample rate is set to 44.1 kHz or 48 kHz.
- If you work with 2 video tracks in your project, you have muted the video track that contains the video you do not want to export.
- If you want to export external audio signals, you have activated **Monitor** for the corresponding channel.

PROCEDURE

1. Set up the left and right locators to encompass the section that you want to export.
2. Set up the audio in your project so that it plays back the way you want.

NOTE

You can only add a stereo output channel to the exported video file. We recommend that you route all mono, stereo, or multi-channel channels that you want to export to a stereo output channel via send.

3. Select **File > Export > Video**.
4. In the **Export Video** dialog, select the stereo output channel that you want to export.

NOTE

Make sure that the selected output channel contains all audio that you want to use for the exported file. For example, solo the channels that you want to export, or mute the channels that you do not want to export.

5. Make any further export settings.
6. Click **Export Video**.

RESULT

The video file is exported.

RELATED LINKS

[Export Video Dialog](#) on page 1242

Extracting Audio from Video

You can extract the audio stream of a video file on import.

PROCEDURE

1. Do one of the following:
 - Select **File > Import > Audio from Video File**.
This creates an audio clip in the **Pool**, but does not add any events to the **Project** window.
 - Select **Media > Extract Audio from Video File**.
 2. In the dialog, select the video file, and click **Open**.
 3. In the **Import Options** dialog, select the desired import options.
-

RESULT

The extracted audio stream is added to the project on a new audio track and can be edited like all other audio material.

RELATED LINKS

[Pool](#) on page 675

[On Import Audio Files Settings](#) on page 313

[Importing Video Files](#) on page 1236

[Audio Editing to Picture](#) on page 1246

Audio Editing to Picture

Nuendo is a production tool that allows you to create music and sound design for film and video.

This includes the following tasks:

- Preparing a video project
- Importing production audio to the project
- Placing audio to picture
- Adjusting and editing audio

Video Timeline and the Grid

As opposed to music that uses bars and beats, video and film use frames as a basic measuring block for editing.

In the time displays, video frames are displayed in SMPTE timecode where colons separate each division of time: hours, minutes, seconds, frames, and subframes:

01:03:47:12.25

The amount of frames per second depends on the frame rate of the video.

Film frames can be displayed as SMPTE numbers or in feet and frames, a traditional method used by film editors.

Nuendo also offers a user-definable frame rate for specialized frame rates.

Feet and frames are displayed in the **Transport** panel, in the **Project** window ruler, and in the **Time Display**.

RELATED LINKS

[Video](#) on page 1234

[Frame rate \(speed\)](#) on page 1206

[Adopting the Project Frame Rate](#) on page 1237

SMPTE Subframes and Days

Nuendo can also display subframes and days.

Each frame is divided into 80 subframes. These appear separated from frames by a period.

- To display subframes, activate **Show Timecode Subframes** in the **Preferences** dialog (**Transport** page).

If a project crosses the 24-hour mark, days can be displayed. These appear as a day number to the left of the SMPTE display separated by a space.

EXAMPLE

For live events that take place in the evening, it can be useful to display days in timecode even when the project is shorter than 24 hours. If the central timecode generator for the event is running time-of-day SMPTE that correlates to the actual time on the clock, the time display may

cross the 24-hour mark at midnight. In that case, all timecode values after midnight will have a 1 in the days position to the left of the SMPTE value.

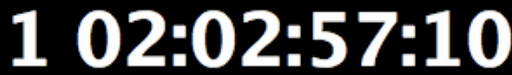

1 02:02:57:10

Drop-Frame SMPTE

Drop-frame timecode is used for the 29.97 fps frame rate used by the NTSC video standard and the 30 fps frame rate.

Since this frame rate does not correlate exactly to the actual time passing on the clock, a system has been devised that omits certain frame numbers in order to match the displayed time with the time of day.

Nuendo distinguishes drop-frame timecode by separating the frame number with a semicolon instead of a colon.

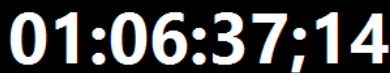

01:06:37;14

If the **Project** window ruler is set to timecode, the following options are available in the **Grid Type** pop-up menu:

- Subframe
- 1/4 frame
- 1/2 frame
- 1 frame
- 2 frames
- 1 second

These grid options allow you to edit, nudge, and move events, fades, and automation data in increments that relate to the video frames you can see.

Import Production Audio

Nuendo allows you to import production audio to match the picture.

You can import production audio that was originally recorded during the filming process, or any other audio you want to use into the project.

In Nuendo, you can import:

- Production audio from field recorders
- Separate audio files
- Audio that is embedded in a video file
- Sounds and music from sound effect libraries

NOTE

Use the **MediaBay** to organize all your sound files.

RELATED LINKS

[Field Recorder File Import](#) on page 1248

- [Audio File Import](#) on page 311
- [Importing Video Files](#) on page 1236
- [Importing Audio from Video Files](#) on page 317
- [MediaBay and Media Rack](#) on page 697
- [Loading Loops and Samples](#) on page 733

Field Recorder File Import

Nuendo offers a dedicated audio import function that supports dialog editors to find, import, and align original production set recordings that match the audio events in the project.

In the **Field Recorder Audio Import** window, you can organize the folders where your field recorder audio files are stored. The specified folders are automatically scanned for audio files in Broadcast Wave Format (BWF). The files are analyzed for iXML metadata, for example, the scene and take name, the duration, and the recording date. You can use this metadata to search for files that match the files of the audio events in your project.

Audio clips in your project that came from imported AAF files often do not contain metadata information that you need to identify matching field recorder audio files, for example, the scene number. In this case, the **Metadata Retrieval** section allows you to retrieve metadata for the attributes **Scene**, **Take**, or **Tape** by interpreting the file name or the event description.

NOTE

The **Tape** attribute might also be referred to as **Reel** in the metadata of field recorder files.

Field recorder audio can contain monophonic or polyphonic WAV files. On import, monophonic files remain in their original location and are only referenced in the **Pool**. When working with polyphonic files, the following applies:

- The single channels of polyphonic files are displayed as single items in the **Matching Field Recorder Files** section. The **Channel Number** and **Total Number of Channels** columns allow you to distinguish them from mono files.
- The **Track Info** attribute shows the channel name of a polyphonic file.
- You can audition the channels of polyphonic files individually.
- On import, polyphonic files are split and added as single monophonic files to the audio folder of your project. Their BWF and iXML metadata is preserved. The **Track Info** attribute is appended to the file name.

The **Field Recorder Audio Import** window allows you to preview both the files of your events and the field recorder files to find out which one to use in your project.

When importing the field recorder files to your project, you can choose to add them as new events on lanes of the corresponding tracks, or only to add them to the **Pool** for later use.

NOTE

The automatic search for matching field recorder files only works for files that are located in folders specified in the **Field Recorder Audio Import** window. Clips in the **Pool** must be added manually to your project.

RELATED LINKS

- [Field Recorder Audio Import Window](#) on page 1251
- [Importing Field Recorder Files](#) on page 1249
- [AAF Import Options Dialog](#) on page 1300

Importing Field Recorder Files

You can search your computer for audio files belonging to the same recording that match the events in your project and import them.

PREREQUISITE

- External storage devices that contain the field recorder audio files of your project are connected to your computer.
- Field recorder files are in Broadcast Wave Format (BWF) with iXML metadata.
- In the **Project** window, you have selected the events for which you want to search matching field recorder files.

PROCEDURE

1. Select **Project > Field Recorder Audio Import** to open the **Field Recorder Audio Import** window.
2. In the **Field Recorder Audio Folders** section, click **Add Folder**, locate the folder that contains the field recorder files of your project, and click **Select Folder**.
The location is added to the list of scanned folders, and the metadata of the contained files is analyzed. Depending on the number of audio files in the corresponding folder, this may take a while.
3. Optional: Add further scan folders, or deactivate existing scan folders in the list.
4. In the **Files of Selected Events** section, click **Update**.
The clips of the selected events in your project are added to the list on the left.
5. In the **Matching Field Recorder Files** section, click **Search**.
All audio files in active scan folders are added to the list on the right.
6. Thoroughly inspect the metadata information provided in the **Files of Selected Events** and the **Matching Field Recorder Files** list and identify the attributes you want to use for finding matches between imported files and files in your project.
7. Optional: In the **Metadata Retrieval** section, change the settings to interpret metadata for the **Scene**, **Take**, or **Tape** attribute in the same format as in the **Matching Field Recorder Files** list.
8. In the **Filters** section, activate the checkboxes for attributes that must match between imported files and the files of events in your project. If you want to use file name prefixes when searching for matching files, define the **Length of Matching Prefix String** value.
9. In the **Matching Field Recorder Files** section, click **Search** again.
All audio files in active scan folders that match your search criteria are added to the list.
10. Select one or several files in the **Files of Selected Events** list to show the matching files in the **Matching Field Recorder Files** list.
11. Optional: Preview the selected events in your project and the matching files to verify that they belong to the same recording.
12. In the list of matching files, select the files that you want to import.
13. Click **Insert on Lanes** to import the matching files to your project.
Alternatively, you can click **Add to Pool** if you only want to save the matching audio files to your project for later use.

RESULT

- The selected files in the **Matching Field Recorder Files** list are imported into your project and added to the **Pool**. Monophonic field recorder files remain in their original location and are only referenced in the **Pool**. Polyphonic field recorder files are split and added as single monophonic files to the audio folder of your project.

- The imported field recorder files are inserted as events on new lanes of the corresponding audio tracks. The new events preserve the following event properties: position, offset, fade-in and fade-out length, crossfade with adjacent events, volume, envelope, and any existing offline processing.

AFTER COMPLETING THIS TASK

- To convert lanes into new tracks, right-click a track and select **Create Tracks from Lanes**.
- To move the created events to other tracks, select **Edit > Move to > Selected Track** or use the corresponding key command.

RELATED LINKS

[Wave Files](#) on page 1178

[Field Recorder Audio Import Window](#) on page 1251

[Retrieving Missing Metadata](#) on page 1250

[Move to Submenu](#) on page 218

Retrieving Missing Metadata

This example shows how to retrieve missing metadata for the attribute **Scene** by interpreting the file name.

PREREQUISITE

- You have added the clips of the selected events in your project to the **Files of Selected Events** list by clicking **Update**.
- In the **Filters** section, no checkbox is activated.
- You have added files to the **Matching Field Recorder Files** list by clicking **Search**.
- You have identified **Scene** as the attribute you want to use for finding matches between imported files and files in your project.
- You have identified the format of the **Scene** name in the field recorder files.

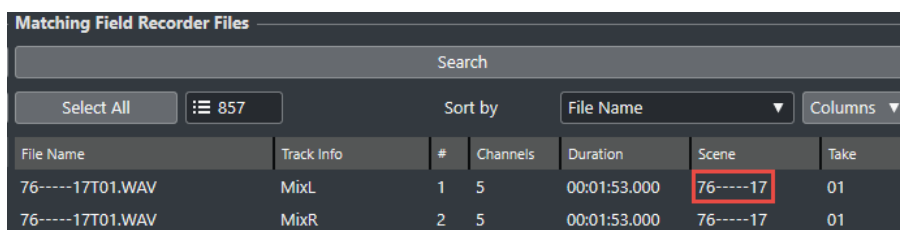

File Name	Track Info	#	Channels	Duration	Scene	Take
76-----17T01.WAV	MixL	1	5	00:01:53.000	76-----17	01
76-----17T01.WAV	MixR	2	5	00:01:53.000	76-----17	01

- Files in the **Files of Selected Events** list show no metadata in the **Scene** column.

PROCEDURE

1. Select a file in the **Files of Selected Events** list.
2. In the **Metadata Retrieval** section, select **File Name** from the **Metadata Source** pop-up menu.
3. Click **Add**  in the **Scene** row to add the selected file as the metadata example.
4. Click into the example field and drag to select the characters of the file name that represents the **Scene**.

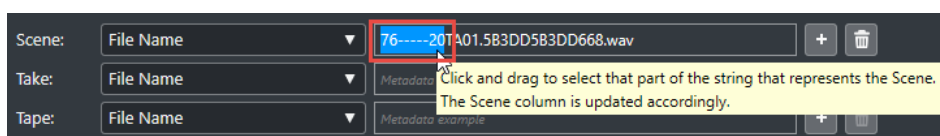

RESULT

The **Scene** column in the **Files of Selected Events** list shows the interpreted **Scene** name. The **Scene** name is shown in brackets, indicating that this value is interpreted from the file name.

Files of Selected Events					
Update					
Select All		Sort by		File Name	
File Name	Event Description	Results	Duration	Scene	Take
76-----17TA01.5B3DD5B3DD6€	76-17-1 KB	20	00:01:53.000	(76-----17)	
76-----17TA02.5B3DD5B3DD6€	76-17-1 KB	20	00:01:53.000	(76-----17)	
76-----19TA01.5B3DD5B3DD6€	76-19-3 KA	60	00:00:59.000	(76-----19)	
76-----19TA02.5B3DD5B3DD6€	76-19-3 KA	60	00:00:59.000	(76-----19)	
76-----20TA01.5B3DD5B3DD6€	76-20-1 KA	20	00:01:33.000	(76-----20)	
76-----20TA02.5B3DD5B3DD6€	76-20-1 KA	20	00:01:33.000	(76-----20)	

AFTER COMPLETING THIS TASK

You can use the **Scene** filter to only display files in the **Matching Field Recorder Files** list that have the same **Scene** name as the selected file in the **Files of Selected Events** list. When selecting other files in the **Files of Selected Events** list, the **Matching Field Recorder Files** list updates accordingly.

RELATED LINKS

[Field Recorder Audio Import Window](#) on page 1251

Field Recorder Audio Import Window

The **Field Recorder Audio Import** window allows you to scan your computer for matching field recorder files, filter these matches by different criteria, and import them to your project.

- To open the **Field Recorder Audio Import** window, select **Project > Field Recorder Audio Import**.

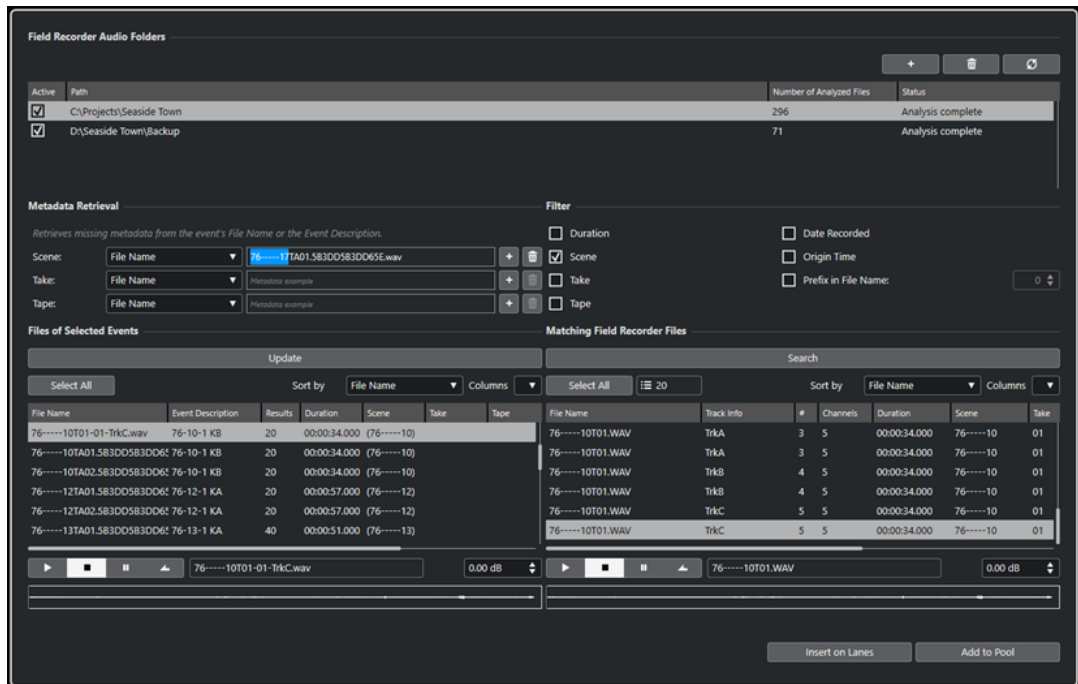

Field Recorder Audio Folders

This section allows you to specify the locations that are automatically scanned for audio files in Broadcast Wave Format (BWF).

Add Folder

Allows you to add folders that are scanned for matching field recorder files.

NOTE

Adding a folder to the list initiates the analysis of the metadata of the contained files. Depending on the number of audio files in the corresponding folder, this may take a while.

Remove Selected Folder

Removes the selected folder from the list of scanned folders.

Rescan Selected Folder

Rescans the folder that is selected in the list of scanned folders. You must rescan a folder after adding further field recorder files to it in order to re-initiate the metadata analysis.

List of scanned folders

Shows the folders that are scanned for matching field recorder files.

The checkbox in the **Active** column allows you to include/exclude folders when searching for matching field recorder files.

Metadata Retrieval

This section allows you to interpret the file name or the event description in order to show **Scene**, **Take**, or **Tape** attribute values in the **Files of Selected Events** list in a format that matches the attribute values in the **Matching Field Recorder Files** list.

Metadata Source

These pop-up menus allow you to choose between **File Name** and **Event Description** as the source for the metadata retrieval.

Metadata example fields

Allow you to select the part of the file name or event description example that represents the **Scene**, **Take**, or **Tape** attribute by clicking and dragging.

NOTE

According to your selection, the corresponding attribute column in the list below is updated instantly.

Add buttons



Add the selection in the list below as the metadata example for **Scene**, **Take**, or **Tape**.

Clear buttons



Remove the metadata example for **Scene**, **Take**, or **Tape**.

Filters

This section allows you to narrow down the criteria when searching for matching field recorder files.

Duration

Uses the duration when searching for matching files.

Scene

Uses the **Scene** attribute when searching for matching files.

Take

Uses the **Take** attribute when searching for matching files.

NOTE

This attribute may also be referred to as **Reel** in the metadata of field recorder files.

Tape

Uses the **Tape** attribute when searching for matching files.

Date Recorded

Uses the recording date when searching for matching files.

Origin Time

Uses the origin time when searching for matching files.

Prefix in File Name

Uses file name prefixes when searching for matching files. **Length of Matching Prefix String** defines the length of the sequence of characters that the name of a matching file must contain.

Files of Selected Events

This section shows the files that belong to selected events in your project.

Update

Updates the file list below according to the current event selection in the **Project** window.

List of files of selected events

Shows the files that belong to the selected events in the **Project** window. You can sort the list by selecting an attribute from the **Sort by** pop-up menu.

NOTE

- After modifying the selection in the **Project** window, you must click **Update** to update the list.
 - If the value for **Scene**, **Take**, or **Tape** is displayed in brackets, this indicates that this value is interpreted from the file name or the event description using the **Metadata Retrieval** section.
-

Select All

Selects all files in the list below.

Set up Columns

Allows you to specify which columns are displayed in the list below.

Matching Field Recorder Files

This section shows the field recorder files that match the files in your project according to the current settings in the **Filters** section.

Search

Starts the search for matching field recorder files according to the current settings in the **Filters** section.

Select All

Selects all files in the list below.

Total Number of Matching Results

Indicates the number of matching field recorder files for the current selection in the **Files of Selected Events** list.

List of matching field recorder files

Shows all matches for the current selection in the **Files of Selected Events** list and the current settings in the **Filters** section.

Set up Columns

Allows you to specify which columns are displayed in the list below.

Previewer section

Allows you to preview the files in the **Files of Selected Events** list and the **Matching Field Recorder Files** list to decide which one to use in your project.

Transport controls

Start, stop, pause, and cycle the preview.

Preview Level

Sets the preview level.

Waveform displays

Allows you to preview a particular part of the audio by clicking its position on the waveform.

Import buttons

Allow you to import the files selected in the **Matching Field Recorder Files** list to your project.

Insert on Lanes

Imports the selected matches to your project and inserts them on new lanes on the corresponding tracks.

Add to Pool

Adds the selected matches only to the **Pool**. This allows you to save matching audio files to your project for later use.

RELATED LINKS

[Field Recorder File Import](#) on page 1248

[Retrieving Missing Metadata](#) on page 1250

EDL Files

EDL (edit decision list) files are lists of edits created by a video editing suite. They are text files that contain the timecode and source tape information that you need to place audio events to picture.

Each step in the EDL describes a complete editing task including:

- The type of edit (audio, video or both)
- The source material (tape number, audio file name, or video file name)

- The start and ending source timecode values
- The start and ending destination timecode values

NOTE

The source material must have correct timestamps, otherwise the EDL timecode values are invalid. You can create audio files with embedded timestamps with timecode DAT machines, video tape machines, field recorders, digital film cameras, etc.

Working with EDL files allows for the most precise control over the source material and synchronization.

RELATED LINKS

[Importing an EDL](#) on page 381

OMF Files

OMF files can contain multiple tracks of audio that are either embedded or refer to external audio media. They store information about where to place each piece of audio in the timeline.

Since the OMF audio is created during the video edit, its timecode values should be correct and you can safely adjust the position of the video and reference audio to match the OMF audio.

RELATED LINKS

[Importing OMF Files](#) on page 1295

Video Cut Detection

The video cut detection function allows you to analyze video cuts between shots and to add markers at the detected cut positions. This is useful for editing the audio according to the cuts of a video if no edit decision list (EDL) is available.

RELATED LINKS

[Markers](#) on page 368

[Adding Markers at Video Cut Positions](#) on page 1255

[EDL Files](#) on page 1254

Adding Markers at Video Cut Positions

You can analyze video for cuts between different shots and add position or cycle markers at the detected cut positions.

PREREQUISITE

- Your project contains a video file.

PROCEDURE

1. In the **Project** window, select the whole video event or a range selection.
2. Select **Project > Video Cut Detection Panel**.
3. On the **Video Cut Detection Panel**, click **Analyze Video**.

The video is analyzed for cuts between shots. When the analyzing process is finished, the detection result is shown in the **Number of Video Cuts** field and in the **Analysis Result** section.

4. Inspect the detected results.

- Optional: Adjust the **Sensitivity** value according to the requirements of the video material.

NOTE

When adjusting **Sensitivity**, the detection result is instantly updated. You do not need to click **Analyze Video** again.

- Change the settings in the **Marker Settings** and in the **Add Markers** section as required.
- Click **Add Markers**.

RESULT

Position markers or cycle markers are added at all detected cut positions.

RELATED LINKS

[Video Cut Detection Panel](#) on page 1256

Video Cut Detection Panel

The **Video Cut Detection Panel** allows you to preview and adjust the detection result and provides settings for adding position or cycle markers at the video cut positions.

- To open the **Video Cut Detection Panel**, select **Project > Video Cut Detection Panel**.

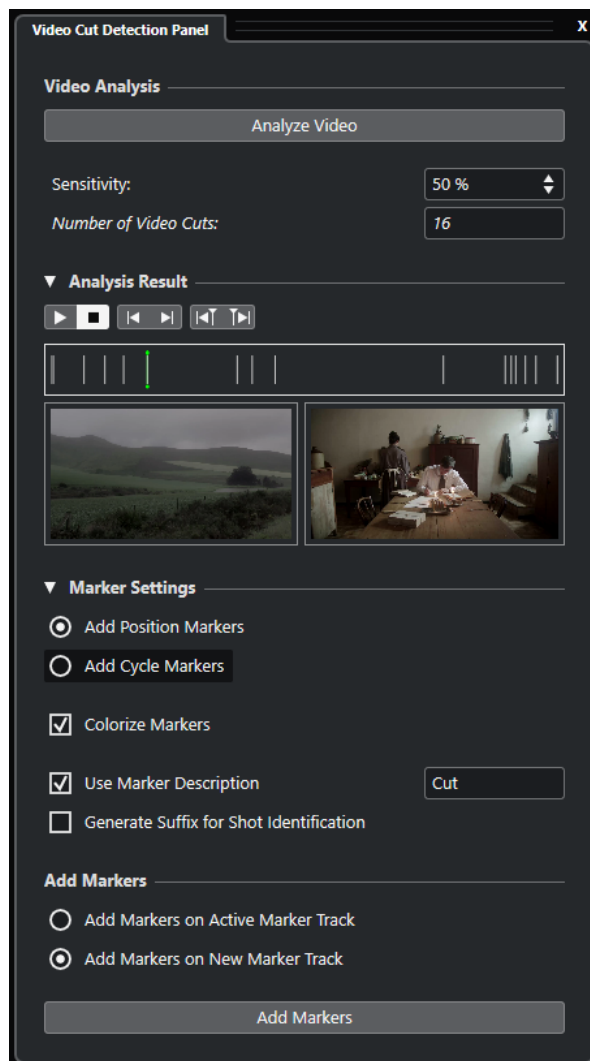

Video Analysis section

Analyze Video

Starts the analyzing process for the selected video file or range selection.

Sensitivity

Increases/Decreases the displayed number of video cuts after analyzing the video. The higher this value, the more video cuts are shown. Adjust this setting according to the requirements of the video material.

NOTE

We recommend that you start with a value of 50 %, which provides good results in most cases.

Number of Video Cuts

Shows the number of detected cuts in the analyzed video. This value depends on the current **Sensitivity** setting.

Analysis Result section

Transport Start

Starts playback.

Transport Stop

Stops playback

Locate Previous Cut

Moves the project cursor to the previous video cut.

Locate Next Cut

Moves the project cursor to the next video cut.

Nudge Cursor - 1 Frame

Moves the project cursor position 1 frame backwards.

Nudge Cursor + 1 Frame

Moves the project cursor position 1 frame forwards.

Cut positions preview display

Shows the positions of the detected video cuts and of the project cursor on the timeline. The selected cut position is shown in the video preview display.

Video preview display

The left display shows the video frame before the current cursor position, the right display shows the video frame at the current cursor position. This helps you to decide if **Sensitivity** is set to an appropriate value.

Marker Settings section

Add Position Markers

Allows you to add position markers at all detected cut positions.

Add Cycle Markers

Allows you to add cycle markers at all detected cut positions.

Colorize Markers

Colorizes the markers on the marker track in different colors.

Use Marker Description

Allows you to add a description for the markers that are created using the **Video Cut Detection Panel**. Click the text field to modify the description.

Generate Suffix for Shot Identification

If this option is activated, an alphabetic character is added to the marker description of a video section that belongs to the same shot.

Add Markers section

Add Markers on Active Marker Track

Allows you to add markers on an existing active marker track.

Add Markers on New Marker Track

Allows you to add markers to a new marker track that is created right below the video track.

Add Markers

Adds position or cycle markers at all video cut positions that are shown in the preview display.

RELATED LINKS

[Adding Markers at Video Cut Positions](#) on page 1255

[Marker Track](#) on page 377

[Adding, Moving, and Removing the Marker Track](#) on page 378

Use Video Follows Edit Mode

The **Use Video Follows Edit Mode** allows you to edit audio while getting continuous visual feedback on the video display.

If you activate **Use Video Follows Edit Mode** in the **Transport** menu, project cursor and video automatically follow each edit you make. This allows you to instantly see where in the video your edit is taking place.

The video display gives you visual feedback during the following actions:

- Selecting ranges
- Editing audio
- Moving audio events
- Nudging audio events or range selections
- Resizing audio events or range selections
- Using the **Time Warp** tool
- Adjusting audio fade handles

NOTE

Use Video Follows Edit Mode uses the snap point of audio events. By adjusting the snap point, you can align to an audio position that is situated in the middle of the event.

EXAMPLE

The sound of a car skidding to a stop can be easily timed to picture by lining up the end of the skid sound with the stopping of the car in the video. However, if the car comes into the frame after the skidding, it can be very difficult to align the sound. In this case, move the snap point to

the end of the skidding sound and activate **Use Video Follows Edit Mode** to match that point to the stopped car on screen.

RELATED LINKS

[Snap Point](#) on page 593

[Editing Tempo and Time Signature](#) on page 1132

Event-Based Fades and Volume Envelopes

When working with picture, consider using event-based fades and volume envelopes.

Event-based fades and volume envelopes are useful for the following reasons:

- They are calculated in real time which gives you instant feedback of your edits while playback continues.
As long as you release the event handle before the cursor reaches the event, you can hear the result of your edit.
- They are calculated before the audio signal is sent to the **MixConsole**.
If you insert a compressor plug-in on an audio track and you increase the volume of an event on that track, this will increase the input signal that reaches the compressor plug-in, and the plug-in changes the gain reduction accordingly.
- They move together with the event.

RELATED LINKS

[Event-Based Fades](#) on page 335

[Creating Event-Based Volume Changes](#) on page 350

Placing Audio to Picture

In Nuendo, you have several possibilities to insert the audio in your project and place it to the picture.

NOTE

If you work with reference audio, consider panning it to one side and the new audio to the other. This allows you to discern whether one source is ahead of the other. You will hear a comb filtering effect when 2 identical sources become very close in sync with one another.

Snapping Audio Events to Video Events

You can place audio to picture by using the **Snap** function.

PREREQUISITE

A project with an audio and a video event is open.

PROCEDURE

1. In the **Project** window toolbar activate **Snap**.
 2. Open the **Snap Type** pop-up menu and select **Events**.
 3. Drag the audio event to the start of the video event.
-

RESULT

The start of the audio event is aligned with the start of the video event.

AFTER COMPLETING THIS TASK

Verify if audio and video are synchronized throughout the length of the project, and fix any issues before editing.

RELATED LINKS

[MediaBay and Media Rack](#) on page 697

[Adjusting and Editing Audio](#) on page 1262

Inserting Audio at Timecode Positions

You can insert audio files from the **MediaBay** or from the **Pool** at the timecode start position of the video event.

PREREQUISITE

A project with a video event is open. You know the timecode start position of the video event.

PROCEDURE

1. Do one of the following:
 - Select **Media > MediaBay** to open the **MediaBay**.
 - Select **Media > Open Pool Window** to open the **Pool**.
2. Right-click the audio event that you want to use and from the context menu select **Insert into Project > At Timecode Position**.
3. In the **Insert Media at Position** dialog, enter the timecode start position of the video event.
4. Click **OK**.

RESULT

The audio event is inserted on the topmost selected track in the **Project** window with the event start aligned with the timecode start position of the video event.

AFTER COMPLETING THIS TASK

Verify if audio and video are synchronized throughout the length of the project, and fix any issues before editing.

RELATED LINKS

[MediaBay and Media Rack](#) on page 697

[Adjusting and Editing Audio](#) on page 1262

Inserting Audio at the Cursor Position

You can insert audio files from the **MediaBay** or from the **Pool** at the cursor position.

PREREQUISITE

A project with a video event is open. You have viewed the video and found the position where you want to insert the audio event.

PROCEDURE

1. Set the cursor to the position where you want to insert the audio event.

NOTE

You can use the **Markers** window to add markers at positions where you want to insert the audio. Locate to these markers to set the cursor to these positions.

2. Do one of the following:
 - Select **Media > MediaBay** to open the **MediaBay**.
 - Select **Media > Open Pool Window** to open the **Pool**.
 3. Right-click the audio event that you want to use and from the context menu select **Insert into Project > At Cursor**.
-

RESULT

The audio event is inserted on the topmost selected track in the **Project** window with the event start aligned with the cursor position.

AFTER COMPLETING THIS TASK

Verify if audio and video are synchronized throughout the length of the project, and fix any issues before editing.

RELATED LINKS

- [MediaBay and Media Rack](#) on page 697
- [Locating to Markers](#) on page 1261
- [Adjusting and Editing Audio](#) on page 1262

Locating to Markers

You can use the **Markers** window to add markers at positions where you want to insert audio. By locating to markers you can set the cursor to these positions.

PROCEDURE

1. Select **Project > Markers** to open the **Markers** window.
2. View the film or the video in Nuendo, keep the **Markers** window open, and add markers at the positions where you want to place sound effects and other audio elements.
The marker is shown in the list.
3. In the **Description** column, enter a description for the marker.

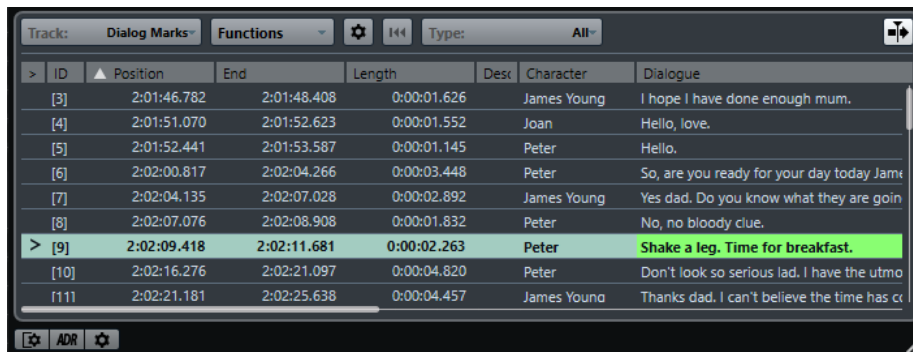

ID	Position	End	Length	Desc	Character	Dialogue
[3]	2:01:46.782	2:01:48.408	0:00:01.626		James Young	I hope I have done enough mum.
[4]	2:01:51.070	2:01:52.623	0:00:01.552		Joan	Hello, love.
[5]	2:01:52.441	2:01:53.587	0:00:01.145		Peter	Hello.
[6]	2:02:00.817	2:02:04.266	0:00:03.448		Peter	So, are you ready for your day today Jame
[7]	2:02:04.135	2:02:07.028	0:00:02.892		James Young	Yes dad. Do you know what they are goin
[8]	2:02:07.076	2:02:08.908	0:00:01.832		Peter	No, no bloody clue.
[9]	2:02:09.418	2:02:11.681	0:00:02.263		Peter	Shake a leg. Time for breakfast.
[10]	2:02:16.276	2:02:21.097	0:00:04.820		Peter	Don't look so serious lad. I have the utmo
[11]	2:02:21.181	2:02:25.638	0:00:04.457		James Young	Thanks dad. I can't believe the time has cr

4. Add as many markers as you need.
 5. Select a marker in the **Markers** window to set the cursor to its position.
-

RESULT

You have added markers for specific positions where you want to insert audio. You can select a marker to set the cursor to the marker position.

RELATED LINKS

- [Markers](#) on page 368
- [Inserting Audio at the Cursor Position](#) on page 1260
- [Inserting Clips into a Project](#) on page 682

Adjusting and Editing Audio

In Nuendo, you have several possibilities to adjust and edit audio events in your project so that they match the picture.

Nudging Audio Events

You can fine-tune the start or end position of audio events or their size with the nudge buttons.

PROCEDURE

1. Right-click in the **Project** window toolbar, and on the context menu, activate **Nudge Palette**.
2. Select the audio event and do one of the following:
 - Click **Move Left** or **Move Right** to incrementally adjust the position of the entire audio event.
 - Click **Trim Start Left** or **Trim Start Right** to incrementally size the start of the audio event.

NOTE

If the **Object Selection** tool is set to **Sizing Moves Contents**, the event content is moved.

- Click **Trim End Left** or **Trim End Right** to incrementally size the end of the audio event.

NOTE

If the **Object Selection** tool is set to **Sizing Moves Contents**, the event content is moved.

RESULT

The audio event is moved accordingly.

NOTE

The nudge increment is determined by the timeline and grid in the **Project** window.

4-Point Editing with the Range Selection Tool

You can use the **Range Selection** tool in Nuendo to select a range on the track where you want to place the audio, and another range that spans the audio you want to use. This works just like marking points in 4-point editing.

PREREQUISITE

The audio that you want to use as work file is imported into your project at a position behind the end of the program material. This prevents your work files from being included in the final mix. The corresponding tracks are moved to a folder track.

PROCEDURE

1. Watch the video, and with the **Range Selection** tool, select the range on the destination track where you want to insert your audio.

NOTE

You can also use the key commands for **Left Selection Side to Cursor (E)** and **Right Selection Side to Cursor (D)** to define the range selection on the fly.

2. Listen to the audio to identify the audio that you want to use with the picture.
3. Open the **Range Selection** pop-up menu and select **Selection B**.
4. Select the audio range and press **Ctrl/Cmd - C** to copy this selection to the clipboard.
5. Open the **Range Selection** pop-up menu and select **Selection A** to switch to the selection range you defined on the destination track.

NOTE

If you switch selections, also the viewing area is switched. This allows you to move quickly between source and destination audio.

6. Press **Ctrl/Cmd - V** to paste the audio from the clipboard onto the track.
-

RESULT

The range on the destination track is replaced with the audio from the clipboard.

RELATED LINKS

[Adjusting Range Selections on the Info Line](#) on page 1263

Adjusting Range Selections on the Info Line

You can adjust selection ranges by modifying their values on the info line.

PROCEDURE

- Do one of the following:
 - Modify the **Range Start** value to move the selection without changing its length.
 - Modify the **Range End** value to change the end time.
 - Modify the **Range Length** value to change the length of the selection.
 - Modify the **Top Track** value to change the number of the topmost track in the selection.
 - Modify the **Bottom Track** value to change the number of the bottom track in the selection.

NOTE

By assigning key commands, you can increase the speed and efficiency for creating range selections.

RELATED LINKS

[Range Editing](#) on page 248

[Editing Selection Ranges](#) on page 250

[4-Point Editing with the Range Selection Tool](#) on page 1262

Cut Head/Cut Tail

You can crop range selections in the **Project** window.

- To delete everything to the left of the selection range, select **Edit > Cut Head**.
- To delete everything to the right of the selection range, select **Edit > Cut Tail**.

NOTE

This affects any type of event in the **Project** window including video, MIDI, markers, and automation data.

RELATED LINKS

[Range Editing](#) on page 248

[Using Cut Head and Cut Tail](#) on page 234

Time-Stretching Audio to Picture

You can change the length of an audio event that does not quite fit with a video by using time stretch.

PREREQUISITE

The start of the audio event is aligned with the position of the video.

PROCEDURE

1. Open the **Transport** menu and activate **Use Video Follows Edit Mode**.
 2. Select the **Range Selection** tool and double-click the audio event to create a selection range that spans the whole audio event.
 3. Click the right edge of the selection range and drag to adjust it to the desired length.
 4. Select **Transport > Locators > Set Locators to Selection Range**.
 5. With the **Object Selection** tool, select the audio event.
 6. Select **Audio > Processes > Time Stretch**.
 7. In the **Time Stretch** dialog, click **Use Locators**.
This sets the time stretch ratio so that the audio event fits the locator range.
 8. Click **Process**.
-

RESULT

The audio is stretched or compressed to fit the range.

Adjusting Audio Fades to Picture

You can fade in the audio so that it reaches its full volume at a certain position in the video, and fade it out at another position.

PREREQUISITE

The audio event is positioned and sized correctly according to the video. **Show Event Volume Curves Always** is activated in the **Preferences** dialog (**Event Display—Audio** page).

PROCEDURE

1. Open the **Transport** menu and activate **Use Video Follows Edit Mode**.
 2. On the **Project** window toolbar, select **Range Selection**.
 3. Select a range that covers the section of the audio event that you want to be played at full volume.
 4. Select **Audio > Adjust Fades to Range**.
-

RESULT

The fade-in and fade-out handles of the audio events are adjusted to the selected range.

Film Transfers

When working on film projects, video postproduction editors typically transfer the film footage to video for use with computer video editing systems.

Once the film has been edited, it can be transferred back to film for presentation in theaters or may remain in video format for television broadcast and release on videotape or DVD.

Pull-Down and Speed Changes

Pull-down is an algorithm for the frame rate conversion of film footage to the faster video frame rate.

When film footage is transferred to video, the frame rate must be converted from 24 fps to either 25 fps (PAL/SECAM) or 29.97 fps (NTSC). This process introduces a slight speed change as a result of the mathematical relationships between the different frame rates. The film to NTSC conversion is done as a 2-3 pull-down and the film is running at 23.98 fps to maintain the exact 2:3 relationship. As a result the film is running ~0.1 % slower in NTSC TV.

These speed changes must also be applied to the audio recorded along with the film, in order for the audio to remain in sync with the picture. Sometimes the speed change is applied at the same time as the film transfer and is recorded directly on the videotape. This allows the video editor to hear the audio along with the transferred video while editing.

However, speed changes also result in pitch changes. Furthermore, this may lead to artifacts in the audio, due to the fact that a direct digital transfer from the field recorder to videotape is not possible without performing either a sample rate conversion or an analog transfer.

Therefore, most audio engineers prefer to use the original source material when working with film audio. Once the original audio has been digitally transferred into Nuendo, the speed change must be compensated for in order to keep the audio in sync with the video. Nuendo has the flexibility to apply these speed changes independently to either the audio or video.

RELATED LINKS

[Compensating for Speed Changes](#) on page 1268

Telecine Process

A telecine machine is the device used to transfer film to videotape. It transfers images from each frame of film to frames of video in a very specific way.

Having a clear understanding of this process will help alleviate the confusion surrounding pull-up and pull-down sample rates and keeping film audio in sync.

Film Frames and Video Fields

When transferring film to videotape, part of the film image must be transferred to one field and then the rest to another field of video. This is due to the way that video signals are formatted.

In video signals, each frame or single image is composed of 2 video fields, each containing half of the image. The first field contains all the odd horizontal lines of resolution and the second field contains the even horizontal lines of the image. This is called interlacing and is needed to minimize the flicker effect that would result if the image was presented all at once.

A film frame, however, is a single, complete image (like a 35 mm photograph). That means that there are no fields involved.

Film Transfers to PAL/SECAM Video

Film transfers to PAL/SECAM video are relatively straightforward. Film runs at 24 fps and PAL video runs at 25 fps. If you speed up film by roughly 4 % (or 4.16 %, to be precise), it will be running at 25 fps. That means that film transfers to PAL video result in a 4 % pull-up in speed.

When properly done, the first frame of film will be transferred to both fields of the first frame of video and so on. All that is needed is the 4 % increase in speed for this to be a one-to-one transfer.

To keep the audio in sync, it must also be pulled up by 4 %. This will result in a 4 % increase in the pitch as well. If the final project is to remain in the video format, pitch-correcting might be necessary. If the project is going to be returned to film for the final presentation, the audio can be slowed back down to normal speed when transferring back to film in order to preserve the fidelity and performance values of the original material.

Film Transfers to NTSC Video

Transferring film at 24 fps to NTSC video at 29.97 fps presents a few more difficulties than the PAL transfer. Simply speeding up film to 29.97 fps would cause both the visual and audio elements to become too fast and high-pitched to be usable. There is no neat mathematical relationship between 24 fps and 29.97 fps.

To allow film transfers to NTSC video, another method called the 2-3 pull-down was devised.

Two-Three Pull-Down

The 2-3 pull-down allows for a smooth transfer to NTSC video without any unwanted or noticeable pitch changes in the audio. It consists of a combination of speed change and frame-to-field counting.

The following steps are involved during the process:

- The film speed is slowed or pulled down to 23.976 fps (-0.1 %).
- The first frame of film is transferred to the first 2 fields of video.
- The second frame of film is transferred to 3 fields of video, the 2 fields of the second video frame, and just the first field of the third video frame.

NOTE

This is where the 2-3 part of the name comes from. Each alternating frame of film is transferred to 2 fields of video, then 3 fields of video, and so on.

- The third film frame is transferred to the second field of video frame 3 and the first field of video frame 4.
- The remaining film frames are transferred in this manner, alternating between 2 and 3 fields of video, until the end of the transfer. After 4 frames of film have been transferred this way, an even 5 video frames will be created. Over the course of one second, 24 frames of film and 30 frames of video will have gone by. Because they are running at -0.1 %, the actual frame rate is 29.97 video frames per second, the NTSC standard.

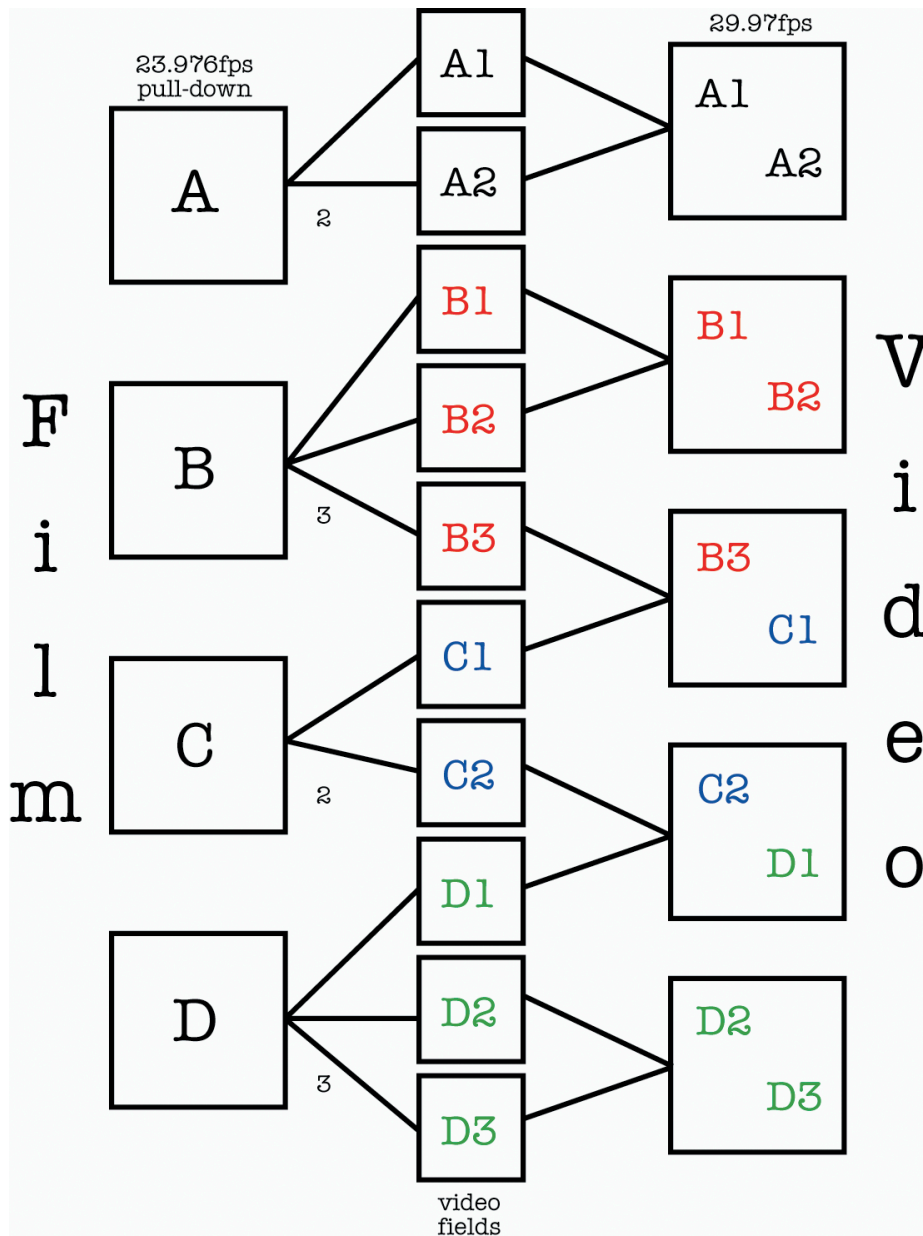

In order to make accurate decisions regarding audio pull-down and video pull-up when working with NTSC film transfers in Nuendo, it is important to have a clear understanding of 2-3 pull-down.

Even though 29.97 fps (video speed) is a faster frame rate than 24 fps (film speed), the video is running -0.1 % slower than the original film due to the 2-3 transfer process. Therefore, you need to slow the audio down a bit so that production audio, such as DAT tapes or files from a field recorder from a film shoot are played back in sync with NTSC video.

IMPORTANT

Many video editors working with NTSC video refer to 30 fps as film speed as opposed to 24 fps. The reason for this is, if you speed NTSC video (29.97 fps) up by 0.1 %, you are running at the same speed as the original film at 24 fps. Conversations regarding this can often get very confusing. Make sure that you have a clear understanding of the material you are working with when dealing with film transfers and frame rates. It will avoid many mistakes and save time in the long run.

Compensating for Speed Changes

In Nuendo, there are 2 basic ways to compensate for speed changes due to film transfers.

The first is by adjusting the playback speed of the audio to match the speed of the video. The second is to adjust the speed of the video file to match the original speed of the film and production audio in Nuendo.

Adjusting Audio Playback Speed

When adjusting audio playback speed to match the video, the playback adjustment depends on the video format that the film is transferred to.

For NTSC, the speed change is down -0.1 %. For PAL/SECAM, the change is up +4.1667 %.

Audio Pull-Down -0.1 % (NTSC)

When you work with film projects that have been transferred to NTSC, the audio must be slowed down in order to remain in sync.

Audio suffers a generation loss and speed change during the film transfer. Therefore, most audio engineers prefer to use the original tapes from the film shoot when working on a film project that has been transferred to NTSC video.

To slow down audio playback in Nuendo, you might need an external sample clock source to pull the clock speed down by 0.1 %.

For this to work, your audio card must be set to external sync and connected to the clock device via word clock, **VST System Link**, or some other clocking method. Furthermore, you must tell Nuendo that it is being synchronized with an external clock source. This is done in the **Studio Setup** dialog.

Because video and audio playback speeds are independent in Nuendo, the video will remain at the same speed while the audio is slowed down (pulled down). This ensures that the production audio and film transfer remain in sync.

Either you receive an OMF or AES31 file that contains audio from the original source tapes conformed to the edited video or you have to record the source tapes into Nuendo yourself. In both cases, you have audio in Nuendo that is edited to the picture but will not stay in sync with the video unless you pull down the sample rate.

IMPORTANT

- When Nuendo is running at a non-standard sample rate (47.952 kHz = 48 kHz pull-down), digital transfers into Nuendo from external equipment must be made with the external equipment locked to the same sample clock as your audio card. Most devices are capable of a 0.1 % change in sample rate and will function normally.
- Any audio mixdowns that are exported from Nuendo when the sample clock is pulled down will play back in other applications and devices faster because that sample clock will be running at the standard 48 kHz.

The idea is that when you have completed the audio mix for your film project, the video will be sped back up to film speed for the final transfer back to film and your audio mix can then be played at the standard 48 kHz sample rate (no pull-down) and will remain in sync with the picture.

Using this method preserves the quality of the original audio recording made during filming and allows for a digital mixdown transfer at film speed without any generation loss or sample rate conversion.

RELATED LINKS

[Selecting an Audio Driver](#) on page 18

Audio Pull-Up +4.1667 % (PAL/SECAM)

Audio pull-up (+4.1667 %) is the same concept applied to PAL/SECAM video transfers.

Because the film is sped up by 4.1667 % during transfer, audio in Nuendo must be running at +4.1667 % speed in order to remain in sync with the video during editing and mixing.

In this case, the external clock must be set to +4 % varispeed.

IMPORTANT

Steinberg's **SyncStation** is capable of varispeed and has presets for the 4.1667 % necessary with PAL film transfers and the -0.1 % for NTSC.

Once the project is complete, the Nuendo sample rate can be returned to normal (48 kHz) for the final mixdown at film speed. Once again, this allows for a digital transfer of the final master at the correct speed for theatrical presentation.

Non-Standard Audio Pulls

It is also possible to use pulled sample rates that do not fit one of the above scenarios. These sample rates would only need to be used in exceptional circumstances when an error has occurred elsewhere in the process of making a film.

The following settings can be used to correct sync errors made at another studio or problems with video editing systems:

- -4 % pull-down
If a film project was transferred to PAL/SECAM video and the audio editing and mixing was performed at video speed (48 kHz) without using audio pull-up, the final mix would be running at video speed, not film speed. In this case, a -4 % pull-down can be used to correct this and get the audio running at film speed again. The downside to this is that the final transfer to film would either have to be analog or through a sample rate converter in order to be recorded with the film.
- +0.1 % pull-up
This pull-up is not normally used except in situations similar to the one described above, but for NTSC video. It can be used to correct the speed of a project finished at video speed (without pull-down) prior to transferring it to film. Because film is moving 0.1 % faster than NTSC video, the audio mix can be sped up to film speed using +0.1 % pull-up for the transfer.
- Other pull-up/pull-down options
There may be other scenarios where non-standard pull-ups and pull-downs can be used to correct mistakes. Nuendo provides further pull-up/pull-down options for such situations in the **Project Setup** dialog and the respective section in the **Project Synchronization Setup** dialog.

IMPORTANT

All the examples used here are with 48 kHz as the standard sample rate for the film and video industry. However, it is possible to accomplish the same tasks using 44.1 kHz, 88.2 kHz, 96 kHz (this is double the standard sample rate and commonly used for higher fidelity), 176.4 kHz and 192 kHz, provided you have an external clock device capable of pulling these higher sample rates.

Adjustments When Applying Audio Speed Changes

When the audio clock of your audio card is being slowed down or sped up by an external clock source, Nuendo cannot know that it is running slower or faster than normal. The time displays (minutes:seconds, timecode) will become inaccurate because they are based on a sample count, not the independent clock source.

Nuendo provides an adjustment of the timeline to compensate for these changes. This setting is found in the **Project Setup** dialog.

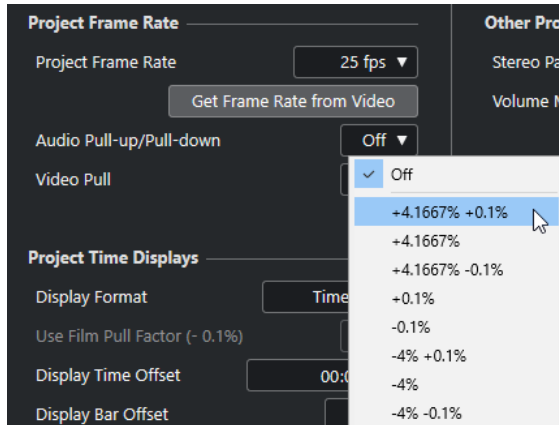

Whenever you apply an audio pull to Nuendo from an external clock, also set **Audio Pull-up/Pull-down** to the corresponding setting. This allows Nuendo to recalculate the sample count to reflect the adjusted sample rate.

For example, if the setting is switched from no pull-down to -0.1 % pull-down, events on the timeline will appear longer because the sample rate has been slowed down. The event display will show the accurate length of events relative to timecode, minutes, and seconds.

NOTE

In the **Project** window, the status line below the toolbar also indicates whether audio pull-up or audio pull-down is applied to this project.

When you change **Audio Pull-up/Pull-down** and there are audio events in the timeline already, Nuendo prompts you to choose whether or not to keep the original sample start times.

- Select **No** to let the events follow the timecode and minutes:seconds clock change, and remain at their SMPTE start times.
- Select **Yes** to force Nuendo to leave events at the same sample start time regardless of the clock speed change.

Video Pull-Up and Pull-Down

Nuendo also provides a method to adjust for film transfers by speeding up or slowing down playback of the video files in your project.

Depending on the situation, it can be helpful to make the video file play back at film speed and not adjust the audio playback at all.

Adjusting the video playback speed back to film reverses the process used when adjusting audio playback speed. For NTSC video, the video playback speed must be adjusted up +0.1 % back to film speed.

Altering the video playback speed is done in the **Project Setup** dialog. You have 2 options: 0.1 % pull-up and 0.1 % pull-down.

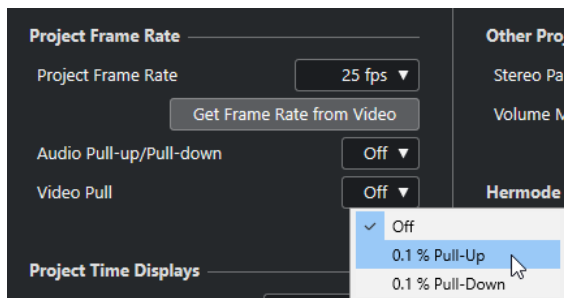

Video +0.1 % Pull-Up for NTSC

Because NTSC video is running -0.1 % slower than the original film, pulling the video speed back up by +0.1 %, returns it to original film speed. With the video now running at the correct film speed, audio originally recorded at 48 kHz on the film shoot will remain in sync with the video. Additionally, the final mix can be digitally transferred back to film at 48 kHz without the need for an analog copy or sample rate conversion.

Video -0.1 % Pull-Down (Non-Standard)

Pulling the video speed down for an NTSC video is a non-standard procedure and would not happen under normal circumstances. It is possible to pull down a video file that is running at 24 fps -0.1 % so it matches with material running at NTSC video speed. The resulting frame rate is 23.976 fps.

NOTE

Speeding up or slowing down the video speed is only possible if the video is running through a computer video card. If a professional genlocked video card is used, the video playback speed is derived from the genlock input.

What is 23.976 fps Used for?

The world of digital video formats is ever changing and the results are new developments for every media professional involved in movies, television, corporate video, and more. With the advent of HD cameras that are capable of recording at several different frame rates internally, the options available to cinematographers have become staggering.

Because the look of film running at 24 fps is unique, many HD productions are filmed at 24 fps to mimic the look of film on video. Because the speed change from 24 fps to 29.97 fps NTSC is such an odd one (requiring the 0.1 % pull-down), designers of these cameras have developed a method of recording that allows the camera to record like film, but also output an NTSC video signal at the same time without any speed change. They record at 23.976 fps which translates to 24 fps pulled down -0.1 %.

Working with Video Tape Recorders

Whenever you are interfacing Nuendo with external hardware, some additional computer hardware may be necessary.

In the case of using video tape recorders (VTRs) with Nuendo, a device capable of dealing with SMPTE timecode, word clock, video reference clock, MIDI machine control, and Sony 9-Pin machine control protocols will be needed.

The most important aspect of working with VTRs is the ability to maintain the best possible synchronization between Nuendo and the tape machine. Using a device, such as Steinberg's **SyncStation**, will provide the best results.

Regardless of your hardware setup, Nuendo will have to be configured to synchronize with the VTR.

RELATED LINKS

[Synchronization](#) on page 1204

Tips

There are so many variables within the boundaries of a multimedia project that only years of experience can cope with all of them. However, here are a few tips and good ideas you can use to help eliminate some common issues.

Preproduction Planning

The most important tip for making postproduction go smoothly for a TV commercial, feature film or even Internet media creation is good use of preproduction planning. Try and meet with all the people involved in a project prior to starting in order to decide how the work will flow once you get into postproduction. Determining frame rates for film and video, film transfer issues, what format the location audio will be recorded in, delivery formats and other details including a working copy of the script will be invaluable to any postproduction audio professional.

TC Burn-In

The timecode burn-in window (BITC) is a section of the video image that contains timecode numbers for each frame of video from the original video editor. Using this, it is possible to align a video perfectly in Nuendo so that all the timecode numbers line up exactly.



ReConform

The **ReConform** function allows you to automatically adapt edited audio projects to new cut versions of video material.

Post production often includes working on audio mixes with early cut versions of video material. When you get changed versions of the video material, you must identify the changed parts and adapt the audio mix accordingly.

The **ReConform** function helps you by re-adapting the audio mix to the changed video material. Most of the process is done automatically, however, you can still make manual changes.

Prerequisites

The following prerequisites are required to work with the **ReConform** function.

- A Nuendo project.
- An Edit Decision List (EDL) for the current cut version of the video material.
- An Edit Decision List for the target cut version of the video material.

NOTE

Instead of old and new EDLs you can also use a change EDL that contains the changes from old to new EDL.

- Optional: The corresponding video for video preview.

RELATED LINKS

[EDL Files](#) on page 1254

ReConform Workflow

The **ReConform** function automates most of the typical workflow that includes comparing old and new EDLs as well as applying the EDL changes correctly to the Nuendo project.

The workflow includes the following steps:

- You import and compare different versions of EDLs. This creates a new EDL that contains the differences between your current project and how it is supposed to be to match the new video. This EDL is called **Change EDL**.

NOTE

If available, you can directly import a **Change EDL**.

- You manually check and validate the entries in the **Change EDL** and make corrections where necessary.

You can use the preview functions to see the result of the **ReConform** process for single entries in the **ReConform** dialog and in the **Project** window. The preview does not affect the original audio or video material.

- When you have made all changes to the **Change EDL**, you start the **ReConform** process which applies the changes to the project.

ReConform Dialog

The **ReConform** dialog contains the main user interface for the **ReConform** function.

- Select **Project > ReConform** to open the **ReConform** dialog.

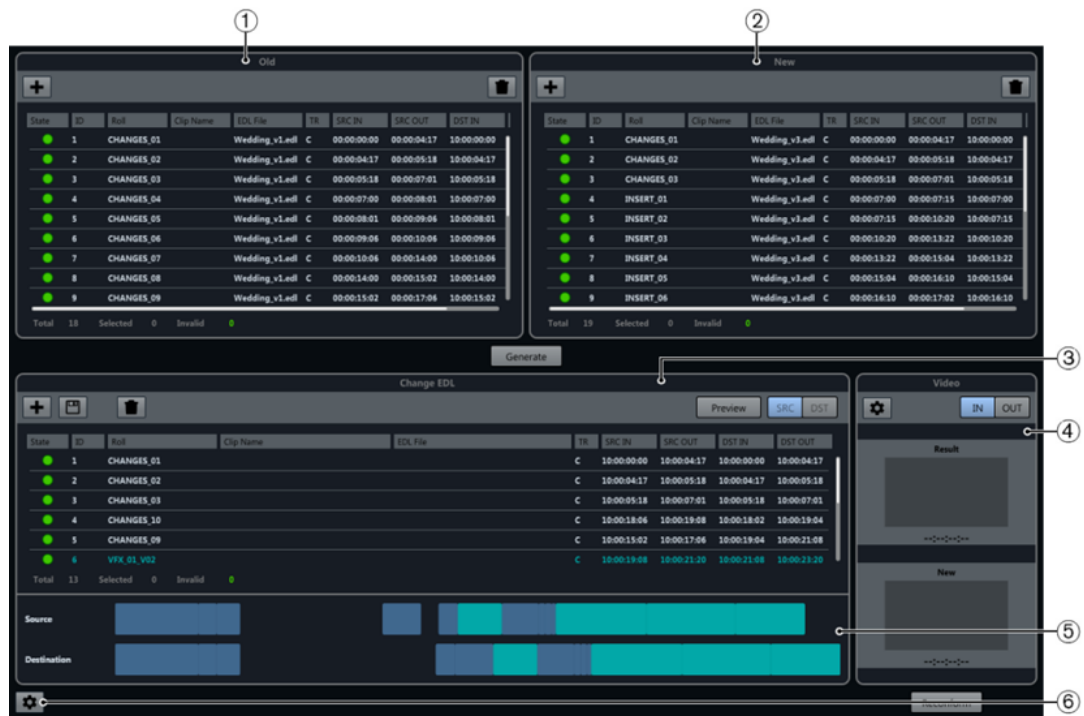

- 1 **Old EDL**
The current cut version of the video material.
- 2 **New EDL**
The updated version of the video material.
- 3 **Change EDL**
The changes between old and new EDLs.
- 4 **Video preview**
Displays video frames of selected entries in the **Change EDL**.
- 5 **Timeline**
The entries of the old and the new EDL.
- 6 **Open ReConform Settings**
Allows you to configure the **ReConform** function.

RELATED LINKS

[ReConform Settings](#) on page 1281

EDLs

Edit Decision Lists (EDLs) form the basis of the **ReConform** function.

The main idea of the ReConform function is to adapt changes in EDLs to a current audio mix. As a prerequisite, you must have at least an existing EDL and a new EDL. Alternatively, you can use an EDL that already contains changes, the **Change EDL**.

The **ReConform** dialog allows you to import old and new EDLs that you can use to generate a **Change EDL**. You can also import an existing **Change EDL**.

In the dialog, you can find these EDLs in the **Old EDL**, **New EDL**, and **Change EDL** lists. In these lists, you have the following options:

Add EDL



Allows you to add an existing EDL into the **ReConform** dialog.

Save EDL (Change EDL only)



Saves a generated **Change EDL**.

Delete EDL



Deletes all entries in the corresponding list.

Each EDL consists of the following data:

State

State of the entry. Green indicates that the entry is valid. Red indicates that the entry is invalid. If you move the mouse pointer over the symbol in the column, a tooltip provides an error description.

ID

ID of the entry.

Roll

Roll name of the entry.

Clip Name

Clip name of the entry.

EDL File

The name of the EDL file from which this entry was read.

TR

Transition type of the entry.

- C - Cut
- D - Dissolve
- W - Wipe

SRC IN

Start timecode of the entry in the original video file or clip.

SRC OUT

End timecode of the entry in the original video file or clip.

DST IN

Start timecode of the entry in the project.

DST OUT

End timecode of the entry in the project.

In addition to the columns, all EDLs inform you about the number of entries and how many of them are selected or invalid.

RELATED LINKS

[Adding EDLs on page 1277](#)

Change EDL Section

The **Change EDL** displays the changes between old and new EDLs.

It can either be generated through comparison of old and new EDLs or imported directly into the **ReConform** dialog.

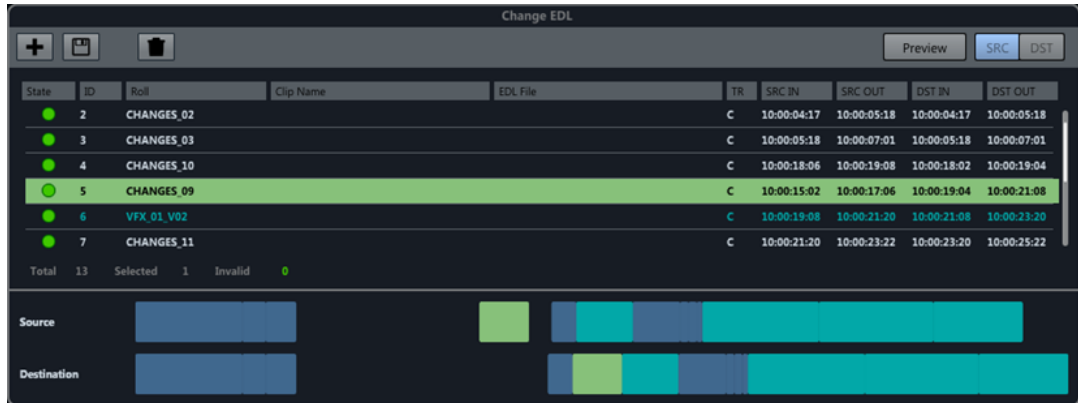

State	ID	Roll	Clip Name	EDL File	TR	SRC IN	SRC OUT	DST IN	DST OUT
●	2		CHANGES_02		C	10:00:04:17	10:00:05:18	10:00:04:17	10:00:05:18
●	3		CHANGES_03		C	10:00:05:18	10:00:07:01	10:00:05:18	10:00:07:01
●	4		CHANGES_10		C	10:00:18:06	10:00:19:08	10:00:18:02	10:00:19:04
●	5		CHANGES_09		C	10:00:15:02	10:00:17:06	10:00:19:04	10:00:21:08
●	6		VFX_01_V02		C	10:00:19:08	10:00:21:20	10:00:21:08	10:00:23:20
●	7		CHANGES_11		C	10:00:21:20	10:00:23:22	10:00:23:20	10:00:25:22

Total 13 Selected 1 Invalid 0

Source: [Timeline visualization showing colored segments]

Destination: [Timeline visualization showing colored segments]

Each entry in the **Change EDL** specifies which parts of the current project version, indicated by the timecodes in the **SRCIN** and **SRCOUT** columns, are to be put at a different position in the new project version, indicated by the timecodes in the **DSTIN** and **DSTOUT** columns.

If you select an entry in the **Change EDL**, the corresponding entries in the old and new EDLs are displayed in a different color.

Timelines

Below the **Change EDL**, the entries of the old and new EDLs that were used for creating the **Change EDL** are displayed on timelines. The **Source** timeline displays the old EDL, the **Destination** timeline the new EDL.

Entries that are selected in the **Change EDL** are highlighted in the same color on the timelines. VFX shots that were found while the **Change EDL** was being created have a specific color in the list and on the timelines.

Preview

The **Preview** function of the **Change EDL** section allows you to check how one or several selected entries will affect the result of the ReConform process. Any manual healing or extending of entries as well as the editing of timecodes in the **Change EDL** can be previewed before the start of the actual process. You can listen to the result and inspect the audio and video material of the source version and the destination version in detail. You can also add notes to the destination preview. It is not possible to make changes to the destination version.

In the **Project** window, locators mark the time range that is used during the **ReConform** process. Technically, the preview result is added to the project with a one day time offset, which will be deleted after the preview is deactivated. The resulting tracks are locked for as long as the preview is active. This prevents you from making changes to the resulting material, as the changes will be lost as soon as the preview is deactivated.



Preview

If this button is activated, the preview shows the source or the destination version of the selected entry in the **Project** window. The button blinks if the preview is active.

SRC

If this button is activated, the preview shows the source version of the selected entries in the project.

DST

If this button is activated, the preview shows the destination version of the selected entries in the project.

Adding Notes to the Preview

In the preview, you can create markers to add notes within the destination time range.

For example, if you discover problems within the generated data of the preview, you can add notes to the **Memos** marker track that is automatically created when you activate the preview. The notes are transferred to the corresponding entry in the source version.

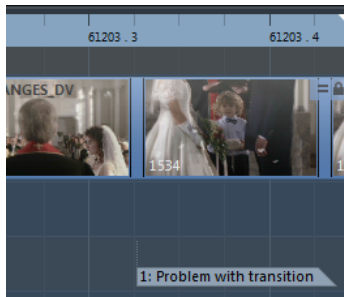

PROCEDURE

1. Activate **DST** to display the destination version of the selected entry.
 2. On the **Memos** marker track, add a marker and move it to the required position.
 3. Enter a description for the marker.
-

RELATED LINKS

[Marker Track](#) on page 377

Adding EDLs



You can add standard EDLs to the **Old EDL** and **New EDL** lists in the **ReConform** dialog. You can import an existing **Change EDL** to the **Change EDL** section.

PREREQUISITE

You have received EDL files in one of the following formats:

- CMX3600
 - FILE16
 - FILE32
-

PROCEDURE

1. In any of the lists, click **Add EDL** .
- The **Add EDL to <name of list> List** dialog opens.
2. Click **Browse EDL Files** .
3. Select one or more EDL files and click **Open**.

- Optional: In the **Add EDL to <name of list> List** dialog, specify a timecode offset for the destination times in the **DST Offset** field. In the **Add EDL to Change EDL List** dialog, you can also specify a timecode offset for the source times in the **SRC Offset** field.
 - Click **OK**.
-

RESULT

The EDL is displayed in the **ReConform** dialog. The timecode offsets are added.

Deleting EDLs

You can delete added EDLs from the **ReConform** dialog.

PROCEDURE

- In the EDL, click **Delete** .
-

RESULT

The EDL is deleted from the dialog.

Modifying Timecodes

You can modify the source and destination start and end times for a selected entry in an EDL.

PROCEDURE

- Select an entry in **Old EDL**, **New EDL**, or **Change EDL**.
- Right-click the entry.
The context menu opens.
- Select **Edit**.

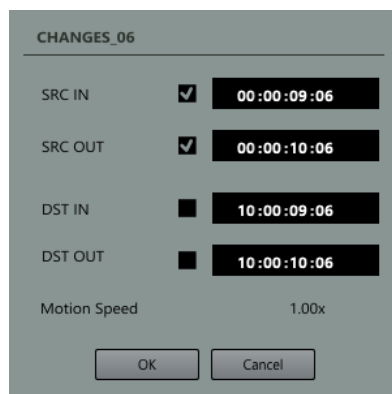

- In the dialog, change the timecodes of the source and destination time ranges. You have the following options:
 - Activate either **SRC IN** and **SRC OUT** or **DST IN** and **DST OUT** and change only one of the timecodes. The other timecode is automatically adjusted. The range length remains the same.
 - Activate either **SRC IN** and **DST IN** or **SRC OUT** and **DST OUT** and change only one of the timecodes. The other timecode is automatically adjusted. The range length in the SRC and DST areas are equally modified.
 - If you want to change the beginning or end of the time range, you can change one of the timecodes.

NOTE

The **Motion Speed** indicator that is available if you modify timecodes in the old and new EDLs informs you about differing source and destination range lengths. If it displays "2.00x", the source range is twice the length of the destination range. This indicates that the source material is referenced with double playback speed.

EXAMPLE

You have received an EDL, but the EDL does not match with the video. This can occur if a video sequence is changed after the EDL was created.

If the video sequence was moved, you can, for example, activate the **SRC IN** and **SRC OUT** timecodes and change these accordingly.

Deleting EDL Entries

You can delete EDL entries from the added or generated EDLs.

PROCEDURE

1. Select one or multiple entries in the EDL.
 2. Right-click the entries.
 3. Select **Delete**.
-

RESULT

The entries are deleted from the EDL.

Generating Change EDLs

You can generate a **Change EDL** from an old and a new EDL.

PREREQUISITE

You have added an old and a new EDL file to the **ReConform** dialog.

PROCEDURE

- Click **Generate**.
-

RESULT

The **Change EDL** is added to the **ReConform** dialog. It displays the changes between the old and new EDL files.

Saving Change EDLs

You can save a **Change EDL** that you generated with the **ReConform** function.

PROCEDURE

1. Click **Save Change EDL** .
 2. Enter the name of the file.
 3. Click **Save**.
-

Healing Entries in the Change EDL

Healing entries helps reducing the complexity of a **Change EDL** by combining two or more consecutive entries to become one entry.

Healing is useful if the comparison of old and new EDL results in a **Change EDL** in which multiple consecutive entries are unchanged and still in the same order.

PROCEDURE

1. Select two or more consecutive entries in the **Change EDL**.
2. Right-click within the selected entries.
3. Select **Healing** and choose from the following options:
 - **None**
Entries are not combined.
 - **Normal**
Consecutive entries without gaps are combined to a single entry.
 - **Gaps without Inserts**
Consecutive entries with gaps are combined to a single entry if the gap length is identical in source and destination file and there is no **New EDL** entry that inserts a new video clip into this gap.
 - **Gaps with Inserts**
Even if a **New EDL** entry inserts a new video clip into a gap, consecutive entries with gaps are combined to a single entry if the gap length is identical in source and destination file.

NOTE

You can automate the healing process by selecting one of the **Heal Processing** options in the options dialog. You can always return to uncombined entries by selecting **None**.

RESULT

The selected consecutive entries become one entry.

RELATED LINKS

[ReConform Settings](#) on page 1281

Extending Entries in the Change EDL

Extending entries helps closing gaps that are caused by new inserts.

Some inserts from new EDLs can replace existing events in the previous EDLs. This deletes already existing audio for the previous events and creates gaps. You can extend events before or after a gap to use their audio within the gap.

PROCEDURE

1. Right-click an entry in the **Change EDL**.
2. Select **Extend Event** and choose one of the following options:
 - **Until Previous Event**
Extends the entry to the previous event.
 - **Until Next Event**
Extends the entry to the following event.

- **Until Previous and Next Event**
Extends the entry to the previous and the following event.
-

RESULT

The source and destination ranges of the entry are extended.

EXAMPLE

If you have a series of film scenes and in one shot, the director chose to use the picture of camera 2 instead of camera 1, this picture change is detected by the **ReConform** function. In the **Change EDL**, the original audio for the new picture shot is discarded and replaced by an empty area. If you want to keep the audio that was used right before the shot, you can extend the length of an existing **Change EDL** entry to a neighboring gap.

ReConform Settings

ReConform provides settings that allow you to configure the **ReConform** function and to automate several functions.

To open the **ReConform Settings** pane, at the bottom of the **ReConform** dialog, click **Open ReConform Settings** .

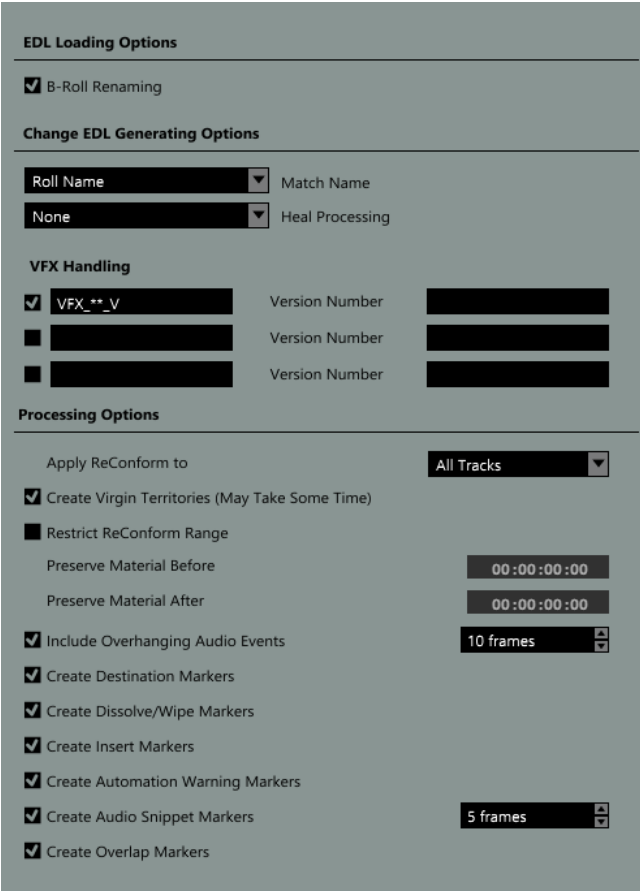

EDL Loading Options

- B-Roll Renaming

Change EDL Generating Options

- Roll Name:
- None:

VFX Handling

- VFX_**_V: Version Number
- : Version Number
- : Version Number

Processing Options

- Apply ReConform to:
- Create Virgin Territories (May Take Some Time)
- Restrict ReConform Range
- Preserve Material Before:
- Preserve Material After:
- Include Overhanging Audio Events:
- Create Destination Markers
- Create Dissolve/Wipe Markers
- Create Insert Markers
- Create Automation Warning Markers
- Create Audio Snippet Markers:
- Create Overlap Markers

EDL Loading Options

B-Roll Renaming

If this option is activated, the roll names of all entries in a loaded EDL are searched for a trailing "B". If a trailing "B" is found in any of the entry names and if the EDL contains

an entry with the same name that has no trailing "B", the B is deleted from the roll name.

Change EDL Generating Options

Match Name

Allows you to decide if the roll name or the clip name of an event is used for creating the **Change EDL**. Use the clip name if the roll name is not unique due to the data format, for example.

Heal Processing

Allows you to combine specific entries in the **Change EDL** to reduce complexity.

- **None**
Entries are not combined.
- **Normal**
Consecutive entries without gaps are combined to a single entry.
- **Gaps without Inserts**
Consecutive entries with gaps are combined to a single entry if the gap length is identical in source and destination file and there is no **New EDL** entry that inserts a new video clip into this gap.
- **Gaps with Inserts**
Even if a **New EDL** entry inserts a new video clip into a gap, consecutive entries with gaps are combined to a single entry if the gap length is identical in source and destination file.

VFX Handling

Allows you to specify and activate up to 3 naming patterns for recognizing VFX (visual effects) shots in the loaded EDL. VFX shots are film sequences with a multitude of different versions that are denoted in the clip or roll name of a corresponding EDL entry according to a custom naming scheme. As VFX shot changes usually have no impact on the audio, naming patterns ensure that simple version changes are not treated as inserts.

Each pattern definition must contain a version number that may be extended by a prefix and a suffix, for example, "VFX_01_V03.mpg", where "VFX_01_V" is the prefix, "03" the version number, and ".mpg" the suffix.

If naming patterns are activated, **Old EDL**, **New EDL**, and **Change EDL** show the recognized VFX shots in a different color.

Processing Options

You can use the following options to specify what the **ReConform** function must take into account. For every marker setting, a marker track is created in the **Project** window.

Apply ReConform to

Allows you to process all tracks or selected tracks.

Create Virgin Territories

If this option is activated, the **ReConform** function automatically creates automation gaps where required, for example, where new scenes have been inserted.

Restrict ReConform Range

If this option is activated, the project data before and after the specified timecodes is not changed during the **ReConform** process.

- **Preserve Material Before**
Enter the timecode before which the project data may not be changed.

- **Preserve Material After**

Enter the timecode after which the project data may not be changed.

Include Overhanging Audio Events

If this option is activated, overhanging sections of audio events are taken into account when video clips are moved. You can specify the maximum frame length for these overhangs.

Create Destination Markers

If this option is activated, cycle markers are created that display the position of each **Change EDL** entry after the **ReConform** function is applied.

Create Dissolve/Wipe Markers

If this option is activated, dissolve or wipe markers are created at positions where dissolve or wipe transitions in the source EDLs are converted into cuts in the **Change EDL** file.

Create Insert Markers

If this option is activated, cycle markers are created at positions where the new EDL inserts new video clips.

Create Automation Warning Markers

If this option is activated, markers are created at positions where automation is affected, for example, when a jump occurs. The name of the marker contains the name of the affected audio track.

Create Audio Snippet Markers

If this option is activated, audio snippet markers are created for small sections of audio events that are cut off from the events. For the **ReConform** function to detect a snippet, you can specify the maximum threshold in frames.

Create Overlap Markers

If this option is activated, overlap markers are created for audio events that overlap each other after the **ReConform** process.

RELATED LINKS

[Restricting the ReConform Range](#) on page 1283

[Including/Excluding Overhanging Audio Events](#) on page 1284

[Examples for Markers](#) on page 1285

[Markers](#) on page 368

[Virgin Territory vs. Initial Value](#) on page 815

Restricting the ReConform Range

You can exempt project material from the **ReConform** process.

Usually, the **ReConform** function is applied to an entire Nuendo project. In this case, the used EDLs lead to a restructuring of all material that is available. However, if the project contains more than one episode, you may want the new EDL to restructure only the episode that contains changes instead of the entire project. To avoid that the rest of the project data is changed or overwritten, use the **Restrict ReConform Range** option in the **ReConform Settings** pane.

PROCEDURE

1. In the **ReConform Settings** pane, activate **Restrict ReConform Range**.
2. Enter the range that you want to preserve.
 - In the **Preserve Material Before** field, enter the timecode before which the project data may not be changed.

- In the **Preserve Material After** field, enter the timecode after which the project data may not be changed.
-

RELATED LINKS

[ReConform Settings](#) on page 1281

Including/Excluding Overhanging Audio Events

You can prevent overhanging audio events from being cut if a video clip does not have the same length as the audio event.

If a video clip is shorter than the corresponding audio event, the **ReConform** process may cut off the sections of the audio event that hang over. To avoid these cuts, you can activate the **Include Overhanging Audio Events** option in the **Processing Options**. If you move video clips to another position, the overhanging sections of the audio events are moved together with the video clip.

You can specify the maximum number of overhanging frames.

EXAMPLE

In the illustration, video clip 1 is shorter than audio event 1. If you activate the **Include Overhanging Audio Events** option and move the video clip to another position, the audio event moves with the video clip. Its length remains unchanged. If the option is deactivated, the overhanging sections in audio event 1 are cut off.

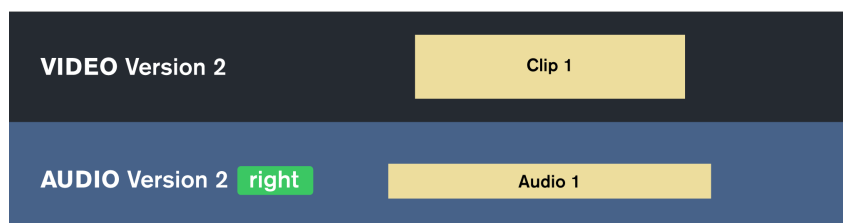
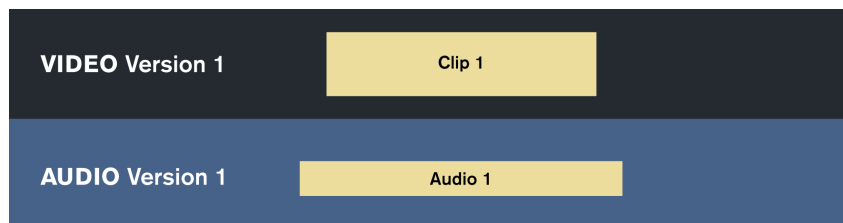

RELATED LINKS

[ReConform Settings](#) on page 1281

Examples for Markers

The following examples provide an overview of the markers that can be created by the **ReConform** process.

Dissolve/Wipe Markers

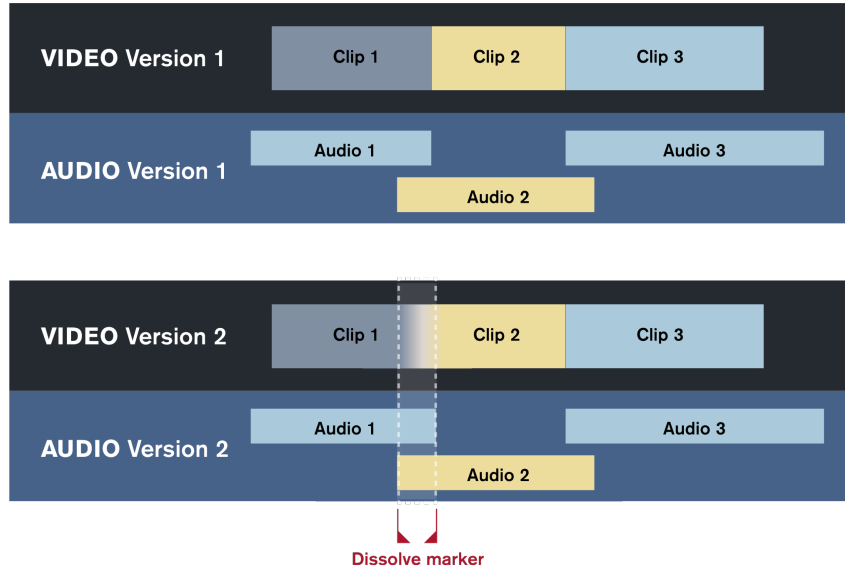

A dissolve or wipe marker is created if either the old or the new EDL contains a dissolve or wipe transition between 2 video clips. In the illustration, such a transition is detected in video version 2 where a marker is added. In the **Change EDL**, this transition is converted into a cut. The **Dissolve/Wipe** marker track displays the position of the cut.

Insert Markers

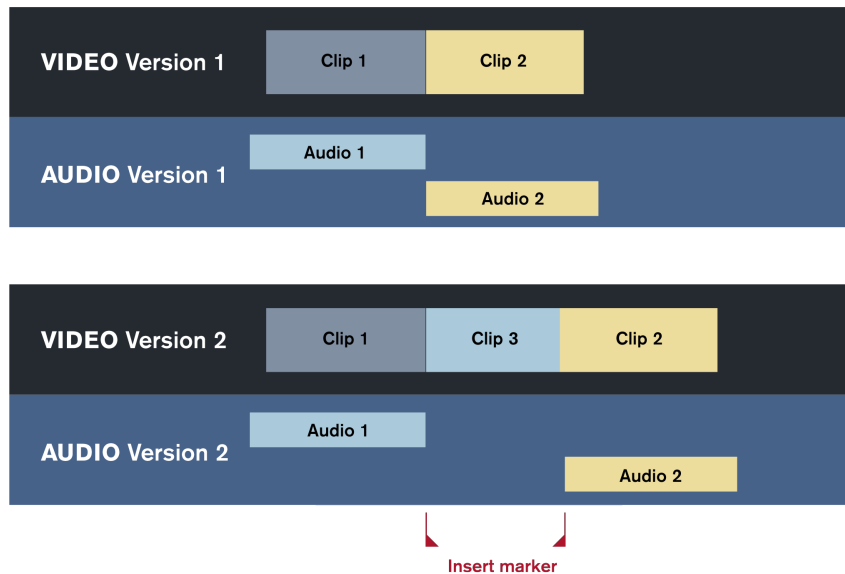

An insert marker is created if the new EDL inserts a new video clip. The **ReConform** process inserts a cycle marker at the position of the new video clip. In the illustration, clip 3 is the new video clip. The **Insert** marker track displays the position of the new video clip.

Automation Warning Markers

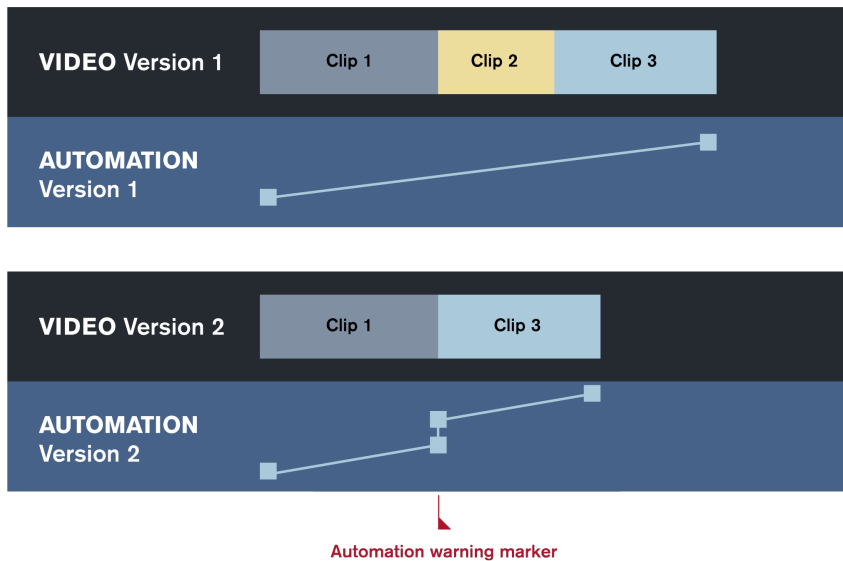

Automation warning markers are created if changes in the video cut lead to strong differences in automation curves, such as jumps. In the illustration, the automation curve in version 1 increases gradually from clip 1 to clip 3. In version 2, clip 2 has been deleted, which breaks the automation curve and lets it continue at a different level. The **ReConform** process detects this and creates an automation warning marker at this position. The **Automation Warning** marker track displays the position of the automation issue.

Audio Snippet Markers

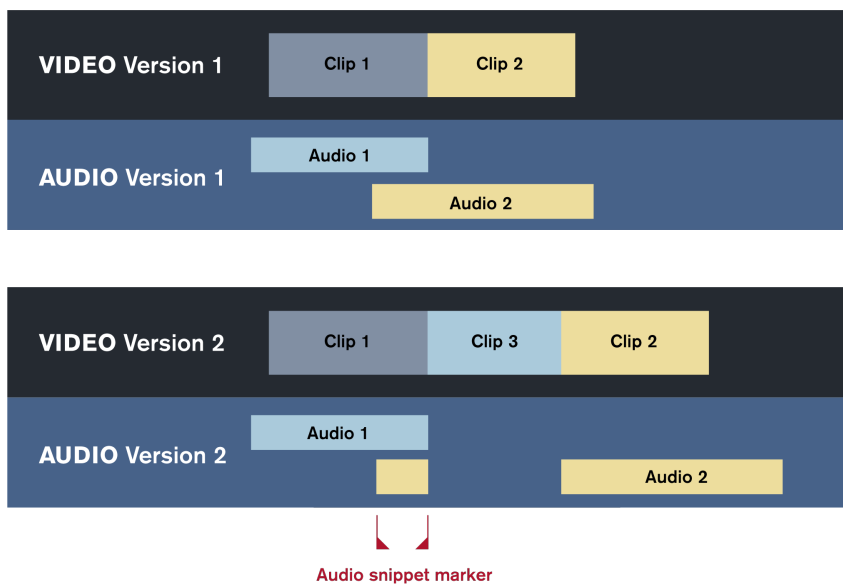

Audio snippet markers are created if the **ReConform** process divides existing audio events due to insertions in the recut video. If one of the cut pieces is a small snippet, it is marked with an audio snippet marker. To define the length of the snippets, you can set the number of frames using the **Create Audio Snippet Markers** option. In the illustration, clip 3 is inserted between clip 1 and 2 in video version 2. The audio event audio 2 is divided in 2 sections. One of these events remains as an audio snippet connected to clip 1. An audio snippet marker is inserted at the position of the audio snippet. The **Audio Snippet** marker track displays the position of the audio snippet.

Video Preview

You can preview new and recut video material in the **Video** section of the **ReConform** dialog.

The video preview allows you to check if the **ReConform** process performs a correct recut of the available video material. The video preview displays the video track in a recut version that can be compared with the new video material. In general, these must match. If the new video material is longer or if it contains previously unavailable material, the resulting recut video preview shows no content. In other cases, where the previews differ, there may be an issue with the delivered video material or with the edits in the **Change EDL**.

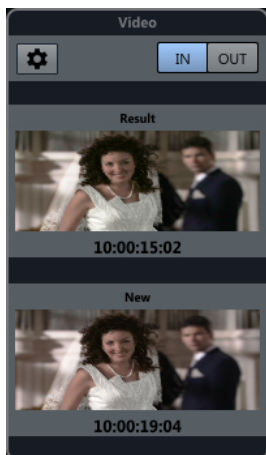

Correct video preview

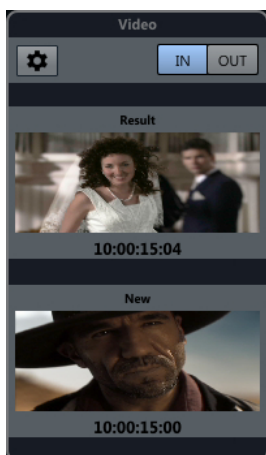

Erroneous video preview

The video preview displays video frames as soon as you select an entry in the **Change EDL**. You can switch to the last frame. The timecode shows the start or end times of the entry.

Technically, the new video material is copied onto a specific video track when the video preview is activated.

If you get new video material, you can select it in the video preview settings.

RELATED LINKS

[Change EDL Section](#) on page 1276

Video Section

The **Video** section in the **ReConform** dialog displays video frames of the selected entry in the **Change EDL**.

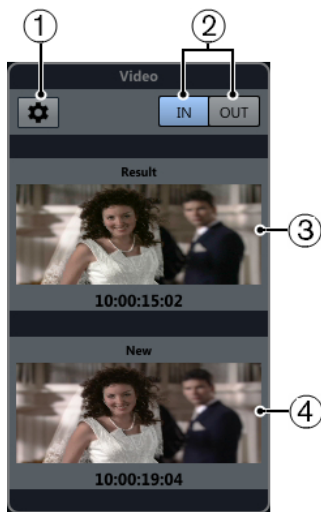

- 1 Open Video Preview Settings**
Opens the video preview settings.
- 2 IN/OUT**
Allows you to switch between first (**IN**) and last (**OUT**) video frame. A highlighted button indicates which frame is active.
- 3 Result**
Displays the first or last video frame of the recut video track including the corresponding timecode.
- 4 New**
Displays the first or last video frame of the delivered new video track.

Video Preview Settings

The video preview settings allow you to specify the video tracks that the **ReConform** function uses for a recut.

To open the video preview settings, in the **Video** section, click **Open Video Preview Settings** .

Video Track Assignment

Allows you to specify which video track contains the old and which the new video material. If you are working on a project that contains a video track, this track is automatically selected as the one containing the old material.

New Video Track Configuration

Allows you to select one or multiple video files from the **Pool** to be used as the recut video material.

NOTE

- If you see no files, you must add them to the **Pool**.
- If you select several files, their timecodes may not overlap.

RELATED LINKS

[Pool](#) on page 675

Selecting Material for New Video Tracks

You can select video material from the **Pool** to be used for the recut version.

PREREQUISITE

You have added the video files to the **Pool**.

PROCEDURE

1. In the **New Video Track Configuration** section, activate one or multiple video files by clicking in the **Use as New Video** column next to the video file names.
 2. Adjust the **Start** and **End** timecodes according to your needs.
-

Determining Old and New Video Tracks

You can determine which of the used video tracks contains the old and which the new material.

PROCEDURE

- In the **Video Track Assignment** section, click in the **Old Edit Version** or **New Edit Version** column next to the video track name.
The other video track is automatically selected as the other version.
-

Exchanging Files with Other Applications

Nuendo supports a number of file formats that you can use to exchange files with other applications.

RELATED LINKS

[AES31 Files](#) on page 1290

[Cue Sheets](#) on page 1292

[OMF Files](#) on page 1295

[AAF Files](#) on page 1299

[ADM Files](#) on page 1304

[MXF Files](#) on page 1306

AES31 Files

The AES31 standard is an open file interchange format developed by the Audio Engineering Society that allows you to transfer projects from one workstation to another, retaining time positions, for example, of events, fades, and markers.

AES31 uses the widely used Microsoft FAT32 file system with Broadcast Wave as the default audio file format. You can transfer AES31 files to digital audio workstations that support AES31, regardless of the type of hardware and software used.

Importing AES31 Files

PROCEDURE

1. Select **File > Import > AES31**.
 2. In the file dialog, locate and select the AES31 file and click **Open**.
 3. Optional: If a project is open, choose if you want to create a new project.
If you select **No**, the AES31 file is imported into the current project.
 4. In the **Import Options** dialog, select the tracks that you want to import and make your changes.
 5. Click **OK**.
-

RESULT

The audio tracks, events, and markers of the imported AES31 file are added.

Exporting AES31 Files

PROCEDURE

1. Select **File > Export > AES31**.
2. In the **Export Options** dialog, select the tracks that you want to include in the exported file and make your changes.
3. Click **OK**.

4. In the file dialog, specify a name and location.
5. Click **Save**.

RESULT

- All audio track data including audio file references are exported.
- Real-time fades set up with the fade handles are automatically converted and saved in a fades folder.
- The marker positions of the first marker track in your project are exported.
- **MixConsole** settings, automation, and MIDI Tracks are not exported.
- The file is saved as an XML file with the extension .ad1 (audio decision list). You can open it in any text editor.

AES31 Export Options Dialog

The **AES31 Export Options** dialog allows you to activate tracks for export and to specify what data is included in the exported files.

- To open the **AES31 Export Options** dialog, select **File > Export > AES31**.

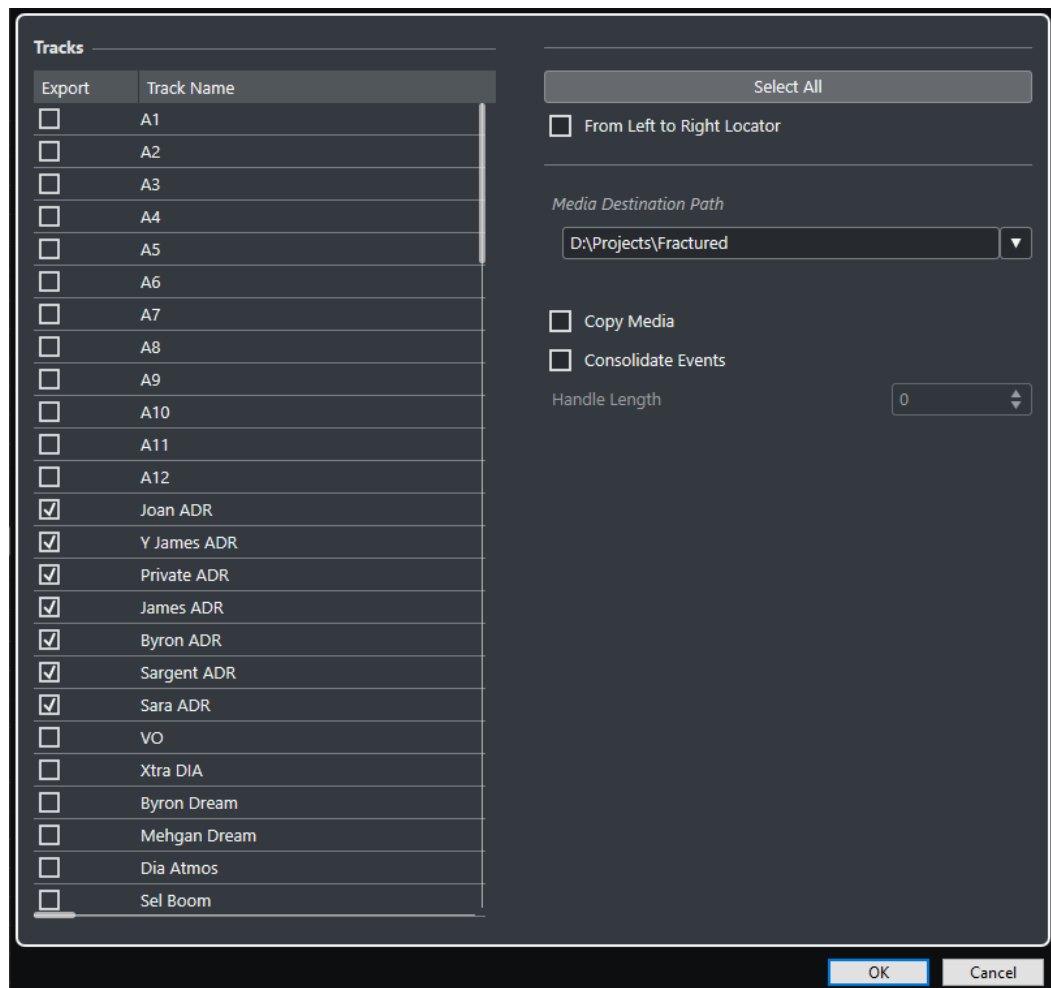

Export

Allows you to select a track for export.

Track Name

Shows the track name.

Select All

Selects all tracks in the project for export.

From Left to Right Locator

Allows you to export the range between the locators only.

Media Destination Path

Allows you to specify a location for the exported files. You can also click **Browse**.

NOTE

You can create references to media destinations that do not exist on the system you are working with. This allows you to prepare files for use in projects on another system or in a network environment, for example.

Copy Media

Allows you to create copies of all the media files. By default, the copied audio files are placed in a subdirectory in the export destination folder. To specify a different location for the copied files, use the **Media Destination Path** field.

Consolidate Events

Allows you to copy only the portions of audio files that are used in the project.

The **Handle Length** value allows you to define a length in milliseconds to include audio outside each event boundary for later fine-tuning. Handles allow you to adjust fades or edit points when the project is imported into another application.

Cue Sheets

You can export a cue sheet that contains detailed information about audio, video, markers, and plug-ins used in your project.

A cue sheet is often needed for billing purposes, such as reporting any used music or film. Furthermore, it can be helpful to reconstruct small projects on other production systems or in case of data loss.

The cue sheet is exported as plain text in CSV or TXT format for further processing in an appropriate editor.

Each cue sheet exported from Nuendo contains the following sections:

Project Information

Provides global project information about project name, sample rate, bit depth, frame rate, author, company, and start and end time.

Audio Track List

Lists all tracks of your project that you selected in the **Export Options** dialog and provides track name, channel configuration, and notepad content for each track. Optionally, you can add detailed information about the events used on each track.

Marker Track List

Lists all marker tracks.

Video Track List

Lists all video tracks.

Additionally, you can add the following sections to the cue sheet:

File List

Lists all audio files that are used in your project.

Plug-in List

Lists all plug-ins that are used in your project.

The following restrictions apply:

- Inactive and hidden tracks are listed.
- Only the events of active track versions are listed.
- Parts are regarded as single events.
- Events are listed, regardless of whether the corresponding media is missing or not.
- Events on all lanes of a track are listed, regardless of any overlaps.

RELATED LINKS

[Exporting a Cue Sheet](#) on page 1293

[Cue Sheet Export Options Dialog](#) on page 1293

[Showing/Hiding Individual Tracks](#) on page 70

Exporting a Cue Sheet

PROCEDURE

1. Select **File > Export > Cue Sheet**.
 2. In the **Export Options** dialog, select the tracks that you want to include in the exported file.
 3. Change the settings in the **Options** and in the **Additional Cue Sheet Content** section as required.
 4. Click **OK**.
 5. In the file dialog, specify a name and location.
 6. Click **Save**.
-

RESULT

The cue sheet is created at the specified location.

RELATED LINKS

[Cue Sheet Export Options Dialog](#) on page 1293

Cue Sheet Export Options Dialog

The **Export Options** dialog allows you to activate tracks for export and to specify what data is included in the exported files.

- To open the **Export Options** dialog, select **File > Export > Cue Sheet**.

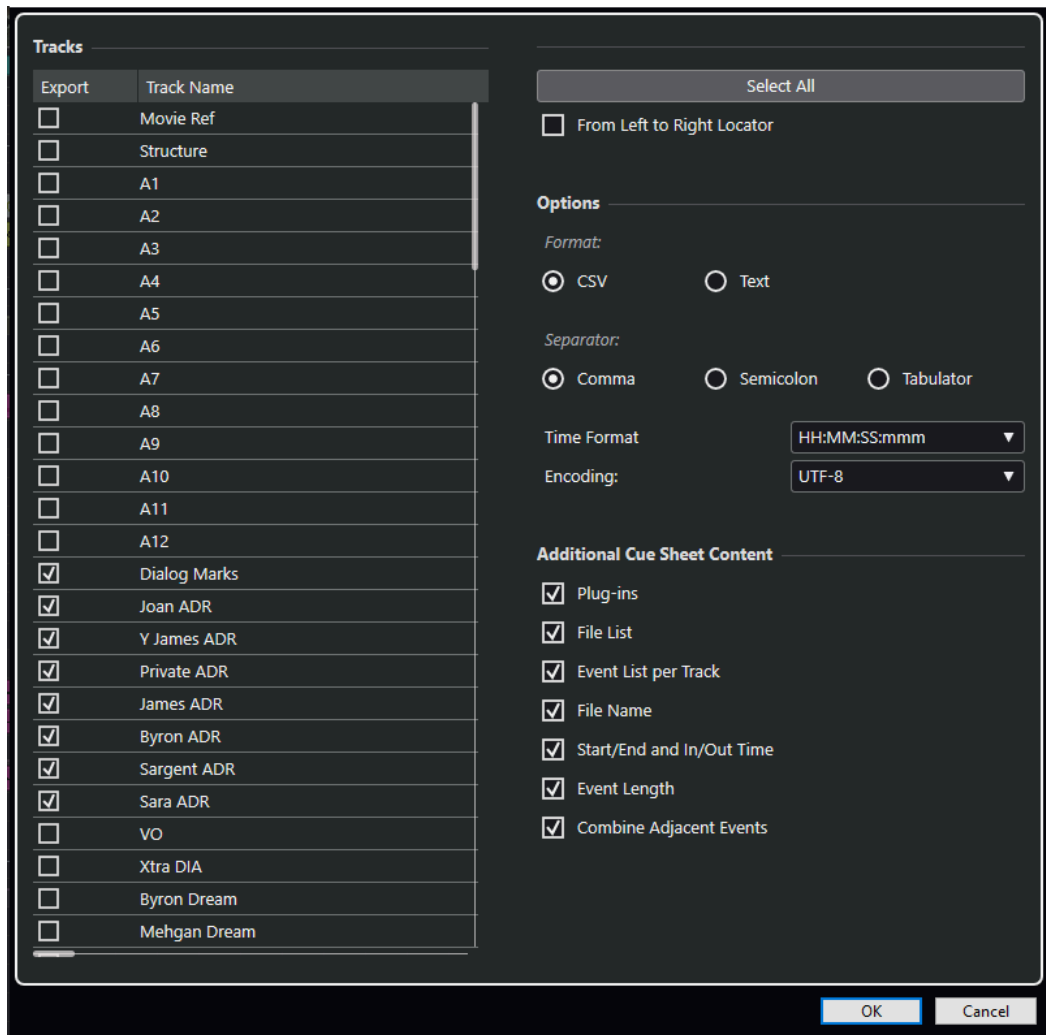

Export

Allows you to select a track for export.

Track Name

Shows the track name.

Select All

Selects all tracks in the project for export.

From Left to Right Locator

Allows you to export the range between the locators only.

Format

Allows you to select the export format. The available formats are **CSV** and **Text**.

Separator

Allows you to specify the kind of separator used in the CSV file.

Time Format

Allows you to select a time format for your cue sheet.

Encoding

Allows you to select an encoding format for the CSV file.

Plug-ins

Adds information about all plug-ins that are used in your project to the cue sheet.

File List

Adds a list of all audio files that are used in your project to the cue sheet.

Event List per Track

Adds a list of the events per track that are used in your project to the cue sheet.

File Name

Adds the file names to the **Event List per Track**.

Start/End and In/Out Time

Adds the start and end point on the project timeline (**Start Time/End Time**) and the start and end point on the clip timeline (**In Time/Out Time**) for each event to the **Event List per Track**.

Event Length

Adds the length of the events to the **Event List per Track**.

Combine Adjacent Events

If this option is activated, adjacent or overlapping events are listed as a single event.

OMF Files

Open Media Framework Interchange (OMFI) is a platform-independent file format that allows you to transfer digital media between different applications.

Nuendo can import and export OMF files.

Importing OMF Files

PROCEDURE

1. Select **File > Import > OMF**.
2. In the file dialog, select the OMF file and click **Open**.
3. Optional: If a project is open, choose if you want to create a new project.
If you select **No**, the OMF file is imported into the current project.
4. In the **Import Options** dialog, choose the tracks that you want to import and make your changes.
5. Click **OK**.
6. Optional: If the OMF file contains video event information, choose whether you want to create markers at the start position of the video events.

NOTE

You can use these markers as position references if you want to manually import the video files.

RESULT

The audio events of the imported OMF file are added.

OMF Import Options Dialog

The **OMF Import Options** dialog allows you to activate tracks for import, to specify the destination in the active project and the data that is to be imported.

- To open the **OMF Import Options** dialog, select **File > Import > OMF**.

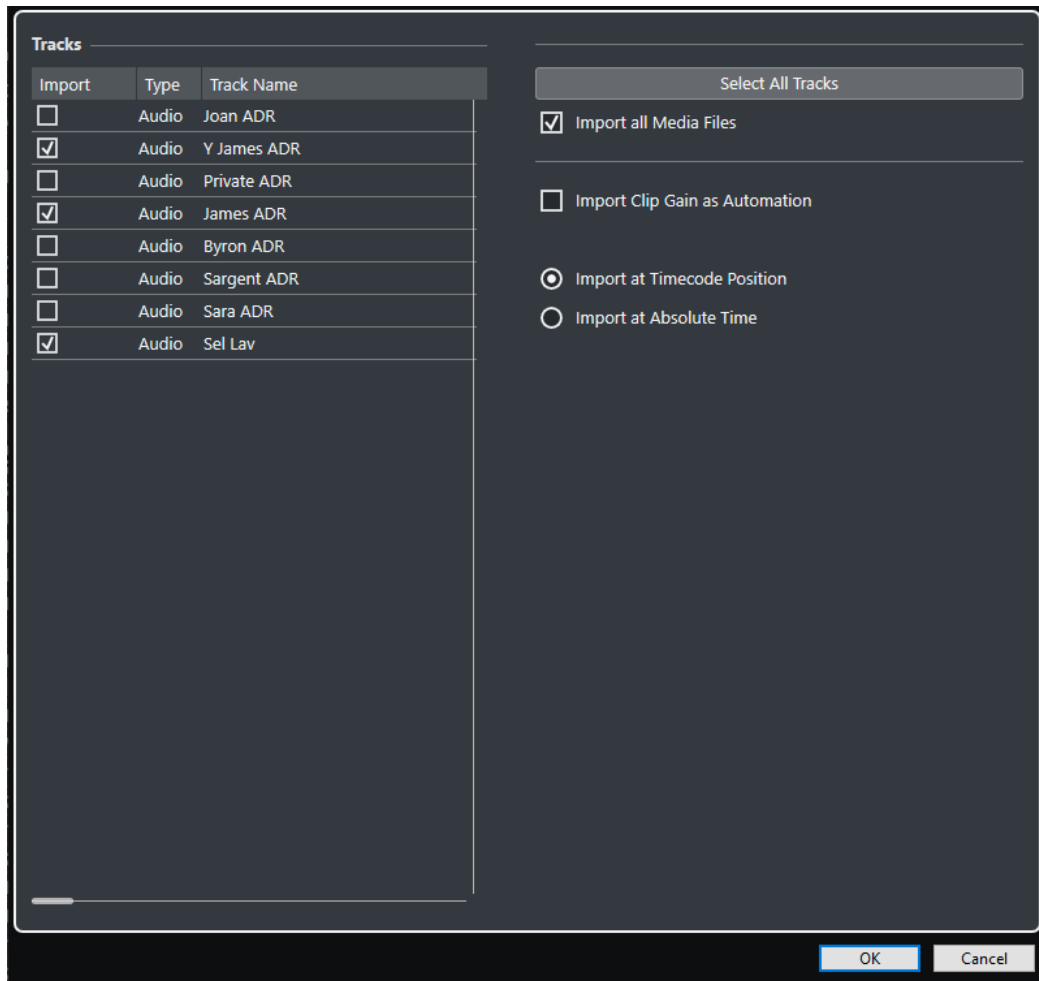

Import

Allows you to select a track for import.

Type

Shows the media type of the track.

Track Name

Shows the track name.

Select All Tracks

Selects all tracks for import.

Import All Media Files

Imports media files that are not referenced by events.

Import Clip Gain as Automation

Imports volume automation and envelopes of the volume automation track of each track.

Import at Timecode Position

Inserts the elements contained in the file at their original timecode positions. This ensures that the elements are placed at their correct time positions even if Nuendo uses a different frame rate than the file.

Import at Absolute Time

Inserts the elements contained in the file starting at the timecode position saved in the file and keeping the relative distances between the elements.

Exporting OMF Files

PREREQUISITE

Consider setting up your project to use mono tracks and mono files. This allows compatibility with audio applications that provide limited support for interleaved audio files.

PROCEDURE

1. Select **File > Export > OMF**.
 2. In the **Export Options** dialog, select the tracks that you want to include in the exported file and make your changes.
 3. Click **OK**.
 4. In the file dialog, specify a name and location.
 5. Click **Save**.
-

RESULT

The OMF file is exported. It contains or references all audio files that are played in the project, including fade and edit files.

Unused audio files that are referenced in the **Pool**, or any MIDI data are not contained in the file. Video files are not included.

RELATED LINKS

[Splitting Multi-Channel Audio Tracks](#) on page 179

OMF Export Options Dialog

The **OMF Export Options** dialog allows you to activate tracks for export and to specify what data is included in the exported files.

- To open the **OMF Export Options** dialog, select **File > Export > OMF**.

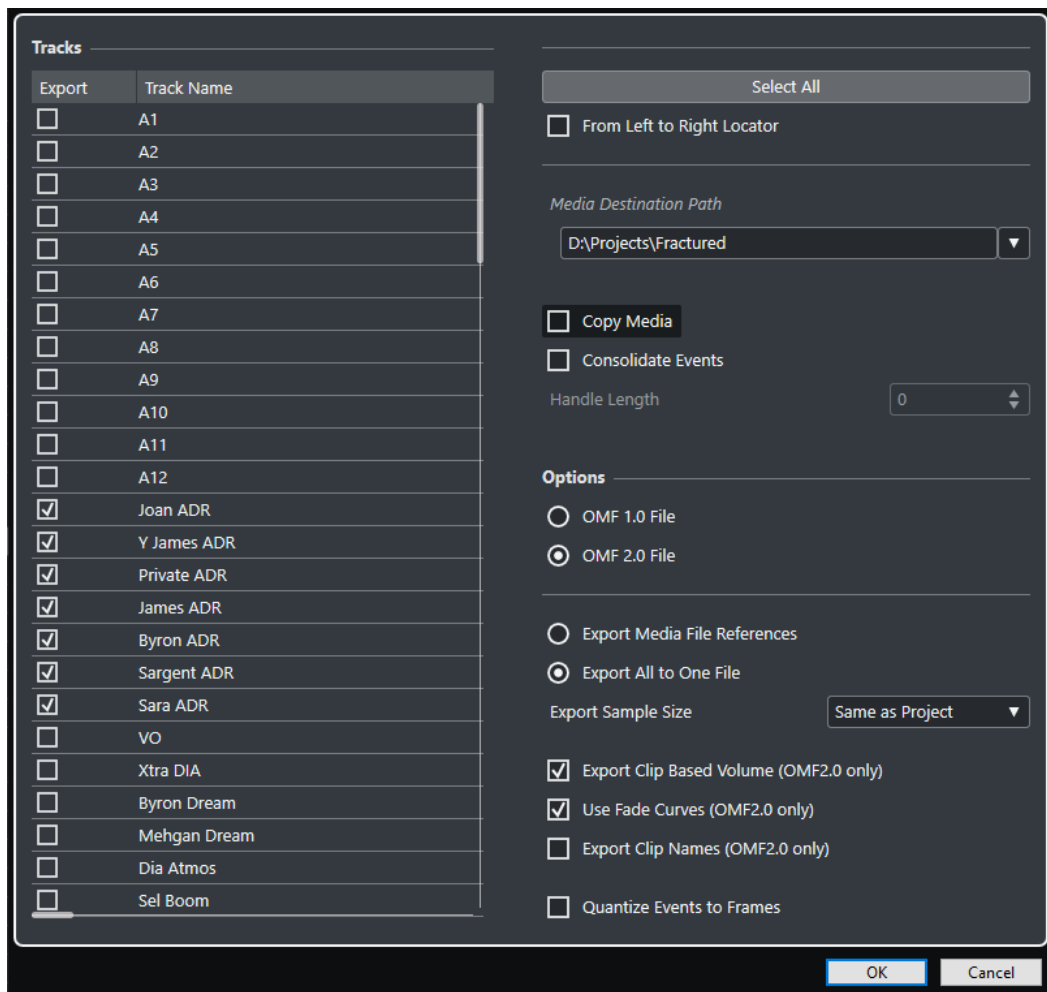

Export

Allows you to select a track for export.

Track Name

Shows the track name.

Select All

Selects all tracks in the project for export.

From Left to Right Locator

Allows you to export the range between the locators only.

Media Destination Path

Allows you to specify a location for the exported files. You can also click **Browse**.

NOTE

You can create references to media destinations that do not exist on the system you are working with. This allows you to prepare files for use in projects on another system or in a network environment, for example.

Copy Media

Allows you to create copies of all the media files. By default, the copied audio files are placed in a subdirectory in the export destination folder. To specify a different location for the copied files, use the **Media Destination Path** field.

Consolidate Events

Allows you to copy only the portions of audio files that are used in the project.

The **Handle Length** value allows you to define a length in milliseconds to include audio outside each event boundary for later fine-tuning. Handles allow you to adjust fades or edit points when the project is imported into another application.

OMF 1.0 File

Allows you to select an OMF version. Select this depending on which version is supported by the application in which you plan to import the file.

OMF 2.0 File

Allows you to select an OMF version. Select this depending on which version is supported by the application in which you plan to import the file.

Export Media File References

Exports only media file references. This keeps the exported file small. However, the referenced audio files must be available for the receiving application.

Export All to One File

Exports all data to one self-contained file. This could result in a large file size.

Export Clip-Based Volume (OMF 2.0 only)

Includes the volume settings that you set up with the volume handles for the events.

Use Fade Curves (OMF 2.0 only)

Includes the fades that you set up with the fade handles for the events.

Export Clip Names (OMF 2.0 only)

Includes the clip names for the events.

Export Sample Size

Allows you to set a sample size for the exported files.

Quantize Events to Frames

Moves the event positions in the exported file to exact frames. This is sometimes necessary when exporting projects to video workstations that limit the accuracy of edits to the frame.

AAF Files

The Advanced Authoring Format (AAF) is a multimedia file format that allows you to exchange digital media and metadata between different systems and applications across multiple platforms. Metadata include fades, automation, and processing information.

RELATED LINKS

[Importing AAF Files](#) on page 1299

[Exporting AAF Files](#) on page 1302

Importing AAF Files

PROCEDURE

1. Select **File > Import > AAF**.
2. In the File Explorer/macOS Finder, choose the AAF file and click **Open**.
3. If a project is already open in Nuendo, a dialog opens that allows you to choose a destination for the imported AAF file.
 - To import the AAF file to a new project, click **Yes**.

- To import the AAF file to your active project, click **No** and proceed with step 5.
4. In the File Explorer/macOS Finder, specify a project folder and click **Select Folder**.
 5. In the **Import Options** dialog, choose the tracks you want to import and make your changes.
 6. Click **OK**.

NOTE

Depending on the size of the imported project and whether the files are embedded or referenced, the import process may take a while.

RESULT

The audio tracks and events of the imported AAF file are added. If you have imported the file to a new project, the events are placed at their original timecode position. If you have imported the file to your active project, the events are placed at the position you have specified in the **Import Options** dialog.

RELATED LINKS

[AAF Import Options Dialog](#) on page 1300

AAF Import Options Dialog

The **AAF Import Options** dialog allows you to activate tracks for import and to specify the destination in the active project.

- To open the **AAF Import Options** dialog, select **File > Import > AAF**.

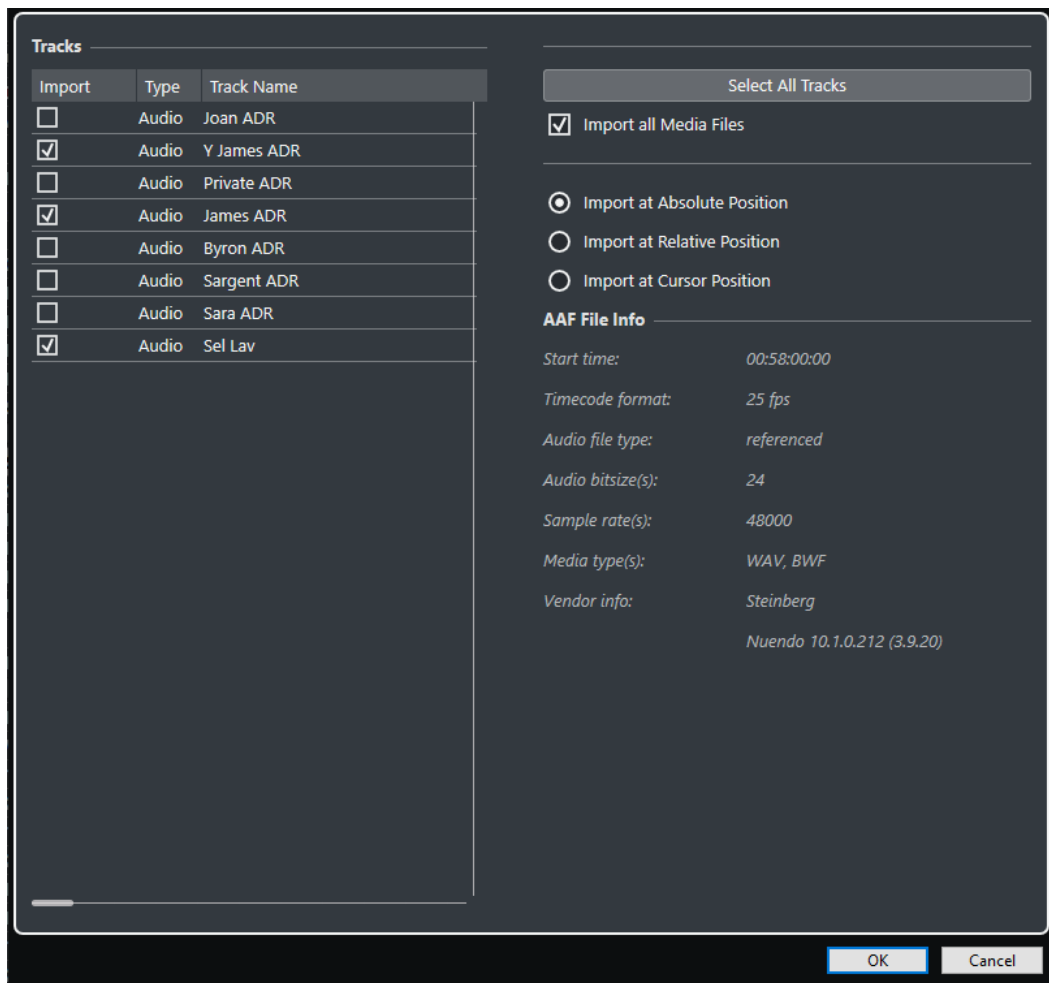

Import

Allows you to select a track for import.

Type

Shows the media type of the track.

Track Name

Shows the track name.

Select All Tracks

Selects all tracks for import.

Import All Media Files

Imports media files that are not referenced by events.

Import at Absolute Position

Places imported track data at its original timecode position in your active project.

Import at Relative Position

Places imported track data relative to the start time of your active project, taking the source project start time into account. For example, if the source project starts at timecode 01:00:00:00 with an event located at 02:00:00:00, and if the active project starts at 02:00:00:00, the imported event is placed at timecode 03:00:00:00.

Import at Cursor Position

Places imported track data relative to the cursor position in your active project, taking the source project start time into account. For example, if the source project starts

at timecode 01:00:00:00 with an event located at 02:00:00:00, and if the cursor in your active project is located at 02:00:00:00, the imported event is placed at timecode 03:00:00:00.

NOTE

- If the original timecode position of the imported data is outside of your project range, the start/end time of your project is modified.
 - The import position options are only available if you import the AAF file to your active project.
-

AAF File Info

Shows information about the file.

Exporting AAF Files

PROCEDURE

1. Select **File > Export > AAF**.
 2. In the **Export Options** dialog, select the tracks that you want to include in the exported file and make your changes.
 3. Click **OK**.
 4. In the file dialog, specify a name and location.
 5. Click **Save**.
-

RESULT

The AAF file is exported.

RELATED LINKS

[AAF Export Options Dialog](#) on page 1302

AAF Export Options Dialog

The **AAF Export Options** dialog allows you to activate tracks for export and to specify what data is included in the exported files.

- To open the **AAF Export Options** dialog, select **File > Export > AAF**.

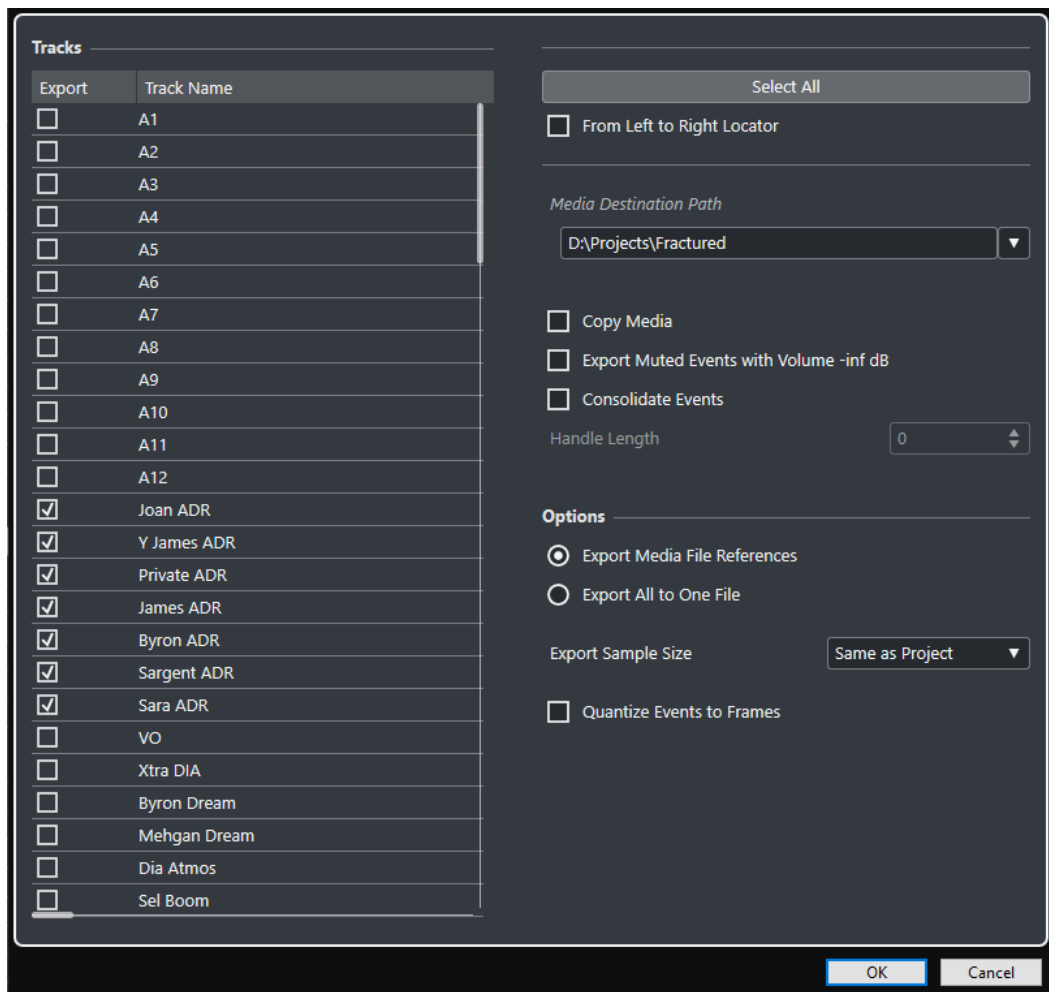

Export

Allows you to select a track for export.

Track Name

Shows the track name.

Select All

Selects all tracks in the project for export.

From Left to Right Locator

Allows you to export the range between the locators only.

Media Destination Path

Allows you to specify a location for the exported files. You can also click **Browse**.

NOTE

You can create references to media destinations that do not exist on the system you are working with. This allows you to prepare files for use in projects on another system or in a network environment, for example.

Copy Media

Allows you to create copies of all the media files. By default, the copied audio files are placed in a subdirectory in the export destination folder. To specify a different location for the copied files, use the **Media Destination Path** field.

Export Muted Events with Volume -inf dB

Sets muted events to a volume -inf dB on export.

Consolidate Events

Allows you to copy only the portions of audio files that are used in the project.

The **Handle Length** value allows you to define a length in milliseconds to include audio outside each event boundary for later fine-tuning. Handles allow you to adjust fades or edit points when the project is imported into another application.

Export Media File References

Exports only media file references. This keeps the exported file small. However, the referenced audio files must be available for the receiving application.

Export All to One File

Exports all data to one self-contained file. This could result in a large file size.

Export Sample Size

Allows you to set a sample size for the exported files.

Quantize Events to Frames

Moves the event positions in the exported file to exact frames. This is sometimes necessary when exporting projects to video workstations that limit the accuracy of edits to the frame.

ADM Files

Nuendo allows you to import Audio Definition Model (ADM) files, for example, complete Dolby Atmos premixes, for further mixing and editing. You can export your own Dolby Atmos mixes as fully compliant ADM BWF files.

You can import ADM files in Broadcast Wave Format (BWF), such as those exported from the Dolby Atmos Production Suite, Dolby Atmos Mastering Suite, or Cinema RMU (Dolby Rendering and Mastering Unit), into new or existing projects, preserving the hierarchical structure of the ADM file and all pan automation. The imported ADM can contain channel-based beds and object-based audio. Nuendo supports different ADM file structures containing the elements `audioProgramme`, `audioContent`, `audioObject`, and `audioChannel`, according to **Recommendation ITU-R BS.2076-1** by the International Telecommunication Union.

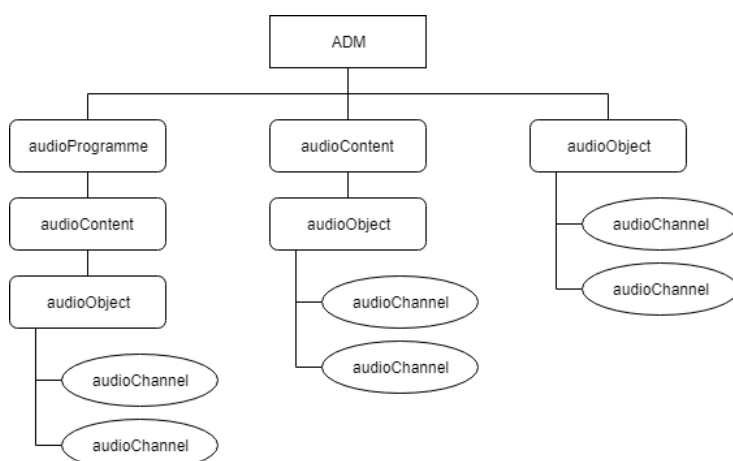

Supported ADM file structures

Cross-references between elements are also supported.

When importing ADM files into your Nuendo project, the following applies:

- Multi-channel audio from ADM files is extracted and split into mono files.

- Folder tracks are created to represent the file elements audioProgramme, audioContent, and audioObject. Each folder track contains the associated sub-elements.
- Folder tracks that represent an audioObject contain the mono audio tracks created from the channels of the object.

NOTE

If an audioObject only contains one channel, no folder track is created, but the mono track is created in the associated parent folder track or on the root level in the track list.

- Cross-references within the ADM file structure are replaced by copies of the corresponding files.
- Tracks with object audio are automatically assigned to **VST MultiPanner**, preserving existing pan automation.
- Tracks with bed audio channels are not automatically assigned to a panner.

You can export ADM data from your project as fully compliant ADM BWF (Broadcast Wave Format) files, containing the complete object structure with all metadata required for re-rendering on a Dolby Atmos playback system. This is done in the **ADM Authoring for Dolby Atmos** window.

When importing ADM files, the following applies:

- Multi-objects are split into the corresponding number of mono objects, containing their own panning metadata.

RELATED LINKS

[Authoring and Mixing for Dolby Atmos](#) on page 770

[Importing ADM Files](#) on page 1305

[Object Mixes with VST MultiPanner](#) on page 787

[Exporting ADM Files](#) on page 1306

[ADM Authoring for Dolby Atmos Window](#) on page 782

Importing ADM Files

PROCEDURE

1. Select **File > Import > ADM**.
2. In the file dialog that opens, navigate to the ADM file you want to import.
3. Click **Open**.
4. In the **Import Options** dialog, select the channels of the ADM file that you want to import.
5. Click **OK**.

RESULT

- The selected channels of the ADM file are imported to your active project.
- The channels of audioObject elements are split into mono audio files, inheriting the name of the channels.
- Folder tracks are created, representing the hierarchical structure of the original ADM file. They contain the associated audioContent, audioObject, and the mono audio tracks deriving from them.
- Object audio channels are connected to **VST MultiPanner**.
- Bed audio channels are not connected to a panner.

AFTER COMPLETING THIS TASK

- You can edit the ADM structure in the **ADM Authoring for Dolby Atmos** window.
- You can mix the ADM in Nuendo, using **VST MultiPanner** for panning, and the **Renderer for Dolby Atmos** or the external Dolby Atmos Renderer for monitoring.

RELATED LINKS

[ADM Files](#) on page 1304

[ADM Authoring for Dolby Atmos Window](#) on page 782

[Object Mixes with VST MultiPanner](#) on page 787

[Renderer for Dolby Atmos Plug-in Panel](#) on page 775

[External Dolby Atmos Renderer Setup Dialog](#) on page 780

Exporting ADM Files

The **ADM Authoring for Dolby Atmos** window allows you to export 3D audio mixes containing object audio and channel-based beds with all metadata required for re-rendering on a Dolby Atmos playback system as ADM BWF (Broadcast Wave Format) files.

PREREQUISITE

- You have set up a complete and valid ADM project, for example a Dolby Atmos mix, containing bed and object audio.
- In the **ADM Authoring for Dolby Atmos** window, you have selected a renderer. If you use an external renderer, you have connected all necessary Nuendo output and renderer input ports.

PROCEDURE

1. Select **Project > ADM Authoring for Dolby Atmos**.
 2. Click **Export ADM File**.
 3. In the file dialog, specify a name and location.
 4. Click **Save**.
-

RESULT

Your ADM is exported as ADM BWF file according to your current settings at the specified location.

RELATED LINKS

[Authoring and Mixing for Dolby Atmos](#) on page 770

[ADM Authoring for Dolby Atmos Window](#) on page 782

MXF Files

Nuendo supports audio files in the MXF (Material Exchange Format) container format (OP1a for import only, and OP-Atom).

Project data from non-linear video editing systems is often delivered as AAF files referencing MXF audio.

On importing AAF files, MXF media from the AAF project is automatically added as audio events to the project. However, you can also import individual MXF media (clips) independently from an AAF file.

Importing MXF Files

PROCEDURE

1. Select **File > Import > MXF**.
 2. In the file dialog, locate and select the MXF file and click **Open**.
 3. Optional: If a project is open, choose whether you want to create a new project.
If you select **No**, the MXF file is imported into the current project.
-

RESULT

The MXF file is imported to your project. For multi-channel audio, a single multi-channel track is created. The video track of the MXF file is ignored.

AFTER COMPLETING THIS TASK

- Nuendo projects reference media files inside an MXF file using relative paths. Changing the relative location of the MXF file and the Nuendo project file (.npr) causes lost references. Therefore, we recommend that you convert the MXF files to WAV. To consolidate the media files in the project folder, select **Media > Convert Files**.
- If you have imported a multitrack MXF file in OP1a standard, you can split the created multi-channel track to mono tracks using the **Convert Tracks** function.

RELATED LINKS

[Splitting Multi-Channel Audio Tracks](#) on page 179

ReWire

ReWire is a special protocol for streaming audio between two computer applications.

Developed by Propellerhead Software and Steinberg, ReWire provides the following possibilities and features:

- Realtime streaming of up to 256 separate audio channels, at full bandwidth, from the synthesizer application into the mixer application.
In this case, the mixer application is Nuendo. An example of a synthesizer application is Propellerhead Software's Reason.
- Automatic, sample-accurate synchronization between the audio in the two programs.
- The possibility to have the two programs share one audio card and take advantage of multiple outputs on that card.
- Linked transport controls that allow you to play, rewind, etc., either from Nuendo or from the synthesizer application (provided it has some kind of transport functionality).
- Automatic audio mixing functions of separate channels as required.
In the case of Reason, for example, this allows you to have separate channels for the different devices.
- Additionally, ReWire offers the possibility to route MIDI tracks in Nuendo to the other application for full MIDI control.
For each ReWire-compatible device, a number of extra MIDI outputs is made available in Nuendo. In the case of Reason, this allows you to route different MIDI tracks in Nuendo to different devices in Reason, with Nuendo serving as the main MIDI sequencer.
- The overall load on your system is reduced significantly, compared to when using the programs together in the conventional way.

Enabling ReWire Applications

To use the available ReWire applications on your computer in your project, you must enable them in the **ReWire Setup** dialog.

IMPORTANT

- Enabling ReWire applications may have an impact on performance and stability of Nuendo, even if the ReWire connection is not used. We therefore recommend to enable only ReWire applications that you want to use in your project.
- Disabling a ReWire application removes the corresponding ReWire channels from your project. All associated automation or parameter settings are lost.

PROCEDURE

1. Select **Studio > ReWire > ReWire Setup**.
2. Activate the ReWire applications that you want to use.
3. Click **Apply**.

RESULT

The enabled ReWire applications become available in the **ReWire** submenu.

AFTER COMPLETING THIS TASK

You can activate ReWire channels in the ReWire panel of the application.

RELATED LINKS

[Activating ReWire channels](#) on page 1310

Launching and quitting

When using ReWire, the order in which you launch and quit the two programs is very important.

Launching for normal use with ReWire

When you use Nuendo with ReWire, the order in which you launch the two programs is very important.

PROCEDURE

1. First launch Nuendo.
2. Enable one or several ReWire channels in the ReWire Device dialog for the other application.
3. Launch the other application.

It may take slightly longer for the application to start when you are using ReWire.

RELATED LINKS

[Activating ReWire channels](#) on page 1310

Quitting a ReWire session

When you are finished using ReWire, you must quit the applications in a specific order.

PROCEDURE

1. First quit the synthesizer application.
 2. Then quit Nuendo.
-

Launching both programs without using ReWire

It is possible to run Nuendo and the synthesizer application simultaneously on the same computer, without using ReWire, even though use cases for this might be rare.

PROCEDURE

1. First launch the synthesizer application.
2. Then launch Nuendo.

NOTE

Please note that the two programs now compete for system resources such as audio cards, just as when running with other, non-ReWire audio applications.

Activating ReWire channels

ReWire supports streaming of up to 256 separate audio channels. The exact number of available ReWire channels depends on the synthesizer application. The ReWire device panels in Nuendo allow you to activate the channels that you want to use.

PREREQUISITE

You have enabled the ReWire application that you want to use in the **ReWire Setup** dialog.

PROCEDURE

1. Select **Studio > ReWire**, and select the ReWire application that you want to use.
The corresponding **ReWire** panel appears. This consists of a number of rows, one for each available ReWire channel.
 2. Click the power buttons to the left to activate/deactivate channels.
The buttons light up to indicate activated channels.
 3. Optional: Double-click the labels in the right column, and type in another name.
These labels are used in your project to identify the ReWire channels.
-

RESULT

The activated ReWire channels are added to the project.

NOTE

- The more ReWire channels you activate, the more processing power is required.
 - For information about exactly what signal is carried on each channel, refer to the documentation of the synthesizer application.
-

IMPORTANT

Deactivating ReWire channels in the **ReWire** panel removes the channels from your project. All associated automation or parameter settings are lost.

RELATED LINKS

[Enabling ReWire Applications](#) on page 1308

Using the transport and tempo controls

IMPORTANT

This is only relevant if the synthesizer application has a built-in sequencer or similar application.

Basic transport controls

When you run ReWire, the transports in the two programs are completely linked. It does not matter in which program you play, stop, fast forward or rewind. However, recording (if applicable) is still completely separate in the two applications.

Loop settings

If there is a loop or cycle facility in the synthesizer application, that loop will be completely linked to the cycle in Nuendo. This means that you can move the start and end point for the loop or turn the loop on or off in either program, and this will be reflected in the other.

Tempo settings

As far as tempo goes, Nuendo is always the master. This means that both programs will run in the tempo set in Nuendo.

However, if you are not using the tempo track in Nuendo, you can adjust the tempo in either program, and this will immediately be reflected in the other.

IMPORTANT

If you are using the tempo track in Nuendo and the **Activate Tempo Track** button is activated on the **Transport** panel, you should not adjust the tempo in the synthesizer application, since a tempo request from ReWire automatically deactivates the tempo track in Nuendo.

How the ReWire channels are handled

When you activate ReWire channels in the ReWire device panels, they will become available as channels in the **MixConsole**.

The ReWire channels have the following properties:

- ReWire channels may be any combination of mono and stereo, depending on the synthesizer application.
- ReWire channels have the same functionality as regular audio channels.
This means you can set volume and pan, add EQ, insert effects and sends, and route the channel outputs to groups or busses. However, ReWire channels have no monitor buttons.
- All channel settings can be automated using the **Read/Write** buttons.
When you write automation, channel automation tracks will automatically appear in the **Project** window. This allows you to view and edit the automation graphically, just as with VST instrument channels, etc.
- You can mix down the audio from ReWire channels to a file on your hard disk with the **Export Audio Mixdown** function.
You can export the output bus to which you have routed the ReWire channels. You can also export individual ReWire channels directly – “rendering” each ReWire channel to a separate audio file.

RELATED LINKS

[Mixing Down to Audio Files](#) on page 1171

Routing MIDI via ReWire

When using Nuendo with a ReWire-compatible application, additional MIDI outputs will automatically appear on the **Output Routing** pop-up menus for MIDI tracks. This allows you to play the synthesizer application via MIDI from Nuendo, using it as one or several separate MIDI sound sources.



- The number and configuration of MIDI outputs depends on the synthesizer application.

Considerations and limitations

Sample rates

Synthesizer applications may be limited to audio playback in certain sample rates. If Nuendo is set to a sample rate other than those, the synthesizer application will play back at the wrong pitch. Consult the documentation of the synthesizer application for details.

ASIO drivers

ReWire works well with ASIO drivers. By using the Nuendo bus system, you can route sounds from the synthesizer application to various outputs on an ASIO compatible audio card.

Key Commands

Key commands are assigned to most main menus and functions in Nuendo. They are stored as **Preferences** that are used for all your projects.

You can view and add key commands in the **Key Commands** dialog. Key command assignments are also shown in the tooltips.



Tooltips that show an exclamation mark at the end have no key command assigned yet.

In addition, you can save complete or partial key commands settings as a “key commands file”, which is stored separately and can be imported into any project. This way you can quickly and easily recall customized settings when moving projects between different computers, for example. The settings are saved in an XML file on the hard disk.

RELATED LINKS

[Saving Complete Key Commands Settings as Presets](#) on page 1317

Key Commands Dialog

The **Key Commands** dialog allows you to view and edit key commands for the main menus and functions in Nuendo.

- To open the **Key Commands** dialog, select **Edit > Key Commands**.

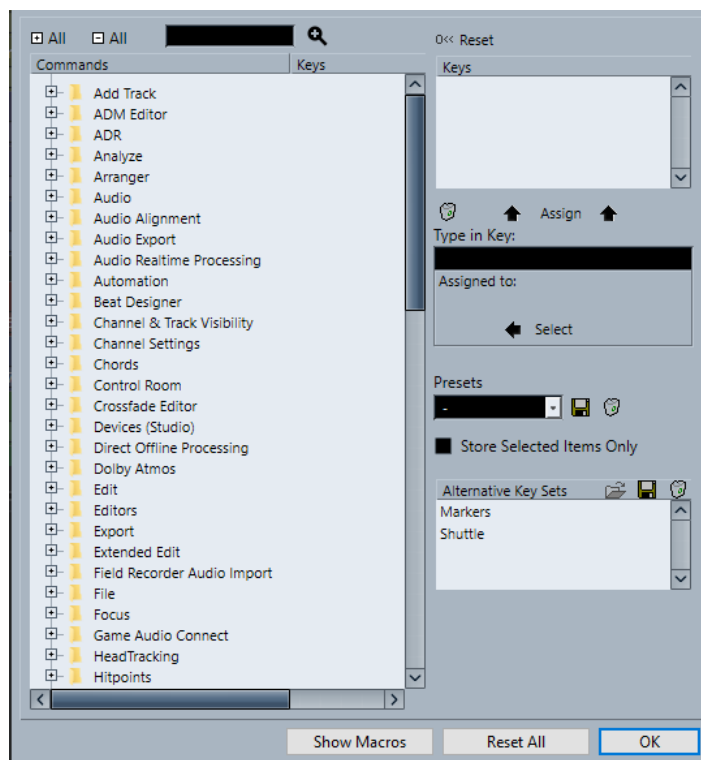

The following options are available:

+ All

Expands all folders.

- All

Reduces all folders.

Search

Allows you to search for Nuendo functions. This is useful if you want to know which key command is assigned to a specific function.

Reset Current Key Command

Allows you to reset the selected key command back to the default setting.

Commands list

Shows the Nuendo functions for that you can assign key commands arranged in category folders.

Keys

This is where the assigned key command is shown for the function that is selected in the **Commands** list.

Delete Selected Key Command

Removes the key command assignment from the function that is selected in the **Commands** list.

Assign Key

Assigns the key from the **Type in Key** value field to the function that is selected in the **Commands** list.

Type in Key

This is where you can enter a key that is assigned to a function that is selected in the **Commands** list.

Assigned to:

Shows the function that the key in the **Type in Key** value field is assigned to. Click the **Select** button, to select this function in the **Commands** list.

Select Preset

Opens a menu with the stored key commands presets.

Store

Opens a dialog that allows you to store a key commands preset.

Delete

Deletes the selected key commands preset.

Show Macros

Opens the **Macros** section that allows you to set up a combination of several functions or commands to be performed in one go as a macro.

Reset All

Resets all key commands to their default settings.

RELATED LINKS

[Macros Section](#) on page 1315

[Assigning Key Commands](#) on page 1316

[Searching for Key Commands](#) on page 1316

[Resetting Key Commands](#) on page 1319

[Removing Key Commands](#) on page 1317

[Loading Key Command Presets](#) on page 1318

[Setting up Macros](#) on page 1317

Macros Section

The **Macros** section allows you to set up a combination of several functions or commands that you want to be performed in one go.

- To open the **Macros** section, select **Edit > Key Commands**, and click **Show Macros**.

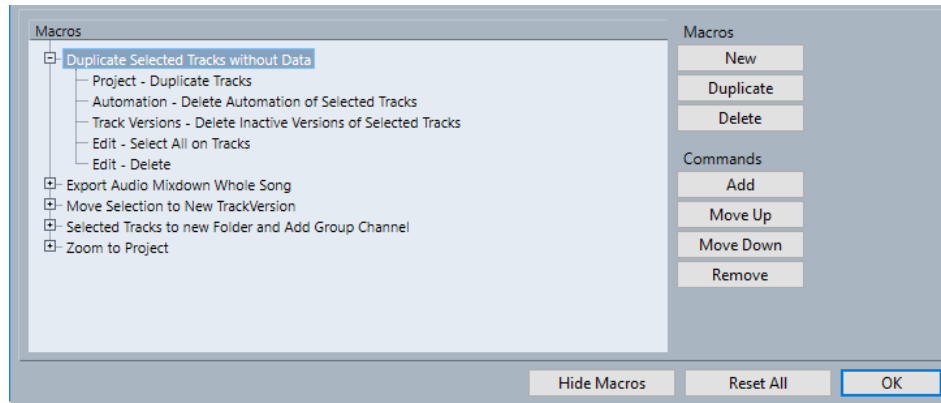

Macros list

Shows all added macros.

New

Allows you to add a new macro.

Duplicate

Allows you to duplicate the selected macro.

Delete

Deletes the selected item from the **Macros** list.

Add

Allows you to add the function that is selected in the **Commands** list to the macro.

Move Up

Allows you to change the position of the selected command by moving it up the list.

Move Down

Allows you to change the position of the selected command by moving it down the list.

Remove

Allows you to remove the command that is selected in the **Commands** list in the upper part of the dialog.

Hide Macros

Hides the **Macros** section.

Reset All

Resets all key commands to their default settings.

RELATED LINKS

[Key Commands Dialog](#) on page 1313

[Setting up Macros](#) on page 1317

Assigning Key Commands

You can add key commands in the **Key Commands** dialog.

PROCEDURE

1. Select **Edit > Key Commands**.
2. Do one of the following:
 - In the **Commands** list, click the plus sign to open a category folder, and select the function to which you want to assign a key command.
 - In the search field, enter the name of the function to which you want to assign a key command.

Assigned key commands are shown in the **Keys** column as well as in the **Keys** list to the right.



3. Click the **Type in Key** field and press the keys you want to use as a key command. You can press individual keys or a combination of one or several modifier keys (**Ctrl/Cmd**, **Alt/Opt**, **Shift**) plus any key.
4. Click **Assign**. The key command is shown in the **Keys** section.
5. Click **OK**.

NOTE

You can set up several different key commands for the same function. Adding a key command to a function that already has another key command does not replace the key command previously defined for the function.

Searching for Key Commands

You can search for Nuendo functions in the **Key Commands** dialog. This is useful if you want to know which key command is assigned to a specific function.

PROCEDURE

1. Select **Edit > Key Commands**.
 2. In the search field, enter the name of the function for which you want to know the key command.
 3. Click **Start/Continue Search**.
-

RESULT

The first matching command is selected and displayed in the **Commands** list. The **Keys** column and the **Keys** list show the assigned key commands, if any.

Removing Key Commands

PROCEDURE

1. Select **Edit > Key Commands**.
 2. In the **Commands** list, click the plus sign to open a category folder, and select the function for which you want to remove a key command.
 3. Select the key command in the **Keys** list and click **Delete selected key command**.
 4. Click **Remove** to remove the selected key command.
 5. Click **OK**.
-

Setting up Macros

You can set up a combination of several functions or commands to be performed in one go as a macro.

PROCEDURE

1. Select **Edit > Key Commands**.
2. Click **Show Macros**.
3. Click **New**.
4. Enter a name for the macro and press **Return** to confirm it.
5. In the **Commands** list, select the first command you want to include in the macro.
6. Click **Add**.
7. Select the next command and click **Add**.

NOTE

Commands are added after the selected command in the **Macros** list. This allows you to specify the order of commands of a macro.

8. Click **OK**.
-

RESULT

All macros are available in the **Macros** submenu of the **Edit** menu.

AFTER COMPLETING THIS TASK

You can also assign key commands to a macro. Macros are shown in the **Commands** list in the **Macro** category folder.

RELATED LINKS

[Macros Section](#) on page 1315

Saving Complete Key Commands Settings as Presets

You can save key command settings as presets.

PREREQUISITE

You have set up the key commands to your liking.

PROCEDURE

1. In the **Key Commands** dialog, deactivate **Store Selected Items Only**.

2. In the **Presets** section, click **Save**.
 3. Enter a name for the preset and click **OK**.
-

RESULT

Your key commands settings are now available as a preset on the **Presets** pop-up menu.

Saving Partial Key Commands Settings

You can save partial key command settings as presets.

PREREQUISITE

You have set up the key commands to your liking.

PROCEDURE

1. In the **Key Commands** dialog, activate **Store Selected Items Only**.
2. Click in the **Store** column for the individual key commands items or for category folders you want to save.

Commands	Keys	Store
⊕ Add Track		
⊖ ADR		
ADR Status Indicator On/Off		
Free Run Mode On/Off		
Guide Track for Control Room On/Off		
Guide Track for Cue 1 On/Off		
Play back the recorded take for review		
Play back the selected take for rehearsal		
Pre-roll On/Off		
Record the selected take		
⊕ Analyze		
⊕ Arranger		
⊕ Audio		

3. In the **Presets** section, click **Save**.
 4. Enter a name for the preset and click **OK**.
-

RESULT

Your key commands settings are now available as a preset on the **Presets** pop-up menu.

NOTE

When you apply a saved partial preset you only change these specific settings. All other key commands settings remain unchanged.

Loading Key Command Presets

You can load key commands presets.

PROCEDURE

- In the **Presets** section, open the pop-up menu and select the preset.
-

RESULT

The key command preset replaces the current key command settings and macros.

Resetting Key Commands

PROCEDURE

1. Select **Edit > Key Commands**.
2. Do one of the following:

- In the **Commands** list, select the key command that you want to restore and click **Reset**.

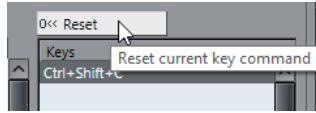

- Click **Reset All**.

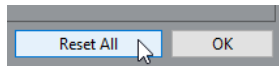

RESULT

The key commands are reset.

IMPORTANT

Any changes made to the default key commands are lost. If you want to be able to revert to these settings again, make sure to save them first.

Key Sets

Nuendo comes with default key sets. Additionally, you can set up and save alternative key sets.

The following key sets are available by default:

- **Markers** is the default set of key commands.
- **Shuttle** contains key commands settings for all **Shuttle** controls of the **Transport** panel.

You can switch between the different key commands settings. You can edit and save them as additional key sets for your specific needs.

Saving Alternative Key Sets

PROCEDURE

1. Select **File > Key Commands**.
2. Set up the key commands and macros the way you want them.
3. Do one of the following:
 - Activate **Store Selected Items Only** to save selected settings only.
 - Deactivate **Store Selected Items Only** to save the complete settings.
4. In the **Alternative Key Sets** section, click **Store Alternative Set**.

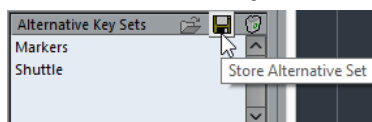

5. Enter a name for the key set.
 6. Click **OK**.
-

RESULT

The saved key set appears in the list of alternative key sets.

Editing Alternative Key Sets

PROCEDURE

1. In the **Alternative Key Sets** section, select the key set that you want to edit.
 2. Click **Load Alternative Set** to load and activate the key set.
 3. Make the desired changes.
 4. Click **Store Alternative Set**.
-

RESULT

The key set is saved with the updated settings.

Removing Alternative Key Sets

PROCEDURE

1. In the **Alternative Key Sets** section, select the key set that you want to remove.
 2. Click **Delete Alternative Set**.
 3. In the dialog that opens, click **Remove**.
-

RESULT

The key set is removed.

Switching Between Alternative Key Sets

You can switch between different key sets in the **Project** window.

PROCEDURE

- In the **Project** window, press **Ctrl/Cmd - F5**.
This is the default key command for **Toggle Alternate Key Commands** that is located in the **File** subfolder in the **Key Commands** dialog.
-

RESULT

The next available alternative key set is activated and its name is briefly shown on top of the **Project** window.

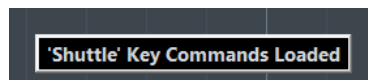

RELATED LINKS

[Assigning Key Commands](#) on page 1316

Default Key Commands

The default key commands are arranged in categories.

NOTE

When the **On-Screen Keyboard** is displayed, the usual key commands are blocked because they are reserved for the **On-Screen Keyboard**. The only exceptions are: **Ctrl/Cmd - S** (Save), **Num *** (Start/Stop Record), **Space** (Start/Stop Playback), **Num 1** (Jump to Left Locator), **Delete** or **Backspace** (Delete), **Num /** (Cycle on/off), **F2** (Show/Hide Transport panel), and **Alt/Opt - K** (Show/Hide On-Screen Keyboard).

- Note that it is possible to switch key commands for menu items and other functions on and off.

RELATED LINKS

[Disabling Key Commands](#) on page 1334

Add Track Category

Option	Key command
Add Track	T

Audio Category

Option	Key command
Adjust Fades to Range	A
Auto-Grid	Shift - Q
Crossfade	X

Automation Category

Option	Key command
Open Panel	F6
Redo Pass	Ctrl/Cmd - Alt/Opt - Shift - Z
Read Automation for All Tracks On/Off	Alt/Opt - R
Write Automation for All Tracks On/Off	Alt/Opt - W
Undo Pass	Ctrl/Cmd - Alt/Opt - Z

Chords Category

Option	Key command
Show/Hide Chord Pads	Ctrl/Cmd - Shift - C

Devices (Studio) Category

Option	Key command
Audio Connections	F4
Audio Performance	F12
MixConsole	F3
MixConsole in Project Window	Alt/Opt - F3
On-Screen Keyboard	Alt/Opt - K
Video Player	Alt/Opt - F3
VST Instruments	Alt/Opt - K

Direct Offline Processing Category

Option	Key command
Direct Offline Processing	F7

Edit Category

Option	Key command
Activate/Deactivate Focused Object	Alt/Opt - A
Auto-Scroll On/Off	F
Copy	Ctrl/Cmd - C
Cut	Ctrl/Cmd - X
Cut Time	Ctrl/Cmd - Shift - X

Option	Key command
Delete	Delete or Backspace
Delete Time	Shift - Backspace
Duplicate	Ctrl/Cmd - D
Expand/Reduce	Alt/Opt - E
Find Track/Channel	Ctrl/Cmd - F
Group	Ctrl/Cmd - G
Group Editing on Selected Tracks On/Off	K
Insert Silence	Ctrl/Cmd - Shift - E
Invert	Alt/Opt - F
Invert Selection	Ctrl/Cmd - Alt/Opt - I
Left Selection Side to Cursor	E
Lock	Ctrl/Cmd - Shift - L
Move to Cursor	Ctrl/Cmd - L
Move to Front (Uncover)	U
Mute	M
Mute Events	Shift - M
Mute/Unmute Objects	Alt/Opt - M
Open	Ctrl/Cmd - E
Paste	Ctrl/Cmd - V
Paste at Origin	Alt/Opt - V
Paste Relative to Cursor	Shift - V
Paste Time	Ctrl/Cmd - Shift - V
Primary Parameter: Decrease	Ctrl/Cmd - Shift - Down Arrow
Primary Parameter: Increase	Ctrl/Cmd - Shift - Up Arrow

Option	Key command
Record Enable	R
Redo	Ctrl/Cmd - Shift - Z
Repeat	Ctrl/Cmd - K
Right Selection Side to Cursor	D
Secondary Parameter: Decrease	Ctrl/Cmd - Shift - Left Arrow
Secondary Parameter: Increase	Ctrl/Cmd - Shift - Right Arrow
Select All	Ctrl/Cmd - A
Select None	Ctrl/Cmd - Shift - A
Snap On/Off	J
Solo	S
Split At Cursor	Alt/Opt - X
Split Range	Shift - X
Stationary Cursor	Alt/Opt - C
Undo	Ctrl/Cmd - Z
Ungroup	Ctrl/Cmd - U
Unlock	Ctrl/Cmd - Shift - U
Unmute Events	Shift - U
Write	W

Editors Category

Option	Key command
Edit In-Place	Ctrl/Cmd - Shift - I
Open Score Editor	Ctrl/Cmd - R
Open/Close Editor	Return

File Category

Option	Key command
Close	Ctrl/Cmd - W
New	Ctrl/Cmd - N
Open	Ctrl/Cmd - O
Quit	Ctrl/Cmd - Q
Save	Ctrl/Cmd - S
Save As	Ctrl/Cmd - Shift - S
Save New Version	Ctrl/Cmd - Alt/Opt - S
Toggle Alternate Key Commands	# or Ctrl/Cmd - F5

Media Category

Option	Key command
Open MediaBay	F5
Open/Close Attribute Inspector	Ctrl - Alt/Opt - Num 6
Open/Close Favorites	Ctrl - Alt/Opt - Num 8
Open/Close File Browser	Ctrl - Alt/Opt - Num 4
Open/Close Filters	Ctrl - Alt/Opt - Num 5
Open/Close Previewer	Ctrl - Alt/Opt - Num 2
Preview Cycle On/Off	Shift - Num /
Preview Start	Shift - Enter
Preview Stop	Shift - Num 0
Search MediaBay	Shift - F5

MIDI Category

Option	Key command
Show/Hide Controller Lanes	Alt/Opt - L

MixConsole History Category

Option	Key command
Undo MixConsole Step	Alt/Opt - Z
Redo MixConsole Step	Alt/Opt - Shift - Z

Navigate Category

Option	Key command
Add Down: Expand/Undo selection in the Project window to the bottom/Move selected event in the Key Editor down 1 octave	Shift - Down Arrow
Add Left: Expand/Undo selection in the Project window/Key Editor to the left	Shift - Left Arrow
Add Right: Expand/Undo selection in the Project window/Key Editor to the right	Shift - Right Arrow
Add Up: Expand/Undo selection in the Project window to the top/Move selected event in the Key Editor up one octave	Shift - Up Arrow
Bottom: Select bottom track in the track list	End
Down: Select next in the Project window/Move selected event in the Key Editor one semitone down	Down Arrow

Option	Key command
Left: Select previous in the Project window/Key Editor	Left Arrow
Right: Select next in the Project window/Key Editor	Right Arrow
Toggle Selection	Ctrl/Cmd - Space
Top: Select top track in the track list	Home
Up: Select next in the Project window/ Move selected event in the Key Editor one semitone up	Up Arrow

Nudge Category

Option	Key command
End Left	Alt/Opt - Shift - Left Arrow
End Right	Alt/Opt - Shift - Right Arrow
Left	Ctrl/Cmd - Left Arrow
Right	Ctrl/Cmd - Right Arrow
Start Left	Alt/Opt - Left Arrow
Start Right	Alt/Opt - Right Arrow

Project Category

Option	Key command
Colors	Alt/Opt - Shift - S
Open Browser	Ctrl/Cmd - B
Open Markers	Ctrl/Cmd - M

Option	Key command
Open Pool	Ctrl/Cmd - P
Open Tempo Track	Ctrl/Cmd - T
Remove Selected Tracks	Shift - Delete
Set Track/Event Color	Alt/Opt - Shift - C
Setup	Shift - S

Quantize Category

Option	Key command
Quantize	Q

Set Insert Length Category

Option	Key command
1/1	Alt/Opt - 1
1/2	Alt/Opt - 2
1/4	Alt/Opt - 3
1/8	Alt/Opt - 4
1/16	Alt/Opt - 5
1/32	Alt/Opt - 6
1/64	Alt/Opt - 7
1/128	Alt/Opt - 8
Toggle Dotted	Alt/Opt - .
Toggle Triplet	Alt/Opt - ,

Tool Category

Option	Key command
Combine Selection Tools On/Off	Alt/Opt - Shift - 1
Draw Tool	8
Drumstick Tool	0
Erase Tool	5
Glue Tool	4
Mute Tool	7
Next Tool	F10
Object Selection Tool	1
Play Tool	9
Previous Tool	F9
Range Selection Tool	2
Split Tool	3
Zoom Tool	6

Track Versions Category

Option	Key command
Duplicate Version	Ctrl/Cmd - Shift - D
New Version	Ctrl/Cmd - Shift - N
Next Version	Ctrl/Cmd - Shift - H
Previous Version	Ctrl/Cmd - Shift - G

Transport Category

Option	Key command
Activate External Sync	Alt/Opt - Shift - T
Activate Metronome	C
Activate Punch In	I
Activate Punch Out	O
Cycle	Num /
Enter Left Locator	Shift - L
Enter Locator Range Duration	Shift - D
Enter Project Cursor Position	Shift - P
Enter Punch In Position	Shift - I
Enter Punch Out Position	Shift - O
Enter Right Locator	Shift - R
Enter Tempo	Shift - T
Enter Time Signature	Shift - C
Exchange Time Formats	.
Fast Forward	Shift - Num +
Fast Rewind	Shift - Num -
Forward	Num +
Go to Left Locator	Num 1
Go to Project Start	Num . or Num , or Num ;
Go to Right Locator	Num 2
Insert Marker (Windows only)	Insert
Locate Next Event	N
Locate Next Hitpoint	Alt/Opt - N

Option	Key command
Locate Next Marker	Shift - N
Locate Previous Event	B
Locate Previous Hitpoint	Alt/Opt - B
Locate Previous Marker	Shift - B
Locate Selection Start	L
Locators to Selection	P
Loop Selection	Alt/Opt - P
MIDI Retrospective Record: Insert from All MIDI Inputs	Shift - Num - -*
Nudge Cursor Left	Ctrl/Cmd - Num -
Nudge Cursor Right	Ctrl/Cmd - Num +
Panel (Transport panel)	F2
Play Selection Range	Alt/Opt - Space
Recall Cycle Marker 1 to 9	Shift - Num 1 to Num 9
Record	Num *
Rewind	Num -
Set Left Locator to Project Cursor Position	Ctrl/Cmd - Num 1
Set Marker 1	Ctrl/Cmd - 1
Set Marker 2	Ctrl/Cmd - 2
Set Marker 3 to 9	Ctrl/Cmd - Num 3 to Num 9 or Ctrl/Cmd - 3 to 9
Set Right Locator to Project Cursor Position	Ctrl/Cmd - Num 2
Start	Enter
Start/Stop	Space
Stop	Num 0

Option	Key command
To Marker 1	Shift - 1
To Marker 2	Shift - 2
To Marker 3 to 9	Num 3 to Num 9 or Shift - 3 to 9

Window Zones Category

Option	Key command
Show/Hide Left Zone	Ctrl/Cmd - Alt/Opt - L ; Alt/Opt - I
Show/Hide Right Zone	Ctrl/Cmd - Alt/Opt - R
Show/Hide Upper Zone	Ctrl/Cmd - Alt/Opt - U
Show/Hide Lower Zone	Ctrl/Cmd - Alt/Opt - E or Ctrl/Cmd - Alt/Opt - B
Show/Hide Transport Bar	Ctrl/Cmd - Alt/Opt - T
Show Previous Tab	Ctrl/Cmd - Alt/Opt - Left Arrow
Show Next Tab	Ctrl/Cmd - Alt/Opt - Right Arrow
Show Previous Page	Ctrl/Cmd - Alt/Opt - Up Arrow or Page Up
Show Next Page	Ctrl/Cmd - Alt/Opt - Down Arrow or Page Down
Show/Hide Info Line	Ctrl/Cmd - I
Show/Hide Overview	Alt/Opt - O

Workspaces Category

Option	Key command
New	Ctrl/Cmd - Num 0
No Workspace	Alt/Opt - Num 0
Update Workspace	Alt/Opt - U
Workspace 1-9	Alt/Opt - Num 1 - Num 9

Option	Key command
Workspace X	Ctrl/Cmd - Alt/Opt - Num 0

Zoom Category

Option	Key command
Zoom Full	Shift - F
Zoom In	H
Zoom In On Waveform Vertically	Alt/Opt - H
Zoom In Tracks	Ctrl/Cmd - Down Arrow
Zoom In Vertically	Shift - H
Zoom Out	G
Zoom Out Of Waveform Vertically	Alt/Opt - G
Zoom Out Tracks	Ctrl/Cmd - Up Arrow
Zoom Out Vertically	Shift - G
Zoom to Event	Shift - E
Zoom to Selection	Alt/Opt - S
Zoom Tracks Exclusive	Z

Setting up Tool Modifier Keys

You can set up tool modifier keys that allow you to get an alternative function when using a tool.

PROCEDURE

1. In the **Preferences** dialog, select **Editing > Tool Modifiers**.

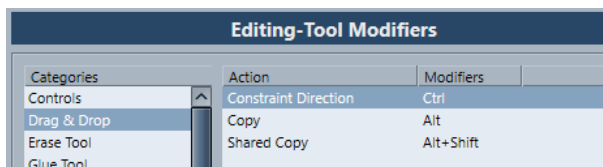

2. Select an option in the **Categories** list, and locate the action for which you want to edit the modifier key.
3. In the **Action** list, select the action.
4. Hold down the desired modifier keys and click **Assign**.

NOTE

If the modifier keys you pressed are already assigned to another tool, you will be asked whether you want to overwrite them. If you do, this leaves the other tool without any modifier keys assigned.

5. Click **OK**.
-

RESULT

The modifier keys for the action are replaced.

Disabling Key Commands

You can disable key commands.

PROCEDURE

1. In the **Preferences** dialog, select the **Configuration** page.

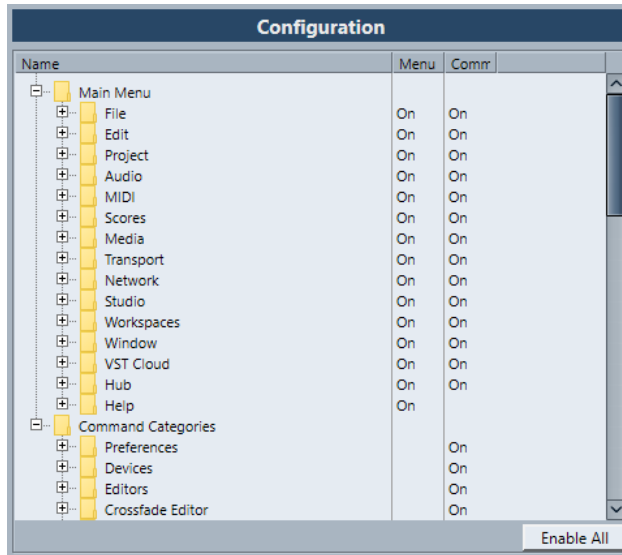

2. Navigate to the item for which you want to disable the assigned key command, and select it.
 3. Click the **Command** column beside the item to set the status to **Off**.
 4. Click **OK**.
-

RESULT

Any key command assigned to that menu item or function is now disabled.

NOTE

If you disable an entire subfolder, all the items or functions it contains are automatically disabled. If this is not what you want, you can reset separate items in the subfolder.

Customizing

In Nuendo you can organize windows and dialogs in workspaces, set up the appearance of specific elements, configure the main menu items, and save program settings as profiles.

RELATED LINKS

[Workspaces](#) on page 1335

[Setup Options](#) on page 1338

[Configuring the Main Menu Items](#) on page 1340

[Profiles](#) on page 1342

Workspaces

Workspaces in Nuendo allow you to organize windows and specific dialogs for your common work routines.

A workspace saves the size, position, and layout or setting of important windows and dialogs, such as the **Project** window, **MixConsole**, or **Transport** panel. You can define several workspaces. This allows you to quickly switch between different working modes, either through the **Workspaces** menu or by using key commands.

You can define different workspace types that are either available for all projects on your computer or specific for one project. However, when you open a project, its last saved view is opened by default. A view is the window layout and setting that you defined for your project. The last saved view can either be a workspace view or a view that you saved without having any workspace selected. When you open an external project, the last used view on your computer is used by default.

The **Workspaces Organizer** and the **Workspaces** menu allow you to create and modify workspaces.

NOTE

- You can also work without workspaces. In this case, the last used view of the former project will be used when you create a new project.
- In the **Preferences** dialog (**General** page), you can select which view is used when you open a project.

RELATED LINKS

[Open Projects in Last Used View](#) on page 1366

Workspace Types

You can create global workspaces or project workspaces.

Global Workspaces

Allows you to save a specific layout of dialogs and windows for all projects on your computer. Global workspaces are indicated by the letter G on your **Workspaces** menu.

Project Workspaces

Allows you to save a specific layout of dialogs and windows that is saved with your current project. This allows you to open your project layout on other computers. Project workspaces are indicated by the letter P on your **Workspaces** menu.

Workspaces for External Projects

You can determine the view of external projects when you open them in Nuendo.

When you open external projects, which are projects that have been created on other computers, the window and dialog settings that you last used on your computer are applied by default. This can either be the last used view that was saved on your computer or one of your specified global workspaces.

If you want to open the original layout setting of a project, you have the following options:

- Select the project's original layout from the project workspaces on the **Workspaces** menu or in the **Workspace Organizer**.
- In the **Preferences** dialog (**General** page), select **Never** from the **Open Projects in Last Used View** menu. This opens all external projects using their original layout. However, this may lead to a modification of your custom layout.

To return to the view that you last saved without any workspace assigned, select **No Workspace** on the **Workspaces** menu.

RELATED LINKS

[Workspaces Organizer](#) on page 1337

[Open Projects in Last Used View](#) on page 1366

Creating Workspaces

To save your current dialog and window setting for future use, you can create a new workspace.

PROCEDURE

1. Select **Workspaces > Add Workspace**.
2. In the **Name** field of the **New Workspace** dialog, enter a workspace name.
3. Select the type of workspace that you want to create.
 - **Global Workspace**
 - **Project Workspace**
4. Click **OK**.

RESULT

The workspace is saved and added to the **Workspaces** menu.

Editing Workspaces

You can modify your created workspaces.

NOTE

To change a global workspace to a project workspace and vice versa, you must save it as a different workspace type.

PROCEDURE

1. On the **Workspaces** menu, select the workspace that you want to modify.
2. Make your changes as required.
3. On the **Workspaces** menu, select one of the following:
 - To update your current workspace, click **Update Workspace**.
 - To save your workspace as a different workspace or workspace type, click **Add Workspace**.

RELATED LINKS

[Creating Workspaces](#) on page 1336

Workspaces Organizer

The **Workspaces Organizer** allows you to manage the existing workspaces.

- To open the **Workspaces Organizer**, click **Workspaces > Organize**.

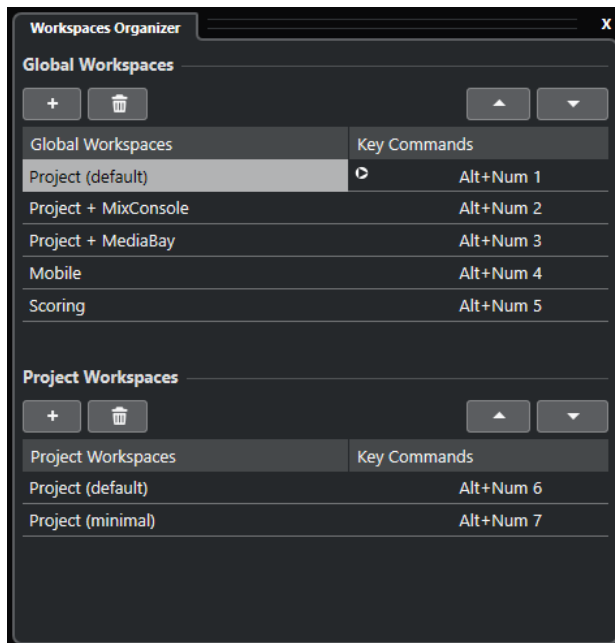

The **Workspaces Organizer** displays the global workspaces and the project workspaces in separate lists. Every workspace has an assigned key command that lets you switch views quickly. Moving or deleting workspaces within the lists changes the key command assignments. When you change the position of a workspace, the key command assignments remain in their original list position. You can click a key command of a selected workspace to open the respective key command assignment in the **Workspace** category of the **Key Commands** dialog.

To organize your workspace, you have the following options:

Add

Allows you to create a new workspace using the **New Workspace** dialog.

Delete

Deletes a selected workspace.

Move Up

Moves up a workspace by one position.

Move Down

Moves down a workspace by one position.

NOTE

- You can also click and drag a workspace to another position within a list.
 - You can move workspaces only within a list. For a global workspace to become a project workspace and vice versa, you must save it as a different type of workspace.
 - To rename a workspace, you can double-click the workspace name.
-

RELATED LINKS

[Workspaces Category](#) on page 1332

Setup Options

You can customize the appearance of the following elements:

- **Transport** panel
- Status line
- Info line
- Toolbars
- **Inspector**

Setup Context Menus

Setup context menus are available for the **Transport** panel, the toolbars, the info lines, or the **Inspector**.

- To open the setup context menus, right-click the corresponding element.

NOTE

You can also click the corresponding setup buttons to open the context menu.

The following general options are available on the setup context menus:

- **Show All** makes all items visible.
- **Reset All** resets the interface to the default setting.
- **Setup** opens the setup dialog.

If presets are available, they can be selected on the lower half of the menu.

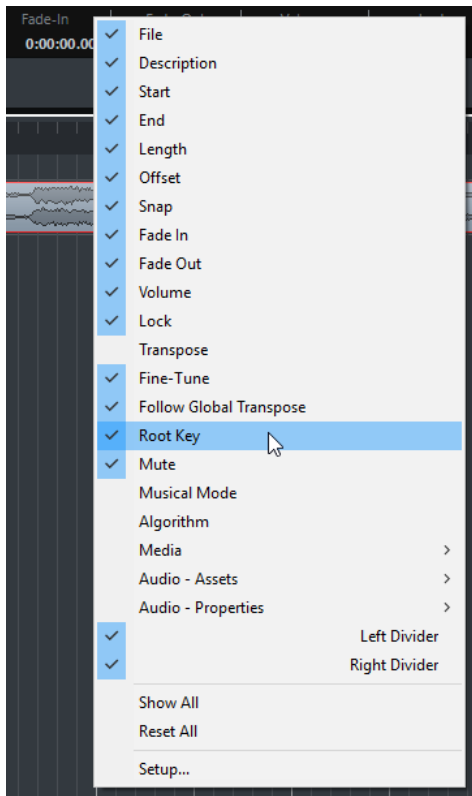

The info line setup context menu

Setup Dialog

The setup dialog allows you to specify which elements are visible/hidden and in what order they are shown. You can save and recall setup presets.

- To open a setup dialog, right-click the element that you want to set up, and select **Setup**.

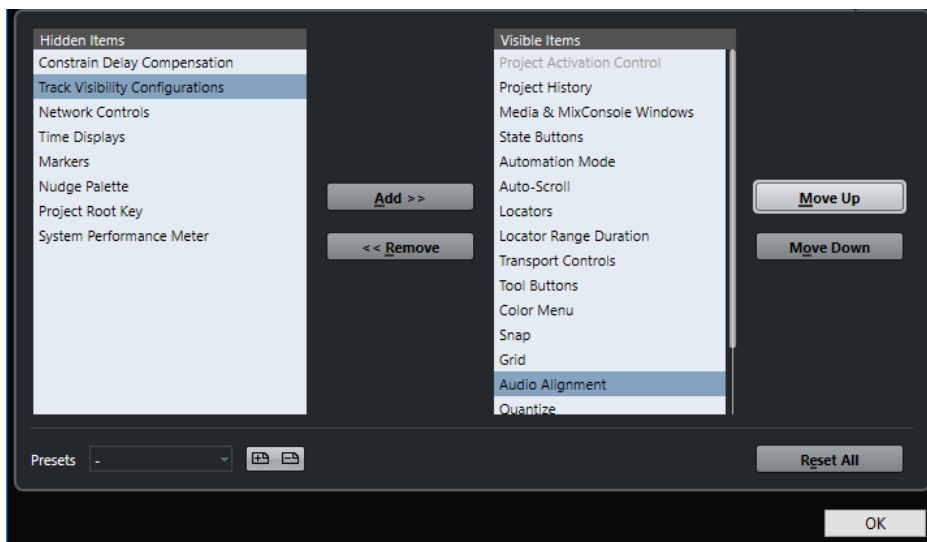

Hidden Items

Lists the elements that are hidden.

Visible Items

Lists the elements that are visible.

Add

Select an item in the list of **Hidden Items**, and click **Add** to make it visible.

Remove

Select an item in the list of **Visible Items**, and click **Remove** to hide it.

Move Up

Select an item in the list of **Visible Items**, and click **Move Up** to reorder the items.

Move Down

Select an item in the list of **Visible Items**, and click **Move Down** to reorder the items.

Store

Allows you to name the current configuration and save it as a preset.

Delete

Remove a selected preset.

Reset All

Reverts to the default configuration.

Configuring the Main Menu Items

You can configure what items are shown on the main menus and submenus, and even hide entire menus. By customizing the menus you can hide items relating to program functions you never use, to customize the program according to your needs.

NOTE

Do not hide menus or menu items unless you are sure that you do not need them.

PROCEDURE

1. In the **Preferences** dialog, select **Configuration**.
 2. Click the + sign for a folder item.
 3. Do one of the following:
 - Activate/Deactivate a menu in the **Menu** column.
 - Activate/Deactivate a key command in the **Command** column.
 4. Click **Apply** to apply the changes or **OK** to apply the changes and exit the dialog.
-

RESULT

The corresponding menu items and key commands are deactivated.

RELATED LINKS

[Configuration Page](#) on page 1341

[Disabling Key Commands](#) on page 1334

Configuration Page

The **Configuration** page in the **Preferences** dialog allows you to customize the menus in Nuendo.

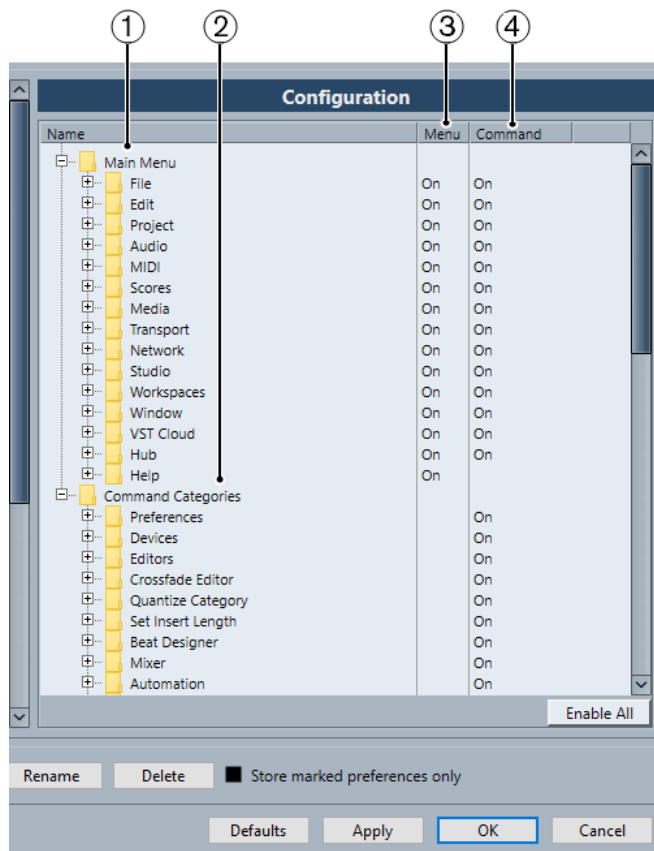

- To open the **Configuration** page, select **Edit > Preferences**, and select **Configuration**.

1 Main Menu

This folder contains folders for all main menus.

2 Command Categories

This folder contains folders for all command categories.

3 Menu

This column allows you to show/hide entire menus from view by setting them to **On** or **Off**.

NOTE

Specific menu items, such as **Save**, **Open**, **Close**, **Undo** on the **File** and **Edit** menus, cannot be hidden.

4 Command

This column allows you to enable/disable the key command for a menu item by setting them to **On** or **Off**.

5 Defaults

Click this button to show all menu items and activate their key commands again.

6 Apply

Allows you to apply the changes without exiting the dialog.

7 OK

Allows you to apply the changes and exit the dialog.

NOTE

You can save menu configurations as preference presets, either separately or together with other **Preferences** dialog settings.

Profiles

Profiles allow you to save customized program settings and preferences. You can switch between profiles, and import and export your profiles for use on different computers.

Profiles are helpful if you work on different computers if you use different settings for different kinds of projects, or in a studio environment where several users work on the same computer. Profiles are saved as files with file name extension **.srf**.

Profiles include the following:

- Preferences
- Toolbar settings for all windows
- Global workspaces
- Track control settings
- Track control presets
- Presets for input and output busses
- File format presets
- Plug-in collections
- Quantize presets
- Crossfade presets
- Key commands

All changes done for these settings are saved in the active profile.

IMPORTANT

The following is not included in profiles: Settings in the **Studio Setup** dialog and in the **Audio Connections** window, presets on the **Control Room** tab of the **Audio Connections** window, track presets, plug-in presets, and project templates.

Profile Manager Dialog

The **Profile Manager** allows you to save customized program settings as profiles and to organize profiles on your computer.

- To open the **Profile Manager**, select **Edit > Profile Manager**.

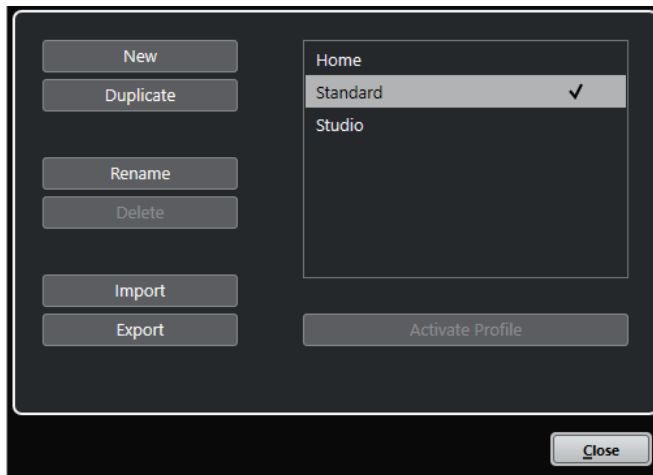

The dialog lists all available profiles. The active profile is indicated by a checkmark.

To organize your profiles, you have the following options:

New

Adds a new profile with factory settings.

Duplicate

Duplicates the selected profile.

Rename

Allows you to rename the selected profile.

Delete

Deletes the selected profile.

Import

Opens a dialog that allows you to import a profile from a file.

Export

Opens a dialog that allows you to export the selected profile to a file.

Activate Profile

Activates the selected profile. You must restart the program for the change to take effect.

Close

Closes the dialog.

Creating Profiles

The **Profile Manager** allows you to create a new profile that is based on the factory default settings.

PROCEDURE

1. Select **Edit > Profile Manager**.
2. In the **Profile Manager**, click **New**.
3. In the **Add New Profile** dialog, enter a profile name and click **OK**.

RESULT

The new profile is added to the list.

AFTER COMPLETING THIS TASK

Activate the new profile to apply the settings.

RELATED LINKS

[Activating Profiles](#) on page 1344

Duplicating Profiles

The **Profile Manager** allows you to create a duplicate of a profile and save it under a different name.

PROCEDURE

1. Select **Edit > Profile Manager**.
 2. In the **Profile Manager**, select the profile that you want to duplicate.
 3. Click **Duplicate**.
 4. In the **Duplicate Profile** dialog, enter a profile name and click **OK**.
-

RESULT

The new profile is added to the list.

Activating Profiles

The **Profile Manager** allows you to switch to another profile. A profile switch requires a restart of Nuendo.

PREREQUISITE

You have saved at least two profiles.

PROCEDURE

1. Select **Edit > Profile Manager**.
 2. In the **Profile Manager**, select the profile that you want to activate.
 3. Click **Activate Profile**.
 4. Click **OK**.
 5. Restart the application.
-

RESULT

The settings of the profile are now active.

Renaming Profiles

The **Profile Manager** allows you to rename profiles.

PROCEDURE

1. Select **Edit > Profile Manager**.
 2. In the **Profile Manager**, select the profile that you want to rename.
 3. Click **Rename**.
 4. In the **Rename Profile** dialog, enter a profile name and click **OK**.
-

Deleting Profiles

The **Profile Manager** allows you to delete profiles.

PREREQUISITE

You have saved at least two profiles.

NOTE

You cannot delete the active profile.

PROCEDURE

1. Select **Edit > Profile Manager**.
 2. In the **Profile Manager**, select the profile that you want to delete.
Select multiple profiles to delete them at once.
 3. Click **Delete**.
 4. Click **OK**.
-

RELATED LINKS

[Activating Profiles](#) on page 1344

Exporting Profiles

The **Profile Manager** allows you to export profiles for use on another computer.

PROCEDURE

1. Select **Edit > Profile Manager**.
 2. In the **Profile Manager**, select the profile that you want to export.
 3. Click **Export**.
 4. In the file dialog, specify the file name and the location.
 5. Click **Save**.
-

RESULT

The exported profile is saved as **.srf** file at the specified location.

AFTER COMPLETING THIS TASK

Import the profile on another computer.

Importing Profiles

The **Profile Manager** allows you to import profiles.

PROCEDURE

1. Select **Edit > Profile Manager**.
 2. In the **Profile Manager**, click **Import**.
 3. In the file dialog, select the profile that you want to import.
 4. Click **Open**.
-

RESULT

The imported profile is added to the list of available profiles.

AFTER COMPLETING THIS TASK

Activate the new profile to apply the settings.

RELATED LINKS

[Activating Profiles](#) on page 1344

Windows Dialog

The **Windows** dialog allows you to manage open windows in Nuendo.

- To open the **Windows** dialog, select **Window > Windows**.

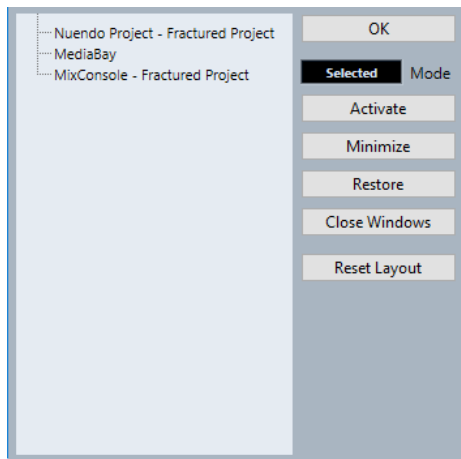

The dialog lists all open dialogs, windows, and editors. The following options are available:

OK

Closes the dialog.

Mode

Allows you to select a mode that affects the function.

- **Selected**
Affects the selected window only.
- **Cascaded**
Affects also the associated windows, such as the editors of a project window, for example.
- **All**
Affects all windows.

Activate

Activates the selected window.

Minimize

Minimizes the selected or all windows.

Restore

Restores the selected or all windows.

Close Windows

Closes the selected or all windows.

Reset Layout

Resets the layout of the selected window.

Where are the Settings Stored?

There is a large number of ways in which you can customize Nuendo. While some of the settings you make are stored with each project, others are stored in separate preference files.

If you need to transfer your projects to another computer in another studio, for example, you can bring all your settings along by copying the desired preference files and installing them on the other computer.

NOTE

It is a good idea to make a backup copy of your preference files once you have set things up the way you want! This way, if another Nuendo user wants to use his or her personal settings when working on your computer, you can restore your own preferences afterwards.

- On Windows, preference files are stored in the following location: “\Users\\AppData\Roaming\Steinberg\\”.
On the Start menu, you will find a shortcut to this folder for easy access.
- On macOS, preference files are stored in the following location: “/Library/Preferences/<program name>/” under your home directory.
The full path is: “/Users/<user name>/Library/Preferences/<program name>/”.

NOTE

The RAMpresets.xml file, which contains various presets settings, is saved when exiting the program.

NOTE

Program functions, such as crossfade, or configurations, such as panels, not used in the project will not be stored.

Updating from a Previous Version of Nuendo

When you are updating from Nuendo 5 or higher, most of the customized settings of your previous installation are used for the new Nuendo version.

When your previous Nuendo version is older than Nuendo 5, its settings are discarded, and the default settings of the new version of Nuendo are used.

Safe Mode Dialog

The **Safe Mode** dialog contains troubleshooting options.

- To open the **Safe Mode** dialog, launch Nuendo, and hold down **Ctrl/Cmd - Shift - Alt/Opt**.

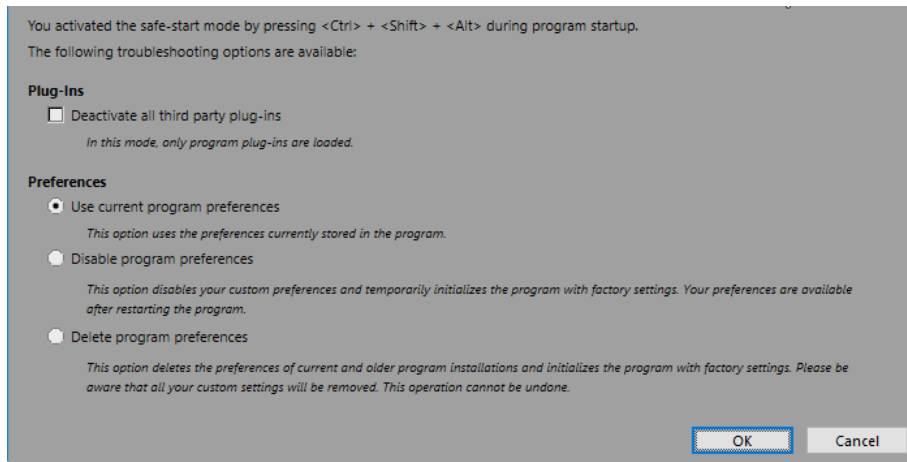

The following options are available in the **Plug-Ins** section:

Deactivate all third-party plug-ins

Temporarily disables all third-party plug-ins. After startup, only Steinberg plug-ins are available.

The following options are available in the **Preferences** section:

Use current program preferences

Opens the program with the current preference settings.

Disable program preferences

Disables the current preferences and opens the program with the factory default settings instead.

Delete program preferences

Deletes the preferences and opens the program with the factory default settings instead. This process cannot be undone. This affects all versions of Nuendo installed on your computer.

RELATED LINKS

[Disabling Third-Party Plug-ins](#) on page 1349

[Disabling the Preferences](#) on page 1348

Disabling the Preferences

Sometimes you might experience odd program behavior that can be due to inconsistent preferences settings. In such a case, you should save your project and relaunch Nuendo. You can disable or delete the current preferences settings, and load the factory defaults instead.

PROCEDURE

1. Quit Nuendo.
2. Launch Nuendo, and hold down **Ctrl/Cmd - Alt/Opt - Shift**.
3. In the **Preferences** section of the **Safe Start Mode** dialog, activate one of the troubleshooting options.
 - **Use current program preferences**
Opens the program with the current preference settings.
 - **Disable program preferences**
Disables the current preferences, and opens the program with the factory default settings instead.

- **Delete program preferences**

Deletes the preferences and opens the program with the factory default settings instead. This process cannot be undone. Note that this affects all versions of Nuendo installed on your computer.

4. Click **OK**.

AFTER COMPLETING THIS TASK

If the program works fine with disabled preferences, consider deleting and re-initializing the preferences.

RELATED LINKS

[Safe Mode Dialog](#) on page 1347

[Preferences](#) on page 1354

Disabling Third-Party Plug-ins

If Nuendo does not start or if a project does not load, chances are, that this is due to a third-party plug-in. In such a case, you can disable third-party plug-ins on startup to identify, if the plug-in is the reason.

PROCEDURE

1. Quit Nuendo.
 2. Launch Nuendo, and hold down **Ctrl/Cmd - Alt/Opt - Shift**.
 3. In the **Plug-Ins** section of the **Safe Start Mode** dialog, activate **Deactivate all third-party plug-ins**.
 4. Click **OK**.
-

RESULT

Only Steinberg plug-ins are available after startup, and third-party plug-ins are temporarily disabled.

RELATED LINKS

[Safe Mode Dialog](#) on page 1347

Optimizing Audio Performance

To get the most out of your Nuendo system, performance-wise, you can optimize specific settings.

NOTE

For details and current information on system requirements and hardware properties refer to the Steinberg web site.

Performance Aspects

Tracks and Effects

The faster your computer, the more tracks, effects, and EQs you are able to play. Exactly what constitutes a fast computer is almost a science in itself, but some hints are given below.

Short Response Times (Latency)

One aspect of performance is response time. The term “latency” refers to the buffering, that is, the temporary storing of small chunks of audio data during various steps of the recording and playback process on a computer. The larger those chunks, and the more there are, the higher the latency.

High latency is most irritating when playing VST instruments and when monitoring through the computer, that is, when listening to a live audio source via the Nuendo **MixConsole** and effects. However, very long latency times (several hundred milliseconds) can also affect other processes like mixing, for example, when the effect of a fader movement is heard only after a noticeable delay.

While Direct Monitoring and other techniques reduce the problems associated with very long latency times, a system that responds fast will always be more convenient to work with.

- Depending on your audio hardware, it may be possible to trim your latency times, usually by lowering the size and the number of buffers.
- For details, refer to the audio hardware documentation.

Audio Hardware and Driver

The hardware and its driver can have some effect on regular performance. A badly written driver can reduce the performance of your computer. But where the hardware driver design makes the most difference is with latency.

NOTE

We recommend that you use audio hardware for which there is a specific ASIO driver.

This is especially true when using Nuendo for Windows:

- Under Windows, ASIO drivers written specifically for the hardware are more efficient than the Generic Low Latency ASIO Driver and produce shorter latency times.
- Under macOS, audio hardware with properly written macOS (Core Audio) drivers can be very efficient and produce very low latency times.

However, there are additional features only available with ASIO drivers, such as the ASIO Positioning Protocol.

Settings That Affect Performance

Audio Buffer Settings

Audio buffers affect how audio is sent to and from the audio hardware. The size of the audio buffers affects both the latency and the audio performance.

Generally, the smaller the buffer size, the lower the latency. On the other hand, working with small buffers can be demanding for the computer. If the audio buffers are too small, you may get clicks, pops or other audio playback problems.

Adjusting the Buffer Size

To lower the latency, you can reduce the buffer size.

PROCEDURE

1. Select **Studio > Studio Setup**.
 2. In the **Devices** list, select your audio hardware driver.
 3. Click **Control Panel**.
 4. Do one of the following:
 - Windows: Adjust the buffer size in the dialog that opens.
 - macOS: Adjust the buffer size in the **CoreAudio Device Settings** dialog.
-

Multi Processing

Multi processing distributes the processing load evenly to all available CPUs, allowing Nuendo to make full use of the combined power of the multiple processors.

Multi processing is activated by default. You can find the setting in the **Studio Setup** dialog (**Audio System** page).

Audio Performance Window

This window shows the audio processing load and the hard disk transfer rate. This allows you to verify that you do not run into performance problems when adding effects or plug-ins, for example.

- To open the **Audio Performance** window, select **Studio > Audio Performance**.

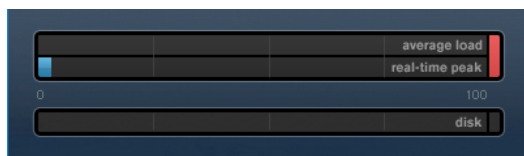

Average load

Shows how much of the available CPU power is used for audio processing.

Real-time peak

Shows the processing load in the real time path of the audio engine. The higher this value, the higher the risk that dropouts occur.

Overload indicator

The overload indicator to the right of the **real-time peak** indicator and the **average load** indicator displays overloads of the average or real-time indicator.

If it lights up, decrease the number of EQ modules, active effects, and audio channels that play back simultaneously. You can also activate the ASIO-Guard.

Disk

Shows the hard disk transfer load.

Disk overload indicator

The overload indicator to the right of the disk indicator lights up if the hard disk does not supply data fast enough.

If it lights up, use **Disable Track** to reduce the number of tracks playing back. If this does not help, you need a faster hard disk.

NOTE

You can show a simple view of the performance meter on the **Transport** panel and on the **Project** window toolbar. These meters only feature the average and the disk indicator.

ASIO-Guard

The ASIO-Guard allows you to shift as much processing as possible from the ASIO real time path to the ASIO-Guard processing path. This results in a more stable system.

The ASIO-Guard allows you to preprocess all channels as well as VST instruments that do not need to be calculated in real time. This leads to fewer dropouts, the ability to process more tracks or plug-ins, and the ability to use smaller buffer sizes.

ASIO-Guard Latency

High ASIO-Guard levels lead to an increased ASIO-Guard latency. When you adjust a volume fader, for example, you will hear the parameter changes with a slight delay. The ASIO-Guard latency, in contrast to the latency of the audio hardware, is independent from live input.

Restrictions

The ASIO-Guard cannot be used for:

- Real time-dependent signals
- External effects and instruments

NOTE

If you select **Studio > VST Plug-in Manager** and click **Show VST Plug-in Information**, you can deactivate the ASIO-Guard option for selected plug-ins.

If you activate the monitoring for an input channel, a MIDI instrument, or a VST instrument channel, the audio channel and all dependent channels are automatically switched from ASIO-Guard to real time processing and vice versa. This results in a gentle fade out and fade in of the audio channel.

RELATED LINKS

[VST 2 Plug-in Path Settings](#) on page 855

Activating the ASIO-Guard

PROCEDURE

1. Select **Studio > Studio Setup**.
2. In the **Devices** list, select **Audio System**.
3. Activate the **Activate ASIO-Guard** option.

NOTE

This option is only available if you activate **Activate Multi Processing**.

4. Select an **ASIO-Guard Level**.
The higher the level, the higher the processing stability and audio processing performance. However, higher levels also lead to an increased ASIO-Guard latency and memory usage.
-

Preferences

The **Preferences** dialog provides options and settings that control the global behavior of the program.

Preferences Dialog

The **Preferences** dialog is divided into a navigation list and a settings page. Clicking one of the entries in the navigation list opens a settings page.

- To open the **Preferences** dialog, select **Edit > Preferences**.

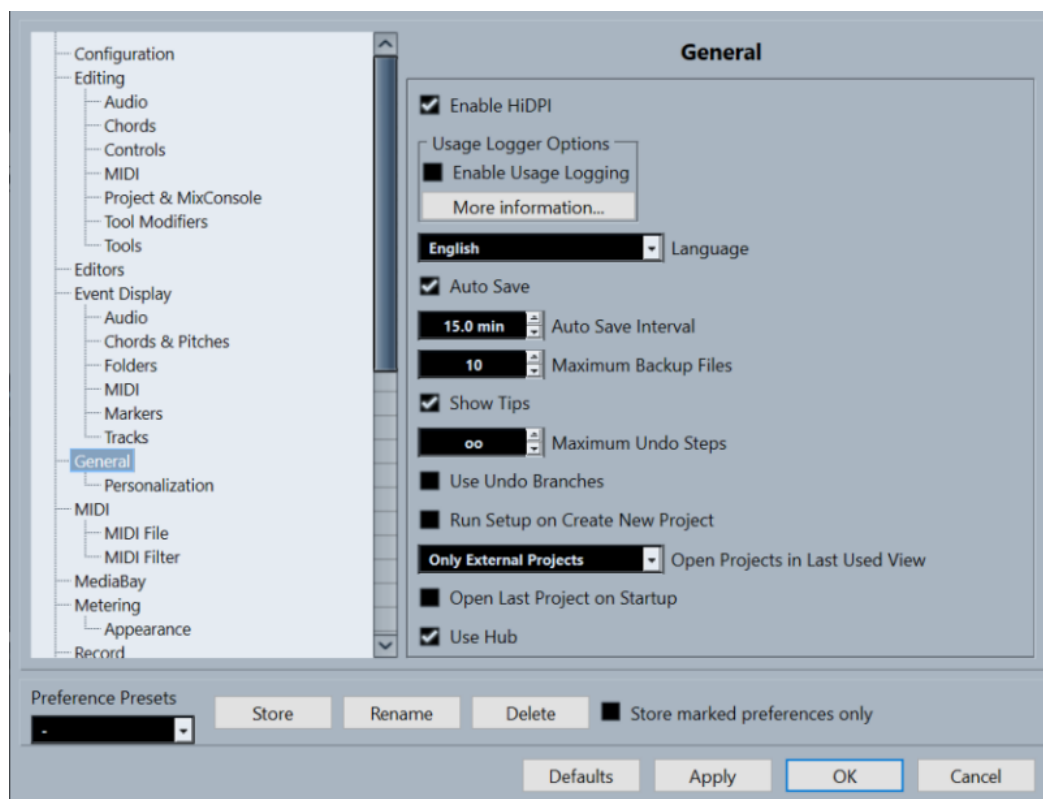

In addition to the settings, the dialog provides the following options:

Preference Presets

Allows you to select a saved preference preset.

Store

Allows you to save the current preferences as a preset.

Rename

Allows you to rename a preset.

Delete

Allows you to delete a preset.

Store marked preferences only

Allows you to select which pages are included in the preset.

Defaults

Resets the options on the active page to their default settings.

Apply

Applies any changes that you have made without closing the dialog.

OK

Applies any changes that you have made and closes the dialog.

Cancel

Closes the dialog without saving any changes.

Saving Preference Presets

You can save complete or partial preference settings as presets.

PROCEDURE

1. In the **Preferences** dialog, make your changes.
2. Click **Store** in the lower left section of the dialog.
3. Enter a preset name and click **OK**.

RESULT

Your settings are now available on the **Preference Presets** pop-up menu.

Saving Partial Preference Settings

You can save partial preference settings. This is useful when you have made settings that only relate to a certain project or situation, for example. When you apply a saved partial preference preset, you only change the saved settings. All other preferences are left unchanged.

PROCEDURE

1. In the **Preferences** dialog, make your changes.
2. Activate **Store marked preferences only**.
In the preferences list, the **Store** column is shown.

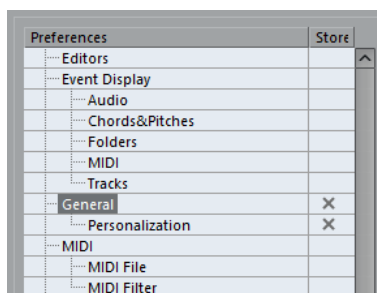

3. Click in the **Store** column of the preference pages that you want to save.
4. Click **Store** in the lower left section of the dialog.
5. Enter a preset name and click **OK**.

RESULT

Your settings are now available from the **Preference Presets** pop-up menu.

Configuration

This section allows you to configure what items are shown on the main menus and submenus. You can also hide entire menus.

You can activate/deactivate key commands for menu items by changing the **On/Off** status in the **Command** column. Even if a key command is assigned to an item, it will be disabled if you set the key command status to **Off**.

- The **Configuration** page contains 2 parent folders: **Main Menu**, which contains subfolders with items found on all main menus, and **Command Categories**, which contains subfolders with items corresponding to program functions that are not available on the main menus.
- To hide a menu item or a menu, click in the **Menu** column beside it to change it to **Off**. Click again to change back to **On**.

All menu items or menus set to **Off** will be hidden in the program when you click **Apply** or **OK**.

NOTE

Note that certain essential menu items cannot be hidden, such as **Save, Open, Close, Undo/Redo**, etc. This has the consequence that if you set a main menu folder that contains such items to **Off**, all hideable items on the menu will be set to **Off**, but the menu will still be visible.

- To disable the key commands for a menu item, menu or function, click in the **Command** column beside it so that the column reads **Off**. Click again to change back to **On**.
For all items set to **Off** it will not be possible to use any assigned key commands when you click **Apply** or **OK**.
- By clicking **Enable All**, you can revert back to the default settings - all items set to **On**. Meaning all menu items are visible and all key commands enabled.

RELATED LINKS

[Configuring the Main Menu Items](#) on page 1340

Editing

'Edit Solo'/'Record in MIDI Editors' Follow Focus

Suspends **Record in Editor** and **Solo Editor** in the MIDI editor if the **Project** window gets the focus.

Default Track Time Type

Allows you to select the default track time type for new tracks.

- **Musical**
Sets new tracks to musical time base.
- **Time Linear**
Sets new tracks to linear time base.
- **Follow Transport Main Display**
Sets new tracks to follow the primary time format: **Bars+Beats** format sets new tracks to musical time base. **Seconds, Timecode, Samples**, etc. sets new tracks to linear time base.

Display Warning before Deleting Non-Empty Tracks

Shows a warning if you delete tracks that are not empty.

Select Track on Background Click

Allows you to select a track by clicking in the event display background.

Auto Select Events under Cursor

Automatically selects all events in the **Project** window or in an editor that are under the project cursor.

Cycle Follows Range Selection

Sets the left locator to the range start position and the right locator to the range end position of a range selection.

Delete Overlaps

Deletes overlapped, that is, hidden, sections of overlapping events. Hold **Shift** while moving events to override this setting.

Parts Get Track Names

Automatically changes event names to the name of the track they are moved to.

Lock Event Attributes

Determines which properties are affected when you lock an event. You can use any combination of the following:

- **Position**
Locks the position so that the event cannot be moved.
- **Size**
Locks the size so that the event cannot be resized.
- **Other**
Locks all other editing of the event. This includes adjusting the fades and event volume, processing, etc.

Quick Zoom

Only redraws the contents of parts and events once you have stopped changing the zoom. This is useful if screen redraws are slow on your system.

Use Up/Down Navigation Commands for Selecting Tracks only

Uses the **Up Arrow** / **Down Arrow** keys for track selection, not for event/part selection.

Track Selection Follows Event Selection

Automatically selects the corresponding track if you select an event in the **Project** window.

Automation Follows Events

Lets automation events automatically follow when you move, duplicate, copy, or paste an event or part on the track. This facilitates setting up automation that is related to a specific event or part, instead of a specific position in the project.

Drag Delay

Allows you to set up a delay in ms that is used when you move events. This is useful to avoid accidentally moving events when you click on them in the **Project** window.

Editing - Audio

Treat Muted Audio Events like Deleted

Allows you to play the hidden event of 2 overlapping audio events when you mute the top event.

Use Mouse Wheel for Event Volume and Fades

Allows you to use the mouse wheel to move event volume and fades.

- Moving the mouse wheel moves the event volume curve up or down.
- Holding down **Shift** while moving the mouse wheel moves the fade curves.
- Positioning the mouse in the left half of the event moves the end point of the fade in.
- Positioning the mouse in the right half of the event moves the start point of the fade out.

Simple Crossfade Editor

Opens a simplified **Crossfade** dialog when you double-click a crossfade or select **Open Fade Editor(s)** from the **Audio** menu. The regular **Crossfade** dialog contains a host of additional, advanced functions for adjusting crossfades.

On Import Audio Files

Determines what happens when you import an audio file.

- **Open Options Dialog**
Opens a dialog where you can select whether you want to copy the file to the audio folder and/or convert it to the project settings.
- **Use Settings**
Uses the default settings for importing audio.

Remove Regions/Hitpoints on all Offline Processes

Removes regions/hitpoints of audio ranges when you perform offline processing.

On Processing Shared Clips

Determines what happens when you apply processing to a shared clip that is used by more than one event in the project.

- **Open Options Dialog**
Opens the **Options** dialog that allows you to select whether you want to create a new version of the clip or apply the processing to the existing clip.
- **Create New Version**
Creates a new editing version of the clip, and applies the processing to that version leaving the original clip unaffected.
- **Process Existing Clip**
Applies the processing to the existing clip. All events playing that clip are affected.

Enable Automatic Hitpoint Detection

Enables the automatic hitpoint detection for imported or newly recorded audio files.

Time Stretch Tool Algorithm

Sets the default algorithm that is applied when you use the **Object Selection** tool in **Sizing Applies Time Stretch** mode.

Default Warping Algorithm

Sets the warp algorithm for new audio clips in the project.

Editing - Chords

'X' Chords Mute Notes on Tracks That are in Follow Chord Track Mode

Mutes playback when you play back a track that follows the chord track and the cursor reaches an undefined chord event (X chord).

Disable 'Acoustic Feedback' during Playback

Disables **Acoustic Feedback** during playback. This ensures that chord events are not triggered twice.

Hide Muted Notes in Editors

Hides notes that get muted due to their MIDI track following the chord track.

Editing - Controls

Value Box/Time Control Mode

Allows you to select your preferred way of controlling value fields.

- **Text Input on Left-Click**
Clicking opens a value box for editing.
- **Increment/Decrement on Left/Right-Click**
Clicking decreases the value, right-clicking increases the value. Double-clicking allows you to enter values manually.
- **Increment/Decrement on Left-Click and Drag**
Clicking and dragging up or down adjusts the value. Double-clicking allows you to enter values manually.

Knob Mode

Allows you to select your preferred way of controlling knobs.

- **Circular**
Clicking and dragging in a circular motion changes the setting. Clicking anywhere along the encoder's edge immediately changes the setting.
- **Relative Circular**
Clicking anywhere on an encoder and dragging changes the current setting. There is no need to click on the exact current position.
- **Linear**
Clicking on an encoder and dragging up or down, or left or right changes the setting.

Slider Mode

Allows you to select your preferred way of controlling value sliders.

- **Jump**
Clicking anywhere on a slider instantly moves the slider handle to that position.
- **Touch**
Clicking and dragging the actual slider handle adjusts the setting.
- **Ramp**
Clicking and dragging a slider causes the handle to move smoothly to the new position.
- **Relative**
Clicking and dragging up or down changes the setting according to how far you drag, not according to where you click.

Editing - MIDI

Select Controllers in Note Range: Use Extended Note Context

Takes into account the extended note context when you move notes together with their controllers. This means that controllers between the last selected note and the following note or the end of the part are also moved.

Legato Overlap

Allows you to set an overlap for the **Legato** function. **Legato** allows you to extend MIDI notes so that they reach the next notes.

An overlap setting of 0 ticks causes each selected note to extend so that it reaches the next note exactly. A positive value causes the notes to overlap by the specified number of ticks. A negative value causes a slight gap between the notes.

Legato Mode: Between Selected Notes Only

Adjusts the length of selected notes so that they reach the next selected note.

Split MIDI Events

Splits MIDI events when you split a MIDI part in the **Project** window, and the split position intersects the MIDI events. This also creates new notes at the beginning of the second part.

Split MIDI Controllers

Splits MIDI controllers when you split a MIDI part in the **Project** window, and the part contains a controller. If the controller value at the split position is not zero, a new controller event of the same type and value is inserted at the split position at the start of the second part.

NOTE

If you just split a part and play back the result, it will sound the same regardless of this setting. However, if you split a part and delete the first half or move the second half to a different position in the project, you may want to activate **Split MIDI Controllers** to make sure all controllers have the correct value at the beginning of the second part.

Editing - Project & MixConsole

Select Channel/Track on Solo

Selects channels/tracks when you click their **Solo** button.

Select Channel/Track on Edit Settings

Selects channels/tracks when you click their **Edit Channel Settings** button.

Scroll to Selected Track

Scrolls the track list when you select a **MixConsole** channel and the respective track is out of view.

Sync Selection in Project Window and MixConsole

Synchronizes the selection in the **Project** window and the **MixConsole**.

Enable Record on Selected MIDI Track

Record-enables MIDI tracks when you select them.

Enable Record on Selected Audio Track

Record-enables audio tracks when you select them.

Enable Solo on Selected Track

Solos tracks when you select them.

Deep Track Folding

Applies the **Track Folding** functions to all subelements of the tracks.

Enlarge Selected Track

Enlarges a track when you select it. If you select a different track, this track is enlarged, and the previously selected track is displayed in its original size.

Editing - Tool Modifiers

On this page, you can specify which modifier keys are used for additional functionality when using tools.

PROCEDURE

1. Select an option in the **Categories** list.
 2. Select the action for which you want to edit the modifier keys in the **Action** list.
 3. On your computer keyboard, hold down the modifier keys and click **Assign**.
-

RESULT

The current modifier keys for the action are replaced. If this tool already has assigned modifier keys, you are prompted to replace them.

Editing - Tools

Show Toolbox on Right Click

Opens a toolbox when you right-click in the event display and editors. To open the context menu instead of the toolbox, press any modifier key when right-clicking.

Cross-Hair Cursor

Allows you to set up the colors for the line and the mask of the cross-hair cursor, as well as its width.

Zoom Tool Standard Mode: Horizontal Zooming Only

Zooms the window horizontally without changing the track height when you zoom with the **Zoom** tool.

Select Tool: Show Extra Info

Displays the current pointer position and the name of the track and event at which you are pointing when you use the **Object Selection** tool in the **Project** window event display.

Show Notification when Switching Tool Mode with Key Command

Shows a notification when you switch the tool mode by using a key command.

Editors

Use Drum Editor when Drum Map is assigned

Shows drum note symbols in parts on MIDI tracks to which drum maps are assigned. The parts automatically open in the **Drum Editor** on double-click. This overwrites the **Default MIDI Editor** setting.

Default MIDI Editor

Determines which editor is opened when you double-click a MIDI part or when you select it and press **Ctrl/Cmd-E**. This setting is overwritten for tracks with drum maps if **Use Drum Editor when Drum Map is assigned** is activated.

Editor Content Follows Event Selection

Open editors show the events that are selected in the **Project** window.

Double-click opens Editor in a Window/in Lower Zone

Determines where an editor is opened when you double-click an audio event or a MIDI part, or when you use the key command assigned to **Open/Close Editor**.

Open Editor Commands open Editors in a Window/in Lower Zone

Determines where an editor is opened when you use an open command from the **Audio** or **MIDI** menu or the corresponding key commands.

Event Display

The **Event Display** section contains several settings for customizing the display in the **Project** window.

Show Event Names

Shows the names on parts and events.

Hide Truncated Event Names

Hides event names if they are too long.

Show Overlaps

Determines how overlapping events are displayed.

Grid Overlay Intensity

Sets the overlay intensity of the displayed grid lines.

Event Handling Opacity

Sets the opacity of overlying events when you move them.

Event Opacity

Sets the opacity of the event background.

NOTE

- If you reduce the event opacity, it might be helpful to increase the **Waveform Brightness** for audio events or the **Note Brightness** for MIDI events.
- Reducing the opacity may result in a less responsive user interface.

Smallest Track Height to Show Data

Determines from which track height the track contents are displayed.

Smallest Track Height to Show Name

Determines from which track height the track names are displayed.

RELATED LINKS

[Waveform Brightness](#) on page 1363

[Note Brightness](#) on page 1365

Event Display - Audio

Addition to Event Name

Allows you to add metadata to the event name.

Further Addition to Event Name

Allows you to add further metadata to the event name.

Interpolate Audio Waveforms

Interpolates sample values to form curves when you zoom in to one sample per pixel or less.

Show Event Volume Curves Always

Shows event volume curves, regardless of whether the event is selected.

Show Waveforms

Shows waveforms for audio events.

Show Hitpoints on Selected Events

Shows hitpoints for selected audio events.

Waveform Brightness

Sets the brightness of the waveform.

Waveform Outline Intensity

Sets the intensity of the waveform outline.

Fade Handle Brightness

Sets the brightness of the fade lines for audio events.

Background Color Modulation

Reflects the waveform dynamics in the background of audio waveforms.

Event Display - Chords & Pitches

Pitch Notation

- **Note Name**
Allows you to select how chord symbols are displayed. You can choose **English**, **German**, or **Solfège**.
- **Naming Format**
Allows you to determine how MIDI note names are displayed in editors, etc.
- **Display 'Bb' as 'B'**
Displays 'B' as a pitch name. This is only available if you selected **English** in the **Note Name** pop-up menu.
- **Display 'B' as 'H'**
Displays 'H' as a pitch name. This is only available if you selected **English** in the **Note Name** pop-up menu.
- **Enharmonics from Chord Track**
Uses the chord events on the chord track to determine if enharmonically equivalent notes in the **Key Editor** and in the **List Editor** are displayed as sharp or flat.

Chord Font

Allows you to specify a font for all chord symbols.

Chord Symbols

Allows you to select your preferred display method for major 7th chords, minor chords, half-diminished chords, diminished chords, and augmented chords.

Custom Chord Symbols

Allows you to modify the default chord symbols that are used on the chord track, for the chord pads, and in the **Score Editor**.

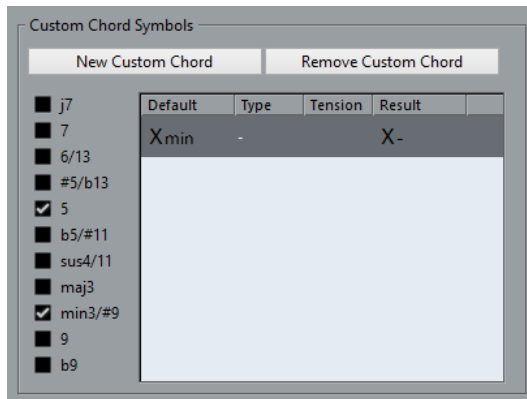

- **New Custom Chord** allows you to add a new custom chord symbol.
- The options to the left allow you to specify the chord for which you want to change the chord symbol.
- Click the **Type** and **Tension** column and enter your custom symbol.

NOTE

You must define custom symbols for each set of tensions.

- The **Result** column shows how the chord will be displayed.
- The **Remove Custom Chord** button allows you to remove the custom chord symbol that is selected in the list.

EXAMPLE

To change the appearance of all minor chords from **Xmin** to **X-**, click **New Custom Chord**, activate **5** and **min3/#9** to define the chord type, and change the symbol in the **Type** column from **min** to **-**.

Event Display - Folders

Show Event Details

Displays event details instead of data blocks.

This setting depends on the **Show Data on Folder Tracks** setting.

Show Data on Folder Tracks

Determines in which case data blocks or event details are displayed on folder tracks.

- **Always Show Data**
Displays data blocks or event details always.
- **Never Show Data**
Displays nothing.
- **Hide Data When Expanded**
Hides the display of events when you open folder tracks.

Event Display - MIDI

Part Data Mode

Determines if and how events in MIDI parts are shown. This setting is overwritten for tracks with drum maps if **Use Drum Editor when Drum Map is assigned** is activated.

Show Controllers

Shows non-note events such as controllers, etc. in MIDI parts.

Note Brightness

Sets the brightness of note events.

Controller Brightness

Sets the brightness of controller events.

RELATED LINKS

[Use Drum Editor when Drum Map is assigned](#) on page 1361

Event Display - Markers

Show Marker Lines

Allows you to specify if marker lines are shown on other tracks in the **Project** window.

- **Off**
Marker lines are only shown on marker tracks.
- **From Active Marker Track**
Marker lines of the active marker track are shown on other tracks in the **Project** window.
- **From All Marker Tracks**
Marker lines of all marker tracks are shown on other tracks in the **Project** window.

RELATED LINKS

[Markers](#) on page 368

Event Display - Tracks

Default Track Name Width

Sets the default name width for all track types.

General

The **General** page contains general settings that affect the program user interface. Set these according to your preferred work methods.

Enable HiDPI (Windows only)

Enables the appropriate resolution to render Nuendo GUI elements sharp and precise on high resolution displays with supported scaling factors of 100 %, 125 %, 150 %, 175 %, and 200 %.

NOTE

Other scaling factors, such as 133 %, are not supported.

NOTE

On macOS, you can disable HiDPI support in the Nuendo application folder by invoking **Get Info** and checking **Open in Low Resolution**.

Usage Logger Options

If you activate this option, Nuendo gathers usage information and writes it in a log file that you can find in the following location:

- On Windows: “\Users\\AppData\Local\Steinberg\usagelogger”
On macOS: “/Users/<user name>/Library/Logs/Steinberg/usagelogger”

Activating this option to write such a file, and then sending the file to the Steinberg support team can be useful if Nuendo crashes, and the crash dump files do not reveal enough information.

By default, **Enable Usage Logging** is deactivated. We recommend that you deactivate it when you no longer need it.

Language

Allows you to select which language is used in the program. After switching the language, you must restart the program for the change to take effect.

Auto Save

Automatically saves backup copies of all open projects with unsaved changes. These are named Name .bak, where name is the name of the project, and are saved in the project folder. Backup copies of unsaved projects are named #UntitledX.bak, where X is an incremental number, to allow multiple backup copies in the same project folder.

Auto Save Interval

Allows you to specify how often a backup copy is created.

Maximum Backup Files

Allows you to specify how many backup files are created. When the maximum number of backup files is reached, the existing files is overwritten starting with the oldest file.

Show Tips

Displays an explanatory tooltip when you position the mouse pointer over an icon or button in Nuendo.

Maximum Undo Steps

Allows you to specify the number of undo steps.

Use Undo Branches

Gathers edit actions in the **Edit History** dialog and automation actions on the automation panel in branches.

Run Setup on Create New Project

Opens the **Project Setup** dialog every time you create a new project.

Open Projects in Last Used View

Allows you to determine what window layout is used when you open a project.

- **Never**
Uses the original window layout and settings.
- **Only External Projects**
Projects that have been created on a different computer use the view that you last used on your computer. Projects that have been created on this computer use the original window layout and settings.
- **Always**
Uses the view that you last used on your computer.

Open Last Project on Startup

Opens the last saved project when you start Nuendo.

Use Hub

Opens the **Hub** when you start Nuendo or create a new project using the **File** menu.

RELATED LINKS

[VST Instrument Context Menu](#) on page 841

General - Personalization

Default Author Name

Allows you to specify an author name that is used by default for new projects. This is included as metadata when exporting audio files with an iXML chunk.

Default Company Name

Allows you to specify a company name that is used by default for new projects. This is included as metadata when exporting audio files with an iXML chunk.

MIDI

This page contains settings that affect MIDI recording and playback.

MIDI Thru Active

Sets all MIDI tracks that are record-enabled or have monitoring activated to echo incoming MIDI data, sending it back out on their respective MIDI outputs and channels. This allows you to hear the correct sound from your MIDI instrument during recording.

NOTE

If you use MIDI Thru, select **Local Off** mode on your MIDI instrument to prevent each note from sounding twice.

Reset on Stop

Sets Nuendo to send out MIDI reset messages, including note-off and controller resets, on stop.

Never Reset Chased Controllers

Never resets controllers to 0 when you stop playback or move to a new position in the project.

Length Adjustment

Allows you to enter a length adjustment value in ticks by which the notes that have the same pitch and MIDI channel are adjusted. This ensures that there is always a short time between the end of one note and the start of another. By default, there are 120 ticks per 1/16 note, but you can adjust this with the **MIDI Display Resolution** setting.

Chase Events

Chases event types for which one of the chase options is activated when you locate to a new position and start playback. This makes your MIDI instruments sound as they should when you locate to a new position and start playback.

If **Chase not limited to Part Boundaries** is activated, MIDI controllers are also chased outside the part boundaries, and the chase is performed on the part under the cursor as well as on all the parts to the left of it. Deactivate this for very large projects, as it slows down processes such as positioning and soloing.

MIDI Display Resolution

Allows you to set the display resolution for viewing and editing MIDI data.

Extend Playback Range of Notes that start before the Part

Extends the playback range of MIDI notes that start before the part in ticks. This is useful if MIDI events start shortly before the start of the MIDI part. If you do not

extend the playback range, these events are not played. This setting is also taken into account during cycle playback.

Insert Reset Events after Record

Inserts a reset event at the end of each recorded part. This resets controller data, such as **Sustain**, **Aftertouch**, **Pitchbend**, **Modulation**, or **Breath Control**. This is useful if you stop recording before the note off command is sent, for example.

Audition through MIDI Inserts/Sends

Activates the layering of MIDI instruments (by MIDI sends) also within the MIDI editors. This way, the acoustic feedback of the editors sends the MIDI data not only to the output selected for the track, but additionally through any MIDI inserts and MIDI sends assigned to it. However, this also means that MIDI events will be sent through any MIDI plug-ins assigned to this track.

MIDI Latency Mode

Allows you to specify the latency of the MIDI playback engine.

Low lowers the latency and increases the responsiveness of the MIDI playback engine. However, this setting might also decrease your computer performance if your project contains lots of MIDI data.

Normal is the default mode and the recommended setting for most workflows.

High increases the latency and the playback buffer. Use this if you work with complex VST instrument libraries or with projects that have a very high performance level.

MIDI Max. Feedback in ms

Allows you to set the maximum length of the notes when using **Acoustic Feedback** in MIDI editors.

MIDI - MIDI File

Export Options

These options allow you to specify what data is included in exported MIDI files.

Export Inspector Patch

Includes MIDI patch settings in the **Inspector** as MIDI bank select and program change events in the MIDI file.

Export Inspector Volume/Pan

Includes volume and pan settings in the **Inspector** as MIDI volume and pan events in the MIDI file.

Export Automation

Includes automation as MIDI controller events in the MIDI file. This also includes automation recorded with the **MIDI Control** plug-in.

If you record a continuous controller (CC7, for example) and deactivate **Read Automation** for the automation track, only the part data for this controller is exported.

Export Inserts

Includes MIDI modifiers and MIDI inserts in the MIDI file.

Export Sends

Includes MIDI sends in the MIDI file.

Export Markers

Includes markers as standard MIDI file marker events in the MIDI file.

Export as Type 0

Exports a type 0 MIDI file with all data on a single track, but on different MIDI channels. If you deactivate this option, a type 1 MIDI file with data on separate tracks is exported.

Export Resolution

Allows you to set a MIDI resolution between 24 and 960 for the MIDI file. The resolution is the number of pulses, or ticks, per quarter note (PPQ) and determines the precision with which you will be able to view and edit the MIDI data. The higher the resolution, the higher the precision. The resolution should be chosen depending on the application or sequencer with which the MIDI file will be used, because certain applications and sequencers may not be able to handle certain resolutions.

Export Locator Range

Exports only the range between the left and right locator.

Export includes Delay

Includes delay settings you have made in the **Inspector** in the MIDI file.

Import Options

The **Import Options** for MIDI files allow you to specify what data is included in imported MIDI files.

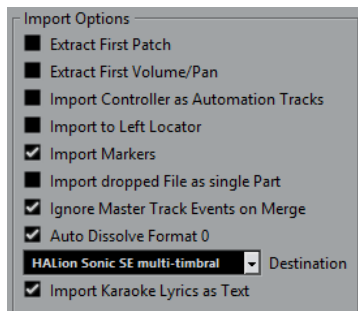

Extract First Patch

Converts the first **Program Change** and **Bank Select** events for each track to **Inspector** settings for the track.

Extract First Volume/Pan

Converts the first **MIDI Volume** and **Pan** events for each track to **Inspector** settings for the track.

Import Controller as Automation Tracks

Converts **MIDI Controller** events in the MIDI file to automation data for the MIDI tracks.

Import to Left Locator

Aligns the imported MIDI file at the position of the left locator.

Import Markers

Imports Standard MIDI File Markers in the file and converts them to Nuendo markers.

Import Dropped File as Single Part

Places the file on one track if you drag a MIDI file into the project.

Ignore Master Track Events on Merge

Ignores tempo track data if you import a MIDI file into the current project. The imported MIDI file will play according to the current tempo track in the project.

Auto Dissolve Format 0

Automatically dissolves imported MIDI files of type 0. Each embedded MIDI channel in the file is placed on a separate track in the **Project** window.

Destination

Allows you to specify what happens when you drag a MIDI file into the project.

- **MIDI Tracks** creates MIDI tracks for the imported file.
- **Instrument Tracks** creates instrument tracks for each MIDI channel in the MIDI file and lets the program automatically load appropriate presets.
- **HALion Sonic SE multi-timbral** creates several MIDI tracks, each routed to a separate instance of HALion Sonic SE in the **VST Instruments** window, and loads the appropriate presets.

Import Karaoke Lyrics as Text

Converts karaoke lyrics in the MIDI file to text that can be displayed in the **Score Editor**. If this option is deactivated, lyrics are only shown in the **List Editor**.

MIDI - MIDI Filter

This page allows you to prevent certain MIDI messages from being recorded and/or echoed by the MIDI thru function (thruput).

The page is divided into 4 sections:

Record

Prevents the corresponding type of MIDI message from being recorded. It will, however, be thruput, and if already recorded, play back normally.

Thru

Prevents the corresponding type of MIDI message from being thruput. It will, however, be recorded and played back normally.

Channels

Prevents MIDI messages on that MIDI channel from being recorded or thruput. Already recorded messages are, however, played back normally.

Controller

Prevents certain MIDI controller types from being recorded or thruput.

To filter out a controller type, select it from the list at the top of the section and click **Add**. It is shown in the list below.

To remove a controller type from the list (allow it to be recorded and thruput), select it in the lower list and click **Remove**.

MediaBay

Maximum Items in Results List

Sets the maximum number of files that are displayed in the **Results** list.

Allow Editing in Results List

Enables editing of attributes in the **Results** list.

Show File Extensions in Results List

Displays file name extensions in the **Results** list.

Scan Folders Only When MediaBay Is Open

Scans for media files when the **MediaBay** window is open.

NOTE

During playback or recording no folder scans are performed.

Scan Unknown File Types

Scans all file types.

Metering

Map Input Bus Metering to Audio Track (in Direct Monitoring)

Maps the input bus metering to monitor-enabled audio tracks, giving you the opportunity to watch the input levels of your audio tracks when working in the **Project** window. For this to work, activate **Direct Monitoring** in the **Studio Setup** dialog.

Note that the tracks are mirroring the input bus signal, that is, you will see the same signal in both places. When using mapped metering, any functions, such as trimming, that you apply to the audio track are not reflected in its meters.

Meters' Peak Hold Time

Allows you to specify for how long the peak levels are held in the meters. For this to work, deactivate **Meters - Hold Forever** in the **MixConsole**.

Meters' Fallback

Allows you to specify how quickly the meters in the **MixConsole** return to lower values after signal peaks.

Metering - Appearance

This page allows you to assign colors to level meter values to quickly identify what levels are reached. You can edit the appearance individually for all available scales.

Add

Adds a color handle to the top of the meter.

Remove

Removes the selected color handle.

Scale

Allows you to select a scale for editing.

NOTE

The **+3 dB Digital** scale is used for the channel meters.

RELATED LINKS

[Setting up Meter Colors](#) on page 433

Record

This page contains settings related to audio and MIDI recording.

Deactivate Punch In on Stop

Deactivates **Punch In** on the **Transport** panel whenever you enter stop mode.

Stop after Automatic Punch Out

Stops playback after automatic **Punch Out**. If the post-roll value on the **Transport** panel is set to a value other than zero, playback will continue for the set time before stopping.

Record - Audio

Audio Pre-Record Seconds

Sets for how many seconds any incoming audio you play is captured in buffer memory during playback or in stop mode.

When Recording Wave Files Larger than 4 GB

Determines what happens if you record wave files that are larger than 4 GB.

- To split the wave file, select **Split Files**.
Use this if you work on a FAT32 file system that supports only file sizes up to 4 GB.
- To save the wave file as an RF64 file, select **Use RF64 Format**.
RF64 files use the .wav extension. However, they can only be opened with an application that supports the RF64 standard.

Create Audio Images during Record

Creates and displays a waveform image during the recording process.

NOTE

This real-time calculation uses some extra processing power.

Record - Audio - Broadcast Wave

This page allows you to specify the **Description**, **Author**, and **Reference Value** text strings that are embedded in recorded Broadcast Wave files. The settings you make here also appear as default strings in the **Broadcast Wave Chunk** dialog when you export files to certain formats. Not only Broadcast Wave files can contain embedded information, but also Wave, and AIFF files.

Record - MIDI

Record-Enable allows MIDI Thru

Prevents record-enabled MIDI or instrument tracks from echoing incoming MIDI data. This way record-enabled tracks to which a VST instrument is assigned do not play doubled notes.

Snap MIDI Parts to Bars

Lengthens recorded MIDI parts so that they start and end at whole bar positions. If you are working in a context that is based on bars and beats, this can make editing, such as moving, duplicating, and repeating, easier.

MIDI Record Catch Range in ms

Ensures that the very start of a recording that starts at the left locator is included.

Retrospective Record Buffer Size

You can capture MIDI data that you played in **Stop** mode or during playback and turn them into a MIDI part. **Retrospective Record Buffer Size** determines how much MIDI data can be captured in the buffer.

ASIO Latency Compensation Active by Default

Determines the initial state of the **ASIO Latency Compensation** button in the track list for MIDI or instrument tracks.

If you record live on a VST instrument, you usually compensate the latency of your audio card by playing too early. In consequence, the timestamps are recorded too early. By activating this option, all recorded events are moved by the current latency, and playback sounds like during the recording situation.

Add Latency to MIDI-Thru Processing

If you set the audio buffer size to a high value, and you play an arpeggiator in real time, for example, the MIDI notes are output with an increased latency.

If you consequently adapt your playing to the output latency, the notes are recorded even later. To minimize this effect, you can activate **Add Latency to MIDI-Thru Processing**. This adds a regular latency to each note that is played in real time.

Replace Recording in Editors

Affects the result of recording in a MIDI editor when **Replace** mode is selected as a record mode:

- **None**
Nothing is replaced.
- **Controller**
Only controller data is replaced, not notes.
- **All**
Replace mode works as usual. Notes and controllers are replaced when recording.

Scores

This page allows you to make settings for the **Score Editor**. Select one of the available entries.

Scores - Colors for Additional Meanings

Allows you to specify different colors to identify non-standard elements in the score.

- Click in the **Active** column to activate this function for the respective element.
- Click in the color field to the right to specify a color.

Scores - Editing

Insert Tool

Display Object Selection Tool after Inserting Symbol

Switches back to the **Object Selection** tool after you add a symbol.

Double-Click Symbol to Get Draw Tool

Activates the **Draw** tool in a palette when you double-click with the **Object Selection** tool.

Selections

Tied Notes Selected as Single Units

Selects both notes when you click on either note in a tied note pair.

Note Tool

Show Bars and Beats Positions When Inserting Notes

Shows the bars and beats positions when you insert notes with the mouse or the computer keyboard.

Show Pitch When Inserting Notes

Indicates the pitch when inserting notes.

Use Mouse Wheel to Transpose Notes

Allows you to transpose selected notes with the mouse wheel.

Show Note Info by the Mouse

Shows a tooltip with pitch and position information when inserting or dragging a note in the score.

Layout Tool

Global Staff Spacings with **Alt/Opt - Ctrl/Cmd**

Applies the spacing to all staves on the current and all the following pages when you press **Alt/Opt - Ctrl/Cmd** and adjust the spacing of staves.

Show Braces in Edit Mode

Shows braces also in **Edit Mode**, not only in **Page Mode**.

Unlock Layout When Editing Single Parts

If there is more than one part on a track, and you open the **Score Editor** for one of these parts, the other parts are displayed as empty space to preserve the layout. If this option is activated, this empty space is avoided, so you can print this single part without endless rests.

NOTE

This option erases the layout for the whole track. The next time you open the entire track, the previous layout is overwritten with the layout settings you made for the single edited part.

Double-Click on Staff Flips between Full Score/Part

Switches between display of either the whole track or the current part when you double-click on a staff.

NOTE

In this case, the **Score Settings** dialog only opens if you select **Scores > Settings**.

Miscellaneous

Show Position Cursor

Shows the project cursor as a vertical line in the score. You can click and drag the line to move the cursor or hold down **Ctrl/Cmd** and click anywhere in the score to move the cursor directly there.

“Apply” closes Property Windows

Closes property windows and non-modal dialogs when you click **Apply**.

Hide Notes beyond Limits

Hides notes outside the **Note Limits** range set in the **Score Settings** dialog (**Staff page - Options** tab).

Default Number of Bars per Staff

This is used in 2 cases:

- In **Edit Mode** this sets how many bars are shown across the page.
- In **Page Mode** this sets how many bars are shown across the page in a new layout.

NOTE

When using the **Auto Layout** function, you will be asked for the maximum number of bars across the page, overriding this setting.

Scores - Note Layer

When you are moving and editing notes, you might accidentally move other objects nearby. To avoid this, you can assign different types of objects to different note layers (up to 3) and instruct Nuendo to lock one or 2 of these layers, making them unmovable.

This page is where you specify to which layer each object type belongs. The actual locking of layers is done on the extended toolbar of the **Score Editor**.

Transport

This page contains options related to playback, recording, and positioning.

Playback Toggle Triggers Local Preview

Allows you to use **Space** on your keyboard to start/stop local playback of the selected file in the **Sample Editor** or the **Pool**.

When the **Sample Editor** is not open or when there is no audio file selected in the **Pool**, **Space** still toggles the global project playback.

Show Timecode Subframes

Shows subframes for all frame-based display formats.

Timecode Input Scheme

You can enter a timecode value on the **Transport** panel. If you press **Shift - P**, a specific timecode position is focused. Select one of the following options:

- **Full Timecode**
Allows you to enter the timecode as a sequence of numbers. For example, entering **010203** results in **00:01:02:03**.
- **Starting at Hour Position**
Allows you to enter the timecode per entry field, starting with hours.
- **Starting at Minute Position**
Allows you to enter the timecode per entry field, starting with minutes.

Feet'n'Frames Count from Project Start

Always starts time displays and rulers in **Feet+Frames** format with 0'00 at the beginning of the project regardless of any offset settings in the **Project Setup** dialog.

User-definable Frame Rate

Allows you to set the frame rate for the ruler display format **User**.

Return to Start Position on Stop

Automatically sets the project cursor to the position where recording or playback last started when you stop playback.

Stop Playback while Winding

Stops playback when you click **Rewind** or **Fast Forward** on the **Transport** panel.

Wind Speed Options

These options affect the fast forward/rewind speed.

- **Adjust to Zoom** adapts the wind speed to the horizontal zoom factor.

If you zoom in very close for detailed editing, you probably do not want to have a high fast forward/rewind speed. Because of this, the **Speed Factor** does not have any effect in this mode. The **Fast Wind Factor** still applies.

- **Fixed** keeps a fixed wind speed regardless of the horizontal zoom factor.
- **Speed Factor** allows you to set the wind speed. You can set a value between 2 and 50. The higher the value, the faster the wind speed will be.

If **Adjust to Zoom** is activated, this has no effect.

- **Fast Wind Factor** allows you to set the winding speed to a multiple for fast winding.

If you press **Shift** while fast forwarding or rewinding, the wind speed will increase. The increase in speed is a multiple of the **Speed Factor**. Meaning that if you set the **Fast Wind Factor** to 2, the wind speed will be twice as fast. If you set it to 4, the wind speed will be 4 times as fast, etc. You can set a value between 2 and 50.

Cursor Width

Adjusts the width of the project cursor line.

Zoom while Locating in Time Scale

Allows you to zoom in or out by clicking in the ruler and dragging down or up.

Clicking Locator Range in Upper Part of the Ruler Activates Cycle

Allows you to activate/deactivate cycle mode when you click the locator range in the upper part of the ruler.

Locate when Clicked in Empty Space

Allows you to move the project cursor by clicking in an empty area of the **Project** window.

RELATED LINKS

[Setting the Project Cursor](#) on page 273

Transport - Scrub

Scrub Volume

Sets the playback volume for the **Scrub** tool in the **Project** window and audio editors.

NOTE

This does not affect the scrub volume controlled by any connected hardware.

Use High Quality Scrub Mode

Enables effects for scrubbing and uses a higher resampling quality. However, scrubbing will be more demanding on the processor.

Use Inserts While Scrubbing

Allows you to activate insert effects for scrubbing with the shuttle speed control. By default, insert effects are bypassed.

User Interface

This page contains options that allow you to adjust the default user interface colors.

Color Schemes

Allows you to adjust the color scheme for the application and the desktop cover.

- Click one of the colors in the **Choose Color Scheme** section to apply a pre-defined color.
- Click the field in the **Choose Custom Color** section to open the **Color Picker** and select a custom color.

Track & MixConsole Channel Colors

Allows you to set the **Auto Track/Channel Color Mode**, to colorize track controls and **MixConsole** channel controls, and to determine the brightness of selected channels.

Track Type Default Colors

Allows you to set the colors for the different track types.

MixConsole Fader Colors

Allows you to set the colors for the level faders of the channel types in the **MixConsole**.

MixConsole Rack Colors

Allows you to set the colors for the racks in the **MixConsole**.

MixConsole Channel Strip Colors

Allows you to set the colors for the channel strips in the **MixConsole**.

Customizing the User Interface Colors

You can change the color of the Nuendo desktop, the track types, the **Project** window, the editor elements, and **MixConsole** elements.

PROCEDURE

1. In the **Preferences** dialog, select **User Interface > Color Schemes**.
2. Do one of the following:
 - Activate a default color scheme by clicking on it.
 - Click **Choose Custom Color** and in the **Color Picker**, select a new color.

RESULT

The color scheme is instantly applied.

User Interface - Track & MixConsole Channel Colors

Allows you to set the **Auto Track/Channel Color Mode** to colorize track controls and channel faders, and to determine the brightness of selected channels.

Auto Track/Channel Color Mode

Allows you to set an automatic color assignment mode for new tracks or new channels.

Use Track's Default Color

New tracks get the default event color.

Use Previous Track Color

New tracks get the same color as the track above them in the track list.

Use Previous Track Color +1

This is similar to **Use Previous Track Color**, except that new tracks get the next color in the color palette.

Use Last Applied Color

New tracks get the color that you last applied to an event/part.

Use Random Track Color

New tracks get random track colors.

Colorize Tracks and MixConsole Channels

Applies the track/channel color to track/channel controls.

Tracks

Enables the application of the track color to the track controls.

Folder Tracks

Enables the application of the folder track color to the track controls.

MixConsole Channels

Enables the application of the **MixConsole** channel color to the channel controls.

Color Strength

Allows you to adjust the intensity of the color.

Selected Channel Brightness

Allows you to adjust the brightness of the selected **MixConsole** channel.

Show Color for Selected Channel

Colorizes the selected channel and gives it more color strength instead of displaying it in gray.

VST

This page contains settings for the VST audio engine.

Activate 'Link Panners' for New Tracks

Activates **Link Panners** by default for new tracks so that the channel sends section always mirrors the pan settings made in the channel fader section.

Warn if realtime mixdown is required in order to include external plug-in

Shows a warning if a realtime mixdown is required.

Default Stereo Panner Mode

Allows you to specify the default pan mode for inserted audio tracks.

Connect Sends Automatically for Each Newly Created Channel

Automatically connects the send routing for existing FX channels when you create a new audio or group channel.

Instruments use Automation Read All and Write All

If you activate this, the **Read** and **Write** automation status in control panels for VST instruments is affected by **Activate/Deactivate Read for All Tracks** and **Activate/Deactivate Write for All Tracks**.

Mute Pre-Send when Mute

Mutes pre-fader sends when you mute their channels.

Default Send Level

Allows you to specify a default level for your send effects.

Group Channels: Mute Sources as well

Mutes channels that are directly routed to a group channel when you mute the group channel. Channels that were muted prior to the group channel being muted will not remember their mute status and will be unmuted when the group channel is unmuted.

NOTE

This does not affect how mute automation is written.

Delay Compensation Threshold (for Recording)

Minimizes the latency effects of the delay compensation while maintaining the sound of the mix as far as possible. Only plug-ins with a delay higher than this threshold setting are affected by the **Constrain Delay Compensation** function. By default, this is set to 0.0 ms, which means that all plug-ins will be affected. If you feel that a little latency is acceptable, you can raise this threshold value.

NOTE

Nuendo features full delay compensation—any delay inherent in the VST plug-ins you use will automatically be compensated for during playback. However, when you play a VST instrument in real time or record live audio (with monitoring through Nuendo activated), this delay compensation may result in added latency.

Do Not Connect Input/Output Busses When Loading External Projects

Prevents connecting input and output busses to the ASIO ports of your system when loading external projects.

Auto Monitoring

Determines how Nuendo handles monitoring. The following options are available:

- **Manual**
Turns input monitoring on or off when you click **Monitor**.
- **While Record-Enabled**
Connects the audio source to the channel input when you click **Record Enable**.
- **While Record Running**
Switches to input monitoring only during recording.
- **Tapemachine Style**
Activates input monitoring in stop mode and during recording, but not during playback.

NOTE

The automatic monitoring options apply when you monitor through Nuendo, or when you use ASIO Direct Monitoring. If you monitor externally (listen to the input signal from an external mixer, for example), select **Manual** mode and keep all audio **Monitor** buttons turned off in Nuendo.

Warn on Processing Overloads

Shows a warning if the CPU overload indicator on the **Transport** panel lights up during recording.

RELATED LINKS

[Realtime Export](#) on page 1168

VST - Plug-ins

Warn before Removing Modified Effects

Shows a warning if you remove an effect plug-in for which you have made parameter changes.

Open Effect Editor after Loading It

Opens the effect control panel when you load VST effects or VST instruments.

Create MIDI Track when Loading VSTi

Allows you to determine if a MIDI track is created when you add a rack instrument.

- **Always**

A MIDI track is always created.

- **Do not**

No MIDI track is created.

- **Always ask to**

You are asked whether a corresponding MIDI track should be created.

Synchronize Plug-in Program Selection to Track Selection

Synchronizes track and plug-in program selection if you route multiple MIDI tracks to multitimbral instruments.

Suspend VST 3 plug-in processing when no audio signals are received

Suspends VST plug-in processing in passages where no audio is passing through the plug-in. This can improve system performance noticeably.

NOTE

We recommend to leave this option deactivated.

Plug-in Editors “Always on Top”

Always shows the control panels for effect plug-ins and VST instruments on top of other windows.

VST - Control Room

This page contains settings for the **Control Room**.

Show Control Room Volume in Transport Panel

If the **Control Room** is enabled, the **Control Room** volume is shown on the **Transport** panel.

Auto Disable Talkback Mode

Determines if talkback is disabled during recording, during playback and recording, or not at all.

NOTE

Set the Talkback **DIM** level to 0 dB so as not to radically change the mix level when punching in and out of record mode.

Use Phones Channel as Preview Channel

Uses the phones channel for monitoring.

Dim Cue during Talkback

Dims the cue mix heard in a studio by the amount set in the **Talkback Dim** level field in the **Control Room** for as long as the talkback channel is used.

Exclusive Device Ports for Monitor Channels

Makes the port assignment for monitor channels exclusive. If your scenario does not require you to assign ports to several monitor channels, it is recommended to activate this option. This way you can make sure that you do not accidentally assign ports to inputs/outputs and monitor channels at the same time.

NOTE

This setting is saved with the **Control Room** presets.

Reference Level

Allows you to specify the reference level that can be assigned to the **Control Room** level. The reference level is the level that is used in calibrated mixing environments, such as film dubbing stages.

NOTE

You can also manually adjust the reference level in the **Control Room** settings.

Main Dim Volume

Sets the amount of gain reduction applied to the **Control Room** channel when the **DIM** button is activated.

VariAudio

Inhibit warning when changing the Sample Data

Inhibits the message that warns you when you modify audio material that is used in several places in the project.

Inhibit warning when applying Offline Processes

Inhibits the message that warns you when you apply offline processes to audio material that is used in several places in the project.

Video

Extract Audio on Import Video File

Extracts and saves the audio data of imported video files as a separate audio clip.

Thumbnail Memory Cache Size

Allows you to set the size of the thumbnail cache.

Index

Special Characters

élastique algorithm [559](#)

A

AAF files [1299](#)

ACID® loops [606](#)

Action Target [1127](#)

Length [1127](#)

Name [1129](#)

Position [1127](#)

Set Color [1129](#)

Track Operation [1128](#)

Trim [1129](#)

Activate Project [112](#)

Activate Read/Write for all tracks [818](#)

Activate tempo track [1133](#)

Activate this Track

Track Control [123](#)

Adapt to Zoom [86](#)

Grid type [91](#)

ADAT Lightpipe

Synchronization [1207](#)

Add Cycle Marker

Track Control [123](#)

Add Latency to MIDI-Thru Processing [1372](#)

Add Marker

Track Control [123](#)

Add Track dialog [127](#)

Audio tracks [128](#)

Folder tracks [155](#)

FX channel tracks [146](#)

Group channel tracks [143](#)

Instrument tracks [132](#)

Marker tracks [150](#)

MIDI tracks [139](#)

Ruler tracks [152](#)

Sampler tracks [136](#)

VCA fader tracks [148](#)

Adding chords [1054](#), [1057](#)

Addition to Event Name [1362](#)

ADM authoring [769](#)

ADM Authoring for Dolby Atmos [782](#)

Binaural rendering [785](#)

Connecting the Dolby Atmos Renderer [780](#)

Defining objects [777](#)

Dolby Atmos [770](#)

Downmix for monitoring [775](#)

Downmixes for playback [784](#)

Exporting ADM files [1306](#)

External Dolby Atmos Renderer Setup [780](#)

External OSC Renderer Setup [789](#)

External renderers [777](#)

Multi-objects [777](#)

ADM authoring (*continued*)

Object busses [778](#)

Object groups [786](#)

Object mapping [777](#)

Object-based mixing [787](#)

OSC protocol [788](#)

Playback metadata [784](#)

Renderer for Dolby Atmos [775](#)

Setup for content in OSC format [789](#)

Setup for Dolby Atmos content [771](#)

Setup for object-based mixing in OSC format [789](#)

Trim and Downmix Editor [784](#)

VST MultiPanner [751](#)

VST MultiPanner in object mode [787](#)

ADM files [1304](#)

Exporting [1306](#)

Importing [1305](#)

ADR [390](#)

Defining takes [397](#)

Modes [390](#)

Record [400](#)

Record-enabling target tracks [399](#)

Rehearse [399](#)

Review [400](#)

Routing [398](#)

Setting up [396](#)

Show Dialogue [399](#)

Video overlays [398](#)

ADR environment

Setting up [397](#)

ADR panel [390](#), [392](#)

ADR Setup [393](#)

ADR Track Assignment [397](#)

AES/SPDIF Digital Audio

Synchronization [1207](#)

AES17

Meters [497](#)

AES31 files [1290](#)

AIFF files [1179](#)

Algorithms

Limitations [561](#)

Time-stretching [559](#)

Aligning

Tempo matching audio [220](#)

Using modifier keys [222](#)

Aligning audio

Tempo matching [220](#)

To other audio events [224](#)

To selection ranges [224](#)

To the cursor [225](#)

Alignment level (Meters) [493](#)

All MIDI Inputs [25](#)

Allow Editing in Results List [1370](#)

Alternative Key Sets [1319](#)

- Ambisonics [792](#)
 - Binaural playback [795](#), [799](#), [800](#)
 - Bypassing head tracking [801](#)
 - Editing [792](#)
 - Exporting [803](#)
 - Format conversion [795](#)
 - Format converter [804](#)
 - GoPro Player VR Remote [802](#)
 - Head-Locked Signal [801](#)
 - HRTF [795](#)
 - IMMERSE profiles [795](#)
 - Mixing [792](#)
 - Monitoring [795](#)
 - Monitoring via headphones [799](#)
 - Monitoring via speakers [800](#)
 - Panner plug-ins [793](#)
 - Playback [795](#)
 - Routing [792](#), [793](#)
 - Side-chain input [801](#)
 - Third-party plug-ins [800](#)
 - VST AmbiConverter [804](#)
 - VST MultiPanner [794](#)
- Appearance
 - Colors [1376](#)
 - Metering [1371](#)
- ARA [649](#)
 - Events [652](#)
 - Selecting a plug-in [649](#)
- Archive
 - Prepare [115](#)
- Arranger track
 - Flattening [354](#), [356](#)
 - Inspector [158](#)
 - Track controls [159](#)
- Articulations [1016](#), [1019](#)
 - Adding sound slots [1018](#)
 - Editing on the info line [1025](#)
 - Groups [1020](#)
 - Inserting on the controller lane [1024](#)
 - Mapping sound slots [1020](#)
 - Remote settings [1021](#)
 - Set Remote Keys [1022](#)
- ASIO Direct Monitoring [24](#), [296](#)
- ASIO Latency Compensation
 - Track Control [123](#)
- ASIO Latency Compensation Active by Default [1372](#)
- ASIO-Guard [1352](#)
- Aspect ratio
 - Video Player window [1240](#)
- Assigning chords to Chord Pads [1080](#)
- Assigning chords with the Chord Editor [1081](#)
- Attribute Filter
 - Applying in the MediaBay [727](#)
 - Context menu search [727](#)
 - MediaBay [726](#)
- Attribute Inspector
 - MediaBay [729](#)
- Attributes [728](#)
 - Defining [732](#)
 - Editing in the MediaBay [729](#)
 - Managing lists [731](#)
 - MediaBay [726](#)
- Attributes for elements
 - Pool [691](#)
- Audio
 - Handling [209](#)
 - Placing to picture [1259](#)
 - Pull-down [1268](#)
 - Pull-up [1268](#)
 - Rendering [1156](#)
 - Zooming [86](#)
- Audio Alignment [220](#)
 - Audio Alignment Panel [220](#)
- Audio Assets
 - Exporting [573](#)
 - Exporting to a Game Audio Engine [572](#)
- Audio Click
 - Render [286](#)
- Audio clock
 - Synchronization [1207](#)
- Audio Connections [28](#)
 - Editing [44](#)
 - Exclusive port assignment [480](#)
 - Presets [36](#)
- Audio Definition Model. *See* ADM authoring
- Audio editing to picture [1246](#)
- Audio effects
 - Surround [740](#)
- Audio events [208](#)
 - Aligning [224](#), [225](#)
 - Auditioning [214](#)
 - Processing with ReConform [1284](#)
- Audio Events
 - Inverting phase [239](#)
- Audio files
 - Previewing in MediaBay [718](#)
- Audio Files
 - Inverting phase [239](#)
- Audio Functions [562](#)
 - Detect Silence [562](#)
 - Spectrum Analyzer [565](#)
 - Statistics [567](#)
- Audio hardware
 - Connections [17](#)
 - Externally clocked [22](#)
- Audio Part Editor
 - Lower zone [75](#)
- Audio parts
 - Aligning [224](#), [225](#)
 - Auditioning [214](#)
 - Creating [212](#)
- Audio performance
 - Optimizing [1350](#)
- Audio Pre-Record Seconds [1372](#)
- Audio processing
 - Pool [693](#)
- Audio Processing
 - Direct Offline Processing [534](#)
- Audio Recording [299](#)
 - Downmix [300](#)
 - Pre-Record Time [301](#)
 - Preparations [298](#)
 - RAM Requirements [298](#)
 - Record File Format [297](#)
 - Record Folder [297](#)

-
- Audio Recording (*continued*)
 - Record Modes 299
 - Recovering 301
 - Recovering recordings 301
 - Undo 300
 - With Effects 299
 - Audio regions 211
 - Audio snippet markers 1285
 - Audio System 18
 - Audio tracks 128
 - Add Track dialog 128
 - Inspector 130
 - Audition
 - VariAudio 620
 - Audition chords 1059
 - Audition through MIDI Inserts/Sends 1367
 - Auditioning
 - Audio events 214
 - Audio parts 214
 - Using key commands 688
 - Auto Disable Talkback Mode 1380
 - Auto Edit (9-Pin) 1218
 - Auto fades
 - Global settings 349
 - Track settings 349
 - Auto join
 - Automation 824
 - Auto Monitoring
 - Manual 1378
 - Tapemachine Style 1378
 - Auto Punch
 - Preview options 828
 - Auto Save 114, 1365
 - Auto Save Internal 1365
 - Auto Select Controllers 945
 - Auto Select Events under Cursor 1356
 - Auto Track/Channel Color Mode 1377
 - Auto-Scroll 274
 - Crossfades 341
 - Suspend 274
 - Automatable parameters
 - Controlling with Quick Controls 862
 - Automatic Hitpoint Detection
 - Enabling 1357
 - Automatic scales 1060
 - Automatic voicings 1063
 - Automatically generating new audio clips
 - Pool 695
 - Automation 805
 - Activating Gaps 826
 - Activating Loop 826
 - Activating Preview 827
 - Activating To End 825
 - Activating To Punch 825
 - Activating To Start 825
 - Auto join 824
 - Bézier curves 809
 - Bottom-Top Panning 751
 - Continuous fill 826
 - Drawing Fill manually 827
 - Elevation patterns 761
 - Fill options 825
 - Freeze Trim 822
 - Automation (*continued*)
 - Functions pop-up menu 822
 - Initial value 815
 - Join now 824
 - Join options 823
 - Merge Modes 942
 - One Shot 826
 - Preview options 827
 - Punch Log 829
 - Quick scaling 811
 - Ramp curves 805
 - Read 805
 - Show options 830
 - Smooth transitions 809
 - Static value line 805
 - Step curves 805
 - Suspend options 829, 830
 - Suspend Read 829
 - Trim 821
 - Virgin territory 815
 - VST MultiPanner 755
 - Write 805
 - Automation data
 - Cleaning 813
 - Deleting Automation Spikes 813
 - Editing 808
 - Reducing Automation Events 813
 - Removing 812, 813
 - Selecting 809
 - Automation Event Editor
 - Compress Left 810
 - Compress Right 810
 - Move Vertically 810
 - Scale Around Absolute Center 810
 - Scale Around Relative Center 810
 - Scale Vertically 810
 - Stretch 810
 - Tilt Left 810
 - Tilt Right 810
 - Automation Follows Events 1356
 - Automation modes 818
 - Auto-Latch 820
 - Cross-over 820
 - Touch 819
 - Automation panel 816
 - Read buttons 818
 - Write buttons 818
 - Automation Panel 817
 - Operations tab 817
 - Automation parameter
 - Track Control 123
 - Automation passes 830
 - Activating 831
 - Deactivating undo branches 832
 - Undoing 831
 - Undoing branches 831
 - Automation tracks 814
 - Assigning parameters 814
 - Hiding 814
 - Muting 815
 - Removing 814
 - Showing 814
 - Automation warning markers 1285

B

- Back up Project 115
- Background Color Modulation 1362
- Bank assignments 892
- Batches Processing
 - Direct Offline Processing 544
- Beat Calculator 1142, 1143
- Bézier curves
 - Automation 809
 - Continuous controllers 939
- Binaural playback 795
- Bounce MIDI 905
- Bounce Selection 209
- Branches
 - Undo history 94
- Broadcast Wave files 1178
- Broadcast Wave Files
 - Embedded information 1372
- Buffer
 - Settings 1351
- Bulk Dumps 1009
- Busses
 - Adding 35
 - Child busses 35
 - Removing 44
- Bypass
 - VST MultiPanner 754
- Bypass EQs
 - Track Control 123
- Bypass Inserts
 - Track Control 123
- Bypass Sends
 - Track Control 123

C

- Cadence mode
 - Chord Assistant 1055, 1077
 - Complexity filters 1055, 1077
- Change EDL 1276
 - Adding 1277
 - Deleting 1278
 - Extending entries 1280
 - Generating 1279
 - Healing entries 1280
 - Saving 1279
- Change Release Length
 - Note Expression Event Editor 1042
- Changing object names
 - Pool 680
- Channel
 - Track Control 123
- Channel Configuration
 - Track Control 123
- Channel latencies
 - MixConsole 458
- Channel linking 426
- Channel names
 - Searching 415
- Channel racks 422, 436
 - EQ 442
 - Filters 439

- Channel racks (*continued*)
 - Gain 440
 - Inserts 441
 - Phase 440
 - Pre 439
 - Routing 437
 - Sends 452
 - Strips 445
- Channel settings 459
 - Channel Faders 472
 - Channel Inserts 462
 - Channel Sends 470
 - Channel Strip 463–466
 - Copying 436
 - Direct Routing 471
 - Equalizer 468, 469
- Channel Settings
 - Toolbar 460
- Channel strip rack 445
 - Compressor 445
 - EQ position 445
 - Gate 445
 - Limiter 445
 - Presets 452
 - Saturation 445
 - Transformer 445
- Channel types
 - MixConsole 420
- Channels
 - Adding to link groups 427
 - Color 183
 - Connecting with VCA faders 477
 - Controlling with VCA faders 474
 - Disconnecting from VCA faders 478
 - Linking 424
 - Removing from link groups 427
- Chase Events 287, 1367
- Child busses 35
 - Surround configurations 744
- Chord Assistant 1055, 1076
 - Assigning chords 1081, 1082
 - Cadence mode 1055, 1077
 - Circle of Fifths 1076, 1079
 - Common notes mode 1055, 1077
 - Complexity 1055, 1077
 - Gap mode 1055, 1077
 - Proximity 1076, 1079
- Chord Editor 1053
 - Adding chords 1057
 - Assigning chords 1081
 - MIDI Input 1055
- Chord events 1053
 - Adding 1054
 - Adding chords 1054
 - Assigning to MIDI effects or VSTis 1066
 - Auditioning 1059
 - Chord type 1053
 - Converting to MIDI 1065
 - Editing 1054
 - Extracting from MIDI 1071
 - Getting suggestions 1057
 - Resolving Display Conflicts 1060

- Chord events (*continued*)
 - Tension [1053](#)
 - Voicings [1062](#)
- Chord Font [1363](#)
- Chord Pad Controls [1075](#)
- Chord Pads [1073](#), [1075](#), [1076](#)
 - Adaptive voicing [1088](#)
 - Assigning chords [1080–1083](#)
 - Context menu [1075](#)
 - Controls [1076](#)
 - Copying Assignments [1084](#)
 - Creating chord events [1100](#)
 - Creating MIDI parts [1100](#)
 - Custom Section Player [1092](#)
 - Functions menu [1076](#)
 - Multiple tracks [1090](#)
 - Pad Remote Control [1095](#)
 - Pads remote range [1097](#)
 - Pattern player [1090](#)
 - Player Articulations [1092](#)
 - Player Modes [1087–1089](#), [1091](#)
 - Player Remote Control [1097](#)
 - Player Setup [1087](#)
 - Players [1088](#)
 - Playing back [1084](#)
 - Playing back sections [1093](#)
 - Presets [1099](#)
 - Recording chords [1086](#)
 - Saving presets [1100](#)
 - Setting up [1076](#)
 - Swapping Assignments [1083](#)
 - Voicings [1088](#)
 - Zone [1076](#)
- Chord Pads Setup
 - Pad layout [1099](#)
 - Remote Control [1094](#)
- Chord Pads Zone [1073](#)
- Chord symbols [1363](#)
- Chord track [159](#), [1052](#)
 - Assign Pads [1083](#)
 - Controlling MIDI or audio playback [1068](#)
 - Inspector [160](#)
 - Live input [1068](#)
 - Track controls [161](#)
- Chord voicing
 - Changing [974](#)
- Chords
 - Changing pitch [974](#)
 - Changing voicing [974](#)
 - Editing [975](#)
 - Inserting [976](#)
- Click Pattern [277](#)
 - Setting up [279](#)
 - Signature events [279](#)
- Click Pattern Editor [278](#)
- Click Sounds
 - Custom Sounds [284](#)
- Click Track
 - Render [286](#)
- Clip editing
 - Pool [688](#)
- Clip packages [210](#)
 - Creating (Exporting) [246](#)
 - Importing [318](#)
- Clips
 - Renaming [680](#)
- Color
 - Auto Track/Channel Color Mode [183](#)
- Color Picker [101](#)
- Color Set [99](#)
- Colorize Only Folder Track Controls [1377](#)
- Colorize Track Controls [1377](#)
- Colorizing
 - Events [96](#)
 - Note events [914](#)
 - Select Color for Selected Tracks or Events [95](#), [96](#)
 - Single Tracks [95](#)
 - Tracks [95](#)
- Colors
 - MixConsole Channels [457](#)
 - Preferences [1376](#)
 - Tracks [96](#), [98](#)
 - User Interface [1377](#)
- Colors for Additional Meanings
 - Scores [1373](#)
- Colors Setup Dialog
 - Events [915](#)
 - Project [98](#)
- Combine Selection Tools [215](#)
 - Object Selection [215](#)
 - Range Selection [215](#)
- Common notes mode
 - Chord Assistant [1055](#), [1077](#)
 - Complexity filters [1055](#), [1077](#)
- Complexity filters
 - Cadence mode [1055](#), [1077](#)
 - Common notes mode [1055](#), [1077](#)
- Compress Left
 - Automation Event Editor [810](#)
 - Tempo Event Editor [1136](#)
- Compress Right
 - Automation Event Editor [810](#)
 - Tempo Event Editor [1136](#)
- Compressor
 - Strip module [445](#)
- Configuration
 - Preferences [1356](#)
- Conforming
 - Audio to picture [1247](#)
 - EDL files [1254](#)
 - Multi-channel media [1255](#)
 - OMF [1255](#)
- Connect Sends automatically for each newly created Channel [1378](#)
- Connecting
 - Audio [17](#)
 - MIDI [24](#)
- Constrain Delay Compensation [846](#)
- Continuous controllers
 - Adding in controller display [938](#)
 - Controller display [928](#)
 - Controller lane [938](#)
 - Ramp/Step [939](#)
 - Smooth transitions [939](#)

- Continuous Fill
 - Fill options 826
 - Control link 424, 426
 - Control Room 479
 - Adding channels 479
 - Channels section 484
 - Cue channels 484
 - Downmix Presets section 486
 - Exclusive port assignment 480
 - External section 483
 - Input gain 489
 - Input phase 489
 - Insert effects 489
 - Inserts 489
 - Main 482
 - Main mix output 480
 - Monitor Sources section 483
 - Monitors section 485
 - Opening 479
 - Outputs 480
 - Phones section 486
 - Right zone 83
 - Routing 480
 - Control Room channels 480, 484
 - Adding 479
 - Control Room 487
 - Cues 481
 - External inputs 481
 - Metering 482
 - Monitor sources 481
 - Monitors 480, 489
 - Phones 481
 - Talkback 482, 489
 - Control Room Volume
 - Showing in Transport Panel 1380
 - Controller curves
 - Smart controls for scaling 944
 - Controller Data
 - Thinning Out 910
 - Controller display 921
 - Adding events 930, 938
 - Continuous controllers 928
 - Editing events with Line tool 942
 - Moving events 945
 - Controller Event Editor 944
 - Controller events 1027
 - Controller lane
 - Adding 926
 - Continuous controllers 938
 - Inserting articulations 1024
 - Presets 929
 - Removing 926
 - Selecting event types 927
 - Setting up as preset 929
 - Controller lanes 924
 - Setup 923
 - Controller Selection and Functions 924
 - Controllers
 - Selecting 945
 - Showing 1364
 - Convert to Real Copy 236
 - Converting chord events to MIDI 1065
 - Counter shots
 - VST MultiPanner 759
 - Create Audio Images during Record 1372
 - Create Chord Symbols 1071
 - Create MIDI track when loading VSTi 1379
 - Creating gaps
 - Automation 815
 - Cross-hair cursor 92, 1361
 - Crossfades
 - Auto Zoom 341
 - Auto-Scroll 341
 - Changing the length 346
 - Creating 340
 - Editing in dialog 341
 - Equal Gain 341
 - Equal Power 341
 - Move Audio 345
 - Move Fade 345
 - Nudging 345
 - Overlap 344
 - Presets 341
 - Resizing 346
 - Simple Crossfade Editor 341
 - Splice Point 344
 - Symmetric Fades 341
 - CSV files 383
 - Cue Mix
 - Setting up 491
 - Cue Sends 492
 - Adjusting the volume 492
 - Cue mix 491
 - Cue Sheets 1292
 - Cursor Width 1375
 - Custom Chord Symbols 1363
 - Customizing
 - Colors 101
 - Info line 1338
 - Inspector 1338
 - Menu 1340
 - Meter Colors 433
 - Toolbars 1338
 - Transport panel 1338
 - User Interface Colors 1377
 - Cut Head 234
 - Cut Tail 234
 - Cycle
 - Track Control 123
 - Cycle Follows Range Selection 1356
 - Cycle markers 368
 - Editing with tools 369
 - Using 369
 - Zooming 88, 369
 - Cycle recording 293
- ## D
- Data on Folder Tracks
 - Showing 1364
 - DC Offset
 - Removing 554
 - Deactivate Read/Write for all tracks 818
 - Deactivating undo branches
 - Automation 832

- Deep Track Folding [1360](#)
- Default MIDI Editor [1361](#)
- Delay compensation
 - Constraining [846](#)
 - Threshold for Recording [1378](#)
- Delete Notes
 - Dialog [918](#)
- Delete Overlaps [1356](#)
- Deleting
 - Continuous Controllers [909](#)
 - Controllers [909](#)
 - Doubles [909](#)
 - MIDI controllers [909](#)
- Deleting Overlaps
 - Poly (MIDI) [908](#)
 - Poly (Mono) [908](#)
- Designating a new pool record folder
 - Pool [692](#)
- Detect Silence
 - Audio Functions [562](#)
- Device panels [897](#)
- Device ports
 - Selecting for busses [35](#)
- Dim Cue during Talkback [1380](#)
- Direct Offline Processing [534](#)
 - Applying [540](#)
 - Applying permanently [547](#)
 - Applying to multiple events [541](#)
 - Auto Apply [536](#)
 - Batches [544](#)
 - Bypassing [546](#)
 - Copying [547](#)
 - Deleting [545](#)
 - Envelope [548](#)
 - Extend Process Range [545](#)
 - Fade In [549](#)
 - Fade Out [549](#)
 - Favorites [542](#)
 - FX Chain presets [544](#)
 - Gain [549](#)
 - Invert Phase [550](#)
 - Key Commands [557](#)
 - Modifying [545](#)
 - Normalize [550](#)
 - Pitch Shift [551](#)
 - Pool [693](#)
 - Remove DC Offset [554](#)
 - Resample [554](#)
 - Resetting [545](#)
 - Reverse [555](#)
 - Silence [555](#)
 - Stereo Flip [555](#)
 - Tail [545](#)
 - Time Stretch [555](#)
 - Toolbar [538](#)
 - Track Presets [544](#)
 - Window [536](#)
 - Workflow [535](#)
- Direct Routing [454](#)
 - Automatic downmixing [455](#)
 - Setting up [454](#)
- Disable Acoustic Feedback during Playback [1358](#)
- Display format
 - Ruler [60](#)
- Display line
 - Fader section [425](#)
- Dissolve markers [1285](#)
- Dithering
 - Applying [523](#)
 - Effects [523](#)
- Divider
 - Project window toolbar [56](#)
- Dolby Atmos
 - ADM authoring [770](#)
 - ADM Authoring [782](#)
 - ADM files [1304](#)
 - Bed mixing [751](#)
 - Beds [772](#)
 - Binaural rendering [785](#)
 - Channel routing [771](#)
 - Connecting objects to output busses [778](#)
 - Connecting the Dolby Atmos Renderer [780](#)
 - Content creation [770](#)
 - Defining objects [777](#)
 - Device port mapping [780](#)
 - Downmix for monitoring [775](#)
 - Downmixes for playback [784](#)
 - External Dolby Atmos Renderer Setup [780](#)
 - External renderers [777](#)
 - Multi-object busses [779](#)
 - Multi-objects [777](#)
 - Object groups [786](#)
 - Object mapping [777](#)
 - Object-based mixing [787](#)
 - Output busses [771](#)
 - Playback metadata [784](#)
 - Preparations [771](#)
 - Renderer for Dolby Atmos [775](#)
 - Routing for beds [772](#)
 - Setup for object-based mixing for Dolby Atmos [771](#)
 - Supported channel configurations for beds [772](#)
 - Trim and Downmix Editor [784](#)
 - VST MultiPanner [751](#)
 - VST MultiPanner in object mode [787](#)
- Drag Delay [1356](#)
- Draw tool
 - Drawing note events [970](#)
- Drop-Frame
 - Video [1247](#)
- Drum Editor [979](#)
 - Info line [987](#)
 - Lower zone [75](#)
 - Note display [988](#)
 - Status line [986](#)
 - Toolbar [981](#)
- Drum Map
 - Track Control [123](#)
- Drum maps [993](#), [996](#)
 - Key Editor [977](#)
 - Selecting [990](#)
 - Setting up [994](#), [995](#)
- Drum notes
 - Deleting [992](#)

- Drum sounds [989](#)
 - Changing the Note Length [992](#)
 - Setup [989](#)
 - Visibility [990](#)
- Drum Sounds
 - Settings [995](#)
- Drum Visibility Agents [981](#)
- Dump request messages
 - MIDI SysEx Editor [1009](#)
- Duplicating
 - Events [235](#)
- Dynamics
 - Editing [934](#)
- E**
- Edit Channel Settings
 - Track Control [123](#)
- Edit Decision Lists [381](#)
- Edit History dialog [92](#)
 - Branches [94](#)
- Edit In-Place
 - Track Control [123](#)
- Edit Instrument
 - Track Control [123](#)
- Editing
 - Project window info line [62](#)
- Editing events
 - Group editing [238](#)
- Editor Content Follows Event Selection [1361](#)
- EDL
 - Adding for ReConform process [1277](#)
 - Changing timecodes with ReConform [1278](#)
 - Deleting for ReConform process [1278](#)
 - ReConform [1274](#)
- EDL entries
 - Extending with ReConform [1280](#)
- EDL files [381](#)
- Effect parameters
 - Track Quick Controls [860](#)
- Effect Plug-in Presets
 - Loading in MediaBay [734](#)
- Effects [502](#)
 - Channel configuration [509](#)
 - Comparing settings [526](#)
 - Context menu [525](#)
 - Control panel [523](#)
 - Direct Offline Processing [534](#)
 - Dithering [523](#)
 - External effects [523](#)
 - Functions menu [525](#)
 - Insert effects [502](#), [504](#)
 - Multi-channel configurations [509](#)
 - Plug-in delay compensation [504](#)
 - Pre/Post fader sends [516](#)
 - Presets [527](#)
 - Presets browser [527](#)
 - Routing [510](#), [516](#)
 - Saving presets [529](#)
 - Selecting presets [528](#)
 - Send effects [502](#), [513](#)
 - Setting up the channel configuration [509](#)
 - Side-chain inputs [519](#)
- Effects (*continued*)
 - Side-chain routing [521](#)
 - System component information [532](#), [533](#)
 - Tempo sync [504](#)
 - Track presets [531](#)
 - VST 3 [503](#)
- Enable Record on Selected Audio Track [1360](#)
- Enable Record on Selected MIDI Track [1360](#)
- Enable Solo on Selected Track [1360](#)
- Enlarge Selected Track [185](#), [1360](#)
- Envelope
 - Direct Offline Processing [548](#)
 - Realtime processing [349](#)
- Envelope editor
 - Sampler Control [664](#)
- EQ
 - Channel racks [442](#)
 - Presets [445](#)
- EQ position
 - Strip module [445](#)
- Equal Gain
 - Crossfades [341](#)
- Equal Power
 - Crossfades [341](#)
- Equalizer
 - Activate Channel Comparison [469](#)
- Equalizer settings [469](#)
- Event Details
 - Showing [1364](#)
- Event display [58](#)
 - Editing events [1008](#)
 - Folder tracks [189](#)
 - Modifying on folder tracks [189](#)
 - Project Browser [1153](#)
- Event Handling Opacity [1362](#)
- Event lengths
 - Changing with Trim tool [973](#)
- Event list
 - Editing events [1008](#)
 - Filtering events [1008](#)
- Event name
 - Showing [1362](#)
- Event Opacity [1362](#)
- Event Volume Curves
 - Showing [1362](#)
- Events [208](#)
 - Arranging at a Specific Distance [219](#)
 - Combine Selection Tools [215](#)
 - Copying and Pasting [234](#)
 - Creating new files from events [209](#)
 - Displaying on folder tracks [189](#)
 - Duplicating [235](#)
 - Editing [213](#)
 - Envelopes [349](#)
 - Gluings [234](#)
 - Group editing [238](#)
 - Grouping [237](#)
 - Locking [238](#), [239](#)
 - Move to [218](#)
 - Moving [217](#), [219](#)
 - Moving via info line [219](#)
 - Moving with Nudge [218](#)
 - Moving with Object Selection [218](#)

- Events (*continued*)
 - Muting 240
 - Normal resizing 215, 229
 - Pasting 234
 - Removing 217
 - Renaming 225
 - Renaming from list 225
 - Repeating 235
 - Resizing 228
 - Resizing with Object Selection 215, 229, 230
 - Resizing with Scrub 231
 - Resizing with Trim 230
 - Setting a spacer between events 219
 - Sizing Applies Time Stretch 230
 - Sizing Moves Contents 229
 - Sliding the contents 237
 - Splitting 231
 - Splitting repeatedly 232
 - Exclusive Device Ports for Monitor Channels 1380
 - Export Audio Mixdown 1162, 1171, 1173, 1174
 - AIFF files 1179
 - Broadcast Wave files 1178
 - Channel selection 1176
 - Export jobs 1176
 - Export Queue section 1174
 - File Formats 1177
 - Flac files 1182
 - Mixing down to multiple files 1173
 - MP3 files 1181
 - MXF files 1181
 - Ogg Vorbis files 1183
 - Surround mixes 769
 - Wave files 1178
 - Export jobs 1173, 1176
 - Updating 1174
 - Export queue 1174
 - Export Video 1241
 - Export Video dialog 1242
 - Exporting
 - AAF 1299
 - ADM files 1306
 - AES31 1290
 - Cue Sheets 1292
 - MIDI files 177
 - OMF 1295
 - Profiles 1345
 - Selected tracks 176
 - Track archives 176
 - Tracks 176
 - Video files 1244
 - Expression Map Setup 1016
 - Expression maps 1015
 - Creating 1018
 - Extracting from VST instruments 1022
 - Inspector 1017
 - List Editor 1026
 - Loading 1023
 - Project window 1017
 - Saving 1023
 - Score Editor 1025
 - Setup 1016
 - Extensions 649
 - Activating 649
 - Add Events 651
 - Editor 650
 - Handling events in the Project window 652
 - Remove Events 651
 - External Dolby Atmos Renderer Setup 780
 - External effects 37, 523
 - Favorites 42
 - Freezing 43
 - Missing plug-ins 43
 - Setting up 38
 - External instruments 37
 - Favorites 42
 - Freezing 43
 - Missing plug-ins 43
 - Setting up 41
 - External monitoring 295
 - External OSC Renderer Setup 789
 - Extract Audio on Import Video File 1381
 - Extract MIDI from Audio 635
 - Extracting
 - Audio from video 317, 1244
 - MIDI Automation 910
 - Extracting chord events from MIDI 1071
- ## F
- Fade Handle Brightness 1362
 - Fade In
 - Direct Offline Processing 549
 - Fade In dialog 338
 - Fade Out
 - Direct Offline Processing 549
 - Fade Out dialog 338
 - Fader section (MixConsole) 429
 - Fades
 - Apply defaults 337
 - Auto fades 347
 - Editing in dialog 338
 - Presets 338
 - With Range Selection tool 337
 - Favorites
 - Adding 706, 712
 - Direct Offline Processing 542
 - Media rack 705
 - Feet'n'Frames Count from Project Start 1375
 - Field recorder data 1248
 - Metadata Retrieval 1250
 - File Browser
 - Media rack 705
 - File Extensions
 - Showing in Results list 1370
 - File format presets 1184
 - Fill Loop 237
 - Film Transfers 1265
 - Filter Target
 - Color Name 1124
 - Combining Condition Lines 1125
 - Combining Filter Types 1120
 - Container Type 1119, 1120
 - Length 1122, 1123
 - Media Type 1118

- Filter Target (*continued*)
 - Name [1121](#)
 - Position [1121](#), [1122](#)
 - Property [1124](#)
 - Find Tracks [59](#)
 - Fixed lengths [906](#)
 - Fixed tempo
 - Mode [1132](#)
 - Fixed Tempo
 - Mode [1141](#)
 - Setting up [1141](#)
 - Fixed velocity [907](#)
 - Flac files [1182](#)
 - FLAC files
 - Importing [314](#)
 - Flattening
 - Arranger track [354](#), [356](#)
 - Realtime Processing [612](#), [637](#)
 - Folder parts [213](#)
 - Folder tracks [154](#)
 - Add Track dialog [155](#)
 - Displaying events [189](#)
 - Inspector [156](#)
 - Modifying event display [189](#)
 - Track controls [157](#)
 - Follow Chord Track [1069](#)
 - Auto [1069](#)
 - Chords [1069](#)
 - Directly [1070](#)
 - Scale events [1070](#)
 - Single Voice [1069](#)
 - Synchronizing Track Data [1070](#)
 - Using [1068](#)
 - Formant Shifting
 - VariAudio [632](#)
 - Frame count [1205](#)
 - Frame rates
 - Drop-Frame [1247](#)
 - Mismatch [1237](#)
 - Synchronization [1205](#)
 - Video [1237](#)
 - Frames
 - Subframes [1246](#)
 - Free Run mode
 - ADR [390](#)
 - Freeze
 - VST instruments [845](#)
 - Freeze Channel
 - Track Control [123](#)
 - Freeze MIDI Modifiers [886](#)
 - Freeze Trim
 - Automation [822](#)
 - Further Addition to Event Name [1362](#)
 - FX chain presets [442](#)
 - FX Chain presets
 - Direct Offline Processing [544](#)
 - FX Chain Presets
 - Loading in MediaBay [734](#)
 - FX channel tracks [145](#)
 - Add Track dialog [146](#)
 - Adding [514](#), [515](#)
 - Inspector [147](#)
 - Setting up [37](#)
 - FX Plug-in Presets
 - Loading in MediaBay [734](#)
- ## G
- Gain
 - Direct Offline Processing [549](#)
 - Game Audio Connect [569](#)
 - Exporting Audio Assets [572](#), [573](#)
 - Network Communication [571](#)
 - Perforce [571](#)
 - Renaming assets [572](#)
 - Renaming events [225](#)
 - Settings Dialog [570](#)
 - Gap mode
 - Chord Assistant [1055](#), [1077](#)
 - Gaps
 - Fill options [826](#)
 - Gate
 - Strip module [445](#)
 - Generate Harmony Voices [613](#), [637](#), [638](#)
 - Generic Remote [869](#)
 - Global track controls [58](#)
 - Find Tracks [59](#)
 - Track Type Filter [59](#)
 - Global tracks
 - Key Editor [956](#)
 - Keyboard focus [965](#)
 - Showing in the Key Editor [963](#)
 - Global workspaces [1335](#)
 - Gluing
 - Events [234](#)
 - GoPro Player VR Remote [802](#)
 - Grid Overlay Intensity [1362](#)
 - Grid type
 - Project window [91](#)
 - Groove quantizing [327](#)
 - Group channel tracks [142](#)
 - Add Track dialog [143](#)
 - Inspector [144](#)
 - Group channels
 - Adding insert effects [506](#)
 - Adding to selected channels [506](#)
 - Routing [439](#)
 - Setting up [37](#)
 - Group Channels - Mute Sources as well [1378](#)
 - Group editing [238](#)
 - Group Editing
 - Track Control [123](#)
 - Grouping events [237](#)
 - Guide track
 - ADR [396](#)
- ## H
- Hardware controls
 - Activating pick-up mode [864](#)
 - Hardware setup
 - Control panel [18](#)
 - Healing
 - ReConform [1280](#)
 - Hermod tuning [885](#)
 - Hide muted Notes in Editors [1358](#)

- Hide Truncated Event Names [1362](#)
- High Quality Scrub Mode [1376](#)
- History
 - Edit History [92](#)
 - MixConsole [409](#), [416](#)
 - Project window [48](#)
- Hitpoints [596](#)
 - Showing [1362](#)
- HMT Type
 - Hermod tuning [886](#)
- Horizontal Snap
 - Note Expression Event Editor [1042](#)
- Horizontal zoom
 - Sample Editor [586](#)
- HRTF [795](#)
- Hub [103](#)
 - Deactivating [104](#)
 - Using [1365](#)
- I**
- I-notes (Input notes) [997](#)
- IMMERSE profiles [795](#)
- Immersive video playback [802](#)
- Importing
 - AAF [1299](#)
 - ADM files [1305](#)
 - AES31 [1290](#)
 - Audio files [313](#), [1249](#)
 - Audio from video files [317](#)
 - Compressed audio files [313](#)
 - Events [171](#)
 - Field recorder data [1249](#)
 - FLAC files [314](#)
 - Location sound [1249](#)
 - MIDI files [177](#), [319](#)
 - MP3 files [314](#)
 - MPEG files [314](#)
 - MXF [1306](#)
 - Ogg Vorbis files [314](#)
 - OMF files [1295](#)
 - Production sound [1249](#)
 - Profiles [1345](#)
 - REX files [317](#)
 - Track archives [173](#)
 - Track settings [171](#)
 - Tracks from a track archive [171](#), [173](#)
 - Tracks from projects [171](#), [172](#)
 - Video files [1236](#)
 - WMA files [314](#)
- In-Place Editor
 - Editing controllers [1012](#)
 - Editing MIDI notes [1012](#)
 - Toolbar [1012](#)
- Independent track loop
 - Audio Part Editor [647](#)
- Independent Track Loop
 - MIDI [921](#)
- Indicate Transpositions
 - Key Editor [365](#)
- Info line
 - Editing articulations [1025](#)
 - Project window [62](#)
 - Transpose [366](#)
- Inhibit warning when applying Offline Processes [1381](#)
- Inhibit warning when changing the Sample Data [1381](#)
- Initial value
 - Automation [815](#)
- Input busses
 - Adding [35](#)
 - Removing [44](#)
 - Renaming [34](#)
 - Routing [438](#)
 - Surround configurations [747](#)
- Input gain
 - MixConsole [440](#)
- Input levels [17](#)
- Input ports [23](#)
- Inputs
 - Meter position options [433](#)
- Insert effects [502](#), [504](#)
 - Adding to busses [505](#)
 - Adding to group channels [506](#)
 - Routing [505](#)
- Insert markers [1285](#)
- Insert MIDI Retrospective Recording in Editor [309](#)
- Insert presets
 - Copying [530](#)
 - Pasting [530](#)
 - Saving [530](#)
- Insert Reset Events after Record [1367](#)
- Inserts
 - FX chain presets [442](#)
 - MIDI [887](#)
 - MixConsole [441](#)
 - Monitor channels [489](#)
 - Talkback channel [489](#)
 - Using while scrubbing [1376](#)
- Inspector [64](#)
 - Editor [66](#)
 - Expression maps [1017](#)
 - Score [67](#)
 - Sections [119](#)
 - Surround Pan [752](#)
 - Switch Score Editor Inspector Content [67](#)
 - Synchronizing track and channel visibility [71](#)
 - Track Inspector [65](#)
 - Visibility [68](#), [69](#)
 - VST MultiPanner [752](#)
 - Zones [71](#)
- Inspector Sections
 - Showing/Hiding [68](#)
- Instrument
 - Track Control [123](#)
- Instrument Freeze [845](#)
- Instrument parameters
 - Track Quick Controls [861](#)
- Instrument presets
 - Applying [203](#)
- Instrument Presets
 - Loading in MediaBay [733](#)
 - Results [843](#)

- Instrument tracks [132](#)
 - Add Track dialog [132](#)
 - Inspector [134](#)
- Instruments use Automation Read All and Write All [1378](#)
- Interpolate Audio Waveforms [1362](#)
- Invert Phase
 - Control Room [489](#)
 - Direct Offline Processing [550](#)
 - Info line [239](#)
 - MixConsole [440](#)
- J**
- Job queues [1173](#), [1174](#)
- Join now
 - Automation [824](#)
- Join options
 - Automation [823](#)
- K**
- Key commands [1313](#)
 - Alternative Key Sets [1319](#)
 - Default [1321](#)
 - Dialog [1313](#)
 - Loading [1318](#)
 - Macros [1315](#)
 - Modifying [1316](#)
 - Removing [1317](#)
 - Resetting [1319](#)
 - Saving [1317](#)
 - Searching for [1316](#)
- Key Editor [945](#)
 - Fold keyboard [961](#)
 - Global tracks [956](#), [963](#)
 - Info line [954](#)
 - Inspector [955](#)
 - Keyboard focus [965](#)
 - Lower zone [75](#)
 - Note display [959](#)
 - Note expression data [977](#)
 - Piano keyboard display [960](#)
 - Pitch Visibility [962](#)
 - Scales [958](#)
 - Status line [954](#)
 - Toolbar [948](#)
 - Visible Pitches [961](#)
- Keyboard focus
 - Activating for a zone [85](#)
 - Zones [84](#)
- Keyboard navigation
 - MixConsole [472](#)
- Knob Mode [1359](#)
- L**
- Lanes [190](#)
 - Assembling a perfect take [190](#)
 - Assembling operations [191](#)
 - Audio Part Editor [645](#)
- Language (Preferences) [1365](#)
- Latch Buffer
 - Note expression [1041](#)
- Latency
 - MixConsole [458](#)
 - Optimizing [1350](#)
 - VST System Link [1226](#)
- Left locator
 - Setting [272](#)
- Left Locator [271](#)
- Left zone [63](#)
 - Inspector [64](#)
 - MixConsole [407](#)
 - Visibility [68](#), [69](#)
 - Zones [71](#)
- Legato [906](#)
- Legato Mode - Between Selected Notes Only [1359](#)
- Legato Overlap [1359](#)
- Length
 - Crossfades [346](#)
- Length Adjustment [1367](#)
- Level meters (MixConsole) [434](#)
- Limiter
 - Strip module [445](#)
- Line tool [972](#)
 - Drawing note events [971](#)
 - Editing controller display events [942](#)
- Linear Time Base [1132](#)
- Link groups [424](#)
 - Adding channels [427](#)
 - Changing settings [426](#)
 - Creating [426](#)
 - Q-Link [427](#)
 - Removing channels [427](#)
 - Settings [424](#)
 - Unlink [426](#)
- Link Project and Lower Zone Cursors [77](#)
- List Editor [998](#)
 - Editing events [1008](#)
 - Editing operations [1007](#)
 - Event display [1006](#)
 - Event list [1005](#)
 - Filters bar [1004](#)
 - Inserting events [1007](#)
 - Showing/Hiding events [1004](#)
 - Status line [1003](#)
 - Toolbar [999](#)
 - Value display [1006](#)
- Listen
 - MixConsole [432](#)
 - Track Control [123](#)
- Live input
 - Chord track [1068](#)
- Loading Multi-Track Presets [205](#)
- Locate
 - Track Control [123](#)
- Locate When Clicked in Empty Space [1375](#)
- Location sound [1248](#)
- Locator Range Duration [273](#)
- Locators [271](#)
 - Setting ranges [273](#)
- Lock
 - Track Control [123](#)
 - Transpose track [364](#)

- Lock Automation
 - Track Control [123](#)
 - Lock Event Attributes [239](#), [1356](#)
 - Lock Punch Points to Locators [276](#)
 - Lock Record [310](#)
 - Logical Editor [1101](#)
 - Actions [1112](#)
 - Functions [1111](#)
 - Searching for highest/lowest notes in chords [1109](#)
 - Logical Filter
 - Advanced Text Search [725](#)
 - Applying [725](#)
 - MediaBay [724](#)
 - Logical Presets [1115](#)
 - Looping
 - Audio Part Editor [647](#)
 - Fill options [826](#)
 - Loops and Samples
 - Loading in MediaBay [733](#)
 - Loudness [493](#), [494](#)
 - LU [494](#)
 - LUFS [494](#)
 - Measuring short-term loudness during playback [499](#)
 - Measuring short-term loudness offline [500](#)
 - Meter [495](#)
 - Normalizing on export [500](#)
 - Settings [497](#)
 - Statistics [567](#)
 - Units [494](#)
 - Loudness track [166](#), [499](#)
 - Lower zone [72](#)
 - Chord Pads [73](#)
 - Editor [75](#)
 - Link Project and Lower Zone Cursors [77](#)
 - MixConsole [74](#)
 - Sampler Control [75](#)
 - Selecting a MIDI editor [76](#)
 - Setting up [73](#)
- ## M
- M&E track
 - ADR [396](#)
 - macOS
 - Port activation [34](#)
 - Port selection [34](#)
 - Macros [1317](#)
 - Key commands [1315](#)
 - Main Dim Volume [1380](#)
 - Main mix
 - Output [480](#)
 - Setting up [35](#)
 - Managing media files
 - Pool [675](#)
 - Map Input Bus Metering to Audio Track [1371](#)
 - Marker lines [368](#), [369](#), [1365](#)
 - Marker track [377](#)
 - Inspector [152](#)
 - Marker tracks [150](#)
 - Add Track dialog [150](#)
 - Marker window [371](#)
 - Functions [372](#)
 - Marker list [372](#)
 - Markers [368](#), [369](#)
 - Adding markers at video cut positions [1255](#)
 - ADR [392](#)
 - Attributes [373](#)
 - CSV files [383](#)
 - Cycle markers [368](#)
 - Exporting [381](#)
 - Exporting CSV files [386](#)
 - Exporting markers as track archive [389](#)
 - Exporting via MIDI [389](#)
 - IDs [377](#)
 - Importing [381](#)
 - Importing an EDL [381](#)
 - Importing markers as track archive [389](#)
 - Importing via MIDI [388](#)
 - Position markers [368](#)
 - ReConform [1285](#)
 - Settings [373](#)
 - Working with EDLs [382](#)
 - Material
 - Preserving with ReConform [1283](#)
 - Max. Record Time Display [310](#)
 - Maximizer
 - Details view [466](#)
 - Edit Module [466](#)
 - Maximum Backup Files [1365](#)
 - Maximum Items in Results List [1370](#)
 - Maximum Undo Steps [1365](#)
 - Media rack
 - Adding Favorites [706](#)
 - Adding VST plug-in pictures [707](#)
 - Favorites [699](#), [705](#)
 - File Browser [700](#), [705](#)
 - Home [697](#)
 - Results [699](#)
 - Right zone [81](#), [82](#)
 - Right Zone [697](#), [699](#)
 - Track Presets [706](#)
 - VST Effects [703](#), [705](#)
 - VST Instruments [702](#), [705](#)
 - MediaBay [697](#)
 - Adding Favorites [712](#)
 - Allow Editing in Results List [730](#)
 - Attribute Filter [726](#), [727](#)
 - Attribute Inspector [728](#), [729](#)
 - Attributes [726](#)
 - Defining user attributes [732](#)
 - Editing attributes [729](#)
 - Editing attributes of multiple files [730](#)
 - File Browser [711](#)
 - Filters [724](#), [726](#)
 - Finding file locations [714](#)
 - Hiding sections [711](#)
 - Instrument Presets [843](#)
 - Logical Filter [724](#), [725](#)
 - Media Type Filter [715](#)
 - Media Types [715](#)
 - Previewer [718](#)
 - Rating filter [716](#)
 - Refresh Views [713](#)

- MediaBay (*continued*)
 - Reset Filter 727
 - Results 713, 714, 718
 - Scanning 711
 - Select Media Type 715
 - Settings 739
 - Show in Explorer/Reveal in Finder 714
 - Showing sections 711
 - Shuffle Results 714
 - Tagging 729
 - Text search 717
 - Toolbar 709
 - Using Media Files 732
 - Volume databases 736–738
 - Window 708
 - Write-protected files 730
- MediaBay results
 - Managing media files 714
 - Resetting 718
 - Setting up 713
 - Shuffling 714
- Merge MIDI in Loop 902, 903
- Metadata
 - Author Name 1367
 - Company Name 1367
- Metadata Retrieval
 - Field recorder data 1250
- Meter
 - Right zone 83
 - Settings 497
- Meter Colors 433
- Meter peak options 433
 - Hold forever 433
 - Hold peaks 433
- Meter position options 433
 - Input 433
 - Post-Fader 433
 - Post-Panner 433
- Meter section
 - MixConsole 493, 494
 - Project window 493
- Metering 493
- Meters
 - AES17 497
 - Alignment level 493
 - Peak meter display 493
 - RMS display 493
 - Scale standards 493
 - Settings 433
- Meters' Fallback 1371
- Meters' Peak Hold Time 1371
- Metronome 277, 281, 282, 284
 - Click Pattern Editor 278, 279
 - Setup window 280
- Metronome Click
 - Setting up 279
- Metronome Setup 280
 - Click Pattern 277
 - Click Patterns 284
 - Click Sounds 282
 - General 281
- Mic Signal Track
 - ADR 396
- MIDI
 - Delete notes 918
 - MIDI channels
 - Send effects 889
 - Separating for drum map sounds 996
 - MIDI Click
 - Render 286
 - MIDI clock
 - Synchronization 1207
 - MIDI Controller Automation 940
 - Setting up 940
 - MIDI controllers
 - Note Expression 1029
 - MIDI Controllers
 - Pitchbend 931
 - MIDI devices
 - Defining new for patch selection 897
 - Device Manager 892
 - Editing patches 897
 - Installing 895
 - Selecting patches 896
 - MIDI Display Resolution 1367
 - MIDI editors
 - Cutting and pasting 914
 - MIDI effects 887
 - Inserts 887
 - Presets 890
 - Sends 889
 - MIDI events 212
 - MIDI Export Options 1368
 - MIDI files 177, 319
 - Previewing in MediaBay 719
 - MIDI Filter 1370
 - MIDI Import Options 1368, 1369
 - MIDI Input
 - Chord Editor 1055
 - VariAudio 625
 - MIDI Inputs
 - Setting up 302
 - MIDI insert effects
 - Recording 888
 - MIDI interface
 - Connecting 24
 - MIDI Latency Mode 1367
 - MIDI Loops
 - Previewing in MediaBay 720
 - MIDI Max. Feedback in ms 1367
 - MIDI Merge Options 903
 - MIDI modifiers 882
 - Hermod tuning 885, 886
 - Random variations 884
 - Range 884
 - MIDI note numbers 995
 - MIDI notes
 - Transpose (function) 901
 - MIDI outputs
 - Send effects 889
 - MIDI pan
 - MIDI track parameters 880
 - MIDI parts
 - Creating 213
 - Handling several 920

- MIDI parts (*continued*)
 - Independent Track Loop 921
 - Processing 913
- MIDI Polyphonic Expression 1029
- MIDI Port Setup 302
- MIDI ports
 - Setting up 25
- MIDI Record Catch Range in ms 1372
- MIDI Record Mode 306
- MIDI Recording
 - Channel and Output 303
 - Continuous messages 305
 - Different types of messages 304
 - Instruments and channels 302
 - MIDI Input setting 302
 - Naming MIDI ports 302
 - Notes 305
 - Preparations 302
 - Program Change Messages 305
 - Record mode 306
 - Recovering 308
 - Recovering in Editor 309
 - Recovering recordings 307
 - Reset 305
 - Sound selection 303
 - System Exclusive Messages 305
- MIDI recordings
 - Exporting to MIDI file 998
- MIDI Retrospective Recording 307
- MIDI SysEx Editor
 - Dump request messages 1009
- MIDI Thru Active 1367
 - Monitoring 296
- MIDI track delay
 - MIDI track parameters 880
- MIDI track parameters 880
- MIDI tracks 139
 - Add Track dialog 139
 - Expression Maps 977
 - Freezing MIDI Modifiers 886
 - Inspector 140
 - Routing to device 1010
- MIDI Velocity
 - Editing 908
- MIDI volume
 - MIDI track parameters 880
- Mirror
 - MIDI 911
- Missing ports
 - Re-routing 113
- MixConsole 402
 - Channel linking 424
 - Channel racks 422
 - Channel types 420
 - Direct Routing 454
 - Display line 425
 - EQ presets 445
 - Fader section 429
 - FX chain presets 442
 - History 409
 - Left zone 407
 - Left Zone 408–410
 - Level meters 434
- MixConsole (*continued*)
 - Listen 432
 - Lower zone 74
 - Meter section 493, 494
 - Mute 432
 - Notepads 457
 - Opening 402
 - Panning 431
 - Pre rack 439
 - Racks 436
 - Setting volume 432
 - Snapshots 410
 - Solo 432
 - Solo Defeat 432
 - Strip presets 452
 - Surround Pan 752
 - Toolbar 410
 - Undoing parameter changes 409, 416
 - Visibility 408
 - Visibility agents 421
 - VST MultiPanner 752
 - Zones 409
- MixConsole in Project Window 74
- MixConsole snapshot
 - Recall settings 419
- MixConsole snapshots
 - Recalling 417
 - Saving 416, 417
- MixConvert V6
 - 3D downmixing 768
 - Channel configurations 768
 - In surround setups 764
- Mixing down to audio files 1171
- Mixing down to multiple files 1173, 1174
- MMC Master Panel 1216
- Modifier keys 1333
- Monitor
 - Track Control 123
- Monitoring 24, 295
 - ASIO Direct Monitoring 296
 - External 295
 - MIDI 296
 - Via Nuendo 295
- Mouse Wheel for Event Volume and Fades 1357
- Move Audio
 - Crossfades 345
- Move Fade
 - Crossfades 345
- Move Vertically
 - Automation Event Editor 810
 - Tempo Event Editor 1136
- Moving
 - Events 217
- Moving tracks 182
- MP3 files 1181
 - Importing 314
- MPE 1029
- MPEG files
 - Importing 314
- MPEX algorithm 559
 - Pitch Shift 551
- Multi processing 1351

- Multi-channel audio
 - Splitting [232](#)
- Multi-channel tracks
 - Splitting [179](#)
- Musical Articulations
 - Editing [934](#)
- Musical Mode [606](#)
- Musical Scales
 - Finding [966](#), [967](#)
 - Key Editor [958](#)
 - Live Input [968](#)
 - Quantize Pitches [968](#)
 - Setup [1061](#)
 - Snap Pitch Editing [969](#)
- Musical Time Base [1132](#)
- Mute
 - MixConsole [432](#)
 - Surround channels [762](#)
 - Track Control [123](#)
 - Transpose track [364](#)
- Mute Automation
 - Track Control [123](#)
- Mute Pre-Send when Mute [1378](#)
- Muting events [240](#)
- MXF files [1181](#), [1306](#)

- N**
- Name
 - Track Control [123](#)
- Naming schemes
 - Export Audio Mixdown [1169](#), [1170](#)
- Navigating
 - MixConsole [472](#)
- Network
 - Activating [1187](#)
 - Chat [1197](#)
 - Committing changes [1195](#)
 - Communication problems [1197](#)
 - Default permissions [1189](#)
 - Disconnecting from projects [1194](#)
 - Downloading selected tracks [1193](#)
 - Guest user [1189](#)
 - Joining projects [1193](#)
 - Loading changes [1195](#)
 - Loading permission presets [1190](#)
 - Merging projects [1194](#)
 - Override Project Permissions [1191](#)
 - Permission Presets [1189](#)
 - Permissions [1189](#)
 - Permissions for tracks [1191](#)
 - Port [1185](#)
 - Project Sharing and Permissions [1199](#)
 - Protocol [1185](#)
 - Reconnecting [1197](#)
 - Requirements [1186](#)
 - Shared Project [1199](#)
 - Sharing projects [1192](#)
 - Transfer Status [1196](#)
 - Unsharing [1197](#)
 - User Manager [1198](#)
 - User Name [1188](#)
- Network (*continued*)
 - Verifying communication [1187](#)
 - WAN connection [1186](#)
- Network Controls
 - Toolbar [1202](#)
- Network permission preset
 - Adding in User Manager dialog [1189](#)
- Network permissions
 - Setting up manually [1190](#)
- Network section
 - Inspector [1201](#)
- Networking
 - Track Control [123](#)
- Never Reset Chased Controllers [1367](#)
- New Project Dialog [105](#)
- Normalize
 - Direct Offline Processing [550](#)
 - Loudness [550](#)
 - Maximum peak level [550](#)
- Note display
 - Drum Editor [988](#)
 - Key Editor [959](#)
- Note events
 - Colorizing [914](#)
 - Deleting [918](#), [970](#)
 - Drawing with Draw tool [970](#)
 - Drawing with Line tool [971](#)
 - Duplicating [919](#)
 - Editing [919](#)
 - Editing via MIDI [977](#)
 - Excluding from playback [917](#)
 - Gluing [974](#)
 - Inserting [970](#)
 - Moving [972](#)
 - Muting [917](#)
 - Repeating [919](#)
 - Resizing [973](#)
 - Selecting [916](#)
 - Setting velocity values [920](#)
 - Setting with Snap [919](#)
 - Splitting [974](#)
 - Transposing [972](#)
 - Trimming [919](#)
- Note Expression [1027](#)
 - Adding events [1044](#)
 - Adding release phases [1047](#)
 - Converting events [1050](#)
 - Deleting events [1045](#)
 - Expression section [1034](#)
 - Global section [1036](#)
 - HALion Sonic SE [1028](#)
 - Inspector section [1033](#)
 - Key Editor [977](#)
 - Latch Buffer [1041](#)
 - Mapping [1037](#), [1038](#)
 - Mapping controllers [1037](#)
 - Mapping presets [1038](#)
 - MIDI controllers [1029](#)
 - MIDI learn [1038](#)
 - Moving events [1046](#)
 - Overdubbing [1041](#)
 - Overlaps [1050](#)
 - Parameter details [1035](#)

- Note Expression (*continued*)
 - Pasting events [1045](#)
 - Pasting events to different parameters [1046](#)
 - Recording [1039](#), [1040](#)
 - Recording by overdubbing [1041](#)
 - Recording via MIDI Input [1042](#)
 - Removing events [1048](#)
 - Repeating events [1046](#)
 - Sustain pedal [1039](#)
 - Tools [1037](#)
 - Trimming events [1049](#)
 - Trimming to note length [1047](#)
 - VST note expressions [1028](#)
 - Note Expression Event Editor
 - Change Editor Size [1042](#)
 - Change Release Length [1042](#)
 - Compress Left [1042](#)
 - Compress Right [1042](#)
 - Horizontal Snap [1042](#)
 - Move Vertically [1042](#)
 - One-Shot Mode [1042](#)
 - Parameter Range [1042](#)
 - Parameter Selection [1042](#)
 - Scale Around Absolute Center [1042](#)
 - Scale Around Relative Center [1042](#)
 - Scale Vertically [1042](#)
 - Stretch [1042](#)
 - Tilt Left [1042](#)
 - Tilt Right [1042](#)
 - Vertical Snap [1042](#)
 - Note Expression MIDI Input [1037](#)
 - Note Expression MIDI Setup [1048](#)
 - Note Layer
 - Scores [1375](#)
 - Notepads
 - MixConsole [457](#)
 - Notes
 - Adding in ReConform preview [1277](#)
 - Nudge buttons
 - Crossfades [345](#)
 - Nudging audio events to picture [1262](#)
- ## O
- O-notes (Output notes) [997](#)
 - Object audio content [769](#)
 - Object Selection
 - Combine Selection Tools [215](#)
 - Object Selection tool
 - Inserting note events [970](#)
 - Offline Processing
 - Applying permanently [547](#)
 - Ogg Vorbis files [1183](#)
 - Importing [314](#)
 - OMF files [1295](#)
 - On Import Audio Files [1357](#)
 - On Processing Shared Clips [1357](#)
 - On-Screen Keyboard [288](#)
 - Computer keyboard [288](#)
 - Modulation [288](#)
 - Note velocity level [288](#)
 - Octave offset [288](#)
 - Options [288](#)
 - On-Screen Keyboard (*continued*)
 - Piano keyboard [288](#)
 - Pitchbend [288](#)
 - Recording MIDI [288](#)
 - One Shot
 - Fill options [826](#)
 - One-Shot Mode
 - Note Expression Event Editor [1042](#)
 - Open Effect Editor after Loading it [1379](#)
 - Open Last Project on Startup [1365](#)
 - Open Sound Control
 - ADM authoring [788](#)
 - Mixing [788](#)
 - Open/Close Sampler
 - Track Control [123](#)
 - Organizing files in subfolders
 - Pool [692](#)
 - OSC
 - ADM authoring [788](#)
 - Content creation [788](#)
 - Mixing [788](#)
 - Position tracking [791](#)
 - OSC Object Position Tracking [791](#)
 - Output
 - Track Control [123](#)
 - Output busses
 - Adding [35](#)
 - Default [35](#)
 - Removing [44](#)
 - Renaming [34](#)
 - Routing [439](#)
 - Surround configurations [744](#)
 - Output Mapping [1020](#)
 - Output ports [23](#)
 - Overlap
 - Crossfades [344](#)
 - Overlapping Audio [188](#)
 - Overlaps
 - Showing [1362](#)
 - Overview line
 - Project window [62](#)
 - Overview Mode
 - VST MultiPanner [758](#)
- ## P
- Panning
 - Bypass [431](#)
 - Constant power [747](#)
 - MixConsole [431](#)
 - MixConvert V6 [764](#)
 - Surround [747](#)
 - Using a joystick [764](#), [879](#)
 - VST MultiPanner [747](#)
 - Parameter Range
 - Note Expression Event Editor [1042](#)
 - Parameter Selection
 - Note Expression Event Editor [1042](#)
 - Part Data Mode [1364](#)
 - Parts [208](#), [212](#)
 - Editing [213](#)
 - Folder [213](#)
 - Sliding the contents [237](#)

- Parts Get Track Names [1356](#)
- Paste at Origin [234](#)
- Paste Relative to Cursor [234](#)
- Patch Banks [892](#)
- Pattern
 - Chord Pads [1087](#)
- Pattern Banks
 - Loading in MediaBay [735](#)
 - Previewing in MediaBay [722](#)
- Peak meter display [493](#)
- Pedals
 - To note length [907](#)
- Performance
 - Aspects [1350](#)
 - Audio performance [1351](#)
 - Optimizing [1350](#)
- Phase
 - MixConsole [440](#)
- Phones channel
 - Source buttons [486](#)
- Phones Channel
 - Using as Preview Channel [1380](#)
- Piano keyboard display
 - Key Editor [960](#)
- Piano voicings [1063](#)
- Pick-up Mode [864](#)
- Pitch
 - Changing for chords [974](#)
- Pitch Notation [1363](#)
- Pitch Shift
 - Algorithm [559](#)
 - Direct Offline Processing [551](#)
 - Limitations [561](#)
- Pitch Snap Mode
 - VariAudio [624](#)
- Pitch Visibility
 - Key Editor [961](#)
 - Options [962](#)
- Pitchbend
 - Controller lanes [931](#)
- Placing audio events to picture
 - Four-point editing with the Range Selection tool [1262](#)
- Placing audio to picture
 - At cursor [1260](#), [1261](#)
 - At timecode positions [1260](#)
 - Snap [1259](#)
- Plain Chords
 - Chord Pads [1087](#)
- Playback
 - Disable Acoustic Feedback [1358](#)
 - Excluding note events [917](#)
- Playback Toggle triggers Local Preview [557](#), [1375](#)
- Player Modes
 - Pattern [1089](#)
 - Plain Chords [1088](#)
 - Sections [1091](#)
- Plug-in delay compensation [504](#)
- Plug-in Editors Always on Top [1379](#)
- Plug-in latency
 - MixConsole [458](#)
- Plug-in processing
 - Suspending [503](#)
- Plug-ins
 - Surround [740](#)
- Poly Pressure events
 - Adding [937](#)
 - Editing [937](#)
- Polyphony
 - Restricting [910](#)
- Pool
 - Applying different processing methods [682](#)
 - Attributes for elements [691](#)
 - Audio processing [693](#)
 - Automatically generating new audio clips [695](#)
 - Changing object names [680](#)
 - Clip editing [688](#)
 - Designating a new pool record folder [692](#)
 - Key commands [688](#)
 - Managing large sound databases [686](#)
 - Managing media files [675](#)
 - Organizing files in subfolders [692](#)
 - Reducing the project size [693](#)
 - Reference file [675](#)
 - Renaming clips and regions [680](#)
 - Resolve missing files dialog [686](#)
 - Sampler tracks [675](#)
 - Toolbar [678](#)
 - Transferring media from a library to a project [694](#)
- Position markers [368](#)
- Post fader sends [516](#)
- Post-roll
 - Recording [293](#)
 - Transport panel [275](#)
- Pre fader sends [516](#)
- Pre-Record time
 - Audio recording [301](#)
- Pre-roll
 - Recording [293](#)
 - Transport panel [275](#)
- Preferences
 - Colors [1376](#)
 - Configuration [1356](#)
 - Dialog [1354](#)
 - Disabling [1348](#), [1349](#)
 - Saving presets [1355](#)
 - Store marked preferences only [1355](#)
- Presets
 - File Format [1184](#)
 - Previewing in MediaBay [721](#), [722](#)
 - Previewing using a MIDI file [721](#)
 - Previewing using the Memo Recorder [722](#)
 - Previewing via MIDI Input [721](#)
 - Previewing via the Computer Keyboard [722](#)
- Presets browser
 - Effects [527](#)
- Preview options
 - Activating [827](#)
- Previewing
 - ReConform results [1276](#)
 - Video with ReConform [1287](#)
- Primary Time Format
 - Selecting [275](#)
- Process Bars [1147](#)
- Process Tempo [1146](#)
- Production sound [1248](#)

- Profiles 1342
 - Activating 1344
 - Adding 1343
 - Creating 1343
 - Deleting 1345
 - Duplicating 1344
 - Exporting 1345
 - Importing 1345
 - Managing 1342
 - Renaming 1344
 - Switching 1344
- Programs
 - Track Control 123
- Project Browser 1152
 - Deleting events 1155
 - Editing Note Expression data 1155
 - Event display 1152, 1153
 - Info line 1152
 - Project structure 1152, 1153
 - Toolbar 1152
- Project Colors Setup
 - Color Set 99
 - Options 100
 - Presets 100
- Project Colors Setup Dialog 98–100
- Project folder 1191
- Project Logical Editor 1116
 - Actions 1126–1129
 - Applying Actions 1130
 - Filter conditions 1117–1125
 - Functions 1129
 - Macros 1130
 - Overview 1116
 - Presets 1130
 - Setting up Key Commands 1131
 - Storing Presets 1130
- Project Root Key 360
 - Assigning to a Project 361
 - Assigning to Parts or Events 361
 - Changing 362, 363
 - Recording with 362
- Project Setup Dialog 108
- Project Sharing and Permissions
 - Network 1199
- Project structure
 - Automation 1153
 - Track data 1153
- Project Synchronization Setup 1209
 - Destinations 1213
 - Machine Control 1214
 - Sources 1210
- Project window
 - Event display 58
 - Extensions 652
 - Global track controls 58
 - History 48
 - Info line 62
 - Inspector 64
 - Keyboard focus 84
 - Left zone 63
 - Lower zone 72–75, 650
 - Meter section 493
 - Overview 46
- Project window (*continued*)
 - Overview line 62
 - Project zone 47
 - Right zone 78
 - Ruler 60
 - Showing/Hiding Zones 47
 - Snap 89
 - Snap to zero crossing 90
 - Status line 61
 - Toolbar 48
 - Toolbox 56
 - Track list 56
 - Transport Bar 63, 264
 - Transport pop-up window 269
 - Visibility 68, 69
 - Zones 71
 - Zoom presets 87
 - Zoom submenu 87
 - Zooming 86
- Project workspaces 1335
- Project zone 47
 - Event display 58
 - Global track controls 58
 - Ruler 60
 - Toolbar 48
 - Track list 56
- Projects
 - Activating 112
 - Back up 115
 - Creating new 103, 105
 - Hub 103
 - Location 114
 - Locations 112
 - Missing ports 113
 - Opening 111
 - Opening from locations 112
 - Opening recent 113
 - Prepare archive 115
 - Project files 105
 - Revert 114
 - Saving 113
 - Saving templates 107
 - Setting up 108
 - Template files 105
 - Templates 106
- Pull-down
 - Audio 1268
 - Video 1270
- Pull-up
 - Audio 1268
 - Video 1270
- Punch
 - Preview options 828
- Punch In 276, 293
 - On Stop 1371
- Punch In/Out
 - Common Record Modes 294
- Punch Log
 - Automation 829
- Punch on Play
 - Preview options 828
- Punch Out 276, 292, 293
 - Stop after automatic 1371

Punch Points [276](#)

Q

Q-Link [427](#)

QC Learn Mode

Track Quick Controls [860](#)

Quantize Panel [326](#)

Quantizing to a grid [328](#)

Quantizing to a groove [330](#)

Quantizing [321](#)

Catch Range [328](#)

Crossfades section [333](#)

Multiple audio tracks [324](#)

Original position [330](#)

Pre-Quantize [330](#)

Swing [328](#)

Tuplets [328](#)

Using groove presets [327](#)

Quick Zoom [1356](#)

R

Rack settings [423](#)

Copying [436](#)

Racks

MixConsole [436](#)

VCA [476](#)

RAM

Recording [298](#)

Ramp/Step

Continuous controllers [939](#)

Range Editing [248](#)

Range selection

Video [1263](#)

Range Selection

Combine Selection Tools [215](#)

Range Selection tool [248](#)

Creating fades [337](#)

Re-Record

Activating [294](#)

Common Record Modes [294](#)

Read automation [805](#)

Read Automation

Track Control [123](#)

Recent projects [113](#)

ReConform

Audio snippet markers [1285](#)

Automation warning markers [1285](#)

Change EDL [1276](#)

Dissolve markers [1285](#)

Healing entries [1280](#)

Insert markers [1285](#)

Prerequisites [1273](#)

Previewing video [1287](#)

Restricting the range [1283](#)

User interface [1274](#)

Wipe markers [1285](#)

Record

ADR [390](#)

Record Enable

Track Control [123](#)

Record File Format

Audio [297](#)

Record Folder

Audio [297](#)

Record-Enable allows MIDI Thru [1372](#)

Recording [290](#)

Common Record Modes [294](#)

Cycle [293](#)

Levels [17](#)

Lock Record [310](#)

Notes and Note Expression [1039](#), [1040](#)

Pre-roll and post-roll [293](#)

Remaining Record Time [310](#)

Stopping [292](#), [293](#)

Stopping automatically [292](#)

With Effects [299](#)

Recovering recordings

Audio [301](#)

MIDI [307](#)

ReCycle files [317](#)

Reducing the project size

Pool [693](#)

Reference file

Pool [675](#)

Reference Level [1380](#)

Refresh Views

MediaBay [713](#)

Regions

Creating with Detect Silence [564](#)

Event or Range as Region [211](#)

Events from Regions [211](#)

Renaming [680](#)

Rehearse

ADR [390](#)

Remote control [865](#)

Assigning commands [868](#)

Automation [868](#)

Connections [865](#)

Control Assignment [872](#)

Generic Remote [869](#)

Global Options [867](#)

Joysticks [879](#)

MIDI Port Setup [865](#)

MIDI remote control configuration [870](#)

Remote Control Editor [874](#)

Resetting [867](#)

Setting up [866](#)

Remote Control Editor [874](#)

Control settings [876](#)

Layout [878](#)

Parameter assignment [878](#)

Toolbar [876](#)

Remote Controllers

Connecting Track Quick Controls [863](#)

Connecting VST Quick Controls [849](#)

Remove DC Offset

Direct Offline Processing [554](#)

Remove Regions/Hitpoints on all Offline Processes
[1357](#)

Removing

Events [217](#)

Silence [564](#)

- Renaming
 - Clips [680](#)
 - Events [225](#)
 - Regions [680](#)
 - Tracks [182](#)
 - Render Audio Click between Locators [286](#)
 - Render MIDI Click between Locators [286](#)
 - Renderer for Dolby Atmos [775](#)
 - Rendering
 - Naming Scheme [242](#)
 - Rendering Audio [1156](#)
 - Rendering Selected Events [240](#)
 - Rendering Selections [1159](#)
 - Rendering Tracks [1156](#), [1158](#)
 - Repeat Events [235](#)
 - Repeat Loop [906](#)
 - Replace Recording in Editors [1372](#)
 - Resample
 - Direct Offline Processing [554](#)
 - Reset on Stop [1367](#)
 - Resize crossfades [346](#)
 - Resizing events [228](#)
 - Resolve Display Conflicts
 - Track Control [123](#)
 - Retrospective MIDI Recording [308](#), [309](#)
 - Empty Buffer [310](#)
 - Insert from All MIDI Inputs [308](#)
 - Retrospective Record [1372](#)
 - Retrospective Record Buffer [307](#)
 - Retrospective Recording
 - Buffer [307](#)
 - MIDI [307](#)
 - Return to Start Position on Stop [1375](#)
 - Reverse
 - Audio [555](#)
 - Direct Offline Processing [555](#)
 - MIDI [911](#)
 - Reverse shots
 - VST MultiPanner [759](#)
 - Review
 - ADR [390](#)
 - ReWire [1308](#)
 - Activating channels [1310](#)
 - Channels [1311](#)
 - Enabling applications [1308](#)
 - Routing MIDI [1312](#)
 - Setup [1308](#)
 - REX files [317](#)
 - Right locator
 - Setting [272](#)
 - Right Locator [271](#)
 - Right zone [78](#)
 - Control Room [83](#)
 - Media rack [81](#), [82](#), [697](#), [700](#), [702](#), [703](#)
 - Meter [83](#), [493](#)
 - VSTi rack [79](#), [80](#)
 - RMS
 - Resolution [497](#)
 - RMS display
 - Meters [493](#)
 - Root Key
 - Sampler Control [670](#)
 - Routing
 - Editor [510](#), [511](#)
 - For surround setups [745](#)
 - Group channels [439](#)
 - Input busses [438](#)
 - Insert effects [505](#)
 - MixConsole [437](#)
 - Output busses [439](#)
 - Ruler
 - Display format [60](#)
 - Project window [60](#)
 - Timeline [913](#)
 - Ruler track [152](#)
 - Track controls [153](#)
 - Ruler tracks
 - Add Track dialog [152](#)
 - Run Setup on Create New Project [1365](#)
- ## S
- Safe Mode
 - Dialog [1347](#)
 - Sample editing
 - Sampler Control [669](#)
 - Sample Editor [574](#), [585](#), [586](#)
 - Generate Harmony Voices [613](#), [638](#)
 - Info line [580](#)
 - Inspector [581](#)
 - Lower zone [75](#)
 - Overview Line [581](#)
 - Regions [591](#)
 - Ruler [584](#)
 - Showing multiple waveforms [585](#)
 - Snap [593](#)
 - Toolbar [576](#)
 - Undo zoom operations [586](#)
 - Sample rate
 - Externally clocked [22](#)
 - Sampler Control [654](#)
 - Adjusting the sample gain [672](#)
 - Amp section [664](#)
 - AudioWarp mode [660](#)
 - Envelope editor [664](#)
 - Filter section [663](#)
 - Keyboard section [668](#)
 - Lower zone [75](#)
 - Normalizing samples [672](#)
 - Pitch section [663](#)
 - Playback and sound parameters [660](#)
 - Playback quality [660](#)
 - Playback section [660](#)
 - Playing back samples [671](#)
 - Root Key [670](#)
 - Sample editing [669](#)
 - Slice mode [660](#)
 - Slicing [672](#)
 - Toolbar [655](#)
 - Transferring samples to VST instruments [673](#)
 - Waveform display [659](#)
 - Sampler tracks [136](#)
 - Add Track dialog [136](#)
 - Creating [654](#)
 - Inspector [137](#)

- Sampler tracks (*continued*)
 - Loading Audio Samples [653](#)
 - Loading MIDI Parts [654](#)
 - Pool [675](#)
 - Sampler Control [653](#)
 - Transferring Samples to Instruments [673](#)
- Saturation
 - Strip module [445](#)
- Save as Template [107](#)
- Save partial preferences settings [1355](#)
- Save Track Preset [202](#), [205](#)
- Scale Around Absolute Center
 - Automation Event Editor [810](#)
 - Tempo Event Editor [1136](#)
- Scale Around Relative Center
 - Automation Event Editor [810](#)
 - Tempo Event Editor [1136](#)
- Scale Assistant
 - Key Editor [958](#)
 - Scale Suggestions [966](#), [967](#)
- Scale events [1060](#)
 - Adding [1060](#)
 - Auditioning [1060](#)
 - Automatic scales [1060](#)
 - Changing [1060](#)
 - Follow Chord Track [1070](#)
 - Showing [1060](#)
- Scale standards
 - Meters [493](#)
- Scale Vertically
 - Automation Event Editor [810](#)
 - Tempo Event Editor [1136](#)
- Scan Folders only when MediaBay is open [1370](#)
- Scan unknown File Types [1370](#)
- Scanning
 - MediaBay [711](#)
- Score Editor
 - Lower zone [75](#)
- Scroll to selected Track [1360](#)
- Scrub Tool [215](#)
- Scrub Volume [1376](#)
- Scrubbing
 - Scrub tool [214](#)
- Secondary Time Format
 - Selecting [275](#)
- Sections
 - Chord Pads [1087](#)
- Segments
 - VariAudio [619](#)
- Select Channel/Track on Edit Settings [1360](#)
- Select Channel/Track on Solo [1360](#)
- Select Controllers in Note Range [945](#)
- Select Controllers in Note Range - Use Extended Note Context [1359](#)
- Select Media Type
 - MediaBay [715](#)
- Select Tool - Show Extra Info [1361](#)
- Select Track for Auditioning [1059](#)
 - Track Control [123](#)
- Select Track on Background Click [1356](#)
- Selected Events
 - Rendering [240](#)
- Selection ranges
 - Aligning audio [224](#)
- Selection Ranges
 - Creating [248](#)
 - Editing [250](#)
- Selections
 - Rendering [1159](#)
- Send effects [502](#), [513](#)
 - Adding FX channel tracks [514](#)
 - Adding to selected channels [515](#)
 - Setting level [518](#)
 - Setting pan [517](#)
- Send Level [1378](#)
- Sends
 - MixConsole [452](#)
- Set Spacer between Selected Events [219](#)
- Set Track Type Filter [59](#)
- Setting Event Colors to Track Colors [98](#)
- Settings
 - Factory defaults [1343](#)
- Shared Copies
 - Convert to Real Copy [236](#)
 - Creating [236](#)
- Shared Project
 - Network [1199](#)
- Show Dialogue during ADR [399](#)
- Show Frame Numbers
 - Track Control [123](#)
- Show Lanes
 - Track Control [123](#)
- Show Note Expression Data [1037](#)
- Show Scales [1060](#)
 - Track Control [123](#)
- Show Thumbnails
 - Track Control [123](#)
- Show Timecode Subframes [1246](#)
- Side-chain [519](#), [521](#)
 - Ducking delay [519](#)
 - Effect inputs [503](#)
 - Inserts rack [441](#)
 - Trigger signals [520](#)
- Side-chain inputs [503](#)
- Signal Switchboard
 - ADR [393](#)
- Signature track [162](#)
 - Inspector [162](#)
 - Track controls [162](#)
- Silence
 - Detecting [562](#)
 - Direct Offline Processing [555](#)
 - Inserting [253](#)
 - Removing [564](#)
- Simple Crossfade Editor [341](#), [1357](#)
- Single Voice
 - Follow Chord Track [1069](#)
- Slices [596](#)
 - Close gaps [601](#)
 - Delete overlaps [601](#)
- Slider Mode [1359](#)
- Smallest Track Height To Show Data [1362](#)
- Smallest Track Height To Show Name [1362](#)

- SMPTE
 - Drop-Frame [1247](#)
 - Time-of-day [1246](#)
 - Timecode [1246](#)
- Snap [89](#)
 - Sample Editor [593](#)
- Snap MIDI Parts to Bars [1372](#)
- Snap point
 - Setting [89](#)
- Snap Point To Cursor [89](#)
- Snap to zero crossing [90](#)
- Snap type
 - Project window [90](#)
- Snapshots
 - MixConsole [410](#), [416](#), [417](#)
- Solo
 - MixConsole [432](#)
 - Surround channels [762](#)
 - Track Control [123](#)
- Solo Defeat
 - MixConsole [432](#)
- Solo Record in MIDI Editors [1372](#)
- Spectrum Analyzer [566](#)
 - Audio Functions [565](#)
 - Comparing level values [566](#)
- Splice Point [344](#)
 - Offset [344](#)
- Split Channels dialog [233](#)
- Split MIDI Controllers [1359](#)
- Split MIDI Events [1359](#)
- Splitting
 - Events [231](#)
 - Into equal events [232](#)
 - Ranges [252](#)
- Splitting multi-channel audio [232](#)
- Splitting multi-channel audio into mono files [232](#)
- Standard algorithm [560](#)
- Standard Compressor
 - Details view [464](#)
 - Edit Module [464](#)
- Start Recording at Cursor
 - Common Record Modes [294](#)
- Start Recording at Left Locator
 - Common Record Modes [294](#)
- Static value line
 - Automation [805](#)
- Stationary Cursors [1375](#)
- Statistics
 - Audio Functions [567](#)
- Status line
 - Project window [61](#)
- Step recording [978](#)
- Stereo Flip
 - Direct Offline Processing [555](#)
- Stereo Panner Mode [1378](#)
- Stop playback while winding [1375](#)
- Stretch
 - Automation Event Editor [810](#)
 - Tempo Event Editor [1136](#)
- Strip presets [452](#)
- Strip Presets
 - Loading in MediaBay [735](#)
- Studio Setup
 - Dialog [16](#)
 - Note Expression Input Device [1029](#)
- Surround [740](#)
 - 3D downmixing [768](#)
 - 3D mixing for Ambisonics [792](#)
 - 3D mixing for Dolby Atmos [770](#)
 - ADM Authoring for Dolby Atmos [770](#)
 - Ambisonics mixing [792](#)
 - Applying plug-ins [740](#)
 - Automatic downmixing [455](#)
 - Automation [755](#), [761](#)
 - Constant power [747](#)
 - Counter shots [759](#)
 - Deliverables [741](#)
 - Disable channels [762](#)
 - Divergence [760](#)
 - Elevation patterns [761](#)
 - Exporting to file [769](#)
 - Input bus configuration [747](#)
 - Inspector [747](#)
 - MixConsole [747](#)
 - MixConvert V6 [764](#)
 - Multi-channel formats [741](#)
 - Mute channels [762](#)
 - Orbit Center [759](#)
 - Output bus configuration [744](#)
 - Panning [758](#), [762](#)
 - Positioning [755](#)
 - Radius [759](#)
 - Rotating signals [759](#)
 - Routing [745](#)
 - Signal distribution [760](#)
 - Solo channels [762](#)
 - Supported channel configurations [741](#)
 - Tilting signals [759](#)
 - VST MultiPanner [747](#)
- Suspend Auto-Scroll when Editing [274](#)
- Suspend Read
 - Suspend options [829](#)
- Suspend VST 3 plug-in processing when no audio signals are received [1379](#)
- Suspend Write
 - Suspend options [830](#)
- Swing
 - Quantizing [328](#)
- Sync Selection in Project Window and MixConsole [1360](#)
- Synchronization [1204](#)
 - Audio clock [1207](#)
 - Audio to picture [1247](#)
 - External Sync [1217](#)
 - Machine Control Master [1204](#)
 - Machine Control Slave [1204](#)
 - MIDI clock [1207](#)
 - Phase [1209](#)
 - Setup dialog [1209](#)
 - Speed references [1207](#)
 - Timecode [1205](#)
 - Timecode Master [1204](#)
 - Timecode Slave [1204](#)
- Synchronize Plug-in Program Selection to Track Selection [1379](#)

- Synchronizing Track Data
 - Follow Chord Track [1070](#)
- SysEx
 - Changing settings [1010](#)
 - Editing values [1011](#)
 - Messages [1009](#)
- System component information [532](#)
 - Exporting [533](#)
- T**
- Tail
 - Direct Offline Processing [545](#)
- Tap Tempo [1142](#)
- Tapemachine Style
 - Monitoring [1378](#)
- Telecine process [1265](#)
- Template projects [105](#)
- Templates [106](#)
 - Renaming [107](#)
- Tempo
 - Process Bars [1147](#)
 - Process Tempo [1146](#)
 - Set Definition from Tempo [1149](#)
- Tempo Changes
 - Tempo Detection [1139](#)
- Tempo Detection [1139](#), [1144](#)
 - Corrections [1140](#)
 - Panel [1144](#)
- Tempo Editor
 - Toolbar [1133](#)
- Tempo Event Editor [1136](#)
 - Compress Left [1136](#)
 - Compress Right [1136](#)
 - Move Vertically [1136](#)
 - Scale Around Absolute Center [1136](#)
 - Scale Around Relative Center [1136](#)
 - Scale Vertically [1136](#)
 - Stretch [1136](#)
 - Tilt Left [1136](#)
 - Tilt Right [1136](#)
- Tempo Events
 - Editing [1140](#)
- Tempo matching
 - Audio Alignment [220](#)
- Tempo modes
 - Fixed Tempo [1132](#)
 - Tempo track [1132](#)
- Tempo track [163](#), [1132](#), [1135](#)
 - Activate [1133](#)
 - Editor [1133](#)
 - Exporting [1145](#)
 - Importing [1145](#)
 - Inspector [163](#)
 - Mode [1132](#)
 - Tempo changes [1137](#)
 - Track controls [164](#)
- Tempo-related tracks [1132](#)
- Terminator point
 - Automation [815](#)
- Thumbnail Memory Cache Size [1381](#)
- Thumbnails [1238](#)
 - Thumbnail cache files [1238](#)
- Tilt Left
 - Automation Event Editor [810](#)
 - Tempo Event Editor [1136](#)
- Tilt Right
 - Automation Event Editor [810](#)
 - Tempo Event Editor [1136](#)
- Tilt/Rotate Anchor
 - VariAudio [628](#)
- Time Base [193](#)
 - Default track time base [194](#)
 - Linear [1132](#)
 - Musical [1132](#)
- Time display [275](#)
- Time Display [1246](#)
- Time Display Window [270](#)
- Time Format [275](#)
- Time Signature Events
 - Adding [1150](#)
 - Adding on the Signature Track [1150](#)
 - Setting up [1149](#)
 - Setting up Click Patterns [1151](#)
- Time Stretch
 - Algorithms [559](#)
 - Direct Offline Processing [555](#)
 - Limitations [561](#)
- Time Stretch Tool Algorithm [1357](#)
- Time Warp [1147](#)
- Time-of-day
 - SMPTE [1246](#)
- Time-related tracks [1132](#)
- Timecode
 - SMPTE [1246](#)
 - Standards [1205](#)
 - Synchronization [1205](#)
- Timecode Subframes
 - Showing [1375](#)
- Timecodes
 - Modifying in EDLs [1278](#)
- Timeline
 - Ruler [913](#)
- Timelines
 - ReConform [1276](#)
- Tips
 - Showing [1365](#)
- To End
 - Fill options [825](#)
- To Punch
 - Fill options [825](#)
- To Start
 - Fill options [825](#)
- Toggle Time Base [1132](#)
- Tool modifier keys [1333](#), [1361](#)
- Toolbar
 - Pool [678](#)
 - Project Browser [1152](#)
 - Project window [48](#)
- Toolbar Divider
 - Project window [56](#)
- Toolbox
 - Project window [56](#)
- Toolbox on Right-Click [1361](#)
- Touch Assist
 - Preview options [828](#)

- Track archives 176
 - Exporting 176
 - Importing 173
- Track Area Width 1365
- Track Color
 - Resetting 96
- Track Controls 123
- Track Controls Settings 121
- Track Folding 188
- Track Height 185
- Track Inspector
 - Opening 65
- Track list 56
 - Dividing 57
- Track Name Width 1365
- Track parameters
 - Track Quick Controls 859
- Track Pictures 183
 - Browser 183
 - Showing 183
- Track presets
 - Quick Control assignment 861
- Track Presets 201
 - Applying 201, 203
 - Audio 202
 - Creating 202
 - Extracting sounds 204
 - Instrument 203
 - Loading 206
 - Loading in MediaBay 733
 - Loading inserts and EQ 206
 - MIDI 202
 - Multi-Track 204
 - Pattern Banks 206
 - Previewing in MediaBay 721
 - Sampler tracks 205
 - Track Quick Controls 207
 - VST Presets 204
- Track Quick Controls 858, 879
 - Assigning effect parameters 860
 - Assigning instrument parameters 861
 - Assigning parameters 859
 - Automatable Parameters 862
 - Connecting with Remote Controllers 863
 - Inspector 859
 - Loading presets 862
 - Parameter assignment 859
 - Presets 207
 - QC Learn Mode 860
 - Removing assignments 861
 - Saving assignments as presets 861
 - Showing automated assignments 863
- Track Selection follows Event Selection 1356
- Track Time Base 1132
 - Musical 193
 - Time linear 193
- Track Time Type 1356
- Track Versions 194
 - Activating 197
 - Copying and Pasting 199
 - Creating 196
 - Creating from lanes 201
 - Creating lanes from track versions 201
- Track Versions (*continued*)
 - Deleting 198
 - Duplicating 198
 - IDs 196
 - Inspector Section 119
 - Names 199
 - Renaming 200
 - Version name 194
- Tracks 118
 - Add Track dialog 170
 - Adding 170, 171
 - Audio 128
 - Chord 159
 - Color 183
 - Colorizing 95
 - Customizing track controls 121
 - Deselecting 186
 - Disabling 187
 - Duplicating 187
 - Enabling 187
 - Folder 154
 - FX channel 145
 - Group Channel 142
 - Importing from a project 171
 - Importing from a track archive 171, 173
 - Inspector 119
 - Instrument 132
 - Loudness 166
 - Marker 150
 - MIDI 139
 - Moving 182
 - Removing 182
 - Renaming 182
 - Rendering 1156, 1158
 - Ruler 152
 - Sampler 136
 - Selecting 186
 - Signature 162
 - Splitting 179
 - Tempo 163
 - Transpose 164
 - Using Track Presets 170
 - VCA fader 148
 - Video 165
 - Zooming 185
- Tracks Presets
 - Direct Offline Processing 544
- Transformer
 - Strip module 445
- Transport
 - Overview 264
 - Sections 264
- Transport Bar 264
- Transport menu
 - Functions 259
- Transport panel 254
 - Display format 275
 - Overview 254
 - Post-roll 275
 - Pre-roll 275
 - Sections 254
- Transport pop-up window 269

- Transport Zone
 - Project window 63
 - Transpose
 - Exclude Parts or Events 367
 - Global 367
 - Independent 367
 - Indicate Transpositions 365
 - Info line 366
 - Lock 364
 - MIDI function 901
 - Mute 364
 - Project Root Key 360
 - Transpose functions 360
 - Transpose track 164, 363
 - Inspector 164
 - Lock 364
 - Mute 364
 - Recording 366
 - Track controls 165
 - Transposing 364
 - Treat Muted Audio Events like Deleted 1357
 - Trim
 - Automation 821
 - Trim tool
 - Changing event lengths 973
 - Tube Compressor
 - Details view 464
 - Edit Module 464
 - Tuplets
 - Quantizing 328
 - Type of New Tempo Points 1133
- U**
- Undoing
 - Edit History 92
 - Maximum undo steps 93
 - Maximum Undo Steps 1365
 - MixConsole parameter changes 409, 416
 - Offline processing 545, 693
 - Project window 48
 - Recording audio 300
 - Use Undo Branches 1365
 - Zoom operations 586
 - Use Drum Editor when Drum Map is assigned 1361
 - Use Undo Branches 1365
 - Use Up/Down Navigation Commands for Selecting Tracks only 1356
 - Use Video Follows Edit Mode
 - Video 1258
 - User Manager
 - Network 1198
 - User-definable Frame Rate 1375
- V**
- Value Box/Time Control Mode 1359
 - Value display
 - Editing in List Editor 1009
 - VariAudio 614
 - Analysis 618
 - Audition 620
 - Changing Pitches by MIDI Input 625
 - VariAudio (*continued*)
 - Deleting Segments 622
 - Extract MIDI 635
 - Extracting MIDI from Audio 634
 - Formant Shifting 632
 - Generate Harmony Voices 637
 - Gluing Segments 622
 - Inspector Section 615
 - MIDI Input 625
 - MIDI Input Modes 626
 - MIDI reference tracks 631
 - Navigating 620
 - Pitch Changes 623
 - Pitch Curve Changes 627
 - Pitch Ranges 630
 - Pitch Snap Mode 624
 - Quantizing Pitches 626
 - Rotating Pitch Curves 629
 - Segment Colors 620
 - Segments 618, 619, 621
 - Smart Controls 616
 - Splitting Segments 621
 - Straightening Pitch Curves 629
 - Tilt/Rotate Anchor 628
 - Tilting Pitch Curves 628
 - Timing Modifications 630
 - VariAudio Changes 624
 - Volume Editing 633
 - Warping Segments 630
 - Zooming 620
 - VCA connections
 - Deactivating 478
 - VCA fader track
 - Inspector 150
 - VCA fader tracks 148
 - Add Track dialog 148
 - VCA faders 474
 - Automation 476
 - Connecting 477
 - Nesting 476
 - Settings 474
 - VCA rack 476
 - Velocity
 - MIDI function 908
 - Velocity events
 - Adding in controller display 930
 - Editing 929
 - Vertical Snap
 - Note Expression Event Editor 1042
 - Vertical zoom
 - Sample Editor 585
 - Video
 - Adjusting and editing audio to picture 1262–1264
 - Adjusting audio fades to picture 1264
 - Audio editing to picture 1246
 - Audio pull-up/pull-down 1268
 - Bi-level signals 1207
 - Codecs 1235
 - Conforming production audio 1247
 - Cut head/Cut tail 1263
 - Editing 1241
 - EDL 1254
 - Event-based fades 1259

Video (*continued*)

- Event-based volume envelopes 1259
 - Exporting 1244
 - Extracting audio from 1244
 - Formats 1234
 - Four-point editing 1262
 - Importing 1236
 - Inserting audio events at cursor position 1260, 1261
 - Inserting audio events at timecode positions 1260
 - Locating to markers 1261
 - Nudging audio events to picture 1262
 - OMF 1255
 - Output devices 1236
 - Placing audio to picture 1259
 - Playback 1238
 - Previewing with ReConform 1287
 - Pull-down 1270
 - Pull-up 1270
 - Range selections 1262, 1263
 - Scrubbing 1241
 - Shot transition detection 1255
 - Snapping audio events to video events 1259
 - Studio Setup 1238
 - Synchronization 1207
 - Thumbnails 1238
 - Time-stretching audio to picture 1264
 - Timeline 1246
 - Tri-level signals 1207
 - Use Video Follows Edit Mode 1258
- Video Cut Detection 1255
- Video Cut Detection panel 1256
- Video overlays
- ADR 398
- Video Player window 1240
- Aspect ratio 1240
 - Setting window size 1240
- Video track
- Inspector 165
 - Track controls 166
- Video tracks 165
- Vintage Compressor
- Details view 465
 - Edit Module 465
- Virgin territory
- Automation 815
 - Creating gaps 815
 - Defining a terminator point 815
- Virtual reality
- Video playback 802
- Visibility
- Inspector 68–70
 - MixConsole 408
 - Synchronizing track and channel visibility 71
- Voicings 1062
- Automatic voicings 1063
 - Configuring parameters 1063
 - Library 1063
 - Library subset 1063
 - Octave offset 1063
 - Piano 1063
 - Range 1063

Volume

- MixConsole 432
- Volume curve 349
- Volume databases
- Creating in the MediaBay 737
 - Mounting in the MediaBay 738
 - Removing from the MediaBay 738
 - Unmounting in the MediaBay 738
- VST
- Input ports 23
 - Output ports 23
 - VST 2 503
 - VST 3 503
- VST 3
- Suspend plug-in processing 845
- VST AmbiConverter 804
- VST AmbiDecoder 795
- VST effect selector 512
- VST instrument selector 837
- VST instruments
- Context menu 841
 - Control panel 835
 - Extracting expression maps 1022
 - Freezing 845
 - Functions menu 841
 - Presets 842
 - Saving presets 843
 - Setting up 835
- VST MultiPanner 747
- 3D mixing 751
 - 3D mixing elevation patterns 761
 - 3D mixing panning laws 762
 - Ambisonics mode 794
 - Automation 755
 - Bed mixing 751
 - Constant power 747
 - Disable channels 762
 - Divergence 760
 - Movement restrictions 756
 - Mute channels 762
 - Object mode 787
 - Object Mode 787
 - Object-based mixing 787
 - Orbit Center 759
 - Overview Mode 758
 - Panning 758, 762
 - Panning restrictions 756
 - Pinning mode 753
 - Plug-in panel 748
 - Positioning 755
 - Radius 759
 - Remote controlling 763, 764
 - Rotating signals 759
 - Signal distribution 760
 - Solo channels 762
 - Tilting signals 759
- VST Note Expression 1028
- VST Plug-in collection
- Adding 855
- VST Plug-in control panels
- Closing 527, 837
 - Hiding 526, 837
 - Showing 526, 837

-
- VST Plug-in Manager [852](#)
 - Collections [853](#)
 - Window [853](#)
 - VST plug-in pictures
 - Adding [707](#)
 - VST Plug-ins
 - Adding collections [855](#)
 - Blocklist [857](#)
 - Hiding [856](#)
 - Installing [852](#)
 - Managing [852](#)
 - Reactivating [857](#)
 - Showing [856](#)
 - VST Presets
 - Loading [206](#)
 - Previewing in MediaBay [721](#)
 - VST Quick Controls
 - Connecting with Remote Controllers [849](#)
 - VST System Link [1223](#)
 - Activating [1228](#)
 - Connections [1225](#)
 - Latency [1226](#)
 - Putting computers online [1229](#)
 - Setting up sync [1225](#)
 - VSTi rack
 - Right zone [79, 80](#)
- W**
- Warn before removing modified effects [1379](#)
 - Warn on Processing Overloads [1378](#)
 - Warping Algorithm [1357](#)
 - Wave files [1178](#)
 - Waveform Brightness [1362](#)
 - Waveform display [585](#)
 - Sample Editor [585](#)
 - Waveform Outline Intensity [1362](#)
 - Waveforms
 - Showing [1362](#)
 - When Recording Wave Files larger than 4 GB [1372](#)
 - Wind Speed Options [1375](#)
 - Windows
 - Dialog [1346](#)
 - Windows Media Audio files
 - Importing [314](#)
 - Wipe markers [1285](#)
 - Word clock
 - Synchronization [1207](#)
 - Working with MIDI data
 - Tools and functions for [987](#)
 - Workspaces
 - Adding [1336](#)
 - Creating [1336](#)
 - Editing [1336](#)
 - External projects [1336](#)
 - Modifying [1336](#)
 - Organizing [1337](#)
 - Saving [1336](#)
 - Types [1335](#)
 - Updating [1336](#)
 - Workspaces Organizer [1337](#)
 - Write Automation
 - Track Control [123](#)
 - Writing automation [805](#)
 - Automatically [806](#)
 - Manually [806, 807](#)
 - Tools [807](#)
- Z**
- Zones
 - Inspector [71](#)
 - Keyboard focus [84](#)
 - Left zone [63](#)
 - Lower zone [72](#)
 - MixConsole [407, 409](#)
 - Project zone [47](#)
 - Right zone [78](#)
 - Zoom
 - Adapt Grid to Zoom [86](#)
 - Audio Contents [86](#)
 - Cycle Markers [88](#)
 - Project window [86](#)
 - Track Control [123](#)
 - Zoom history
 - Project window [89](#)
 - Zoom presets
 - Project window [87](#)
 - Zoom Tool Standard Mode - Horizontal Zooming Only [1361](#)
 - Zoom while Locating in Time Scale [1375](#)
 - Zooming
 - To cycle markers [369](#)
 - Zooming horizontally [586](#)
 - Zooming tracks [185](#)
 - Zooming vertically [585](#)